



HP Color LaserJet MFP E77822, E77825, E77830  
HP Color LaserJet MFP E78323, E78325, E78330

## Service Manual



[www.hp.com/videos/laserjet](http://www.hp.com/videos/laserjet)  
[www.hp.com/support/colorlje77800mfp](http://www.hp.com/support/colorlje77800mfp)  
[www.hp.com/support/lje78323mfp](http://www.hp.com/support/lje78323mfp)





HP Color  
LaserJet Managed MFP E77822 Series  
HP Color  
LaserJet Managed MFP E77825 Series  
HP Color  
LaserJet Managed MFP E77830 Series  
HP Color  
LaserJet Managed MFP E78323 Series  
HP Color  
LaserJet Managed MFP E78325 Series  
HP Color  
LaserJet Managed MFP E78330 Series  
Service Manual

#### SUMMARY

Learn about theory of operation, remove and replace, troubleshooting on the printer. Parts are either customer-self repair (CSR) replaceable, or field replaceable units (FRUs) which require installation by a trained field-service technician. Use the provided parts diagrams and tables to identify the required part.

## **Copyright and License**

© Copyright 2020 HP Development Company, L.P.

Reproduction, adaptation, or translation without prior written permission is prohibited, except as allowed under the copyright laws.

The information contained herein is subject to change without notice.

The only warranties for HP products and services are set forth in the express warranty statements accompanying such products and services. Nothing herein should be construed as constituting an additional warranty. HP shall not be liable for technical or editorial errors or omissions contained herein.

Edition 13, 9/2020

## Revision History

View a list of document revisions.

The information contained herein is subject to change without notice. The only warranties for HP products and services are set forth in the express warranty statements accompanying such products and services. Nothing herein should be construed as constituting an additional warranty. HP shall not be liable for technical or editorial errors or omissions contained herein.

**Table -1 Revision History**

Revision Number	Revision Date	Revision Notes
13.0	Sept, 2020	Completed , adding the information for E78323, E78325, E78330 models in whole manual.  Added to tile page, all tables needed and all specifications as designated.  Added new part numbers for E78323, E78325, E78330 to Parts view and Remove and replace procedures.
12.0	Aug, 2020	Added the information for 78323, 78325, 78330 models in whole manual.  Updated Hardware configuration image and added formatter sections. See <a href="#">Formatter on page 104</a> .
11.0	May, 2020	Part number updates and general edits.
10.0	May, 2020	SRM migration to SDL Tridion Docs.  Part number updates and general edits.  Updated SSBM sections to current HPPK content. See <a href="#">Stapler/stacker and booklet maker (SSBM) on page 981</a> .  Updated BHCI sections. See <a href="#">Optional high-capacity input (HCI) on page 974</a> .  Added HP EPA 3.0 compliance content. See <a href="#">Service parts changes For Environmental Protection Agency 3.0 Compliant Products on page 2889</a> .
9.0	January, 2020	Corrected Graphic issues

Table -1 Revision History (continued)

Revision Number	Revision Date	Revision Notes
8.0	January, 2020	<p>Updated numerous part numbers throughout based on HP PN format.</p> <p>Added Electrical Mechanical diagrams to aide in troubleshooting. See <a href="#">Electrical-mechanical diagrams on page 941</a>.</p> <p>Removed references to Control panel that used 8"(inch) in title. This is due to the marketing change to definition of the control panel. See Table 1.1 <a href="#">Technical specifications on page 8</a>.</p> <p>Added high-voltage rail remove and replace procedure. See Table 1.1 <a href="#">Removal and replacement: High-voltage rail assembly on page 402</a>.</p>
7.0	June, 2019	<p>Updated all inner finisher content. See <a href="#">Inner finisher on page 2269</a>.</p> <p>Updated developer unit remove and replace procedure. See <a href="#">Removal and replacement: Developer unit on page 228</a>.</p> <p>Added right door dampner kit remove and replace. See <a href="#">Removal and replacement: Right door dampener and lever kit on page 397</a>.</p>
6.0	July, 2018	<p>Updated parts numbers throughout document to remove "SAM-" prefix and updated new part numbers as identified.</p> <p>Minor content edits (including graphics)</p>
5.0	March, 2018	<p>Upload all graphics to data base.</p> <p>Part number updates.</p> <p>Minor changes/updates.</p>
4.0	January, 2018	<p>Minor changes to environmental specs and engine dimensions.</p>

**Table -1 Revision History (continued)**

Revision Number	Revision Date	Revision Notes
3.0	November, 2017	<p>Updated code data for Diagnostics and Service Functions</p> <p>Replaced Product Overview with the UG-style Printer Views and removed the previous "Machine external view" section.</p> <p>Updated R&amp;R TOC level to 1.</p> <p>Replaced references to SAW with WISE and removed QR codes.</p> <p>Replaced Samsung Paper Jam content with the UG content</p> <p>Moved specifications out of the appendix to the Product Specifications chapter</p> <p>Added additional specification content to the Product Specifications chapter from the UG</p> <p>Removed the lists of tables and figures and the alphabetical and numerical lists of parts</p> <p>Placed ESD cautions at the beginning of the R&amp;R sections for the main printer and both finishers.</p> <p>Removed the Samsung precaution sections</p> <p>Updated variable list items to refer only to Diamond</p> <p>Updated part numbers, part descriptions, diagrams, and photos</p> <p>Linked Removal and Replacement procedures are linked to part number information.</p>
2.0	July, 2017	<p>Updated TOC to only consist of 3 levels</p> <p>Add error code and CPMD overview</p> <p>Added "How to search for documentation" section.</p> <p>Updated toner average yield data</p> <p>Changed all occurrences of #2 Phillips to #2 JIS</p>
1.0	April, 2017	Service manual initial release








## Conventions used in this guide


Learn about the conventions used in this publication.

---

 **TIP:** Tips provide helpful hints or shortcuts.

 **NOTE:** Notes provide important information to explain a concept or to complete a task.

 **CAUTION:** Cautions indicate procedures that you should follow to avoid losing data or damaging the product.

 **WARNING!** Warnings alert you to specific procedures that you should follow to avoid personal injury, catastrophic loss of data, or extensive damage to the product.

---



---

# Table of contents

<b>1 Product specifications and description .....</b>	<b>1</b>
Printer views .....	2
Printer front view .....	2
Printer back view .....	3
Interface ports .....	3
Control-panel view .....	4
Inner finisher view .....	6
Stapler/stacker finisher view .....	6
Booklet finisher view .....	6
Specifications .....	8
Technical specifications .....	8
Supported operating systems .....	11
Mobile printing solutions .....	13
Printer dimensions .....	14
Power consumption, electrical specifications, and acoustic emissions .....	15
Operating-environment range .....	15
General specifications .....	15
Print specifications .....	17
Scan specifications .....	19
Copy specifications .....	22
Paper handling specifications .....	25
Supplies .....	29
Maintenance parts .....	30
Optional .....	32
Feeding system .....	34
Feeding system overview .....	34
Main components and functions .....	35
Cassette .....	37
Pickup Assembly .....	39
Registration assembly .....	39
Tray 1 (MP) feed assembly .....	39
Image creation .....	41

Printing process overview .....	41
Imaging unit .....	43
Fuser unit .....	50
Fuser unit overview .....	50
Fuser unit drive .....	51
Fuser unit temperature control .....	51
Loop control .....	52
Laser scanner unit .....	54
Laser scanner assembly overview .....	54
Laser scanning optical path .....	55
Laser synchronizing detectors .....	56
Automatic CPR adjustment .....	57
Drive system .....	61
Drive motors .....	61
Main drive unit (OPC/DEVE/ITB/Transfer Roller/Disengage/Engage motors) .....	62
Pickup Drive .....	63
Registration (Regi)/Tray 1 drive .....	64
Feed drive .....	64
Fuser/Exit Drive .....	65
Toner collection unit drive .....	66
Toner supply drive .....	67
Flatbed Scanner System .....	68
Flatbed scanner system overview .....	69
Scanning system components .....	71
Caution for moving the scanner .....	77
Document feeder LX (dn models) .....	79
Document feeder LX overview .....	79
Document feeder LX electrical parts .....	79
Document feeder LX registration .....	80
Document feeder LX drive system .....	81
Document feeder LX scanning position .....	83
Document feeder LX specifications .....	84
Flow document feeder z models (GX) .....	85
Flow document feeder overview .....	85
Flow document feeder sensors .....	85
Flow document feeder ultra sonic multi-feed (USM) sensor .....	87
Flow document feeder drive system .....	88
Flow document feeder specifications .....	90
Flow document feeder registration .....	90
Flow document feeder scanning position .....	91
Flow document feeder mixed size original (MSO) sensor .....	91

Flow document feeder dual sensor cleaning method .....	93
Flow ADF z bundles (GX) .....	93
Hardware configuration .....	95
Main controller .....	99
Formatter .....	104
Low voltage power supply (LVPS; Type 5H) / switching mode power supply (SMPS) .....	106
Low voltage power supply (LVPS) PCA (Type 4) (GX/z models) .....	106
Fuser drive board (FDB) .....	108
High-voltage power supply (HVPS) PCA .....	110
Eraser PCA .....	112
Waste Sensor PCA .....	112
CRUM PCA .....	113
Toner CRUM joint PCA .....	113
Paper Size sensor PCA .....	113
Dual cassette feeder (DCF) .....	114
Inner finisher .....	118
<b>2 Parts, diagrams, removal and replacement .....</b>	<b>123</b>
HP service and support .....	123
How to search for printer documentation .....	124
Order parts by authorized service providers .....	128
Ordering .....	128
Orderable parts .....	128
How to use parts lists and diagrams .....	128
ESD precautions .....	128
Service approach .....	130
Precautions when replacing parts .....	130
Before performing service .....	131
After performing service .....	131
Post-service test .....	132
Maintenance (printer cleaning) .....	133
Cleaning the document feeder white bar and CIS (LX) .....	133
Cleaning the flow document feeder white bar and CIS (GX) .....	134
Cleaning the scanner glass .....	134
Cleaning the transfer roller .....	135
Cleaning the color toner density (CTD) sensor .....	136
Main parts .....	139
Main assembly .....	140
Removal and replacement: ADF white backing (LX) .....	144
Removal and replacement: ADF white backing (GX) .....	147
Removal and replacement: ADF whole unit (LX) .....	150

Removal and replacement: Flow ADF whole unit (GX) .....	155
Removal and replacement: Image scanner assembly (flatbed) .....	161
Removal and replacement: Exit unit .....	170
Removal and replacement: Fuser unit .....	173
Removal and replacement: Right door assembly .....	175
Removal and replacement: Image transfer belt (ITB) assembly .....	179
Removal and replacement: Fuser drive assembly board .....	188
Removal and replacement: Scanner LVPS (Type 5) board .....	192
Removal and replacement: LVPS fan .....	196
Removal and replacement: Formatter and formatter cage .....	200
Removal and replacement: Removal and replacement: 500 GB FIPS HDD/500 GB formatter HDD	207
Removal and replacement: HP Foreign interface harness (FIH) solution .....	210
Removal and replacement: NFC Kit installation .....	212
Removal and replacement: Main board .....	222
Removal and replacement: Developer unit .....	228
Removal and replacement: Imaging drum .....	233
Removal and replacement: Front cover open switch .....	238
Removal and replacement: Right door open switch .....	244
Removal and replacement: 500 GB Main PCA HDD .....	247
Removal and replacement: Control panel .....	252
Removal and replacement: Keyboard .....	255
Exit assemblies .....	258
Exit assembly .....	260
Cassettes tray 2/3 .....	262
Cassettes Tray 2/3 .....	264
Main drive assembly .....	266
Main drive .....	268
Fuser output drive .....	270
Fuser output drive .....	272
Main frame assembly .....	274
Main engine frame .....	276
Removal and replacement: Main drive unit .....	279
Removal and replacement: Fuser/exit drive assembly .....	285
Removal and replacement: Feed drive assembly .....	289
Removal and replacement: Toner collection unit drive .....	293
Removal and replacement: Toner supply drive assembly .....	296
Removal and replacement: Toner collection full sensor .....	303
Removal and replacement: Toner duct assembly .....	307
Removal and replacement: Fuser-duct fan .....	312
Removal and replacement: Pickup drive units .....	316
Removal and replacement: Feed sensor 1 .....	320

Removal and replacement: Feed sensor 2 .....	325
Removal and replacement: Automatic color registration (ACR) .....	331
Removal and replacement: Fuser out sensor .....	338
Removal and replacement: Duplex sensor and loop sensor .....	341
Tray 1 registration drive .....	344
Tray 1 registration drive .....	346
Registration sub-frame .....	348
Registration sub-frame .....	350
Removal and replacement: Registration drive assembly .....	352
Removal and replacement: Registration assembly .....	357
Main frame pickup .....	362
Main frame pickup .....	364
Removal and replacement: Trays 2-x main rollers .....	366
Removal and replacement: Paper pickup assemblies and empty/level sensor .....	372
Main frame pickup upper .....	378
Main frame pickup upper .....	380
Main frame .....	382
Main frame .....	384
Removal and replacement: ACR shutter motor .....	386
Removal and replacement: High-voltage power supply (HVPS) board .....	388
Removal and replacement: Laser scanner assembly .....	392
Removal and replacement: Right door dampener and lever kit .....	397
Removal and replacement: High-voltage rail assembly .....	402
Removal and replacement: TCU presence photo sensor .....	427
Removal and replacement: Paper size sensor PCA .....	429
Covers .....	431
Covers .....	432
Removal and replacement: Rear covers .....	434
Removal and replacement: Left cover .....	437
Right door .....	440
Right door .....	442
Tray 1 .....	444
Tray 1 rollers .....	446
Removal and replacement: Tray 1 rollers .....	448
Removal and replacement: Tray 1 unit and Tray 1 assemblies .....	452
Right door output .....	467
Right door output .....	468
Right door feed guide .....	470
Right door feed guide .....	472
Removal and replacement: HP LaserJet Transfer Roller (T2) .....	474
ADF (LX models) .....	476

ADF (LX models) .....	478
Removal and replacement: Removal and replacement: Document feeder (ADF) jam access cover (LX) .....	480
Removal and replacement: Removal and replacement: Document feeder (ADF) input tray (LX) .....	484
Removal and replacement: Removal and replacement: Contact Image Sensor (CIS) assembly .....	490
Removal and replacement: Removal and replacement: Document feeder (ADF) main motor (LX) ..	500
ADF exterior and ADF pickup (LX models) .....	505
ADF exterior and ADF pickup (LX) .....	506
Removal and replacement: Removal and replacement: Document feeder (ADF) PCA (LX) .....	508
Removal and replacement: Removal and replacement: Document feeder (ADF) pick/feed roller assembly (LX) .....	512
ADF main frame assembly (LX models) .....	518
ADF main frame assembly (LX/du models) .....	520
Removal and replacement: Removal and replacement: Document feeder (ADF) separation roller assembly (LX) .....	522
Removal and replacement: Removal and replacement: Document feeder (ADF) feed motor (LX) ..	529
Flow ADF (GX/z) .....	533
ADF (GX/z) .....	534
Removal and replacement: Document feeder input tray (GX) .....	536
Removal and replacement: Contact Image Sensor (CIS) assembly .....	543
Flow ADF open cover (GX/sGX) .....	550
Flow ADF open cover (GX/z) .....	552
Removal and replacement: Document feeder jam access cover (GX) .....	554
ADF upper pickup (GX/z) .....	560
ADF upper pickup (GX/z) .....	562
Removal and replacement: Flow document feeder pick roller assembly (GX) .....	564
Removal and replacement: ADF separation roller assembly (GX) .....	569
Flow ADF stacker (GX/z) .....	577
Flow ADF stacker (GX/sGX) .....	578
Flow ADF main frame (GX/z) .....	580
ADF main frame (GX/z) .....	582
Removal and replacement: Removal and replacement: Document feeder front motor (GX) .....	585
Removal and replacement: Document feeder rear motors (GX) .....	589
Removal and replacement: Document feeder PCA fan (GX) .....	598
Removal and replacement: Document feeder contact image sensor (CIS) fan (GX) .....	601
Removal and replacement: Flow ADF ultrasonic sensor with PCA (GX) .....	604
Removal and replacement: PCA-ADF HIC (GX) .....	612
Image scanner .....	615
Image scanner .....	616
Image scanner assembly .....	618
Image scanner assembly .....	620



Removal and replacement: Scan glass .....	622
HP LaserJet Managed MFP E72525-E72535, E77822-E77830 - Removal and replacement: Scanner LED lamp module .....	625
Image scanner, lower (LX) .....	629
Image scanner, lower (LX) .....	630
Removal and replacement: Scanner assembly – CCD and lens .....	632
Removal and replacement: Scanner APS sensor .....	636
Second Exit (Optional) .....	640
Remove the second exit (Optional) .....	640
Remove the return gate solenoid (Optional) .....	642
Dual cassette feeder (DCF) .....	645
DCF main .....	646
DCF main frame pickup 1 .....	664
DCF main frame pickup .....	666
DCF main frame pickup, upper .....	672
High-capacity input (HCI) tray (workgroup) .....	674
HCI main .....	675
HCI sub - frame .....	692
HCI sub - pickup upper/lower .....	714
HCI drive .....	721
HCI sub - cassette .....	746
<b>3 Problem solving .....</b>	<b>759</b>
Control panel messages document (CPMD) .....	760
Error codes .....	760
How to search for printer documentation .....	762
Troubleshooting process .....	766
Determine the problem source .....	767
Tools for troubleshooting .....	786
Problem-solving checklist .....	787
Print menu map .....	789
Print current settings pages .....	789
Print event log .....	790
Pre-boot menu options .....	791
Control panel menus .....	809
Clear paper jams .....	875
Paper jam locations .....	875
13.A1 tray 1 paper jam .....	875
13.A2, 13.A3 tray 2, tray 3 paper jam .....	876
Clear paper jams in the Bottom HCI .....	879
Service mode (tech mode) .....	881

Entering service mode .....	881
Service mode menu tree .....	881
Information .....	889
Maintenance counts .....	891
Diagnostics .....	893
Service functions .....	912
Print quality troubleshooting guide .....	915
Image quality problems and solutions .....	916
Adjusting the Adjusting the laser scanner assembly skew error .....	933
Adjusting the flow ADF/ADF skew .....	935
Adjust Scan skew error .....	938
<b>4 Electrical-mechanical diagrams .....</b>	<b>941</b>
PCAs, Boards, and Laser Scanning Unit (LSU) .....	941
Exit section .....	945
Drive section .....	946
Paper handling section .....	953
Frame section .....	955
Fuser section .....	958
Right door section .....	959
Scanner section .....	963
Document feeder section .....	965
Image formation section .....	967
Optional dual-cassette feeder (DCF) .....	971
Optional high-capacity input (HCI) .....	974
<b>5 Stapler/stacker and booklet maker (SSBM) .....</b>	<b>981</b>
Product specification and description .....	982
Stapler/stacker finisher and booklet finisher view .....	982
Specification .....	984
Stapler/stacker finisher and booklet finisher system .....	991
Service approach .....	1063
Precautions when replacing parts .....	1064
Before performing service .....	1066
ESD precautions .....	1066
After performing service .....	1066
Post-service test .....	1067
Order parts by authorized service providers .....	1068
Parts, diagrams, removal and replacement (stapler/ stacker and booklet finishers) .....	1069
Parts, diagrams (stapler/stacker) .....	1070
Parts, diagrams (Booklet finisher) .....	1116

Bridge unit .....	1142
Covers .....	1166
Entrance unit .....	1236
Punch unit .....	1242
Tray diverter unit .....	1249
Top exit unit .....	1278
Top output tray unit .....	1305
Main exit unit .....	1319
Paddle unit .....	1346
End fence unit .....	1379
Tamper unit .....	1414
Stapler unit .....	1571
Ejector unit .....	1652
Main output tray unit .....	1808
Paper holding unit .....	1869
Buffer unit .....	1927
Booklet maker .....	1941
Booklet entrance unit .....	1952
Booklet paddle unit .....	1970
Booklet end fence unit .....	1983
Booklet presser unit .....	2005
Booklet tamper unit .....	2028
Booklet stapler unit .....	2085
Booklet fold unit .....	2104
Booklet diverter unit .....	2188
Booklet exit unit .....	2212
Booklet output tray unit .....	2231
PCA .....	2235
Problem solving .....	2253
Control panel message document (CPMD) .....	2253
Clear paper jams .....	2254
Finisher system diagram .....	2267
<b>6 Inner finisher .....</b>	<b>2269</b>
Product specification and description .....	2270
Inner finisher view .....	2270
Specification .....	2271
Inner finisher system .....	2276
Service approach .....	2314
Precautions when replacing parts .....	2315
Before performing service .....	2317

ESD precautions .....	2317
After performing service .....	2317
Post-service test .....	2318
Order parts by authorized service providers .....	2319
Parts, diagrams, removal and replacement (inner finisher) .....	2320
Parts and diagrams (inner finisher) .....	2321
Covers .....	2338
Entrance unit .....	2364
Exit unit .....	2380
Paper support unit .....	2400
Paddle unit .....	2486
Tamper unit .....	2510
Stapler unit .....	2621
Ejector unit .....	2649
End fence unit .....	2715
Output tray unit .....	2726
Paper holding unit .....	2789
Punch unit .....	2836
Problem solving .....	2851
Control panel message document (CPMD) .....	2851
Electrical Mechanical Diagrams (Inner finisher) .....	2852
Punch waste full sensor .....	2852
Punch waste box sensor and finisher docking sensor .....	2853
Entrance motor .....	2854
Exit sensor .....	2855
Exit motor, main paddle motor & home sensor, output tray lower limit switch, and paper holding solenoid .....	2856
Paper support motor & home sensor .....	2857
Front tamper motor and home sensor .....	2858
Rear tamper motor and home sensor .....	2859
End fence sensor .....	2860
Stapler position motor and sensor .....	2861
Ejector 1 motor and home sensor, ejector 2 motor, motor sensor, and home sensor .....	2862
Output tray motor and sensor .....	2863
Output tray top of stack sensor .....	2864
Top cover switch .....	2865
Front cover switch .....	2866
<b>7 Diagrams .....</b>	<b>2869</b>
Diagrams (connection) .....	2869
Diagrams (FUSER EXIT) .....	2870

Diagrams (PICKUP/PH DRIVE/SIDE) .....	2870
Diagrams (laser scanner assembly/HVPS) .....	2871
Diagrams (toner) .....	2872
Diagrams (FDB/LVPS) .....	2873
Diagrams (UI) .....	2874
Diagrams (FRONT/OPC) .....	2875
Diagrams (scanner) .....	2876
Diagrams (Dual Cassette Feeder) .....	2877
<b>Appendix A Certificate of Volatility .....</b>	<b>2879</b>
Certificate of Volatility (For 77822, 77825, 77830) .....	2879
Certificate of Volatility (for E783xxdn) .....	2881
Certificate of Volatility (for E783xxz) .....	2884
<b>Appendix B Service parts changes For Environmental Protection Agency 3.0 Compliant Products .....</b>	<b>2889</b>
<b>Glossary of terms .....</b>	<b>2893</b>
<b>Index .....</b>	<b>2901</b>



---

# 1 Product specifications and description

You will learn more about the following sub sections:

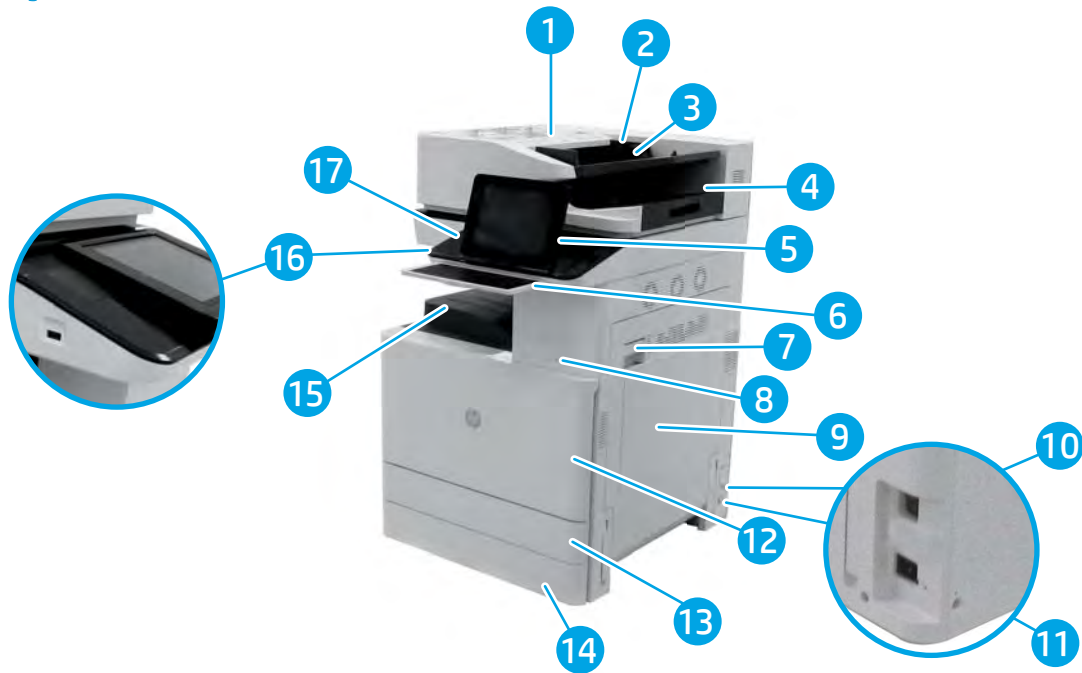
# Printer views

Learn more specifically about the different views of the printer.

## Printer front view

Learn about the printer components (front view).

Figure 1-1 Printer front view



Item	Description
1	Automatic document feeder cover (access for clearing jams)
2	Automatic document feeder width guides
3	Automatic document feeder input tray
4	Automatic document feeder output tray
5	Control panel with color touchscreen display (tilts up for easier viewing)
6	Physical keyboard (Flow models only). Pull the keyboard straight out to use it. (NOTE: Close the keyboard when it is not in use.)
7	Right door (access for clearing jams)
8	On/off button
9	Tray 1
10	Power switch

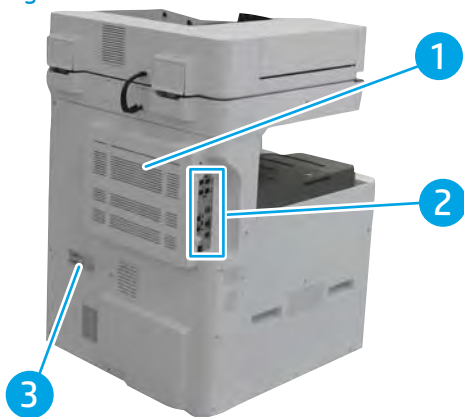


Item	Description
11	Power connection
12	Front door (access to the toner cartridges)
13	Tray 2
14	Tray 3
15	Output bin
16	Easy-access USB port. Insert a USB flash drive for printing or scanning without a computer, or to update the printer firmware. (NOTE: An administrator must enable this port before use.)
17	Hardware integration pocket (for connecting accessory and third-party devices)

## Printer back view

Learn about the printer components (back view).

Figure 1-2 Printer rear view

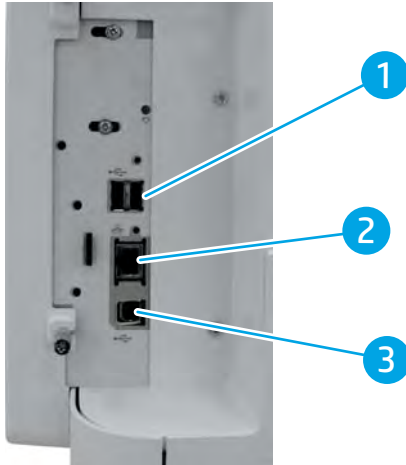


Item	Description
1	Formatter cover
2	Interface ports
3	Serial number and product number label

## Interface ports

Learn about the printer components (interface ports).

Figure 1-3 Interface ports




Item	Description
1	USB port for connecting external USB devices (NOTE: For easy-access USB printing, use the USB port near the control panel.)
2	Local area network (LAN) Ethernet network port
3	Hi-Speed USB 2.0 printing port

## Control-panel view

Learn about the printer components (control-panel).

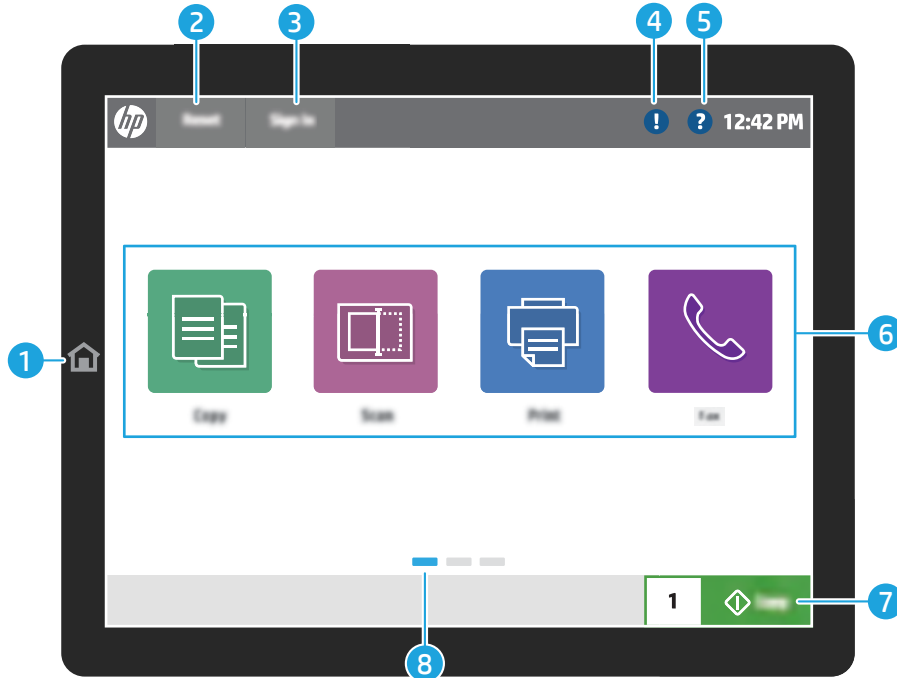
 **NOTE:** Tilt the control panel for easier viewing.



The Home screen provides access to the printer features and indicates the current status of the printer.


Return to the Home screen at any time by touching the Home  button on the printer control panel.

 **NOTE:** The features that appear on the Home screen can vary, depending on the printer configuration.

Figure 1-4 Printer control panel



Item	Button	Description
1	Home  button	Touch the Home button to return to the Home screen.
2	Reset button	The <a href="#">Reset</a> button returns the printer to default settings and is always present if users are not logged in. The <a href="#">Reset</a> button is not present when the <a href="#">Sign Out</a> button is present. Touch the <a href="#">Reset</a> button to resume and release jobs from the previous pause state and interrupt mode, reset the quick copy count in the copy count field, exit special modes, reset the display language and the keyboard layout.
3	<a href="#">Sign In</a> or <a href="#">Sign Out</a> button	Touch the <a href="#">Sign In</a> button to access secured features.  Touch the <a href="#">Sign Out</a> button to sign out of the printer. The printer restores all options to the default settings.  <b>NOTE:</b> This button displays only if the administrator has configured the printer to require permission for access to features.
4	Information  button	Touch the information button to access a screen that provides access to several types of printer information. Touch the buttons at the bottom of the screen for the following information: <ul style="list-style-type: none"> <li>• <a href="#">Display Language</a>: Change the language setting for the current user session.</li> <li>• <a href="#">Sleep Mode</a>: Place the printer into sleep mode.</li> <li>• <a href="#">Wi-Fi Direct</a>: View information for how to connect directly to the printer using a phone, tablet, or other device with Wi-Fi.</li> <li>• <a href="#">Wireless</a>: View or change wireless connection settings (only when an optional wireless accessory is installed).</li> <li>• <a href="#">Ethernet</a>: View or change Ethernet connection settings.</li> <li>• <a href="#">HP Web Services</a>: View information to connect and print to the printer using HP Web Services (ePrint).</li> </ul>

Item	Button	Description
5	Help  button	Touch the Help button to open the embedded help system.  The status line provides information about the overall printer status.
6	Applications area	Touch any of the icons to open the application. Swipe the screen sideways to access more applications.  <b>NOTE:</b> The available applications vary by printer. The administrator can configure which applications appear and the order in which they appear.
7	Start Copy button	Touch the Start Copy button to start a copy job.
8	Home-screen page indicator	Indicates the number of pages on the Home screen or in an application. The current page is highlighted. Swipe the screen sideways to scroll between pages.

## Inner finisher view

Learn about the printer components (inner finisher).



## Stapler/stacker finisher view

Learn about the printer components (stapler/stacker finisher).



## Booklet finisher view

Learn about the printer components (booklet finisher).



# Specifications

Learn about the specifications.

## Technical specifications

Learn technical specifications for model bundles.

 **NOTE:** Hole punch accessories are optional for the stapler/stacker, inner finisher, and booklet maker accessories.

**Table 1-1** E77822dn, E77822z, E77825dn, E77825z, E77830dn, E77830z, E78323dn, E78323z, E78325dn, E78325z, E78330dn, E78330z

		E77822dn	E77822z	E77825dn	E77825z	E77830dn	E77830z
Model number		E78323dn	E78323z	E78325dn	E78325z	E78330dn	E78330z
Product number		X3A78A	X3A77A	X3A81A	X3A80A	X3A84A	X3A83A
Product number	Item	8GR95A	8GR99A	8GR96A	8GS00A	8GR97A	8GS01A
Paper handling	Tray 1 (100-sheet capacity)	Supported	Supported	Supported	Supported	Supported	Supported
	Tray 2 (520-sheet capacity)	Supported	Supported	Supported	Supported	Supported	Supported
	Tray 3 (520-sheet capacity)	Supported	Supported	Supported	Supported	Supported	Supported
	HP LaserJet dual cassette feeder (DCF) (workgroup)	Optional	Optional	Optional	Optional	Optional	Optional
	2,000-sheet high-capacity input tray (HCI) (workgroup)	Optional	Optional	Optional	Optional	Optional	Optional
	HP LaserJet Printer cabinet (workgroup)	Optional	Optional	Optional	Optional	Optional	Optional
	HP LaserJet Stapler/stacker finisher	Optional	Optional	Optional	Optional	Optional	Optional
	HP LaserJet Booklet finisher	Optional	Optional	Optional	Optional	Optional	Optional
	HP LaserJet Inner finisher	Optional	Optional	Optional	Optional	Optional	Optional
	HP LaserJet 2/3 hole punch	Optional	Optional	Optional	Optional	Optional	Optional
	HP LaserJet 2/4 hole punch	Optional	Optional	Optional	Optional	Optional	Optional
	Swedish hole punch	Optional	Optional	Optional	Optional	Optional	Optional
	HP LaserJet Job separator	Optional	Optional	Optional	Optional	Optional	Optional
HP LaserJet Spacer	Optional	Optional	Optional	Optional	Optional	Optional	

**Table 1-1** E77822dn, E77822z, E77825dn, E77825z, E77830dn, E77830z, E78323dn, E78323z, E78325dn, E78325z, E78330dn, E78330z (continued)

		E77822dn	E77822z	E77825dn	E77825z	E77830dn	E77830z
		E78323dn	E78323z	E78325dn	E78325z	E78330dn	E78330z
		X3A78A	X3A77A	X3A81A	X3A80A	X3A84A	X3A83A
Product number	Item	8GR95A	8GR99A	8GR96A	8GS00A	8GR97A	8GS01A
	HP LaserJet Second exit	Optional	Optional	Optional	Optional	Optional	Optional
	Automatic duplex printing	Supported	Supported	Supported	Supported	Supported	Supported
<b>Connectivity</b>	10/100/1000 Ethernet LAN connection with IPv4 and IPv6	Supported	Supported	Supported	Supported	Supported	Supported
	Hi-Speed USB 2.0	Supported	Supported	Supported	Supported	Supported	Supported
	Easy-access USB port for printing without a computer and upgrading the firmware	Supported	Supported	Supported	Supported	Supported	Supported
	Hardware Integration Pocket for connecting accessory and third-party devices	Supported	Supported	Supported	Supported	Supported	Supported
<b>Memory</b>	6 GB base memory	Supported	Not supported	Supported	Not supported	Supported	Not supported
	7 GB base memory	Not supported	Supported	Not supported	Supported	Not supported	Supported
<b>Mass storage</b>	500 GB HP Secure High-Performance Hard Disk	Supported	Not supported	Supported	Not supported	Supported	Not supported
	2x 500 GB HP Secure High-Performance Hard Disk	Not supported	Supported	Not supported	Supported	Not supported	Supported
	16 GB embedded Multi-Media Controller (eMMC)	Supported	Not supported	Supported	Not supported	Supported	Not supported
<b>Control-panel display</b>	Color touchscreen control panel	Supported	Supported	Supported	Supported	Supported	Supported
	Retractable keyboard	Not supported	Supported	Not supported	Supported	Not supported	Supported
<b>Print</b>	Prints 22 pages per minute (ppm) on A4 and on letter-size paper.	Supported	Supported	Not supported	Not supported	Not supported	Not supported
	Prints 25 pages per minute (ppm) on A4 and on letter-size paper	Not supported	Not supported	Supported	Supported	Not supported	Not supported

**Table 1-1** E77822dn, E77822z, E77825dn, E77825z, E77830dn, E77830z, E78323dn, E78323z, E78325dn, E78325z, E78330dn, E78330z (continued)

		E77822dn	E77822z	E77825dn	E77825z	E77830dn	E77830z
Model number		E78323dn	E78323z	E78325dn	E78325z	E78330dn	E78330z
Product number		X3A78A	X3A77A	X3A81A	X3A80A	X3A84A	X3A83A
Item		8GR95A	8GR99A	8GR96A	8GS00A	8GR97A	8GS01A
	Prints 30 pages per minute (ppm) on A4 and on letter-size paper	Not supported	Not supported	Not supported	Not supported	Supported	Supported
	Easy-access USB printing (no computer required)	Supported	Supported	Supported	Supported	Supported	Supported
<b>Fax</b>		Optional	Optional	Optional	Optional	Optional	Optional
<b>Copy and Scan</b>	Scans 80 pages per minute (ppm) on A4 and letter-size paper	Supported	Not supported	Supported	Not supported	Supported	Not supported
	Scans 120 pages per minute (ppm) on A4 and letter-size paper	Not supported	Supported	Not supported	Supported	Not supported	Supported
	100-page document feeder with dual-head scanning for single-pass duplex copying and scanning	Supported	Not supported	Supported	Not supported	Supported	Not supported
	250-page document feeder with dual-head scanning for single-pass duplex copying and scanning	Not supported	Supported	Not supported	Supported	Not supported	Supported
	HP EveryPage Technologies including ultrasonic multi-feed detection	Not supported	Supported	Not supported	Supported	Not supported	Supported
	Embedded optical character recognition (OCR) provides the ability to convert printed pages into text that can be edited or searched using a computer	Not supported	Supported	Not supported	Supported	Not supported	Supported
	SMART Label feature provides paper-edge detection for automatic page cropping	Not supported	Supported	Not supported	Supported	Not supported	Supported
	Automatic page orientation for pages that have at least 100 characters of text	Not supported	Supported	Not supported	Supported	Not supported	Supported



**Table 1-1** E77822dn, E77822z, E77825dn, E77825z, E77830dn, E77830z, E78323dn, E78323z, E78325dn, E78325z, E78330dn, E78330z (continued)

		E77822dn	E77822z	E77825dn	E77825z	E77830dn	E77830z
Model number		E78323dn	E78323z	E78325dn	E78325z	E78330dn	E78330z
		X3A78A	X3A77A	X3A81A	X3A80A	X3A84A	X3A83A
Product number	Item	8GR95A	8GR99A	8GR96A	8GS00A	8GR97A	8GS01A
	Automatic tone adjustment sets contrast, brightness, and background removal for each page	Not supported	Supported	Not supported	Supported	Not supported	Supported
Digital Send	Send documents to E-mail, USB, and shared folders on a network	Supported	Supported	Supported	Supported	Supported	Supported
	Send documents to SharePoint®	Supported	Supported	Supported	Supported	Supported	Supported

## Supported operating systems

Learn about supported operating systems.

The following information applies to the Printer-Specific Windows PCL 6 and HP print drivers for OS X and to the software installer.

**Windows:** The HP Software Installer can be downloaded from the printer support website for this printer and installs the “HP PCL.6” version 3 print driver, the “HP PCL 6” version 3 print driver, or the “HP PCL-6” version 4 print driver, depending on the Windows operating system, along with optional software when using the software installer. Download the “HP PCL.6” version 3 print driver, the “HP PCL 6” version 3 print driver, and the “HP PCL-6” version 4 print driver from the printer-support website for this printer: [www.hp.com/support/colorlje77822mfp](http://www.hp.com/support/colorlje77822mfp) or <http://www.hp.com/support/colorlje78323mfp>.

**OS X:** Mac computers are supported with this printer. Download HP Easy Start either from [123.hp.com/LaserJet](http://123.hp.com/LaserJet) or from the Printer Support page, and then use HP Easy Start to install the HP print driver. HP Easy Start is not included in the HP Software Installer.

1. Go to [123.hp.com/LaserJet](http://123.hp.com/LaserJet).
2. Follow the steps provided to download the printer software.

**Linux:** For information and print drivers for Linux, go to [www.hp.com/go/linuxprinting](http://www.hp.com/go/linuxprinting).

**UNIX:** For information and print drivers for UNIX®, go to [www.hp.com/go/unixmodelscrip](http://www.hp.com/go/unixmodelscrip).

**Table 1-2** Supported operating systems and print drivers


Operating system	Print driver installed (from the software on the web)	Notes
Windows® XP SP3, 32-bit	The “HP PCL.6” printer-specific print driver is installed for this operating system as part of the software installation.	Microsoft retired mainstream support for Windows XP in April 2009. HP will continue to provide best effort support for the discontinued XP operating system. Some features and page sizes in the print driver are not supported.


**Table 1-2 Supported operating systems and print drivers (continued)**

Operating system	Print driver installed (from the software on the web)	Notes
Windows Vista®, 32-bit	The “HP PCL.6” printer-specific print driver is installed for this operating system as part of the software installation.	Microsoft retired mainstream support for Windows Vista in April 2012. HP will continue to provide best effort support for the discontinued Vista operating system. Some features and page sizes in the print driver are not supported.
Windows Server 2003 SP2, 32-bit	The “HP PCL.6” printer-specific print driver is available for download from the printer-support website. Download the driver, and then use the Microsoft Add Printer tool to install it.	Microsoft retired mainstream support for Windows Server 2003 in July 2010. HP will continue to provide best effort support for the discontinued Server 2003 operating system. Some features and page sizes in the print driver are not supported.
Windows 7 SP1, 32-bit and 64-bit	The “HP PCL 6” printer-specific print driver is installed for this operating system as part of the software installation.	
Windows 8, 32-bit and 64-bit	The “HP PCL 6” printer-specific print driver is installed for this operating system as part of the software installation.	Windows 8 RT support is provided through Microsoft IN OS Version 4, 32-bit driver.
Windows 8.1, 32-bit and 64-bit	The “HP PCL-6” V4 printer-specific print driver is installed for this operating system as part of the software installation.	Windows 8.1 RT support is provided through Microsoft IN OS Version 4, 32-bit driver.
Windows 10, 32-bit and 64-bit	The “HP PCL-6” V4 printer-specific print driver is installed for this operating system as part of the software installation.	
Windows Server 2008 SP2, 32-bit	The “HP PCL.6” printer-specific print driver is available for download from the printer-support website. Download the driver, and then use the Microsoft Add Printer tool to install it.	Microsoft retired mainstream support for Windows Server 2008 in January 2015. HP will continue to provide best effort support for the discontinued Server 2008 operating system. Some features and page sizes in the print driver are not supported.
Windows Server 2008 SP2, 64-bit	The “HP PCL 6” printer-specific print driver is available for download from the printer-support website. Download the driver, and then use the Microsoft Add Printer tool to install it.	
Windows Server 2008 R2, SP 1, 64-bit	The “HP PCL 6” printer-specific print driver is available for download from the printer-support website. Download the driver, and then use the Microsoft Add Printer tool to install it.	
Windows Server 2012, 64-bit	The PCL 6 printer-specific print driver is available for download from the printer-support website. Download the driver, and then use the Microsoft Add Printer tool to install it.	

**Table 1-2 Supported operating systems and print drivers (continued)**

Operating system	Print driver installed (from the software on the web)	Notes
Windows Server 2012 R2, 64-bit	The PCL 6 printer-specific print driver is available for download from the printer-support website. Download the driver, and then use the Microsoft Add Printer tool to install it.	
OS X 10.10 Yosemite, OS X 10.11 El Capitan, and OS X 10.12 Sierra	To install the print driver, download HP Easy Start from <a href="http://123.hp.com/LaserJet">123.hp.com/LaserJet</a> . Follow the steps provided to install the printer software and print driver.	

 **NOTE:** Supported operating systems can change. For a current list of supported operating systems, go to [www.hp.com/support/colorlje77822mfp](http://www.hp.com/support/colorlje77822mfp) or <http://www.hp.com/support/colorlje78323mfp> for HP's all-inclusive help for the printer.

 **NOTE:** For details on client and server operating systems and for HP UPD driver support for this printer, go to [www.hp.com/go/upd](http://www.hp.com/go/upd). Under **Additional information**, click the links.

**Table 1-3 Minimum system requirements**

Windows	OS X
<ul style="list-style-type: none"><li>• An Internet connection</li><li>• Dedicated USB 1.1 or 2.0 connection or a network connection</li><li>• 2 GB of available hard-disk space</li></ul>	<ul style="list-style-type: none"><li>• Internet connection</li><li>• 1 GB of available hard-disk space</li></ul>

## Mobile printing solutions

Learn what HP offers for mobile printing solutions.

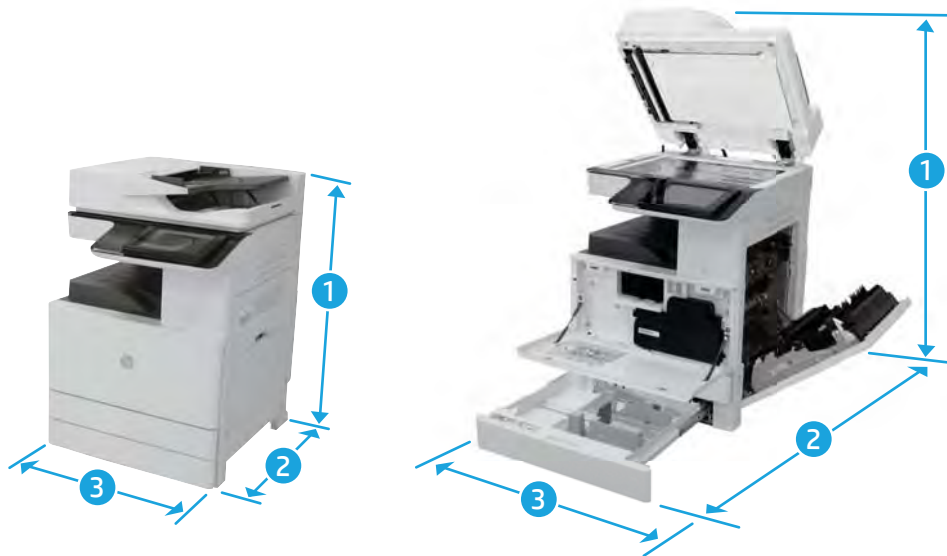
HP offers multiple mobile and ePrint solutions to enable easy printing to an HP printer from a laptop, tablet, smartphone, or other mobile device. To see the full list and to determine the best choice, go to [HP Customer Support - Knowledge Base](#).

- Wi-Fi Direct
- HP ePrint via email (Requires HP Web Services to be enabled and the printer to be registered with HP Connected)
- HP ePrint app (Available for Android, iOS, and Blackberry)
- HP All-in-One Remote app for iOS and Android devices
- HP ePrint software
- Google Cloud Print
- AirPrint
- Android Printing

## Printer dimensions

Learn about printer dimensions.

 **NOTE:** A color printer model is shown in the figure below. However, the dimension information applies to mono and color printers.



**Table 1-4** Printer dimensions

Item	Normal operating dimensions	Maximum operating dimensions
Height	877 mm (34.5 in) (dn models) 925 mm (36.5 in) (z models)	1241 mm (49 in) (dn models) 1375 mm (54.25 in) (z models)
Depth	730 mm (28.75 in) (dn models) 780 mm (30.75 in) (z models)	1115 mm (44 in) (dn models) 1216 mm (48 in) (z models)
Width	568 mm (22.5 in) (dn models) 584 mm (23 in) (z models)	1010 mm (39.75 in) (dn models) 1026 mm (40.5 in) (z models)
Weight	91.1 kg (200.8 lb) (dn models) 102.61 kg (226.2 lb) (z models)	

**Table 1-5** Printer accessory dimensions and weights

Product	Length	Width	Depth	Height	Weight
HP LaserJet Cabinet (workgroup)	790 mm (31.1 in)	566 mm (22.3 in)	610 mm (24 in)	265 mm (10.4 in)	13.4 kg (29.5 lbs)
HP LaserJet 2x520-sheet dual cassette feeder (DCF) (workgroup)	790 mm (31.1 in)	566 mm (22.3 in)	610 mm (24 in)	265 mm (10.4 in)	21 kg (46.3 lbs)

**Table 1-5 Printer accessory dimensions and weights (continued)**


Product	Length	Width	Depth	Height	Weight
HP LaserJet 2000 sheet high capacity input (HCI) feeder (workgroup)	790 mm (31.1 in)	585 mm (23 in)	670 mm (26.4 in)	312 mm (12.3 in)	29.3 kg (64.59 lbs)
HP LaserJet Job separator (workgroup)	790 mm (31.1 in)	464 mm (18.3 in)	394.7 mm (15.5 in)	124.5 mm (4.9 in)	3 kg (1.4 lbs)
HP LaserJet Inner finisher	790 mm (31.1 in)	458 mm (18 in)	491 mm (19.3 in)	173 mm (6.8 in)	15kg (33.1 lbs)
HP LaserJet Booklet finisher	790 mm (31.1 in)	1016.4 mm (39.75 in)	673 mm (26.75 in)	587.5 mm (23.5 in)	62 kg (136.7 lbs)
HP LaserJet Stapler/Stacker finisher	790 mm (31.1 in)	1016.4 mm (39.75 in)	673 mm (26.75 in)	587.5 mm (23.5 in)	40kg (88.2 lbs)

 **NOTE:** HP recommends that 30 mm (1.81 in) be added to the printer dimensions provided in this chapter to make sure there is sufficient space to open doors and covers, and to provide proper ventilation.

## Power consumption, electrical specifications, and acoustic emissions

In order to operate properly, the printer must be in an environment that meets certain power specifications.

See [www.hp.com/support/colorlje77830mfp](http://www.hp.com/support/colorlje77830mfp) for current information.

 **CAUTION:** Power requirements are based on the country/region where the printer is sold. Do not convert operating voltages. This will damage the printer and void the printer warranty.

## Operating-environment range

In order to operate properly, the printer must be in an environment that meets certain specifications.

**Table 1-6 Operating-environment specifications**

Environment	Recommended	Allowed
Temperature	17° to 25°C (62.6° to 77°F)	Not available
Relative humidity	30% to 70% relative humidity (RH)	Not available

## General specifications

Learn about the general specifications.

 **NOTE:** Acoustic values are subject to change. For current information, see [www.hp.com/support](http://www.hp.com/support).

**Table 1-7 General specifications**

Item	Description	Specification
Processor	CPU	1.2 GHz

**Table 1-7** General specifications (continued)

Item	Description	Specification
User Interface	Control Panel	20.3 cm (8 in) Color Graphics Display (CGD) with touchscreen; rotating (adjustable angle) display; illuminated Home button (for quick return to the Home menu); USB High-speed 2.0 port; Hardware Integration Pocket; Extended Keyboard (Flow models only)
User Interface	LED	2 (Power/Status)
User Interface	Key/Button	1 (Power)
Memory	Standard	Flow Bundle : 8GB, dn bundle : 7GB
Storage	Standard	Two 1,000 GB Standard, embedded HP High-Performance Secure Hard Disk, Total 1,000G; AES 256 hardware encryption or greater; Secure erase capabilities (Secure File Erase-Temporary Job Files, Secure Erase-Job Data, Secure ATA Erase-Disk).  <b>NOTE:</b> US Government SKU uses 500 GB FIPS 140-2 validated hard disk.
Storage	Optional	N/A
Interface	USB (Device)	Yes (Hi-Speed USB 2.0)
Interface	USB (Host)	Yes (Hi-Speed USB 2.0)
Interface	USB (EDI)	N/A
Interface	Wired LAN	Standard (Ethernet 10/100/1G Base TX)
Interface	Wireless LAN	Optional (IEEE 802.11b/g/n + NFC Active Type)
Interface	NFC	Optional (IEEE 802.11b/g/n + NFC Active Type)
Interface	Other	N/A
Warmup Time	From Ready)	Less than 25 sec
	From Sleep	Less than 21 sec
Power Consumption	Ready	Less than 250 Wh
Power Consumption	Normal operation	Less than 800 Wh
Power Consumption	Max/Peak	Less than 1200 Wh
Power Consumption	Sleep	Less than 1.5 Wh
Power Consumption	Power off	Less than 0 W
Power Consumption	TEC	<ul style="list-style-type: none"> <li>• E77822, E78323: 1.438 Wh</li> <li>• E77825, E78325: 1.580 Wh</li> <li>• E77830, E78330: 2.034 Wh</li> </ul>
Default Sleep Delay Time	Sleep mode operation	2 minutes

**Table 1-7** General specifications (continued)

Item	Description	Specification
Maximum Sleep Delay Time	Sleep mode operation	60 minutes
Power Requirement	Operation	<ul style="list-style-type: none"> <li>• Input Voltage (Europe): AC 220–240 V (+-6%)</li> <li>• Input voltage (USA): AC 110–127 V (+-10%)</li> <li>• Input Voltage (Korea): AC 220–240 V (+-6%)</li> <li>• Rated Frequency: 50/60 Hz (+-2Hz)</li> </ul>
Acoustic Noise Level (Power)	Power Emissions	<ul style="list-style-type: none"> <li>• Acoustic power emissions</li> <li>• Acoustic power emissions (ready)</li> <li>• Acoustic power emissions (active, copy)</li> <li>• Acoustic power emissions (active, scan)</li> </ul>
Acoustic Noise Level (Pressure)	Pressure Emissions	<ul style="list-style-type: none"> <li>• Acoustic pressure emissions bystander (active, printing)</li> <li>• Acoustic pressure emissions bystander (ready)</li> <li>• Acoustic pressure emissions bystander (active, copy)</li> <li>• Acoustic pressure emissions bystander (active, scan)</li> </ul>
Recommended monthly print volume	Operation	<ul style="list-style-type: none"> <li>• E77822, E78323: 4400 pages</li> <li>• E77825, E78325: 5100 pages</li> <li>• E77830, E78330: 6300 pages</li> </ul>
Max monthly duty cycle	Operation	Up to 30,000 recommended monthly page volume

## Print specifications

Learn about the print specifications.

**Table 1-8** Print specifications

Item	Description	Specification
Print speed	Simplex	<ul style="list-style-type: none"> <li>• E77822               <ul style="list-style-type: none"> <li>– Up to 22 ppm</li> </ul> </li> <li>• E78323               <ul style="list-style-type: none"> <li>– Up to 23 ppm</li> </ul> </li> <li>• E77825/E78325</li> </ul>

**Table 1-8 Print specifications (continued)**

Item		Specification
		<ul style="list-style-type: none"> <li>– Up to 25 ppm</li> <li>• E77830/E78330</li> <li>– Up to 30 ppm</li> </ul>
FPOt	From Ready (mono/color)	<ul style="list-style-type: none"> <li>• E77822: Less than 12.0/9.3 seconds</li> <li>• E77825: Less than 11.3/9.1seconds</li> <li>• E77830: Less than 10.9/8.7 seconds</li> <li>• E78323: Less than 13.3/10.3 seconds</li> <li>• E78325: Less than 12.8/10.3 seconds</li> <li>• E78330: Less than 10.9/8.7 seconds</li> </ul>
FPOt	From Sleep (mono/color)	<ul style="list-style-type: none"> <li>• E77822: Less than 27/27 seconds</li> <li>• E77825: Less than 27/27 seconds</li> <li>• E77830: Less than 27/27 seconds</li> <li>• E78323: Less than 24/24 seconds</li> <li>• E78325: Less than 24/24 seconds</li> <li>• E78330: Less than 24/24 seconds</li> </ul>
Resolution	Optical	600 x 600 dpi
Resolution	Enhanced	Up to 1200 x 1200 dpi with reduced speed
Printer Language		HP PCL 6/HP PCL 5c/HP PostScript Level 3 Emulation/PDF (v1.7)/AirPrint™ compatible
Font		84 scalable TrueType fonts
Network Protocol		<ul style="list-style-type: none"> <li>• IPv4/IPv6: Apple Bonjour Compatible (Mac OS 10.2.4 or higher), SNMPv1/v2c/v3, HTTP, HTTPS, FTP, TFTP, Port 9100, LPD, WS Discovery, IPP, Secure-IPP, IPsec/Firewall</li> <li>• IPv6: DHCPv6, MLDv1, ICMPv6</li> <li>• IPv4: Auto-IP, SLP, Telnet, IGMPv2, BOOTP/DHCP, WINS, IP Direct Mode, WS Print</li> <li>• Other: NetWare NDS, Bindery, NDPS, ePrint; Google Cloud Print 2.0</li> </ul>
Duplex Print	Automatic (standard)	



**Table 1-8** Print specifications (continued)

Item	Specification
Direct Print	PRN/PDF/TIFF/JPEG/XPS
Print Features	<ul style="list-style-type: none"><li>• WSD print</li><li>• Secure print</li><li>• Stored print</li><li>• Booklet</li><li>• N-up</li><li>• Cover page</li><li>• Insert page</li><li>• Except page</li><li>• Barcode</li><li>• Eco</li><li>• Poster</li><li>• Glossy</li><li>• Watermark</li><li>• Tray priority setting</li><li>• Auto tray setting</li><li>• Tray protection</li><li>• USB print</li><li>• Secure PDF print</li><li>• Google Cloud print</li></ul>

## Scan specifications

Learn about the scan specifications.

**Table 1-9** Scan specifications

Item	Specification
Scan method	MMT
Compatibility	Network TWAIN/Network SANE
Color Mode	Mono/Gray/Color

**Table 1-9 Scan specifications (continued)**

Item		Specification
Scan Speed	Scan to folder speeds (hardware)	DN bundles (black and white, gray scale, and color): <ul style="list-style-type: none"> <li>• Simplex up to 80 ipm @ 300 x 300 dpi</li> <li>• Duplex up to 160 ipm @ 300 x 300 dpi</li> </ul> Z bundles (black and white, gray scale, and color): <ul style="list-style-type: none"> <li>• Simplex up to 120 ipm @ 300 x 300 dpi</li> <li>• Duplex up to 240 ipm @ 300 x 300 dpi</li> </ul>
Scan Speed	Gray	<ul style="list-style-type: none"> <li>• E77822, E78323                             <ul style="list-style-type: none"> <li>– Simplex: Up to 45 ipm @ 600 dpi</li> <li>– Duplex: Up to 18 ipm @ 600 dpi</li> </ul> </li> <li>• E77825, E78325                             <ul style="list-style-type: none"> <li>– Simplex: Up to 80 ipm @ 600 dpi</li> <li>– Duplex: Up to 100 ipm @ 600 dpi</li> </ul> </li> <li>• E77830, E78330                             <ul style="list-style-type: none"> <li>– Simplex: Up to 80 ipm @ 600 dpi</li> <li>– Duplex: Up to 100 ipm @ 600 dpi</li> </ul> </li> </ul>
Scan Speed	Color	<ul style="list-style-type: none"> <li>• E77822, E78323                             <ul style="list-style-type: none"> <li>– Simplex: Up to 45 ipm @ 600 dpi</li> <li>– Duplex: Up to 18 ipm @ 600 dpi</li> </ul> </li> <li>• E77825, E78325                             <ul style="list-style-type: none"> <li>– Simplex: Up to 80 ipm @ 600 dpi</li> <li>– Duplex: Up to 100 ipm @ 600 dpi</li> </ul> </li> <li>• E77830, E78330</li> </ul>

Table 1-9 Scan specifications (continued)

Item	Specification	
	<ul style="list-style-type: none"> <li>– Simplex: Up to 80 ipm @ 600 dpi</li> <li>– Duplex: Up to 100 ipm @ 600 dpi</li> </ul>	
File Formats	<ul style="list-style-type: none"> <li>• PDF</li> <li>• Search-able PDF</li> <li>• Compact PDF</li> <li>• PDF Encryption</li> <li>• Digital Signature in PDF</li> <li>• PDF/A</li> <li>• Single-Page PDF</li> <li>• Multi-page PDF</li> <li>• TIFF</li> <li>• Single-Page TIFF</li> <li>• Multi-page TIFF</li> <li>• XPS</li> <li>• Single-Page XPS</li> <li>• Multi-page XPS</li> <li>• JPEG</li> <li>• PNG</li> </ul>	
Resolution	Optical (ADF)	Up to 600 x 600 dpi
Resolution	Optical (flatbed)	Up to 600 x 600 dpi
Resolution	Enhanced (ADF)	Up to 4800 x 4800 dpi
Resolution	Enhanced (flatbed)	Up to 4800 x 4800 dpi
Scan Destinations	<ul style="list-style-type: none"> <li>• Email</li> <li>• FTP</li> <li>• SMB</li> <li>• HDD</li> <li>• USB</li> <li>• WSD</li> <li>• PC</li> </ul>	
Multi-destinations	Yes	

**Table 1-9 Scan specifications (continued)**

Item		Specification
Communication Protocol		<ul style="list-style-type: none"> <li>• SMTP (IPv4, IPv6, SSL/TLS)</li> <li>• FTP (IPv4, IPv6)</li> <li>• SMB (IPv4, IPv6)</li> <li>• WSD</li> <li>• T4Net</li> </ul>
Scan Size	ADF	Minimum for dn bundles: 128 x 140 mm (5 x 5.5 in)  Minimum for z bundles: 105 x 148 mm (4.13 x 5.82 in)  Maximum: 297 x 432 mm (11.7 x 17 in)
	Flatbed	Maximum: 297 x 432 mm (11.7 x 17 in)
Scan Original Types		Text/Text & Photo/Photo

## Copy specifications

Learn about the copy specifications.

**Table 1-10 Copy specifications**

Item		Specification
Copy Speed	Single Document Multiple Copy (SDMC)	<ul style="list-style-type: none"> <li>• E77822, E78323                             <ul style="list-style-type: none"> <li>– Up to 22 cpm</li> </ul> </li> <li>• E77825, E78325                             <ul style="list-style-type: none"> <li>– Up to 25 cpm</li> </ul> </li> <li>• E77830, E78330                             <ul style="list-style-type: none"> <li>– Up to 30 ppm</li> </ul> </li> </ul>
FCOT	From Ready (mono/color)	<ul style="list-style-type: none"> <li>• E77822: Less than 9.9/8.7 seconds</li> <li>• E77825: Less than 9.0/7.7 seconds</li> <li>• E77830: Less than 8.0/6.8 seconds</li> <li>• E78323: Less than 11.0/9.7 seconds</li> <li>• E78325: Less than 10.2/8.7 seconds</li> <li>• E78330: Less than 8.0/6.8 seconds</li> </ul>
Resolution	ADF (Flow ADF/ADF)	<ul style="list-style-type: none"> <li>• Scan: 600 x 600 dpi</li> <li>• Printing: 600 x 600 dpi</li> </ul>

**Table 1-10** Copy specifications (continued)

Item	Specification
Flatbed	<ul style="list-style-type: none"><li>• Scan: 600 x 600 dpi</li><li>• Printing: 600 x 600 dpi</li></ul>
Reduce/Enlarge	ADF (Flow ADF/ADF) 25–400%
Reduce/Enlarge	Flatbed 25–400%

**Table 1-10 Copy specifications (continued)**

Item	Specification
Copier Settings	• 2-sided copying
	• Scalability
	• Image adjustments (darkness, contrast, background clean up, sharpness)
	• Optimized text/picture (text, mixed, printed picture, photograph)
	• N-Up
	• N or Z-ordering
	• Content orientation
	• Collation
	• Booklet
	• ID scan
	• Job build
	• Job storage
	• Watermark
	• Stamps
	• Book mode scans
	• Erase edges
	• Automatically detect color/mono
• Image preview	
Copy Original Type	• Text
	• Text and Printed Photo
	• Text and Glossy Photo
	• Newspaper
	• Printed Photo
	• Glossy Photo
	• Copied Original
	• Map
	• Light Original
	• ID Copy
	• N-up
	• Booklet
	• Image Repeat
	• Auto Fit
	• Book Copy
	• Watermark
	• Image Overlay
• Stamp	

## Paper handling specifications

Learn about the paper handling specifications.

**Table 1-11 Paper handling specifications**

Item		Specification
Input Capacity	Standard	1040 sheets
Input Capacity	Multipurpose	100 sheets
Input Capacity	Other Options	Dual Cassette Feeder (2 x 520 sheets)
Input Capacity	Bottom High Capacity Input (bHCI)	2000 sheets, A4 only
Input Capacity	Maximum	1040 Std + 100 Tray 1 + 2000 bHCI
Standard Cassette Tray	Capacity	520 sheets x 2
Standard Cassette Tray	Media Sizes	<ul style="list-style-type: none"> <li>• Tray2: 140 x 210 mm to 297 x 364 mm (5.5 x 8.27 in) to (11.7 x 14.33 in)</li> <li>• Tray3: 140 x 210 mm to 297 x 432 mm (5.5 x 8.27 in) to (11.7 x 17 in)</li> </ul>
Standard Cassette Tray	Media Types	<ul style="list-style-type: none"> <li>• Plain</li> <li>• Thin</li> <li>• Bond</li> <li>• Hole Punched</li> <li>• Pre-Printed</li> <li>• Recycled</li> <li>• Thin Cardstock</li> <li>• Letterhead</li> <li>• Thick</li> <li>• Cotton</li> <li>• Colored</li> <li>• Archive</li> <li>• Thin Glossy</li> <li>• Heavy Weight</li> </ul>

**Table 1-11 Paper handling specifications (continued)**

Item		Specification
Standard Cassette Tray	Media Weight	<ul style="list-style-type: none"> <li>• Plain Paper: 70-90 g/m<sup>2</sup> (18.5-24 lb/ Duplex)</li> <li>• Thick Paper: 91-105 g/m<sup>2</sup> (25-28 lb/ Duplex)</li> <li>• Heavy Weight Paper : 106-176 g/m<sup>2</sup> (Duplex)</li> <li>• Extra Heavy Weight 1 Paper : 177-220 g/m<sup>2</sup></li> <li>• Thin Paper: 60-69 g/m<sup>2</sup> (16-19 lb/Duplex)</li> <li>• Cotton paper: 75-90 g/m<sup>2</sup> (Duplex)</li> <li>• Colored: 75-90 g/m<sup>2</sup> (Duplex)</li> <li>• Pre-Printed: 71-90 g/m<sup>2</sup> (Duplex)</li> <li>• Recycled: 60-90 g/m<sup>2</sup> (Duplex)<sup>2</sup></li> <li>• Bond Paper: 105-120 g/m<sup>2</sup> (Duplex)<sup>2</sup></li> <li>• Letterhead: 75-90 g/m<sup>2</sup> (Duplex)<sup>2</sup></li> <li>• Hole Punched Paper: 75-90 g/m<sup>2</sup> (Duplex)</li> <li>• Thin CardStock: 105-163 g/m<sup>2</sup> (Duplex)</li> <li>• Thin Glossy : 106-163 g/m<sup>2</sup> (Duplex)</li> </ul>
Standard Cassette Tray	Sensing	<ul style="list-style-type: none"> <li>• H/W Install Detect: Yes</li> <li>• Paper Empty and Low Level Detect: Yes</li> <li>• Paper Type Detect: No</li> <li>• Paper Size Detect: Yes</li> </ul>
Tray 1	Capacity	100 sheets
Tray 1	Media Sizes	98 x 148 mm to 297 x 432 mm (3.8 x 5.8 in) to (11.7 x 17 in)



**Table 1-11 Paper handling specifications (continued)**

Item	Specification	
Tray 1	Media Types	
	<ul style="list-style-type: none"> <li>• Plain</li> <li>• Thin</li> <li>• Bond</li> <li>• Hole Punched</li> <li>• Pre-Printed</li> <li>• Recycled</li> <li>• Thin Cardstock</li> <li>• Letterhead</li> <li>• Thick</li> <li>• Cotton</li> <li>• Colored</li> <li>• Archive</li> <li>• Thin Glossy</li> <li>• Heavy Weight</li> <li>• Envelope</li> <li>• Label</li> <li>• Card transparency</li> </ul>	
Tray 1	Media Weight	
	60 to 176 g/m <sup>2</sup> (16 to 47 lb): Simplex, Duplex Envelope (75 to 90 g/m <sup>2</sup> ) Label (120 to 150 g/m <sup>2</sup> ): Simplex	
Tray 1	Sensing	
	Paper Empty Detect: Yes Paper Size Detect: No	
Automatic document feeder (ADF) (LX/dn models)	Capacity	
		<ul style="list-style-type: none"> <li>• 250 sheets for flow (GX/z models)</li> <li>• 100 sheets for Managed (LX/dn models)</li> </ul>
	Duplex document scanning	Yes
	Document Size	<ul style="list-style-type: none"> <li>• Width: 128 mm-297 mm ((5 in-11.7 in))</li> <li>• Length: 128 mm-432 mm ((5 in- 17in))</li> </ul>
	Document Weight	<ul style="list-style-type: none"> <li>• E72525/72825               <ul style="list-style-type: none"> <li>– Simplex: 42 — 163 g/m<sup>2</sup> (11.25— 43.25 lb)</li> <li>– Duplex: 50 — 128 g/m<sup>2</sup> (12.25— 34 lb)</li> </ul> </li> <li>• E72530/72830, E72535/72835</li> </ul>

**Table 1-11 Paper handling specifications (continued)**

Item	Specification	
		<ul style="list-style-type: none"> <li>– Simplex: 42 — 163 g/m<sup>2</sup> (11.25— 43.25 lb)</li> <li>– Duplex: 50 — 128 g/m<sup>2</sup> (12.25— 34 lb)</li> <li>• E77822, E78323</li> <li>– Simplex: 42 — 163 g/m<sup>2</sup> (11.25— 43.25 lb)</li> <li>– Duplex: 50 — 128 g/m<sup>2</sup> (12.25— 34 lb)</li> <li>• E77825, E77830, E78325, E78330</li> <li>– Simplex: 42 — 163 g/m<sup>2</sup> (11.25— 43.25 lb)</li> <li>– Duplex: 50 — 128 g/m<sup>2</sup> (12.25— 34 lb)</li> </ul>
Automatic document feeder (ADF) (GX/d models)	Capacity	250 sheets
	Document size	<ul style="list-style-type: none"> <li>• Width : 105 mm - 297 mm (5in - 11.7in)</li> <li>• Length : 140 mm - 432 mm (5.5in - 17in)</li> </ul>
	Document Weight	Simplex: 60 — 163 g/m <sup>2</sup> (11.25— 43.24 lb) (guarantee) 42-60 g/m and 163-220 g/m <sup>2</sup> (support)
	Auto Detected Size	A3/A4/A5/A6 SEF/B4/B5/Letter/Legal/Statement/Folio/Executive
Printer Output Capacity	Standard	500 sheets, face down
Printer Output Capacity	Maximum	615 sheets 500 sheets (Standard) + 125 sheets (Job Separator)
Printing Size	Maximum Size	297 x 432 mm (11.7 x 17 in)
Printing Size	Minimum Size	98 mm x 148 mm (3.8 in x 5.8 in)
Maximum Printing Area	Trays 1–3	Top: 4.23 +/- 1.5 mm / Left: 4.23 +/- 1.5 mm
Maximum Printing Area	Simplex from optional trays	Top and Left: 4.23 +/- 2 mm
Maximum Printing Area	Duplex	Top: 4.23 +/- 2 mm / Left: 4.23 +/- 2 mm
Duplex Printing	Support	Built-in
Duplex Printing	Media Sizes	<ul style="list-style-type: none"> <li>• 140 mm x 182 mm (5.5in x 7.2 in)</li> <li>• 297 mm x 432 mm (11.7 in x 17 in)</li> </ul>

**Table 1-11 Paper handling specifications (continued)**

Item		Specification
Duplex Printing	Media Types	<ul style="list-style-type: none"> <li>• Plain</li> <li>• Thin</li> <li>• Bond</li> <li>• Punched</li> <li>• Pre-Printed</li> <li>• Recycled</li> <li>• Thin Cardstock</li> <li>• Letterhead</li> <li>• Thick</li> <li>• Cotton</li> <li>• Colored</li> <li>• Archive</li> <li>• Thin Glossy</li> <li>• Heavy Weight</li> </ul>
Duplex Printing	Media weight	60 to 176 g/m <sup>2</sup> (16 to 47 lb)

## Supplies

Learn about the required toner cartridge and toner collection unit (TCU).


**Table 1-12 Supplies**


Item	Part number	Average yield
HP LJ Toner Cartridge - Cyan <sup>1</sup>	• X3A83-67901 (For E77822, E77825, E77830)	28,000 pages
	• W9211-67901 (For E78323, E78325, E78330)	
HP LJ Toner Cartridge - Magenta <sup>1</sup>	• X3A83-67902 (For E77822, E77825, E77830)	28,000 pages
	• W9213-67901 (For E78323, E78325, E78330)	
HP LJ Toner Cartridge - Yellow <sup>1</sup>	• X3A83-67903 (For E77822, E77825, E77830)	28,000 pages
	• W9212-67901 (For E78323, E78325, E78330)	
HP LJ Toner Cartridge - Black <sup>1</sup>	• X3A83-67904 (For E77822, E77825, E77830)	29,000 pages
	• W9201-67901 (For E78323, E78325, E78330)	

**Table 1-12 Supplies (continued)**

Item	Part number	Average yield
SVC-Cyan Mngd LJ Toner Cartridge <sup>1</sup>	W9191MC (For E77822, E77825, E77830)	28,000 pages
	W9211MC (For E78323, E78325, E78330)	
	W9191-67902 (Service) (For E77822, E77825, E77830)	
SVC-Magenta Mngd LJ Toner Cartridge <sup>1</sup>	W9193MC (For E77822, E77825, E77830)	28,000 pages
	W9213MC (For E78323, E78325, E78330)	
	W9193-67902 (service) (For E77822, E77825, E77830)	
SVC-Yellow Mngd LJ Toner Cartridge <sup>1</sup>	W9212-67901 (For E78323, E78325, E78330)	28,000 pages
	W9212MC (For E78323, E78325, E78330)	
	W9192-67902 (service) (For E77822, E77825, E77830)	
SVC-Black Mngd LJ Toner Cartridge <sup>1</sup>	W9210-67901 (For E78323, E78325, E78330)	29,000 pages
	W9210MC (For E78323, E78325, E78330)	
	W9190-67902 (service) (For E77822, E77825, E77830)	
HP LJ Toner Collection Unit	X3A83-67923	33,700 pages

<sup>1</sup>Print cartridge life is approximate, based on average A4 /Letter-size page count with ISO coverage. Declared cartridge yield value in accordance with ISO/IEC 19798. Actual yields vary considerably based on images printed and other factors. For more information, visit [www.hp.com/go/learnaboutesupplies](http://www.hp.com/go/learnaboutesupplies).

 **NOTE:** Depending on the print pattern and job mode used, the lifespan of the consumable can vary.

 **IMPORTANT:** Toner cartridges or other supplies must be purchased in the same country/region as the printer being used. Otherwise, new toner cartridges or other supplies will be incompatible with the printer. This is due to differing configurations of toner cartridges and other supplies according to the conditions of a specific country/region.

## Maintenance parts

Learn about the printer maintenance parts.

HP recommends replacing the following maintenance parts at specific intervals to make sure the printer produces quality copies and to extend the service life of the printer.

Some of the printer parts have a shorter lifespan than the life of the printer.

**Table 1-13 Maintenance parts**

Item	Product number	Life
HP Managed LJ Imaging Drum	X3A83-67905 (for E77822, E77825, E77830)	135,000 pages
	W9215-67901 (For E78323, E78325, E78330)	
HP Managed LJ Toner Collection Unit	X3A83-67923	33,700 pages
HP LaserJet Cyan Developer Unit	8JM71-67001 (for E77822, E77825, E77830)	300,000 pages
	JC96-11665A (For E78323, E78325, E78330)	
HP LaserJet Magenta Developer Unit	8JM73-67001 (for E77822, E77825, E77830)	300,000 pages
	JC96-11664A (For E78323, E78325, E78330)	
HP LaserJet Yellow Developer Unit	8JM72-67001 (for E77822, E77825, E77830)	300,000 pages
	JC96-11663A (For E78323, E78325, E78330)	
HP LaserJet Black Developer Unit	8JM70-67001 (for E77822, E77825, E77830)	300,000 pages
	JC96-11666A (For E78323, E78325, E78330)	
HP LaserJet 110V Fuser Assembly	JC82-00472A (for E77822, E77825, E77830)	250,000 pages
	X3A64-61001 (For E78323, E78325, E78330)	
HP LaserJet 220V Fuser Assembly	JC82-00485A (for E77822, E77825, E77830)	250,000 pages
	X3A64-61002 (For E78323, E78325, E78330)	
HP LaserJet Image Transfer Cleaner	JC96-06246A (for E77822, E77825, E77830)	150,000 pages
	5PN64-67001 (For E78323, E78325, E78330)	GEMs 1.2 : 200,000 pages
HP LaserJet image transfer belt (ITB)	JC98-00980D (For E77822, E77825, E77830)	GEMs 1.0 : 300,000 pages
	5PN63-67001 (For E78323, E78325, E78330)	GEMs 1.2 : 400,000 pages
HP LaserJet Transfer Roller (T2)	JC95-02274A (For E77822, E77825, E77830)	GEMs 1.0 : 150,000 pages
	5QJ90-61041 (For E78323, E78325, E78330)	GEMs 1.2 : 200,000 pages
HP LaserJet Trays 2-x Rollers	JC93-00540A	200,000 pages

**Table 1-13 Maintenance parts (continued)**

Item	Product number	Life
HP LaserJet Tray 1 Roller	JC93-00540B	200,000 pages
Flow ADF pick roller assembly(GX and sGX z models)	Z8W50A	200,000 pages
ADF pick roller assembly(LX dn models)	Z7Y64A	200,000 pages
ADF reverse(separation) roller assembly(LX dn models)	Z7Y65A	100,000 pages
Flow ADF reverse(separation) roller assembly(GX and sGX z models)	Z8W51A	200,000 pages



**NOTE:** Depending on print patterns and the job mode used, maintenance part lifespans vary.

## Optional

Learn about the printer optional parts.

**Table 1-14 Optional list**

Item	Model	E77830	E77825	E77822	E78330	E78325	E78323
HP LaserJet Dual Cassette Workgroup Feeder	Y1F97A	Yes	Yes	Yes	Yes	Yes	Yes
HP LaserJet Workgroup Cabinet	Y1G17A	Yes	Yes	Yes	Yes	Yes	Yes
HP LaserJet 2000 Sheet High Capacity Tray WG	Y1F99A	Yes	Yes	Yes	Yes	Yes	Yes
HP LaserJet Inner Finisher	Y1G00A	Yes	Yes	Yes	Yes	Yes	Yes
HP LaserJet Booklet Finisher	Y1G07A	Yes	Yes	Yes	Yes	Yes	Yes
HP LaserJet Job Separator WG	Y1G15A	Yes	Yes	Yes	Yes	Yes	Yes
HP LaserJet Stapler/Stacker Finisher Staples	Y1G14A	Yes	Yes	Yes	Yes	Yes	Yes
HP LaserJet Inner/Booklet Finisher Staples	Y1G13A	Yes	Yes	Yes	Yes	Yes	Yes

**Table 1-14** Optional list (continued)

Item	Model	E77830	E77825	E77822	E78330	E78325	E78323
HP LaserJet Inner Finisher Hole 2/3 Punch	Y1G02A	Yes	Yes	Yes	Yes	Yes	Yes
HP LaserJet Inner Finisher Hole 2/4 Punch	Y1G03A	Yes	Yes	Yes	Yes	Yes	Yes
HP LaserJet Inner Finisher Swedish Punch	Y1G04A	Yes	Yes	Yes	Yes	Yes	Yes
HP LaserJet Hole Punch 2/3 Accessory	Y1G10A	Yes	Yes	Yes	Yes	Yes	Yes
HP LaserJet Hole Punch 2/4 Accessory	Y1G11A	Yes	Yes	Yes	Yes	Yes	Yes
HP LaserJet Hole Punch Swedish Accessory	Y1G12A	Yes	Yes	Yes	Yes	Yes	Yes
HP LaserJet Paper Tray Heaters WG	Y1G22A	Yes	Yes	Yes	Yes	Yes	Yes
HP LaserJet Paper Tray Heaters Accessory WG 110V	Y1G22A#BGJ	Yes	Yes	Yes	Yes	Yes	Yes
HP LaserJet Paper Tray Heaters Accessory WG 220V	Y1G22A#B19	Yes	Yes	Yes	Yes	Yes	Yes
HP Second Exit <sup>1</sup>	Y1G23A	Yes	Yes	Yes	Yes	Yes	Yes

<sup>1</sup>Required to attach an external finisher and installing an inner finisher.

# Feeding system

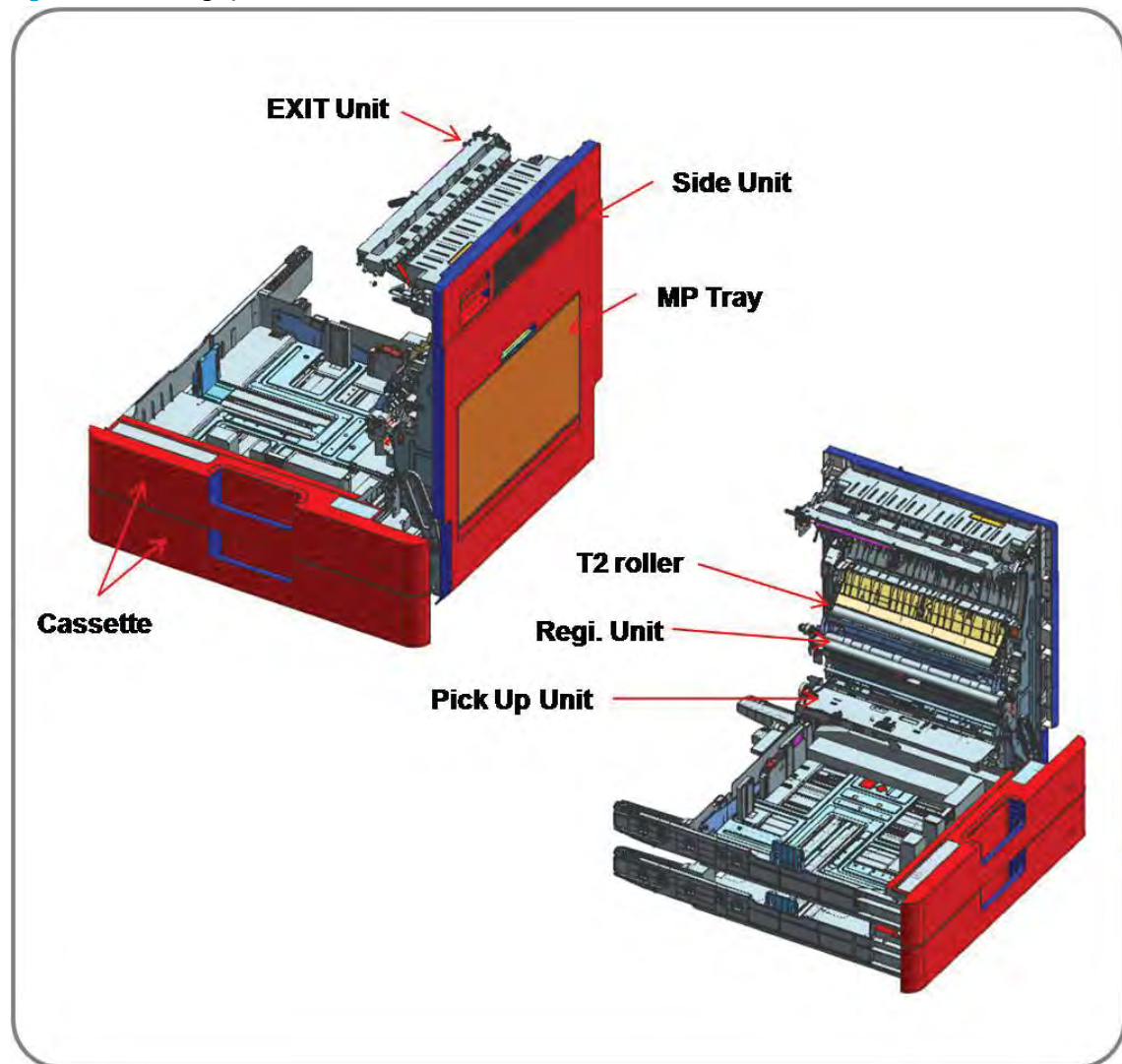
Learn about the feeding system.

## Feeding system overview

Learn about the feeding system overview.

The feeding system picks up paper from the cassette or Tray 1 and moves it to the printing mechanism inside the printer. The feeding system consists of the pickup unit, registration unit, transfer roller assembly, and exit unit.

Figure 1-5 Feeding system overview





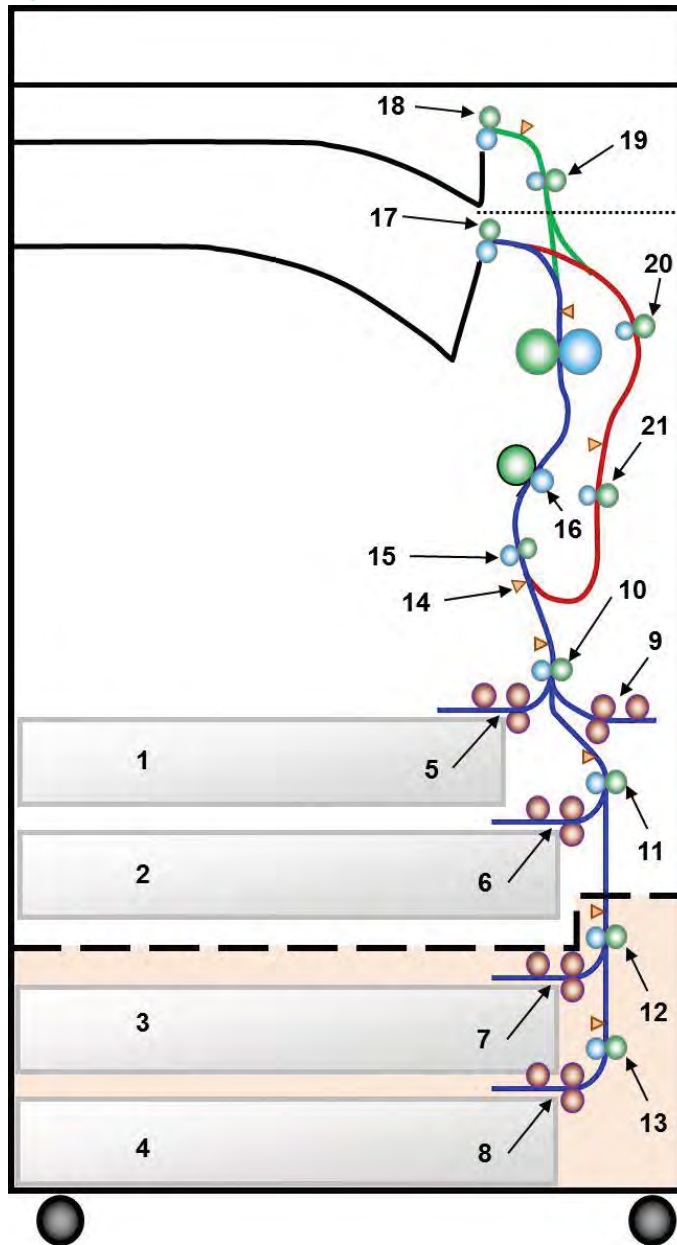
## Main components and functions

Learn about main components and their functions.

### Rollers

Learn about the rollers.

Figure 1-6 Rollers



Callout	Description	Callout	Description
1	Tray 2	12	Tray 4 paper path rollers
2	Tray 3	13	Tray 5 paper path rollers
3	Tray 4 (optional)	14	Sensor registration

(continued)

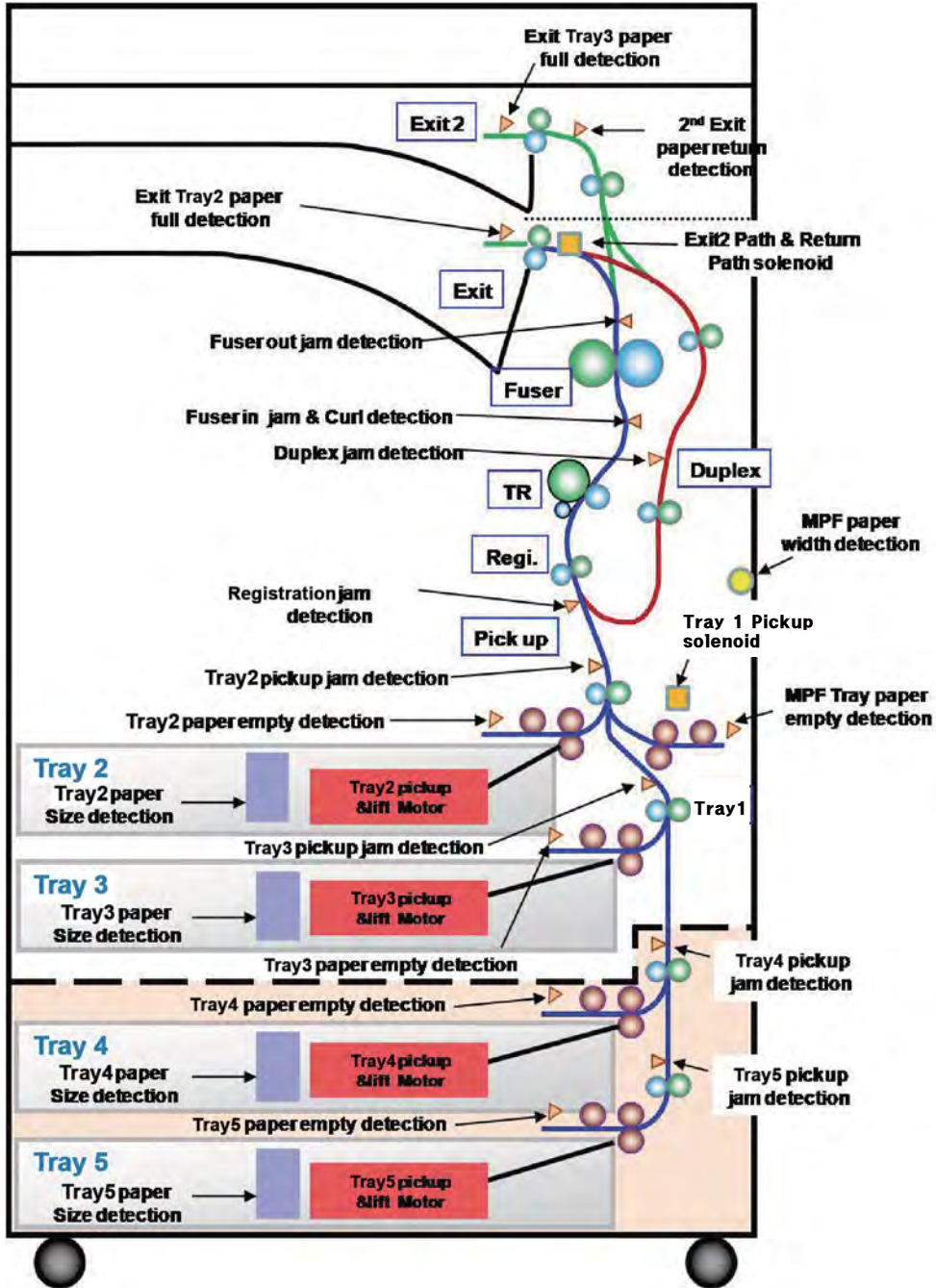
Callout	Description	Callout	Description
4	Tray 5 (optional)	15	Roller registration
5	Tray 2 pick/separation/feed rollers	16	Roller transfer
6	Tray 3 pick/separation/feed rollers	17	Roller output 1st
7	Tray 4 pick/separation/feed rollers	18	Roller output 2nd
8	Tray 5 pick/separation/feed rollers	19	Roller invert
9	Tray 1 pick/separation/feed rollers	20	Roller duplex 1
10	Tray 2 paper path rollers	21	Roller duplex 2
11	Tray 3 paper path rollers		

- Pickup roller (Tray 1, 2, 3, 4, and 5)
  - This roller picks up the paper from the tray.
- Feed roller (Tray 1, 2, 3, 4, and 5)
  - This roller is placed against the reverse roller. It transfers the paper from the pickup roller to the feed roller.
- Separation roller (Tray 1, 2, 3, 4, and 5)
  - This roller is placed against the feed roller and transfers only one sheet of paper to the feed roller. When two or more sheets of paper are being transferred from the pickup roller, the load of the torque limiter of the reverse roller is heavier than the frictional force between the sheets of paper. As a result, the reverse roller is stopped and the lower sheet of paper is not transferred.
- Feed roller
  - This roller transfers the paper came from the forward/separation roller to the registration roller.
- Registration roller
  - This roller aligns the leading edge of the paper and transfers the paper to the transfer roller assembly.

## Sensor, motor, and solenoid

Learn about the sensor, motor, and solenoid.

Figure 1-7 Sensor, motor, and solenoid

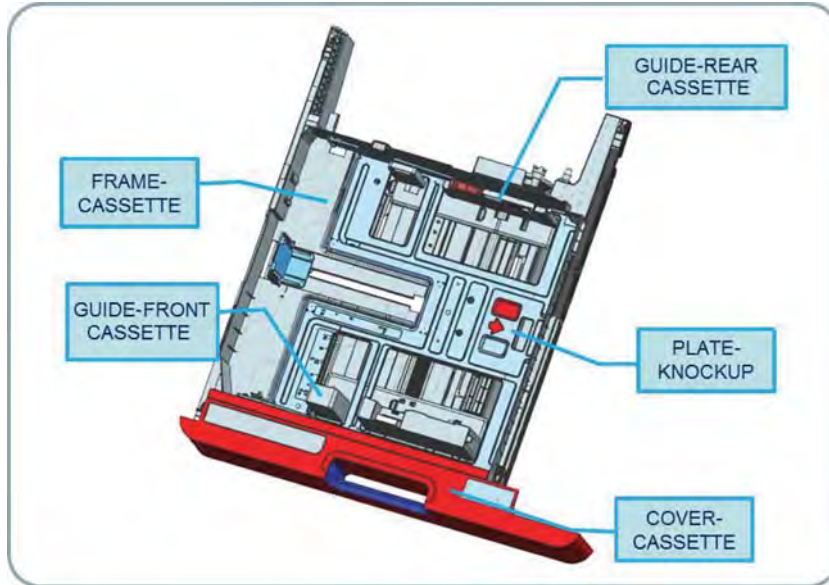


## Cassette

Learn about the cassette.

The tray stores paper. The paper size is set using the guides in each tray.

Figure 1-8 Basic cassette



Item	Description
1	Structure: Drawer Type
2	Capacity: 520 sheets (80 g/m <sup>2</sup> paper standard)
3	Paper type <b>NOTE:</b> Tray 2 does not support A3 or 11 x 17 paper.
4	Paper weight <ul style="list-style-type: none"> <li>• Plain paper: 60–220 g/m<sup>2</sup></li> </ul>
5	Plate knock up lift type: Lift Motor + Up Limit Sensor

## Pickup Assembly

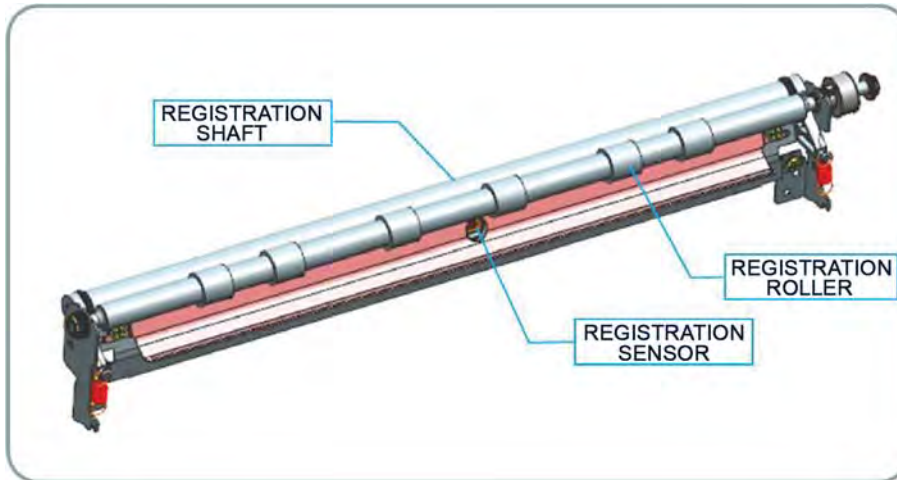
### Registration assembly

Learn about the registration assembly.

The registration roller is driven by the registration/multipurpose motor.

The registration roller clutch is located between the registration/Tray 1 motor and registration roller, or on the transfer belt (for color), and it controls power to the registration roller in order to match paper and an image on the drum at the predetermined registration point.

**Figure 1-9** Registration roller

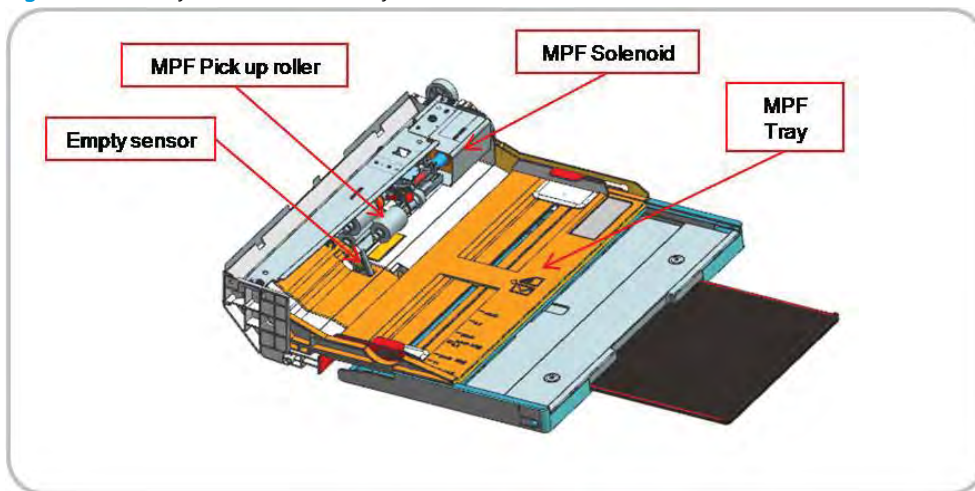


### Tray 1 (MP) feed assembly

Learn about the Tray 1 feed assembly.

The Tray 1 feed assembly allows feeding of special media cardstock and custom size paper.

**Figure 1-10** Tray 1 feeder assembly

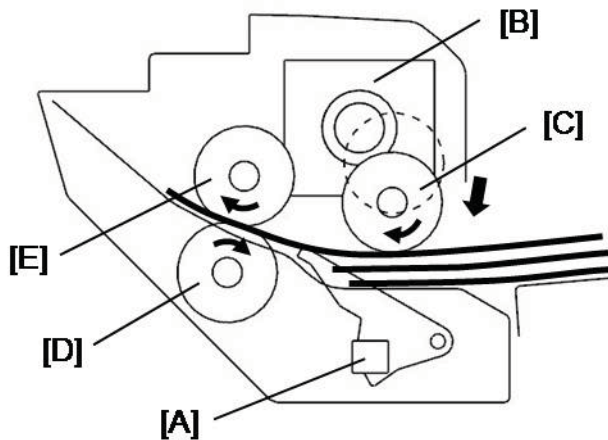


## Specification

- Capacity: 100 sheets (80g/m<sup>2</sup> / 21 lb paper standard)
- Media size: 297mm x 432 mm – 98 mm x 148 mm (11.7 in x 17 in – 3.87 in x 5.8 in)
- Media weight: Plain paper 60 – 176 g/m<sup>2</sup>
- Feeding speed: 30 ppm (E77430/78330), 25 ppm (E77425/78325), 22 ppm (E77422), 23 ppm (E78323) Letter/A4 LEF (Long Edge Feeding)

## Paper separation

Figure 1-11 Paper separation



When the Tray 1 paper detection [A] sensor detects paper and the machine gets a Tray 1 printing job, the Tray 1 solenoid [B] drops the pickup roller [C] onto the top of the paper stack in Tray 1.

This machine uses a Feed and Separation Roller (FSR) system for feeding paper. The friction between the separation roller [D] and feed roller [E] separates the top sheet of paper from the stack.

# Image creation

Learn about image creation.

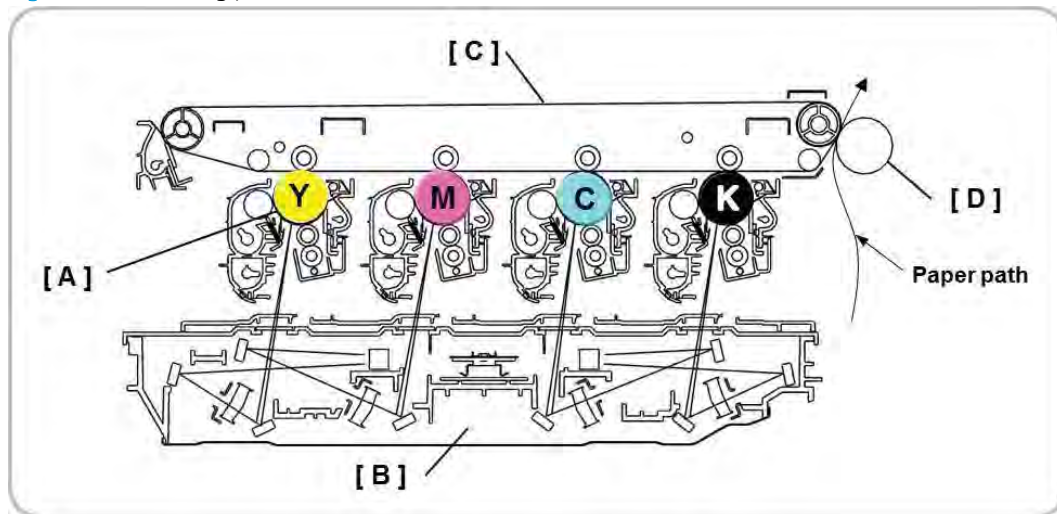
## Printing process overview

Learn about the printing process overview.

This printer uses four imaging units and four lasers for color printing. Each imaging unit consists of a drum unit and a developer unit.

The drum unit has an OPC drum, charge roller, cleaning roller, and cleaning blade.

**Figure 1-12** Printing process overview



The OPC drum (A) is charged with a negative voltage and is exposed by the light from the laser scanning assembly (B).

The light produced by the laser creates a latent image by discharging on the surface of the OPC drum. The negatively charged toner is attracted to the latent drum image due to an electric field. The toner (real image) on each OPC drum is moved to the image transfer belt (ITB) (C) by the positive bias applied to the first transfer roller. All four toners (color image) are transferred to the paper by a positive charge applied to the second transfer roller (D).

- 1. OPC drum charge:** The charge roller gives the drum a negative charge.
- 2. Laser exposure:** Light produced by a laser diode hits the charged OPC through the lens and mirrors.
- 3. Development:** The developing roller carries negatively charged toner to the latent image on the drum surface. This printer uses four independent drum and development units (one for each color).
- 4. Transfer:**
  - *Image transfer:* The first transfer roller opposite the OPC drums transfer toner from the drums to the ITB. Four toner images are super-imposed onto the belt.
  - *Paper transfer:* The second transfer roller transfers the toner from the ITB to the media.
- 5. Cleaning the OPC drum:** The cleaning brush and blade remove remaining toner on the drum surface after image transfer to the paper.

6. **Erasing for OPC drum:** Erasing is done by illuminating the whole area of the drum with the laser at the end of every job.
7. **Cleaning and erasing charges on the ITB:** The cleaning roller and blade clean the belt surface. The grounding roller inside the ITB unit removes the remaining charge from the belt.



## Imaging unit

Learn about the imaging unit.

### Imaging unit overview

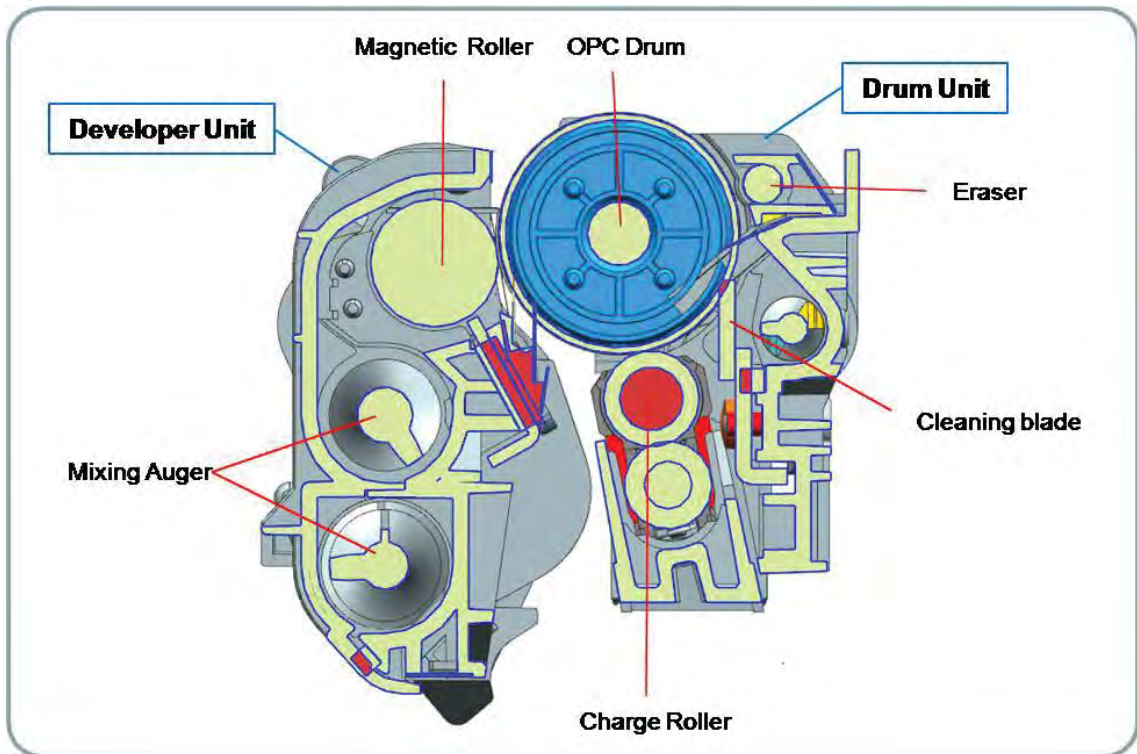
Learn about the imaging unit..

This printer uses a two-part imaging unit. It uses four color development and one paper path to increase color printing productivity.

Each imaging unit consists of the drum unit and the developer unit. The developer units are not interchangeable. The drum units are interchangeable. The diameter of the drum is 30 mm with a circumference of about 94.2 mm (3.7 in).

The development gap between a drum and the corresponding magnetic roller cannot be adjusted. The Customer-Replaceable Unit Monitor (CRUM) is the subpart of the drum unit. The CRUM stores job count information and other data.

Figure 1-13 Imaging unit



### Drum drive

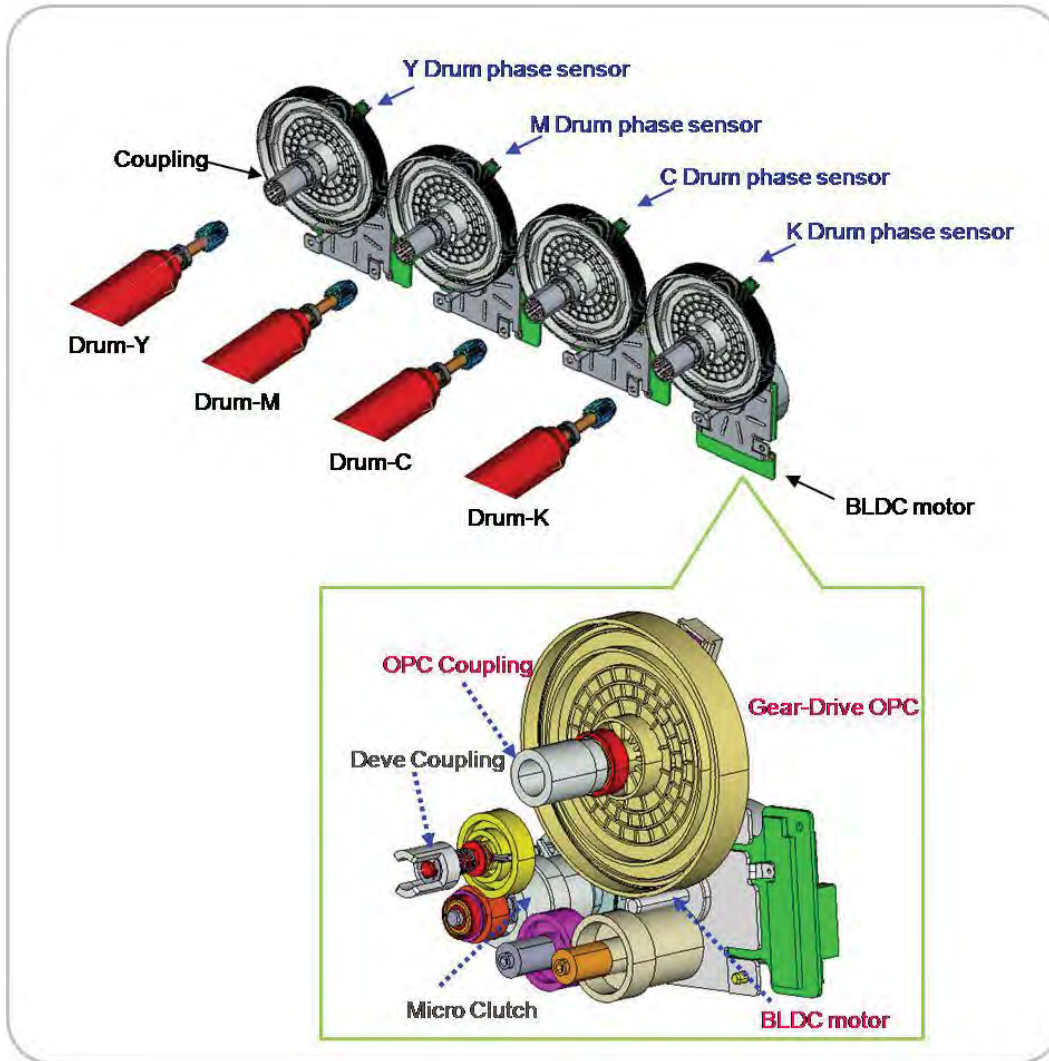
Learn about the drum drive unit.

The color OPCs and magnetic roller are driven by each color motor. The OPC drum and magnetic roller are powered by the coupling.

The Brushless Direct Current (BLDC) motor maintains constant speed. The speed sync for each color depends on the BLDC motor.

Phase sync for each OPC job prints the pattern on the Intermediate Transfer Belt (ITB) and is adjusted automatically.

Figure 1-14 Drum drive



## Developer unit

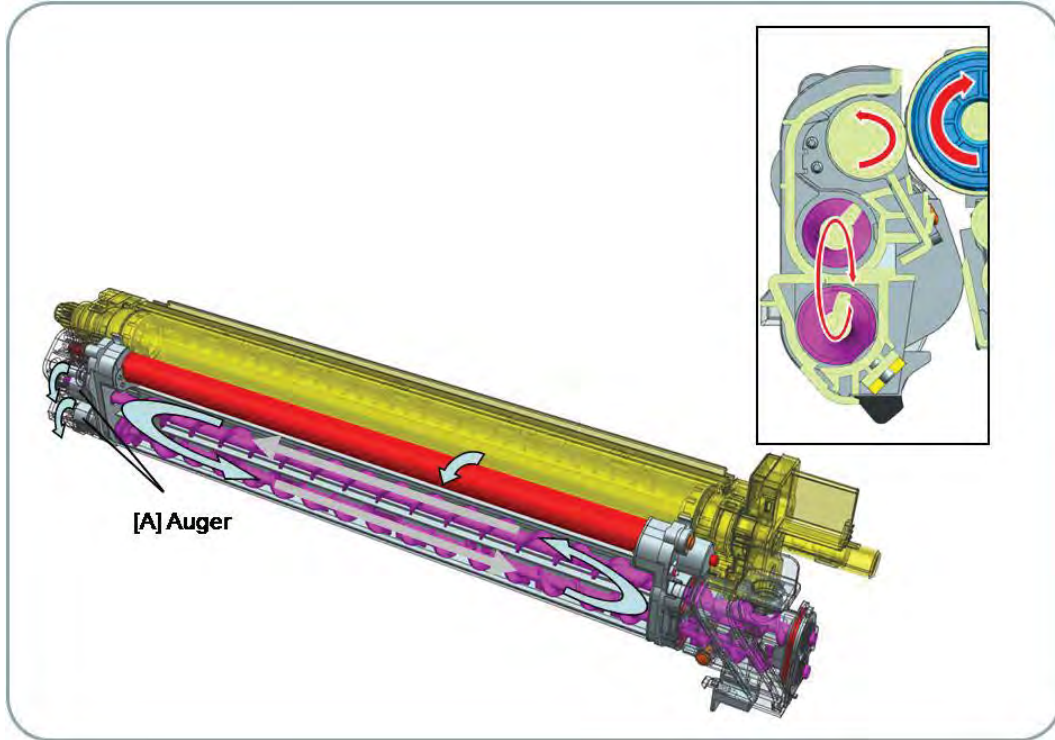
Learn about the developer unit.

This printer uses a dual-component development system that has four developer units. Each new unit contains 185 g (6.5 oz) of magnetic toner carrier.

The developer powder is supplied to the magnetic (development) roller [A] by the two mixing augers [B]. The diameter of the magnetic roller is 16 mm (0.63 in).

Each development unit has a toner carrier (TC) sensor [C]. It is used for controlling the operating range of the toner density.

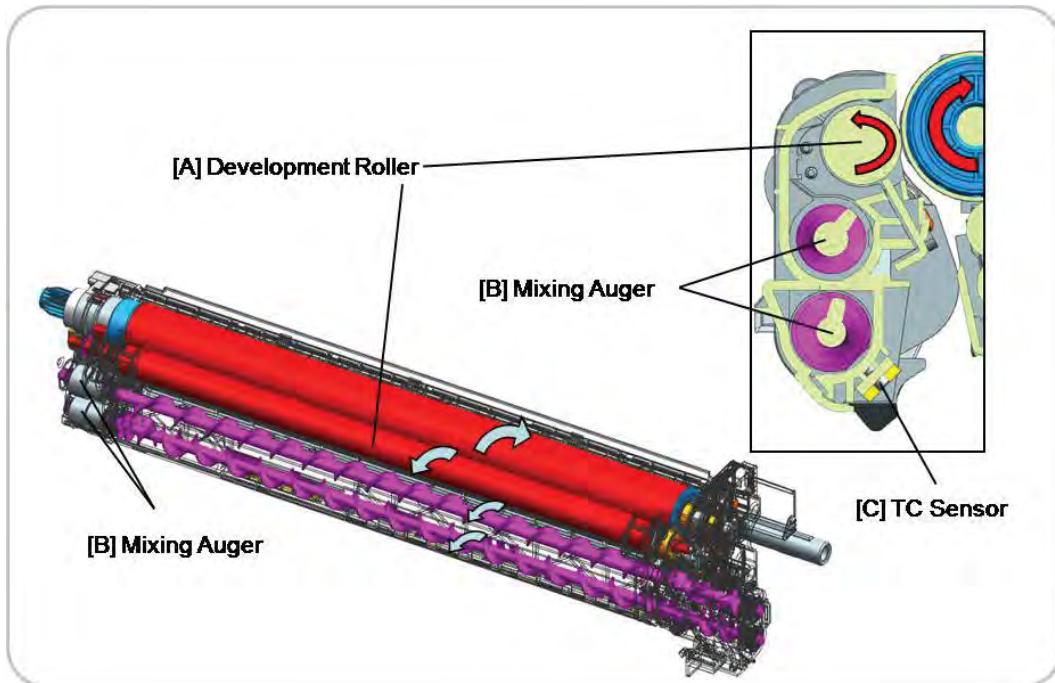
Figure 1-15 Developer unit



### Developer circulation

Two mixing augers (B) circulate the developer forward and backward in order to sufficiently mix the toner and carrier.

Figure 1-16 Developer auger



Agitation occurs at the following times:

- During the process control self-checking (warm up)
- During toner supply job
- During development job

If the developer unit is stored above 50°C (122°F), the toner might harden and will not work properly. If the toner in the development unit has hardened, an installation error occurs.

## Dynamic security

Learn about dynamic-security-enabled printers.

Certain HP printers use cartridges that have security chips or electronic circuitry. Cartridges using a non-HP chip or modified or non-HP circuitry\* might not work. And, those that work today might not work in the future.

As is standard in the printing business, HP has a process for authenticating cartridges. HP continues to use security measures to protect the quality of our customer experience, maintain the integrity of our printing systems, and protect our intellectual property. These measures include authentication methods that change periodically and might prevent some third-party supplies from working now or in the future. HP printers and original HP cartridges deliver the best quality, security and reliability. When cartridges are cloned or counterfeited, the customer is exposed to quality and potential security risks, compromising the printing experience.

**\*Non-HP Chips and modified or non-HP electronic circuitry** are not produced or validated by HP. HP cannot guarantee that these chips or circuitry will work in your printer now or in the future. If you are using a non-original HP cartridge, please check with your supplier to ensure your cartridge has an original HP security chip or unmodified HP electronic circuitry.

## Intermediate transfer belt unit

Learn about the intermediate transfer belt unit.

### Intermediate transfer belt overview

Learn about the intermediate transfer belt (ITB).

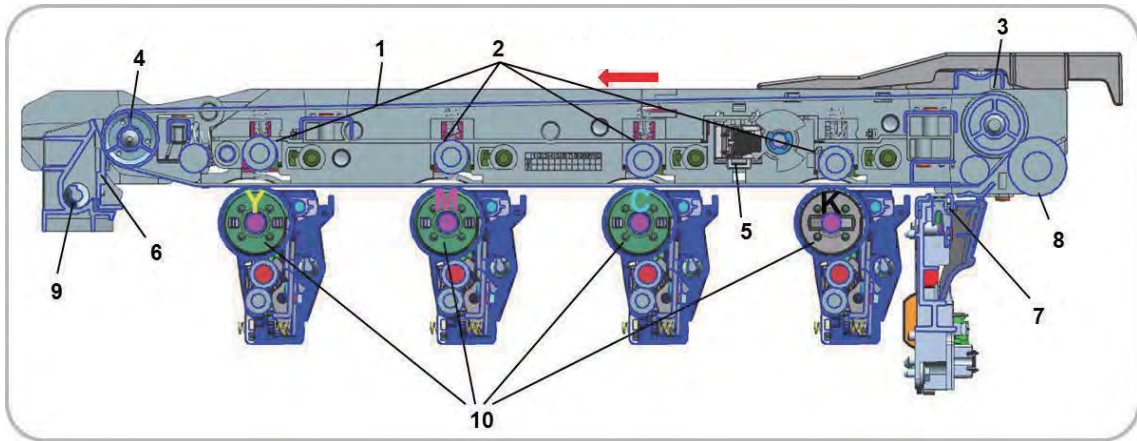
The toner on the four drums is transferred to the intermediate transfer belt (ITB) by the first transfer roller

The image overlapped by four colors is transferred to the paper by the second transfer roller. The remaining toners are removed by the cleaning blade and transferred to the toner collection unit.

This process is completed with one rotation of the ITB. The arrow above the C and M drums on the following diagram shows the direction of the ITB rotation. The ITB is rotated by friction between the drive roller and the ITB. The tension roller provides tension to prevent slipping.

There are three color plane registration (CPR) sensors and one photo sensor. Two CPR sensors are for line position adjustment and one is for process control. The photo sensor monitors the position of the first transfer rollers.

**Figure 1-17** Intermediate transfer belt



**Table 1-17** Intermediate transfer belt components

Item	Description
1	Intermediate transfer belt (ITB)
2	First transfer roller
3	ITB drive roller
4	Tension roller
5	Photo sensor
6	Cleaning blade
7	Color plane registration (CPR) sensor
8	Second transfer roller
9	Toner collection auger
10	Drum unit

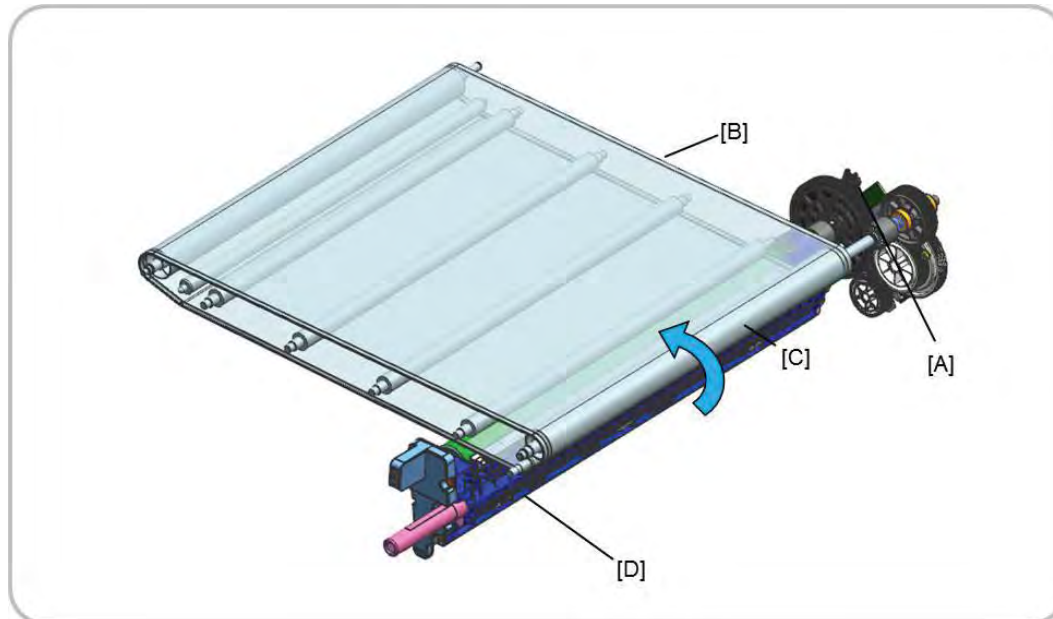
## Transfer belt drive

Learn about the transfer belt drive.

The drive motor (A) drives the ITB (B) by using gears and the ITB drive roller (C).

The ITB (B) and black OPC (D) is synchronized by the drive motor (A).

Figure 1-18 Transfer belt drive



## Cleaning blade

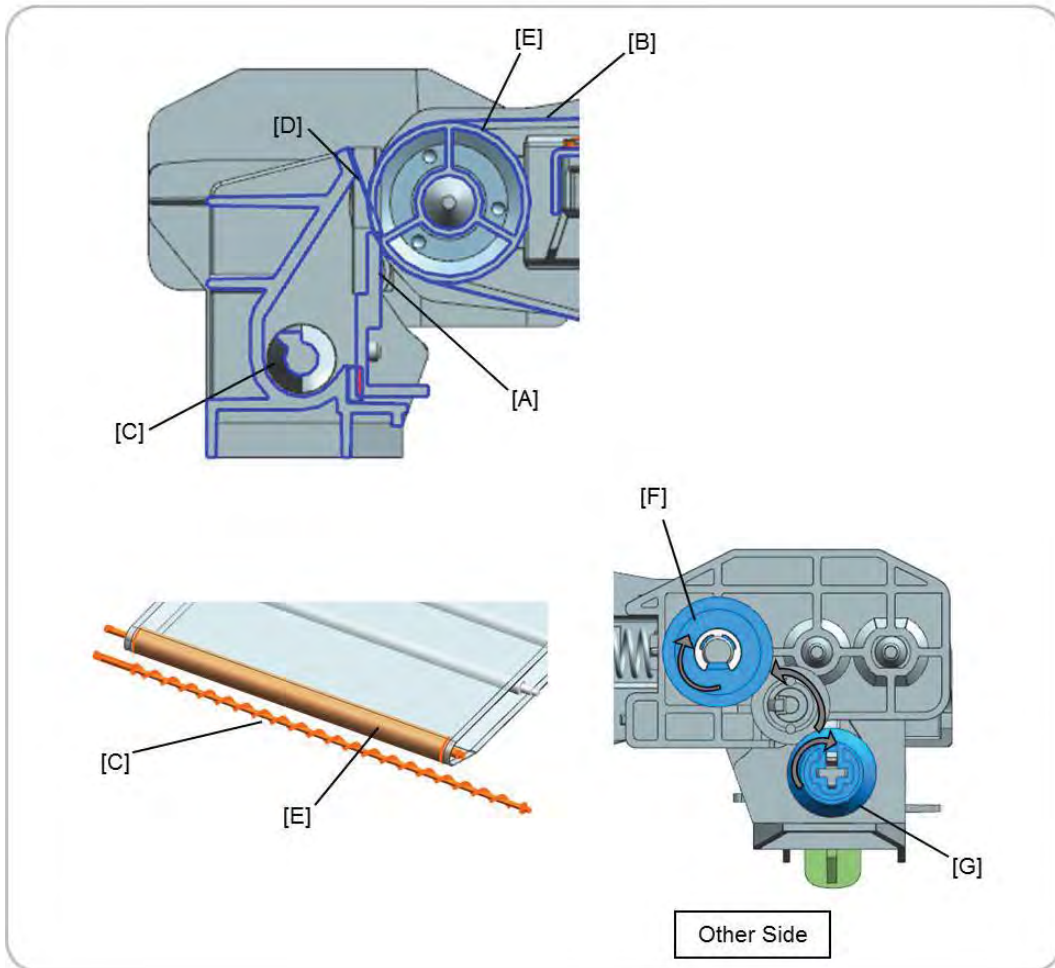
Learn about the transfer belt cleaning blade.

The intermediate transfer belt (ITB) cleaner removes toner during printing. Belt cleaning is completed while the ITB makes one rotation. The ITB drive motor drives the ITB cleaning motor.

The cleaning blade (A) in the ITB cleaner always contacts the ITB (B). The cleaning blade removes the used toner from the ITB. The toner collection auger (C) transfers the waste toner to the toner collection unit.

The seal (D) on the ITB cleaner protects against toner contamination. The driving power by the driver roller is transferred to the tension roller (E). The toner collection auger gear (F) drives the gear (G) and collects the toner

Figure 1-19 Cleaning blade



# Fuser unit

Learn about the fuser unit.

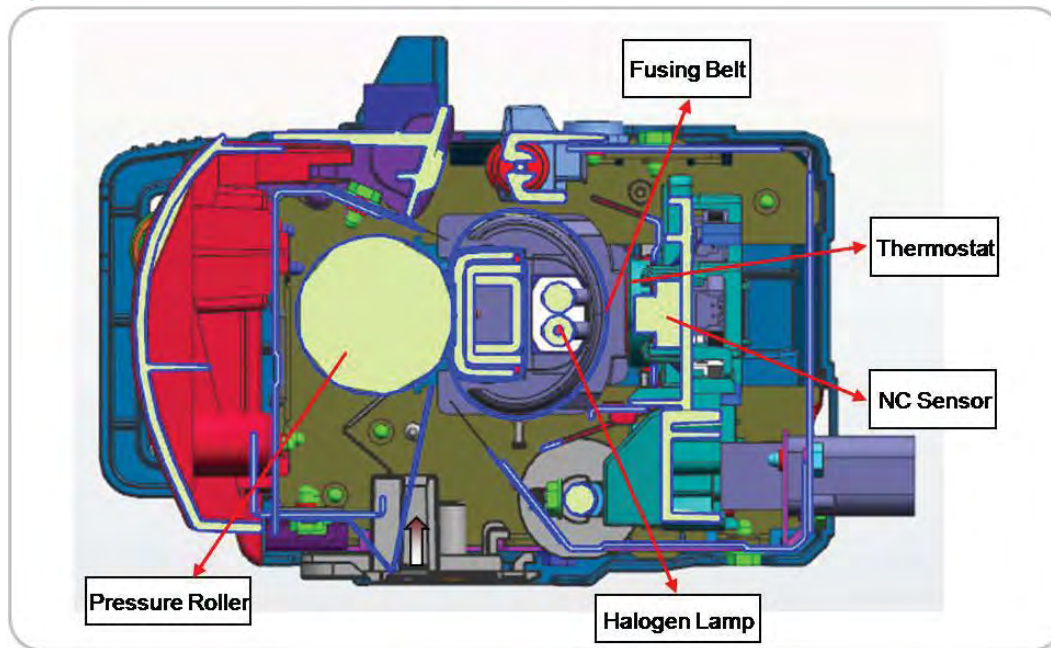
## Fuser unit overview

Learn about the fuser unit.

This section describes the image fusing process used by the printer.

This unit fuses the toner that was transferred by the transfer roller onto the paper by applying heat and pressure. The printer uses an instant fusing belt which has a faster warm-up time than a conventional fusing and pressure roller system.

Figure 1-20 Fuser unit



- **Lamp halogen**

The fuser unit has two halogen lamps. One lamp heats the center of the fusing belt, and the other lamp heats the end of axial direction. The halogen lamps are lit alternately to heat the fusing belt. Each lamp has its coil in a different location. The coil of the center heater lamp is in the center. The coils of the side heater lamp are located on both sides. The lamps are fixed inside of the fusing belt. The lamps do not rotate when the fusing belt rotates.

- **Fusing Belt**

The fusing belt receives heat from the halogen lamp and transfers it to the toner and paper. The fusing belt consists of three thin layers. The thin fusing belt reduces time needed to warm up and change modes. To prevent the fusing belt from adhering to the toner, the surface of the fusing belt is lubricated. There is a nip inside the fusing belt. A spring is used to maintain the proper nip between the fusing belt and pressure roller.

- **Pressure Roller**

The pressure roller is made of rubber, which ensures proper nip width between the pressure roller and the fusing belt. The pressure roller is powered by the drive system and drives the fusing belt.



- **Non-Contact (NC) Sensor**

NC sensors (non-contact type thermistors) are located near the center and the end of the fusing belt and monitor the temperature of the fusing belt.

- **Thermostats**

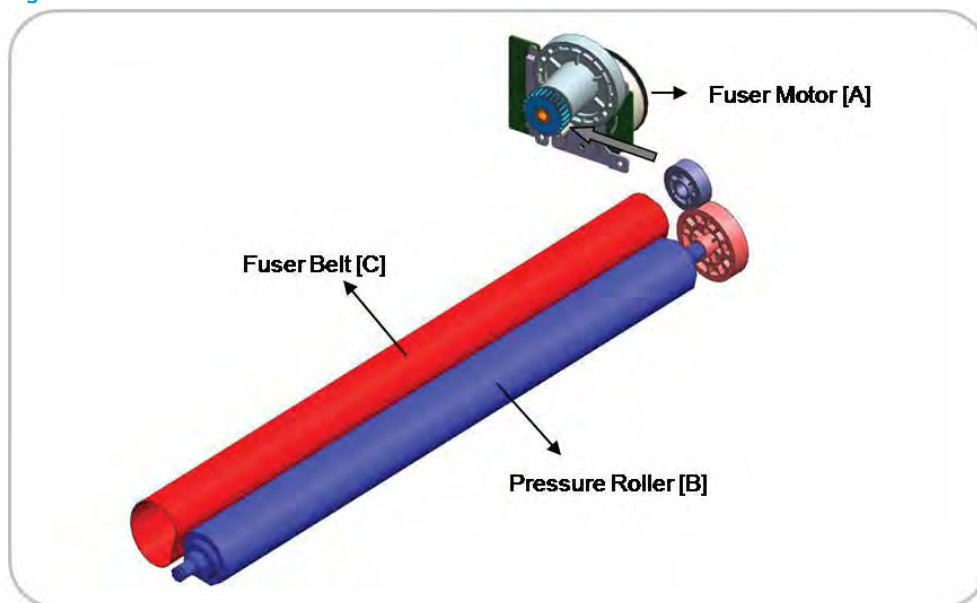
The thermostat cuts off the power supply to the halogen lamp by opening the circuit when the heat roller becomes abnormally hot as a result of problems such as a NC sensor malfunction. The thermostats are used to prevent abnormal operation. When the thermostat is tripped, it cannot be reset and must be replaced (as well as the other damaged parts in the fuser unit).

## Fuser unit drive

Learn about the fuser unit drive.

The fuser motor (A) drives the pressure roller (B) through the gear train. The fuser belt is driven by the pressure roller.

Figure 1-21 Fuser drive

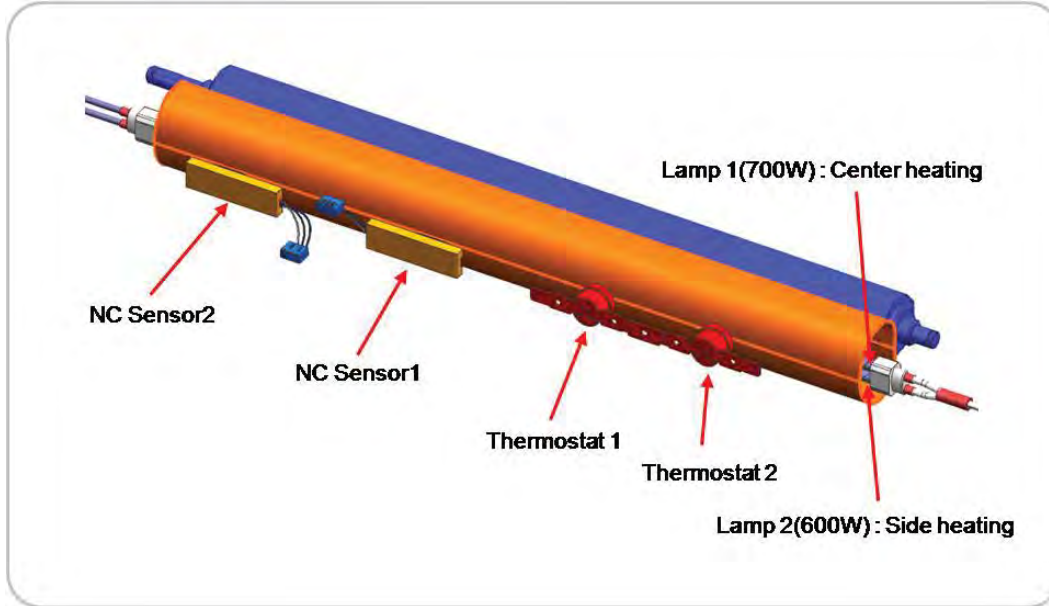


## Fuser unit temperature control

Learn about fuser temperature control.

When the main switch turns on, the CPU turns on the fusing lamp. The lamp stays on until the NC sensors detect the standby temperature. The CPU then raises the temperature up to the printing temperature.

Figure 1-22 Fuser unit temperature control



### Overheat protection

The CPU cuts power to the fusing lamp in the following cases :

- The temperature detected by the NC sensor stays higher than 240°C (464°F) for 20 seconds

The following components are used when thermistor overheat protection fails:

The CPU cuts power to the fusing lamp in the following cases :

The following components are used when thermistor overheat protection fails:

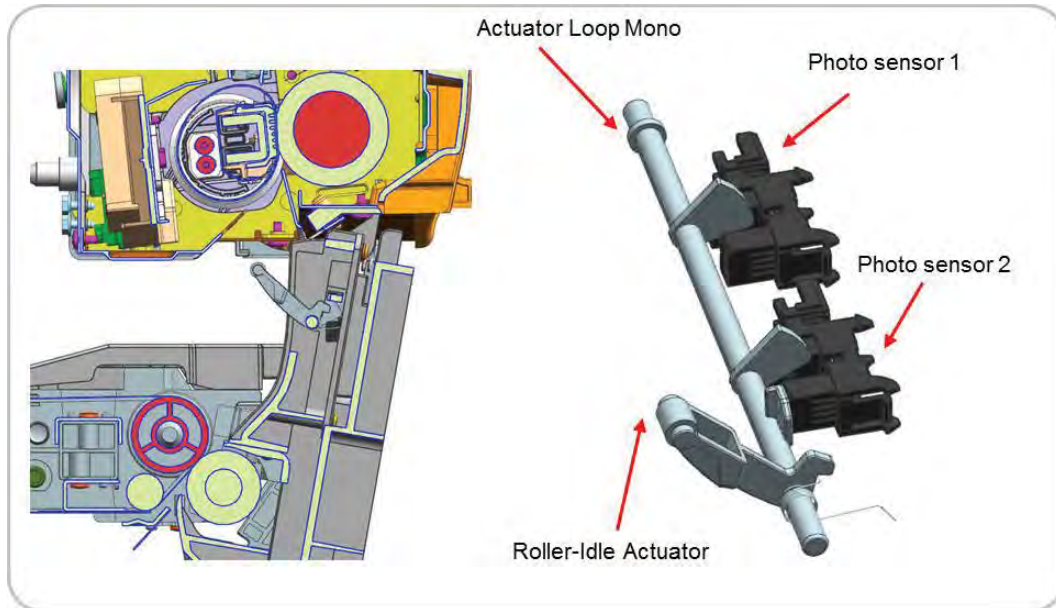
- Two thermostats get into line with the common ground wire of the fusing lamp.
- If one of the thermostat temperatures becomes higher than 195°C (383°F), power is turned off to the fusing lamp. If the other thermostat temperature becomes higher than 195°C (383°F), it also turns the power off to the fusing lamp.

### Loop control

Learn about fuser loop control.

The tension of the paper between the OPC nip and the fuser nip is known as the paper loop level.

Figure 1-23 Loop control



The paper loop level is controlled by monitoring photo sensors 1 and 2. The fuser unit controls the motor speed for the paper loop level.

# Laser scanner unit

Learn about the laser scanner unit.

## Laser scanner assembly overview

Learn about the laser scanner assembly.

The laser scanner assembly consists of one polygon motor and four laser diodes (LD) units. The Laser scanner assembly forms a latent image on the surface of four OPC drums. For this process, the laser scanner assembly has a collimator lens, cylindrical lens, two F-Theta lenses, and two reflective mirrors on an optical path for each color.

This laser scanner assembly uses the cross scan type scanning. K Color and C Color scan the laser from the rear to the front. M Color and Y Color scan the laser from the front to the rear.

The laser scanner assembly has a skew adjustment function which adjusts the scanning line. An automatic shutter is used to clean and protect the glass on the laser scanner assembly.

Figure 1-24 Laser scanner assembly overview

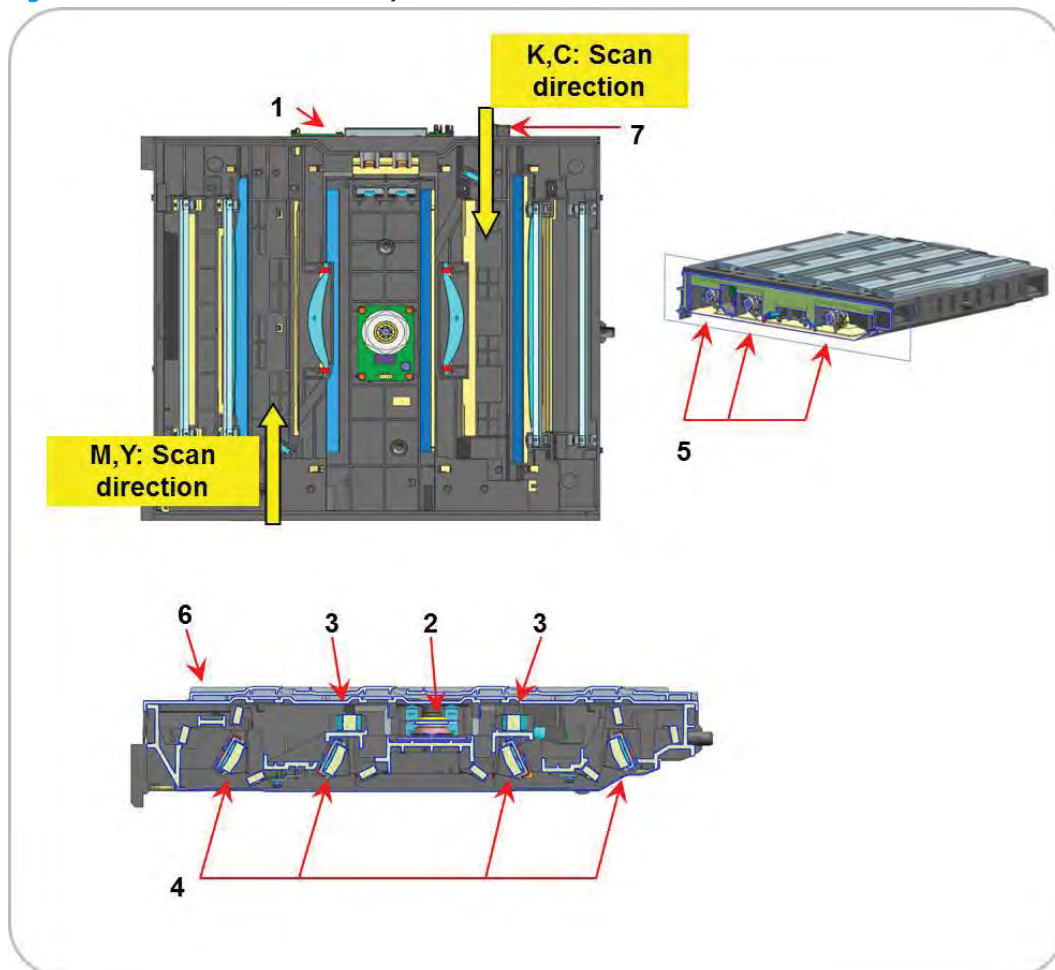


Table 1-18 Laser scanner assembly overview

Item	Description
1	LD PCA

Table 1-18 Laser scanner assembly overview (continued)

Item	Description
2	P/Mirror Motor
3	F1 Lens
4	F2 Lens
5	Skew adjust assembly
6	Shutter
7	PD PCA

## Laser scanning optical path

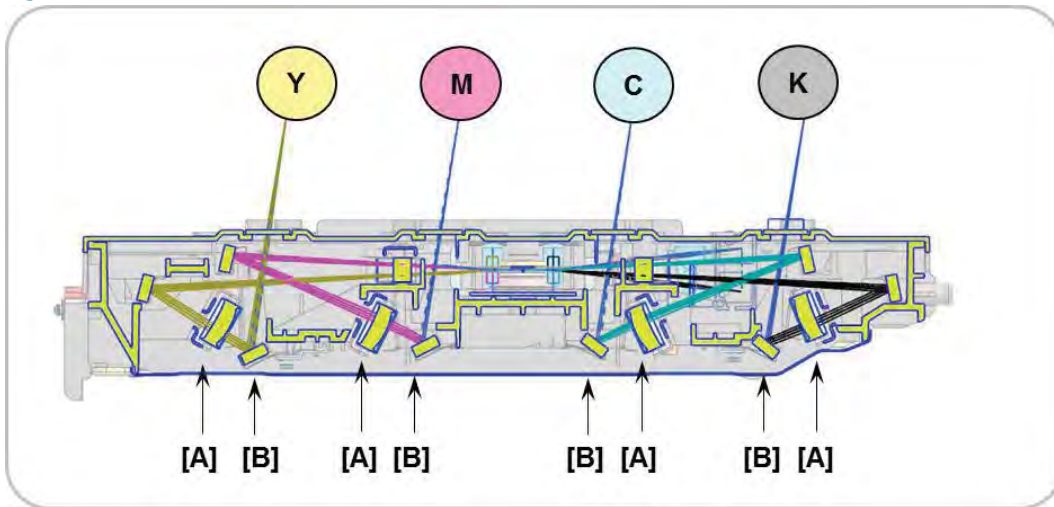
Learn about the laser scanning optical path.

The laser from the laser scanner assembly is placed at intervals of 78 mm for each color. All colors use the same polygon motor for oblique incidence.

The F2 lens (A) determines the slope of the primary scanning line and the image position of the secondary scanning direction. This setting is adjusted by the manufacturer. The primary scanning line slope difference is adjusted by the skew adjustment in the laser scanner assembly.

Reflective mirrors (B) on each color path adjust the curvature of primary scanning. This setting is adjusted by the manufacturer.

Figure 1-25 Laser scanning optical path



Item	Specification	Remark
LD Unit	Laser Diode: Quad Beam Driving IC: Dual LD X 8	LD x 4 (for each color)
P/Motor Speed	<ul style="list-style-type: none"> <li>E77822: 22,087 rpm</li> <li>E77825: 27,520 rpm</li> <li>E77830: 33,071 rpm</li> </ul>	

Item	Specification	Remark
Speed	<ul style="list-style-type: none"> <li>E77822: 187 mm/s</li> <li>E77825: 233 mm/s</li> <li>E77830: 280 mm/s</li> </ul>	
H/W interface	Interface with printer: 50 pin + 60 pin + 8 pin	FFC + FFC + Wire

## Laser synchronizing detectors

Learn about laser synchronizing detectors.

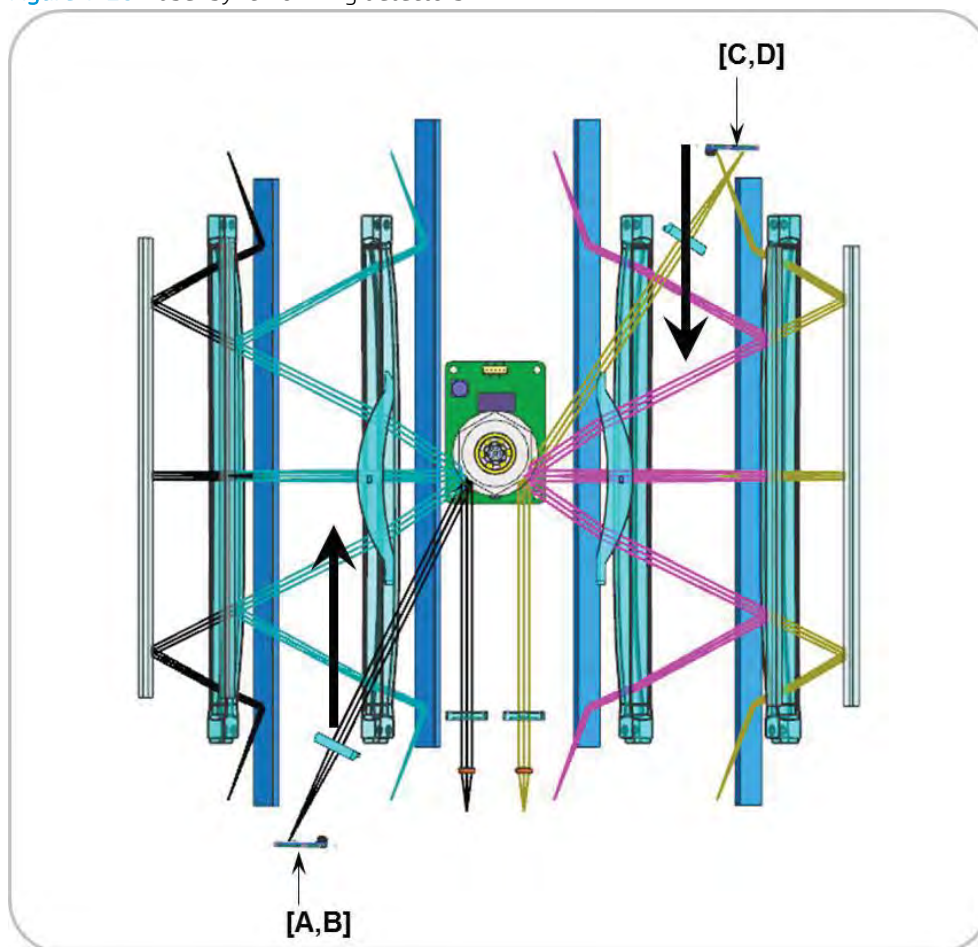
The laser scanner assembly has two beam detector sensor boards (PD PBA includes four sensors). The PD PBAs are located at each corner of the laser optics housing unit.

The beam is detected by the PD PCA at the scanning start point and creates the horizontal sync signal (Hsync).

The two PD PBAs detect the following:

- (A, B): Scanning start position for K, C
- (C, D): Scanning start position for M, Y

**Figure 1-26** Laser synchronizing detectors



## Main scan start detection

The PD PBAs detect four beams at the scanning start point and create the horizontal sync (Hsync) signal. Data is scanned by Hsync.

The arrow in the previous diagram shows the data scanning direction for each color. Black/Cyan and Yellow/Magenta use the same polygon motor scanning in opposite directions.

## Automatic CPR adjustment

Learn about automatic CPR adjustment.

During automatic CPR adjustment, the line patterns below are created eight times on the intermediate transfer belt (ITB). The spaces between the lines (KK, CC, MM, YY, KC, KM, KY) are measured by the front, center, and rear CPR sensors.

The controller takes the average of the spaces and then adjusts the following positions and magnification:

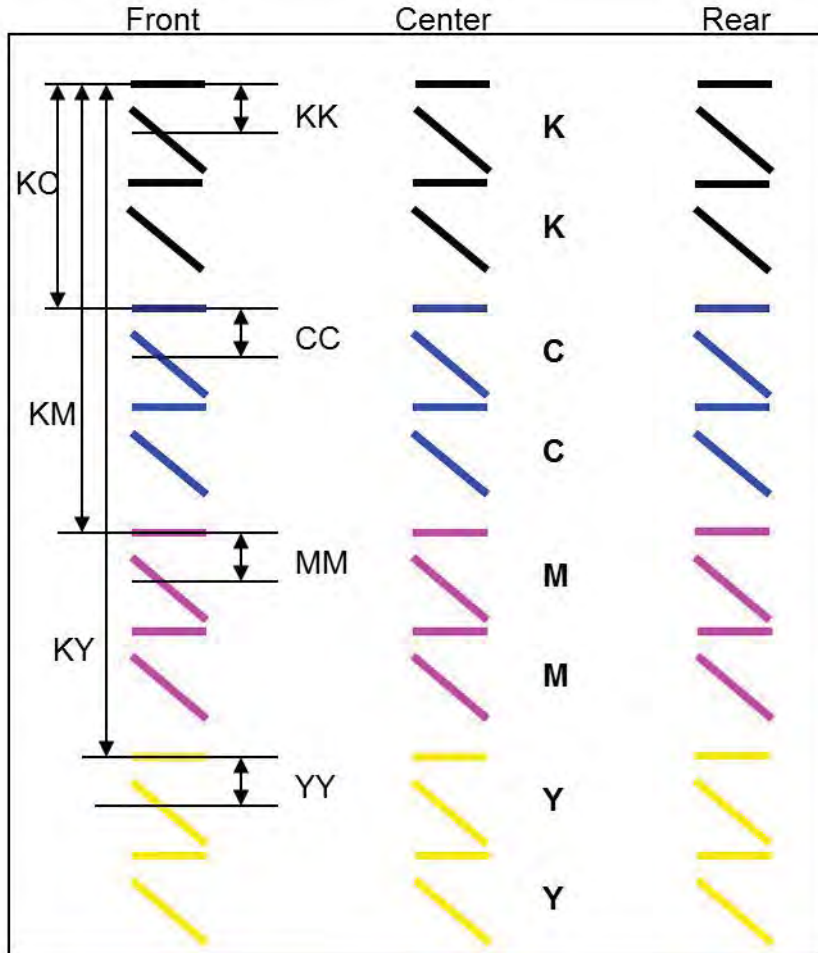
- Sub scan line position for CMY
- Main scan line position for CMY
- Magnification ratio for CMY
- Skew for CMY
- KK, CC, MM, YY: Spaces between two lines of the same color.
- KC, KM, KY: Spaces between a black line and each color line.



**NOTE:** The ITB cleaning unit cleans the ITB after the patterns are measured.

---

Figure 1-27 Automatic CPR adjustment



### Adjustment

- **Sub Scan line position for CMY**

The adjustment of the sub scan line position for CMY is based on the line position for K (black). The printer measures the gaps between the lines of each color in the pattern on the ITB. When the gaps for a color are incorrect, the printer moves the image of the color up or down the sub scan axis. To do this, it changes the laser write timing for that color.

- **Main Scan line position for CMY**

When the printer detects that the image is out of position in the main scan direction, it changes the laser write start timing for each scan line.

- **Magnification Adjustment for CMY**

When the printer detects that magnification adjustment is necessary, it changes the LD clock frequency for the required color.

- **Skew for CMY**

The adjustment of the skew for CMY is based on the line position for K (black).



## Adjustment Conditions

Line position adjustment can be turned on or off. However, it is normally recommended to turn on this function.

Line position adjustment timing depends on several settings. These settings include the following:

- $\Delta T$  = Temperature change of the laser scanner assembly between the temperature of the previous line position adjustment and the current temperature.
- Pages = Total printed pages after previous line position adjustment.

## Interval during print job

Line position adjustment interrupts printing and then starts automatically when one of these conditions occurs when the printer checks at the sheet interval:

- $\Delta T >$  Temperature threshold (laser scanner assembly temperature: default 3°C (37.4°F))
- Pages > Output threshold for all outputs (default: 500 pages)

## Toner collection unit not-installed/installed

- Line position adjustment starts automatically when toner collection unit is removed and reinstalled.

## Drum unit or developer unit replaced

- When the printer detects a new drum unit or developer unit, line position adjustment is automatically performed.

## ITB replaced

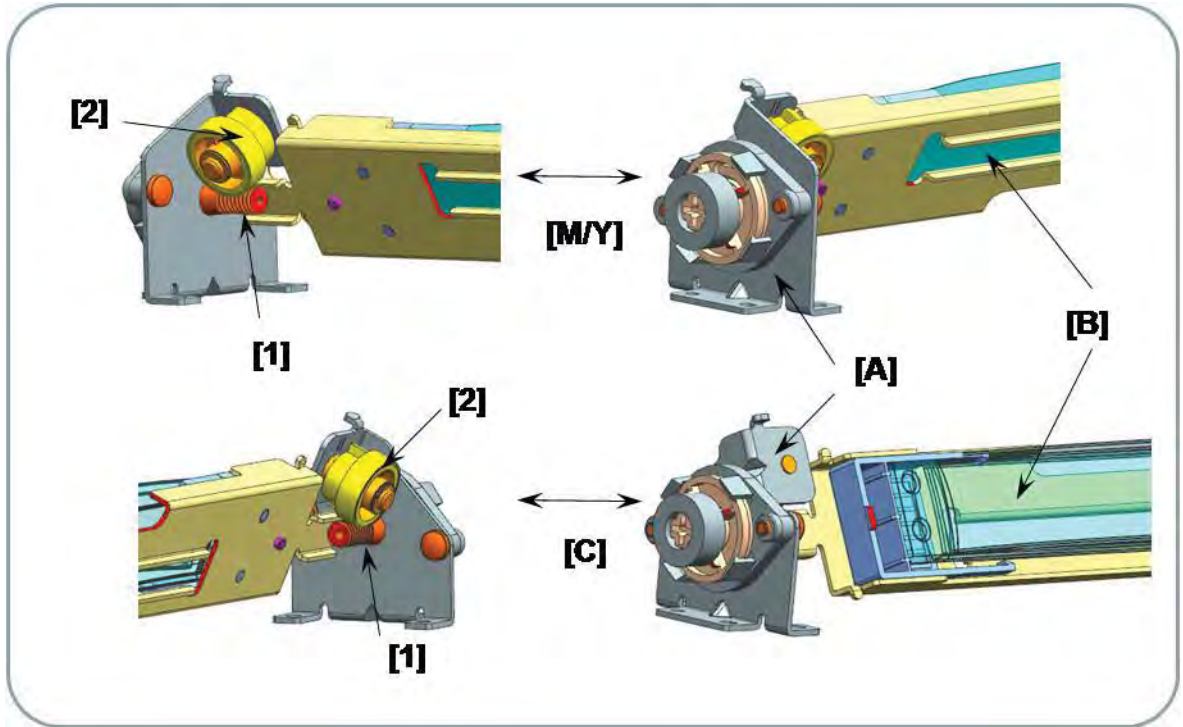
- When the printer detects a new ITB or other ITB, field technicians have to execute the adjustment manually.

## Main scan skew adjustment

The skew adjustment assembly (A) consists of the worm gear (1) for adjustment and worm gear (2). When Color Plane Registration (CPR) executes, it detects and adjusts the scanning line slope manually.

The skew adjustment assembly (A) for magenta, cyan, and yellow adjusts the skew angle of the F2 lens (B). This mechanism corrects main scan skew.

Figure 1-28 Main scan skew adjustment



# Drive system

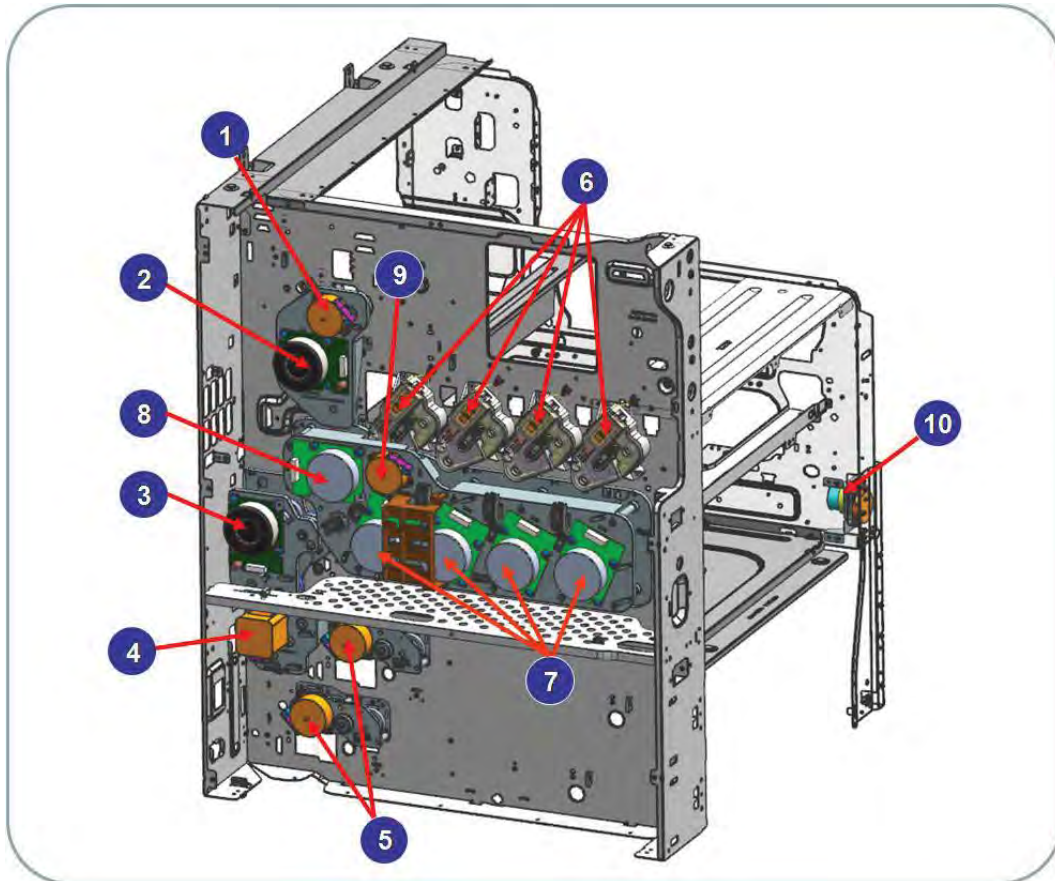
Learn about the drive system.

## Drive motors

Learn about the drive motors.

The following diagram shows the location of the printer drive motors.

Figure 1-29 Drive motors



Number	Motor	Motor type	Qty	Function
1	Exit	PM-STEP	1	Exit drive  (Reverse drive at duplex job)
2	Fuser	BLDC	1	Fuser drive/Fuser pressure mode  (Reverse drive at pressure mode)
3	Registration (Regi)/Tray 1	BLDC	1	Registration (Regi)/Tray 1 drive
3	Registration (Regi)/Tray 1	E-CLT	2	Registration (Regi)/Tray 1 drive control
4	Feed	HB-STEP (Hybrid) Stepper motor	1	Feed 1/2 roll drive

Number	Motor	Motor type	Qty	Function
5	Tray 2 and 3 Pickup	PM-STEP (Permanent Magnet) Stepper Motor	2	Pickup roller/tray lift drive
6	Toner supply	DC	4	Toner transfer in toner cartridge drive duct
7	OPC/DEVE	BLDC	4	OPC/DEVE drive
8	ITB	BLDC	1	ITB drive
9	Transfer roller Dis/En	PM-STEP	1	Transfer roller Dis/Engage
10	Toner collection unit	PM-STEP	1	Toner collection unit leveling

## Main drive unit (OPC/DEVE/ITB/Transfer Roller/Disengage/Engage motors)

Learn about the main drive unit.

The following diagram shows details of the printer main drive unit.

Figure 1-30 Main drive unit—front view

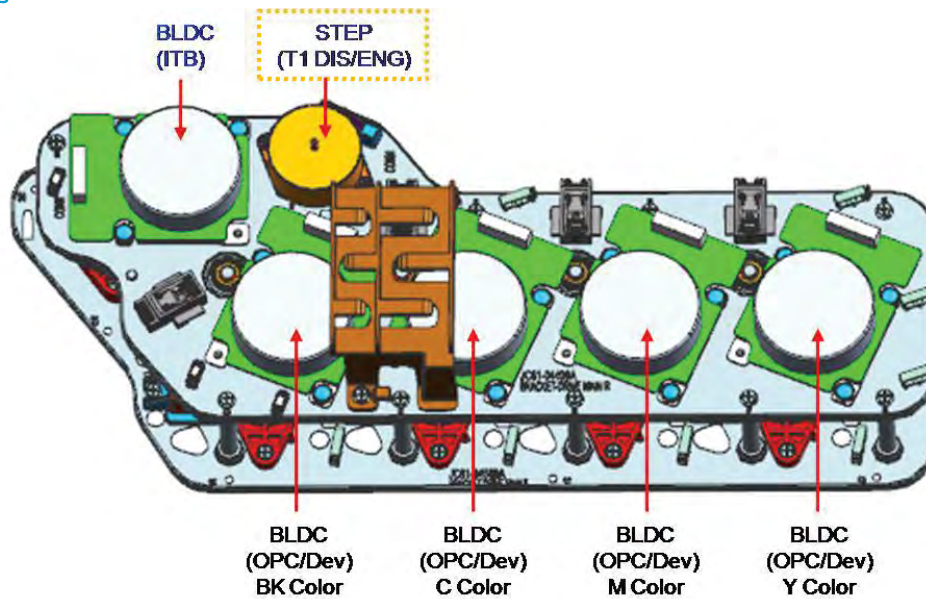
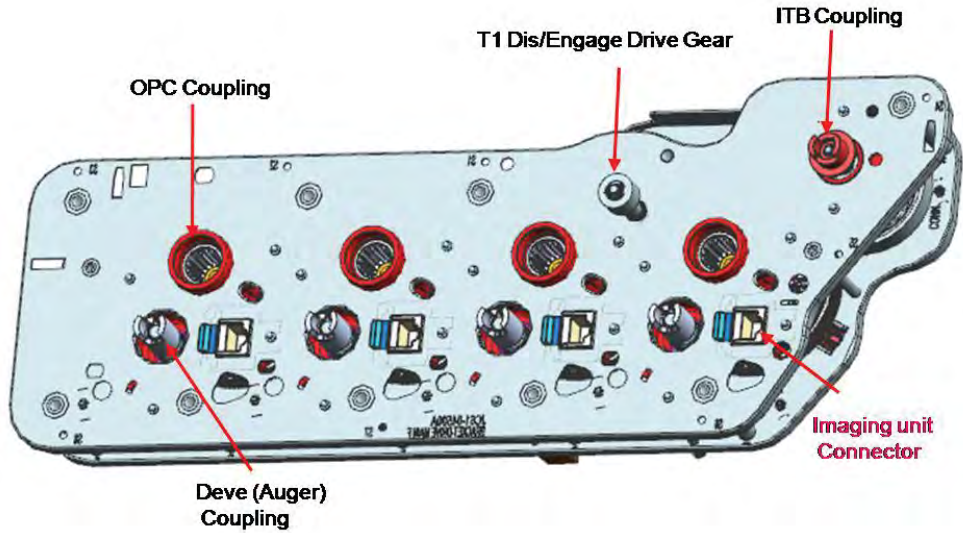


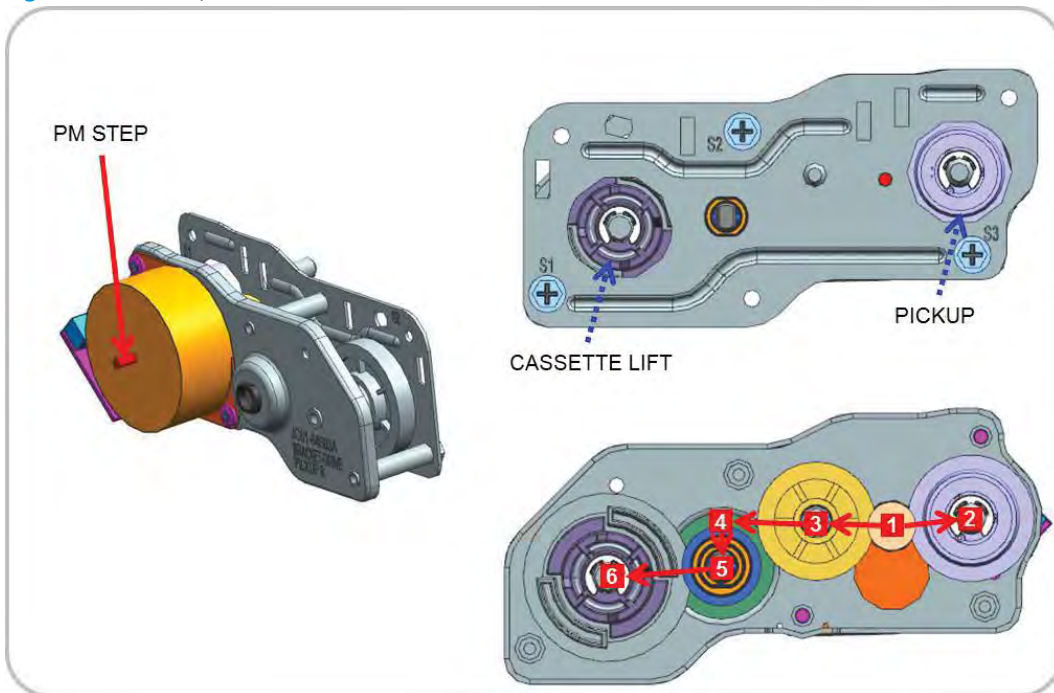
Figure 1-31 Main drive unit—rear view



## Pickup Drive

Learn about the pickup drive.

Figure 1-32 Pickup drive



## Power train

Pickup: rotating (pickup/input)/counter rotating (tray lift input)

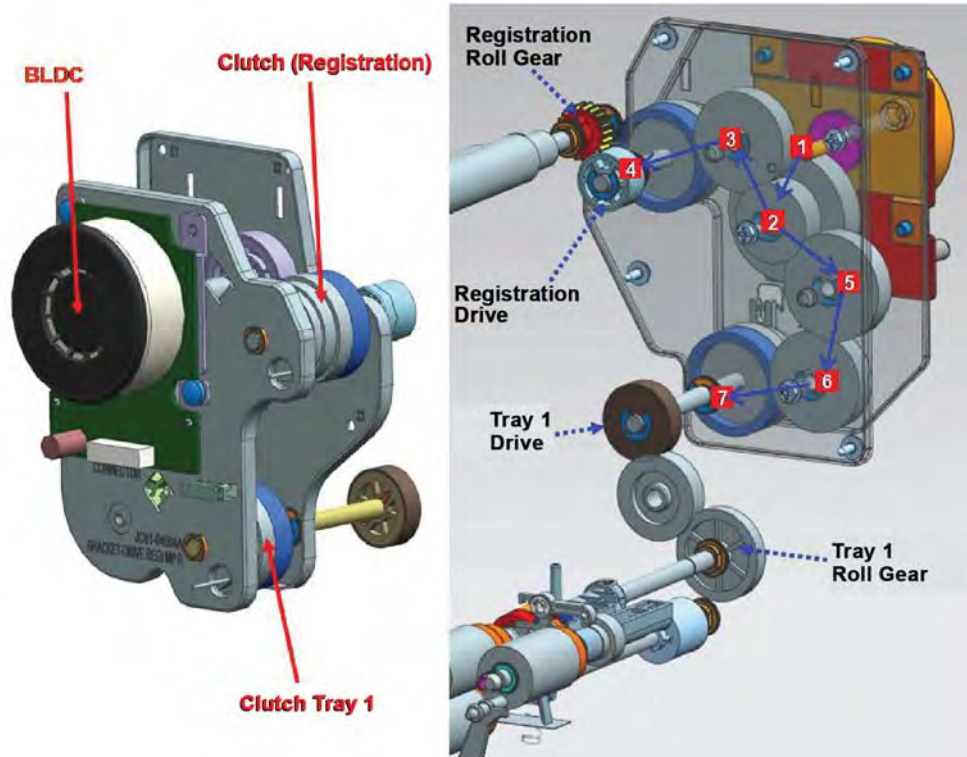
- Step → Forward rotation → Gear 1 → Gear 2 (pickup)
- Step → Reverse rotation → Gear 1 → Gear 3 → Gear 4 → Gear 5 → Gear 6 (tray lift)

## Registration (Regi)/Tray 1 drive

Learn about the registration / Tray 1 drive.

The following diagram shows the drives that power the registration (Regi)/Tray 1 systems.

Figure 1-33 Registration (Regi)/Tray 1 drive



### Power Train

Registration (Regi)/Tray 1: BLDC motor drive, clutch drive control

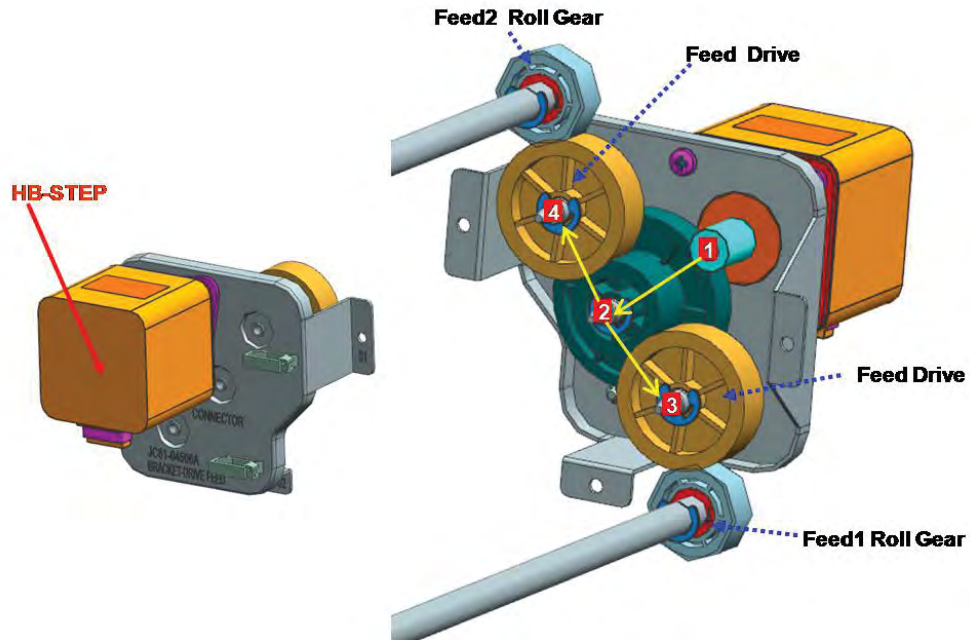
- 1 BLDC motor → 2 gear → 3 gear → 4 clutch/gear (registration (Regi) drive)
- 1 BLDC motor → 2 gear → 5 gear → 6 gear → 7 clutch/gear (Tray 1 drive)

### Feed drive

Learn about the feed drive.

The following diagram shows the feed drive components.

Figure 1-34 Feed drive



### Power Train

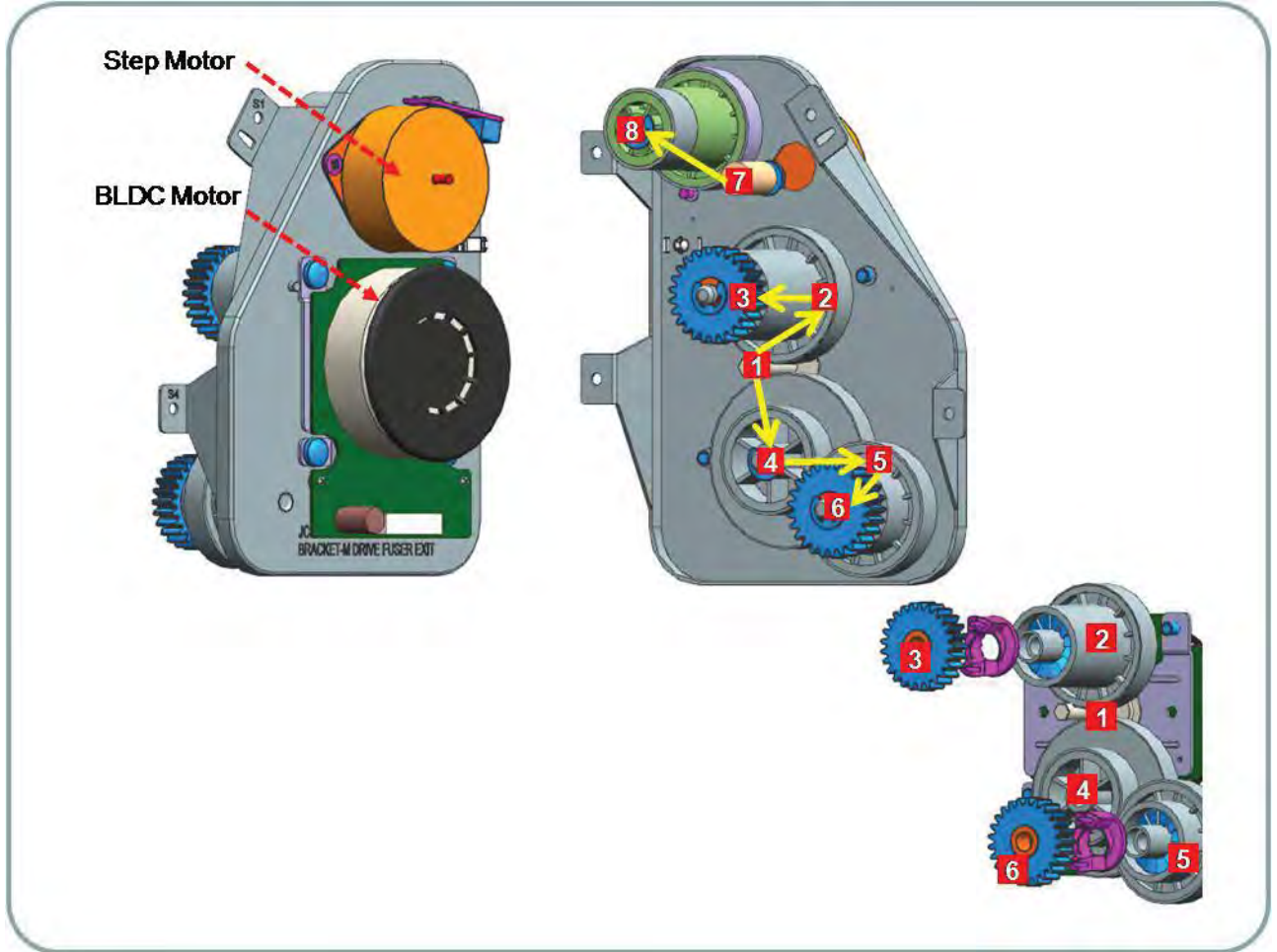
Feed: HB-STEP drive

- 1 HB-STEP motor → 2 gear → 3 gear (feed 1 drive)
- 1 HB-STEP motor → 2 gear → 4 gear (feed 2 drive)

### Fuser/Exit Drive

Learn about the fuser/exit drive.

Figure 1-35 Fuser/exit drive



### Power Train

Fuser and fuser release: One-way gear is used

- 1 BLDC Motor → counterclockwise rotation (CCW) → 2 clockwise rotations (CW) → 3 (CW) (Fuser drive)
- 1 BLDC Motor → 1 clockwise rotation (CW) → 4 (CCW) → 5 (CW) → 6 (CW) (Fuser release drive)
- 7 Step Motor → 8 RDCN Exit (Exit drive)

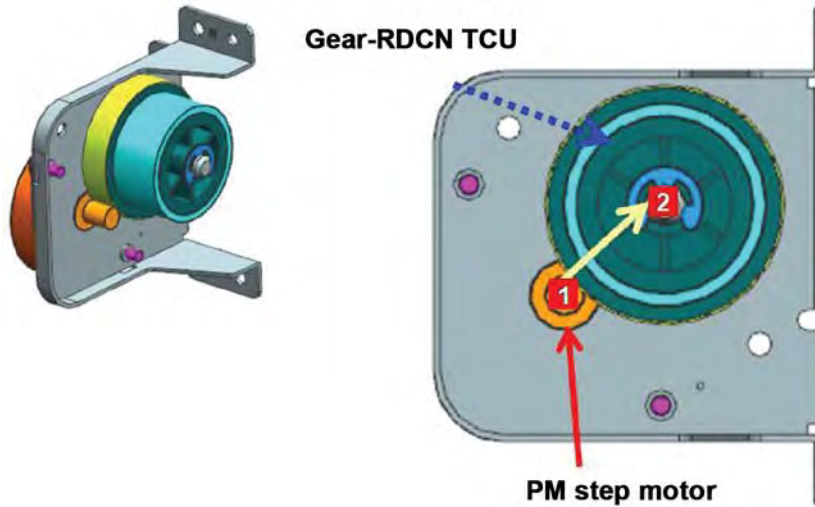
### Toner collection unit drive

Learn about the toner collection unit drive.

The following diagram shows the toner collection unit (TCU) drive components.



Figure 1-36 TCU drive



### Power Train

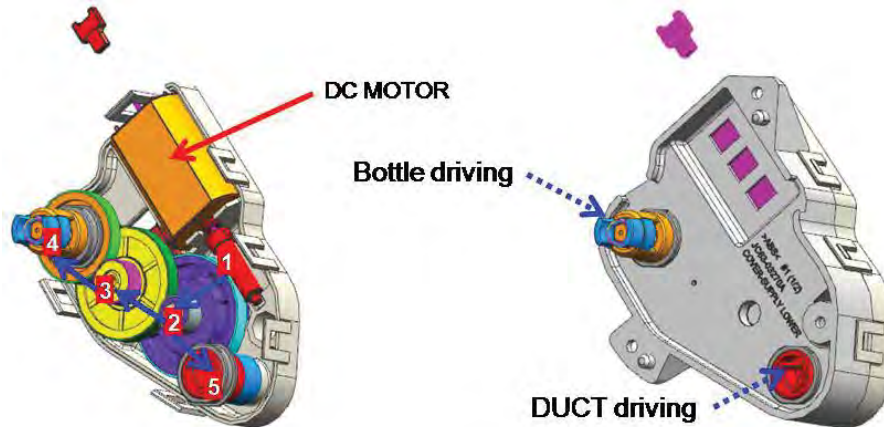
Step motor and Gear-DCN TCU: Toner collection unit drive

- 1 PM step motor → 2 gear- TCU (toner collection unit drive)

### Toner supply drive

Learn about the toner supply drive.

Figure 1-37 Toner supply drive



### Power Train

DUCT and cartridge drive

- 1 DC motor → 2 gear supply → 5 gear DUCT (DUCT drive)
- 1 DC motor → 2 gear supply → 3 gear supply idle → 4 gear supply (cartridge drive)

# Flatbed Scanner System

Learn about the flatbed scanner system.

## Flatbed scanner system overview

Learn about the flatbed scanner system.

The scanner converts a hard copy original into data. To scan an original, the scanner uses the lens and Charge Coupled Device (CCD). The scanner stores and transfers the converted image to the storage space or transfers the scanned data to the printer engine for copy.

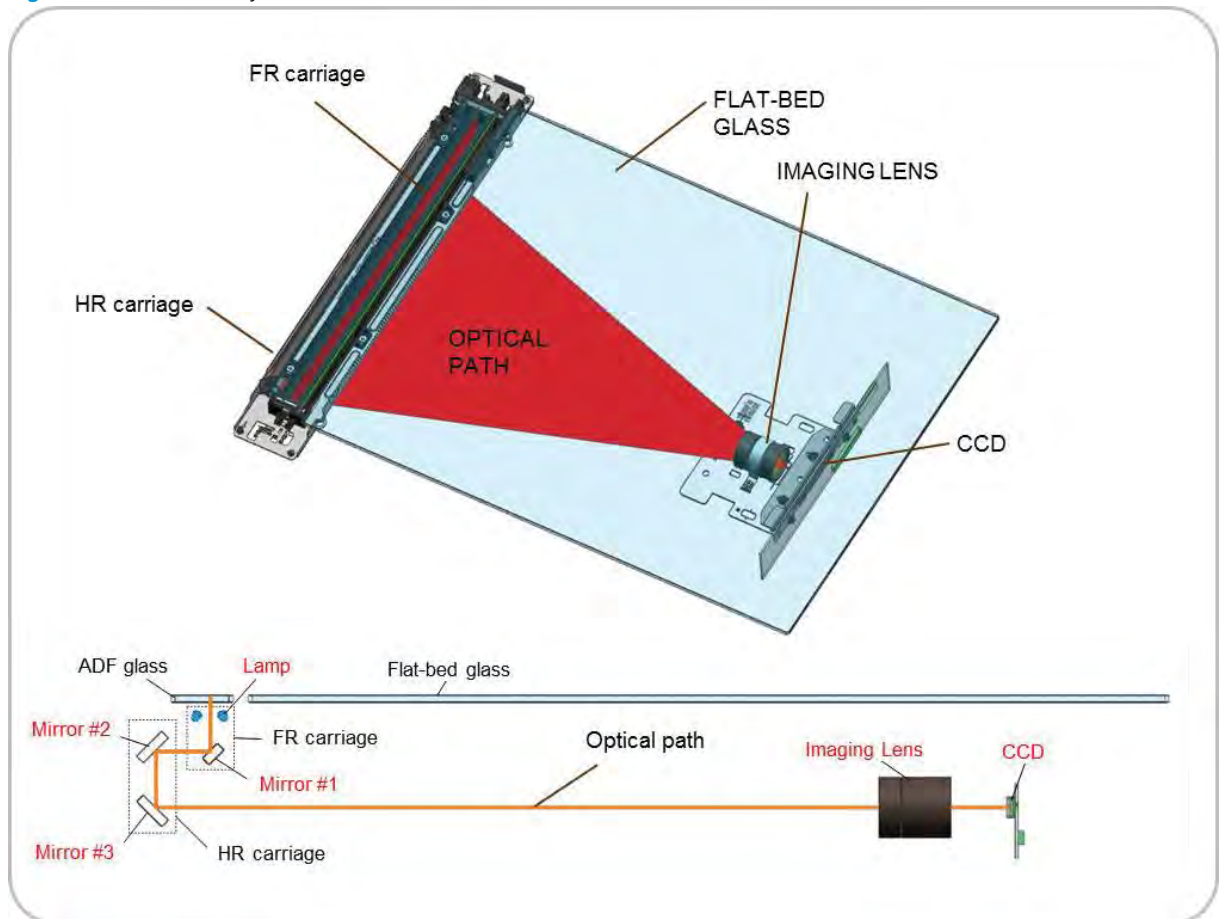
For scan operation, the scanner uses a full rate (FR) carriage and a half rate (HR) carriage that is moved by a wire. It scans the original document on the scanner glass or from the ADF.

The scanner system consists of the three following modules:

- **Full Rate (FR) carriage:** Illuminates the original and reflects the light at a 90 degree angle.
- **Half Rate (HR) carriage:** Transfers the reflected light from the FR carriage to the lens.
- **Imaging lens:** Makes an image on the CCD.

The HR carriage moves half the distance at half the speed of the FR carriage. This keeps a regular gap between the original and the imaging lens.

Figure 1-38 Scanner system overview



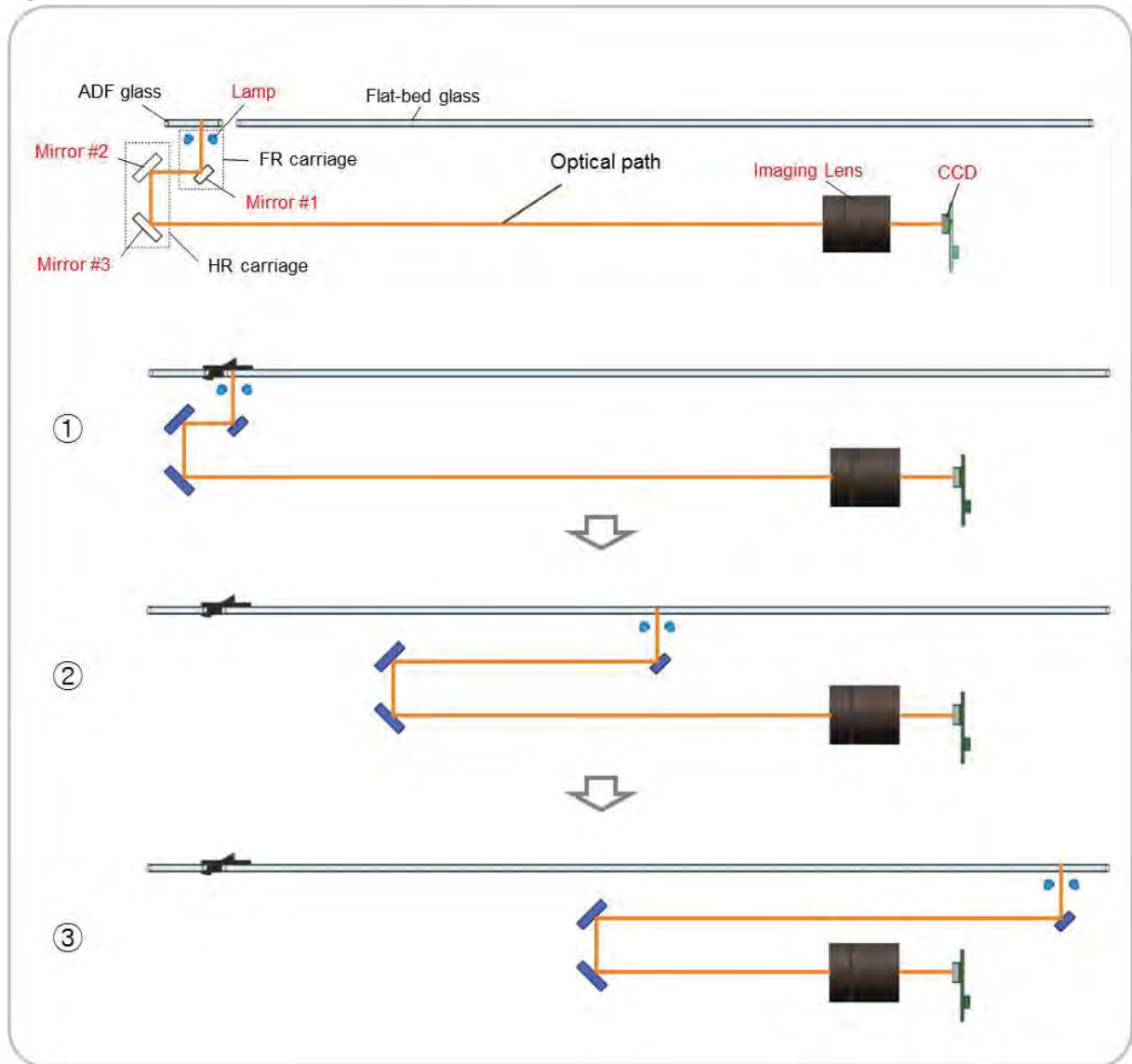
## Scan process description

Learn about the scan process description.

1. The FR carriage lamp illuminates the original. The reflected light is moved to Mirror #1.
2. The reflected light from Mirror #1 is sent to the imaging lens through Mirror #2 and #3.
3. The light becomes smaller and makes an optical image.
4. The optical image is generated to the electrical signal by the CCD sensor.

To make a stable image, a gap must be maintained between the original and the lens. To maintain this gap, the HR carriage moves half the distance and half the speed of the FR carriage.

Figure 1-39 Scan process



The optical image made by the CCD sensor is changed to an electrical-analog signal.

Each color element signal in the optical image is separated by the CCD sensor into red, green, and blue.

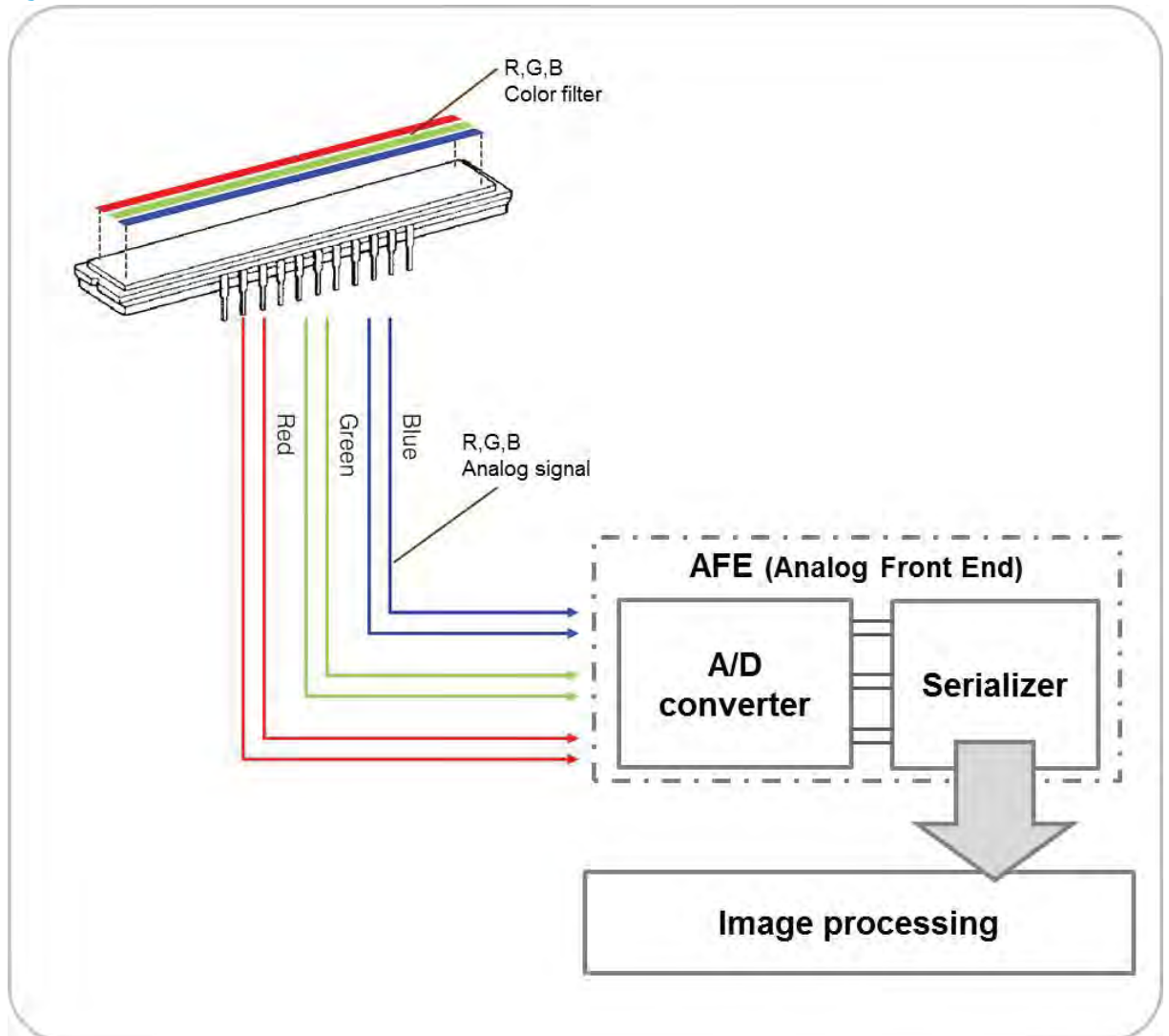
The red CCD sensor extracts the red color from the optical image, the green CCD sensor extracts the green color from the optical image, and the blue CCD sensor extracts the blue color from the optical image.

The analog image signal is changed to a digital image signal by the A/D converter and is transferred to the processor.

The image scan of the main scanning direction is performed by the CCD sensor. The CCD sensor consists of approximately 7500 pixels. The image scan of the sub scanning direction is performed by the FR carriage and HR carriage. The carriage is moved by a wire driven by the scan motor.

Scan resolution is 600 dpi.

Figure 1-40 Image processing



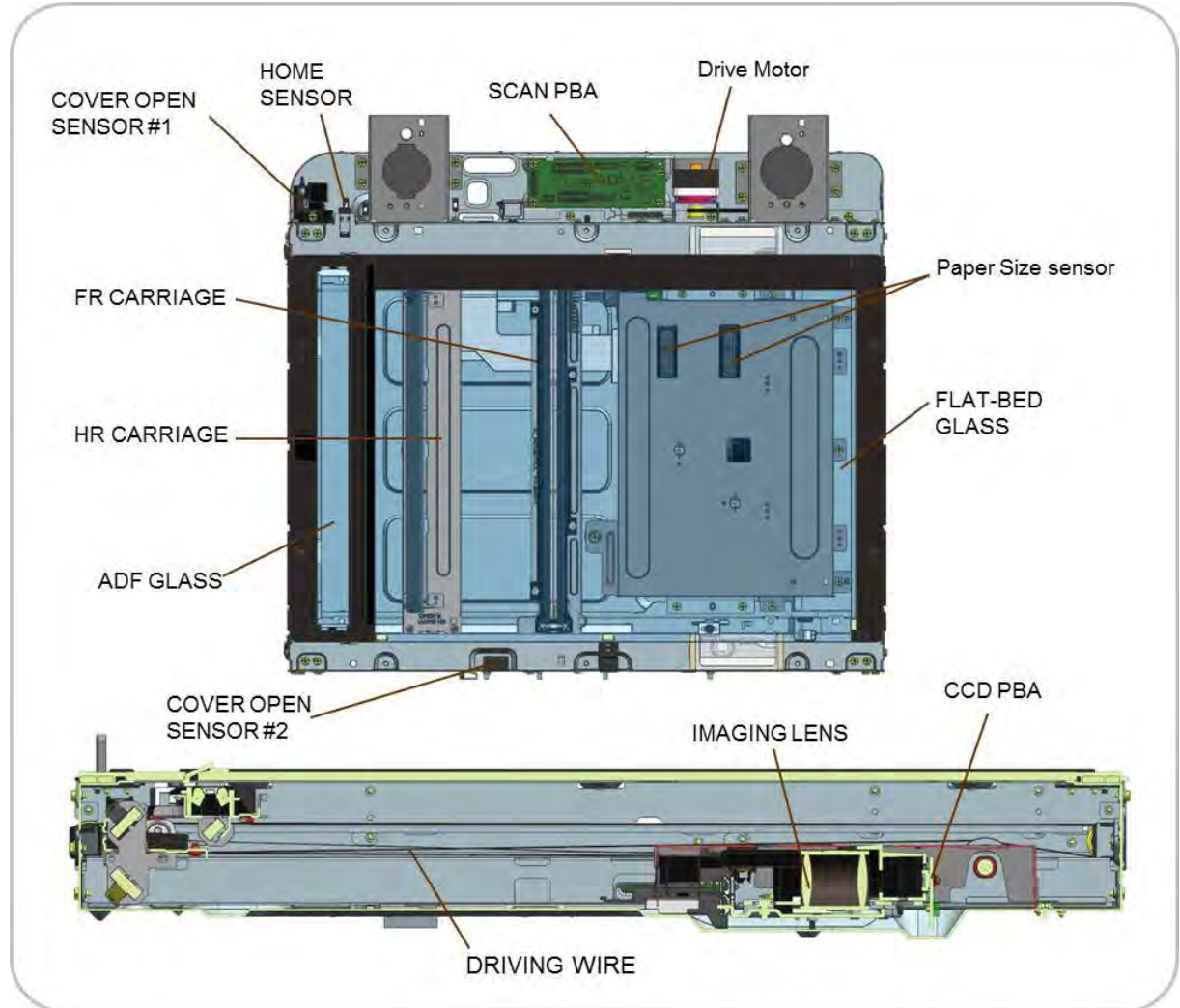
## Scanning system components

The following shows the construction and purpose of the scanning system.

To scan the original on the scanner glass, two carriages driven by the motor move at a regular speed. The motor drives the timing belt, pulley, and wire. The wire pulley rolls and releases the wire to move the carriage.

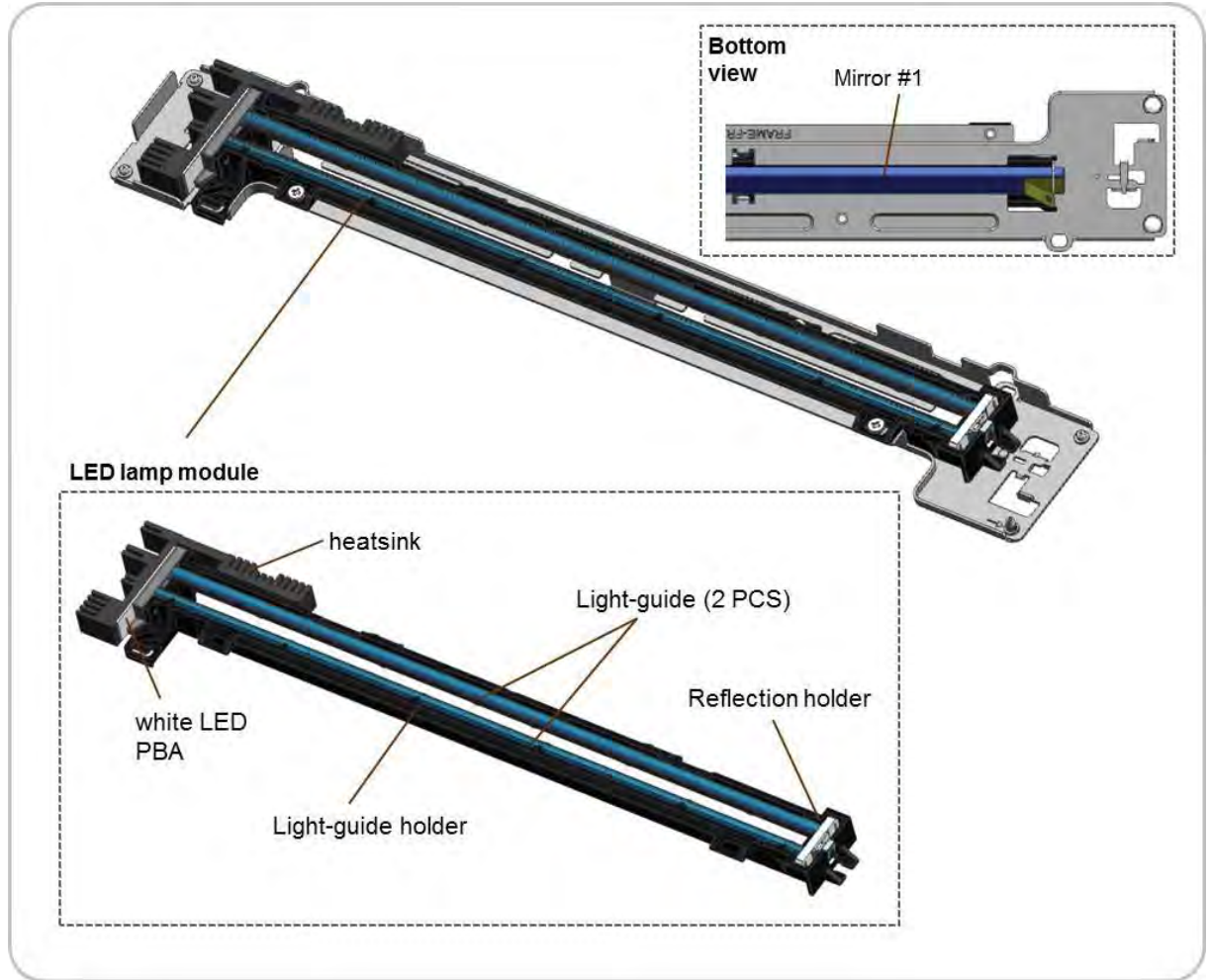
The scanner consists of the scanner glass, FR carriage, HR carriage, imaging unit, and driving unit.

Figure 1-41 Scanning system components



- FR Carriage

Figure 1-42 FR carriage



– LED lamp module

This module illuminates the original. Two white LEDs are assembled on the side of the module. The original is illuminated by the light-guide. The heat sink is attached to the LED PCB. When the heat sink is broken or expired, an engineer needs to replace it.

○ Light-guide

The light-guide changes the light from point type to line type. The light-guide is made by transparent resin and controls the amount of light in the scan area uniformly.

○ White LED

The white LED emits white light. The heat sink attached to the PCA prevents heat deterioration.

○ Reflection holder

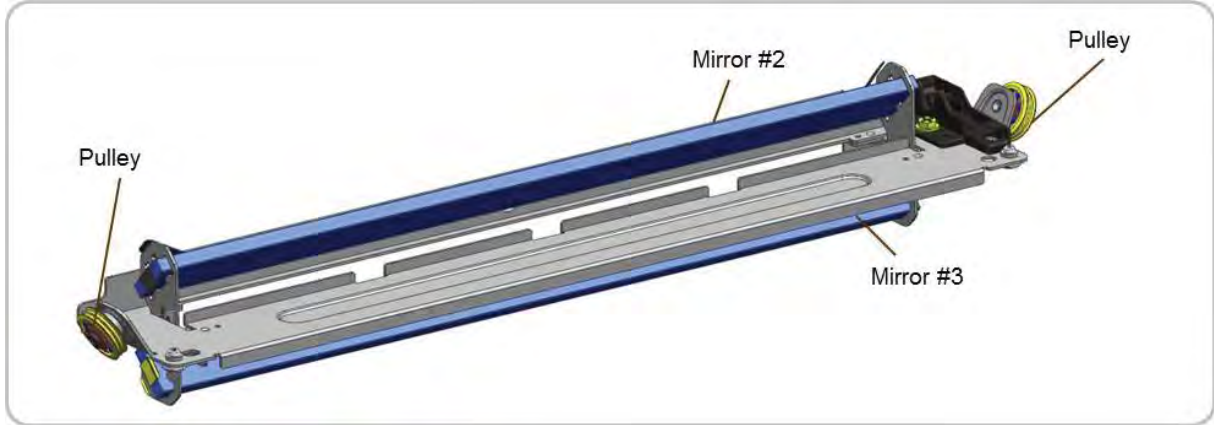
The reflection holder reflects the light that has passed through the light-guide.

– Mirror #1

Mirror #1 reflects light at a 90 degree angle.

**HR Carriage (mirror unit)**

Figure 1-43 HR carriage



- Mirror #2 and #3

Mirrors #2 and #3 are positioned at a 45 degree angle in order to change the direction of the light. The reflected light from mirror #1 is sent to the imaging lens through mirrors #2 and #3.

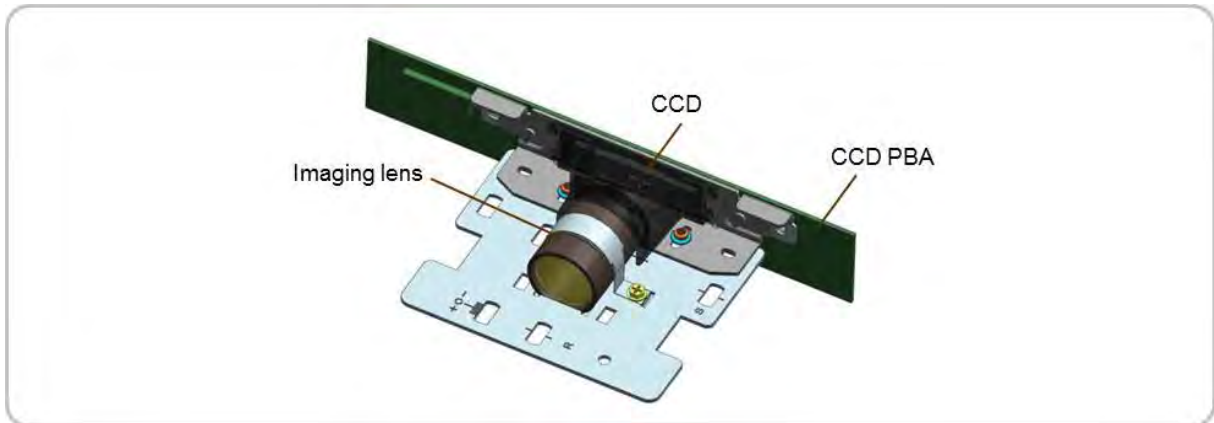
- Pulley

The pulley is a ball bearing type. The pulley rolls and releases the wire which makes the HR carriage move. The HR carriage moves half the distance at half the speed of the FR carriage.

### Imaging unit

The imaging unit changes the optical image to an electrical signal.

Figure 1-44 Imaging unit



- Imaging lens

The reflected light from the imaging lens is focused on the CCD. The image is reduced to the fixed CCD sensor and pixel size.

- CCD PCA

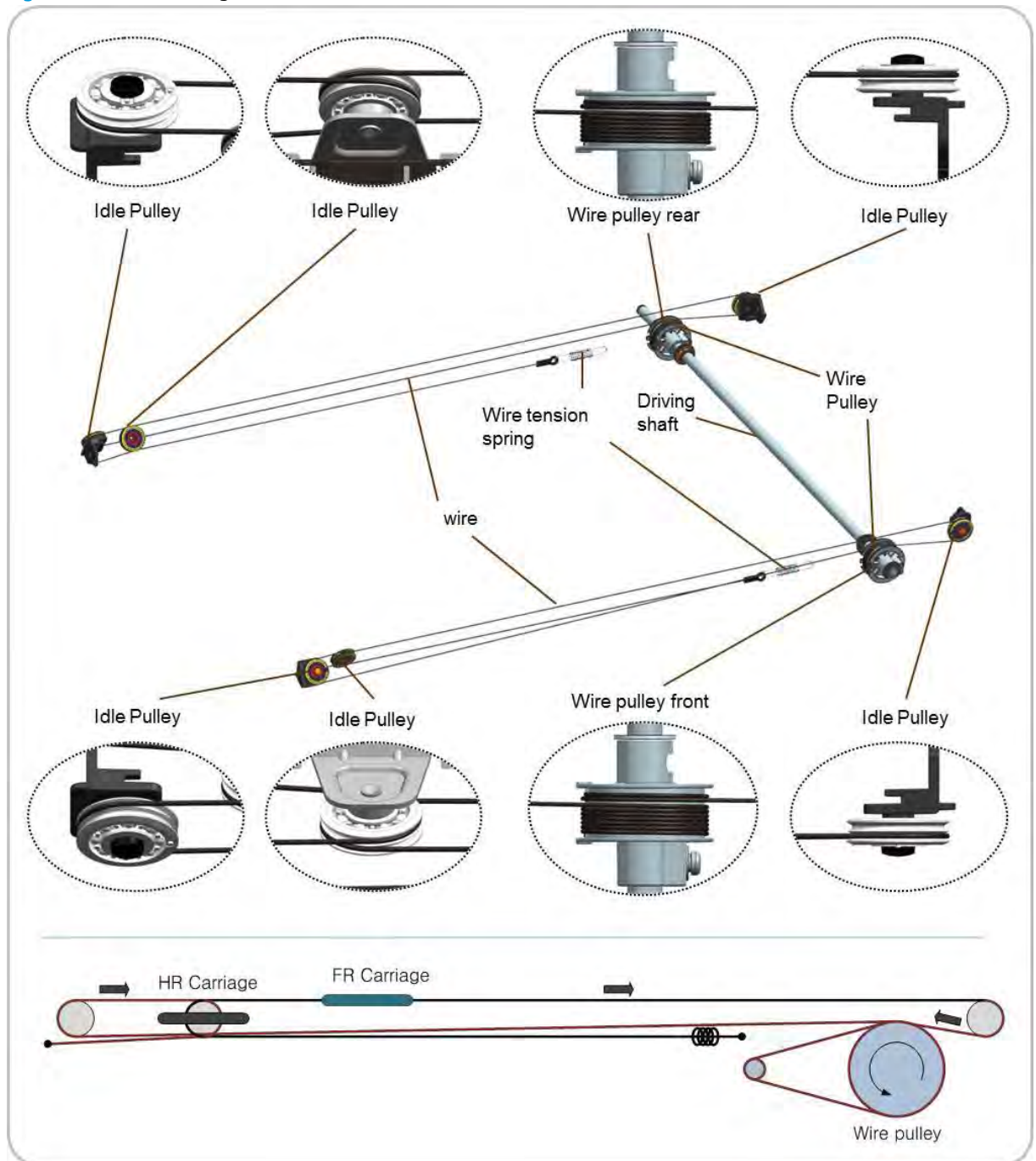
The image made by the imaging lens is changed to an electrical signal by the CCD. The CCD consists of three channel line sensors for image creation. The brightness and darkness of the image depends on the voltage level from the CCD. The output voltage is changed to a digital signal. The digital signal makes the scanned image.

### Wire driving



To move the carriages, the wire is assembled in the front and rear of the scanner. The pulley rolls and releases the wire which moves the FR carriage and the HR carriage.

Figure 1-45 Wire driving



### Scanner glass (flatbed glass)

The original is placed on the scanner glass for scan or copy jobs. The scanner glass is made of tempered glass and is held in place by the frame to prevent distortion.

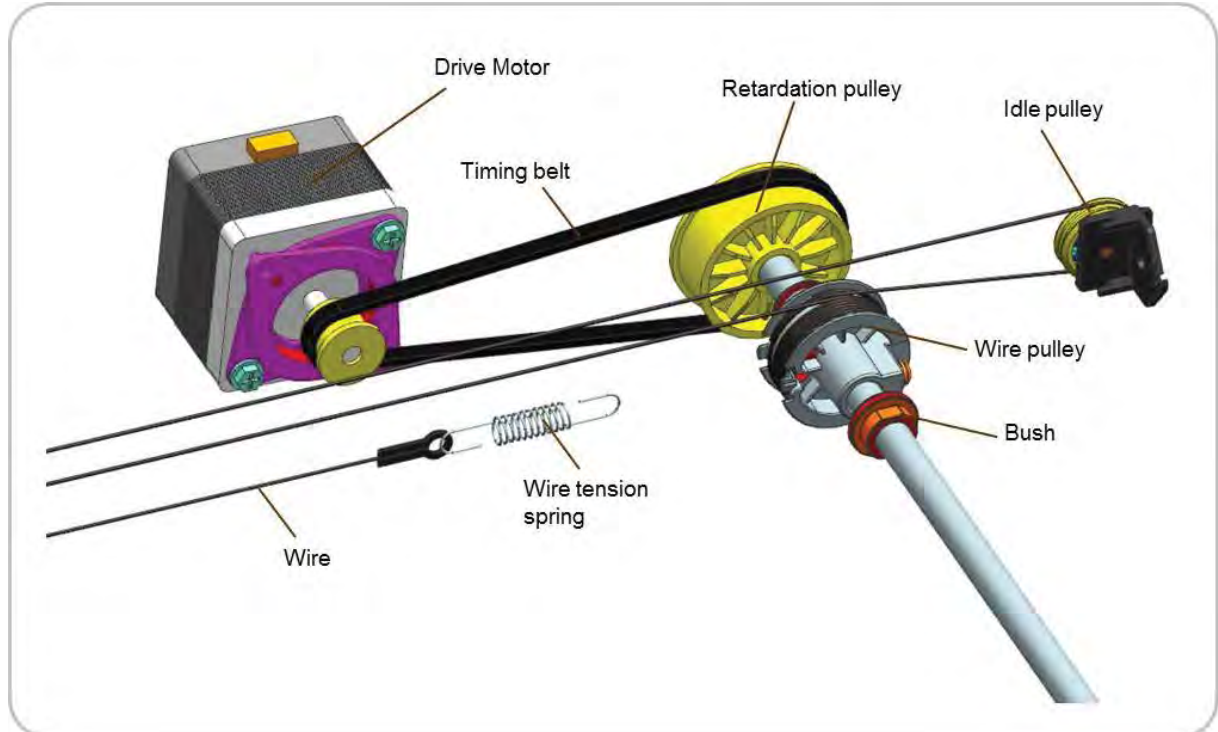
### Drive motor

The scanner drive system uses the step motor to move the carriage. The step motor controls the position and maintains constant speed. The motor power is transferred to the wire through the timing belt and pulley.

### Timing belt

The timing belt has a regular saw tooth gear and transfers the motor power to the pulley.

Figure 1-46 Timing belt



### Paper size sensor

The paper size sensor automatically detects the size of the original on the scanner glass. The paper size sensor uses two sensors. An infrared LED is used to detect the dark original.

### Home sensor

The home sensor detects the FR carriage position. The home sensor is a transmission photo sensor.

### Cover open sensor #1

When the ADF unit opens and closes, a function is triggered which detects whether the paper size sensor is on or off.

### Cover open sensor #2

The cover open sensor #2 detects when the ADF unit is closed using magnetic force.

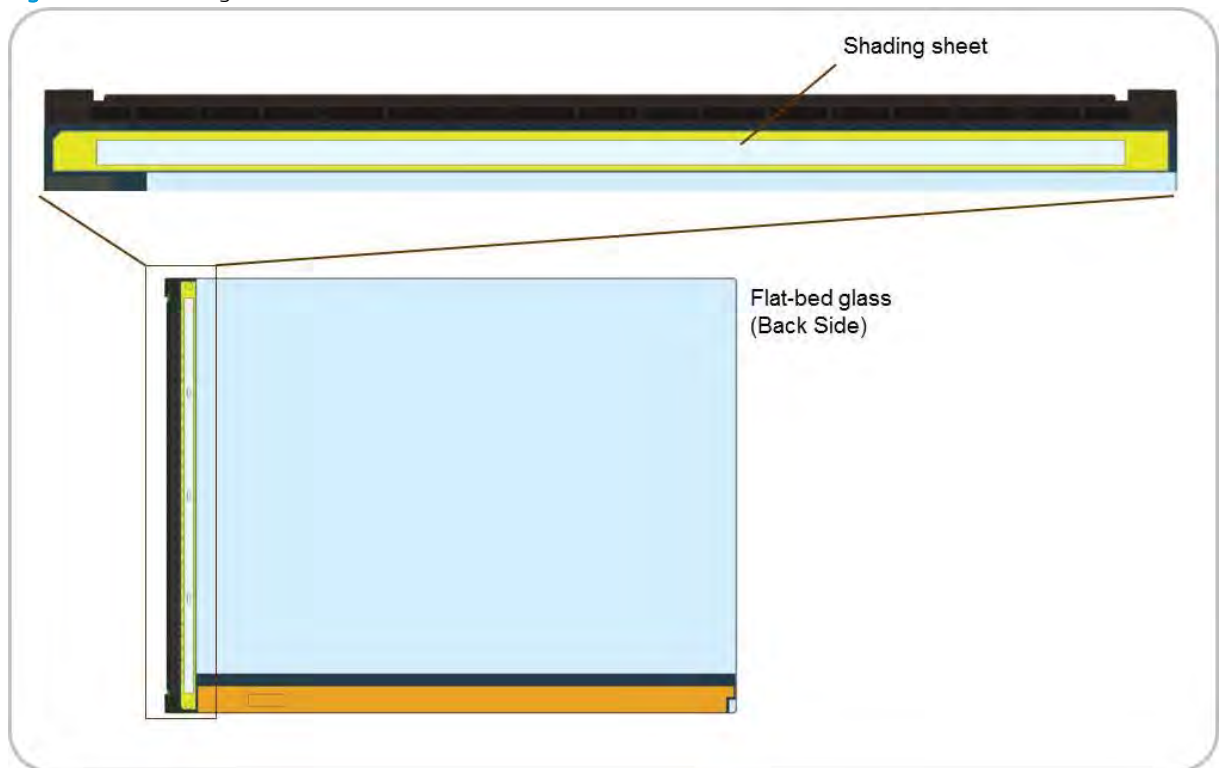
### ADF glass

Scanner read the original feed from ADF unit through ADF glass. The FR carriage read the original as it passes on ADF glass. If ADF glass is contaminated.

### Shading sheet

The shading sheet is attached under flat-bed glass. Before every scan job, scanner read the shading sheet to get reference image with same optical conditions. If shading sheet is contaminated, a vertical line might occur on scan image.

Figure 1-47 Shading sheet



## Caution for moving the scanner

Learn about cautions when moving the scanner.

When shipping or moving the printer, the FR and HR carriages in the scanner must be secured with a scan locking screw to prevent movement of these parts and possible damage to the scanner

This screw must be installed before moving the printer and then removed once the printer is positioned in place.

### When installing

After unpacking, before turning on the printer, the scan locking screw must be removed. If the locking screw is not removed scanner failure will occur.

1. When installing the printer, remove the scan locking screw.
2. After removing the screw, assemble the screw cap from the accessory package.

Figure 1-48 Remove scan locking screw



**When moving the printer**

When moving the printer, tighten the scan locking screw to prevent damage to the carriages.

1. Make sure the FR carriage is located in the end of scanner side wall which is screw locked.
2. Remove the screw cap.
3. Tighten the M3x8 screw to secure the FR carriage.

Figure 1-49 Tighten scan locking screw



# Document feeder LX (dn models)

Learn about the document feeder LX (dn models).

## Document feeder LX overview

Learn about the document feeder LX.

Figure 1-50 Document feeder LX overview

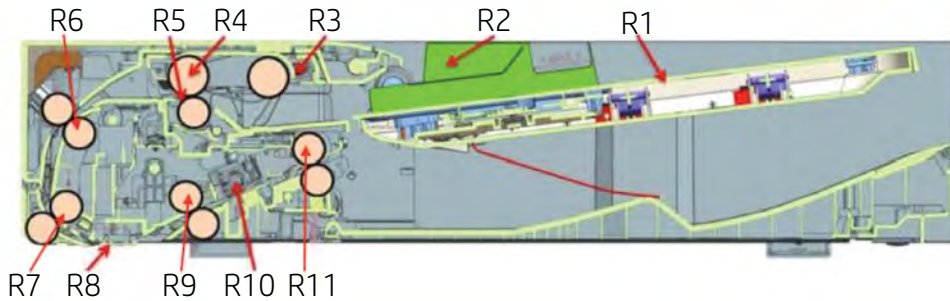


Table 1-19 Document feeder LX overview

Part	Description	Function
R1	STACKER ASSY	Original paper input tray
R2	GUIDE-DOC F&R	Original paper guide (front/rear)
R3	PICK ROLLER	Pick up original paper from the input tray
R4	ADF ROLLER	Original paper feed roller
R5	SEPARATION ROLLER	Original paper separation roller
R6	REGISTRATION (REGI) ROLLER	Original paper alignment roller
R7	SCAN IN ROLLER	Feeds an original paper before scanning
R8	SIMPLEX WHITE-BAR	Support of scanning unit
R9	SCAN OUT ROLLER	Transfer a scanned original paper to the exit roller
R10	D-CIS MODULE	Back side image scan unit
R11	EXIT ROLLER	Sends an original paper to the exit tray

## Document feeder LX electrical parts

Learn about the document feeder LX electrical parts.

Figure 1-51 Document feeder LX electrical parts electrical parts locations

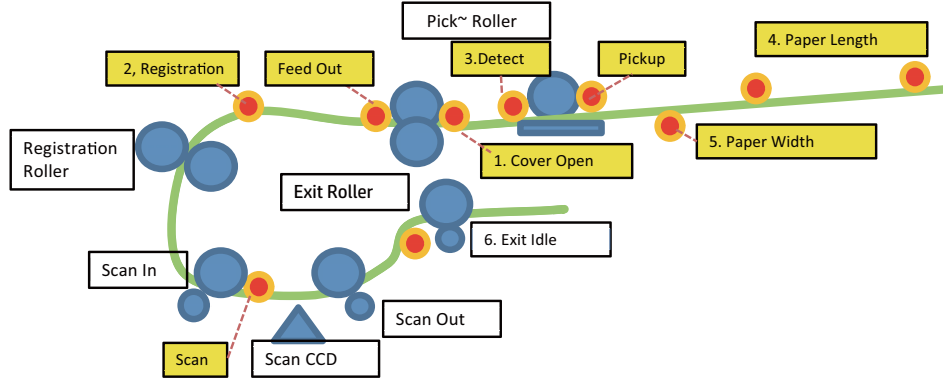


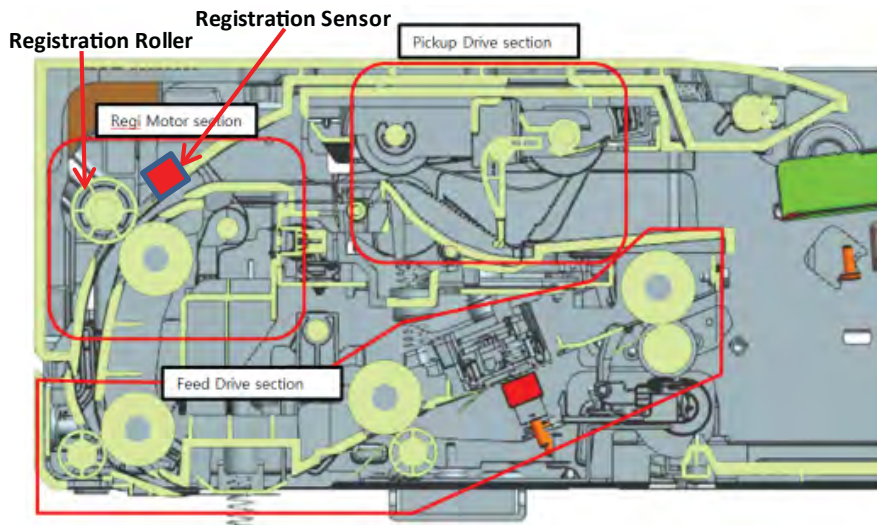
Table 1-20 Document feeder LX electrical parts

Callout	Item	Function
1	Cover Open	Detects if cover is open or closed
2	Registration (Regi) Sensor	Detects if there is a jam on the registration path
3	Detect Sensor	Detects if tray is empty
4	Paper Length Sensor	Detects paper length
5	Paper Width Sensor	Detects paper width

## Document feeder LX registration

Learn about the document feeder LX registration.

Figure 1-52 Document feeder LX registration



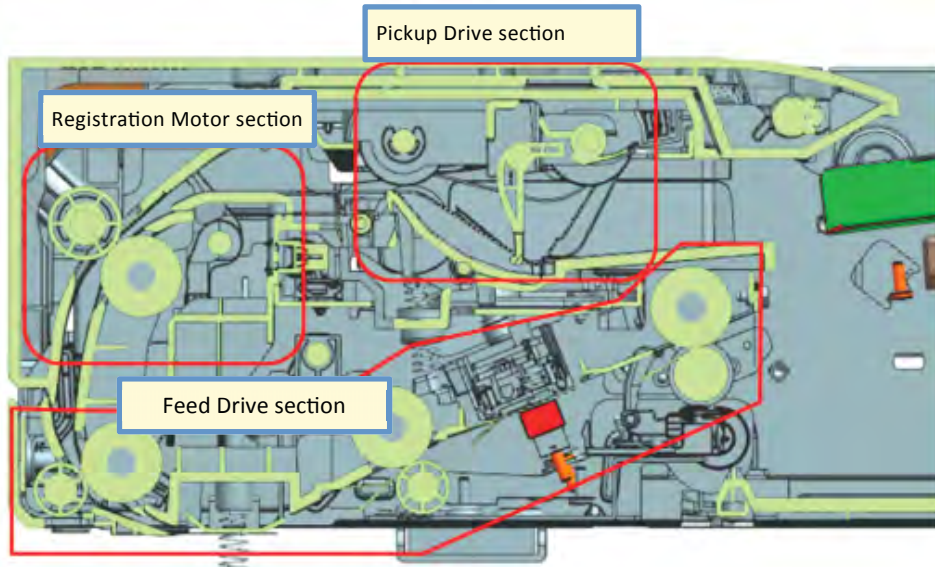
Item	Document feeder LX
Registration	1 times registration

## Document feeder LX drive system

Learn about the document feeder LX drive system.

The drive system consists of one motor and two clutches to transfer the paper.

**Figure 1-53** Document feeder LX drive system



The document feeder LX drive system consists of two motors (BLDC and STEP) and one clutch that moves the paper.

- BLDC Motor > Feed and pickup
- STEP Motor > Regi
- Clutch > Pickup

There are three sections: pickup drive section, registration (regi) motor section, and feed drive section.

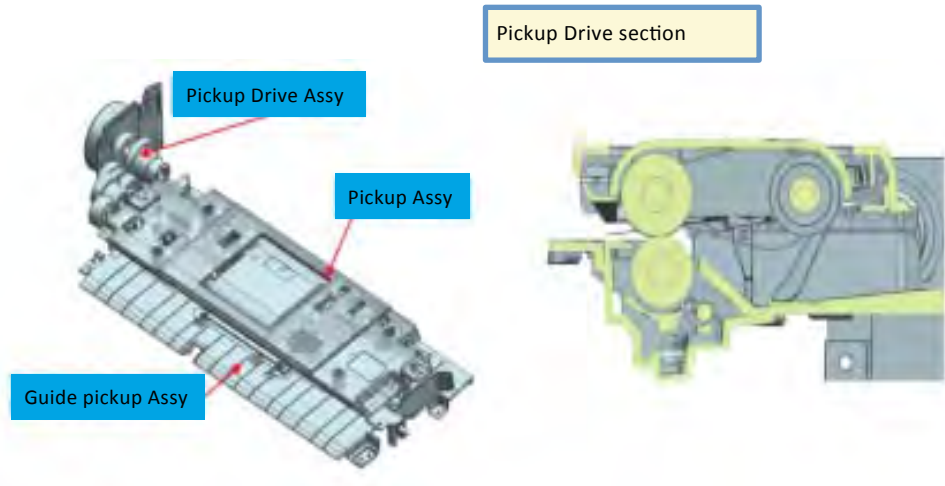
The pickup drive section has three assemblies: pickup drive assembly, pickup assembly, and guide pickup assembly.

The registration motor section has the regi motor, trans gear, regi roller, regi-idle roller, regi sensor, and actuator.

## LX ADF original pickup assembly

Learn about the LX ADF original pickup assembly.

Figure 1-54 LX ADF pickup assembly



After detecting the paper, one motor controls the drive system.

The CLUTCH-ELECTRIC provides the power to pick up the paper.

The CLUTCH cannot rotate inversely. The spring that is included in the ADF GUIDE PICKUP ASSEMBLY is connected to COVER-OPEN. When the CLUTCH does not drive, stand-by status occurs and stops the operation.

The ADF roller and pick roller are connected by the belt.

The ADF roller is provided with power while the paper is picked up and transferred to the registration roller. When the pickup drive is stopped and the registration roller is driven, the ADF roller becomes idle.

The normal process is:

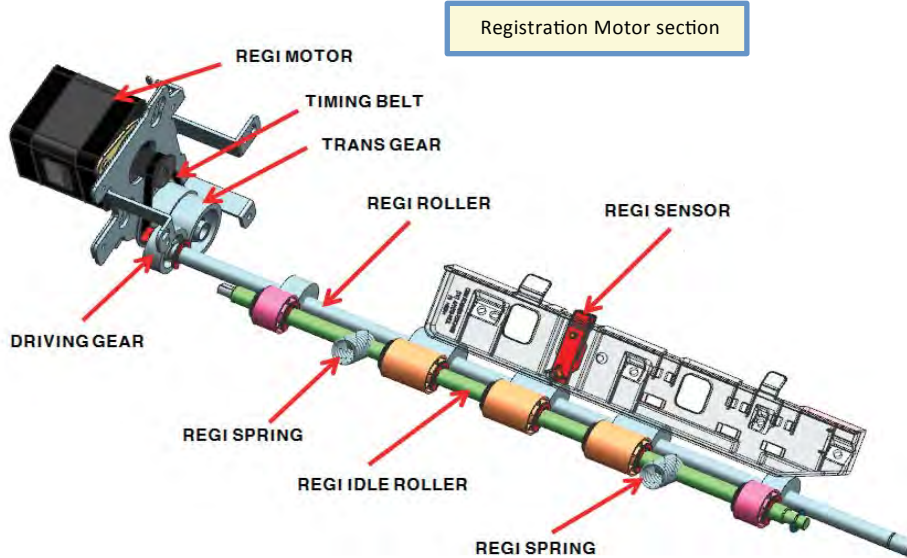
- When the original is setting up, the detect-sensor is activated and the printing job starts. The motor and pickup clutch begin working. The pick roller then moves down and contacts the original in the tray.
- When the registration sensor detects paper, the pickup clutch stops.
- When the detect-sensor detects that the tray is empty, the motor stops and the printer enters stand-by status.

### LX ADF registration (regi) drive assembly

Learn about the LX ADF registration (regi) drive assembly.



Figure 1-55 LX ADF registration (regi) drive assembly



The registration drive uses the CLUTCH-ELECTRIC to drive the registration roller and transfer the paper to the ROLLER FEED.

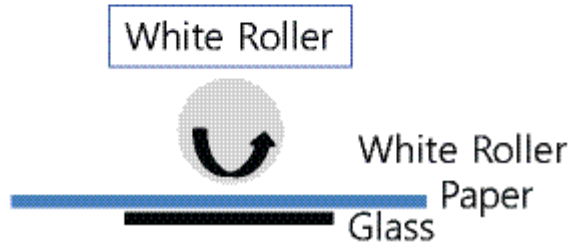
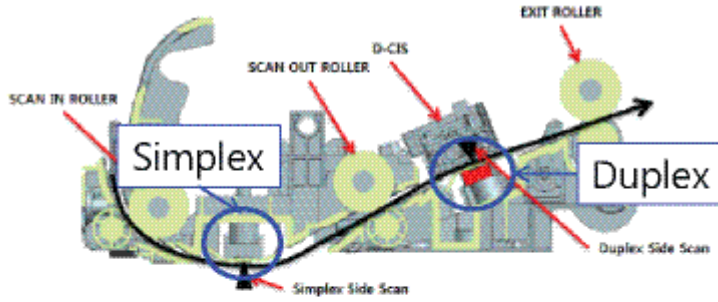
The registration roller aligns the leading edge of the original. When the original is placed in the nip, the roller is rotated for alignment.

The CLUTCH-ELECTRIC repeats on/off to align each original.

## Document feeder LX scanning position

Learn about the document feeder LX scanning position.

Figure 1-56 Document feeder LX scanning position



Item	Simplex	Duplex
Scanning	White Bar	White Bar

## Document feeder LX specifications

Learn about the document feeder LX specifications.

Table 1-21 Document feeder LX specification

Item	Specification
Capacity	100 pages
Scan Speed	80/160 ipm
Pickup	Semi-Retard
Registration	1 times registration
Motor	2 each
Stacker	Not applicable
Scanning	White Bar
MSO	Not applicable

# Flow document feeder z models (GX)

Learn about the flow document feeder z models (GX).

## Flow document feeder overview

Learn about the flow document feeder.

Figure 1-57 Flow document feeder overview

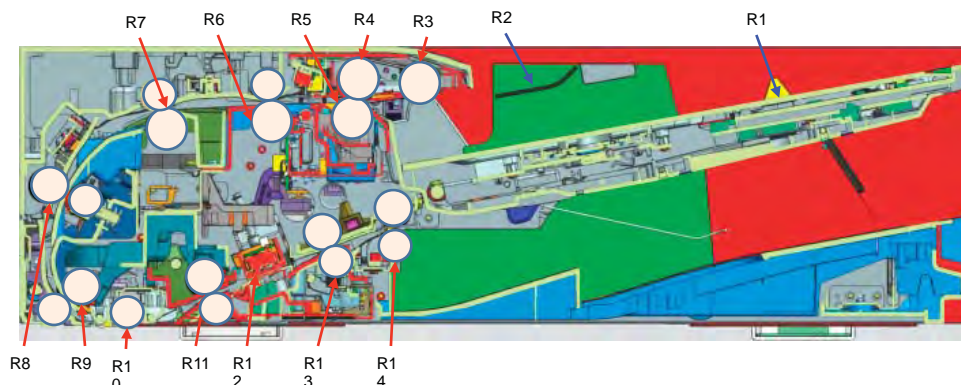


Table 1-22 Flow document feeder overview

Part	Description	Function
R1	STACKER ASSY	Original paper input tray
R2	GUIDE-DOC F&R	Original paper guide (front/rear)
R3	PICK ROLLER	Pick up original paper from the input tray
R4	ADF ROLLER	Original paper feed roller
R5	SEPARATION ROLLER	Original paper separation roller
R6	FEED ROLLER	Original paper transfer roller (A6 size)
R7	PRE REGI ROLLER	Original paper alignment roller (1 round)
R8	REGI ROLLER	Original paper alignment roller (2 round)
R9	SCAN IN ROLLER	Feeds an original paper before scanning
R10	SIMPLEX WHITE-ROLLER	Support of simplex scanning unit
R11	SIMPLEX SCAN OUT ROLLER	Transfer a scanned original paper to the duplex white-roller
R12	D-CIS MODULE	Back side image scan unit
R13	DUPLEX SCAN OUT ROLLER	Transfer a scanned original paper to the exit roller
R14	EXIT ROLLER	Sends an original paper to the exit tray

## Flow document feeder sensors

Learn about the flow document feeder sensors.

Figure 1-58 Flow document feeder sensors

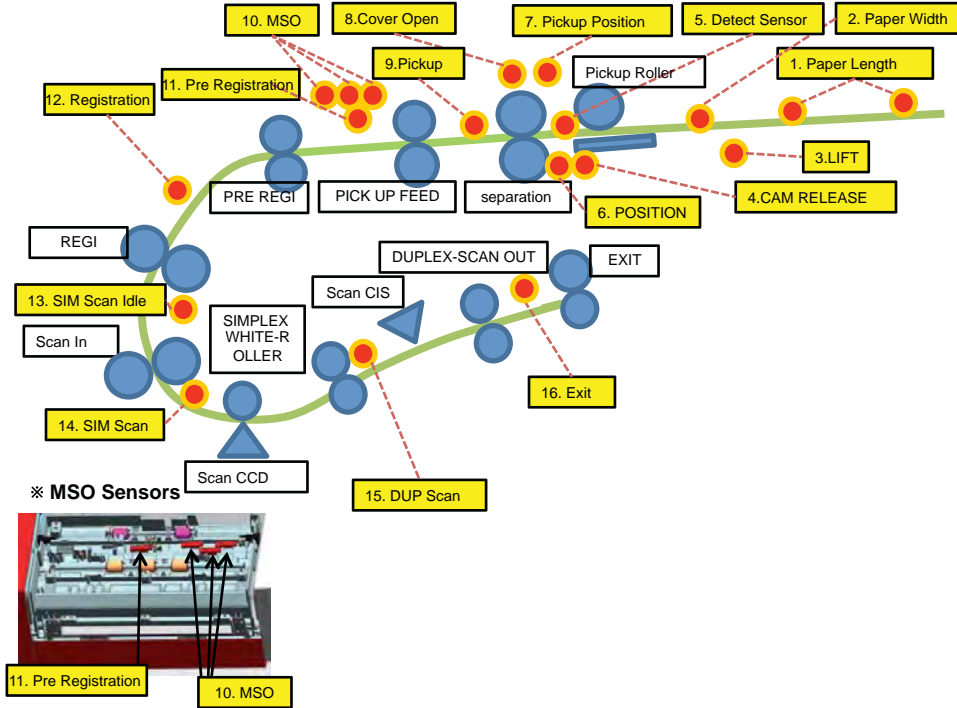


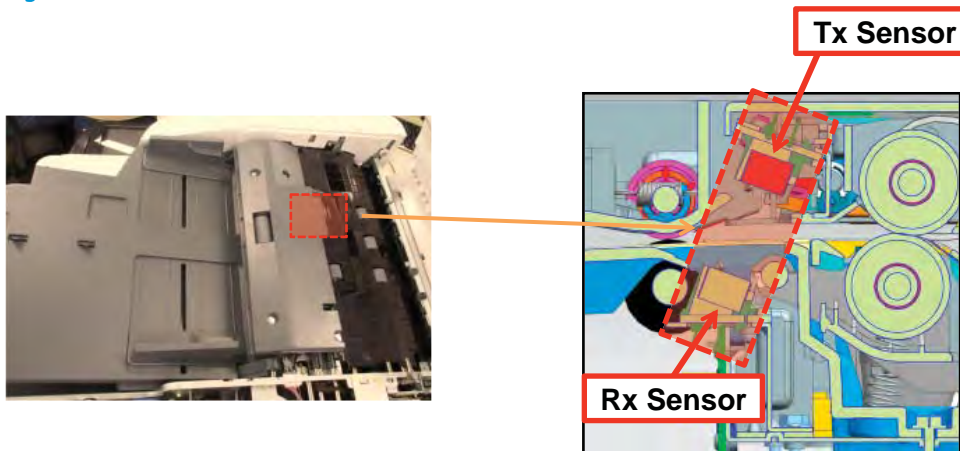
Table 1-23 Flow document feeder sensors

Callout	Item	Function
1	Paper Length Sensor	Detects paper length
2	Paper Width Sensor	Detects paper width
3	Stacker Lift Sensor	Detects Stacker Position
4	Cam Release Sensor	Sensing 'Separation Roller' rotation
5	Detect Sensor	Detects if tray is empty
6	Position Sensor	Detects Stacker Position
7	Pickup Position Sensor	Sensing 'Pickup Roller' rotation
8	Cover Open Sensor	Detects if cover is open or closed
9	Pickup Sensor	Detects if there is a jam on the feed path
10	MSO Sensor	Detects mix size
11	Pre-Regi Sensor	Detects if there is a jam on the pre-regi path
12	Regi Sensor	Detects if there is a jam on the Regi path
13	SIM Scan Idle Sensor	Sensing 'Scan In Roller' rotation
14	SIM Scan Sensor	Detects if there is a jam on the Scan In path
15	DUP Scan Sensor	Detects if there is a jam on the Scan Out path
16	Exit Sensor	Paper Exit Sensing

## Flow document feeder ultra sonic multi-feed (USM) sensor

Learn about the flow document feeder ultra sonic multi-feed (USM) sensor.

Figure 1-59 Flow document feeder ultra sonic multi-feed (USM) sensor



This sensor detects multi-feeds.

- Component: Ultrasonic Sensor Tx Board, Rx Board , HIC Board (Amp and Filter)
- The Rx Sensor has a different level on each paper status: no paper, one paper, multiple papers.
- Detect the multi-feeding through the level change of Rx Sensor.
- Transmit and receive operation of 300 khz frequency.

## Flow document feeder drive system

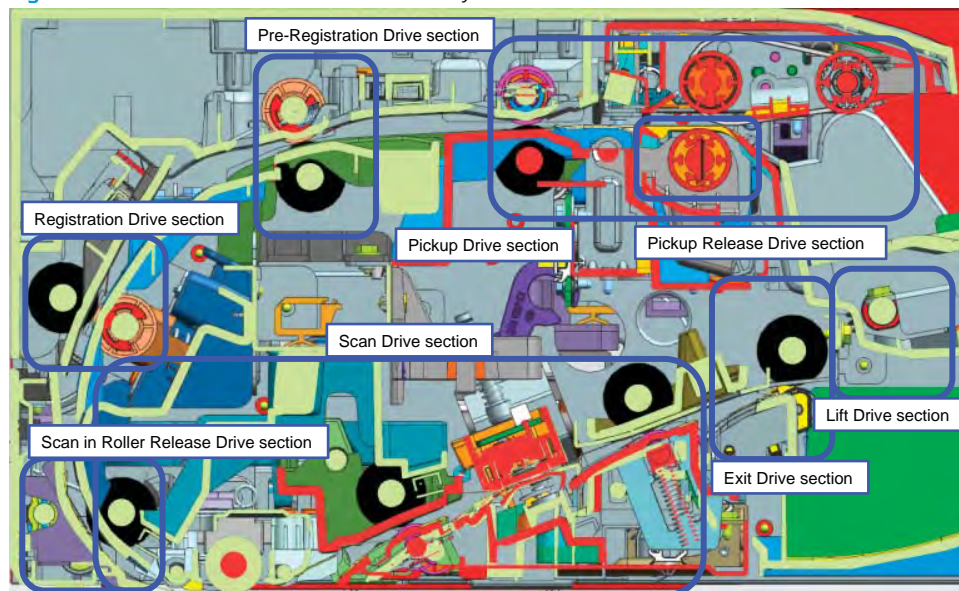
Learn about the flow document feeder drive system.

The flow document feeder drive system drive system includes eight motors.

The Flow ADF drive system consists for the following sections:

- Pickup release drive
- Pickup drive
- Pre-regi drive
- Regi drive
- Scan-in roller release drive
- Scan drive
- Exit drive
- Lift drive

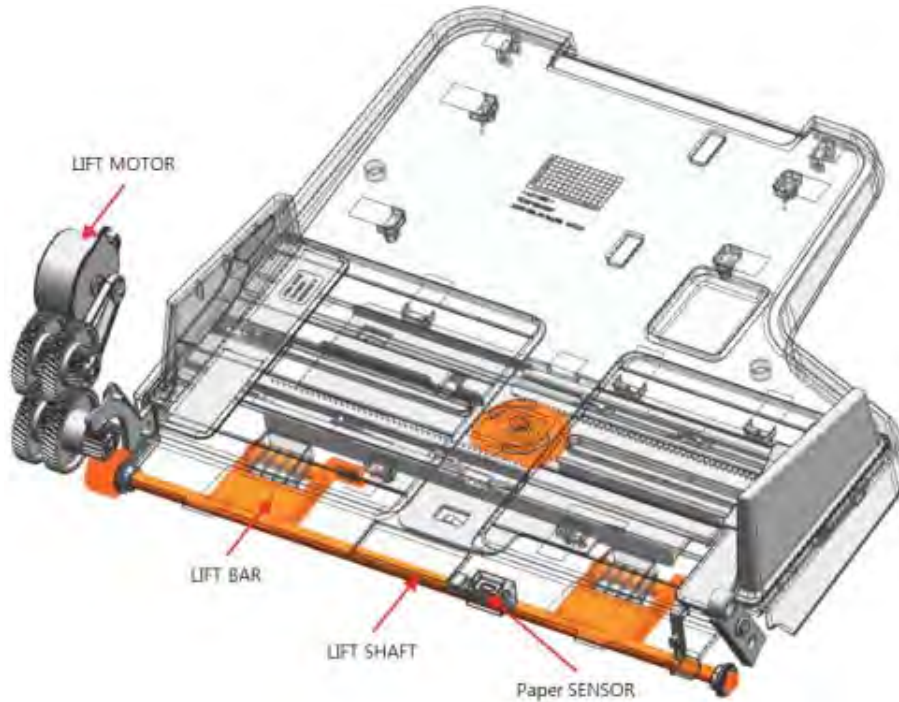
Figure 1-60 Flow document feeder drive system



## Flow document feeder lifting drive system

Learn about the flow document feeder lifting drive system.

Figure 1-61 Flow document feeder lifting drive system

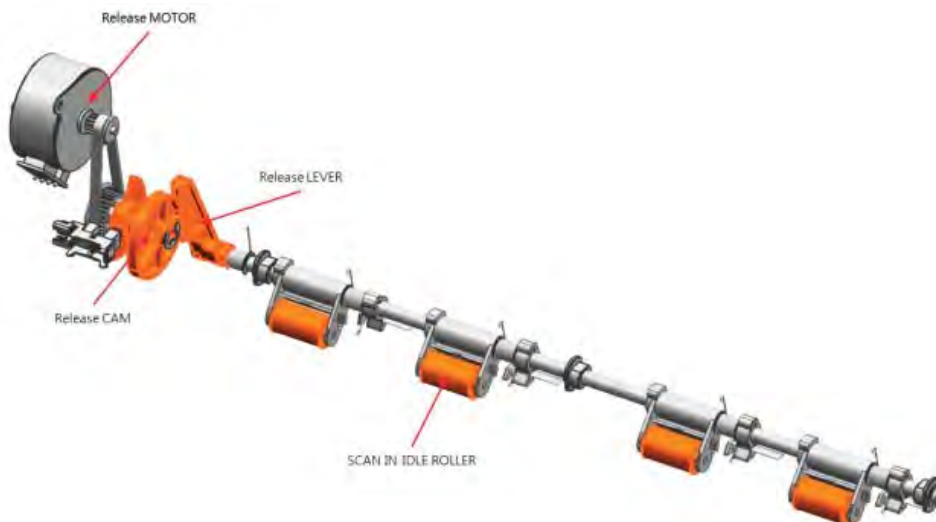


- Component: LIFT MOTOR, LIFT SHAFT, LIFT BAR, PAPER SENSOR
- LIFT MOTOR Starts > LIFT SHAFT and LIFT BAR lift Tray
- PAPER SENSOR detects paper in the Tray
- Paper contacts PICKUP ROLLER and stops movement
- Document is passed through SCAN OUT SENSOR. Duplex scanning starts.

### Flow document feeder scan-in roller release drive system

Learn about the flow document feeder scan-in roller release drive system.

Figure 1-62 Flow document feeder scan-in roller release drive system



- Holds the rear of the paper using cam motion for improved scan quality
- Component: RELEASE MOTOR, RELEASE CAM, SCAN-IN IDLE ROLLER
- Motor and cam operation repeats for every piece of paper

## Flow document feeder specifications

Learn about the flow document feeder specifications.

**Table 1-24** Flow document feeder specification

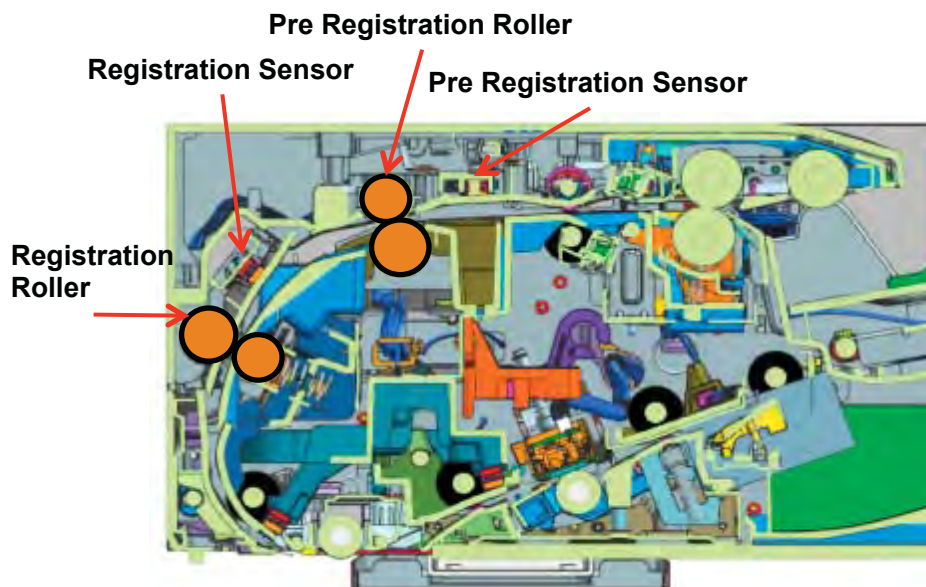
Item	Specification
Capacity	250 pages (stacker lifting)
Scan Speed	120/240 ipm
Pickup	Semi-Retard
Registration	2 times registration
Motor	8 each
Stacker	Lifting
Scanning	White Roller/White Bar
MSO	Support

## Flow document feeder registration

Learn about the flow document feeder registration.

The flow document feeder registration uses a two-times registration process.

**Figure 1-63** Flow document feeder registration





## Flow document feeder scanning position

Learn about the flow document feeder scanning position.

Figure 1-64 Flow document feeder scanning position

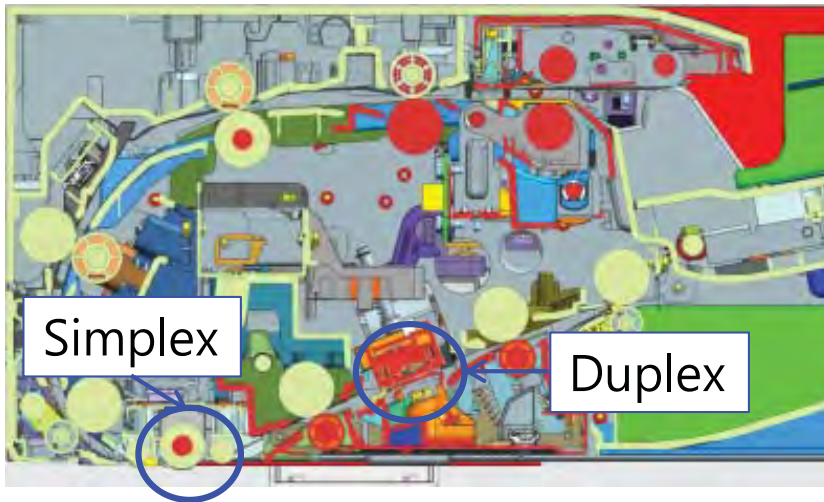


Table 1-25 Flow document feeder scanning position

Item	Simplex	Duplex
Scanning	White Roller	White Bar

## Flow document feeder mixed size original (MSO) sensor

Learn about the flow document feeder mixed size original (MSO) sensor.

The MSO sensor detects the size of mixed size papers and sets the alignment of the papers to the rear.

Figure 1-65 Flow document feeder MSO 1



Figure 1-66 Flow document feeder MS0 2

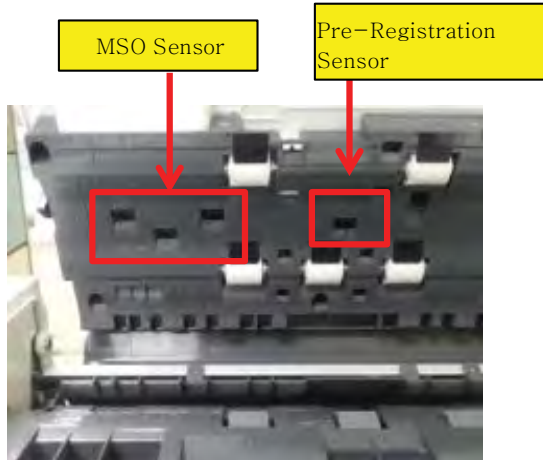


Table 1-26 Flow document feeder MS03 (length x max width)

	A3 SEF (297 mm) (11.7 in)	A4 LEF (297 mm) (11.7 in)	B4 SEF (257 mm) (10.1 in)	B5 LEF (257 mm) (10.1 in)	A4 SEF (210 mm) (8.3 in)	A5 LEF (210 mm) (8.3 in)	A5 LEF (182 mm) (7.2 in)	A5 SEF (148 mm) (5.8 in)
A3 SEF (420 mm) (16.5 in)		X						
A4 LEF (210 mm) (8.3 in)	X							
B4 SEF (363 mm) (14.3 in)	X	X		X				
B5 LEF (182 mm) (7.2 in)	X	X	X					
A4 SEF (297 mm) (11.7 in)	X	X	X	X		X		
A5 LEF (148 mm) (5.8 in)	X	X	X	X	X			
B5 SEF (257 mm) (10.1 in)			X	X	X	X		
A5 SEF (210 mm) (8.3 in)					X	X		

## Flow document feeder dual sensor cleaning method

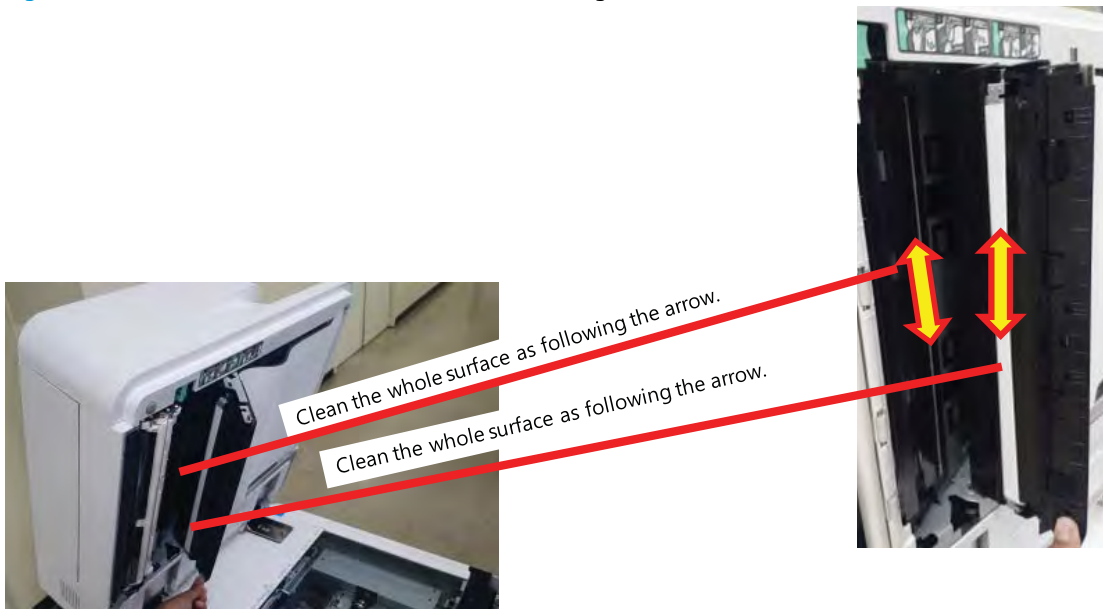
Learn about the flow document feeder dual sensor cleaning method.

- Component: LEVER GUIDE EXIT F, GUIDE-EXIT UPPER ASSEMBLY.
- Open LEVER GUIDE EXIT F.
- Cleans with a D-CIS GLASS in the direction indicated.
- Cleans the GUIDE EXIT UPPER ASSEMBLY in the direction indicated.

Figure 1-67 Flow document feeder dual sensor cleaning method (1 of 2)



Figure 1-68 Flow document feeder dual sensor cleaning method (2 of 2)



## Flow ADF z bundles (GX)

Learn about the flow ADF z bundles (GX).

Model	Engine	Scanner
Platen		DN-sGX Z-GX

Model	Engine	Scanner						
Color	40 ppm	Same at whole model	Scan Speed	USM	Capacity	Scan Speed	USM	Capacity
	50 ppm		80/160 ipm	X	100 sheet	120/240 ipm	0	250 sheet
	60 ppm							
Mono	40 ppm							
	50 ppm							
	60 ppm							

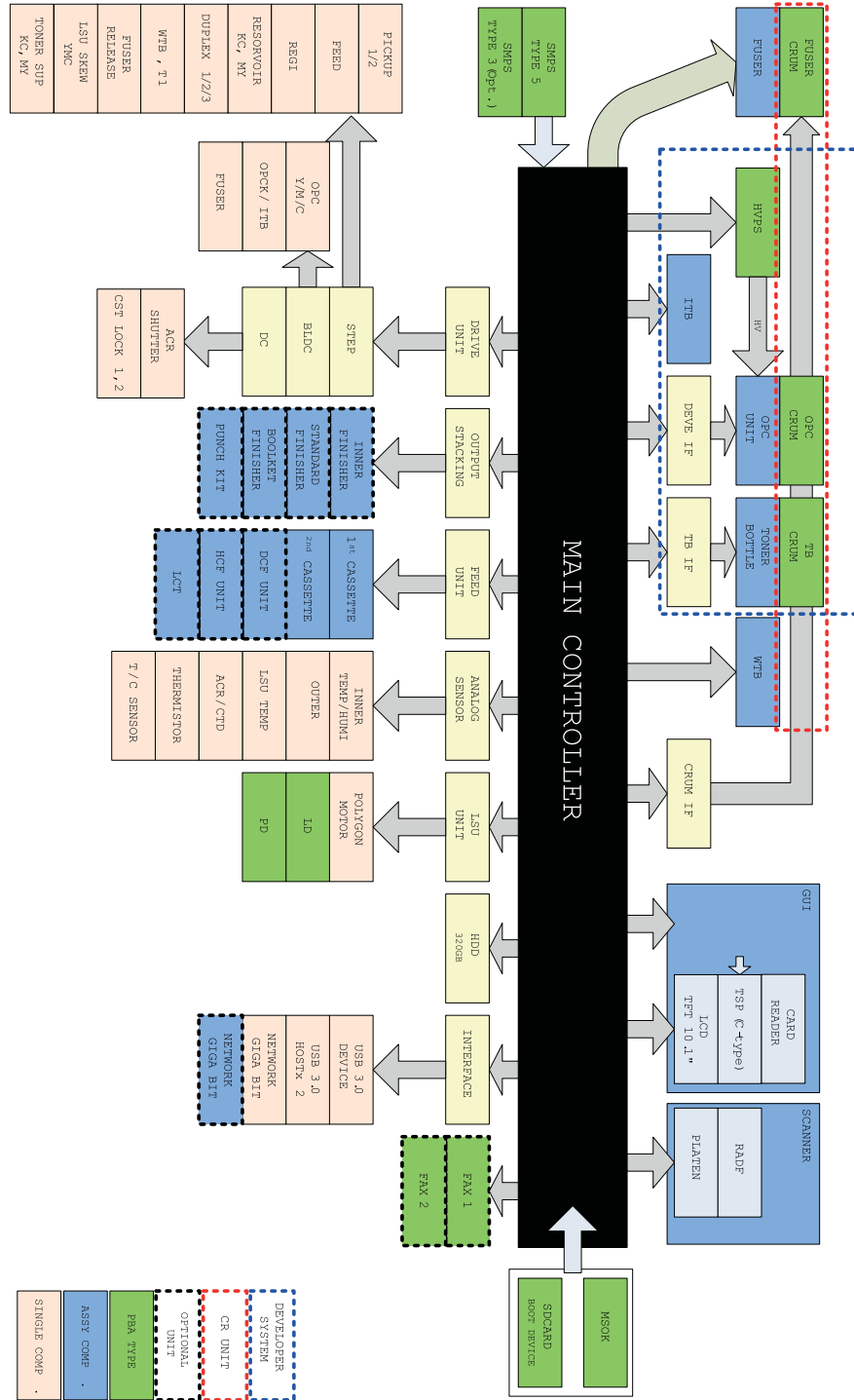
# Hardware configuration

Learn the functions and specifications of the hardware configuration.

The electronic circuit system consists of the following:

- Main controller (main board)
- OPE unit
- Document feeder (Flow/LX) controller
- HVPS board
- LVPS board
- Fuser drive assembly

Figure 1-69 Electronic circuit diagram



The main controller handles the video controller, engine controller, and scan controller.

The main controller receives print data from the host through the network or USB port and receives copy data from the scan controller. The main controller uses this information to generate printable video bitmap data. It controls all modules required to print, including the laser scanner assembly, HVPS, FAN, fuser, and so on.

The main controller communicates with the drive system and other devices through Universal Asynchronous Receiver Transmitter (UART). The main controller communicates with and checks the life of the toner cartridge, drum, and developer units through I2C.

The main controller uses Quad Core CPU 1.5 GHz, DDR3 4 GB memory, Micro SD 4 GB, and a 500 GB SATA HDD to control the engine driving, video signal processing, and user interface.

A MICOM controls power to the fuser lamp and power to the system according to an optimized energy saving algorithm. The MICOM communicates with the OPE controller through the USB 3.0 protocol to display the system information on the control panel.

The OPE unit displays the status of the system using the control panel TFT LCD in response to user actions or the main controller.

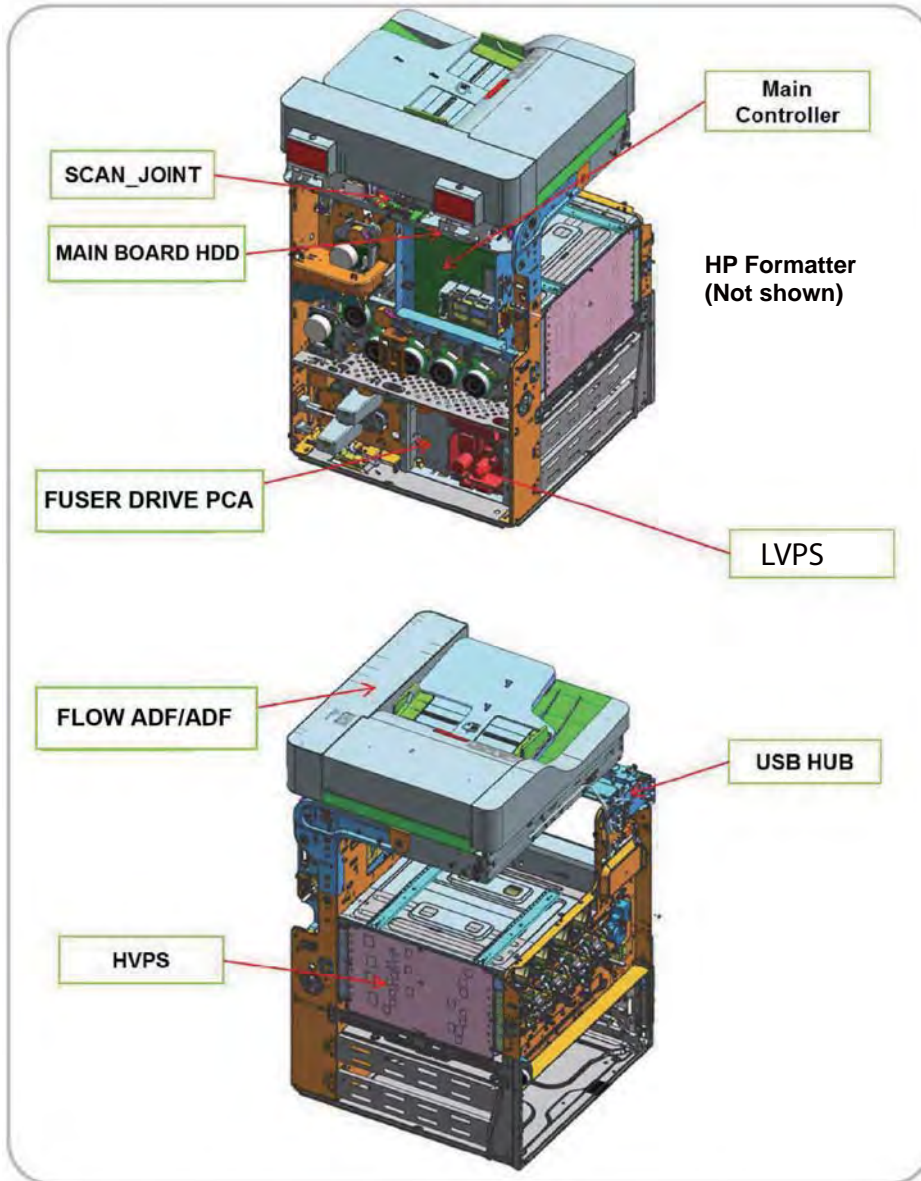
The soft power switch in the OPE unit is used to safely shut down the system.

The ADF controller controls some mechanisms required to scan continuously from the ADF. The ADF controller communicates with the main controller to synchronize scan timing.

The HVPS board generates and controls high-voltage channels. The fuser drive assembly controls power to the fuser lamp. The LVPS board generates 5 V and 24 V power for the system.

The following diagrams show the locations of the printer circuit boards:

Figure 1-70 Circuit board locations





## Main controller

Learn about the main controller.

This topic describes the main controller PCA and formatter cabling.

## Main controller

Learn about the printer main controller.

The main controller consists of the main processor (Chrous4N), memory (DDR3 2GB), flash (4 GB on main board; 2 GB on the front side and 2 GB on the back side), 1G Ethernet PHY, USB 2.0 HUB, Micom (power/fuser control), can/video/UI/fax signal interface connection, motor drive IC, engine signal interface connection, and power interface.

The main processor (Dual Core 1 GHz CPU) controls video, engine, UI display, and communicates with various devices. The HDD is connected to the main controller by SATA cable and to other devices (ADF, dual cassette feeder, finisher, modem) by UART.

Figure 1-71 Main controller block diagram

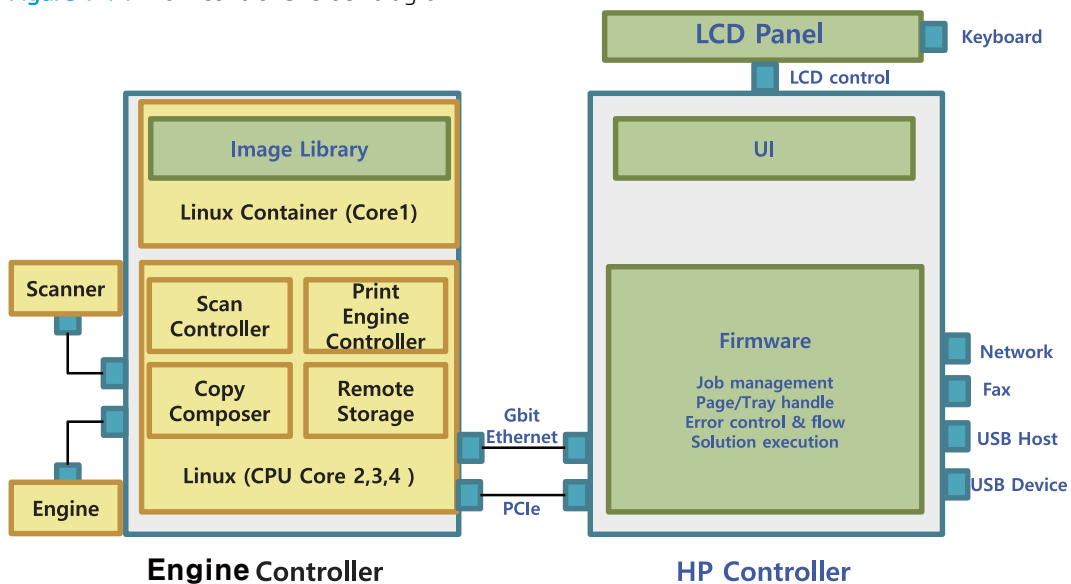


Figure 1-72 Main controller connection information (For 77822, 77825, 77830)

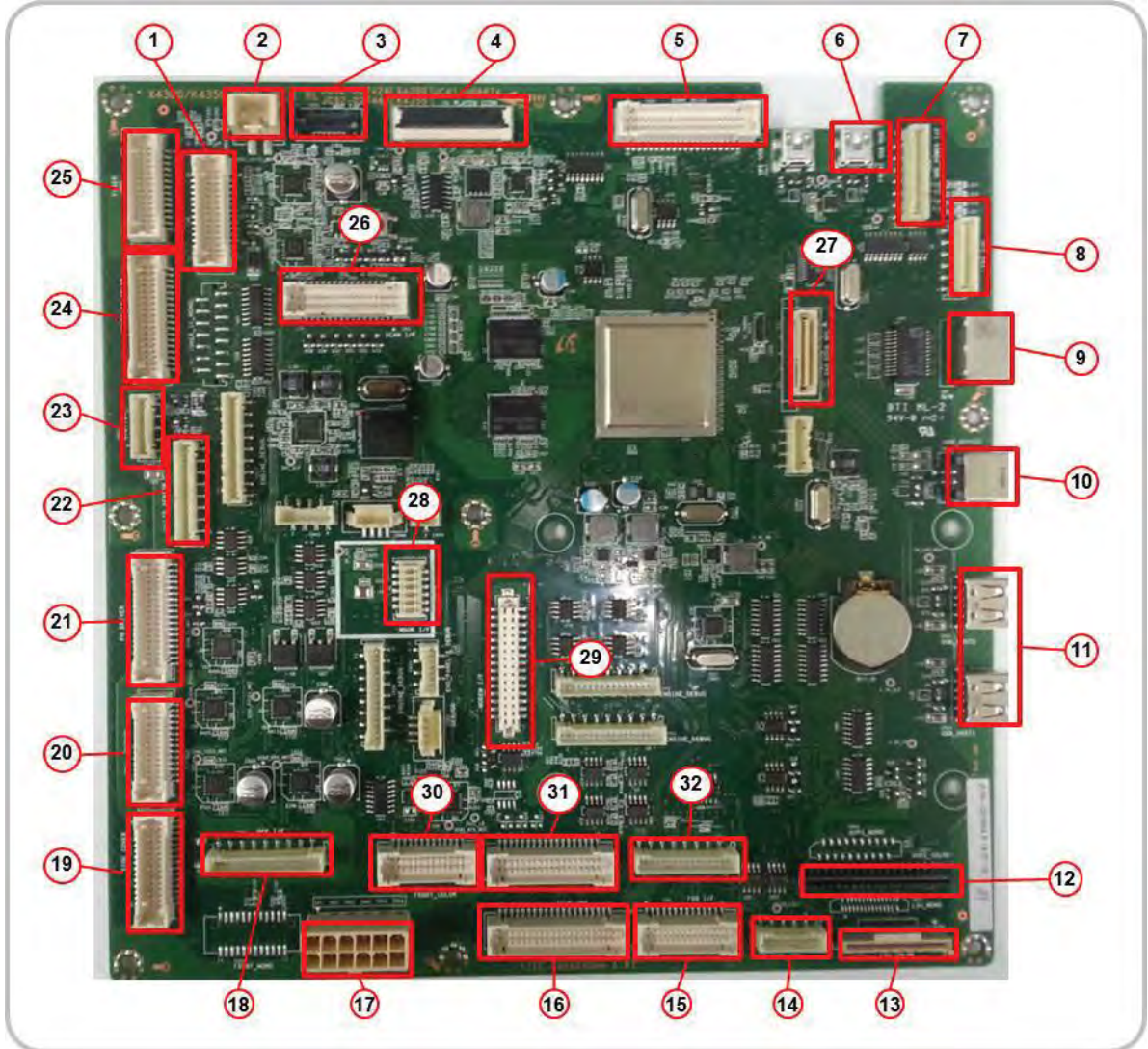


Figure 1-73 Main controller connection information (For 78323, 78325, 78330)

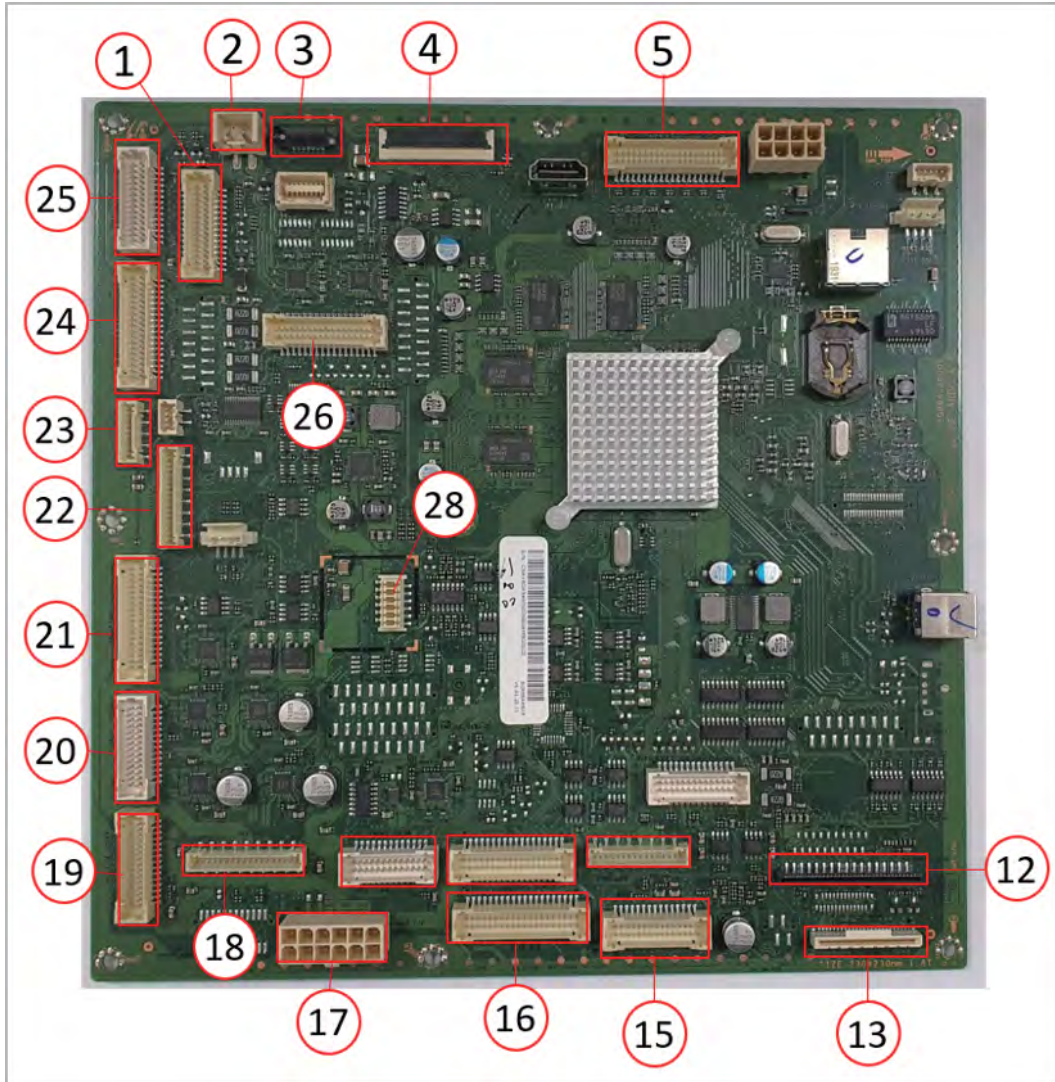


Table 1-27 Main controller connections

Item	Description	Item	Description	Item	Description	Item	Description
1	EXIT	9	GIGA N/W RJ45	17	POWER I/F	25	FUSER
2	HDD POWER	10	USB HOST 1/2	18	Dual cassette feeder I/F	26	SCAN I/F
3	HDD I/F	11	USB DEVICE	19	Right door	27	2nd GIGA NPC
4	Image scanner CCDM	12	HVPS COLOR	20	PICKUP	28	MSOK I/F
5	Flow ADF DCIS	13	Laser scanner assembly COLOR	21	PH DRIVER	29	MODEM JOINT
6	FRONT USB HUB	14	HVPS PWR	22	ID SENSOR	30	COLOR FRONT

**Table 1-27** Main controller connections (continued)

Item	Description	Item	Description	Item	Description	Item	Description
7	OPE POWER I/F	15	Fuser drive assembly I/F	23	SHUTTER	31	OPC SENSOR
8	FIH I/F	16	DEVE MTR	24	TONER I/F COLOR	32	FINISHER



**Information**

- Part Name: PCA-MAIN
- Part Number:
  - JC82-00541B (E77822, E77825, E77830 series)
  - 8GR94-60003 (E78323, E78325, E78330 series)
  - Part Name: PCA-MAIN

**Master system operation key (MSOK)**

Learn about the master system operation key (MSOK).

The MSOK PCA is used to store all system information and consists of serial flash memory, an EEPROM and an x-CRUM. The flash memory (4MB), EEPROM (256Kb), and X-CRUM are used for all system operations (system parameter, device status, tech information, and service information).

-  **NOTE:** When a main board needs to be exchanged, reinstall the MSOK PCA to the new main board to retain the system information.
-  **IMPORTANT:** Do not lose or damage the MSOK chip. It must be installed on the replacement main board in the same orientation as when it was removed in order for the printer to function.

**Figure 1-74** MSOK



1	Main PCA I/F connector
---	------------------------

- Information
  - Part number: Not applicable
  - Part name: PCA-MSOK

# Formatter cabling

Learn about the formatter cabling.

Figure 1-75 Formatter cabling (sGX/GX)

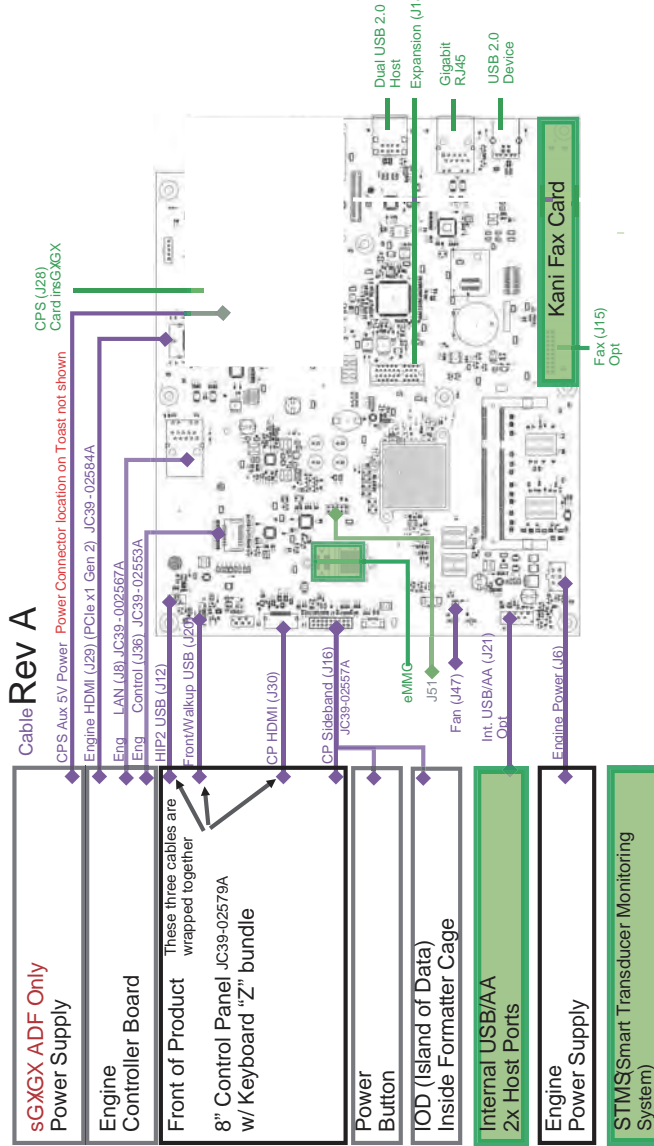


Table 1-28 Formatter cabling

Cable	Jxx	From	To	Purpose
Formatter cabling	NA	LVPS	Accelerator	Power for accelerator
Engine HDMI	J29	Main board	Formatter	High speed print data (JC39-02584A)
Engine LAN	J8	Main board	Formatter	High speed print data (JC39-02584A)
Engine control	J36	Main board	Formatter	Low level engine control (JC39-02553A)

Table 1-28 Formatter cabling (continued)

Cable	Jxx	From	To	Purpose
HIP2 USB	J12	Formatter	HIP	USB for HIP <b>NOTE:</b> Cable bundled.
Front walk-up USB	J20	Formatter	Front of printer	USB for walk u <b>NOTE:</b> Cable bundled.
CP HDMI	J30	Formatter	CP	Data to CP <b>NOTE:</b> Cable bundled.
CP side band	J16	Formatter	CP	Power, reset, wake lines, display power, keyboard (JC39-02557A)
Power button	J16	Formatter	Power button	Power ON/OFF
IOD	J16	Formatter	IOD	Data to/from Island of Data
Internal USB/AA	J21	Formatter	Accessory	Accessory
Engine power	J6	LVPS	Formatter	5V supply to formatter

## Formatter

Figure 1-76 Formatter connections (For 78323, 78325, 78330 dn bundle)

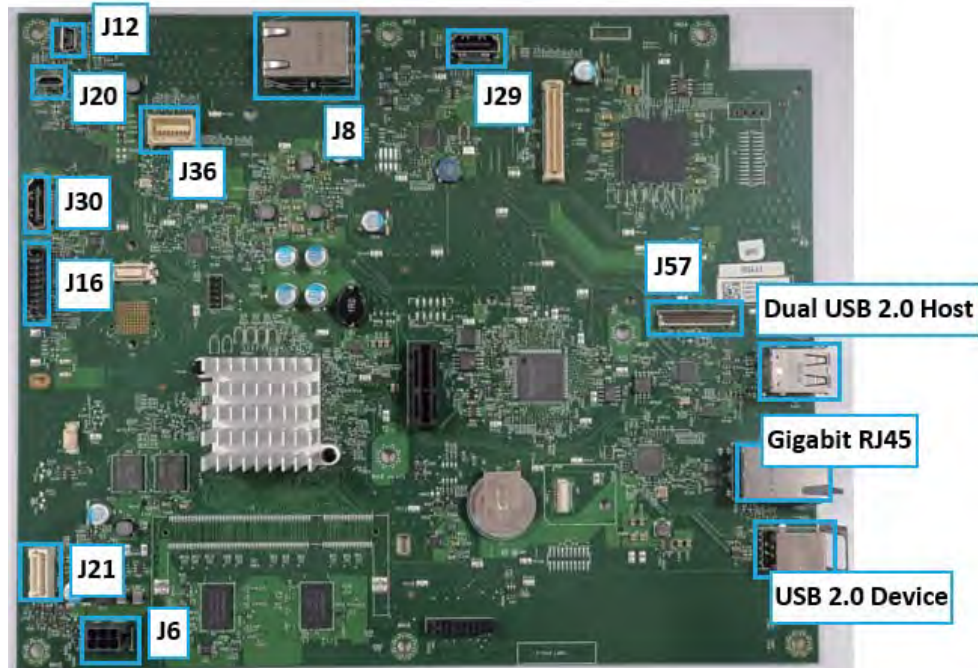


Figure 1-77 Formatter connections (For 78323, 78325, 78330 z bundel)

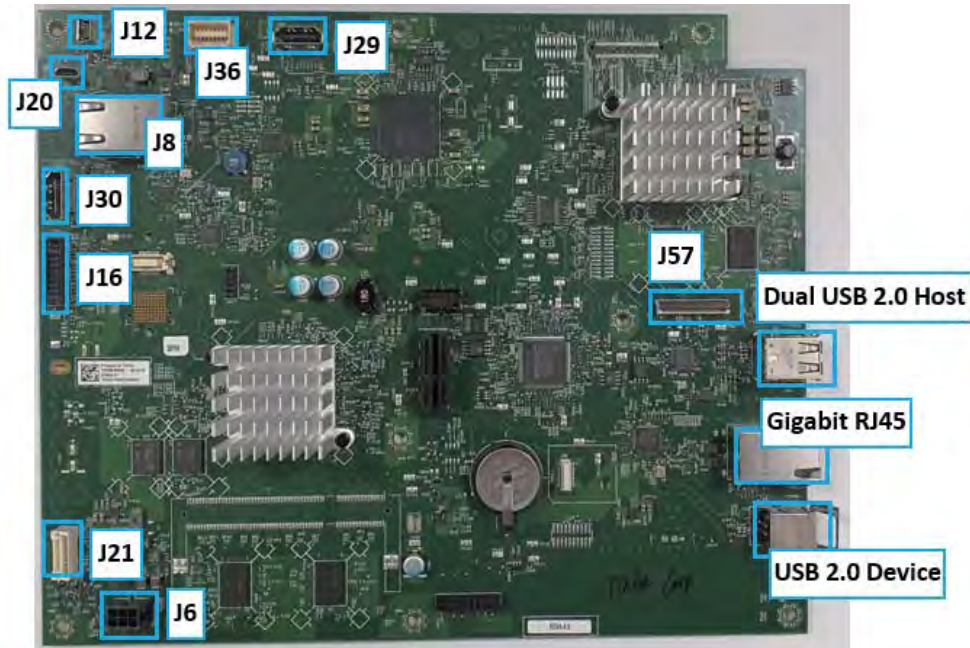


Table 1-29 Formatter connections

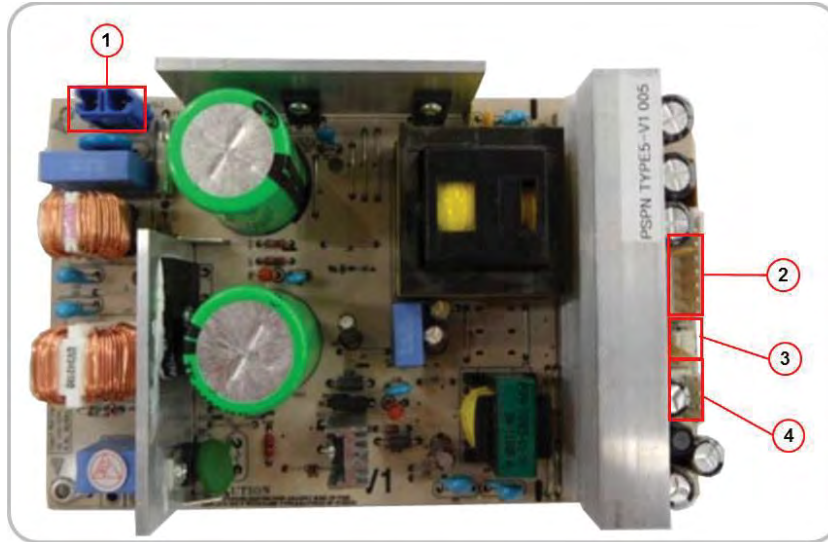
Cable	Jxx	From	To	Purpose
Engine HDMI	J29	Engine controller board (ECB)	Formatter	High speed print data (JC39-02552A)
Engine LAN	J8	Engine controller board (ECB)	Formatter	High speed print data (JC39-02567A)
Engine control	J36	Engine controller board (ECB)	Formatter	Low level engine control (JC39-02553A)
HIP2 USB	J12	Formatter	HIP	USB for HIP
Front walk-up USB	J20		Front of printer	USB for walk up
CP HDMI	J30		CP	Data to CP
				These three cables are wrapped together JC39-02554A
CP side band	J16	Formatter	CP	Power, reset, wake-lines, display power, keyboard. 3 cable assembly <ul style="list-style-type: none"> <li>JC39-02705A (a,dv models only)</li> <li>JC39-02557A (dn models only)</li> </ul>
Power button	J16	Formatter	Power button	Power ON/OFF
IOD	J16	Formatter	IOD	Data to/from island of data
Internal USB/AA	J21	Formatter	Accessory	Accessory
Engine power	J6	LVPS	Formatter	5V supply to formatter
STMS	J57	Formatter	STMS	Data to/from smart transducer monitoring system (STMS) (JC39-02594A)

## Low voltage power supply (LVPS; Type 5H) / switching mode power supply (SMPS)

Learn about the low voltage power supply (LVPS; Type 5H) / switching mode power supply (SMPS).

The low voltage power supply (LVPS-SMPS) Type 5H PCA supplies electric power to the main PCA and other boards. The voltage provided includes +5V, and +24V from a 110V/220V power input. It has safety protection modes for over current and overload.

Figure 1-78 LVPS (SMPS) Type 5H PCA



### Specification

- General input/output voltage
  - AC 110V (90V-135V)
  - AC 220V (180V-270V)
  - Input current: 13.7A (110V)/6.8A (220V)
  - Output power: 1500W
    - DC 5V: 55W/DC 5VS: 30W/DC 24V: 432W


Table 1-30 Information

	110 V	220 V
Part number	JC44-00249A	JC44-00250A
Part name	LVPS 110V Type 5H	LVPS 220V Type 5H

## Low voltage power supply (LVPS) PCA (Type 4) (GX/z models)

Learn about the low voltage power supply (LVPS) PCA (Type 4).

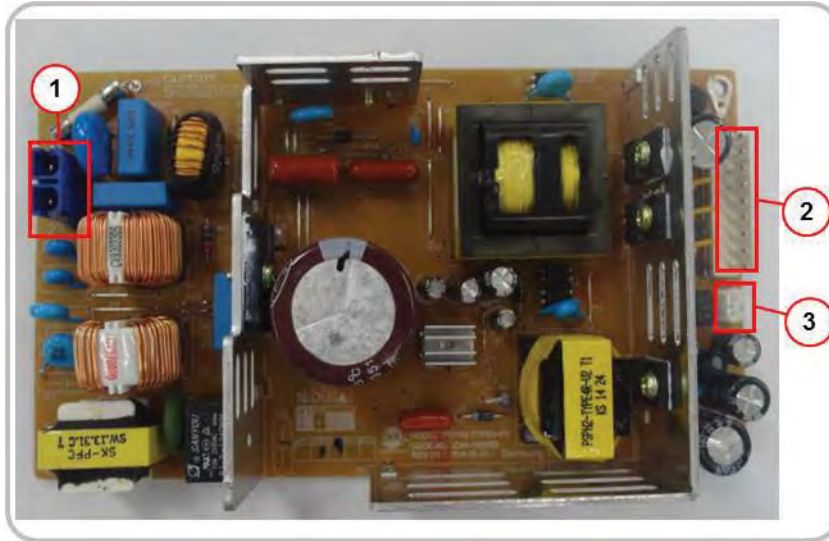


 **NOTE:** The Type 4 LVPS only exists on some early models during original release. This has been removed from all new models.

Some models have three LVPS boards. (Type5 x 1 each, Type4 x 2 each)

The low voltage power supply (LVPS) board supplies electric power to the main board and other boards. The voltage provided includes +5 V, and +24 V from a 110 V/220 V power input. It has safety protection modes for over current and overload.

**Figure 1-79** LVPS PCA (Type 4)



1	INPUT_AC
2	OUTPUT_DC +24 V 1/2/3 and DC +5 V 1/2 (to Main PCA)
3	24 V on/off

### Specification

- General input/output voltage
  - AC 110 V (110 V — 127 V)
  - AC 220 V (220 V — 240 V)
  - Input current: 6.3 A (110 V)/5 A (220 V)
  - Output power: 205 W
    - DC 5 V: 25 W
    - DC 24 V: 180 W

## Information

**Table 1-31** LVPS PCA (Type 4)

	110V	220V
Part number	JC44-00091D	JC44-00092D
Part name	LVPS 110V Type 4	LVPS 220V Type 4

## Input/output connector

- AC input connector (CN1)

**Table 1-32** LVPS PCA (Type 4)

PIN assign	PIN name	Description
1	AC_L	AC input
2	AC_N	

- DC output connector (CN4)

**Table 1-33** LVPS PCA (Type 4)

PIN assign	PIN name	Description
1	+5V1	Power
2	GND	5 V ground
3	+5V2	Power
4	GND	5 V ground
5	+24V1	Power
6	GND	24 V ground
7	+24V2	Power
8	GND	24 V ground
9	+24V3	Power

- Signal Connector (CN3)

**Table 1-34** LVPS PCA (Type 4)

PIN assign	PIN name	Description
1	GND	Active Low
2	24 V On/Off	
3	GND	

## Fuser drive board (FDB)

Learn about the fuser drive board.

This board supplies voltage to the fuser AC, heater, and main board.

Figure 1-80 Fuser drive board (FDB) (For 77822, 77825, 77830)

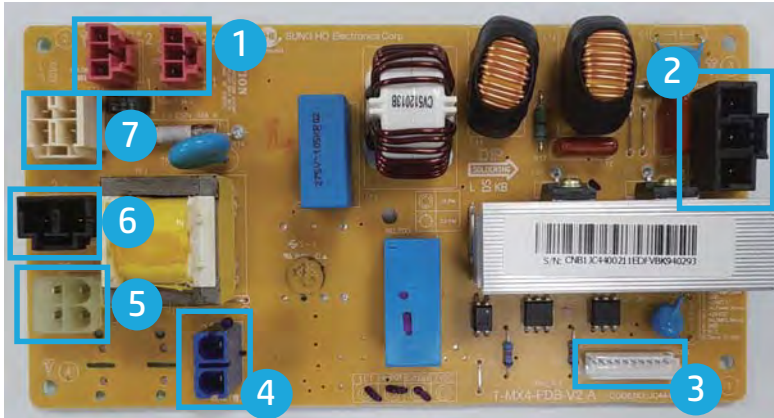
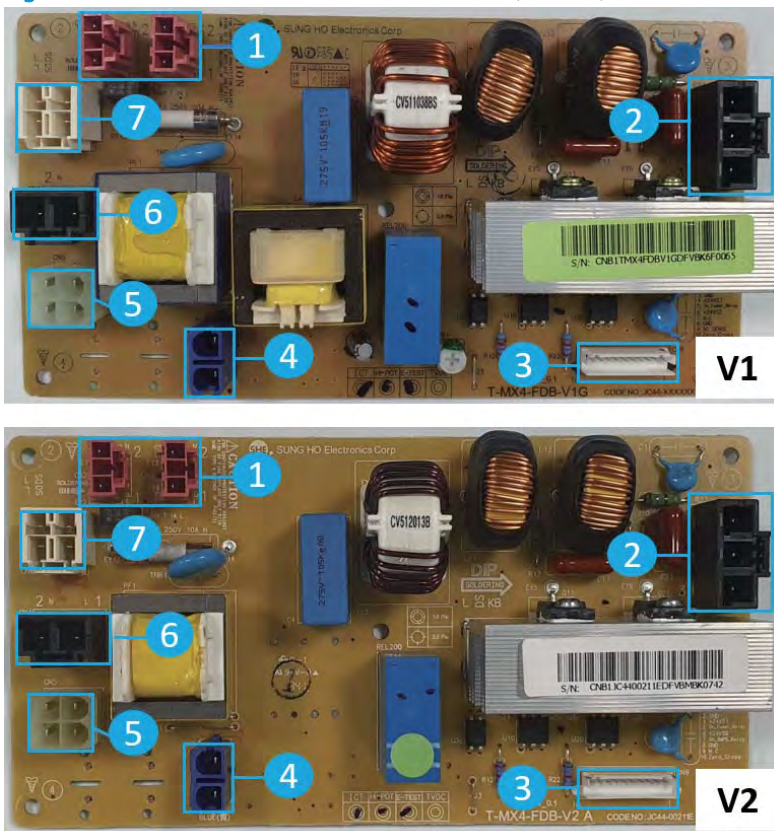


Figure 1-81 Fuser drive board (FDB) (For 78323, 78325, 78330)



- Information

Table 1-35 Fuser drive board (FDB)

Part number	Description	Remark
8GR94-60001	FDB V1 (110V)	
8GR94-60002	FDB V2 (220V)	

- Connection

**Table 1-36** Fuser drive board (FDB)

Item	Description
1	Heater I/F
2	Fuser AC
3	Fuser drive PCA I/F
4	Type 5
5	Main S/W
6	Inlet
7	Heater S/W

## High-voltage power supply (HVPS) PCA

Learn about the high-voltage power supply (HVPS) PCA.

The HVPS PCA generates 15 high-voltage channels, including ITHV (4), MHV (4), DEV (4), FUSER, SAW, and THV.

**Figure 1-82** HVPS board (For 77822, 77825, 77830)

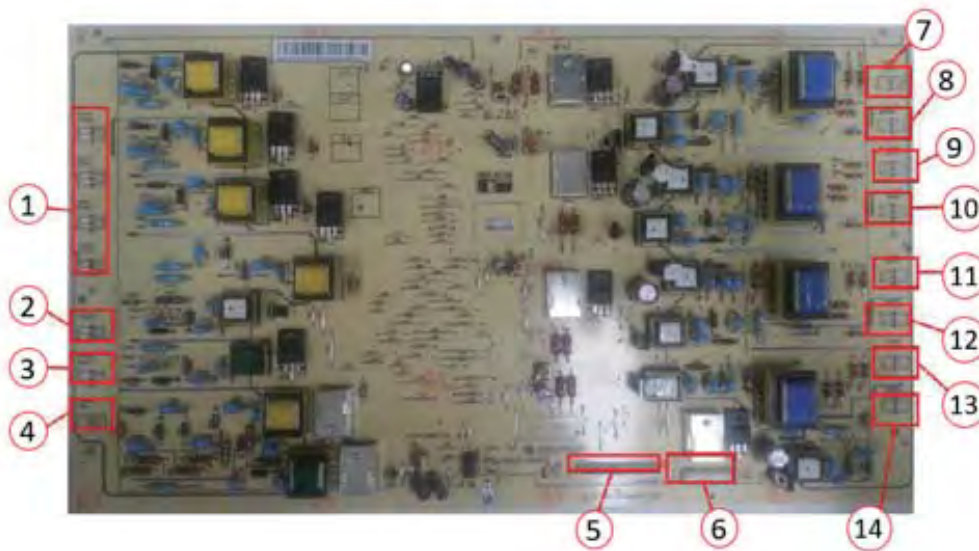
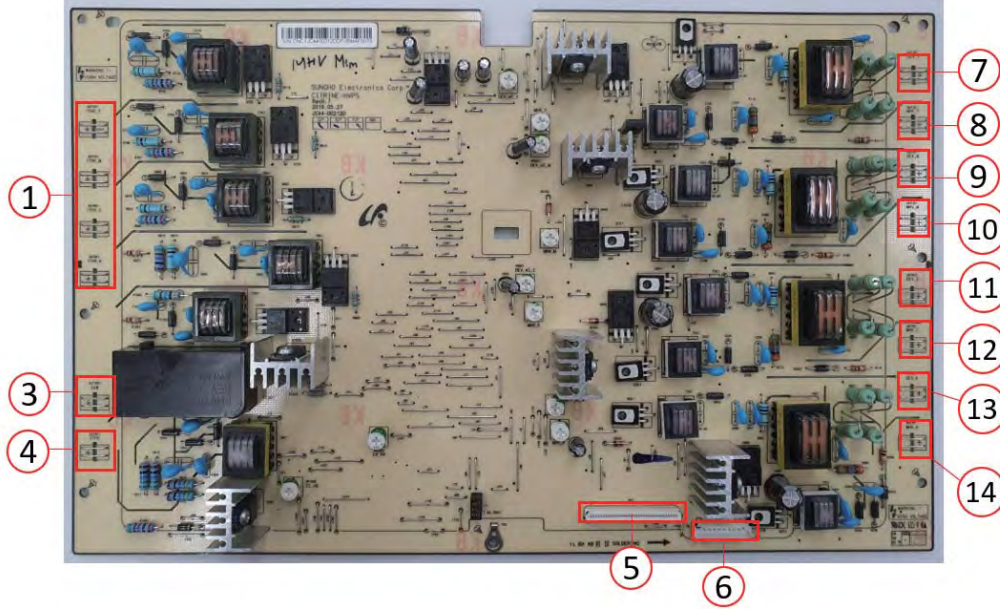


Figure 1-83 HVPS board (For 78323, 78325, 78330)



### Connection Information

Table 1-37 HVPS connections

No	Connections
1	ITHV Y/M/C/K
2	Fuser
3	SAW
4	THV
5	HVPS I/F
6	HVPS Voltage
7	DEV Y
8	MHV Y
9	DEV M
10	MHV M
11	DEV C
12	MHV C
13	DEV K
14	MHV K

### Specification

- Input voltage: DC 24V, 5V
- Output voltage

- MHV: —1182V
- DEV DC: —498V
- DEV AC Y/M/C/K: Vpp 1000V
- THV1 Y/M/C/K: 19.97uA
- THV2+: 1893V, THV2 -: 2250V
- FUSER: 819V
- SAW: -703V

## Eraser PCA

Learn about the eraser PCA.

The eraser PCA has one LED. The LED is used for erasing the negative charges on the surface of the drum after printing.

**Figure 1-84** Eraser PCA



### Information

- Part name: PCA-ERASER

## Waste Sensor PCA

Learn about the waste sensor PCA.

The waste sensor PCA detects the waste toner level inside the toner collection unit.

**Figure 1-85** Waste sensor PCA



### Information

- Part name: WASTE SENSOR RX

## CRUM PCA

Learn about the CRUM PCA.

The CRUM PCA includes memory for the drum, toner cartridge, and fuser.

**Figure 1-86** CRUM PCA



### Information

- Part name: PCA-ZCRUM

## Toner CRUM joint PCA

Learn about the toner CRUM joint PCA.

The toner CRUM joint PCA is the interface PCA between the toner cartridge and the printer.

**Figure 1-87** Toner CRUM joint PCA



## Paper Size sensor PCA

The paper size sensor PCA is used for detecting the size of the paper in the tray.

**Figure 1-88** Paper size sensor PCA



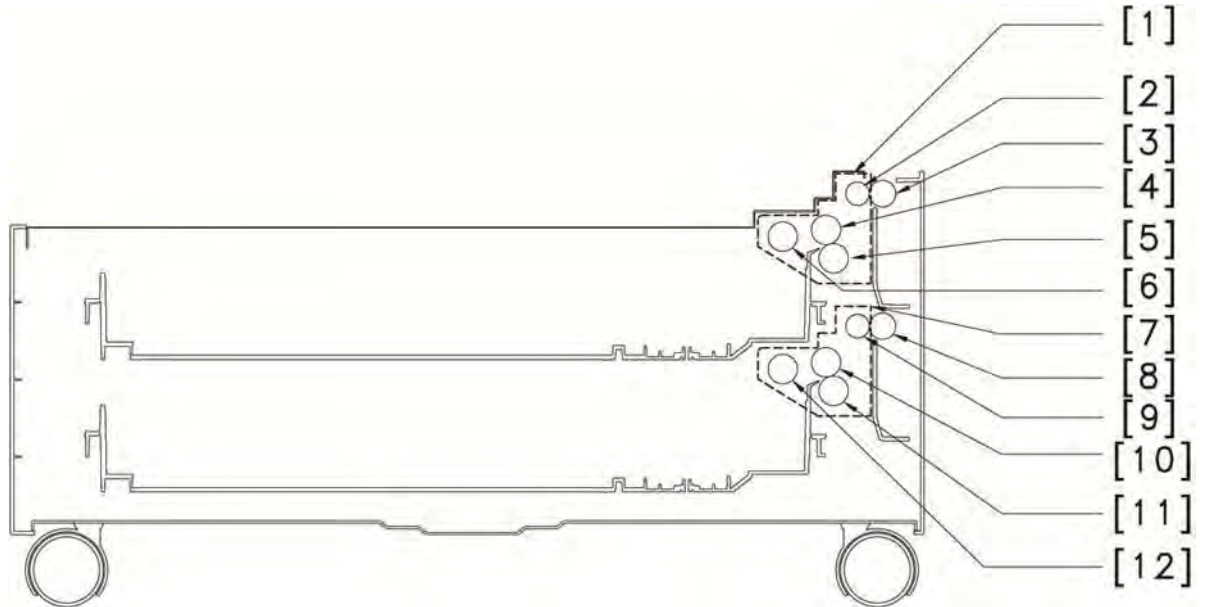
# Dual cassette feeder (DCF)

Learn about the dual cassette feeder.

The DCF is an optional device that stores additional paper.

## DCF front sectional view

Figure 1-89 DCF front sectional view

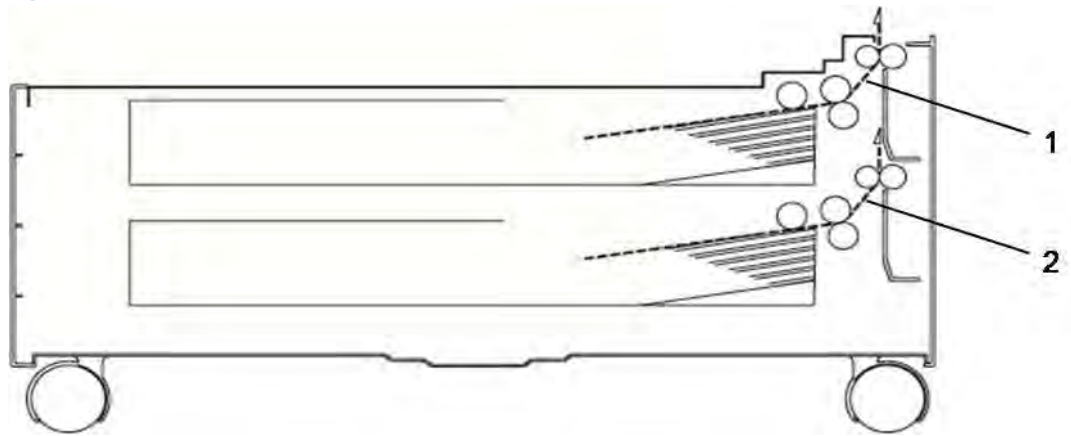


Item	Description	Item	Description
1	Global HCI to tray	7	HCI 4 pickup assembly
2	Feed roller (HCI 3)	8	Feed roller (HCI 4)
3	Idle roller (HCI 3)	9	Idle roller (HCI 4)
4	Feed roller (HCI 3)	10	Feed roller (HCI 4)
5	Separation roller (HCI 3)	11	Separation roller (HCI 4)
6	Pick roller (HCI 3)	12	Pick roller (HCI 4)



## DCF paper path

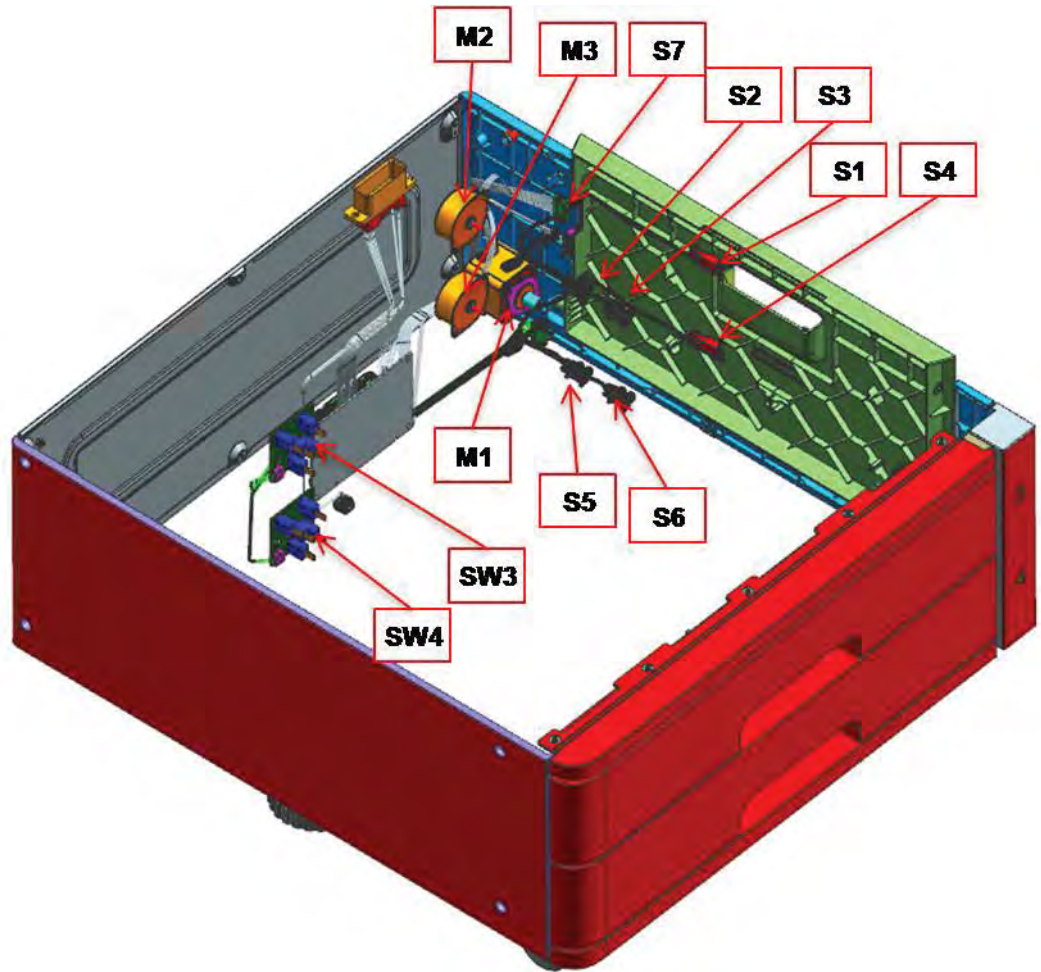
Figure 1-90 DCF paper path



Item	Description
1	Tray 4 paper path
2	Tray 5 paper path

## DCF electrical parts locations

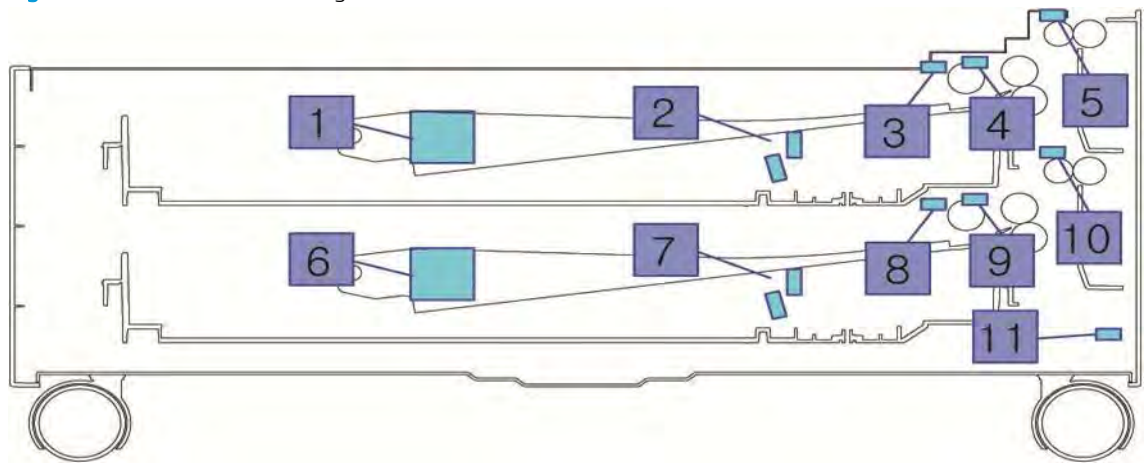
Figure 1-91 DCF electrical parts locations



Item	Description	Part number	DC controller PCA	Item	Description	Part number	DC controller PCA
M1	Feed motor	JC31-00033B	CN5 3 to 6	S2	Tray 4 limit sensor	0604-00138 1	CN6 4 to 6
M2	Tray 4 pickup motor	JC31-00149A	CN5 9 to 12	S3	Tray 4 paper empty sensor	0604-00139 3	CN6 1 to 3
M3	Tray 5 pickup motor	JC31-00149A	CN5 13 to 16	S4	Tray 5 feed sensor	0604-00138 1	CN6 16 to 18
SW3	Tray 4 auto-size switch	JC32-00013A	CN9 1 to 4	S5	Tray 5 limit sensor	0604-00138 1	CN6 13 to 15
SW4	Tray 5 auto-size switch	JC32-00013A	CN9 5 to 8	S6	Tray 5 paper empty sensor	0604-00138 1	CN6 10 to 12
S1	Tray 4 feed sensor	0604-00138 1	CN6 7 to 9	S7	Door open sensor	JC39-01696A	CN3 1 to 2

## DCF sensor and signal

Figure 1-92 DCF sensor and signal



Item	Sensor	Signal
1	P_Size_DCF 1	Tray 4 paper size analog signal
3	nP_Empty_DCF 1_IHCF	Tray 4 paper empty signal
4	Limit_DCF 1_IHCF	Tray 4 paper limit signal
5	Feed_DCF 1_IHCF	Tray 4 feed signal
6	P_Size_DCF 2	Tray 5 paper size analog signal
8	nP_Empty_DCF 2	Tray 5 paper empty signal
9	Limit_DCF 2	Tray 5 paper limit signal
10	Feed_DCF 2	Tray 5 feed signal
11	nDoor_open	Door open signal

## DCF PCA connection

Figure 1-93 DCF PCA connection

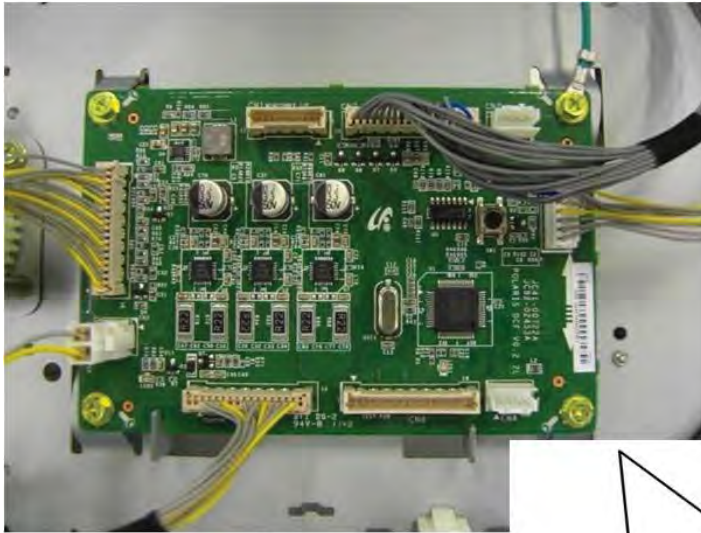
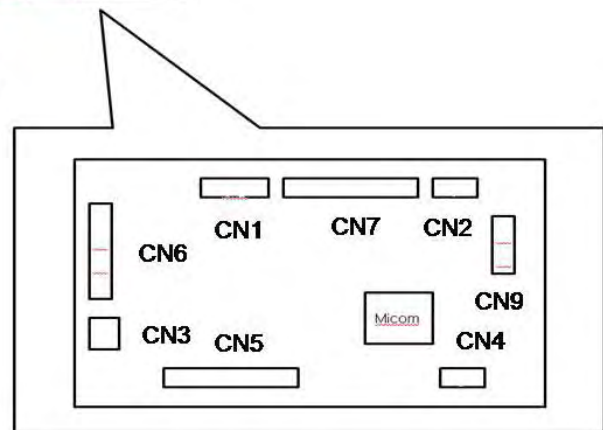


Figure 1



Connector number	Connection
CN1	Download tool I/F (minicube)
CN2	Debug I/F
CN3	Cover open switch (24V interlock switch)
CN4	USB I/F
CN5	EMPTY/LIFT/FEED (Tray 4 and 5) sensor
CN6	FEED/PICKUP 3, 4 motor
CN7	Interface with main
CN9	Paper size sensor (Tray 4 and 5)

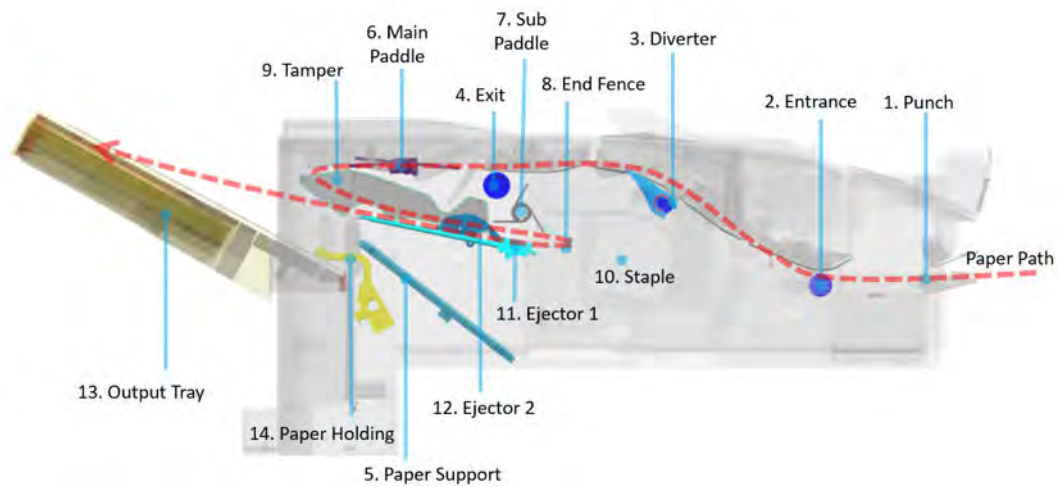
## Inner finisher

Learn about the inner finisher.

The inner finisher is an optional device that stores additional paper.

## Inner finisher sectional view

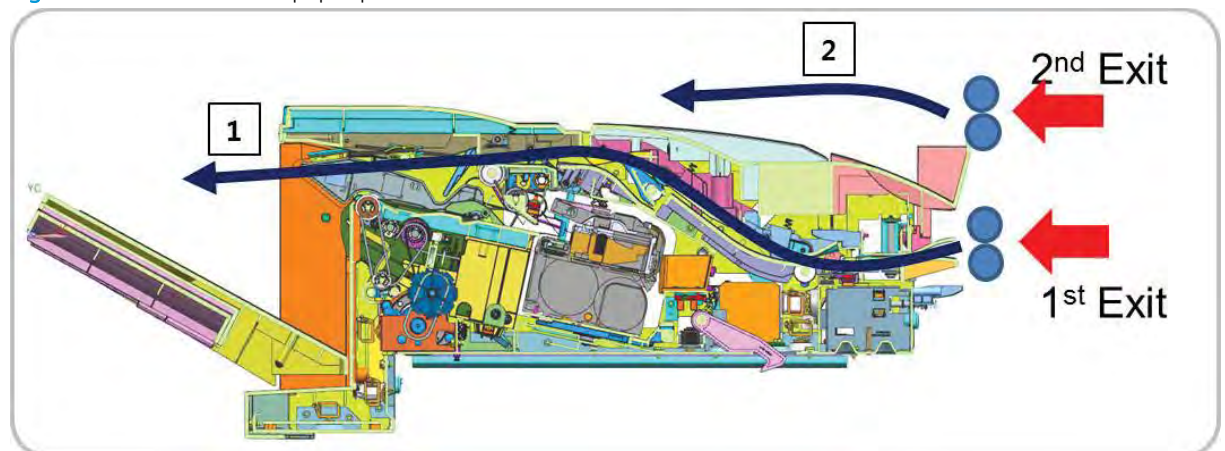
Figure 1-94 Inner finisher sectional view



Item	Description	Item	Description
1	Punch unit	8	End fence unit
2	Entrance unit	9	Tamper unit
3	Diverter unit	10	Stapler unit
4	Exit unit	11	Ejector 1 unit
5	Paper support unit	12	Ejector 2 unit
6	Main paddle unit	13	Output tray unit
7	Sub paddle unit	14	Paper holding unit

## Inner finisher paper path

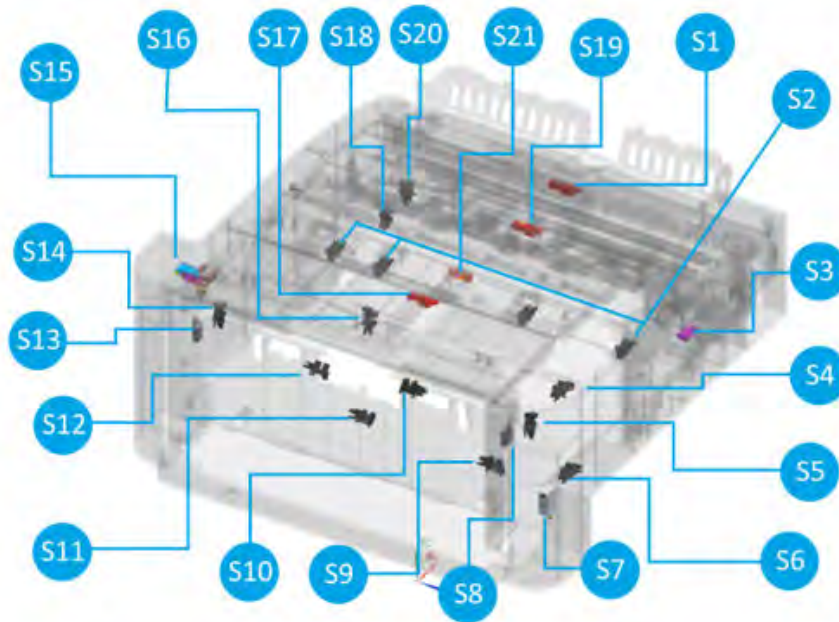
Figure 1-95 Inner finisher paper path



Item	Description
1	Finisher main tray — staple/offset/punch
2	Finisher top tray — stack only

## Inner finisher electrical parts locations

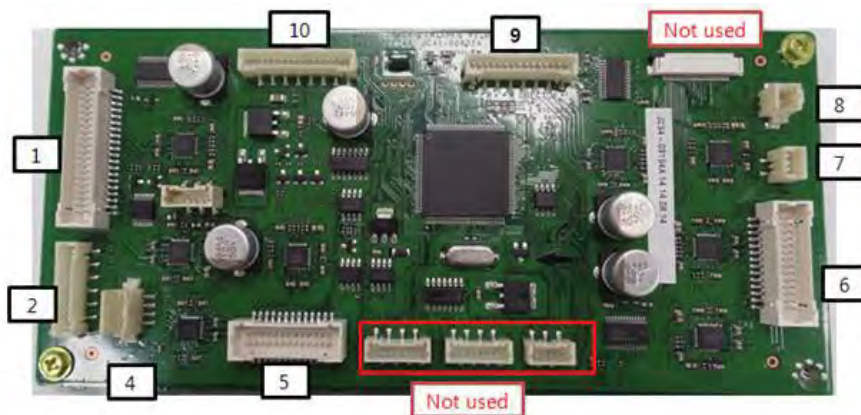
Figure 1-96 Inner finisher electrical parts locations



Item	Description	Part number	Item	Description	Part number
S1	Stapler position sensor	0604-001381	S12	Paper support home sensor	0604-001393
S2	Stapler position sensor	0604-001393	S13	Output tray top of stack sensor (LED)	0601-003440
S3	Front cover switch	JC39-01610A	S14	Rear tamper home sensor	0604-001393
S4	Main paddle home sensor	0604-001393	S15	Top cover switch	JC39-01610A
S5	Front tamper home sensor	0604-001393	S16		0604-001393
S6	Output tray motor sensor	0604-001393	S17	End fence sensor	0604-001381
S7	Output tray lower limit switch	JC90-01320A	S18	Punch waste box sensor	0604-001393
S8	Output tray top of stack sensor (receiver)	0603-001309	S19	Punch waste full sensor	0604-001381
S9	Paper holding sensor	0604-001393	S20	Finisher docking sensor	0604-001393
S10	Ejector 2 home sensor	0604-001393	S21	Exit sensor	0604-001415
S11	Ejector 2 motor sensor	0604-001393			

## Inner finisher PCA connection

Figure 1-97 Inner finisher PCA connection



Connector number	Connection
1	CN3: REAR joint I/F
2	CN1: REAR sensor
3	CN10: Traverse mid sensor
4	CN8: Debug
5	CN2: REAR I/F
6	CN7: FRONT I/F
7	CN6: Stacker switch
8	CN9: Solenoid
9	CN4: Ejector and supporter I/F
10	CN5: Main I/F





---

## 2 Parts, diagrams, removal and replacement

Learn about parts, diagrams, removal and replacement.

### HP service and support

Learn about HP access to additional service and support information.

#### Additional service and support for channel partners

Channel partners go to [partner.hp.com](http://partner.hp.com), and then use the steps below to access the HP Web-based Interactive Search Engine (WISE).

#### Access WISE for Channel partners

1. Select [Services & Support](#) (near the top of the screen).
2. Under [Services Delivery](#), select [Technical Support](#).
3. Select [Technical Documentation](#).

#### Find information about the following topics

- Service manuals
- Service advisories
- Up-to-date control panel message (CPMD) troubleshooting
- Solutions for printer issues and emerging issues
- Remove and replace part instructions and videos
- Install and configure
- Printer specifications
- Warranty and regulatory information

#### Additional service and support for HP internal personnel

HP internal personnel, go to one of the following Web-based Interactive Search Engine (WISE) sites:

## Americas (AMS)

- [WISE - English](#)
- [WISE - Spanish](#)
- [WISE - Portuguese](#)
- [WISE - French](#)

## Asia Pacific / Japan (APJ)

- [WISE - English](#)
- [WISE - Japanese](#)
- [WISE - Korean](#)
- [WISE - Chinese \(simplified\)](#)
- [WISE - Chinese \(traditional\)](#)
- [WISE - Thai](#)

## Europe / Middle East / Africa (EMEA)

- [WISE - English](#)

# How to search for printer documentation

Find printer documentation using the internal HP portals.

The CPMD, error codes, and other support documentation for each printer is found on the internal HP portals [GCSN](#) and [WISE](#) (formerly SAW). GCSN is available to HP channel partners and WISE is available to call agents, service technicians, and other HP internal users. The level of detail available will depend on your access credentials.

## How to search WISE for printer documentation

These instructions are for HP internal use by call agents, service technicians, and other internal users. [View a video of how to find support content in WISE.](#)

To view a list of control panel message documents per printer in WISE, enter document ID **c05048451**, to locate CPMD list.

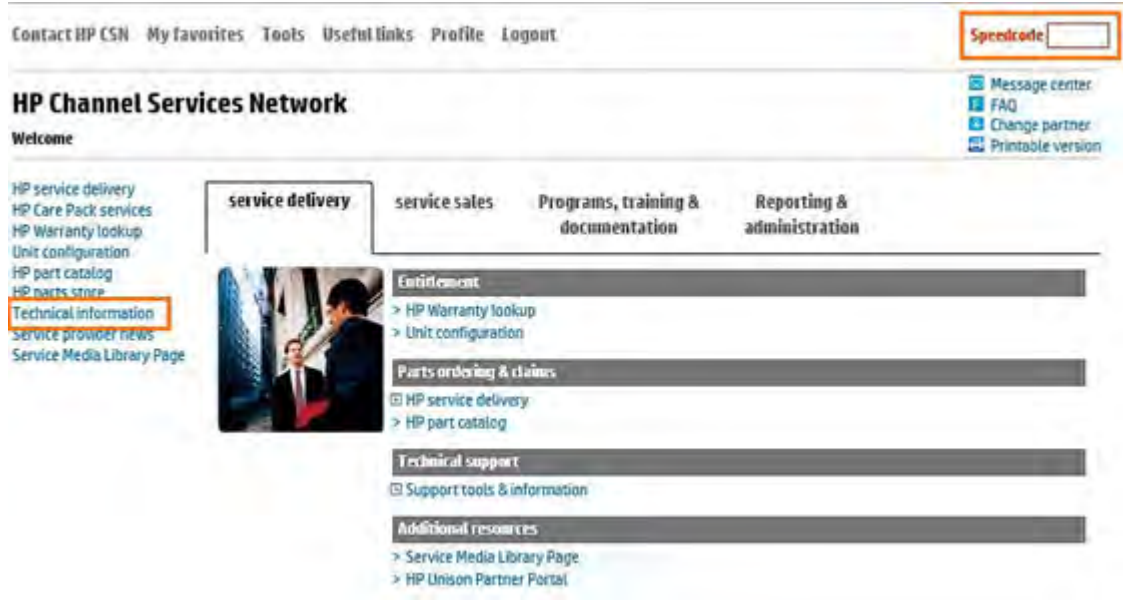
Go to WISE and enter this document ID **c05791539** for written instructions.

## How to search GCSN for printer documentation

These instructions are for internal use by HP Channel Partners. [View a video of how find support content in GCSN](#), or follow the steps below.

1. On the Home screen in GCSN, open **Technical information** using one of the following two methods:
  - Type **TINF** in the **Speedcode** field found in the upper right corner and press **Enter**, or
  - On the Home page, click **Technical information** in the left pane.

Figure 2-1 GCSN home page



2. Under **Product Search**, select the **Type**, **Category**, **Family**, and **Series** that match your product model (leave the **Model** field as blank or the default).


 **NOTE:** Make sure to login to GCSN using your service-qualified credentials to access the most comprehensive content list available. To find out how to become service-qualified, contact your HP representative.

Figure 2-2 Sample product search criteria (GCSN)

**Product Search** [Add Favorites](#)

**Type**  
Printers and Multifunction

**Category**  
Multifunction and All-in-One

**Family**  
HP LaserJet MFP and All-in-One Products

**Series**  
HP Color LaserJet Enterprise MFP M682 series

**Model**  
Select a Model

- Click **Add Favorites** and then click **Add** to add the printer to your Favorites list and allow you to bypass the **Product Search** fields next time for that particular model (optional).

Figure 2-3 Add favorites (GCSN)

The screenshot shows a section titled 'Product Search' with a blue 'Add Favorites' button. Below the button are three dropdown menus: 'Type' set to 'Printers and Multifunction', 'Category' set to 'Multifunction and All-in-One', and 'Family' set to 'HP LaserJet MFP and All-in-One Products'.

- Clear all of the high-level check boxes.

Figure 2-4 Clear search criteria (GCSN)

The screenshot shows a list of search criteria checkboxes under the heading 'Select the appropriate check boxes for the document types you wish to review.' The high-level categories 'Support Communications', 'Manuals and Guides', and 'Support Information' are highlighted with orange boxes. All individual checkboxes under these categories are unchecked.

- Select the check boxes for the document types for which you want to search.

 **NOTE:** Select only the high-level **Manuals and Guides** search option if you are not sure in which type of manual or guide the content might be listed.

Figure 2-5 Select search criteria (GCSN)

The screenshot shows the same search criteria checkboxes as Figure 2-4. In this view, several checkboxes are selected (checked) and highlighted with orange boxes: 'Maintenance/Service Guide', 'Service Guide/Manual', 'User Guide', 'CPMMap', and 'Support Information'.

- Select **Submit**.
- If needed, click **Back To selection Criteria** and narrow your search (the maximum allowed search result is 100 documents).



**NOTE:** Do not select the **Top Issue** option unless you only want to view top issues for that model. All other available content is filtered out.

**Table 2-1** Information type selections

Technical information type	Select this checkbox
Control panel message document (CPMD)	CPMD-Map
List of all CPMDs per product	Support Information
Installation Guide or Hardware Install Guide	Maintenance/Service Guide or Install Guide
Service cost document	Install Guide or Service Guide/Manual
Service guide or Service manual	Service Guide/Manual
Self-solve or troubleshooting document	Support Information
User manual or User guide	User Guide
Warranty and Legal Guide	Warranty Statement

## Order parts by authorized service providers

Find information about ordering parts and supplies for the printer.

### Ordering

Order parts by authorized service providers.

**Table 2-2 Ordering**

Item or provider	Description
Order supplies and paper	<a href="http://www.hp.com/go/suresupply">www.hp.com/go/suresupply</a>
Order parts from authorized service providers	<a href="http://www.hp.com/buy/parts">www.hp.com/buy/parts</a> or <a href="http://partsurfer.hp.com">partsurfer.hp.com</a>
Order through service or support providers	Contact an HP-authorized service or support provider.
Order using the HP Embedded Web Server (EWS)	To access, in a supported web browser on your computer, enter the printer IP address or host name in the address/URL field. The EWS contains a link to the HP SureSupply web site, which provides options for purchasing Original HP supplies.

### Orderable parts

Not all of the parts shown in the exploded assembly diagrams are orderable parts.


Refer to the tables following the diagrams or the alphabetical/numerical parts lists to determine if a part is orderable.


## How to use parts lists and diagrams

Learn how to use the parts lists and diagrams.

The figures in this chapter show the major sub-assemblies in the printer and their component parts. A parts list table follows each exploded view assembly diagram. The table lists the item number, the associated part number, and the description of each part. If a part is not listed in the table, then it is not a field replacement unit (FRU).

---

 **NOTE:** Be sure to order the correct part. When looking for part numbers for electrical parts, pay careful attention to the voltage that is listed in the part description. Doing so will make sure that the selected part number is for the correct printer model.

 **NOTE:** The abbreviation “PCA” stands for “printed circuit-board assembly.” Components described as a PCA might consist of a single circuit board or a circuit board plus other parts, such as cables and sensors.

---

## ESD precautions

Learn the importance of electrostatic discharge.

**CAUTION:**

Some parts are sensitive to electrostatic discharge (ESD). Look for the ESD reminder when removing printer parts. Always perform service work at an ESD-protected workstation or mat. If an ESD workstation or mat is not available, touch the sheet-metal chassis to provide a static ground *before* touching an ESD-sensitive assembly.

Protect the ESD-sensitive assemblies by placing them in ESD pouches when they are out of the printer.

---

# Service approach

Learn more about the service approach.

## Precautions when replacing parts

Learn about precautions when replacing parts.

### Precautions when assembling and disassembling

- Use only HP approved replacement parts. Make sure that the part number, product name, voltage, and current or temperature ratings are correct. Failure to do so might result in damage to the machine, circuit overload, fire, or electric shock.
- Do not make unauthorized changes or additions to the printer. Unauthorized changes might cause the printer to malfunction and create electric shock or fire hazards.
- Use caution when dismantling the unit. Take note of the location of each screw or other part. This printer contains different kinds of screws. Using the wrong screw might lead to system failure, short circuit or electric shock.
- Do not disassemble the laser scanner assembly. Once the laser scanner assembly is disassembled, dust might enter the mirror chamber and will seriously degrade print quality. There are no serviceable parts inside the laser scanner assembly.
- Regularly check the condition of the power cable, plug and socket. Bad contacts might lead to overheating and fire. Damaged cables might lead to electric shock or unit malfunction.

### Precautions when handling PCAs

Static electricity might damage a PCA. Use approved, anti-static precautions when handling or storing a PCA. Service personnel should use grounded ESD straps and/or mats when handling PCAs.

- Precautions when moving and storing a PCA
  - Keep PCA in a conductive case, anti-static bag, or wrapped in aluminum foil.
  - Do not store a PCA where it is exposed to direct sunlight.
- Precautions when replacing a PCA
  - Disconnect power cables before disconnecting other cables.
  - Do not touch any soldered connections, connector terminals, or other electronic parts when handling insulated parts.
- Precautions when checking a PCA
  - Touch a grounded area of the printer chassis to discharge static electric charge before touching a PCA.
  - Do not touch a PCA with bare hands or metal objects. Doing so might create a short circuit or cause electric shock. Use caution when handling a PCA with moving parts such as sensors, motors, or lamps, as they might become very hot.



- Use caution when fitting and removing screws. Watch for hidden screens. Make sure that the correct screw is used and make sure that when toothed washers are removed, they are refitted in their original positions.
- Place the product on an ESD workstation or mat, or use an ESD strap (if one is available). If an ESD workstation, mat, or strap is not available, ground yourself by touching the sheet-metal chassis *before* touching an ESD-sensitive part.

### Releasing plastic latches

Many of the parts are held in place with plastic latches. The latches might easily break. Be careful when releasing them. To remove such parts, press the hook end of the latch away from the part to which it is latched.

### Before performing service

Learn what to do before performing service.

- Press the power button on the front of the printer, and then turn off the power switch next to the power cable.
- Unplug the power cable and interface cable or cables.
- Remove any finishing devices and the side HCI, if they are installed.
- Place the product on an ESD workstation or mat, or use an ESD strap (if one is available). If an ESD workstation, mat, or strap is not available, ground yourself by touching the sheet-metal chassis *before* touching an ESD-sensitive part.
- Remove the toner cartridges, if needed.

### After performing service

Learn what to do after performing service.

- Verify that the service performed was successful.
- Verify that the most recent firmware is installed on the printer.
- Verify that all parts are correctly reinstalled and are properly working.
- Print any pages necessary to verify that the repair resolved the issue and did not create any new issues.
- Verify that the printer is in better condition than when you arrived, cosmetically and electrically.

## Post-service test

Perform the following tests to verify that the repair or replacement was successful:

### Print-quality test

Learn about the print-quality test.

1. Verify that you have completed the necessary reassembly steps.
2. Make sure that the tray contains clean, unmarked paper.
3. Attach the power cord and interface cable or interface cables, and then turn on the product.
4. Print a configuration page.
5. Print a print quality page, and then verify that there are no lines, streaks, banding, or other print quality defects.
6. Send a print job from the host computer, and then verify that the output meets expectations.

### Copy-quality test

Learn about the copy-quality test.

1. Place the configuration page in the document feeder, print a copy job, and then verify the results.
2. Place the configuration page on the flatbed glass, print a copy job, and then verify the results

### Fax-quality test

Learn about the fax-quality test.

1. Place the configuration page in the document feeder.
2. Type a valid fax number, and send the fax job.
3. Verify that the send quality and the receive quality meet expectations.

### Parts removal order

For procedures and/or steps that require identifying the right, left, or rear side of the printer, face the front of the printer for correct orientation.

## Maintenance (printer cleaning)

Learn about printer cleaning for maintenance.

### Cleaning the document feeder white bar and CIS (LX)

Learn about cleaning the document feeder white bar and CIS (LX).

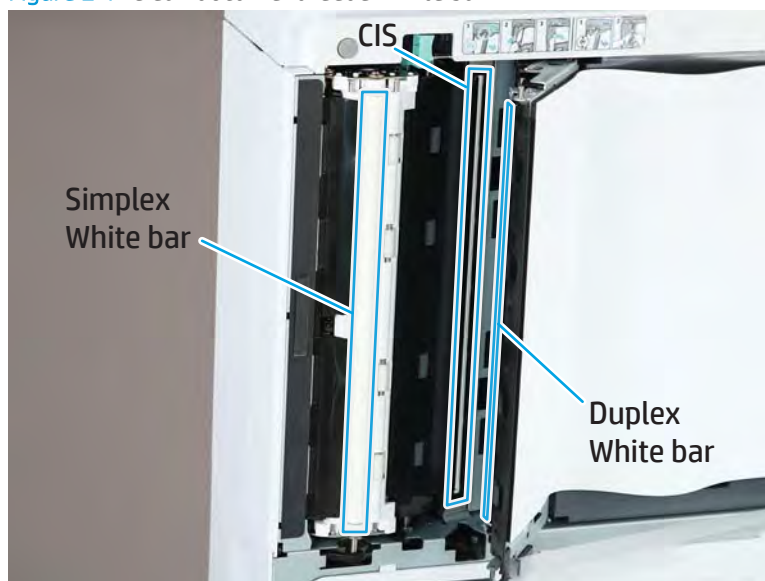
1. Open the document feeder unit.

Figure 2-6 Open document feeder unit



2. Clean the document feeder white bar and CIS using a lint-free cloth.

Figure 2-7 Clean document feeder white bar

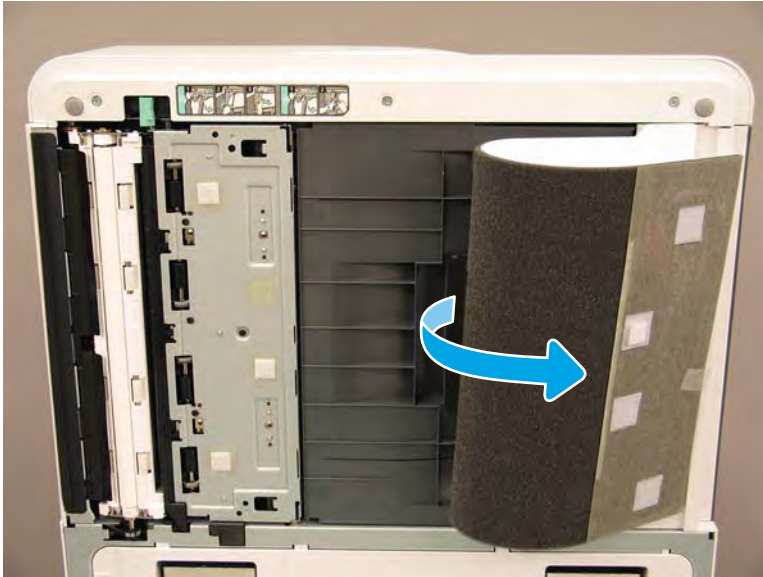


## Cleaning the flow document feeder white bar and CIS (GX)

Learn about cleaning the flow document feeder white bar and CIS (GX).

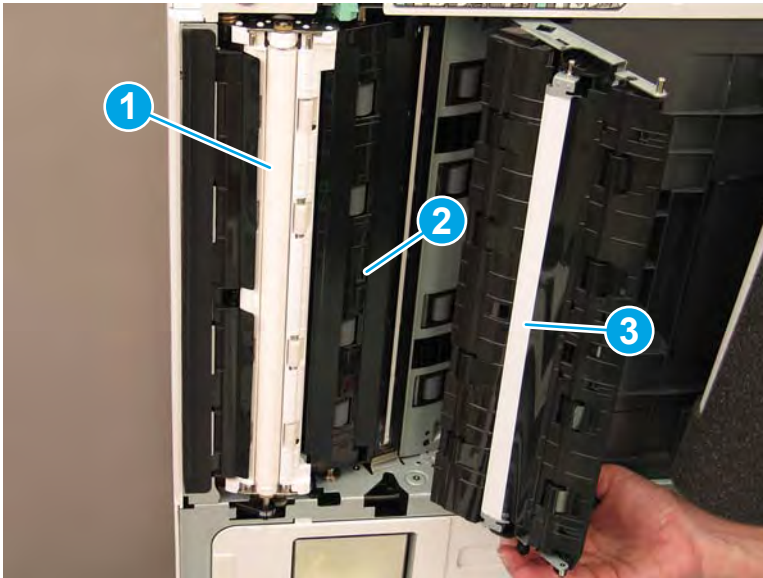
1. Open the document feeder, peel back the white backing, and then release the green tab.

**Figure 2-8** Peel back the white backing and release one tab



2. Open the access door. Clean the simplex white bar (callout 1), the CIS (callout 2), and the duplex white bar (callout 3) using a soft, lint-free, clean cloth.

**Figure 2-9** Clean flow document feeder white bar



## Cleaning the scanner glass

Learn about cleaning the scan glass.

- ▲ Open the document feeder. Clean the scanner glass (callout 1) using a soft, lint-free, clean cloth.

Figure 2-10 Clean the scanner glass (1 of 2)

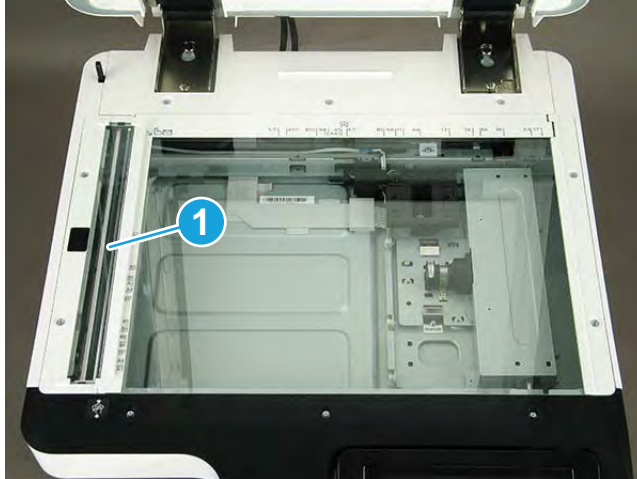


Figure 2-10 Clean the scanner glass (2 of 2)



## Cleaning the transfer roller

Learn about cleaning the transfer roller.

1. Open the right door.

Figure 2-11 Open the right door



2. Clean the transfer roller (A) using a lint-free cloth.

Figure 2-12 Transfer roller cleaning



## Cleaning the color toner density (CTD) sensor

Learn about cleaning the color toner density (CTD) sensor.

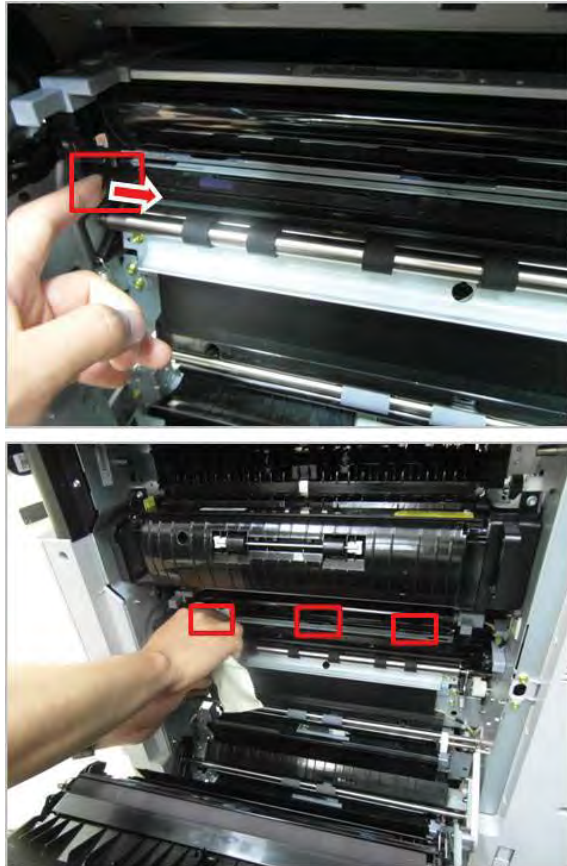
1. Open the right door.

Figure 2-13 Open the right door



2. Clean the sensor window using a lint-free cloth while pushing the shutter to the right.

Figure 2-14 Clean sensor window



3. Do the following:

1. Close the right door.
2. Enter service mode, and then select **CTD Sensor Cleaning** (Diagnostics ► Image Management ► Auto Tone Adjustment ► CTD Sensor Cleaning).
3. When the confirmation screen appears, select **Yes**.



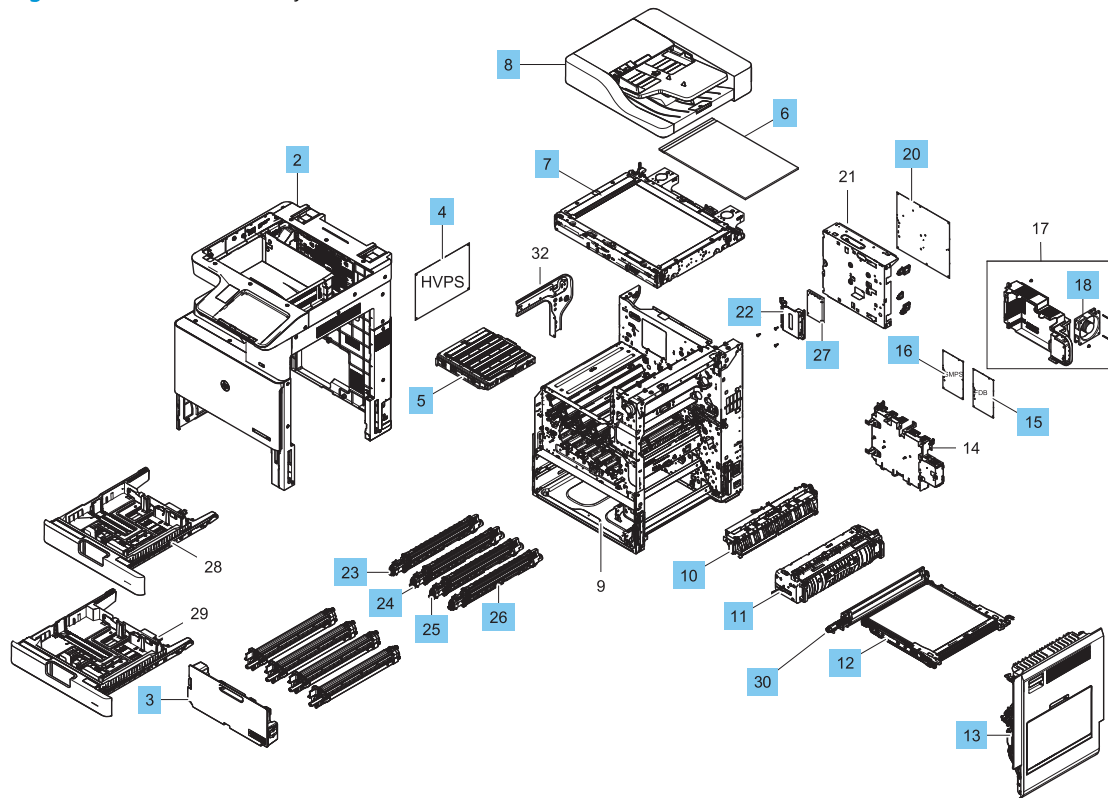
## Main parts

Learn about the printer main parts.

## Main assembly

Parts diagram and parts list for the main assembly.

Figure 2-15 Main assembly



**Table 2-3 Main assembly**

Ref	Part number	Description	Qty
No			
2	JC96-02090A	Cover, top	1
3	X3A83-67923	Toner Collection Unit (TCU)	1
4	JC44-00212C	HVPS 24 (For E77822, E77825, E77830)	1
4	JC44-00212D	HVPS 24 (For E78323, E78325, E78330)	1
5	JC97-04864A	Laser scanner unit	1
6	JC63-05410A	ADF White backing (LX/dn bundles)	2
6	JC63-05795A	ADF White backing (GX/z bundles)	1
7	JC97-04520C	Scanner assembly	1
8	JC97-04954A	ADF, whole unit (LX/dn models only)	1
8	JC97-04955A	Flow ADF, whole unit (GX/z models only)	1
10	JC90-01118B	Exit	1
11	JC82-00485A	Fuser, 220V (For E77822, E77825, E77830)	1
11	X3A64-61002	Fuser, 220V (For E78323, E78325, E78330)	1
11	JC82-00472A	Fuser, 110V (For E77822, E77825, E77830)	1
11	X3A64-61001	Fuser, 110V (For E78323, E78325, E78330)	1
12	JC98-00980D	Image Transfer Belt Assembly (For E77822, E77825, E77830)	1
12	5PN63-67001	Image Transfer Belt Assembly (For E78323, E78325, E78330)	1
13	JC95-02079A	Right door assembly (For E77822, E77825, E77830)	1
13	8GR88-60101	Right door assembly (For E78323, E78325, E78330)	1
15	8GR94-60002	Fuser drive board, 220V	1
15	8GR94-60001	Fuser drive board, 110V	1
16	JC44-00091D	LVPS (SMPS) 110V, Type 4 <sup>1</sup>	1
16	JC44-00092D	LVPS (SMPS) 220V, Type 4 <sup>1</sup>	1
16	JC44-00249A	LVPS (SMPS) 110V, Type 5H	1
16	JC44-00250A	LVPS (SMPS) 220V, Type 5H	1
18	JC31-00162A	Fan-Type 8 LVPS	1
20	JC82-00540A	Main board PCA with heat sink (For E77822, E77825, E77830)	1
20	8GR94-60003	Main board PCA with heat sink (For E78323, E78325, E78330)	1
22	JC93-01440A	HDD Bracket	1
23	8JM72-67001	Developer unit, Y (For E78323, E78325, E78330)	1

**Table 2-3 Main assembly (continued)**

Ref			
No	Part number	Description	Qty
23	JC96-11663A	Developer unit, Y (For E77822, E77825, E77830)	1
24	8JM73-67001	Developer unit, M (For E78323, E78325, E78330)	1
24	JC96-11664A	Developer unit, M (For E77822, E77825, E77830)	1
25	8JM71-67001	Developer unit, C (For E78323, E78325, E78330)	1
25	JC96-11665A	Developer unit, C (For E77822, E77825, E77830)	1
26	8JM70-67001	Developer unit, K (For E78323, E78325, E78330)	1
26	JC96-11666A	Developer unit, K (For E77822, E77825, E77830)	1
27	5851-6712	HDD 500GB	1
30	JC96-06246A	ITB cleaner (For E77822, E77825, E77830)	1
30	5PN64-67001	ITB cleaner (For E78323, E78325, E78330)	1
Not shown	JC39-01202A	Cable, Sata, Main HDD	1
Not shown	5851-6712	Formatter HDD - 500 GB SED	1
Not shown	JC39-01943A	Cable, PWR, Main HDD	1
Not shown	B5L29-60001	PCA SATA Riser (For E77822, E77825, E77830)	1
Not shown	T3U55-60001	PCA SATA Riser ((For E78323, E78325, E78330)	1
Not shown	B5L29-67903	2.5" 500G 5400r FIPS, Yarra BP1	1
Not shown	B5L46-40014	HDD cradle	1
Not shown	X3A92-60006	Formatter PCA (For E77822, E77825, E77830)	1
Not shown	X3A92-60006	Formatter PCA Obsidian (LX) (For E78323, E78325, E78330)	1
Not shown	Y3K99-60005	Formatter PCA Rock (GX) (For E78323, E78325, E78330)	1
Not shown	6502-001131	Wire Clip Formatter	1
Not shown	B5L32-60002	eMMC card-16gb	1
Not shown	B5L46-40021	HIP Cover	1
Not shown	JC93-01538A	Formatter Cage	1
Not shown	2EH31A	HP MFP Analog 700 Fax Accessory	1
Not shown	5UT59A	HP MFP Analog Fax 701 Fax Accessory	1
Not shown	X3A92-60002	Island of Data Board	1
Not shown	JC39-02554A	Control Panel Interface Cable	1
Not shown	X3A61-60001	STMS PCA (SDS)	1
Not shown	JC39-02552A	HDMI Cable Formatter - DC Controller	1
Not shown	X3A83-67905	Imaging drum (For E77822, E77825, E77830)	1
Not shown	W9215-67901	Imaging drum (For E78323, E78325, E78330)	1

**Table 2-3 Main assembly (continued)**

Ref			
No	Part number	Description	Qty
Not shown	B5L31-90902	Foreign Interface Harness (FIH) (service)	1
Not shown	J8030-61001	Jetdirect Wireless Print Server with NFC Kit	1
Not shown	B5L29-67903	Formatter HDD - 500 GB FIPS	1
Not shown	JC93-00466A	Switch, front cover open	1
Not shown	JC93-01467A	Switch, right door open	1
Not shown	5851-6712	500 GB main disk drive assembly	1
Not shown	B5L47-60101	Control panel, Pulsar	1
Not shown	B5L47-60102	Keyboard assembly (US)	1
Not shown	B5L47-60103	Keyboard assembly (UK)	1
Not shown	JC39-02072A	Wiring harness (output device)	1
Not shown	JC64-00708B	HANDLE-SWING DEVE(Latch)	1


<sup>1</sup>Type 4 LVPS is only installed in some early models during original release. Removed from all new models.

## Removal and replacement: ADF white backing (LX)

Learn how to remove and replace the ADF white backing (LX).

This document provides the procedures to remove the white backing assembly.

 [View a video of how to remove and replace the document feeder white backing \(LX\).](#)

 **IMPORTANT:** When applicable, special installation instructions are provided for an assembly at the end of the removal procedure. Always completely read the removal instructions and follow all special installation instructions.


Mean time to repair:

Service level:

### Before performing service

#### Turn the printer power off

- Press the power button on the front of the printer, and then turn off the power switch next to the power cable.
- A shutting-down message appears on the control-panel display.

 **WARNING!** To avoid damage to the printer, turn the power off and wait until the printer shuts down before removing the power cable.

- Disconnect the printer power cable after the printer has completely shut down (the control-panel display is blank).

Use the table below to identify the correct part number for your printer. To order the part, go to [www.hp.com/buy/parts](http://www.hp.com/buy/parts).

Table 2-4 Part information

Part number	Part description
JC63-05410A	ADF white backing (LX)

### Required tools

- No special tools are required to remove or install this assembly.

### After performing service

#### Turn the printer power on

- Connect the printer power cable.
- Turn on the power switch next to the power cable, and then press the power button on the front of the printer.
- Verify that the service performed was successful.

- Verify that the most recent firmware is installed on the printer.
- Verify that all parts are correctly reinstalled and are properly working.

### Post service test

Print any pages necessary to verify that the repair resolved the issue and did not create any new issues.

### Remove the document feeder white backing

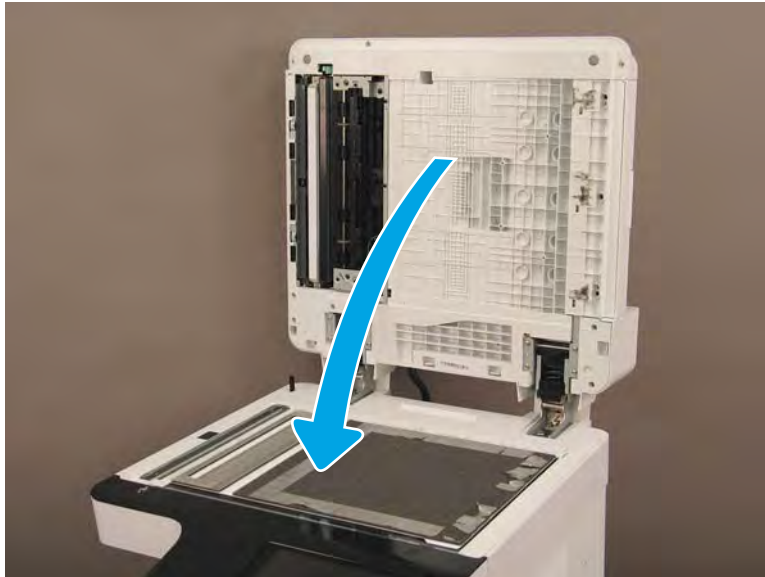
Follow these steps to remove the document feeder white backing.

1. Open the document feeder cover.
2. Peel the white backing away to remove.

 **IMPORTANT:** Remove all the tape and foam from the bottom of the document feeder.

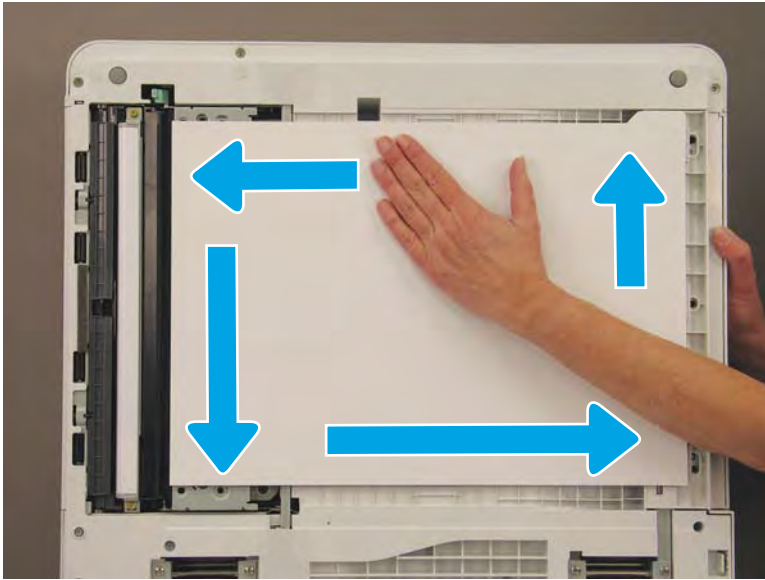
3. Position the new white backing on the scanner glass.
4. Peel the adhesive tape backing off the new white backing.
5. Close the document feeder cover to attach the white backing.

**Figure 2-16** Close the document feeder cover



6. Open the cover again and smooth the white backing.

Figure 2-17 Smooth the white backing



## Unpack the replacement assembly



Follow these steps to unpack the replacement assembly.


1. Dispose of the defective part.


 **NOTE:** HP recommends responsible disposal of the defective part.

<http://www8.hp.com/us/en/hp-information/environment/product-recycling.html>


2. Unpack the replacement part from the packaging.

 **CAUTION:**  Some parts are sensitive to electrostatic discharge (ESD). Always perform service work at an ESD-protected workstation or mat. If an ESD workstation or mat is not available, touch the sheet-metal chassis to provide a static ground before touching an ESD-sensitive assembly. Protect the ESD-sensitive assemblies by placing them in ESD pouches when they are out of the printer.

 **IMPORTANT:** Make sure that all of the shipping materials (for example shipping tape) are removed from the replacement part prior to installation.

 **NOTE:** If the replacement part is a roller or pad, avoid touching the spongy part of it. Skin oils on the roller or pad can cause paper pickup and/or print-quality problems. HP recommends using disposable gloves when handling rollers or pads or washing your hands before touching rollers or pads.

3. To install an assembly, reverse the removal steps.


 **NOTE:** When applicable, special installation instructions are provided for an assembly at the end of the removal procedure. Always completely read the removal instructions and follow all special installation instructions.



## Removal and replacement: ADF white backing (GX)

This document provides the procedures to remove the white backing assembly.

E72520-E72530:


 [https://players.brightcove.net/1160438706001/SyKVJeRXx\\_default/index.html?videoId=ref:REFIDPH0000000337](https://players.brightcove.net/1160438706001/SyKVJeRXx_default/index.html?videoId=ref:REFIDPH0000000337)

E77820-E77830:

Mean time to repair: 10 minutes

Service level: Basic

---

 **IMPORTANT:** When applicable, special installation instructions are provided for an assembly at the end of the removal procedure. Always completely read the removal instructions and follow all special installation instructions.

---

### Before performing service

- Disconnect the power cable.

Use the table below to identify the correct part number for your printer. To order the part, go to [www.hp.com/buy/parts](http://www.hp.com/buy/parts)

**Table 2-5** Part information

Part number	Part description
JC63-05795A	ADF White backing (GX)

### Required tools

- #2 JIS screwdriver with a magnetic tip

### After performing service

#### Turn the printer power on

- Connect the power cable.
- Use the power switch to turn the power on.

### Post service test

Copy, scan, or print a document. Verify the document copies, scans, or prints correctly.

## Remove the document feeder white backing

Follow these steps to remove the document feeder white backing.

1. Open the document feeder cover.
2. Peel the white backing away to remove.

---

 **IMPORTANT:** Remove all the tape and foam from the bottom of the document feeder.

---

3. Position the new white backing on the scanner glass.
4. Peel the adhesive tape backing off the new white backing.
5. Close the document feeder cover to attach the white backing.
6. Open the cover again and smooth the white backing.

**Figure 2-18** Smooth the white backing



## Unpack the replacement assembly

Follow these steps to unpack the replacement assembly.

1. Dispose of the defective part.

---



 **NOTE:** HP recommends responsible disposal of the defective part.


<http://www8.hp.com/us/en/hp-information/environment/product-recycling.html>


---

2. Unpack the replacement part from the packaging.

---

 **CAUTION:**  Some parts are sensitive to electrostatic discharge (ESD). Always perform service work at an ESD-protected workstation or mat. If an ESD workstation or mat is not available, touch the sheet-metal chassis to provide a static ground before touching an ESD-sensitive assembly. Protect the ESD-sensitive assemblies by placing them in ESD pouches when they are out of the printer.


 **IMPORTANT:** Make sure that all of the shipping materials (for example shipping tape) are removed from the replacement part prior to installation.

 **NOTE:** If the replacement part is a roller or pad, avoid touching the spongy part of it. Skin oils on the roller or pad can cause paper pickup and/or print-quality problems. HP recommends using disposable gloves when handling rollers or pads or washing your hands before touching rollers or pads.

---

3. To install an assembly, reverse the removal steps.

---

 **NOTE:** When applicable, special installation instructions are provided for an assembly at the end of the removal procedure. Always completely read the removal instructions and follow all special installation instructions.

---

## Removal and replacement: ADF whole unit (LX)

Learn how to remove and replace the ADF whole unit (LX bundles).

To view a short video of this procedure, click the link below.



[View a video of how to remove and replace the ADF whole unit \(LX/du bundles\).](#)



**IMPORTANT:** When applicable, special installation instructions are provided for an assembly at the end of the removal procedure. Always completely read the removal instructions and follow all special installation instructions.

Mean time to repair:

Service level:

### Before performing service

#### Turn the printer power off

- Press the power button on the front of the printer, and then turn off the power switch next to the power cable.
- A shutting-down message appears on the control-panel display.



**WARNING!** To avoid damage to the printer, turn the power off and wait until the printer shuts down before removing the power cable.

- Disconnect the printer power cable after the printer has completely shut down (the control-panel display is blank).

Use the table below to identify the correct part number for your printer. To order the part, go to [www.hp.com/buy/parts](http://www.hp.com/buy/parts).

Table 2-6 Part information

Part number	Part description
JC97-05074A	Document feeder whole unit assembly (LX models)

### Required tools

- #2 JIS screwdriver with a magnetic tip

### After performing service

#### Turn the printer power on

- Connect the printer power cable.
- Turn on the power switch next to the power cable, and then press the power button on the front of the printer.
- Verify that the service performed was successful.

- Verify that the most recent firmware is installed on the printer.
- Verify that all parts are correctly reinstalled and are properly working.

### Post service test

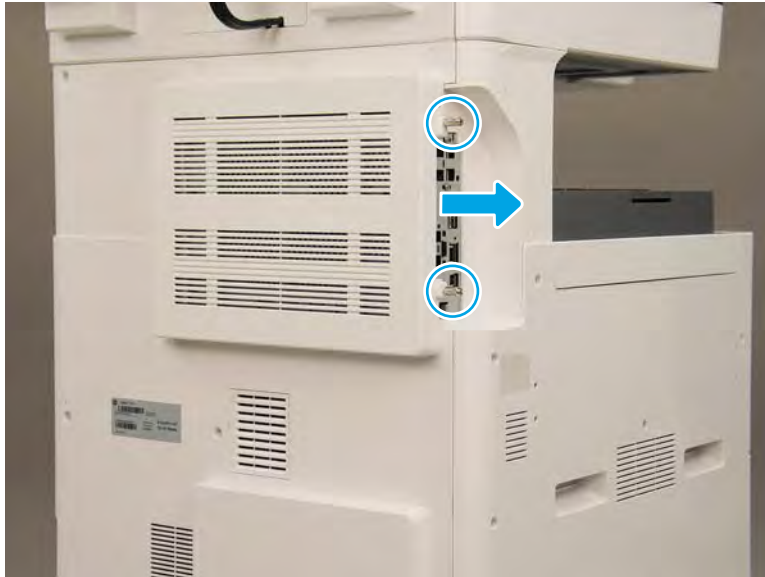
Print any pages necessary to verify that the repair resolved the issue and did not create any new issues.

### Remove the formatter cover

Follow these steps to remove the formatter cover.

- ▲ Unscrew two captive thumbscrews on the formatter cover. Slide the formatter cover to the left, and then to the right to remove it.

Figure 2-19 Remove the formatter cover

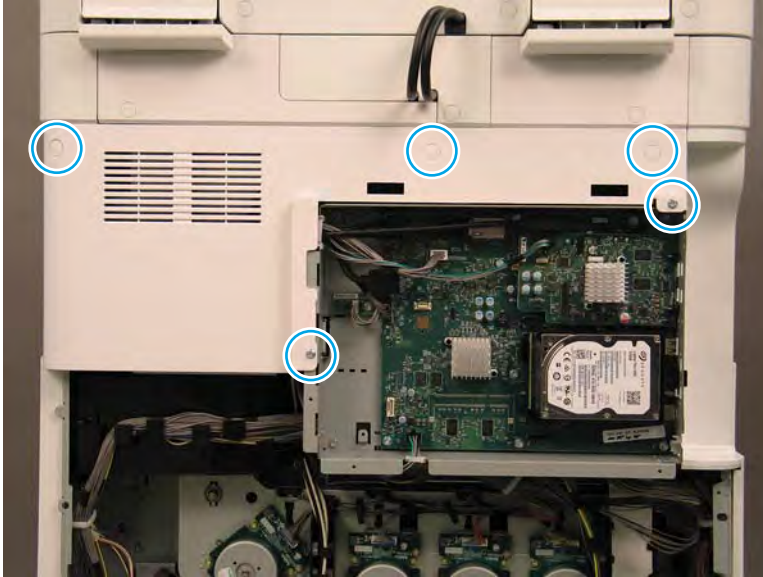


### Remove the upper rear cover

Follow these steps to remove the upper rear cover.

- ▲ Remove three screw-caps and five screws. Lift the upper rear cover away from the printer to remove it.

Figure 2-20 Remove the upper rear cover

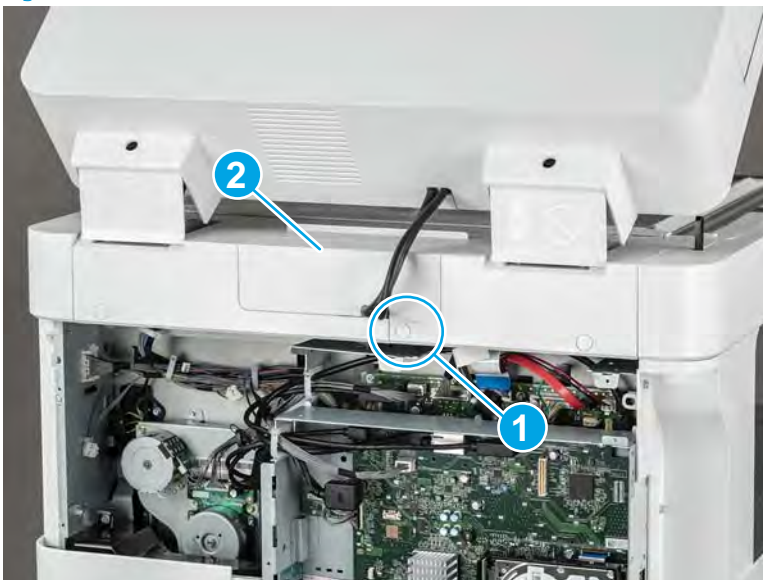


### Remove the document feeder whole unit (LX)

Follow these steps to remove the document feeder whole unit (LX).

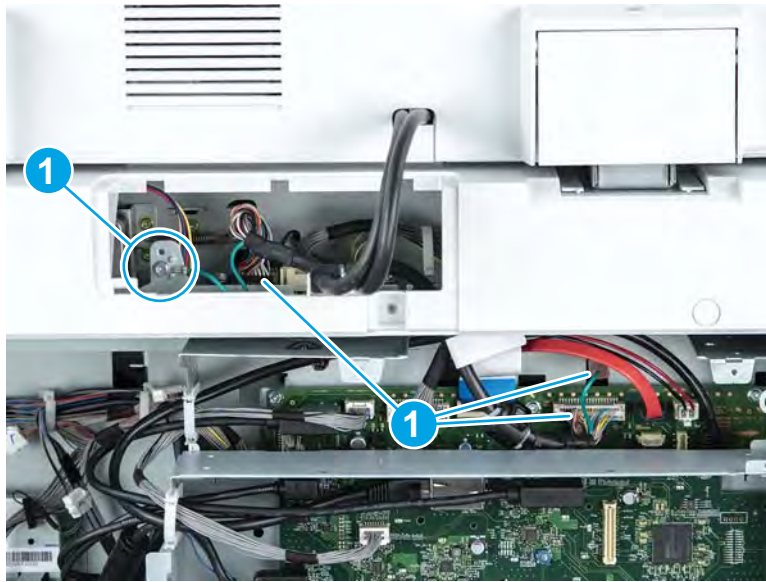
1. Remove one screw cap and screw (callout 1), and then remove the document feeder connector cover (callout 2).

Figure 2-21 Remove the document feeder connector cover



2. Remove one screw to release the ground wire (callout 1), and then disconnect three connectors (callout 2).

Figure 2-22 Remove the document feeder harness and ground wire



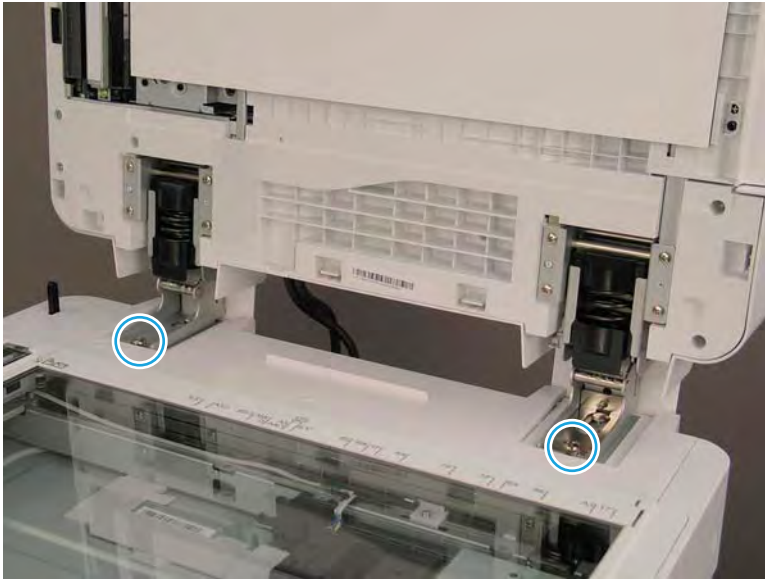
3. Disconnect the document feeder harness from the PCA - ADF HIC. Remove one connector and one grounding wire.
4. Release one screw on each hinge stop on the back of the document feeder.

Figure 2-23 Release the document feeder hinge screws



5. Remove two screws. Slide the assembly back, and then lift the document feeder to remove.

**Figure 2-24** Lift and remove the document feeder



 **NOTE:** Complete a shading test and a skew alignment after replacing the document feeder unit.

## Unpack the replacement assembly



Follow these steps to unpack the replacement assembly.

1. Dispose of the defective part.


 **NOTE:** HP recommends responsible disposal of the defective part.

<http://www8.hp.com/us/en/hp-information/environment/product-recycling.html>


2. Unpack the replacement part from the packaging.

 **CAUTION:**  Some parts are sensitive to electrostatic discharge (ESD). Always perform service work at an ESD-protected workstation or mat. If an ESD workstation or mat is not available, touch the sheet-metal chassis to provide a static ground before touching an ESD-sensitive assembly. Protect the ESD-sensitive assemblies by placing them in ESD pouches when they are out of the printer.

 **IMPORTANT:** Make sure that all of the shipping materials (for example shipping tape) are removed from the replacement part prior to installation.

 **NOTE:** If the replacement part is a roller or pad, avoid touching the spongy part of it. Skin oils on the roller or pad can cause paper pickup and/or print-quality problems. HP recommends using disposable gloves when handling rollers or pads or washing your hands before touching rollers or pads.

3. To install an assembly, reverse the removal steps.

 **NOTE:** When applicable, special installation instructions are provided for an assembly at the end of the removal procedure. Always completely read the removal instructions and follow all special installation instructions.




## Removal and replacement: Flow ADF whole unit (GX)

This document provides the procedures to remove the document feeder whole unit assembly.

Mean time to repair: 5 minutes

Service level: Basic

 **IMPORTANT:** When applicable, special installation instructions are provided for an assembly at the end of the removal procedure. Always completely read the removal instructions and follow all special installation instructions.

### Before performing service

- Disconnect the power cable.

Use the table below to identify the correct part number for your printer. To order the part, go to [www.hp.com/buy/parts](http://www.hp.com/buy/parts)

Table 2-7 Part information

Part number	Part description
JC97-04955A	ADF whole unit assembly (GX/z models)

### Required tools

- #2 JIS screwdriver with a magnetic tip

### After performing service

#### Turn the printer power on

- Connect the power cable.
- Use the power switch to turn the power on.

### Post service test

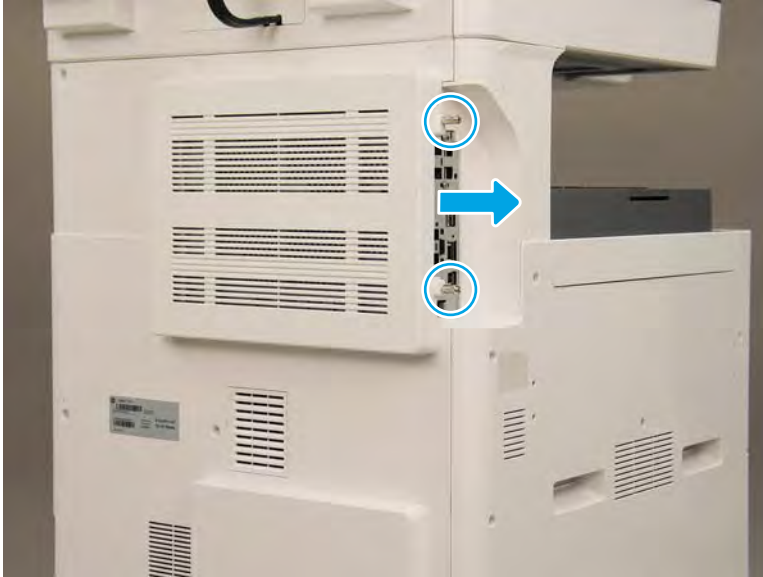
Copy, scan, or print a document. Verify the document copies, scans, or prints correctly.

### Remove the formatter cover

Follow these steps to remove the formatter cover.

- ▲ Unscrew two captive thumbscrews on the formatter cover. Slide the formatter cover to the left, and then to the right to remove it.

Figure 2-25 Remove the formatter cover

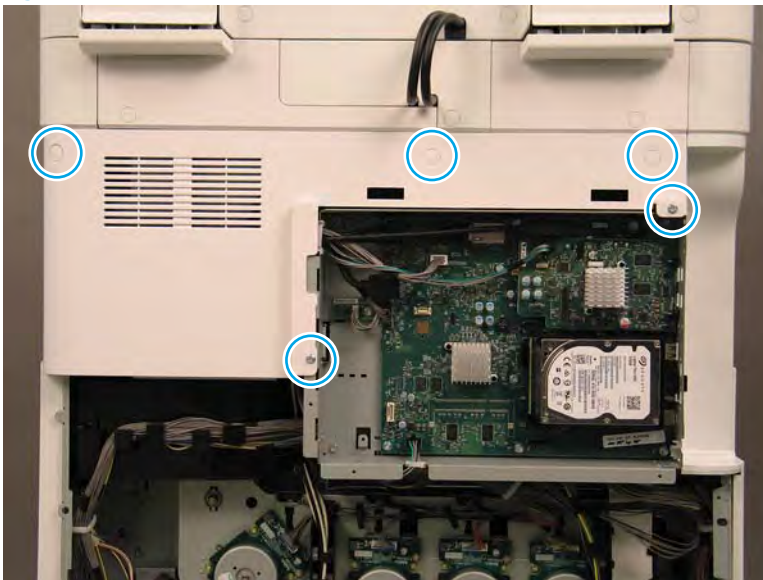


### Remove the upper rear cover

Follow these steps to remove the upper rear cover.

- ▲ Remove three screw-caps and five screws. Lift the upper rear cover away from the printer to remove it.

Figure 2-26 Remove the upper rear cover



### Remove the document feeder whole unit (GX)

Follow these steps to remove the document feeder whole unit (GX).

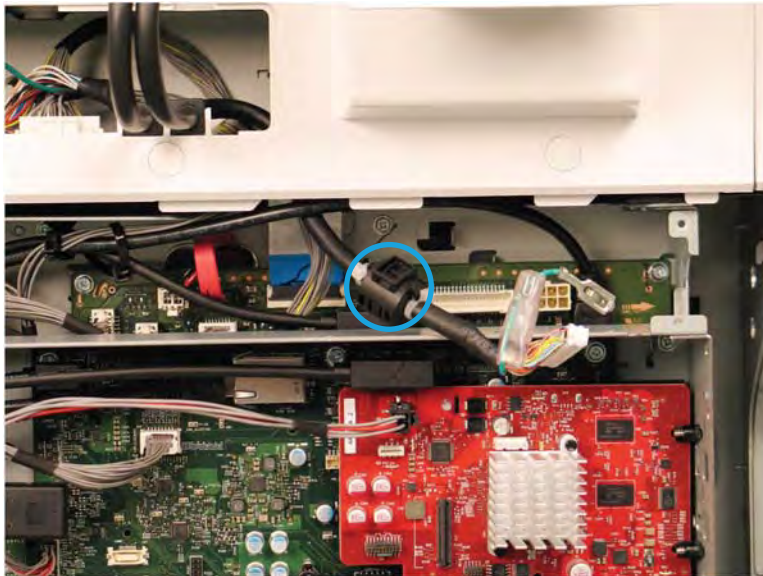
1. Open the document feeder cover, and then remove the document feeder connector cover.

Figure 2-27 Remove document feeder connector cover



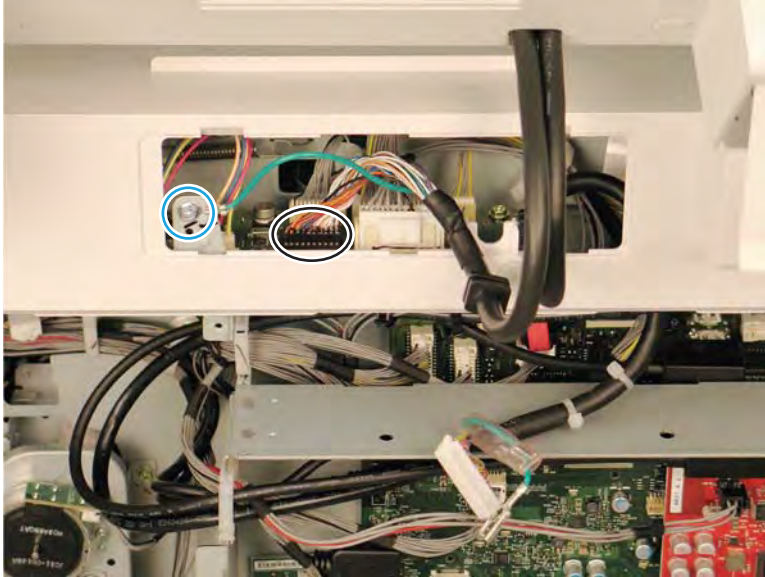
2. Remove the plastic cable choke from the wire harness, and then disconnect the document feeder harness from the main board. Disconnect the insulated ground wire from the chassis.

Figure 2-28 Remove the cable choke




3. Disconnect the document feeder harness from the scanner PCA. Remove one connector and one grounding wire.

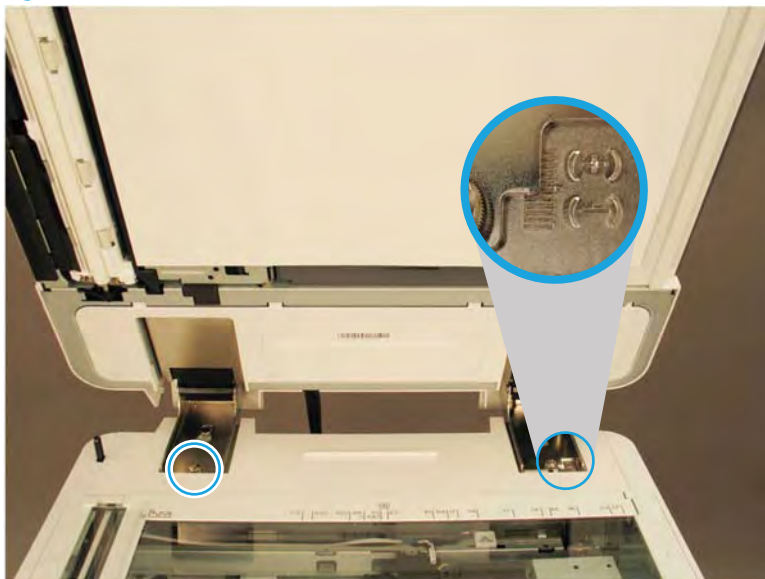
**Figure 2-29** Disconnect document feeder harness



4. Release two hinge stops on the back of the document feeder to allow the document feeder to open to a full 90°.

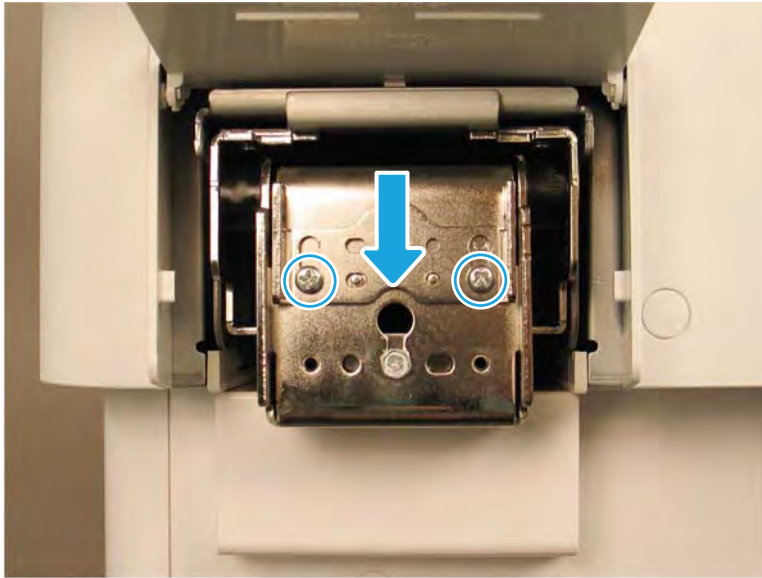
 **IMPORTANT:** Note the alignment marks on the hinge stops. Any new document feeder must be reinstalled with the same alignment.

**Figure 2-30** Alignment marks



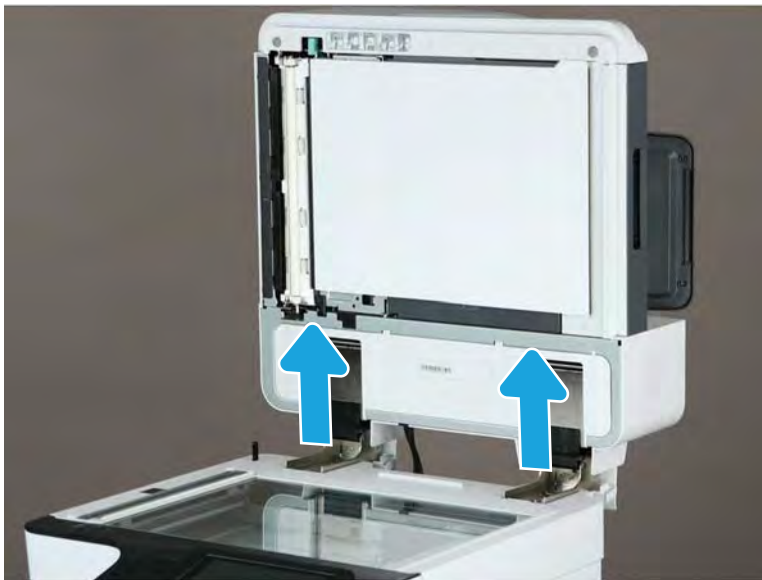
5. Remove two screws on each hinge stop.

Figure 2-31 Remove screws



6. Pull back and then lift up to release the document feeder unit.

Figure 2-32 Release the document feeder



 **NOTE:** Complete a shading test and a skew alignment after replacing the document feeder unit.

## Unpack the replacement assembly

Follow these steps to unpack the replacement assembly.

1. Dispose of the defective part.



---


 **NOTE:** HP recommends responsible disposal of the defective part.


<http://www8.hp.com/us/en/hp-information/environment/product-recycling.html>

---

2. Unpack the replacement part from the packaging.


 **CAUTION:**  Some parts are sensitive to electrostatic discharge (ESD). Always perform service work at an ESD-protected workstation or mat. If an ESD workstation or mat is not available, touch the sheet-metal chassis to provide a static ground before touching an ESD-sensitive assembly. Protect the ESD-sensitive assemblies by placing them in ESD pouches when they are out of the printer.

 **IMPORTANT:** Make sure that all of the shipping materials (for example shipping tape) are removed from the replacement part prior to installation.

 **NOTE:** If the replacement part is a roller or pad, avoid touching the spongy part of it. Skin oils on the roller or pad can cause paper pickup and/or print-quality problems. HP recommends using disposable gloves when handling rollers or pads or washing your hands before touching rollers or pads.

---

3. To install an assembly, reverse the removal steps.

 **NOTE:** When applicable, special installation instructions are provided for an assembly at the end of the removal procedure. Always completely read the removal instructions and follow all special installation instructions.

---

## Removal and replacement: Image scanner assembly (flatbed)


This document provides the procedures to remove the scanner whole unit.

 [View a video of removing and replacing the image scanner \(E77820-E77830\).](#)

Mean time to repair: 30 minutes

Service level: Advanced

---

 **IMPORTANT:** When applicable, special installation instructions are provided for an assembly at the end of the removal procedure. Always completely read the removal instructions and follow all special installation instructions.

---

### Before performing service

- Disconnect the power cable.

Use the table below to identify the correct part number for your printer. To order the part, go to [www.hp.com/buy/parts](http://www.hp.com/buy/parts)

**Table 2-8 Part information**

Part number	Part description
JC97-04520C	Scanner whole unit part number

### Required tools

- #2 JIS screwdriver with a magnetic tip

### After performing service

#### Turn the printer power on

- Connect the power cable.
- Use the power switch to turn the power on.

### Post service test

Copy, scan, or print a document. Verify the document copies, scans, or prints correctly.

### Remove the scanner whole unit

Follow these steps to remove the scanner whole unit.

1. Open the document feeder cover, and then remove the document feeder connector cover.

Figure 2-33 Remove document feeder connector cover



2. Remove the plastic cable choke from the wire harness, and then disconnect the document feeder harness from the main board. Disconnect the insulated ground wire from the chassis.

Figure 2-34 Remove the cable choke





3. Disconnect the document feeder harness from the PCA - ADF HIC. Remove one connector and one and one grounding wire.

Figure 2-35 Disconnect document feeder harness



4. Release two hinge stops on the back of the document feeder to allow the document feeder to open to a full 90°.


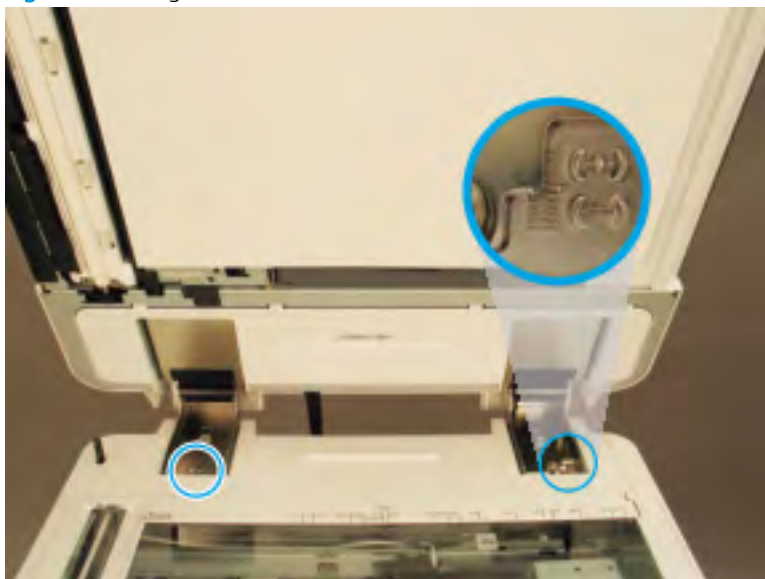
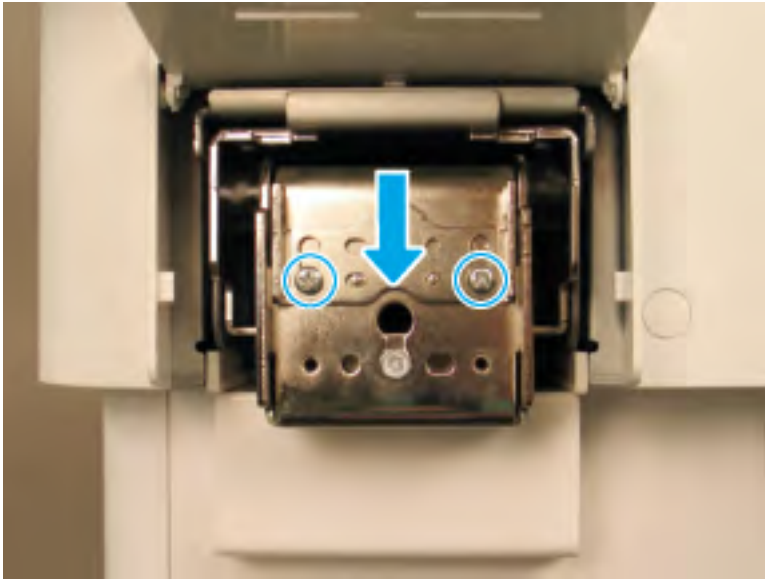
 **IMPORTANT:** If installing a replacement document feeder, note the alignment marks on the hinge stops. Any new document feeder must be reinstalled with the same alignment.

Figure 2-36 Alignment marks



5. Remove two screws on each hinge stop.

Figure 2-37 Remove screws



6. Pull back and then lift up to release the document feeder unit.

Figure 2-38 Release the document feeder



 **NOTE:** Complete a shading test and a skew alignment after replacing the document feeder unit.

7. Remove three screws.

Figure 2-39 Remove three screws



8. Place the control panel in the upright position.
9. Gently pry the control-panel bezel from the center screw hole, and then pry from the center of the control-panel bezel to the edges to release.

---

**⚠ CAUTION:** Do not pry against the scanner glass when removing the control-panel bezel.

---

10. Remove two screws on the control-panel frame.

Figure 2-40 Remove two screws



11. Disconnect one FFC, one connector, the HIP USB cable, and one HDMI connector.

12. Remove the USB interconnect cable from its retainer and reroute out of the way.

Figure 2-41 Remove USB interconnect cable



13. Slide the keyboard out, and then depress two latches to remove the keyboard.

Figure 2-42 Remove the keyboard



14. Lift the control panel up from the front to release the tabs at the rear, and then remove the control panel.

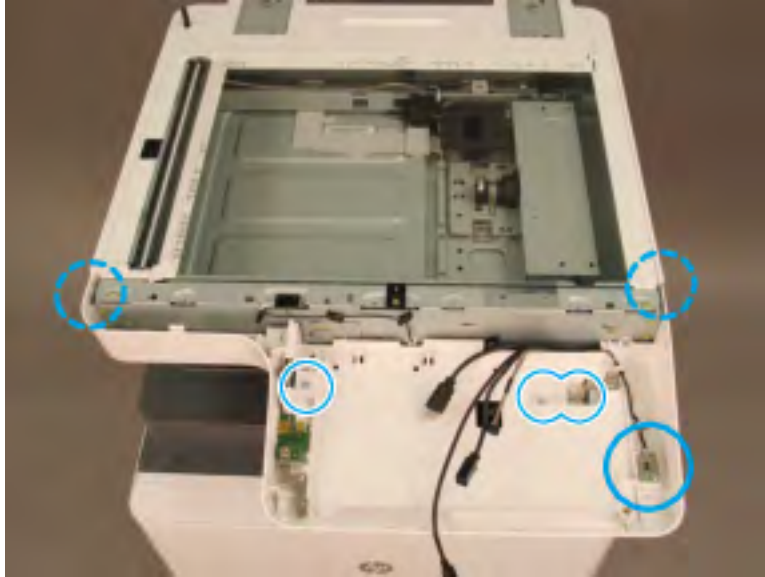
---

💡 **TIP:** Align the four tabs at the rear of the control panel, and then snap in the control panel.

---

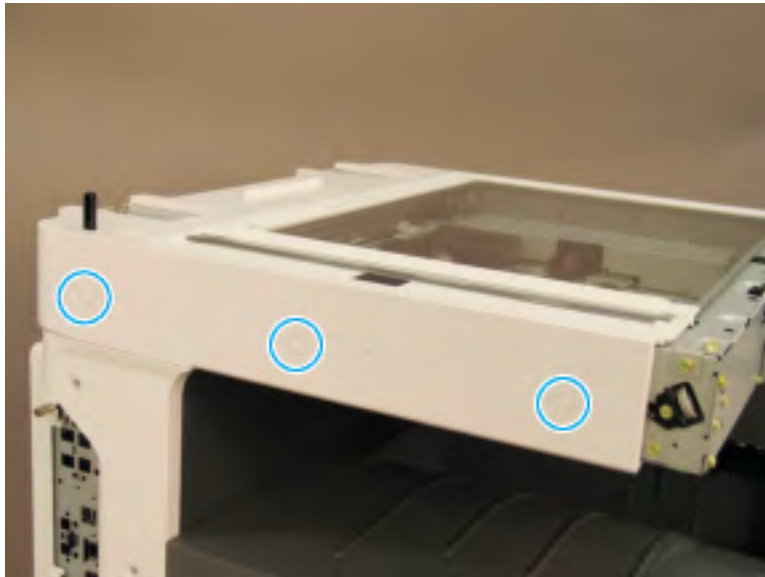
15. Remove six screw-caps and six screws. It might be necessary to use leverage near the left hinge and then pull the cover toward the back.

Figure 2-43 Remove screw-caps and screws and release scan-front cover



16. Remove three screw-caps and three screws. Release the scan-left cover.

Figure 2-44 Release scan-left cover



17. Remove three screw-caps and three screws (callout 1). Release the scan-right cover.


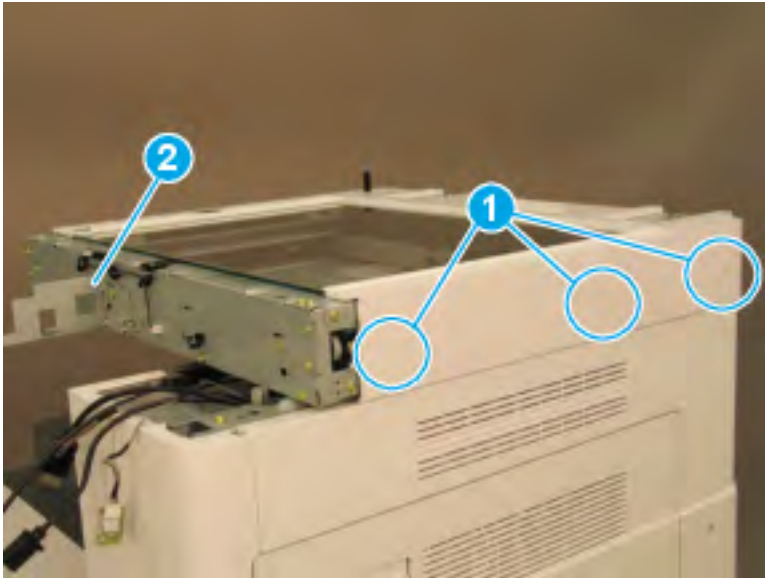
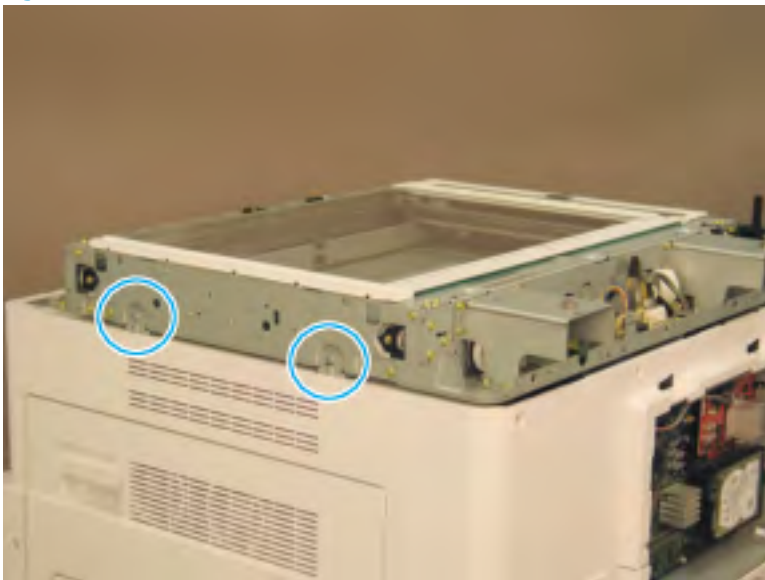
 **NOTE:** At the front of the scanner, remove the bracket (callout 2) and install it on the replacement scanner whole unit.

Figure 2-45 Remove scan-right cover



18. Remove two screws.

Figure 2-46 Remove two screws




19. Disconnect the two scan cables and one FFC at the top of the main board.

Figure 2-47 Disconnect scan cables



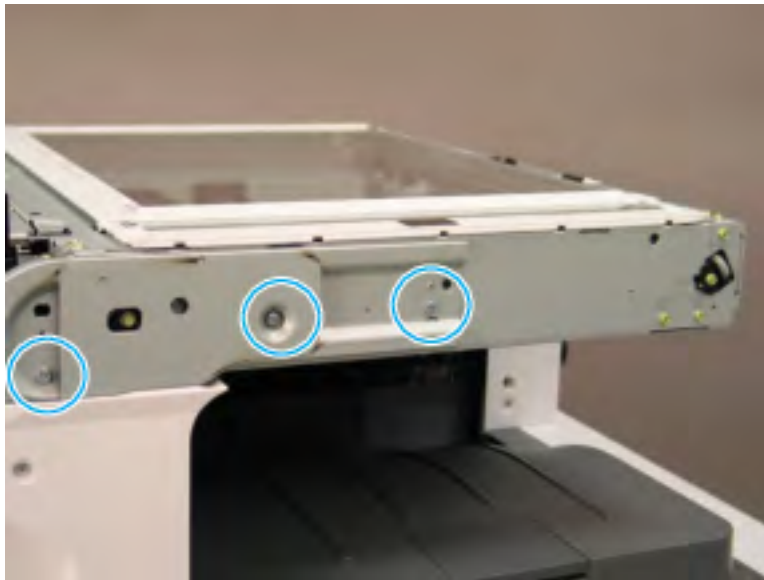
20. Remove three screws. Lift the scanner straight up and off of the printer to remove it.

 **NOTE:** After reassembly, utilize the target to adjust the scanner location as necessary.

 **Reinstallation tip:** Reinstall the scan bed by lowering the left side first and then lower the right. Align the screw holes on the right, and then install the screws.

Reinstall the lower cover and ensure the cables are routed through the opening for the control panel and the bracket is properly aligned in the cover.

Figure 2-48 Remove three screws




## Removal and replacement: Exit unit

This document provides the procedures to remove the exit unit.

Mean time to repair: 15 minutes

Service level: Intermediate

 **IMPORTANT:** When applicable, special installation instructions are provided for an assembly at the end of the removal procedure. Always completely read the removal instructions and follow all special installation instructions.

### Before performing service

- Disconnect the power cable.

Use the table below to identify the correct part number for your printer. To order the part, go to [www.hp.com/buy/parts](http://www.hp.com/buy/parts)

Table 2-9 Part information

Part number	Part description
JC90-01118B	Exit unit

### Required tools

- #2 JIS screwdriver with a magnetic tip

### After performing service

#### Turn the printer power on

- Connect the power cable.
- Use the power switch to turn the power on.

### Post service test

Copy, scan, or print a document. Verify the document copies, scans, or prints correctly.

## Remove the exit unit

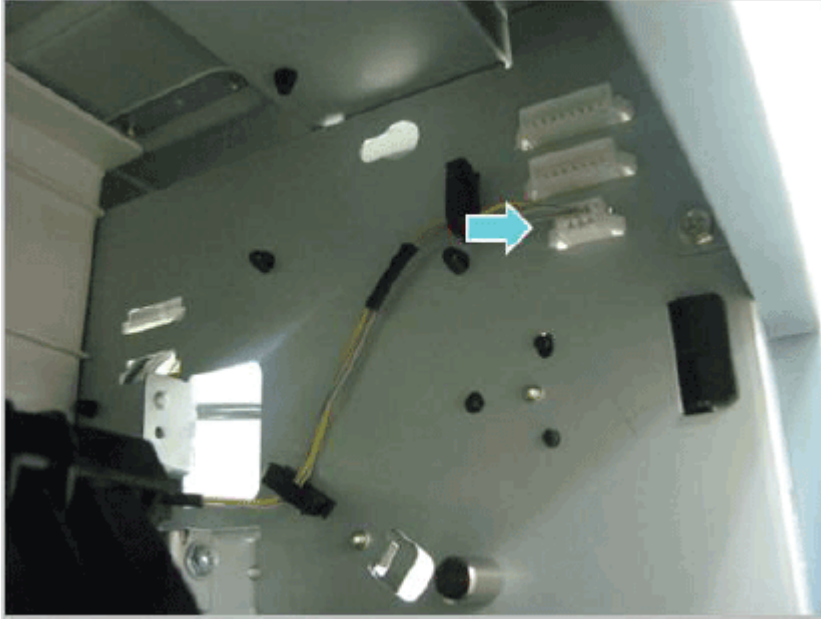
Follow these steps to remove the exit unit.

 **NOTE:** Remove second exit drive if installed.

1. Open the right door. Disconnect the Exit unit connector and two cable restraints.



Figure 2-49 Disconnect exit unit connector and cable restraints



2. Remove three screws, and then remove the exit unit.

Figure 2-50 Remove screws and exit unit



### Unpack the replacement assembly

Follow these steps to unpack the replacement assembly.

1. Dispose of the defective part.

---

 **NOTE:** HP recommends responsible disposal of the defective part.

<http://www8.hp.com/us/en/hp-information/environment/product-recycling.html>

---

2. Unpack the replacement part from the packaging.


 **CAUTION:**  Some parts are sensitive to electrostatic discharge (ESD). Always perform service work at an ESD-protected workstation or mat. If an ESD workstation or mat is not available, touch the sheet-metal chassis to provide a static ground before touching an ESD-sensitive assembly. Protect the ESD-sensitive assemblies by placing them in ESD pouches when they are out of the printer.

 **IMPORTANT:** Make sure that all of the shipping materials (for example shipping tape) are removed from the replacement part prior to installation.

 **NOTE:** If the replacement part is a roller or pad, avoid touching the spongy part of it. Skin oils on the roller or pad can cause paper pickup and/or print-quality problems. HP recommends using disposable gloves when handling rollers or pads or washing your hands before touching rollers or pads.

---

3. To install an assembly, reverse the removal steps.

 **NOTE:** When applicable, special installation instructions are provided for an assembly at the end of the removal procedure. Always completely read the removal instructions and follow all special installation instructions.

---


## Removal and replacement: Fuser unit

This document provides the procedures to remove the fuser unit.

 [View a video of removing the fuser unit.](#)

Mean time to repair: 3 minutes

Service level: Basic

 **IMPORTANT:** When applicable, special installation instructions are provided for an assembly at the end of the removal procedure. Always completely read the removal instructions and follow all special installation instructions.

### Before performing service

- Disconnect the power cable.

Use the table below to identify the correct part number for your printer. To order the part, go to [www.hp.com/buy/parts](http://www.hp.com/buy/parts)

**Table 2-10 Part information**

Part number	Part description
JC82-00472A	Kit-HP LaserJet 110V Fuser (E778xx Series)
3A64-61001	Kit-HP LaserJet 110V Fuser (E783xx Series)
JC82-00485A	Kit-HP LaserJet 220V Fuser (E778xx Series)
X3A64-61002	Kit-HP LaserJet 220V Fuser (E783xx Series)

### Required tools

- #2 JIS screwdriver with a magnetic tip

### After performing service

Turn the printer power on

- Connect the power cable.
- Use the power switch to turn the power on.

### Post service test

Copy, scan, or print a document. Verify the document copies, scans, or prints correctly.

### Remove the fuser unit

Follow these steps to remove the fuser unit.

1. Open the right door.

2. Remove the two screws shown below, and then remove the fuser unit.

**Figure 2-51** Remove two fuser unit screws



## Unpack the replacement assembly



Follow these steps to unpack the replacement assembly.


1. Dispose of the defective part.


 **NOTE:** HP recommends responsible disposal of the defective part.

<http://www8.hp.com/us/en/hp-information/environment/product-recycling.html>


2. Unpack the replacement part from the packaging.

 **CAUTION:**  Some parts are sensitive to electrostatic discharge (ESD). Always perform service work at an ESD-protected workstation or mat. If an ESD workstation or mat is not available, touch the sheet-metal chassis to provide a static ground before touching an ESD-sensitive assembly. Protect the ESD-sensitive assemblies by placing them in ESD pouches when they are out of the printer.

 **IMPORTANT:** Make sure that all of the shipping materials (for example shipping tape) are removed from the replacement part prior to installation.

 **NOTE:** If the replacement part is a roller or pad, avoid touching the spongy part of it. Skin oils on the roller or pad can cause paper pickup and/or print-quality problems. HP recommends using disposable gloves when handling rollers or pads or washing your hands before touching rollers or pads.

3. To install an assembly, reverse the removal steps.

 **NOTE:** When applicable, special installation instructions are provided for an assembly at the end of the removal procedure. Always completely read the removal instructions and follow all special installation instructions.

## Removal and replacement: Right door assembly


This document provides the procedures to remove the right door assembly.

 [View a video of removing the right door assembly.](#)

Mean time to repair: 3 minutes

Service level: Basic

---

 **IMPORTANT:** When applicable, special installation instructions are provided for an assembly at the end of the removal procedure. Always completely read the removal instructions and follow all special installation instructions.

---

### Before performing service

- Disconnect the power cable.

Use the table below to identify the correct part number for your printer. To order the part, go to [www.hp.com/buy/parts](http://www.hp.com/buy/parts)

**Table 2-11 Part information**

Part number	Part description
JC95-02079A	Right door assembly (E778xx series)
8GR88-60101	Right door assembly (E783xx series)

### Required tools

- #2 JIS screwdriver with a magnetic tip

### After performing service

#### Turn the printer power on

- Connect the power cable.
- Use the power switch to turn the power on.

### Post service test

Copy, scan, or print a document. Verify the document copies, scans, or prints correctly.

## Remove the right door

Follow these steps to remove the right door.

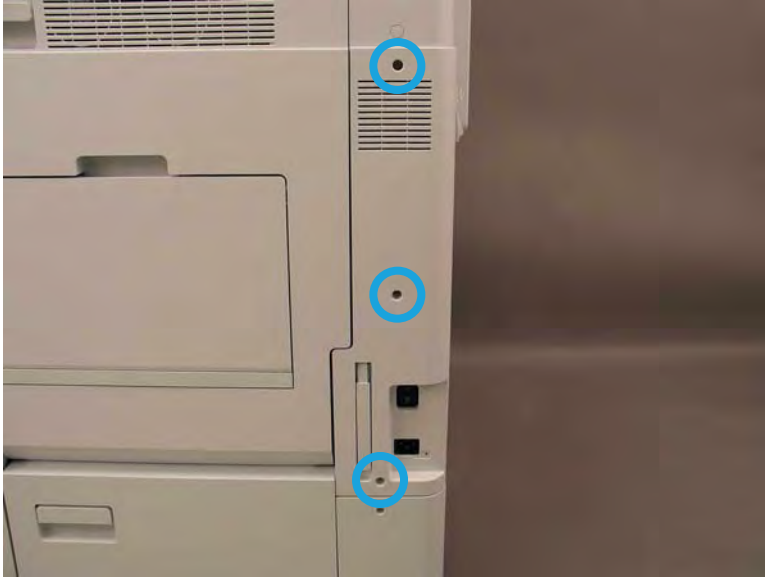
---

 **NOTE:** Remove second exit drive if installed.

---

1. Remove three screws, and then remove the cover (A).

Figure 2-52 Remove cover



2. Disconnect the right door connector.

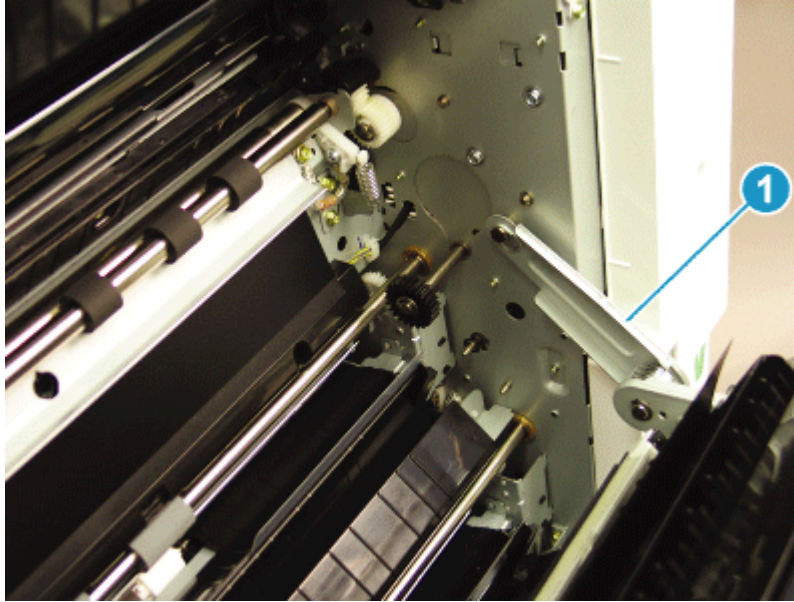
Figure 2-53 Disconnect right door connector



3. Release the right hinge (callout 1).

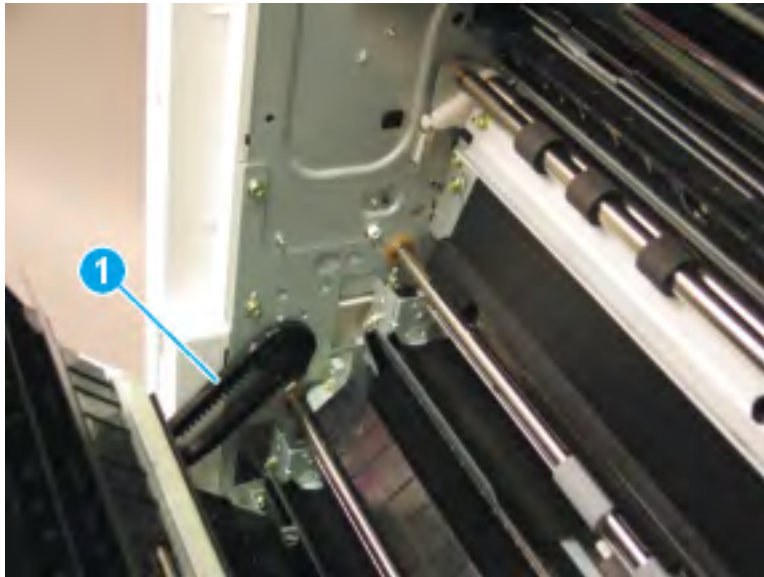
**⚠ CAUTION:** The right hinge spring tension can be dangerous. Use caution when releasing the right hinge to avoid injury.

Figure 2-54 Release right hinge



4. Release the left dampener (callout 1).

Figure 2-55 Release left dampener



5. Remove the right door.

 **NOTE:** Open the lower access door. If there is an HCI or 2x520 input device, release the dampener to clear the lower right door. Remove clockwise.

**Figure 2-56** Remove right door



## Unpack the replacement assembly



Follow these steps to unpack the replacement assembly.


1. Dispose of the defective part.


 **NOTE:** HP recommends responsible disposal of the defective part.

<http://www8.hp.com/us/en/hp-information/environment/product-recycling.html>


2. Unpack the replacement part from the packaging.

 **CAUTION:**  Some parts are sensitive to electrostatic discharge (ESD). Always perform service work at an ESD-protected workstation or mat. If an ESD workstation or mat is not available, touch the sheet-metal chassis to provide a static ground before touching an ESD-sensitive assembly. Protect the ESD-sensitive assemblies by placing them in ESD pouches when they are out of the printer.

 **IMPORTANT:** Make sure that all of the shipping materials (for example shipping tape) are removed from the replacement part prior to installation.

 **NOTE:** If the replacement part is a roller or pad, avoid touching the spongy part of it. Skin oils on the roller or pad can cause paper pickup and/or print-quality problems. HP recommends using disposable gloves when handling rollers or pads or washing your hands before touching rollers or pads.

3. To install an assembly, reverse the removal steps.

 **NOTE:** When applicable, special installation instructions are provided for an assembly at the end of the removal procedure. Always completely read the removal instructions and follow all special installation instructions.



## Removal and replacement: Image transfer belt (ITB) assembly

This document provides the procedures to remove the image transfer belt (ITB).



[View a video of removing the image transfer belt \(ITB\).](#)

Mean time to repair: 15 minutes

Service level: Intermediate



**IMPORTANT:** When applicable, special installation instructions are provided for an assembly at the end of the removal procedure. Always completely read the removal instructions and follow all special installation instructions.

### Before performing service

- Disconnect the power cable.

Use the table below to identify the correct part number for your printer. To order the part, go to [www.hp.com/buy/parts](http://www.hp.com/buy/parts)

**Table 2-12 Part information**

Part number	Part description
JC98-00980D	Image transfer belt (ITB) assembly (E778xx series)
5PN63-67001	Image transfer belt (ITB) assembly (E783xx series)

### Required tools

- #2 JIS screwdriver with a magnetic tip

### After performing service

#### Turn the printer power on

- Connect the power cable.
- Use the power switch to turn the power on.

### Post service test

Copy, scan, or print a document. Verify the document copies, scans, or prints correctly.

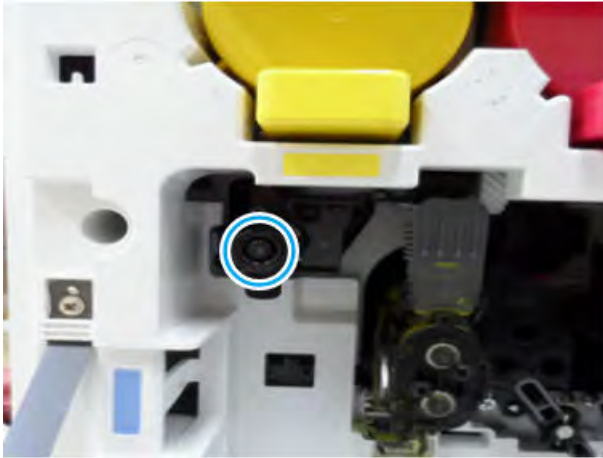
### Remove the ITB cleaner

Follow these steps to remove the ITB cleaner.

1. Open the front cover.

2. Loosen the captive screw.

Figure 2-57 Loosen screw



3. Release the ITB cleaner.

Figure 2-58 Release ITB cleaner



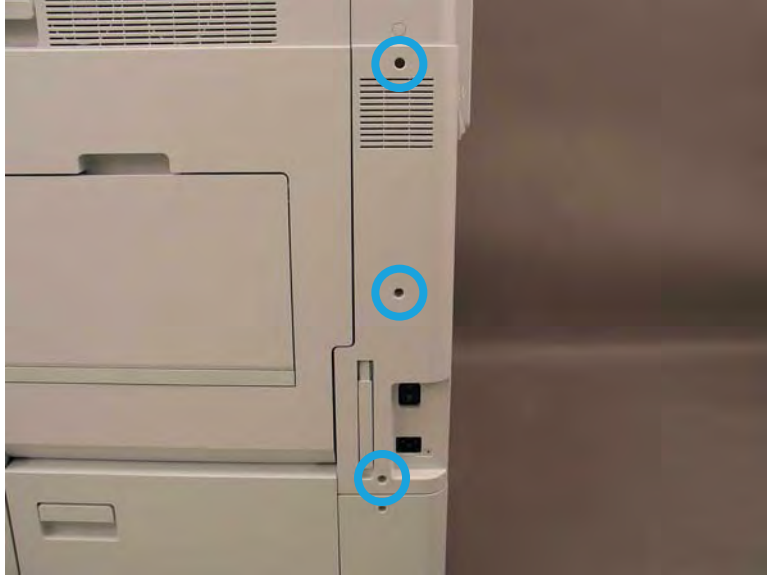
## Remove the right door

Follow these steps to remove the right door.

 **NOTE:** Remove second exit drive if installed.

1. Remove three screws, and then remove the cover (A).

Figure 2-59 Remove cover



2. Disconnect the right door connector.

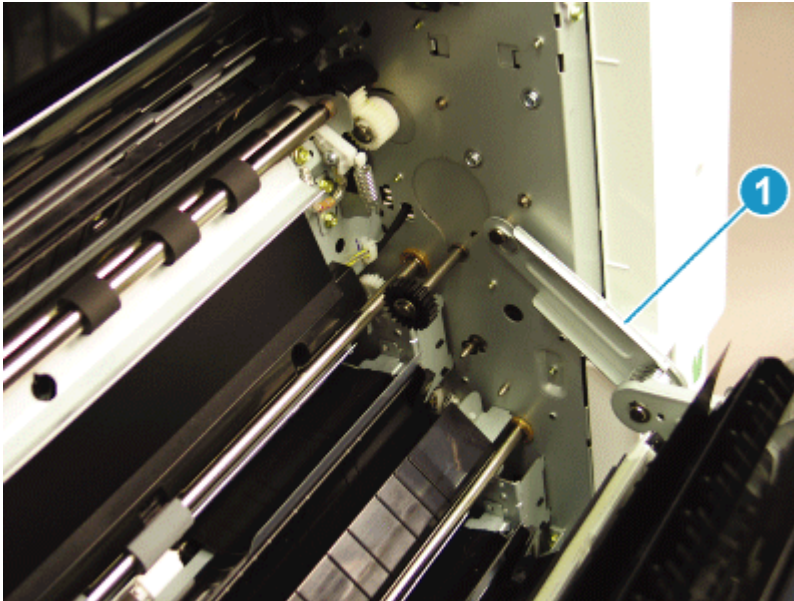
Figure 2-60 Disconnect right door connector



3. Release the right hinge (callout 1).

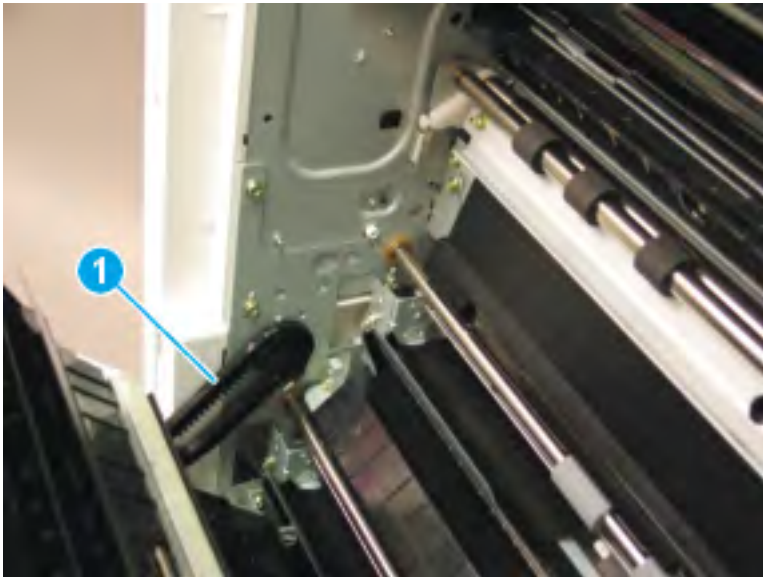
**⚠ CAUTION:** The right hinge spring tension can be dangerous. Use caution when releasing the right hinge to avoid injury.

**Figure 2-61** Release right hinge



4. Release the left dampener (callout 1).

**Figure 2-62** Release left dampener



5. Remove the right door.


 **NOTE:** Open the lower access door. If there is an HCI or 2x520 input device, release the dampener to clear the lower right door. Remove clockwise.

Figure 2-63 Remove right door

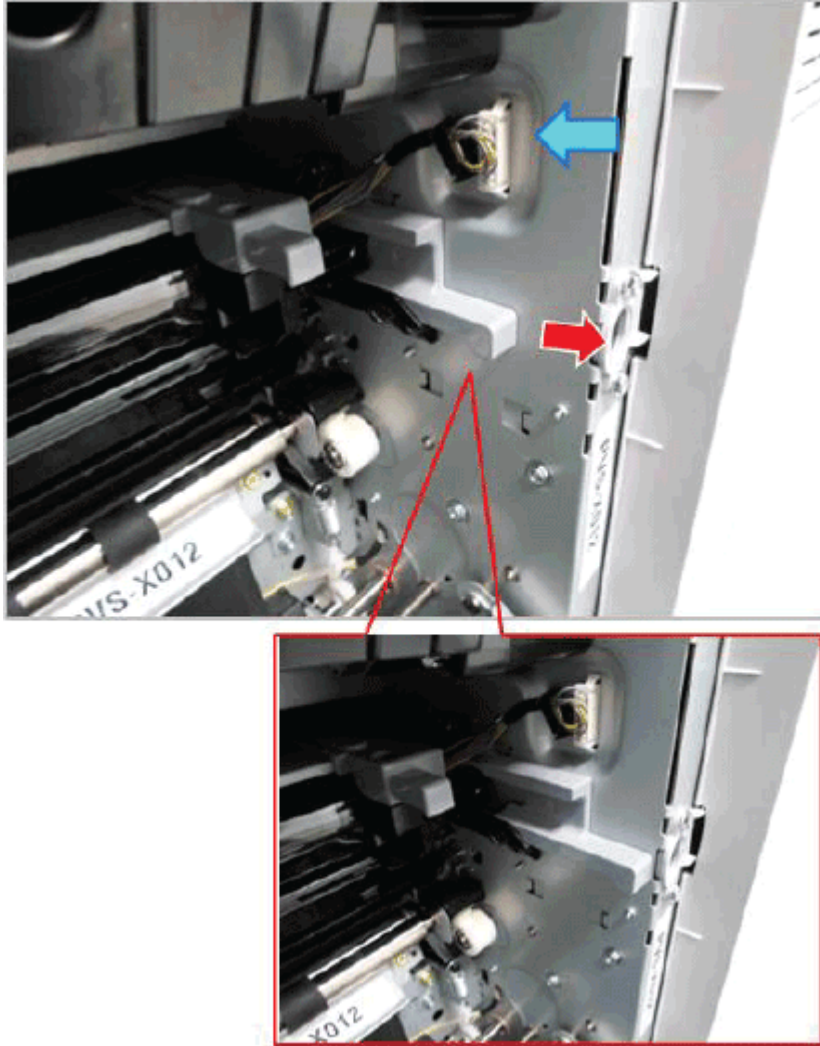


### Remove the ITB unit

Follow these steps to remove the ITB unit.

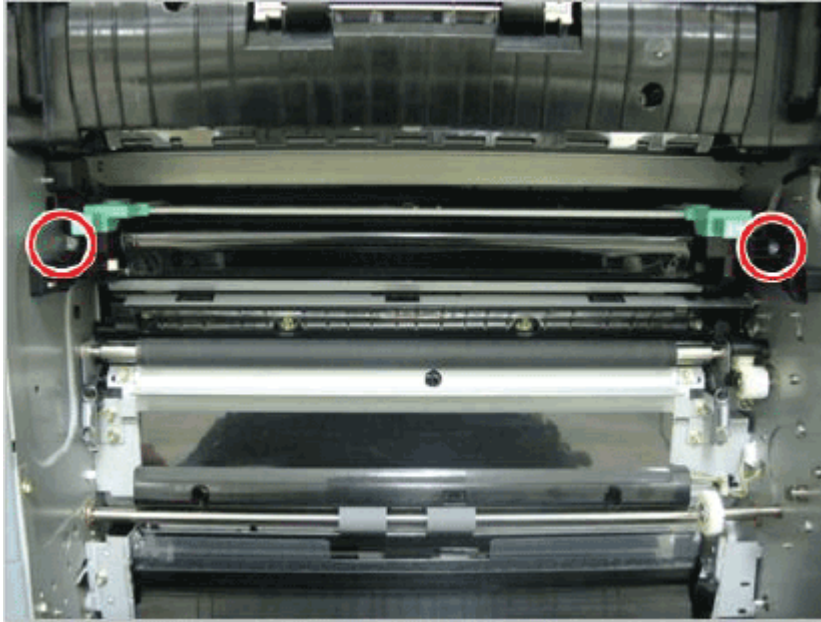
1. Disconnect the ITB connector from the right. Pull the holder to the front.

Figure 2-64 Disconnect ITB connector



2. Remove two screws.

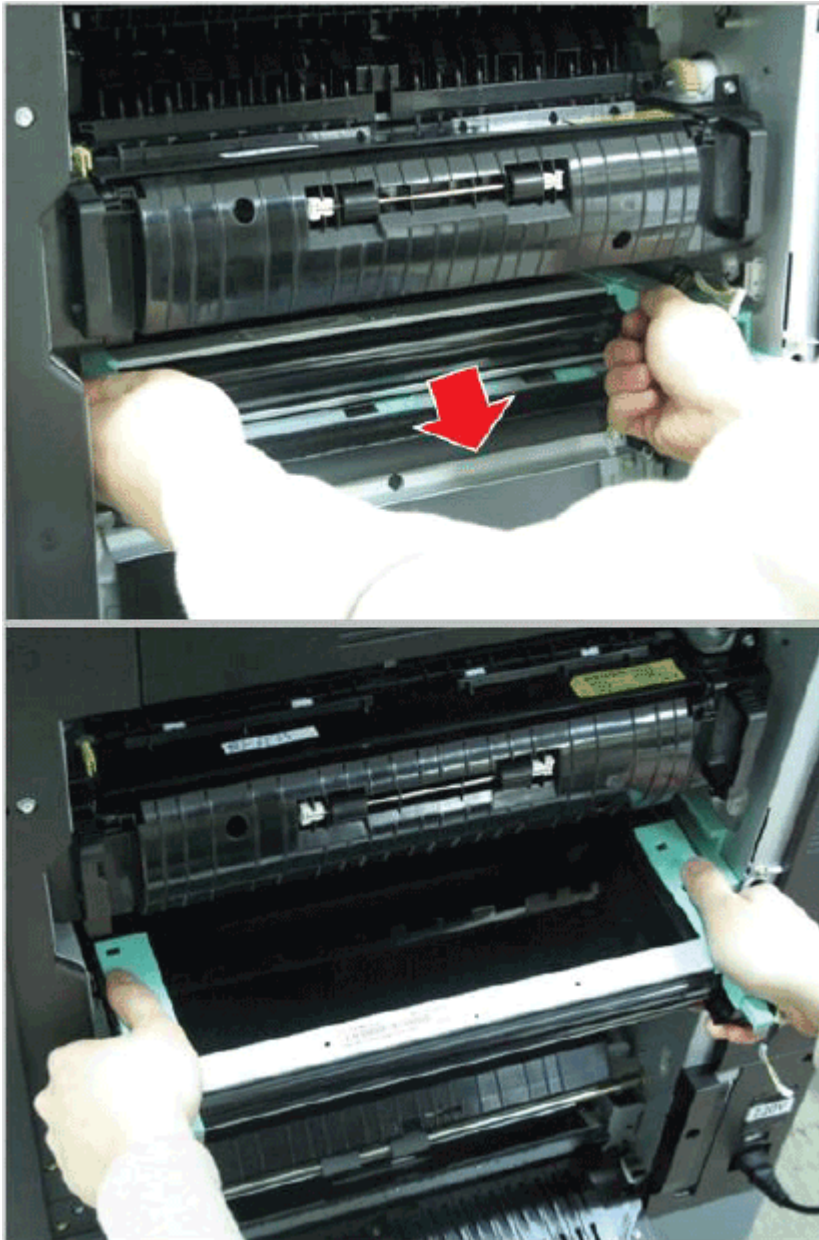
Figure 2-65 Remove two screws



3. Remove the ITB unit until the handles are fully visible. Release the ITB unit smoothly.

**⚠ CAUTION:** Make sure not to touch the belt surface of the ITB.

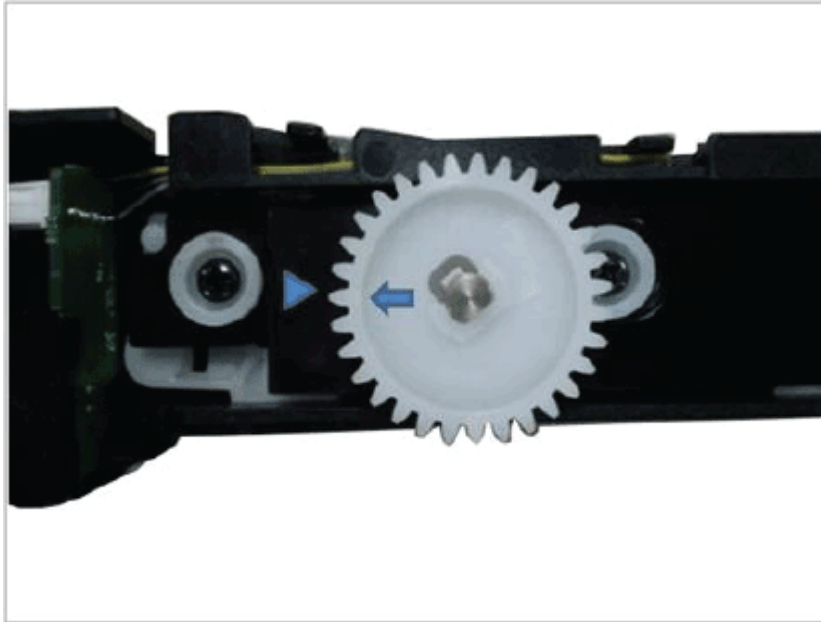
Figure 2-66 Release ITB unit





4. Before installing the new ITB unit, align the CAM position with the two arrows shown.

Figure 2-67 Align CAM



5. Install the new ITB unit, and then install the ITB cleaner.

## Unpack the replacement assembly



Follow these steps to unpack the replacement assembly.


1. Dispose of the defective part.


 **NOTE:** HP recommends responsible disposal of the defective part.

<http://www8.hp.com/us/en/hp-information/environment/product-recycling.html>


2. Unpack the replacement part from the packaging.

 **CAUTION:**  Some parts are sensitive to electrostatic discharge (ESD). Always perform service work at an ESD-protected workstation or mat. If an ESD workstation or mat is not available, touch the sheet-metal chassis to provide a static ground before touching an ESD-sensitive assembly. Protect the ESD-sensitive assemblies by placing them in ESD pouches when they are out of the printer.

 **IMPORTANT:** Make sure that all of the shipping materials (for example shipping tape) are removed from the replacement part prior to installation.

 **NOTE:** If the replacement part is a roller or pad, avoid touching the spongy part of it. Skin oils on the roller or pad can cause paper pickup and/or print-quality problems. HP recommends using disposable gloves when handling rollers or pads or washing your hands before touching rollers or pads.

3. To install an assembly, reverse the removal steps.

 **NOTE:** When applicable, special installation instructions are provided for an assembly at the end of the removal procedure. Always completely read the removal instructions and follow all special installation instructions.


## Removal and replacement: Fuser drive assembly board

This document provides the procedures to remove the fuser drive assembly board.

 [View a video of removing the fuser drive assembly board.](#)


Mean time to repair: 8 minutes

Service level: Basic

 **IMPORTANT:** When applicable, special installation instructions are provided for an assembly at the end of the removal procedure. Always completely read the removal instructions and follow all special installation instructions.

### Before performing service

- Disconnect the power cable.

 **CAUTION:** Wait five minutes after disconnecting the power cable before replacing the Fuser drive assembly board. Not waiting long enough after disconnecting the power cable can cause electric shock.

Use the table below to identify the correct part number for your printer. To order the part, go to [www.hp.com/buy/parts](http://www.hp.com/buy/parts)

**Table 2-13** Part information

Part number	Part description
JC44-00210E	Fuser drive assembly board (110V) (E778xx series)
8GR94-60001	Fuser drive assembly board (110V) (E783xx series)
JC44-00211E	Fuser drive assembly board (220V) (E778xx series)
8GR94-60002	Fuser drive assembly board (220V) (E783xx series)

### Required tools

- #2 JIS screwdriver with a magnetic tip

### After performing service

#### Turn the printer power on

- Connect the power cable.
- Use the power switch to turn the power on.

### Post service test

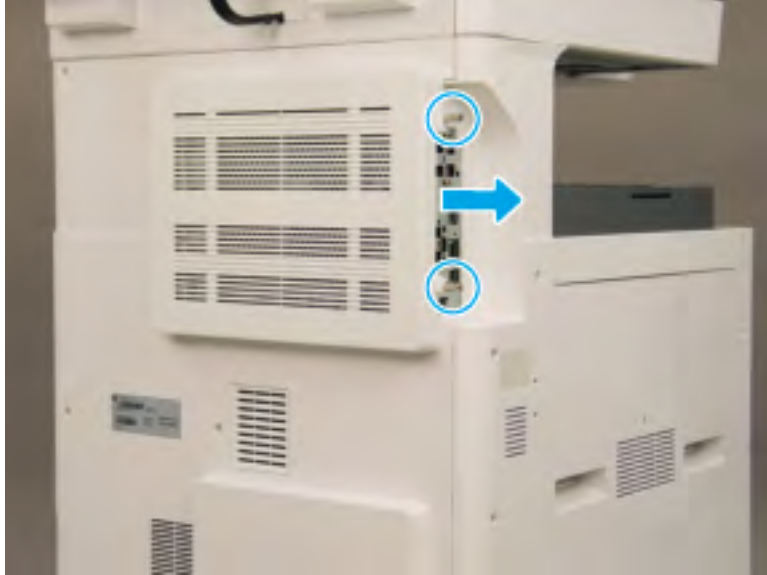
Copy, scan, or print a document. Verify the document copies, scans, or prints correctly.

### Remove the rear bottom cover

Follow these steps to remove the rear bottom cover.

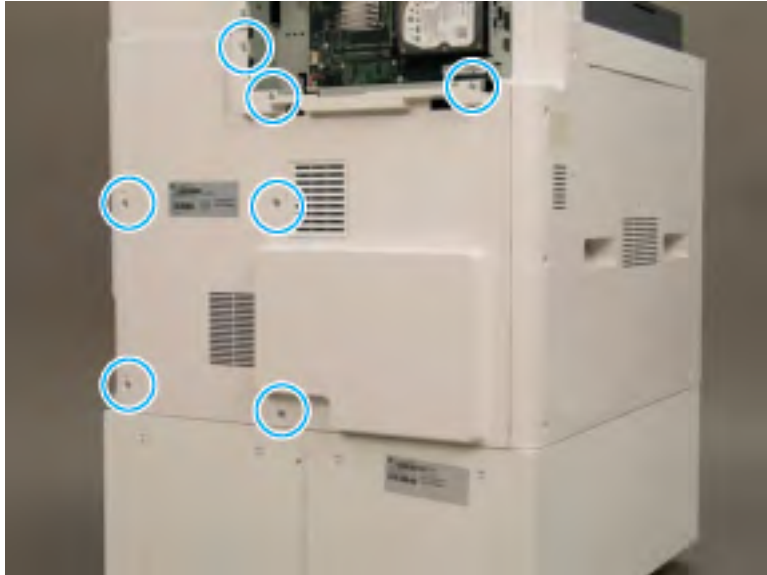
1. Unscrew two captive thumbscrews on the formatter cover. Slide the formatter cover to the left, and then to the right to remove.

Figure 2-68 Remove the formatter cover



2. Remove seven screws, and then remove the rear-bottom cover.

Figure 2-69 Remove the rear-bottom cover

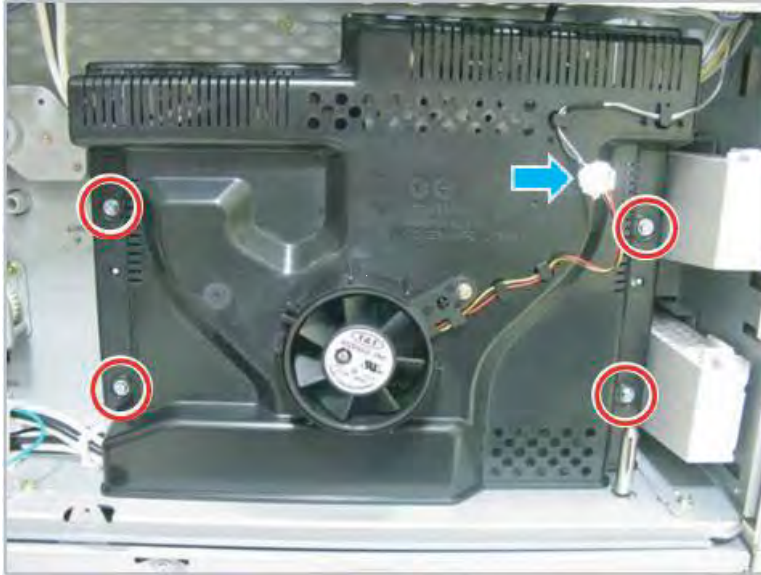


### Remove the LVPS cover

Follow these steps to remove the LVPS cover.

- ▲ Remove four screws, and then remove the LVPS cover.

Figure 2-70 Remove the LVPS cover



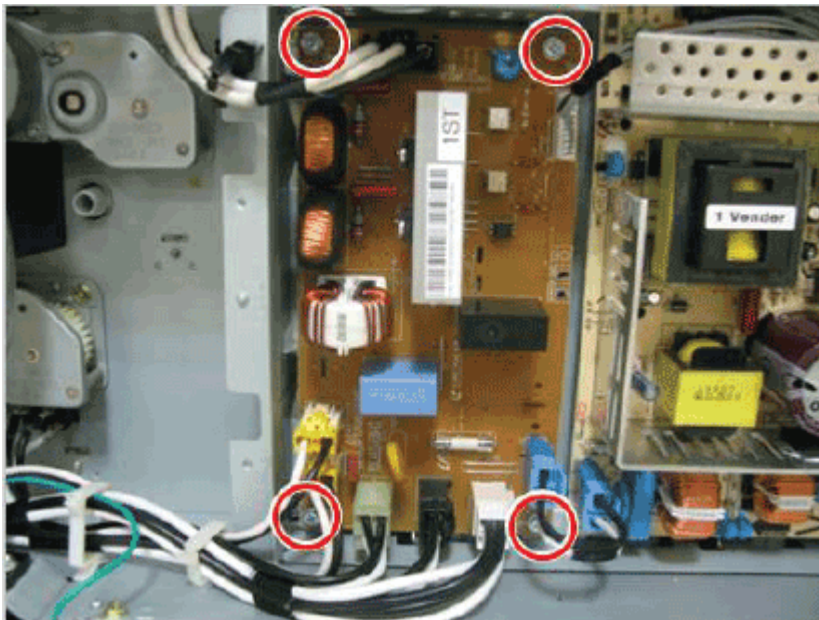
### Remove the fuser drive assembly board

Follow these steps to remove the fuser drive assembly board.

- ▲ Disconnect seven connectors and cable restraints on the fuser-drive assembly board. Remove four screws, and then remove the fuser-drive assembly board.

 **NOTE:** Several of the connectors have tabs that need to be pressed in order to release.

Figure 2-71 Remove the fuser-drive assembly board



### Unpack the replacement assembly

Follow these steps to unpack the replacement assembly.

1. Dispose of the defective part.




**NOTE:** HP recommends responsible disposal of the defective part.

<http://www8.hp.com/us/en/hp-information/environment/product-recycling.html>

2. Unpack the replacement part from the packaging.



**CAUTION:**  Some parts are sensitive to electrostatic discharge (ESD). Always perform service work at an ESD-protected workstation or mat. If an ESD workstation or mat is not available, touch the sheet-metal chassis to provide a static ground before touching an ESD-sensitive assembly. Protect the ESD-sensitive assemblies by placing them in ESD pouches when they are out of the printer.



**IMPORTANT:** Make sure that all of the shipping materials (for example shipping tape) are removed from the replacement part prior to installation.



**NOTE:** If the replacement part is a roller or pad, avoid touching the spongy part of it. Skin oils on the roller or pad can cause paper pickup and/or print-quality problems. HP recommends using disposable gloves when handling rollers or pads or washing your hands before touching rollers or pads.

3. To install an assembly, reverse the removal steps.



**NOTE:** When applicable, special installation instructions are provided for an assembly at the end of the removal procedure. Always completely read the removal instructions and follow all special installation instructions.


## Removal and replacement: Scanner LVPS (Type 5) board

This document provides the procedures to remove the scanner LVPS board.

 [View a video of removing the scanner LVPS board.](#)


Mean time to repair: 8 minutes

Service level: Basic

 **IMPORTANT:** When applicable, special installation instructions are provided for an assembly at the end of the removal procedure. Always completely read the removal instructions and follow all special installation instructions.

### Before performing service

- Disconnect the power cable.

 **CAUTION:** Wait five minutes after disconnecting the power cable before replacing the LVPS board. Not waiting long enough after disconnecting the power cable can cause electric shock.

Use the table below to identify the correct part number for your printer. To order the part, go to [www.hp.com/buy/parts](http://www.hp.com/buy/parts)

**Table 2-14** Part information

Part number	Part description
JC44-00249A	LVPS 110 V type 5H (SMPS V1)
JC44-00250A	LVPS 220 Type 5 (SMPS V2)
JC44-00091D	LVPS 110 Type 4 (SMPS V1)
JC44-00092D	LVPS 220 Type 4 (SMPS V2)

 **NOTE:** The Type 4 LVPS only exists on some early models during original release. This has been removed from all new models.

### Required tools


- #2 JIS screwdriver with a magnetic tip

### After performing service

#### Turn the printer power on

- Connect the power cable.
- Use the power switch to turn the power on.

### Post service test

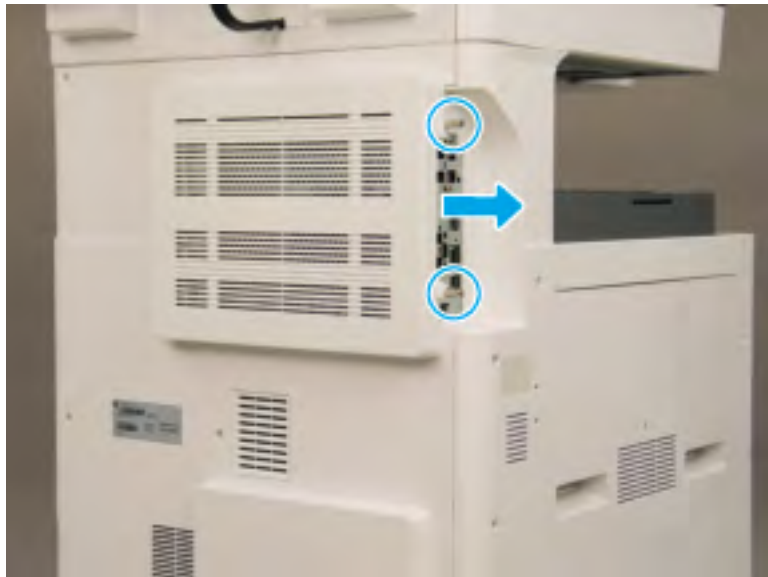
 Copy, scan, or print a document. Verify the document copies, scans, or prints correctly.

## Remove the rear bottom cover

Follow these steps to remove the rear bottom cover.

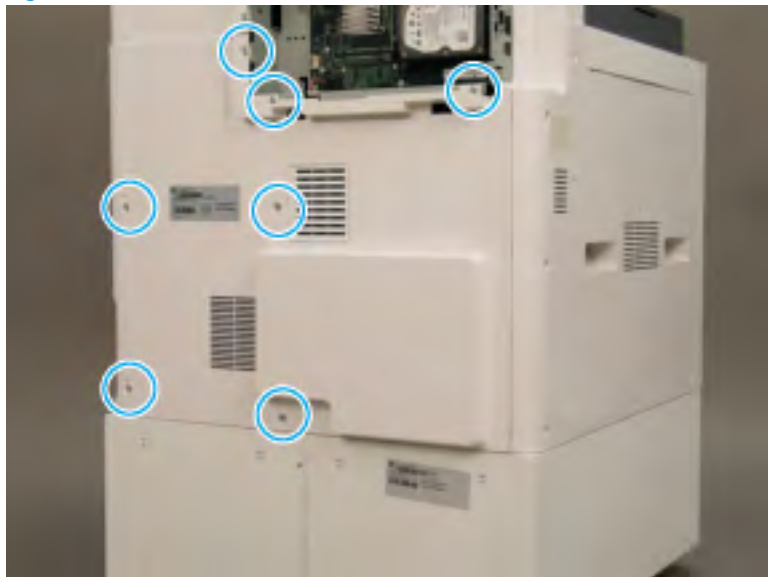
1. Unscrew two captive thumbscrews on the formatter cover. Slide the formatter cover to the left, and then to the right to remove.

Figure 2-72 Remove the formatter cover



2. Remove seven screws, and then remove the rear-bottom cover.

Figure 2-73 Remove the rear-bottom cover

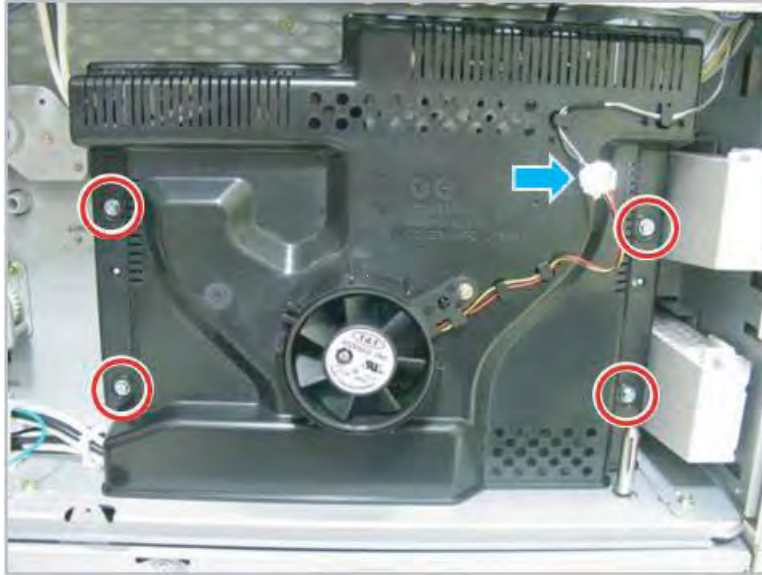


## Remove the LVPS cover

Follow these steps to remove the LVPS cover.

- ▲ Remove four screws, and then remove the LVPS cover.

Figure 2-74 Remove the LVPS cover

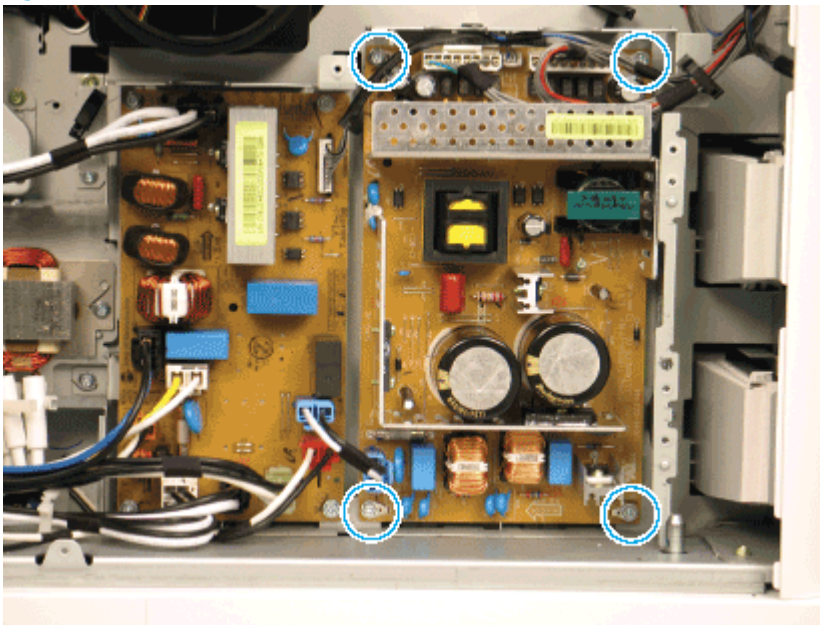


### Remove the scanner LVPS (Type 5) board

Follow these steps to remove the scanner LVPS (Type 5) board.

- ▲ Disconnect four connectors, including one fuser-drive assembly connector and four other connectors, on the LVPS PCA (Type 5). Remove four screws, and then remove the scanner LVPS board (Type 5).

Figure 2-75 Remove the scanner LVPS (Type 5) board



### Unpack the replacement assembly

Follow these steps to unpack the replacement assembly.

1. Dispose of the defective part.





---

 **NOTE:** HP recommends responsible disposal of the defective part.


<http://www8.hp.com/us/en/hp-information/environment/product-recycling.html>

---

2. Unpack the replacement part from the packaging.


 **CAUTION:**  Some parts are sensitive to electrostatic discharge (ESD). Always perform service work at an ESD-protected workstation or mat. If an ESD workstation or mat is not available, touch the sheet-metal chassis to provide a static ground before touching an ESD-sensitive assembly. Protect the ESD-sensitive assemblies by placing them in ESD pouches when they are out of the printer.

 **IMPORTANT:** Make sure that all of the shipping materials (for example shipping tape) are removed from the replacement part prior to installation.

 **NOTE:** If the replacement part is a roller or pad, avoid touching the spongy part of it. Skin oils on the roller or pad can cause paper pickup and/or print-quality problems. HP recommends using disposable gloves when handling rollers or pads or washing your hands before touching rollers or pads.

---

3. To install an assembly, reverse the removal steps.

 **NOTE:** When applicable, special installation instructions are provided for an assembly at the end of the removal procedure. Always completely read the removal instructions and follow all special installation instructions.

---


## Removal and replacement: LVPS fan

This document provides the procedures to remove the LVPS fan assembly.

 [View a video of removing the LVPS fan assembly.](#)


Mean time to repair: 10 minutes

Service level: Basic

 **IMPORTANT:** When applicable, special installation instructions are provided for an assembly at the end of the removal procedure. Always completely read the removal instructions and follow all special installation instructions.

### Before performing service

- Disconnect the power cable.

 **WARNING!** To avoid damage to the printer, turn the printer off, wait 30 seconds, and then remove the power cable before attempting to service the printer.

Use the table below to identify the correct part number for your printer. To order the part, go to [www.hp.com/buy/parts](http://www.hp.com/buy/parts)

**Table 2-15** Part information

Part number	Part description
JC31-00162A	LVPS fan assembly (fan type 8)

### Required tools

- #2 JIS screwdriver with a magnetic tip

### After performing service

#### Turn the printer power on

- Connect the power cable.
- Use the power switch to turn the power on.

### Post service test

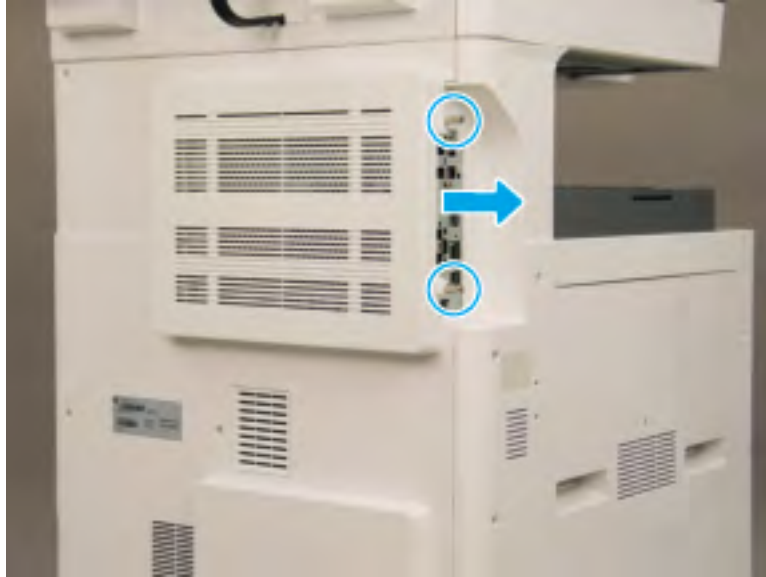
Copy, scan, or print a document. Verify the document copies, scans, or prints correctly.

### Remove the rear bottom cover

Follow these steps to remove the rear bottom cover.

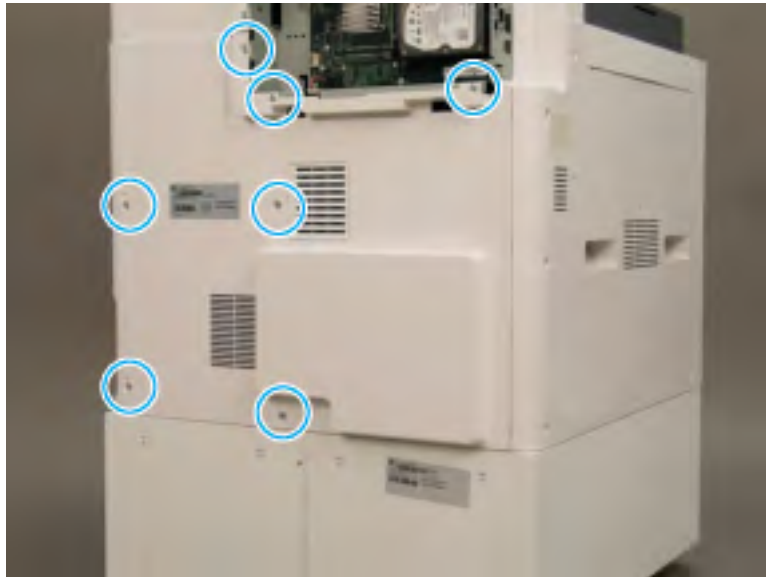
1. Unscrew two captive thumbscrews on the formatter cover. Slide the formatter cover to the left, and then to the right to remove.

Figure 2-76 Remove the formatter cover



2. Remove seven screws, and then remove the rear-bottom cover.

Figure 2-77 Remove the rear-bottom cover

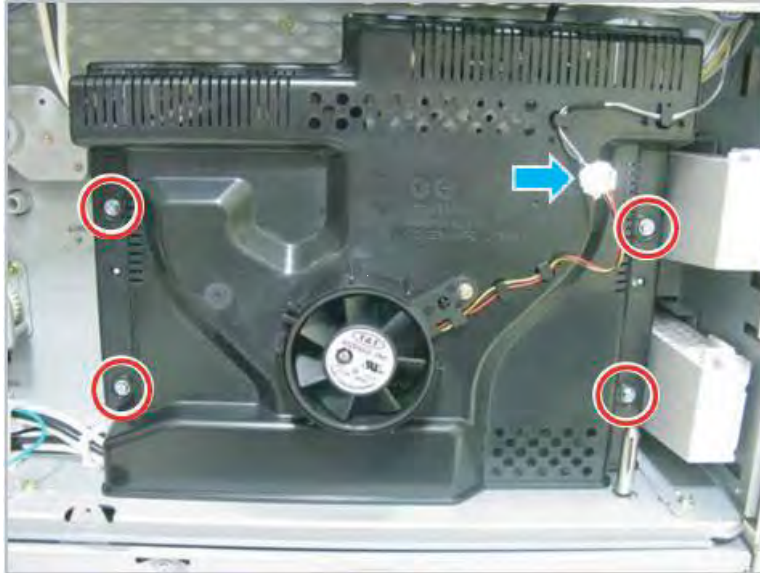


### Remove the LVPS cover

Follow these steps to remove the LVPS cover.

- ▲ Remove four screws, and then remove the LVPS cover.

Figure 2-78 Remove the LVPS cover

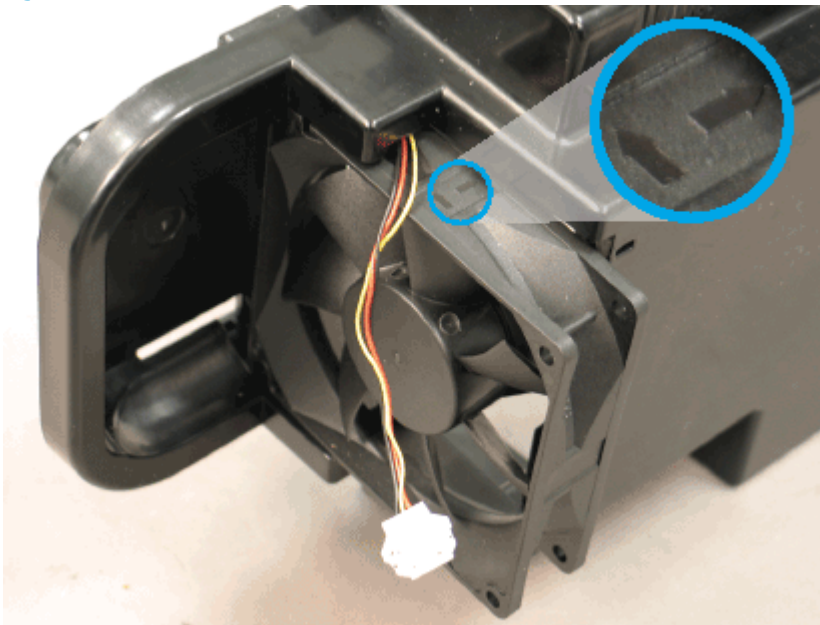


## Remove the LVPS fan

Follow these steps to remove the LVPS fan.

- ▲ Disconnect the connector and remove wire from retainer. Remove one screw, and then remove the LVPS fan.

Figure 2-79 Remove the LVPS fan



 **TIP:** When reinstalling, verify that the fan is oriented as indicated by the arrows on the fan housing.

## Unpack the replacement assembly

Follow these steps to unpack the replacement assembly.

1. Dispose of the defective part.



---

 **NOTE:** HP recommends responsible disposal of the defective part.


<http://www8.hp.com/us/en/hp-information/environment/product-recycling.html>

---

2. Unpack the replacement part from the packaging.


 **CAUTION:**  Some parts are sensitive to electrostatic discharge (ESD). Always perform service work at an ESD-protected workstation or mat. If an ESD workstation or mat is not available, touch the sheet-metal chassis to provide a static ground before touching an ESD-sensitive assembly. Protect the ESD-sensitive assemblies by placing them in ESD pouches when they are out of the printer.

 **IMPORTANT:** Make sure that all of the shipping materials (for example shipping tape) are removed from the replacement part prior to installation.

 **NOTE:** If the replacement part is a roller or pad, avoid touching the spongy part of it. Skin oils on the roller or pad can cause paper pickup and/or print-quality problems. HP recommends using disposable gloves when handling rollers or pads or washing your hands before touching rollers or pads.

---

3. To install an assembly, reverse the removal steps.

 **NOTE:** When applicable, special installation instructions are provided for an assembly at the end of the removal procedure. Always completely read the removal instructions and follow all special installation instructions.

---


## Removal and replacement: Formatter and formatter cage

This document provides the procedures to remove the formatter and formatter cage assembly.

 [View a video of removing and replacing the formatter and formatter cage.](#)


Mean time to repair: 15 minutes

Service level: Basic

 **IMPORTANT:** When applicable, special installation instructions are provided for an assembly at the end of the removal procedure. Always completely read the removal instructions and follow all special installation instructions.

### Before performing service

- Disconnect the power cable.

 **WARNING!** To avoid damage to the printer, turn the printer off, wait 30 seconds, and then remove the power cable before attempting to service the printer.

Use the table below to identify the correct part number for your printer. To order the part, go to [www.hp.com/buy/parts](http://www.hp.com/buy/parts)

**Table 2-16** Part information

Part number	Part description
JC93-01538A	Formatter Cage
X3A92-60003	Formatter PCA (E778xx series)
X3A92-60006	Formatter PCA - obsidian (E783xx series) (LX)
Y3K99-60005	Formatter PCA - Rock (E783xx series) (GX)

### Required tools

- #2 JIS screwdriver with a magnetic tip

### After performing service

#### Turn the printer power on

- Connect the power cable.
- Use the power switch to turn the power on.

### Post service test

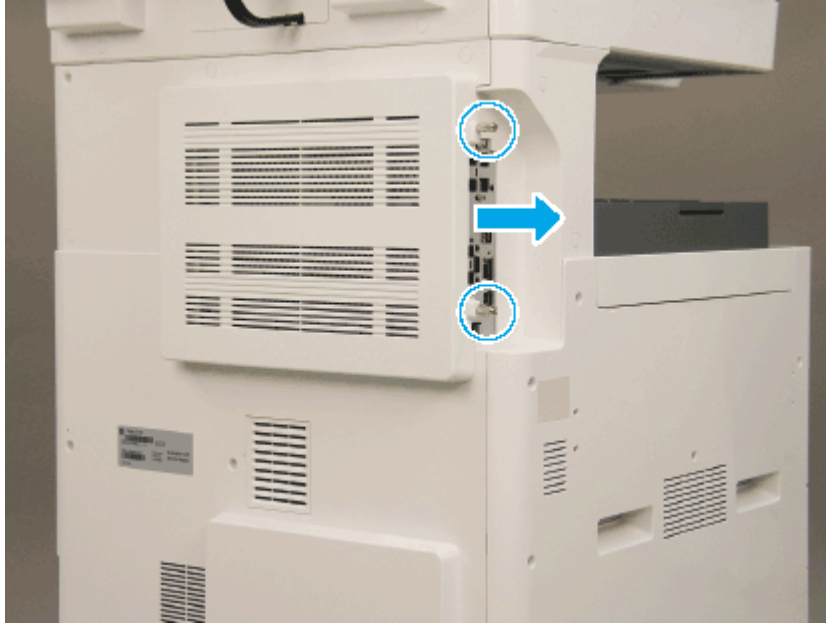
Copy, scan, or print a document. Verify the document copies, scans, or prints correctly.

### Remove the rear covers

Follow these steps to remove the rear covers.

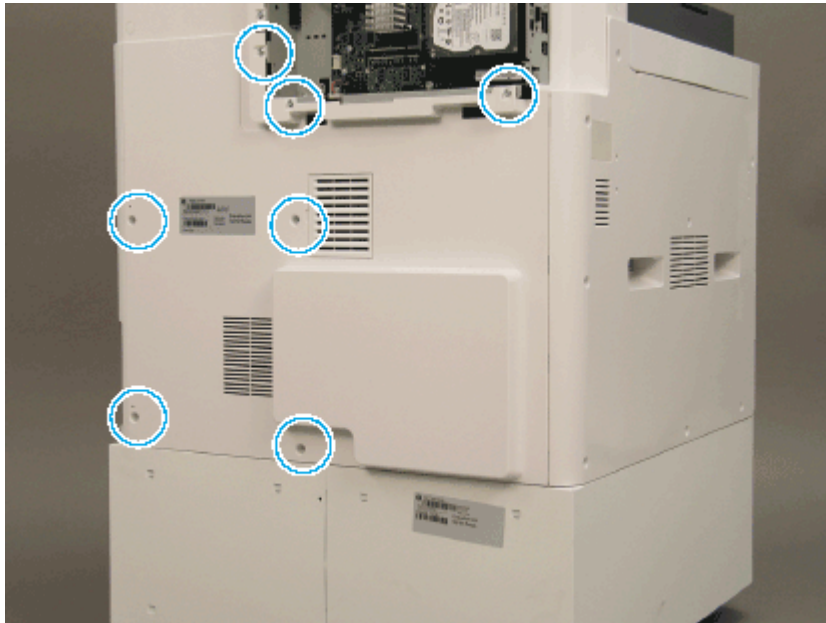
1. Unscrew two captive thumbscrews on the formatter cover. Slide the formatter cover to the left, and then to the right to remove.

Figure 2-80 Remove the formatter cover



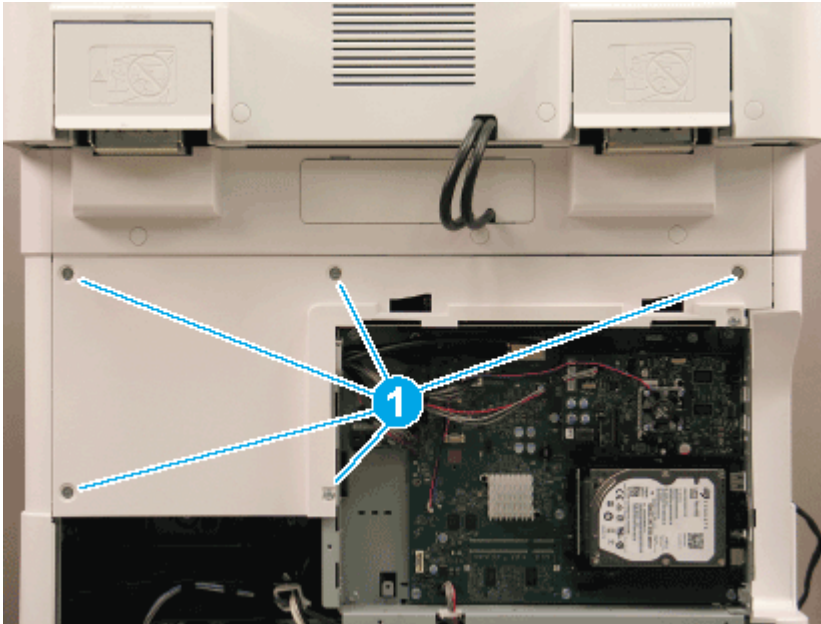
2. Remove seven screws, and then remove the rear-bottom cover.

Figure 2-81 Remove the rear-bottom cover



3. Remove six screws (callout 1), and then remove the rear-top cover.

Figure 2-82 Remove the rear-top cover



## Remove the accelerator board

Follow these steps to remove the accelerator board.

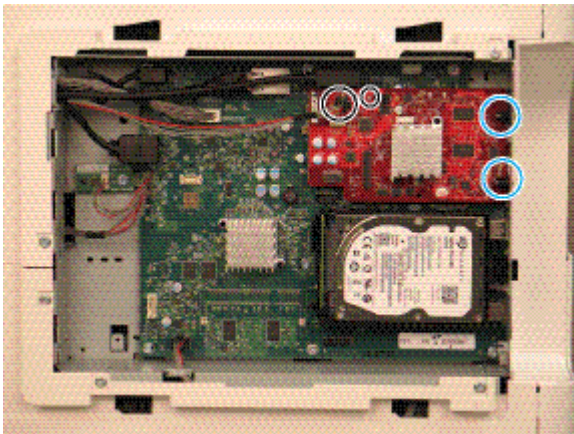
**CAUTION:**  ESD sensitive part.

- ▲ Loosen two screws, retained in plastic clips, on the outside of the formatter cage. Disconnect one connector, release the plastic locator pin, and then gently lift the accelerator board away from the formatter by the edges.

**NOTE:** A connector on the back of the accelerator board holds the board on the formatter.

**IMPORTANT:** Do not lift the accelerator board by the heat sink.

Figure 2-83 Remove the accelerator PCA






## Remove the hard-disk drive (HDD)

Follow these steps to remove the hard-disk drive (HDD).

- ▲ Release one retainer, and then remove the HDD.

---

 **IMPORTANT:** The HDD and the IOD cannot be replaced at the same time.

---

Figure 2-84 Remove the hard-disk drive (HDD)



## Remove the Island of data (IOD)

Follow these steps to remove the Island of data (IOD).

- ▲ Disconnect one connector and remove one screw, and then remove the IOD.

---

 **IMPORTANT:** The HDD and the IOD cannot be replaced at the same time.

---

Figure 2-85 Remove the IOD

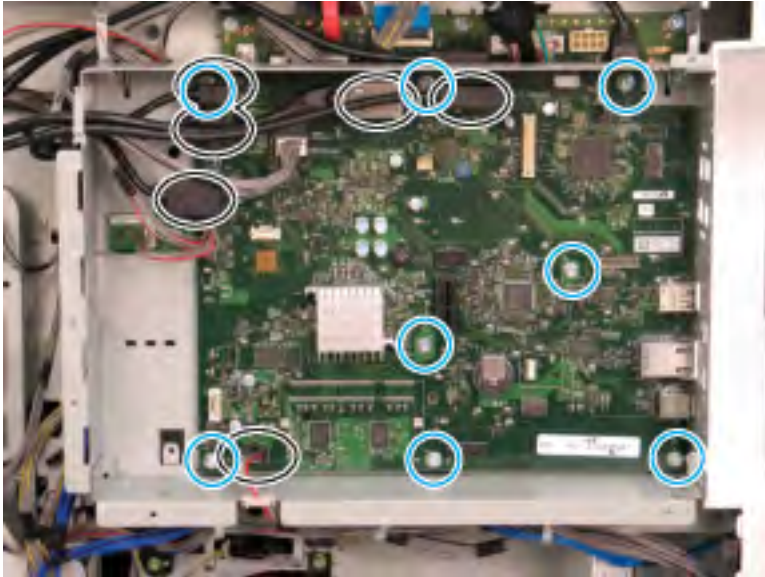


## Remove the formatter PCA

Follow these steps to remove the formatter PCA.

- ▲ Disconnect seven connectors and eight screws, and then remove formatter PCA.

**Figure 2-86** Remove the formatter connectors and screws

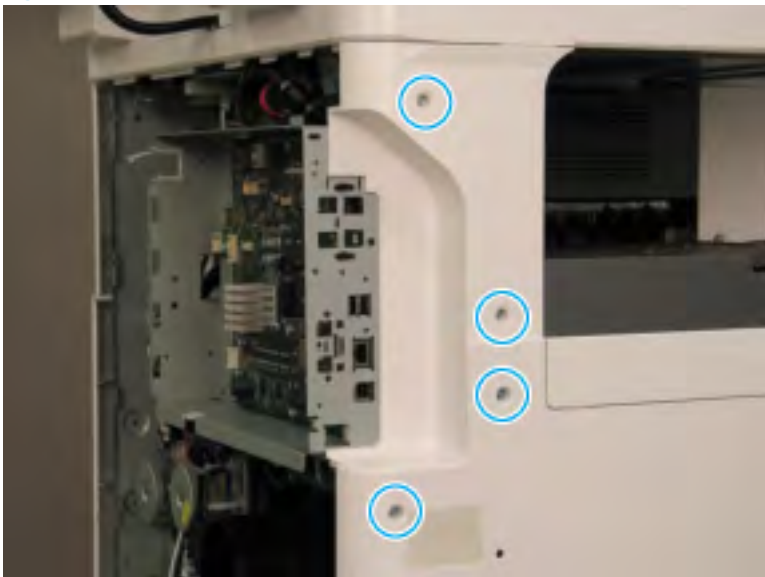


## Remove the formatter cage

Follow these steps to remove the formatter cage.

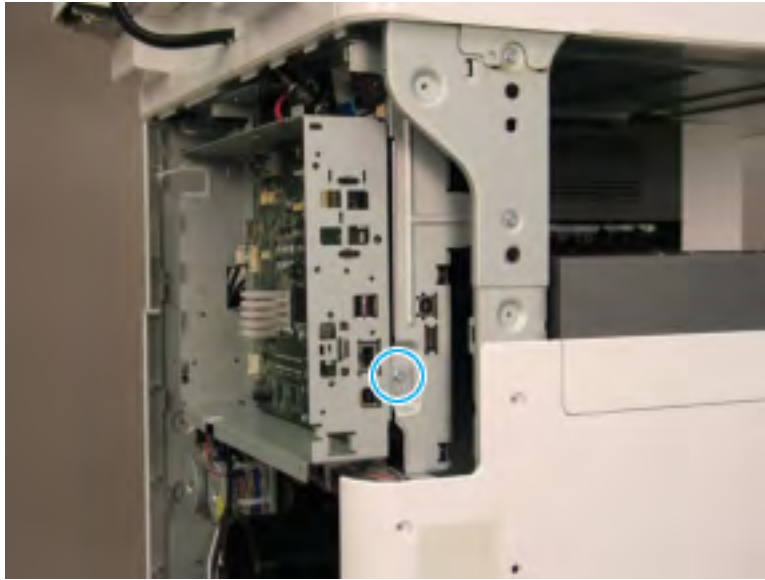
1. Disconnect ten connectors and two cable restraints.
2. Remove four screws and screw-caps, and then remove the left-upper cover.

**Figure 2-87** Remove the left-upper cover



3. Remove one screw from the side of the formatter cage (beneath the left-upper cover location).

Figure 2-88 Remove the formatter cage side screw



4. Remove three screws from the formatter cage face, and then release one tab to remove the formatter cage.

Figure 2-89 Remove three screws to remove the formatter cage



## Unpack the replacement assembly

Follow these steps to unpack the replacement assembly.

1. Dispose of the defective part.



---


 **NOTE:** HP recommends responsible disposal of the defective part.


<http://www8.hp.com/us/en/hp-information/environment/product-recycling.html>

---

2. Unpack the replacement part from the packaging.


 **CAUTION:**  Some parts are sensitive to electrostatic discharge (ESD). Always perform service work at an ESD-protected workstation or mat. If an ESD workstation or mat is not available, touch the sheet-metal chassis to provide a static ground before touching an ESD-sensitive assembly. Protect the ESD-sensitive assemblies by placing them in ESD pouches when they are out of the printer.

 **IMPORTANT:** Make sure that all of the shipping materials (for example shipping tape) are removed from the replacement part prior to installation.

 **NOTE:** If the replacement part is a roller or pad, avoid touching the spongy part of it. Skin oils on the roller or pad can cause paper pickup and/or print-quality problems. HP recommends using disposable gloves when handling rollers or pads or washing your hands before touching rollers or pads.

---

3. To install an assembly, reverse the removal steps.

 **NOTE:** When applicable, special installation instructions are provided for an assembly at the end of the removal procedure. Always completely read the removal instructions and follow all special installation instructions.

---

## Removal and replacement: Removal and replacement: 500 GB FIPS HDD/500 GB formatter HDD

This procedure is for removing the 500 GB FIPS HDD installed on the formatter.


 [View a video of removing and replacing the HDD \(E72520-E72530\).](#)

 [View a video of removing and replacing the HDD \(E77820-E77830\).](#)

Mean time to repair: 20 minutes

Service level: Intermediate

---


 **IMPORTANT:** When applicable, special installation instructions are provided for an assembly at the end of the removal procedure. Always completely read the removal instructions and follow all special installation instructions.

---

### Before performing service

- Disconnect the power cable.

---

 **WARNING!** To avoid damage to the printer, turn the printer off, wait 30 seconds, and then remove the power cable before attempting to service the printer.

---

Use the table below to identify the correct part number for your printer. To order the part, go to [www.hp.com/buy/parts](http://www.hp.com/buy/parts)

**Table 2-17** Part information

Part number	Part description
B5L29-67903	500 GB FIPS HDD
5851-6712	Formatter HDD - 500 GB SED

### Required tools

- #2 JIS screwdriver with a magnetic tip

### After performing service

#### Turn the printer power on

- Connect the power cable.
- Use the power switch to turn the power on.

### Post service test

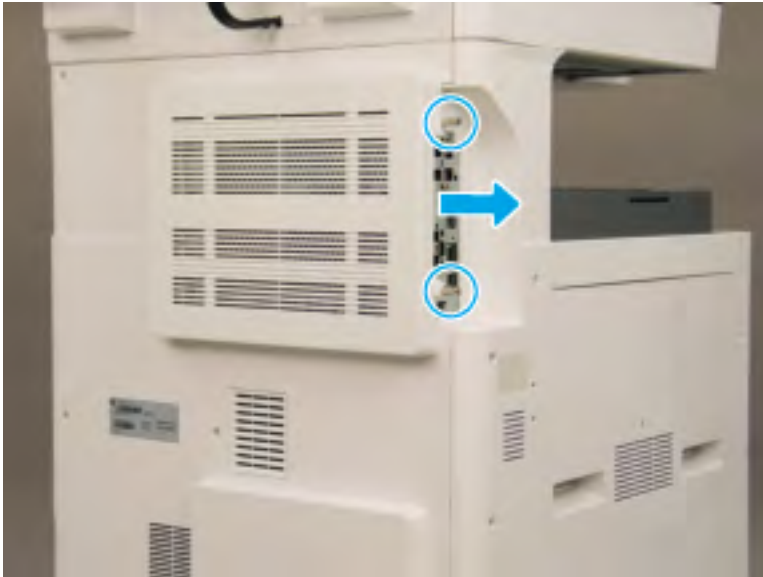
Copy, scan, or print a document. Verify the document copies, scans, or prints correctly.

### Remove the formatter cover

Follow these steps to remove the formatter cover.

- ▲ Unscrew two captive thumbscrews on the formatter cover. Slide the formatter cover to the left, and then to the right to remove.

Figure 2-90 Remove the formatter cover



## Remove the hard-disk drive (HDD)

Follow these steps to remove the hard-disk drive (HDD).

- ▲ Release one retainer, and then remove the HDD.

---

 **IMPORTANT:** The HDD and the IOD cannot be replaced at the same time.

---

Figure 2-91 Remove the hard-disk drive (HDD)



## Unpack the replacement assembly

Follow these steps to unpack the replacement assembly.

1. Dispose of the defective part.




**NOTE:** HP recommends responsible disposal of the defective part.

<http://www8.hp.com/us/en/hp-information/environment/product-recycling.html>

2. Unpack the replacement part from the packaging.



**CAUTION:**  Some parts are sensitive to electrostatic discharge (ESD). Always perform service work at an ESD-protected workstation or mat. If an ESD workstation or mat is not available, touch the sheet-metal chassis to provide a static ground before touching an ESD-sensitive assembly. Protect the ESD-sensitive assemblies by placing them in ESD pouches when they are out of the printer.



**IMPORTANT:** Make sure that all of the shipping materials (for example shipping tape) are removed from the replacement part prior to installation.



**NOTE:** If the replacement part is a roller or pad, avoid touching the spongy part of it. Skin oils on the roller or pad can cause paper pickup and/or print-quality problems. HP recommends using disposable gloves when handling rollers or pads or washing your hands before touching rollers or pads.

3. To install an assembly, reverse the removal steps.



**NOTE:** When applicable, special installation instructions are provided for an assembly at the end of the removal procedure. Always completely read the removal instructions and follow all special installation instructions.


## Removal and replacement: HP Foreign interface harness (FIH) solution

This document provides the procedures to install the Foreign Interface Harness (FIH) accessory.

 [View a video of installing the HP Foreign interface harness \(FIH\) accessory.](#)

Mean time to repair: 1 minute


Service level: Basic

 **IMPORTANT:** When applicable, special installation instructions are provided for an assembly at the end of the removal procedure. Always completely read the removal instructions and follow all special installation instructions.

### Before performing service

#### Turn the printer power off

- Disconnect the power cable.

 **WARNING!** To avoid damage to the printer, turn the printer off, wait 30 seconds, and then remove the power cable before attempting to service the printer.

Use the table below to identify the correct part number for your printer. To order the part, go to [www.hp.com/buy/parts](http://www.hp.com/buy/parts).

Table 2-18 Part information

Part number	Part description
B5L31-90902	Foreign Interface Harness (FIH)

### Required tools

- No special tools are required to remove this part.

### After performing service

#### Turn the printer power on

- Connect the power cable.
- Use the power switch to turn the power on.

### Post service test

Make sure that the printer initializes to a **Ready** state.

Connect a third party solution to the FIH, and then verify it correctly functions.


### Unpack the FIH accessory

Follow these steps to unpack the FIH accessory.

- ▲ Unpack the accessory from the packaging.



---

**CAUTION:**  Some parts are sensitive to electrostatic discharge (ESD). Always perform service work at an ESD-protected workstation or mat. If an ESD workstation or mat is not available, touch the sheet-metal chassis to provide a static ground before touching an ESD-sensitive assembly. Protect the ESD-sensitive assemblies by placing them in ESD pouches when they are out of the printer.

**IMPORTANT:**  Make sure that all of the shipping materials (for example shipping tape) are removed from the replacement part prior to installation.

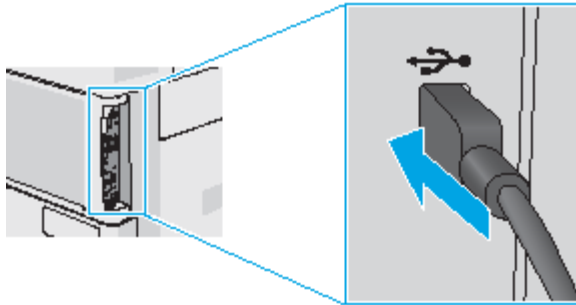
---

## Install the FIH accessory

Follow these steps to install the FIH accessory.

- ▲ Locate the USB connector on the printer formatter. Connect the FIH to this connector

Figure 2-92 Connect the FIH



## Unpack the replacement assembly

Follow these steps to unpack the replacement assembly.


1. Dispose of the defective part.


**NOTE:**  HP recommends responsible disposal of the defective part.


<http://www8.hp.com/us/en/hp-information/environment/product-recycling.html>

---

2. Unpack the replacement part from the packaging.


**CAUTION:**  Some parts are sensitive to electrostatic discharge (ESD). Always perform service work at an ESD-protected workstation or mat. If an ESD workstation or mat is not available, touch the sheet-metal chassis to provide a static ground before touching an ESD-sensitive assembly. Protect the ESD-sensitive assemblies by placing them in ESD pouches when they are out of the printer.

**IMPORTANT:**  Make sure that all of the shipping materials (for example shipping tape) are removed from the replacement part prior to installation.

**NOTE:**  If the replacement part is a roller or pad, avoid touching the spongy part of it. Skin oils on the roller or pad can cause paper pickup and/or print-quality problems. HP recommends using disposable gloves when handling rollers or pads or washing your hands before touching rollers or pads.

---

3. To install an assembly, reverse the removal steps.

**NOTE:**  When applicable, special installation instructions are provided for an assembly at the end of the removal procedure. Always completely read the removal instructions and follow all special installation instructions.


---

## Removal and replacement: NFC Kit installation

This document provides the procedures to install the NFC kit.

Mean time to repair: 5 minutes


Service level: Basic

 **IMPORTANT:** When applicable, special installation instructions are provided for an assembly at the end of the removal procedure. Always completely read the removal instructions and follow all special installation instructions.

### Before performing service

#### Turn the printer power off

- Disconnect the power cable.

 **WARNING!** To avoid damage to the printer, turn the printer off, wait 30 seconds, and then remove the power cable before attempting to service the printer.

Use the table below to identify the correct part number for your printer. To order the part, go to [www.hp.com/buy/parts](http://www.hp.com/buy/parts).

Table 2-19 Part information

Part number	Part description
J8030-61001	Jetdirect Wireless Print Server with NFC Kit

### Required tools

- No special tools are required to remove this part.

### After performing service

#### Turn the printer power on

- Connect the power cable.
- Use the power switch to turn the power on.

### Post service test

Make sure that the printer initializes to a **Ready** state.



Connect a third party solution to the FIH, and then verify it correctly functions.

### Unpack the NFC kit

Follow these steps to unpack the NFC kit.

- ▲ Unpack the kit from the packaging.

---

 **CAUTION:**  Some parts are sensitive to electrostatic discharge (ESD). Always perform service work at an ESD-protected workstation or mat. If an ESD workstation or mat is not available, touch the sheet-metal chassis to provide a static ground before touching an ESD-sensitive assembly. Protect the ESD-sensitive assemblies by placing them in ESD pouches when they are out of the printer.

 **IMPORTANT:** Make sure that all of the shipping materials (for example shipping tape) are removed from the part prior to installation.

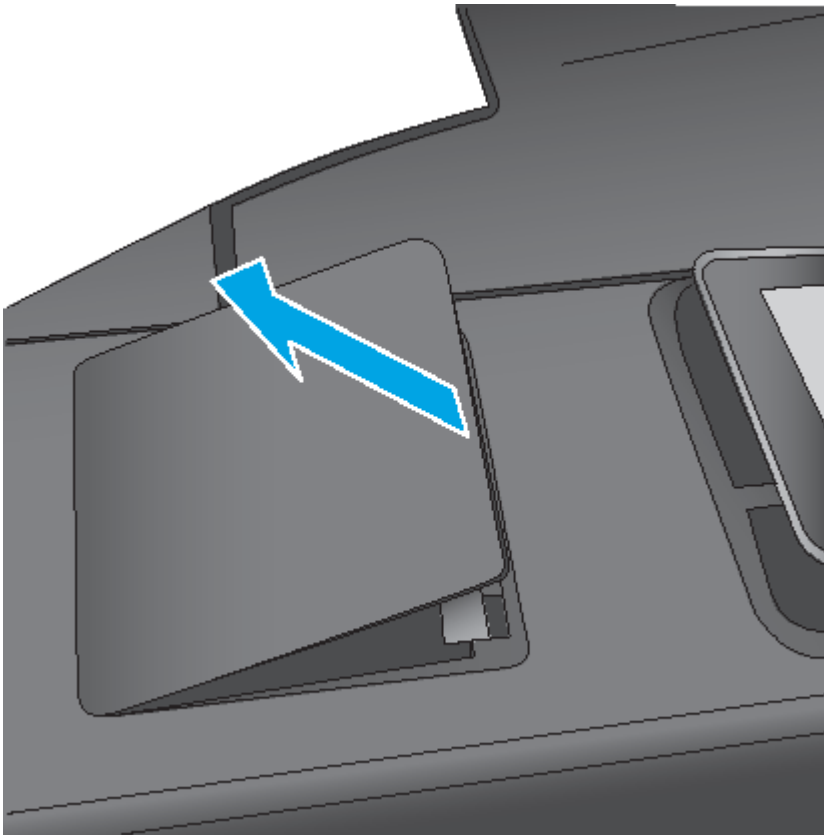
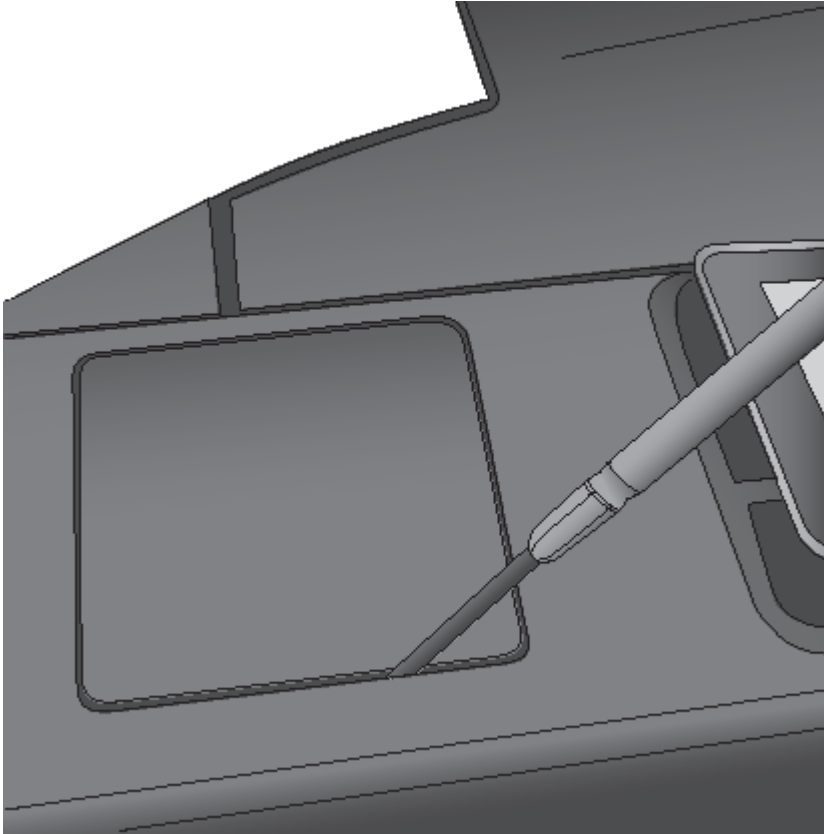
---

## Install the NFC kit

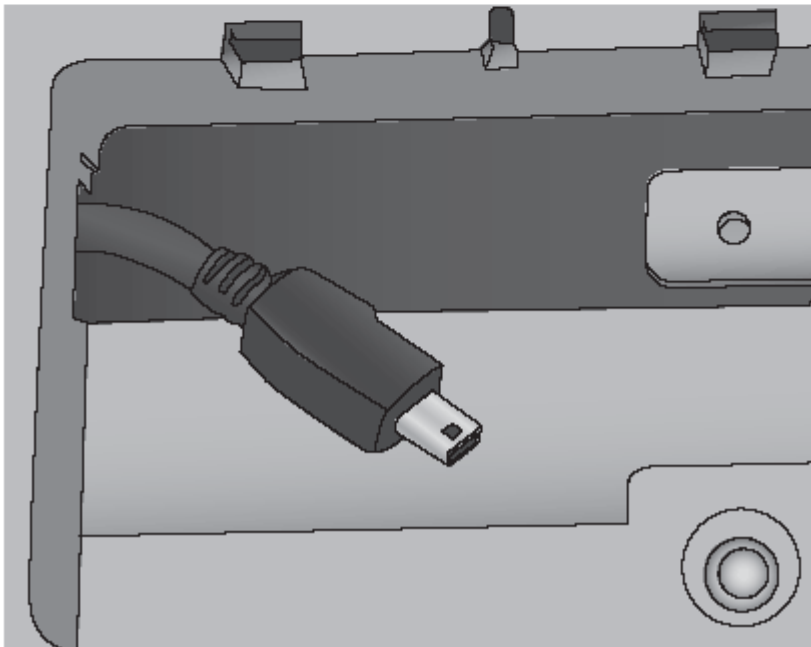
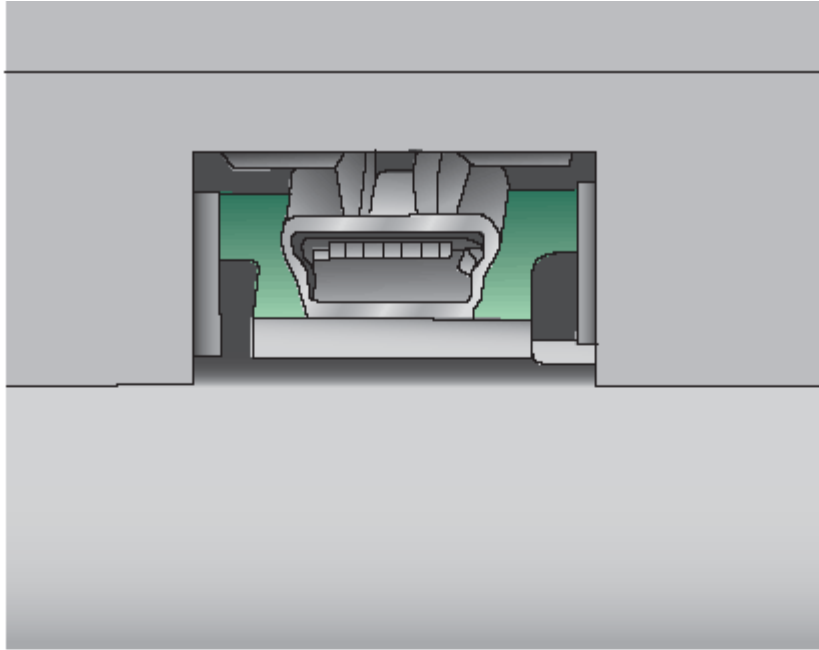
Follow these steps to install the NFC kit.

1. Turn off the power to the product.

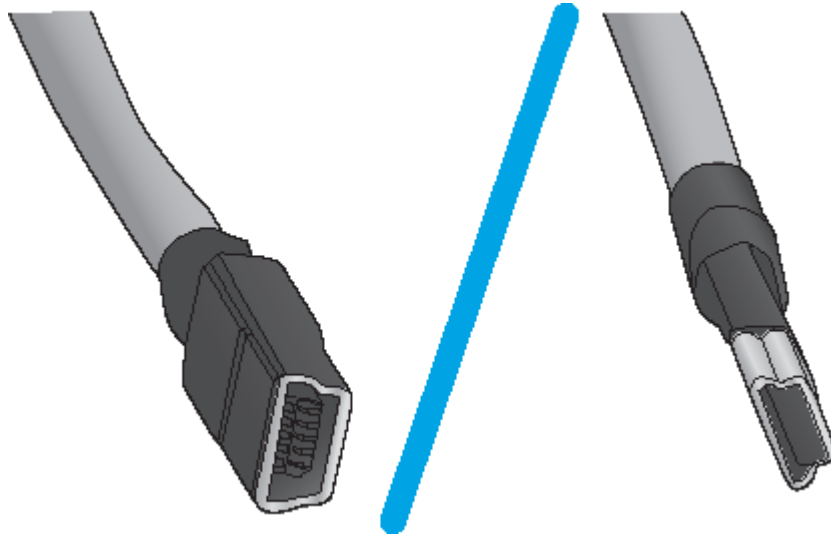
2. Remove the HIP cover.



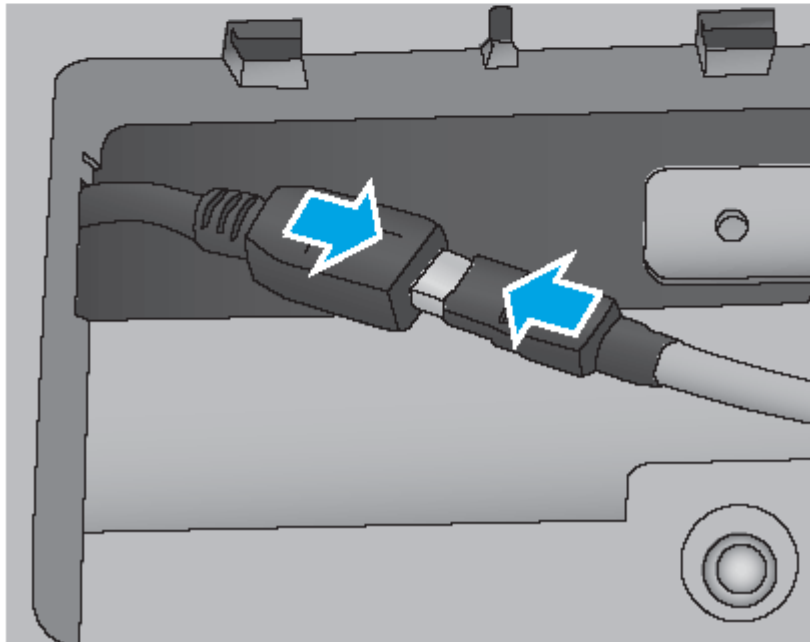
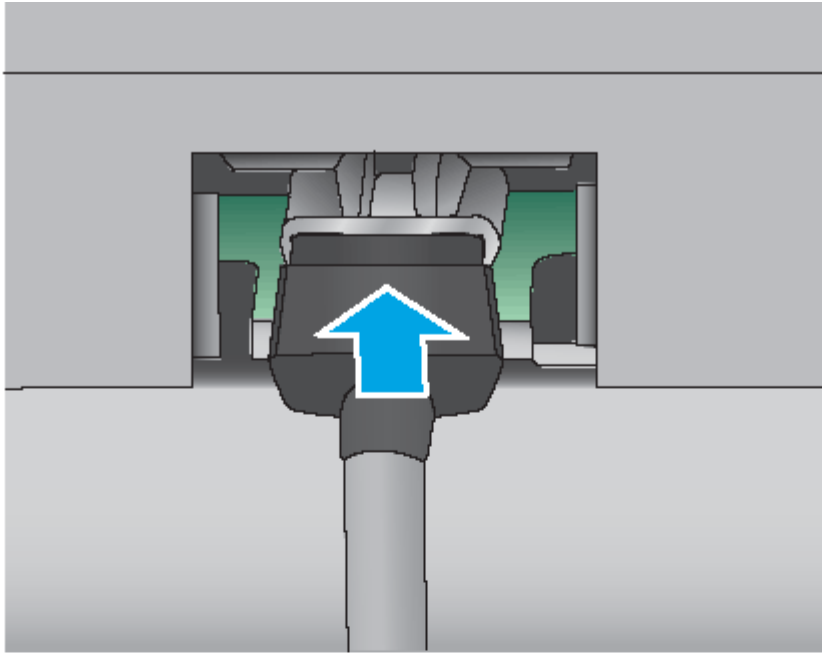
3. Identify the USB connector in the HIP and attach the appropriate USB cable:
  - a. Locate the USB connector that is along one of the short edges. A USB Mini B receptacle (callout 1.1) is the most common. However, on some models, a USB Mini B plug (callout 1.2) is used.




- b. Select the appropriate cable from the two that are provided.



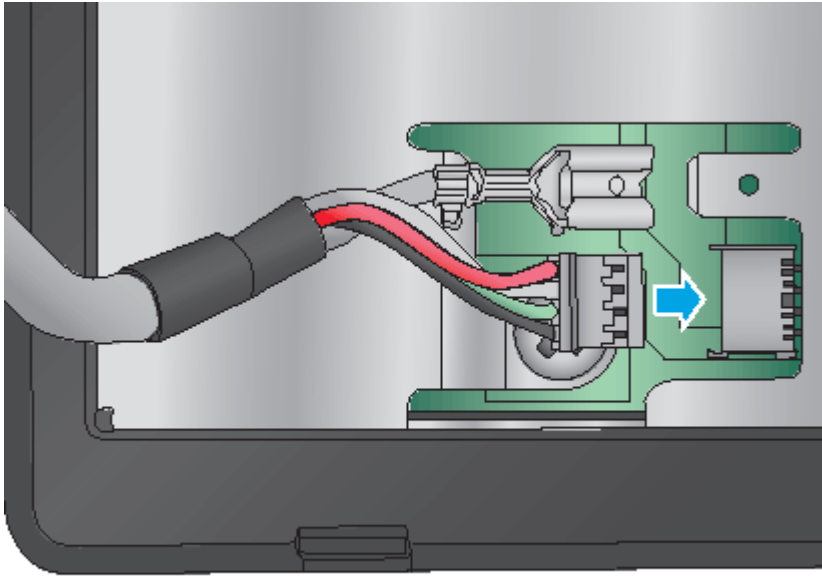
- c. Plug the USB cable into the socket in the HIP. Note that the USB logo on the connector may face down on some models of printers/MFPs.



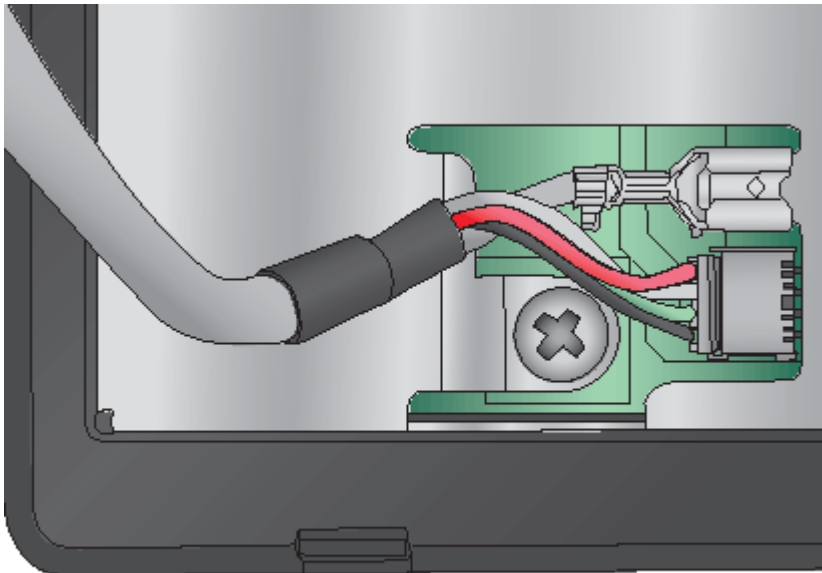
4. Attach the power and grounding ends of the USB cable:

 **NOTE:** Before connecting the NFC accessory to the USB connector, verify that the product power is turned off.

- a. Attach the white power connector of the cable into the corresponding receptacle on the underside of the NFC accessory with the contacts facing down.

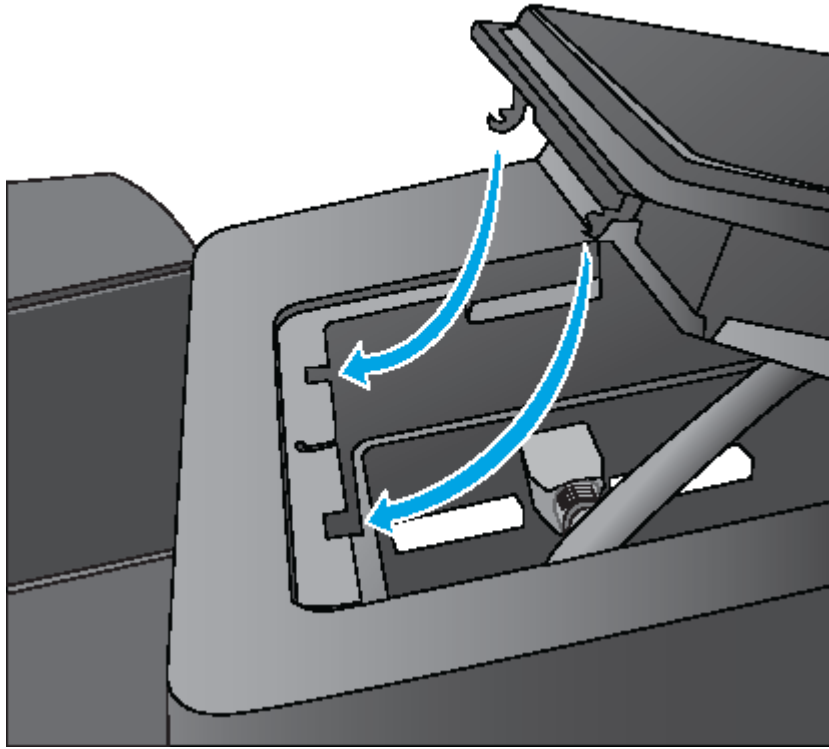


- b. Attach the metal ground connector of the cable to the grounding tab on the underside of the

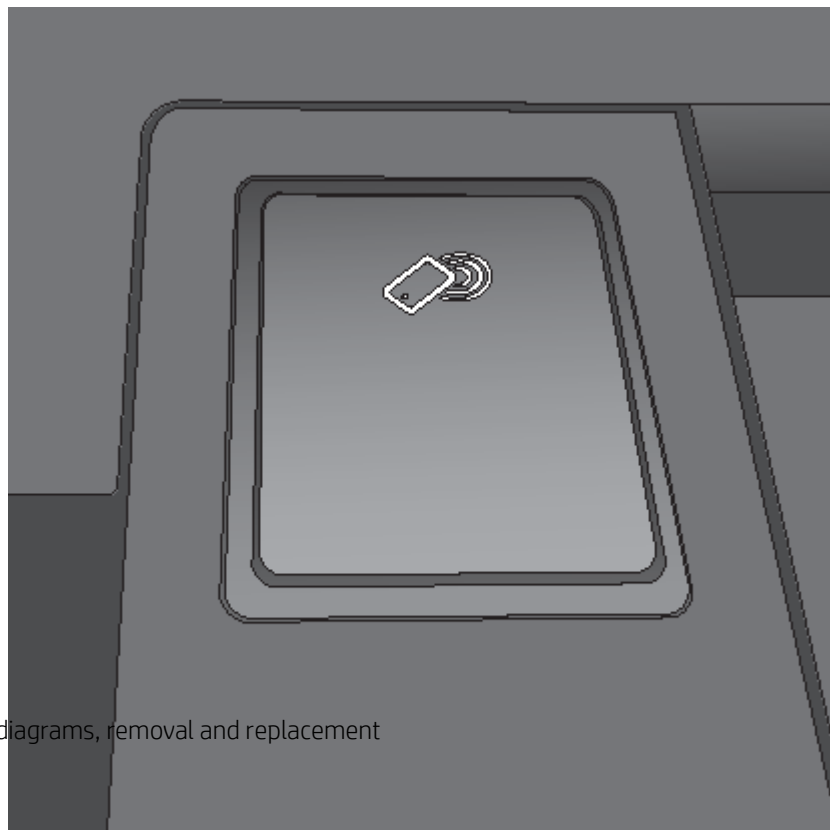
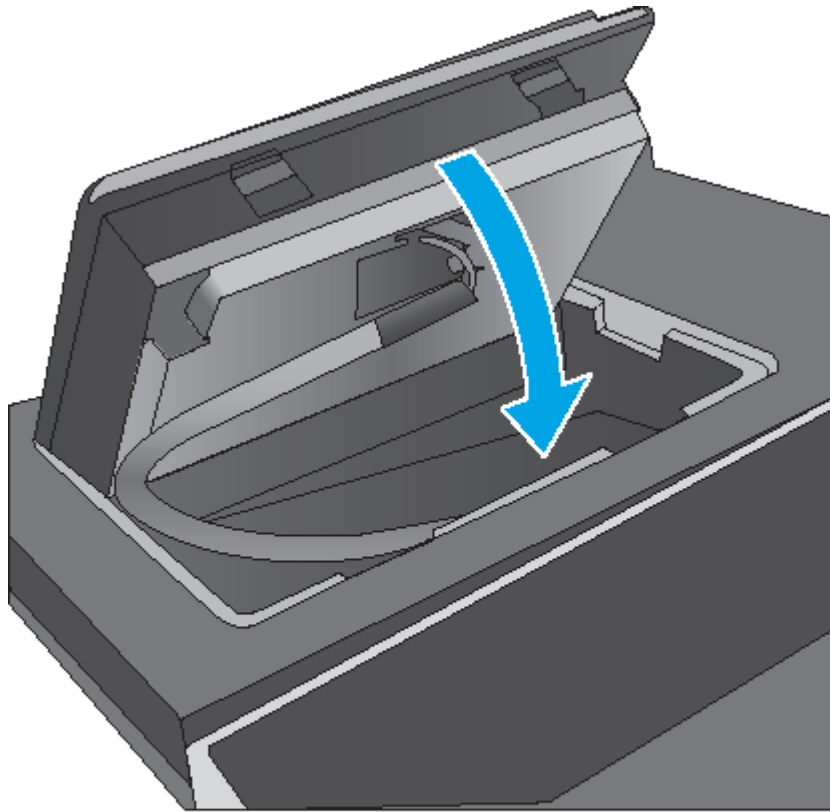


5. Insert the NFC accessory into the HIP recess.
  - a. Insert the NFC accessory into the HIP recess using the hook-shaped clips first.





- b. Gently push the NFC accessory onto the rounded clips so that it is held securely in place within the recess.



wireless network icon will also appear on the control panel.

## Unpack the replacement assembly

Follow these steps to unpack the replacement assembly.

1. Dispose of the defective part.




**NOTE:** HP recommends responsible disposal of the defective part.

<http://www8.hp.com/us/en/hp-information/environment/product-recycling.html>

---

2. Unpack the replacement part from the packaging.



**CAUTION:**  Some parts are sensitive to electrostatic discharge (ESD). Always perform service work at an ESD-protected workstation or mat. If an ESD workstation or mat is not available, touch the sheet-metal chassis to provide a static ground before touching an ESD-sensitive assembly. Protect the ESD-sensitive assemblies by placing them in ESD pouches when they are out of the printer.



**IMPORTANT:** Make sure that all of the shipping materials (for example shipping tape) are removed from the replacement part prior to installation.



**NOTE:** If the replacement part is a roller or pad, avoid touching the spongy part of it. Skin oils on the roller or pad can cause paper pickup and/or print-quality problems. HP recommends using disposable gloves when handling rollers or pads or washing your hands before touching rollers or pads.

---

3. To install an assembly, reverse the removal steps.



**NOTE:** When applicable, special installation instructions are provided for an assembly at the end of the removal procedure. Always completely read the removal instructions and follow all special installation instructions.

---


## Removal and replacement: Main board

This document provides the procedures to remove the main board assembly.




Mean time to repair: 15 minutes

Service level: Intermediate

 **IMPORTANT:** When applicable, special installation instructions are provided for an assembly at the end of the removal procedure. Always completely read the removal instructions and follow all special installation instructions.

### Before performing service

- Disconnect the power cable.

 **WARNING!** To avoid damage to the printer, turn the printer off, wait 30 seconds, and then remove the power cable before attempting to service the printer.

Use the table below to identify the correct part number for your printer. To order the part, go to [www.hp.com/buy/parts](http://www.hp.com/buy/parts)

**Table 2-20** Part information

Part number	Part description
JC82-00540A	Main board whole unit (E778xx series)
8GR94-60003	Main board whole unit (E783xx series)

### Required tools

- #2 JIS screwdriver with a magnetic tip

### After performing service

#### Turn the printer power on

- Connect the power cable.
- Use the power switch to turn the power on.

### Post service test

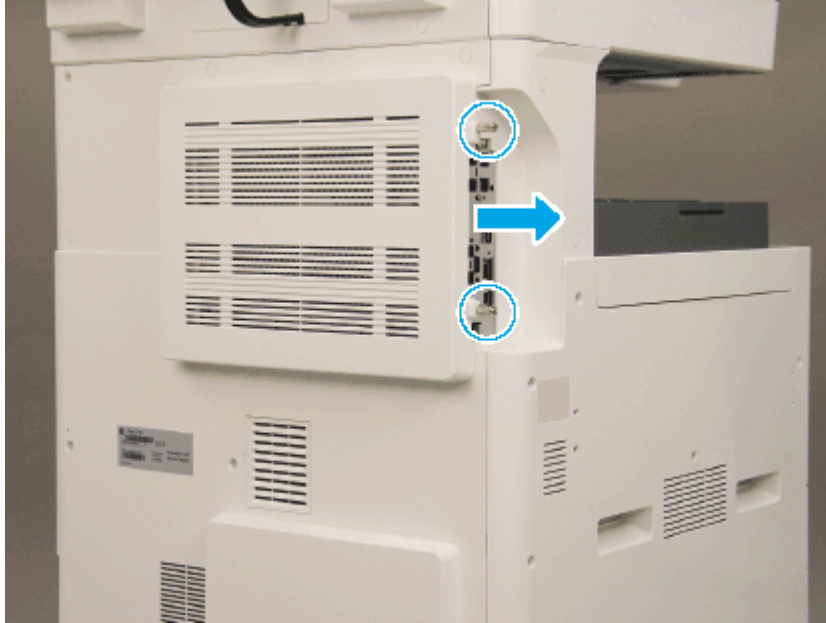
Copy, scan, or print a document. Verify the document copies, scans, or prints correctly.

### Remove the rear covers

Follow these steps to remove the rear covers.

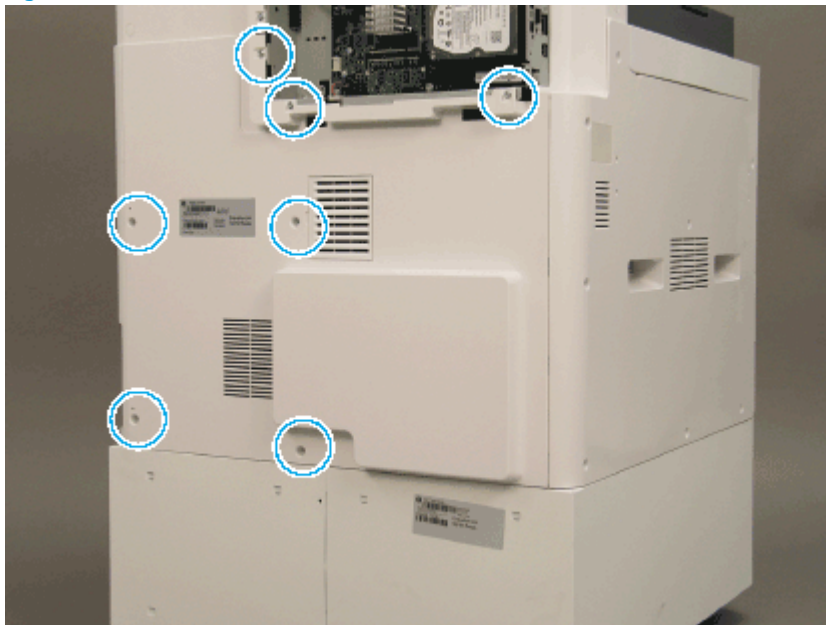
1. Unscrew two captive thumbscrews on the formatter cover. Slide the formatter cover to the left, and then to the right to remove.

Figure 2-93 Remove the formatter cover



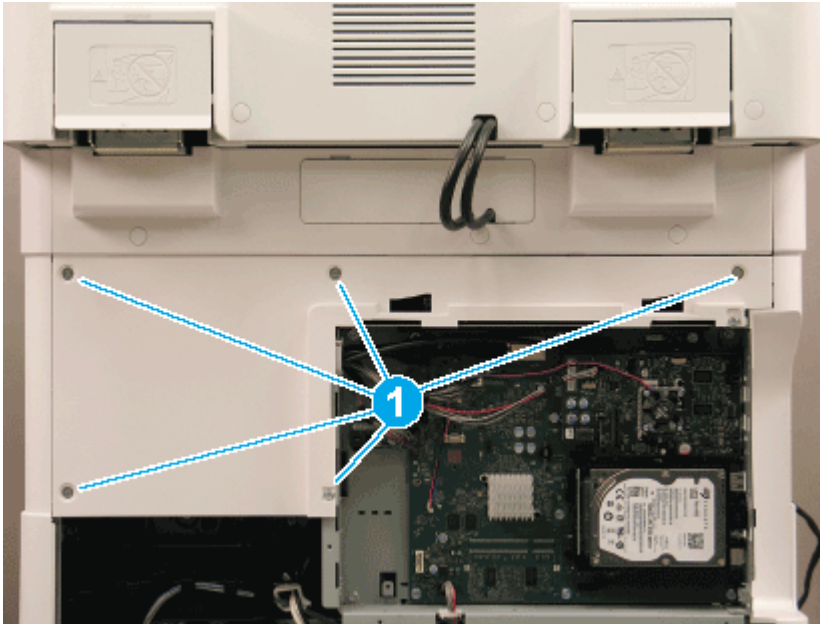
2. Remove seven screws, and then remove the rear-bottom cover.

Figure 2-94 Remove the rear-bottom cover



3. Remove six screws (callout 1), and then remove the rear-top cover.

Figure 2-95 Remove the rear-top cover

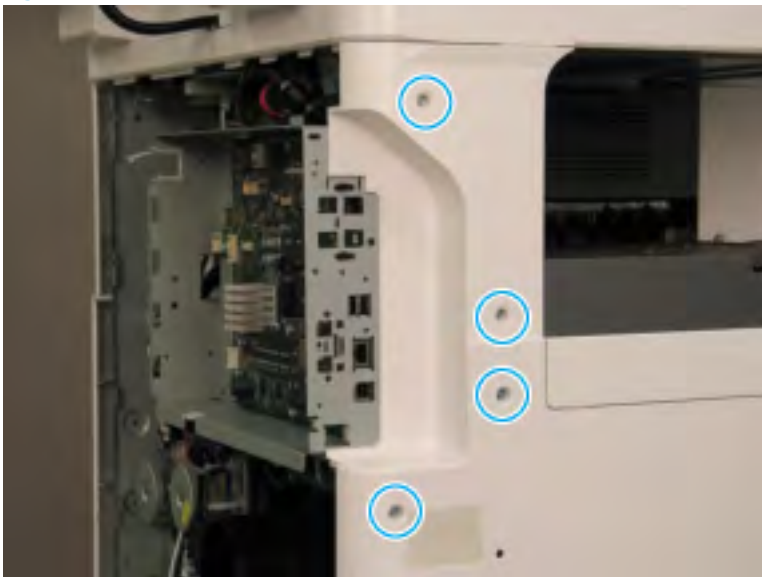


### Remove the formatter cage

Follow these steps to remove the formatter cage.

1. Disconnect ten connectors and two cable restraints.
2. Remove four screws and screw-caps, and then remove the left-upper cover.

Figure 2-96 Remove the left-upper cover



3. Remove one screw from the side of the formatter cage (beneath the left-upper cover location).

Figure 2-97 Remove the formatter cage side screw



4. Remove three screws from the formatter cage face, and then release one tab to remove the formatter cage.

Figure 2-98 Remove three screws to remove the formatter cage

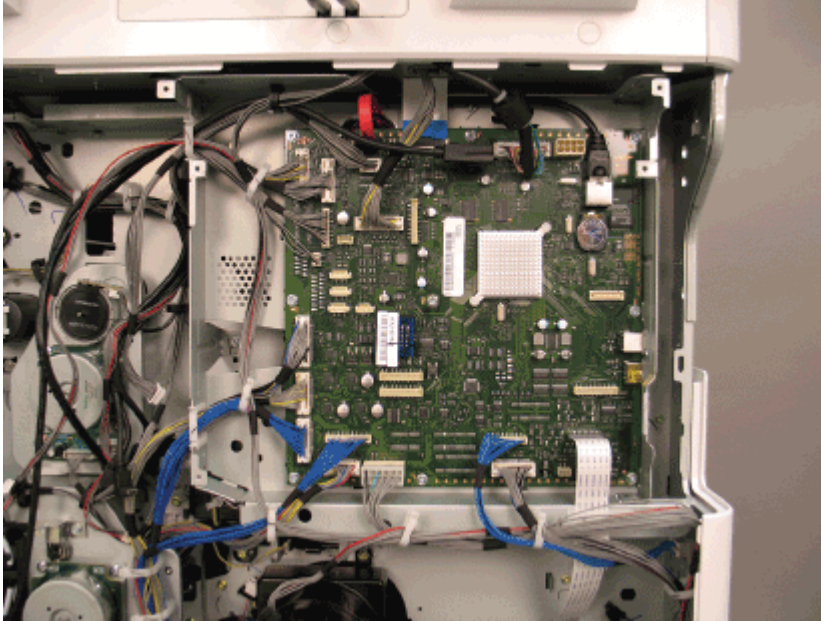


## Remove the main board

Follow these steps to remove the main board.

1. Disconnect 24 connectors and three FFCs on the main board.

Figure 2-99 Remove the main board connectors and screws



2. Remove nine screws, and then remove the main board.
3. Disconnect the MSOK from the removed main board, noting its orientation. Transfer the MSOK to the replacement main board and install it using the same orientation.

---

 **TIP:** The main board is marked to show the correct orientation of the MSOK when installed.

 **IMPORTANT:** A Shading Test for the ADF must be completed after replacing the ADF unit or the Main board.

---

Figure 2-100 MSOK installation orientation



## Unpack the replacement assembly

Follow these steps to unpack the replacement assembly.

1. Dispose of the defective part.





---

 **NOTE:** HP recommends responsible disposal of the defective part.


<http://www8.hp.com/us/en/hp-information/environment/product-recycling.html>

---

2. Unpack the replacement part from the packaging.


 **CAUTION:**  Some parts are sensitive to electrostatic discharge (ESD). Always perform service work at an ESD-protected workstation or mat. If an ESD workstation or mat is not available, touch the sheet-metal chassis to provide a static ground before touching an ESD-sensitive assembly. Protect the ESD-sensitive assemblies by placing them in ESD pouches when they are out of the printer.

 **IMPORTANT:** Make sure that all of the shipping materials (for example shipping tape) are removed from the replacement part prior to installation.

 **NOTE:** If the replacement part is a roller or pad, avoid touching the spongy part of it. Skin oils on the roller or pad can cause paper pickup and/or print-quality problems. HP recommends using disposable gloves when handling rollers or pads or washing your hands before touching rollers or pads.

---

3. To install an assembly, reverse the removal steps.

 **NOTE:** When applicable, special installation instructions are provided for an assembly at the end of the removal procedure. Always completely read the removal instructions and follow all special installation instructions.

---


## Removal and replacement: Developer unit

This document provides the procedures to remove the developer unit(s).

 [View a video of removing the developer unit.](#)

Mean time to repair: 10 minutes

Service level: Basic

 **IMPORTANT:** When applicable, special installation instructions are provided for an assembly at the end of the removal procedure. Always completely read the removal instructions and follow all special installation instructions.

### Before performing service

- Disconnect the power cable.

Use the table below to identify the correct part number for your printer. To order the part, go to [www.hp.com/buy/parts](http://www.hp.com/buy/parts)

**Table 2-21 Part information**

Part number	Part description
JC-96-11666A	Kit-HP LaserJet Black Developer Unit (E778xx series)
8JM70-67001	Kit-HP LaserJet Black Developer Unit (E783xx series)
JC-96-11663A	Kit-HP LaserJet Yellow Developer Unit (E778xx series)
8JM72-67001	Kit-HP LaserJet Yellow Developer Unit (E783xx series)
JC-96-11664A	Kit-HP LaserJet Magenta Developer Unit (E778xx series)
8JM73-67001	Kit-HP LaserJet Magenta Developer Unit (E783xx series)
JC-96-11665A	Kit-HP LaserJet Cyan Developer Unit (E778xx series)
8JM71-67001	Kit-HP LaserJet Cyan Developer Unit (E783xx series)

### Required tools

- #2 JIS screwdriver with a magnetic tip

### After performing service

#### Turn the printer power on

- Connect the power cable.
- Use the power switch to turn the power on.

### Post service test

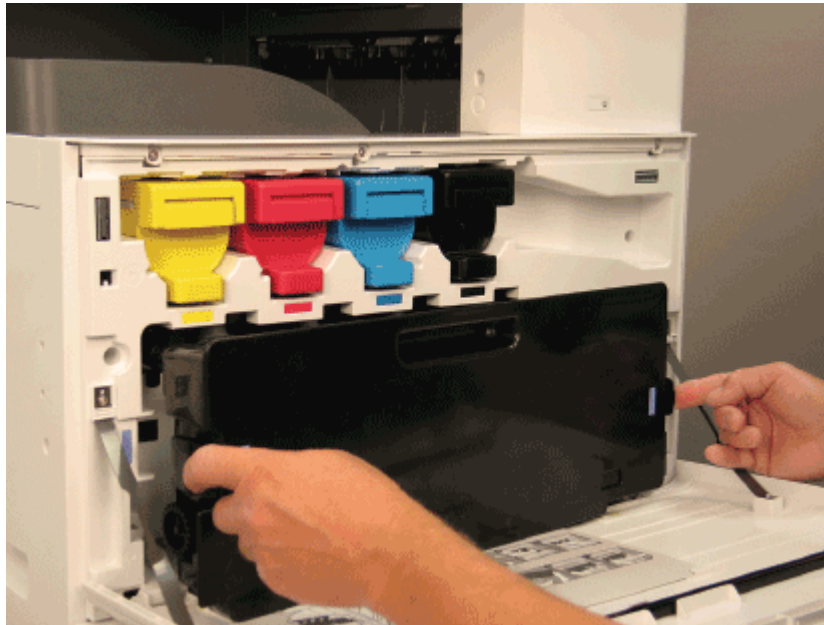
Copy, scan, or print a document. Verify the document copies, scans, or prints correctly.

## Remove the developer unit

Follow these steps to remove the developer unit.

1. Turn off the printer. Open the front door and remove the toner collection unit.

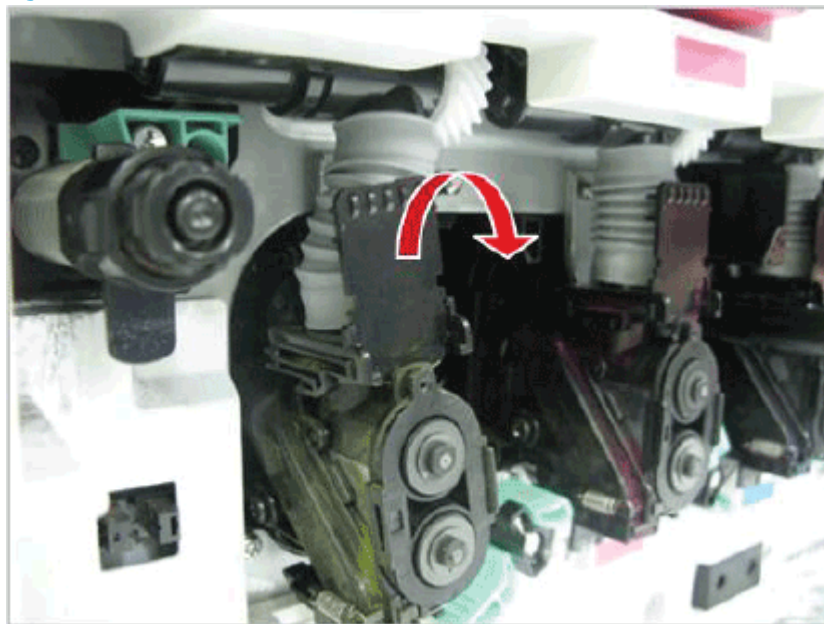
**Figure 2-101** Remove the toner collection unit



2. Remove the imaging drum that corresponds with the developer unit being replaced.
3. Fold down the toner supply shutter.

**CAUTION:** The toner supply cap contains toner. Use caution to avoid spilling toner during removal.

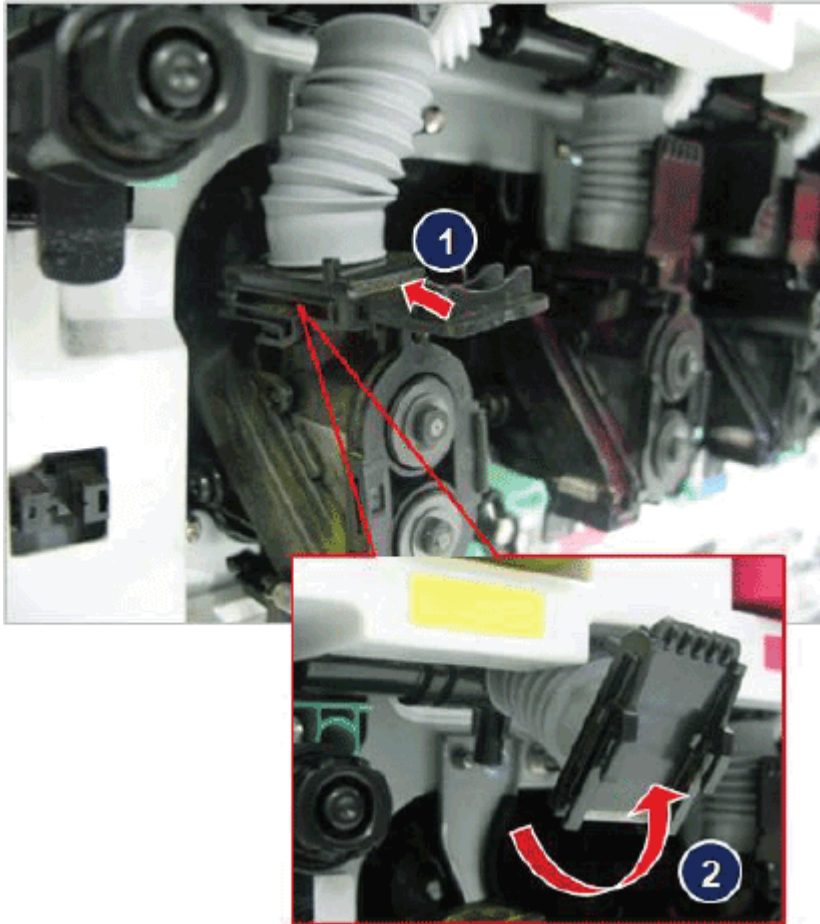
**Figure 2-102** Fold down the toner supply shutter



4. Push the shutter in to close the toner supply (callout 1). Grasp the toner supply connection on the black plastic and wiggle and pull out to disengage the connection from the developing unit. Rotate the toner supply up (callout 2).

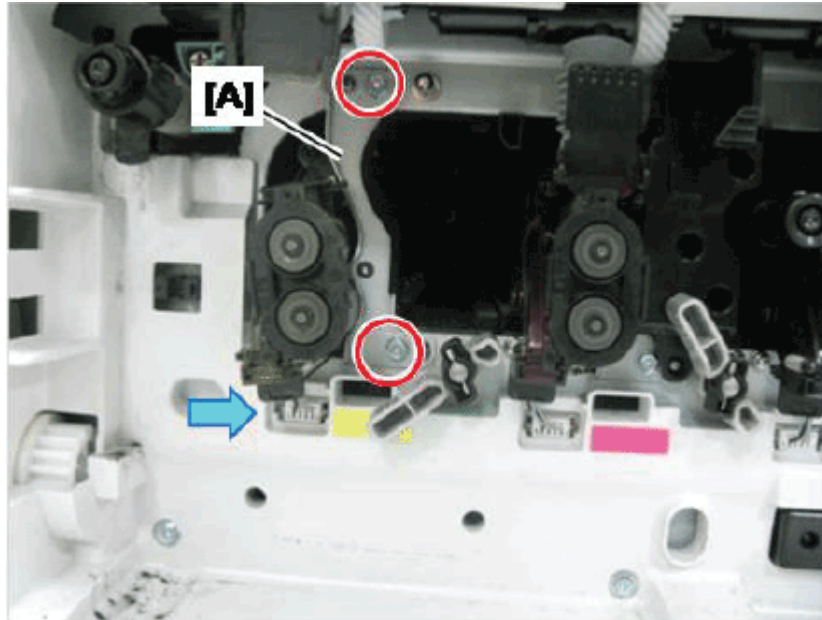
**⚠ CAUTION:** Do not compress or squeeze the gray supply pipe. This supply pipe is filled with toner and will leak if squeezed.

Figure 2-103 Rotate swivel



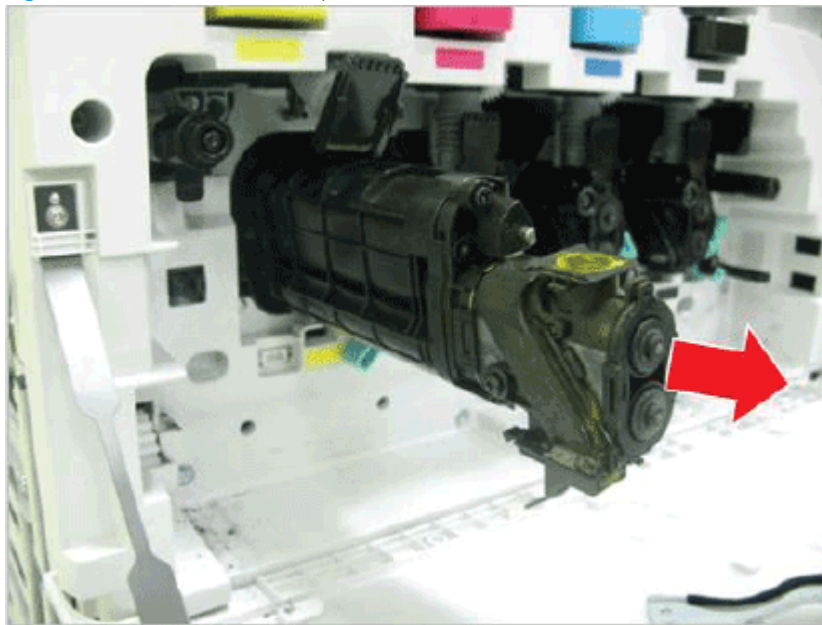
5. Remove 2 screws and then remove the bracket (A). Disconnect the connector.


Figure 2-104 Remove bracket




6. Remove the developer unit.

Figure 2-105 Remove developer unit



 **NOTE:** The carrier in this printer series developer unit cannot be changed. The entire developer unit must be replaced.

 **NOTE:** When the assembly is installed, make sure that the bracket is seated correctly and that the bracket screws are installed. Install the toner supply by swiveling down to the normal position, and make sure the toner supply shutter is pulled up to the "open" position. Reinstall the imaging drum, then reinstall the toner collection unit.

## Unpack the replacement assembly

Follow these steps to unpack the replacement assembly.

1. Dispose of the defective part.




**NOTE:** HP recommends responsible disposal of the defective part.

<http://www8.hp.com/us/en/hp-information/environment/product-recycling.html>

---

2. Unpack the replacement part from the packaging.



**CAUTION:**  Some parts are sensitive to electrostatic discharge (ESD). Always perform service work at an ESD-protected workstation or mat. If an ESD workstation or mat is not available, touch the sheet-metal chassis to provide a static ground before touching an ESD-sensitive assembly. Protect the ESD-sensitive assemblies by placing them in ESD pouches when they are out of the printer.



**IMPORTANT:** Make sure that all of the shipping materials (for example shipping tape) are removed from the replacement part prior to installation.



**NOTE:** If the replacement part is a roller or pad, avoid touching the spongy part of it. Skin oils on the roller or pad can cause paper pickup and/or print-quality problems. HP recommends using disposable gloves when handling rollers or pads or washing your hands before touching rollers or pads.

---

3. To install an assembly, reverse the removal steps.



**NOTE:** When applicable, special installation instructions are provided for an assembly at the end of the removal procedure. Always completely read the removal instructions and follow all special installation instructions.

---

## Removal and replacement: Imaging drum


This document provides the procedures to remove the imaging drum.

 [View a video of removing the imaging drum.](#)

Mean time to repair: 5 minutes

Service level: Basic

---

 **IMPORTANT:** When applicable, special installation instructions are provided for an assembly at the end of the removal procedure. Always completely read the removal instructions and follow all special installation instructions.

---

### Before performing service

- Disconnect the power cable.

Use the table below to identify the correct part number for your printer. To order the part, go to [www.hp.com/buy/parts](http://www.hp.com/buy/parts)

**Table 2-22 Part information**

Part number	Part description
X3A83-67905	Imaging drum (E778xx series)
W9215-67901	Imaging drum (E783xx series)

### Required tools

- #2 JIS screwdriver with a magnetic tip

### After performing service

#### Turn the printer power on

- Connect the power cable.
- Use the power switch to turn the power on.

### Post service test

Copy, scan, or print a document. Verify the document copies, scans, or prints correctly.

## Remove the imaging drum

Follow these steps to remove the imaging drum.

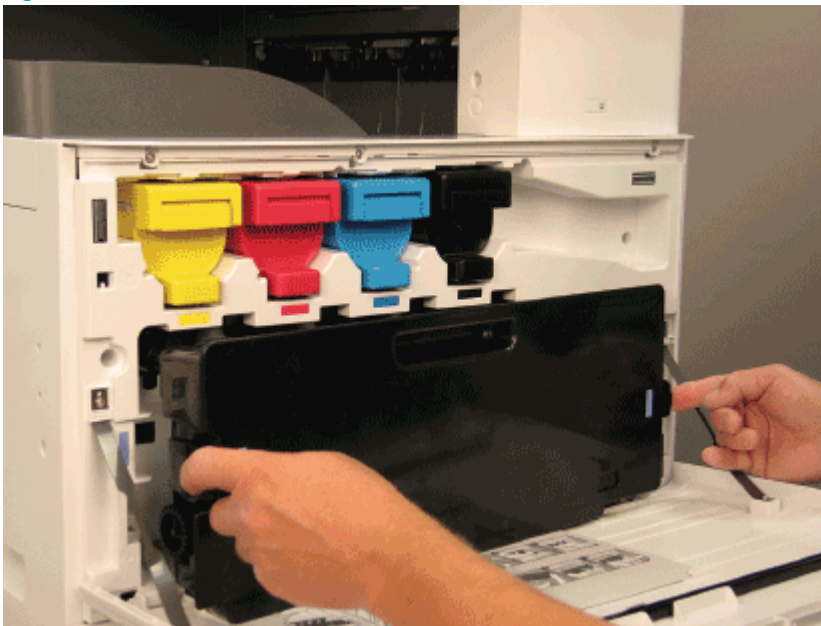
1. Open the front cover.

Figure 2-106 Open the front cover



2. Open the right door and make sure the latch releases.
3. Remove the toner collection unit.

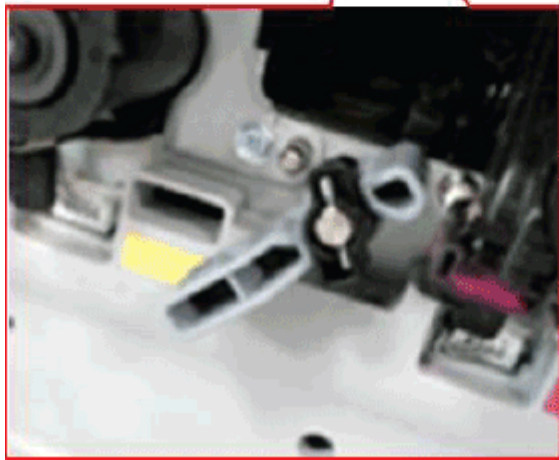
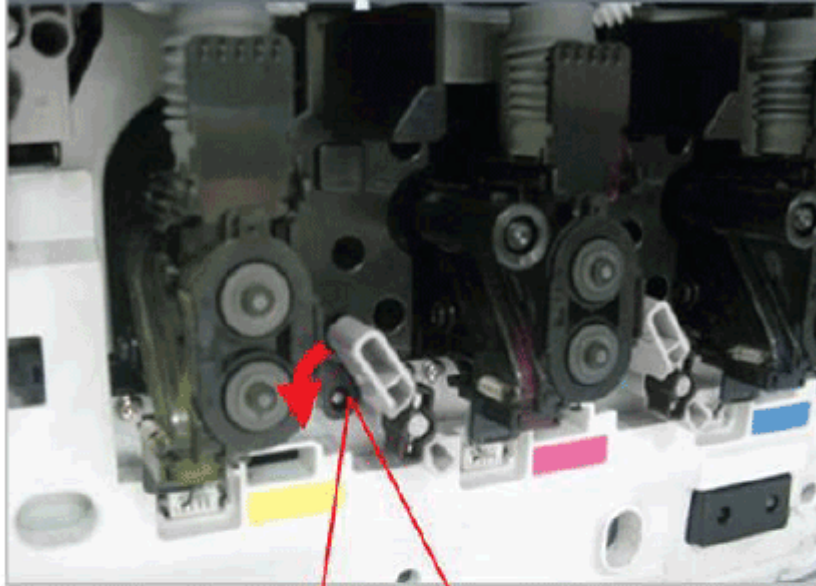
Figure 2-107 Remove the toner collection unit.





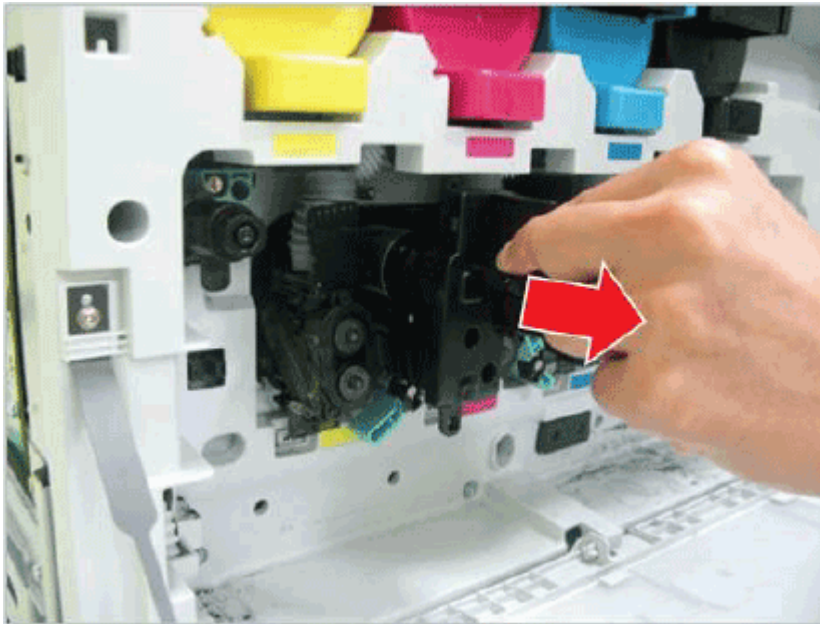
4. Turn the locking level counterclockwise.

Figure 2-108 Turn level counterclockwise




5. Remove the imaging drum.

Figure 2-109 Remove the imaging drum



6. If installing a new imaging drum, remove from the imaging drum from its packaging, and then rotate the locking lever clockwise until it makes a solid “click”.

---

 **NOTE:** If you intend to reuse an imaging drum, make sure the imaging drum surface is covered and not exposed to direct light or sunlight. Cover the imaging drum with a few sheets of paper or keep it in the original packaging until ready to install. When handling any imaging drum, do not touch the drum surface.

---

## Unpack the replacement assembly

Follow these steps to unpack the replacement assembly.

1. Dispose of the defective part.

---



 **NOTE:** HP recommends responsible disposal of the defective part.


<http://www8.hp.com/us/en/hp-information/environment/product-recycling.html>


---

2. Unpack the replacement part from the packaging.

---

 **CAUTION:**  Some parts are sensitive to electrostatic discharge (ESD). Always perform service work at an ESD-protected workstation or mat. If an ESD workstation or mat is not available, touch the sheet-metal chassis to provide a static ground before touching an ESD-sensitive assembly. Protect the ESD-sensitive assemblies by placing them in ESD pouches when they are out of the printer.

 **IMPORTANT:** Make sure that all of the shipping materials (for example shipping tape) are removed from the replacement part prior to installation.

 **NOTE:** If the replacement part is a roller or pad, avoid touching the spongy part of it. Skin oils on the roller or pad can cause paper pickup and/or print-quality problems. HP recommends using disposable gloves when handling rollers or pads or washing your hands before touching rollers or pads.

---

3. To install an assembly, reverse the removal steps.



---

**NOTE:** When applicable, special installation instructions are provided for an assembly at the end of the removal procedure. Always completely read the removal instructions and follow all special installation instructions.


---

## Removal and replacement: Front cover open switch

This document provides the procedures to remove the front cover open switch assembly.

Mean time to repair: 15 minutes

Service level: Intermediate

 **IMPORTANT:** When applicable, special installation instructions are provided for an assembly at the end of the removal procedure. Always completely read the removal instructions and follow all special installation instructions.

### Before performing service

- Disconnect the power cable.

Use the table below to identify the correct part number for your printer. To order the part, go to [www.hp.com/buy/parts](http://www.hp.com/buy/parts)

**Table 2-23** Part information

Part number	Part description
JC93-00466A	APS sensor assembly

### Required tools

- #2 JIS screwdriver with a magnetic tip

### After performing service

#### Turn the printer power on

- Connect the power cable.
- Use the power switch to turn the power on.

### Post service test

Copy, scan, or print a document. Verify the document copies, scans, or prints correctly.

## Remove the front cover open switch

Follow these steps to remove the front cover open switch.

1. Open the right door.

Figure 2-110 Open right door



2. Remove two screw-caps and two screws (callout 1).


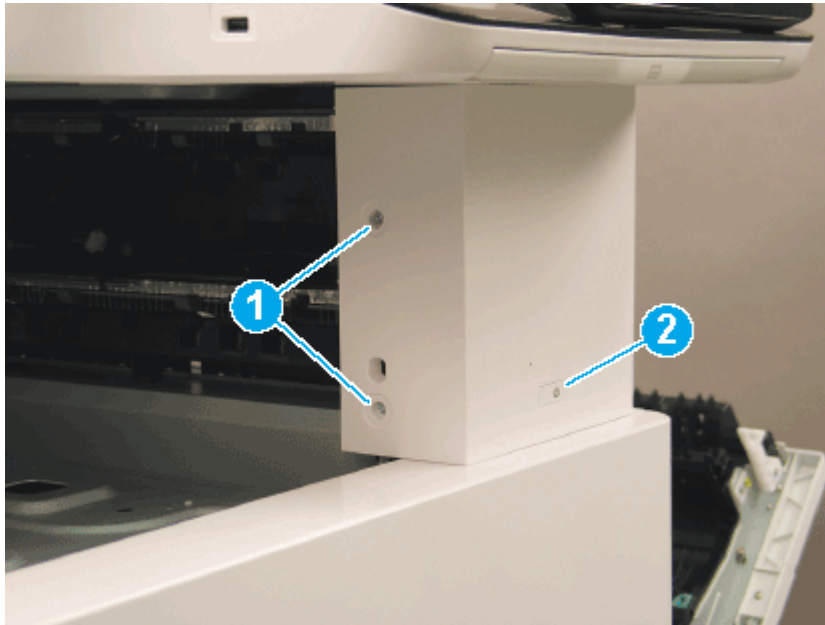
 **NOTE:** Do not dislodge the power button (callout 2) when the cover is removed.

Figure 2-111 Remove screw-caps and screws



3. GX/z models: Remove two screws.

 **NOTE:** Do not dislodge the power button when the cover is removed.

---

**Figure 2-112** Remove screws



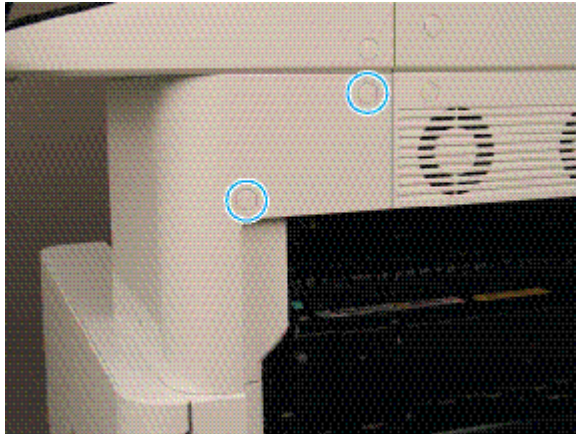
4. LX/dn Models: Remove one screw inside of right door.

**Figure 2-113** Remove one screw



5. GX/z models: Remove two screws.

Figure 2-114 Remove two screws



6. Remove the front-top cover.

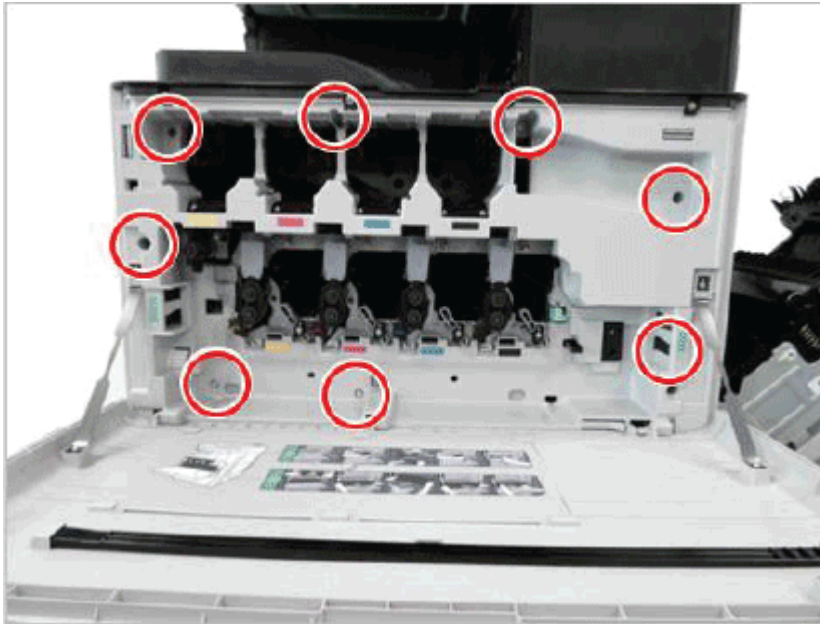
Figure 2-115 Remove the front top cover



7. Open the front door. Remove the Toner Collection Unit (TCU). Remove all toner cartridges.
8. Remove three tapping screws and remove the top front cover.

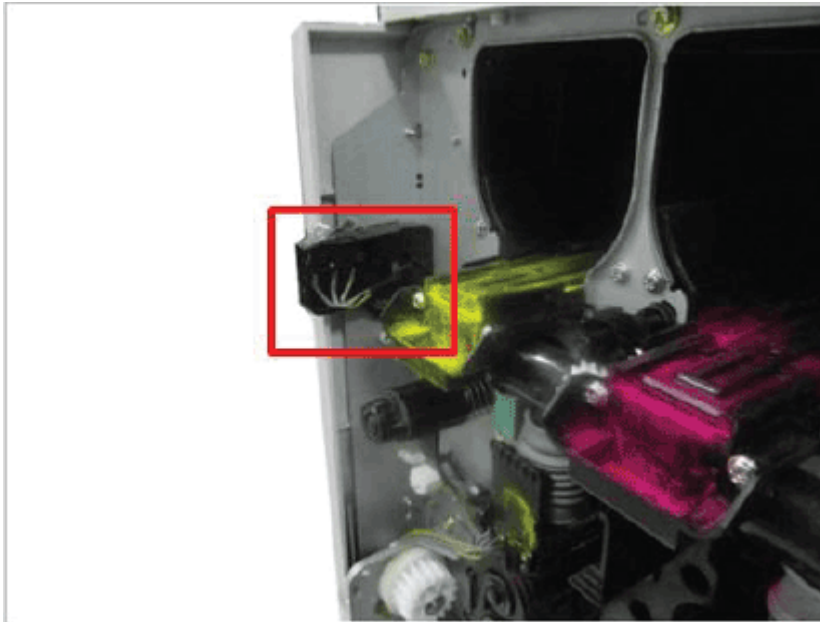
9. Remove eight screws, and then remove the front inner cover.

Figure 2-116 Remove screws and front inner cover



10. Remove one screw, and then remove the cover-open switch.

Figure 2-117 Remove screw and cover-open switch



## Unpack the replacement assembly

Follow these steps to unpack the replacement assembly.

1. Dispose of the defective part.





---

 **NOTE:** HP recommends responsible disposal of the defective part.


<http://www8.hp.com/us/en/hp-information/environment/product-recycling.html>

---

2. Unpack the replacement part from the packaging.


 **CAUTION:**  Some parts are sensitive to electrostatic discharge (ESD). Always perform service work at an ESD-protected workstation or mat. If an ESD workstation or mat is not available, touch the sheet-metal chassis to provide a static ground before touching an ESD-sensitive assembly. Protect the ESD-sensitive assemblies by placing them in ESD pouches when they are out of the printer.

 **IMPORTANT:** Make sure that all of the shipping materials (for example shipping tape) are removed from the replacement part prior to installation.

 **NOTE:** If the replacement part is a roller or pad, avoid touching the spongy part of it. Skin oils on the roller or pad can cause paper pickup and/or print-quality problems. HP recommends using disposable gloves when handling rollers or pads or washing your hands before touching rollers or pads.

---

3. To install an assembly, reverse the removal steps.

 **NOTE:** When applicable, special installation instructions are provided for an assembly at the end of the removal procedure. Always completely read the removal instructions and follow all special installation instructions.


---

## Removal and replacement: Right door open switch

This document provides the procedures to remove the right door open switch.

Mean time to repair: 15 minutes

Service level: Intermediate

 **IMPORTANT:** When applicable, special installation instructions are provided for an assembly at the end of the removal procedure. Always completely read the removal instructions and follow all special installation instructions.

### Before performing service

- Disconnect the power cable.

Use the table below to identify the correct part number for your printer. To order the part, go to [www.hp.com/buy/parts](http://www.hp.com/buy/parts)

Table 2-24 Part information

Part number	Part description
JC93-01467A	Right door open switch

### Required tools

- #2 JIS screwdriver with a magnetic tip

### After performing service

#### Turn the printer power on

- Connect the power cable.
- Use the power switch to turn the power on.

### Post service test

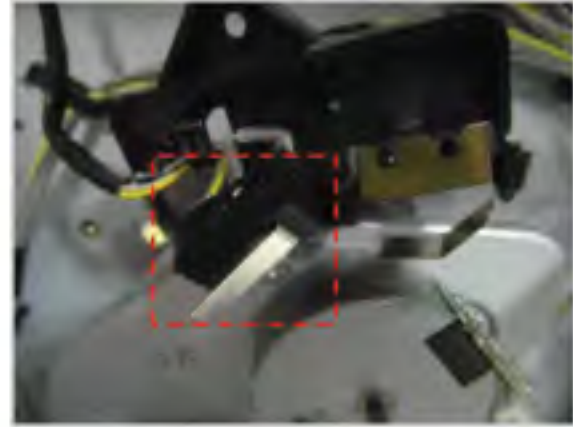
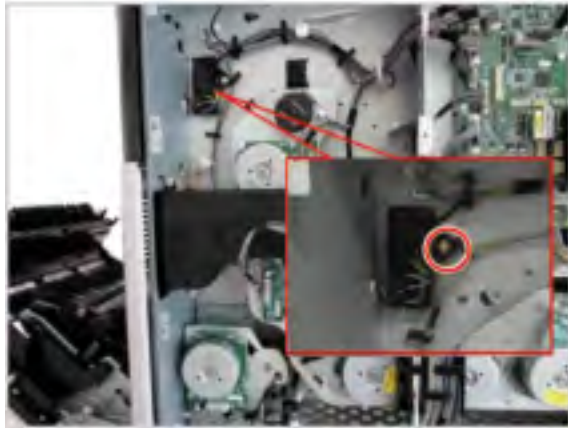
Copy, scan, or print a document. Verify the document copies, scans, or prints correctly.

## Remove the right door open switch

Follow these steps to remove the right door open switch.

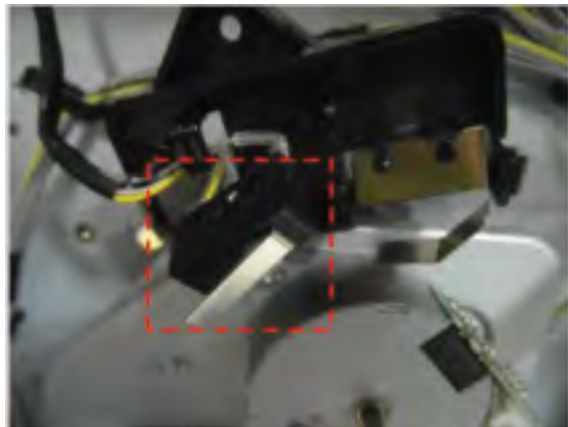
1. Remove the rear cover. Remove one screw securing the sensor.

Figure 2-118 Remove rear cover and screw



2. Remove the micro-switch.

Figure 2-119 Remove micro-switch



### Unpack the replacement assembly

Follow these steps to unpack the replacement assembly.

1. Dispose of the defective part.



---


 **NOTE:** HP recommends responsible disposal of the defective part.


<http://www8.hp.com/us/en/hp-information/environment/product-recycling.html>

---

2. Unpack the replacement part from the packaging.


 **CAUTION:**  Some parts are sensitive to electrostatic discharge (ESD). Always perform service work at an ESD-protected workstation or mat. If an ESD workstation or mat is not available, touch the sheet-metal chassis to provide a static ground before touching an ESD-sensitive assembly. Protect the ESD-sensitive assemblies by placing them in ESD pouches when they are out of the printer.

 **IMPORTANT:** Make sure that all of the shipping materials (for example shipping tape) are removed from the replacement part prior to installation.

 **NOTE:** If the replacement part is a roller or pad, avoid touching the spongy part of it. Skin oils on the roller or pad can cause paper pickup and/or print-quality problems. HP recommends using disposable gloves when handling rollers or pads or washing your hands before touching rollers or pads.

---

3. To install an assembly, reverse the removal steps.

 **NOTE:** When applicable, special installation instructions are provided for an assembly at the end of the removal procedure. Always completely read the removal instructions and follow all special installation instructions.

---

## Removal and replacement: 500 GB Main PCA HDD


This procedure is for removing the 500GB main PCA HDD installed beneath the rear-exit cover.

 [View a video of removing and replacing the 500GB Main PCA HDD.](#)

Mean time to repair: 15 minutes

Service level: Intermediate

---

 **IMPORTANT:** When applicable, special installation instructions are provided for an assembly at the end of the removal procedure. Always completely read the removal instructions and follow all special installation instructions.

---

### Before performing service

- Disconnect the power cable.

Use the table below to identify the correct part number for your printer. To order the part, go to [www.hp.com/buy/parts](http://www.hp.com/buy/parts)

**Table 2-25 Part information**

Part number	Part description
5851-6712	500GB Main PCA HDD

### Required tools

- #2 JIS screwdriver with a magnetic tip

### After performing service

#### Turn the printer power on

- Connect the power cable.
- Use the power switch to turn the power on.

### Post service test

Copy, scan, or print a document. Verify the document copies, scans, or prints correctly.

### Remove the main disk drive

Follow these steps to remove the main disk drive.

1. Remove the inner finisher or paper pass, if installed.

2. Remove two screw-caps and two screws from the power-switch cover.

**Figure 2-120** Remove the power-switch cover



3. Remove two screw-caps and two screws, and then remove the exit tray.

**Figure 2-121** Remove screw-caps and screws



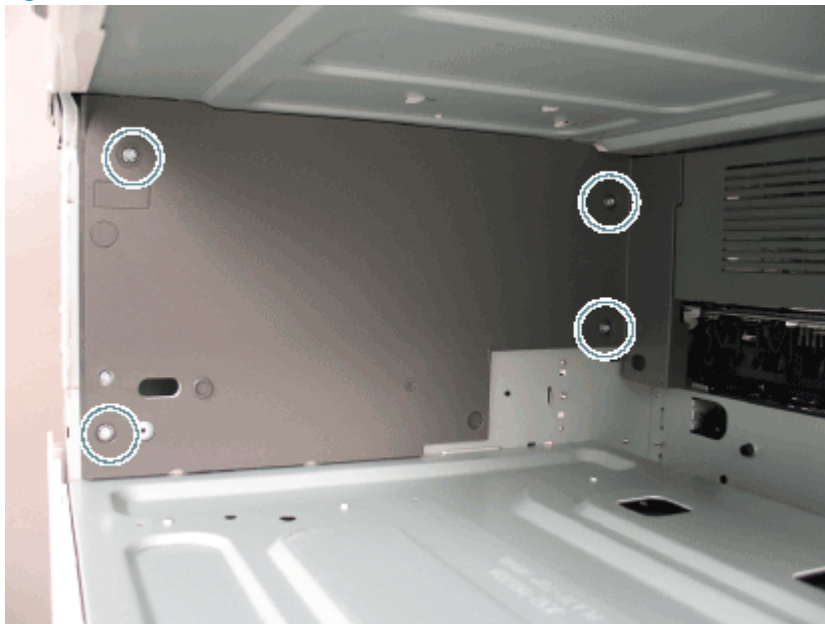
4. Remove one screw and cover exit right.

Figure 2-122 Remove the cover exit right



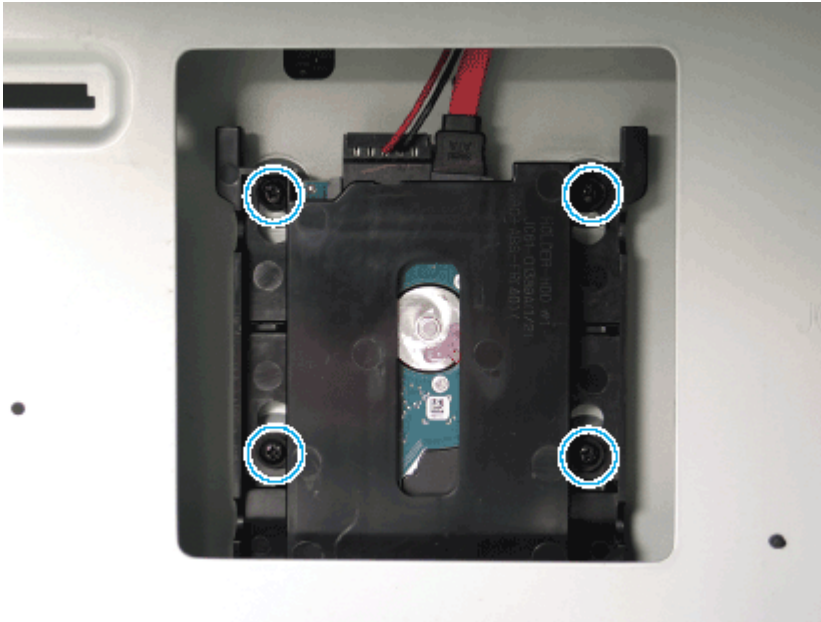
5. Remove four screws and three screw covers. Remove the cover exit rear by pulling from the right and rotating out.

Figure 2-123 Remove screws and cover exit rear



6. Remove four screws. Disconnect the cable and remove the main disk drive assembly.

**Figure 2-124** Remove screws, disconnect cable and remove main disk drive assembly



7. Remove four screws, and then remove main disk drive from its bracket.
8. Install the new main disk drive assembly.

---

 **TIP:** When reinstalling, make sure the plastic locator tabs on the rear exit cover are seated correctly.

---

## Unpack the replacement assembly

Follow these steps to unpack the replacement assembly.

1. Dispose of the defective part.

---



 **NOTE:** HP recommends responsible disposal of the defective part.


<http://www8.hp.com/us/en/hp-information/environment/product-recycling.html>


---

2. Unpack the replacement part from the packaging.

---

 **CAUTION:**  Some parts are sensitive to electrostatic discharge (ESD). Always perform service work at an ESD-protected workstation or mat. If an ESD workstation or mat is not available, touch the sheet-metal chassis to provide a static ground before touching an ESD-sensitive assembly. Protect the ESD-sensitive assemblies by placing them in ESD pouches when they are out of the printer.

 **IMPORTANT:** Make sure that all of the shipping materials (for example shipping tape) are removed from the replacement part prior to installation.


 **NOTE:** If the replacement part is a roller or pad, avoid touching the spongy part of it. Skin oils on the roller or pad can cause paper pickup and/or print-quality problems. HP recommends using disposable gloves when handling rollers or pads or washing your hands before touching rollers or pads.

---

3. To install an assembly, reverse the removal steps.



---

 **NOTE:** When applicable, special installation instructions are provided for an assembly at the end of the removal procedure. Always completely read the removal instructions and follow all special installation instructions.

---


## Removal and replacement: Control panel

This document provides the procedures to remove the control panel assembly.

 [View a video of removing and replacing the control panel \(E77820-E77830\).](#)


Mean time to repair: 15 minutes

Service level: Intermediate

 **IMPORTANT:** When applicable, special installation instructions are provided for an assembly at the end of the removal procedure. Always completely read the removal instructions and follow all special installation instructions.

### Before performing service

- Disconnect the power cable.

 **WARNING!** To avoid damage to the printer, turn the printer off, wait 30 seconds, and then remove the power cable before attempting to service the printer.

Use the table below to identify the correct part number for your printer. To order the part, go to [www.hp.com/buy/parts](http://www.hp.com/buy/parts)

**Table 2-26 Part information**

Part number	Part description
B5L47-60101	Control panel assembly

### Required tools

- #2 JIS screwdriver with a magnetic tip

### After performing service

#### Turn the printer power on

- Connect the power cable.
- Use the power switch to turn the power on.

### Post service test

Copy, scan, or print a document. Verify the document copies, scans, or prints correctly.

## Remove the control-panel bezel

Follow these steps to remove the control-panel bezel.

1. Open the document feeder, and then remove three screws.

Figure 2-125 Remove the document feeder bezel



2. Place the control panel in the upright position.
3. Gently pry the control-panel bezel from the center screw hole, and then pry from the center of the control-panel bezel to the edges to release.

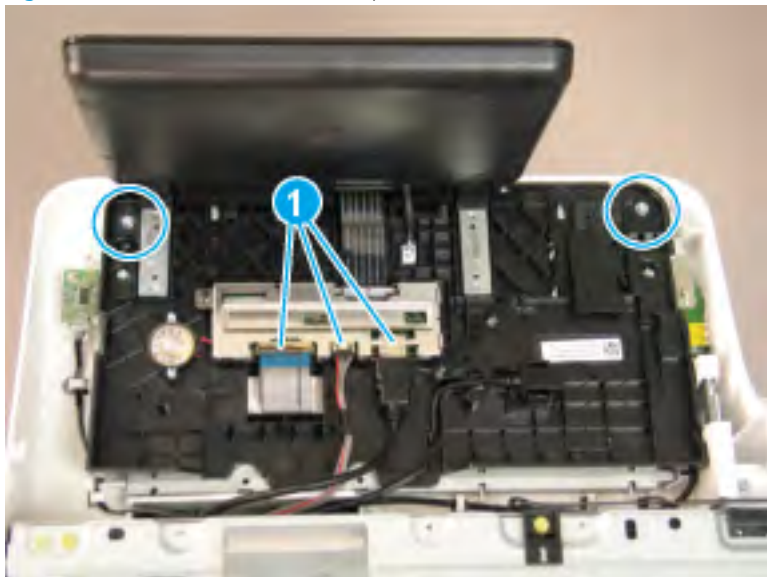
**⚠ CAUTION:** Do not pry against the scanner glass when removing the control-panel bezel.

## Remove the control-panel

Follow these steps to remove the control-panel.

1. Place the control panel in the upright position.
2. Disconnect one FFC, one connector, and one HDMI connector (callout 1), and then remove two screws on the control-panel frame.

Figure 2-126 Remove the control panel screws and disconnect connectors



3. Remove the USB interconnect cable from its retainer and reroute out of the way.

**Figure 2-127** Remove the USB interconnect cable



4. Lift the control panel up from the front to release the tabs at the rear, and then remove the control panel.

---

 **TIP:** Align the four tabs at the rear of control panel, and then snap in the control panel.

---

## Unpack the replacement assembly

Follow these steps to unpack the replacement assembly.

1. Dispose of the defective part.

---



 **NOTE:** HP recommends responsible disposal of the defective part.


<http://www8.hp.com/us/en/hp-information/environment/product-recycling.html>


---

2. Unpack the replacement part from the packaging.

---

 **CAUTION:**  Some parts are sensitive to electrostatic discharge (ESD). Always perform service work at an ESD-protected workstation or mat. If an ESD workstation or mat is not available, touch the sheet-metal chassis to provide a static ground before touching an ESD-sensitive assembly. Protect the ESD-sensitive assemblies by placing them in ESD pouches when they are out of the printer.


 **IMPORTANT:** Make sure that all of the shipping materials (for example shipping tape) are removed from the replacement part prior to installation.

 **NOTE:** If the replacement part is a roller or pad, avoid touching the spongy part of it. Skin oils on the roller or pad can cause paper pickup and/or print-quality problems. HP recommends using disposable gloves when handling rollers or pads or washing your hands before touching rollers or pads.

---

3. To install an assembly, reverse the removal steps.

---

 **NOTE:** When applicable, special installation instructions are provided for an assembly at the end of the removal procedure. Always completely read the removal instructions and follow all special installation instructions.

---

## Removal and replacement: Keyboard


This document provides the procedures to remove the keyboard assembly.

 [View a video of removing and replacing the keyboard \(E72520-E72530\).](#)

 [View a video of removing and replacing the keyboard \(E77820-E77830\).](#)


Mean time to repair: 10 minutes

Service level: Basic

 **IMPORTANT:** When applicable, special installation instructions are provided for an assembly at the end of the removal procedure. Always completely read the removal instructions and follow all special installation instructions.

### Before performing service

- Disconnect the power cable.

 **WARNING!** To avoid damage to the printer, turn the printer off, wait 30 seconds, and then remove the power cable before attempting to service the printer.

Use the table below to identify the correct part number for your printer. To order the part, go to [www.hp.com/buy/parts](http://www.hp.com/buy/parts)

Table 2-27 Part information

Part number	Part description
B5L47-60102	US English Keyboard Assy
B5L47-60103	UK English Keyboard Assy

### Required tools

- #2 JIS screwdriver with a magnetic tip

### After performing service

#### Turn the printer power on

- Connect the power cable.
- Use the power switch to turn the power on.

### Post service test

Copy, scan, or print a document. Verify the document copies, scans, or prints correctly.

### Remove the control-panel bezel

Follow these steps to remove the control-panel bezel.

1. Open the document feeder, and then remove three screws.

**Figure 2-128** Remove the document feeder bezel



2. Place the control panel in the upright position.
3. Gently pry the control-panel bezel from the center screw hole, and then pry from the center of the control-panel bezel to the edges to release.

---

**CAUTION:** Do not pry against the scanner glass when removing the control-panel bezel.

---

## Remove the keyboard

Follow these steps to remove the keyboard.

1. Disconnect one FFC.

**Figure 2-129** Disconnect one FFC



2. Slide the keyboard out, and then depress two latches to remove the keyboard.

**Figure 2-130** Remove the control-panel keyboard



## Unpack the replacement assembly

Follow these steps to unpack the replacement assembly.

1. Dispose of the defective part.

---



 **NOTE:** HP recommends responsible disposal of the defective part.

<http://www8.hp.com/us/en/hp-information/environment/product-recycling.html>


---

2. Unpack the replacement part from the packaging.

---

 **CAUTION:**  Some parts are sensitive to electrostatic discharge (ESD). Always perform service work at an ESD-protected workstation or mat. If an ESD workstation or mat is not available, touch the sheet-metal chassis to provide a static ground before touching an ESD-sensitive assembly. Protect the ESD-sensitive assemblies by placing them in ESD pouches when they are out of the printer.


 **IMPORTANT:** Make sure that all of the shipping materials (for example shipping tape) are removed from the replacement part prior to installation.

 **NOTE:** If the replacement part is a roller or pad, avoid touching the spongy part of it. Skin oils on the roller or pad can cause paper pickup and/or print-quality problems. HP recommends using disposable gloves when handling rollers or pads or washing your hands before touching rollers or pads.

---

3. To install an assembly, reverse the removal steps.

---

 **NOTE:** When applicable, special installation instructions are provided for an assembly at the end of the removal procedure. Always completely read the removal instructions and follow all special installation instructions.

---

## Exit assemblies

View the exit assemblies exploded view, parts list, and repair procedures.

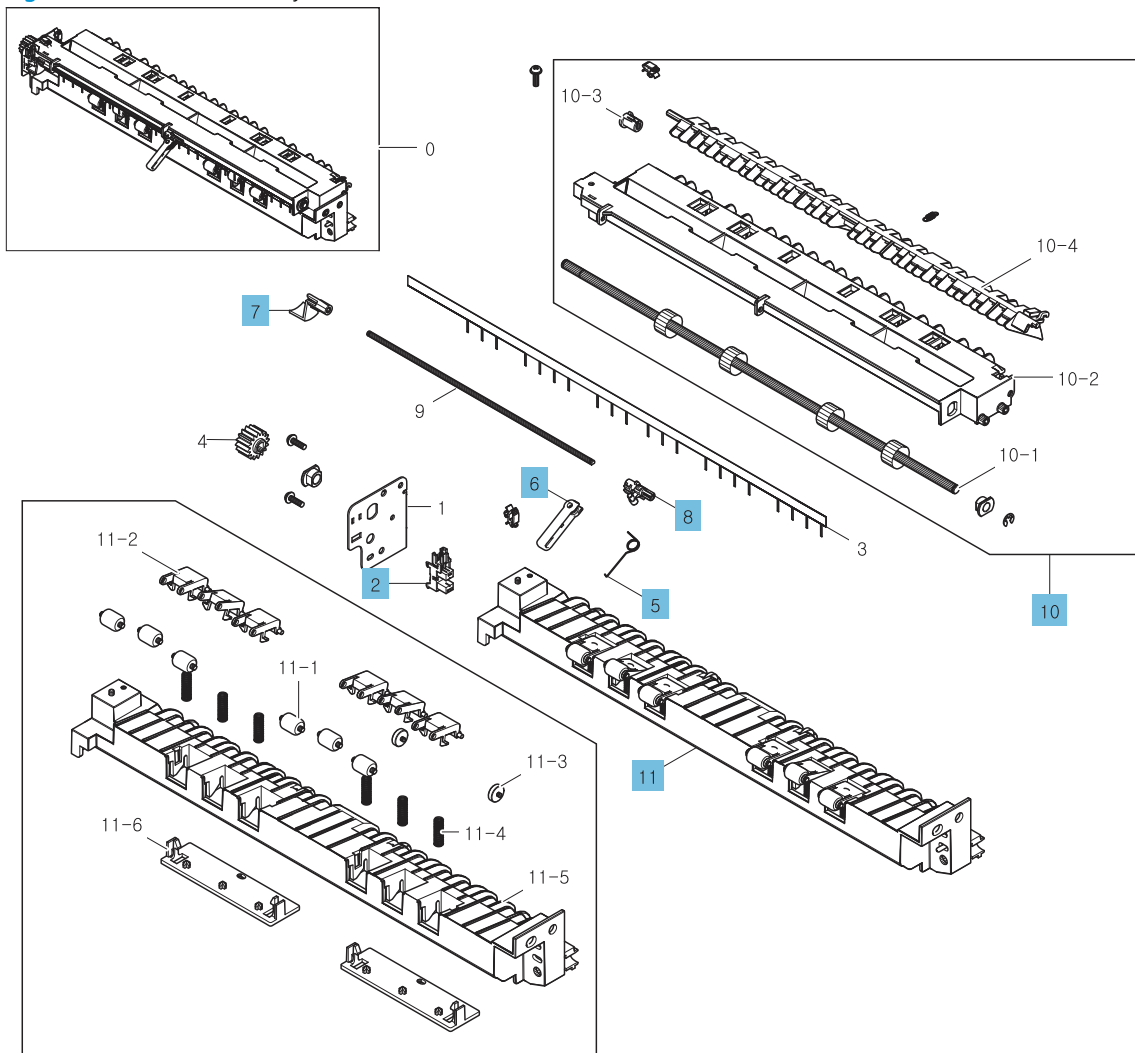




## Exit assembly

Parts diagram and parts list for the exit assemblies.

Figure 2-131 Exit assembly



**Table 2-28 Exit assembly**

<b>Ref</b>			
<b>No</b>	<b>Part number</b>	<b>Description</b>	<b>Qty</b>
2	0604-001393	Photo interrupter (fuser out sensor)	2
5	JC61-07185A	Spring, TS	1
6	JC66-04339A	Actuator-bin full exit	1
7	JC66-02218A	Actuator, full exit	1
8	JC66-02278A	Actuator, full exit	1
10-1	JC66-03183A	Roller, face down exit	1
10-2	JC61-04799A	Upper exit guide	1
11	JC90-01133A	Exit guide, lower	1

## Cassettes tray 2/3

View the cassettes tray 2/3 exploded view, parts list, and repair procedures.



## Cassettes Tray 2/3

Parts diagram and parts list for the cassettes tray 2/3.

Figure 2-132 Cassettes Tray 2/3

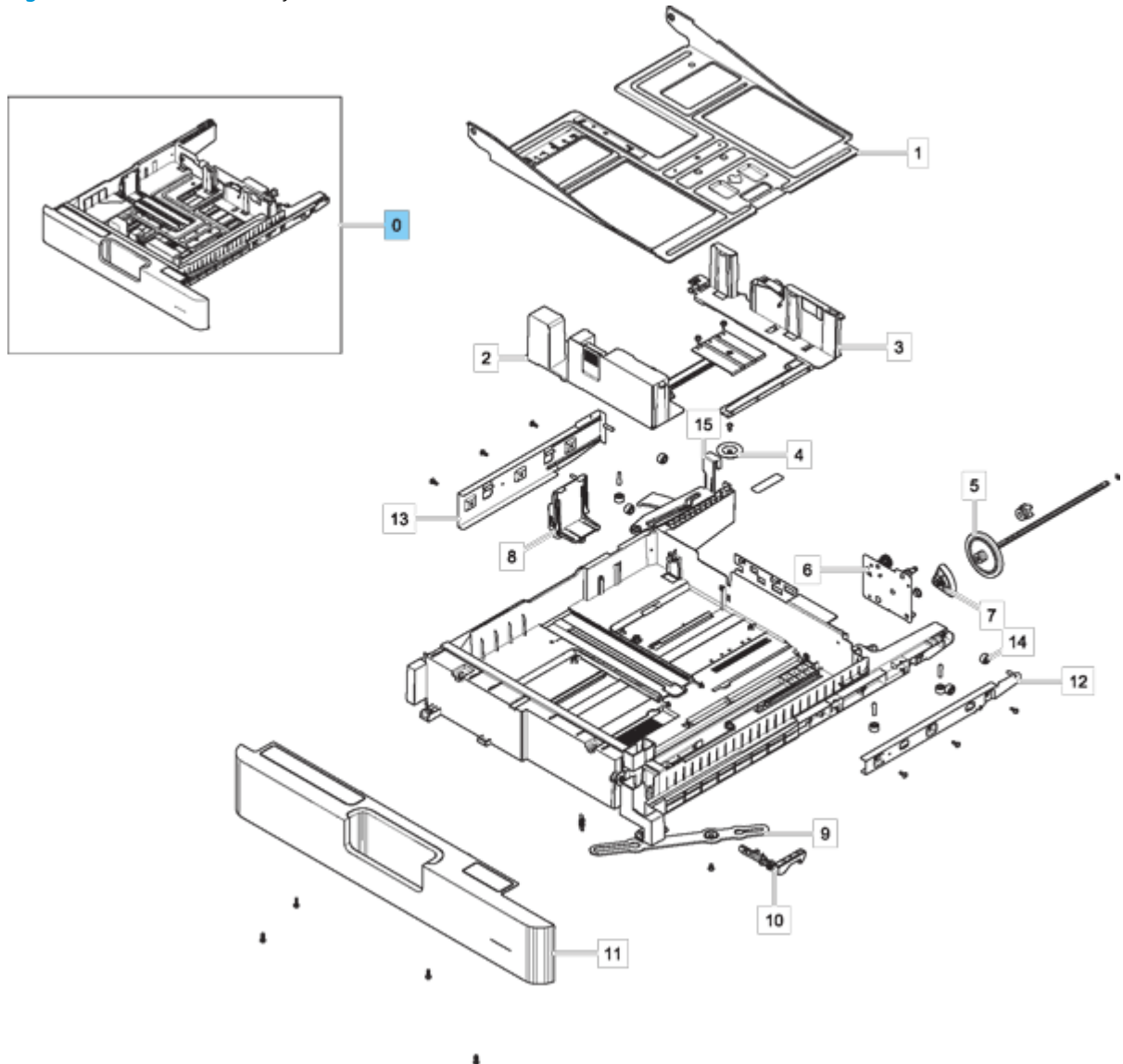


Table 2-29 Cassettes Tray 2/3

Ref				
No	Part number	Description	Qty	Repair procedure
0	JC90-01619A	Cassette, Tray 2	1	Not applicable
0	5QJ98-60109	Cassette, Tray 3	1	Not applicable

## Main drive assembly

View the main drive assembly exploded view, parts list, and repair procedures.

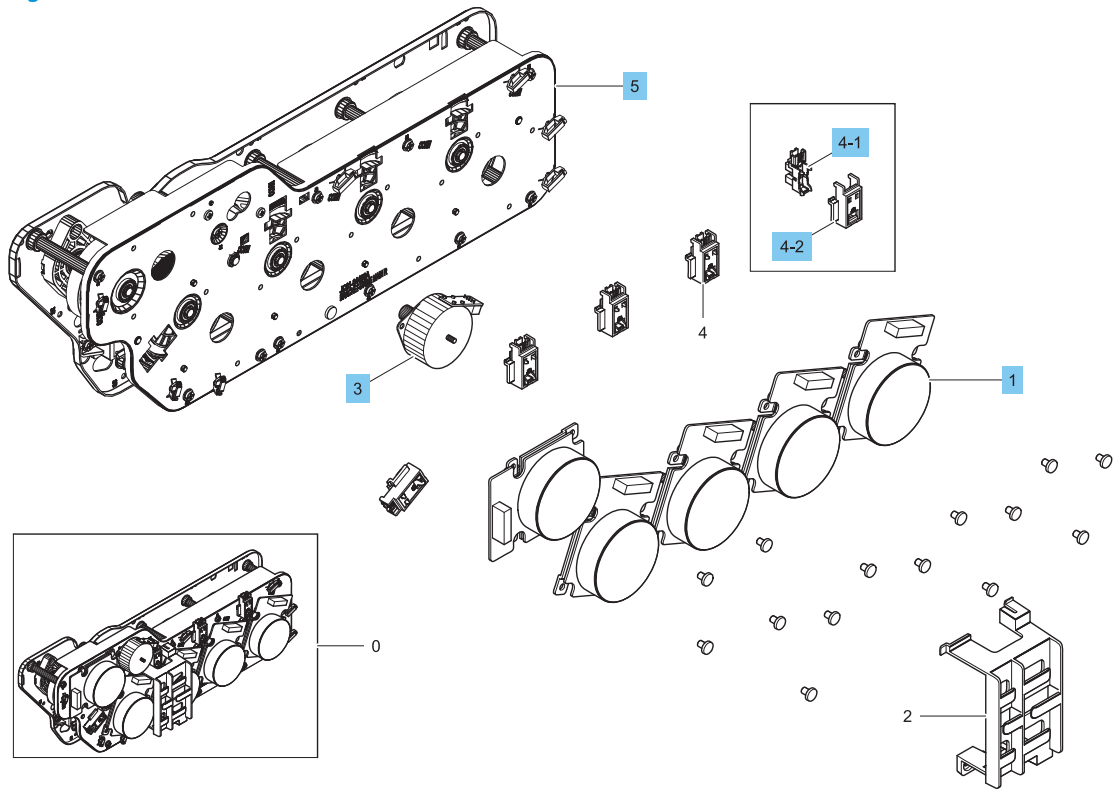




## Main drive

Parts diagram and parts list for the main drive.

Figure 2-133 Main drive



**Table 2-30 Main drive**

Ref				
No	Part number	Description	Qty	Repair procedure
1	JC31-00123A	Motor, bldc	5	Not applicable
3	JC93-00452A	Drive motor, step (For E77822, 77825, 77830)	1	Not applicable
3	5QJ90-64002	Drive motor, step (For E78323, E78325, E78330)	1	Not applicable
4-1	0604-001393	Photo interrupter	4	Not applicable
4-2	JC61-04538A	OPC sensor holder	4	Not applicable
5	JC93-00914B	Main sub drive	1	Not applicable

## Fuser output drive

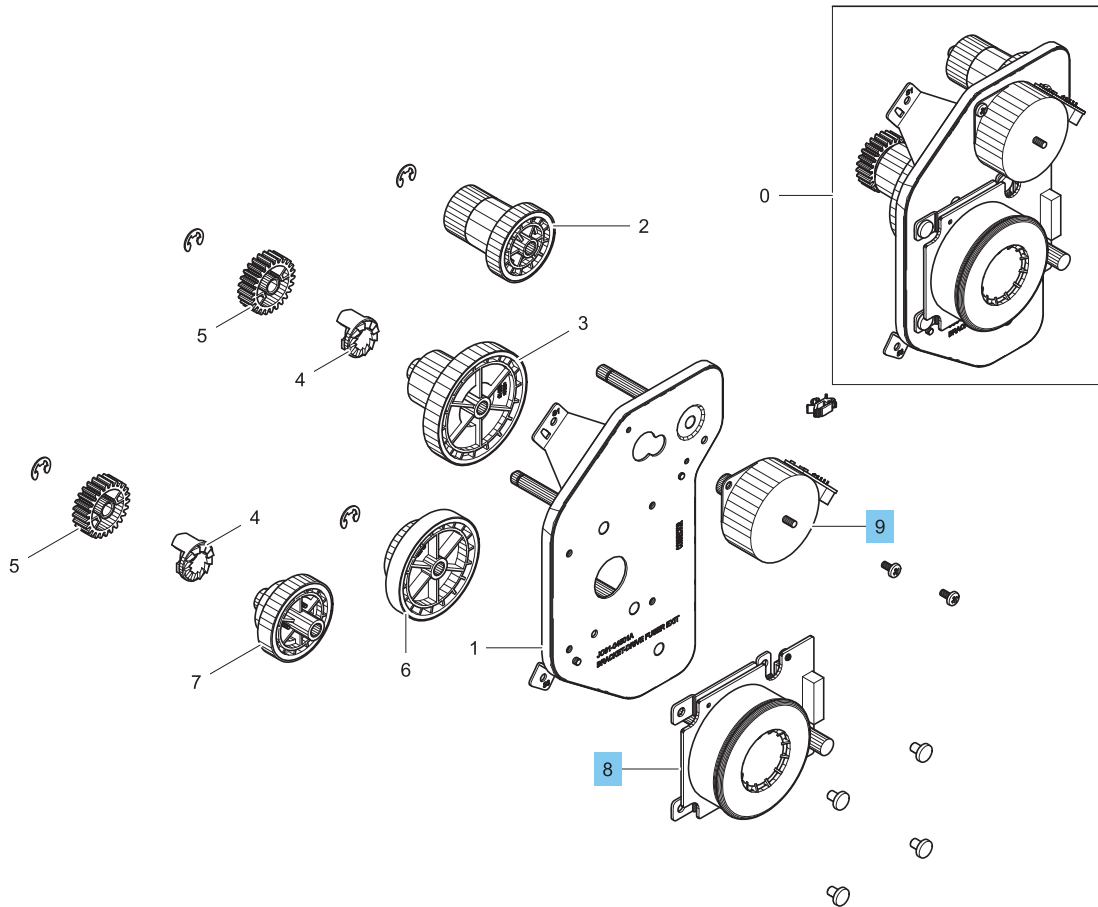
View the fuser output drive exploded view, parts list, and repair procedures.



## Fuser output drive

Parts diagram and parts list for the fuser output drive.

Figure 2-134 Fuser output drive



**Table 2-31** Fuser output drive

Ref				
No	Part number	Description	Qty	Repair procedure
8	JC31-00123B	Motor, bldc	1	Not applicable
9	JC93-00452A	Drive motor, step	1	Not applicable

## Main frame assembly

View the main frame assembly exploded view, parts list, and repair procedures.

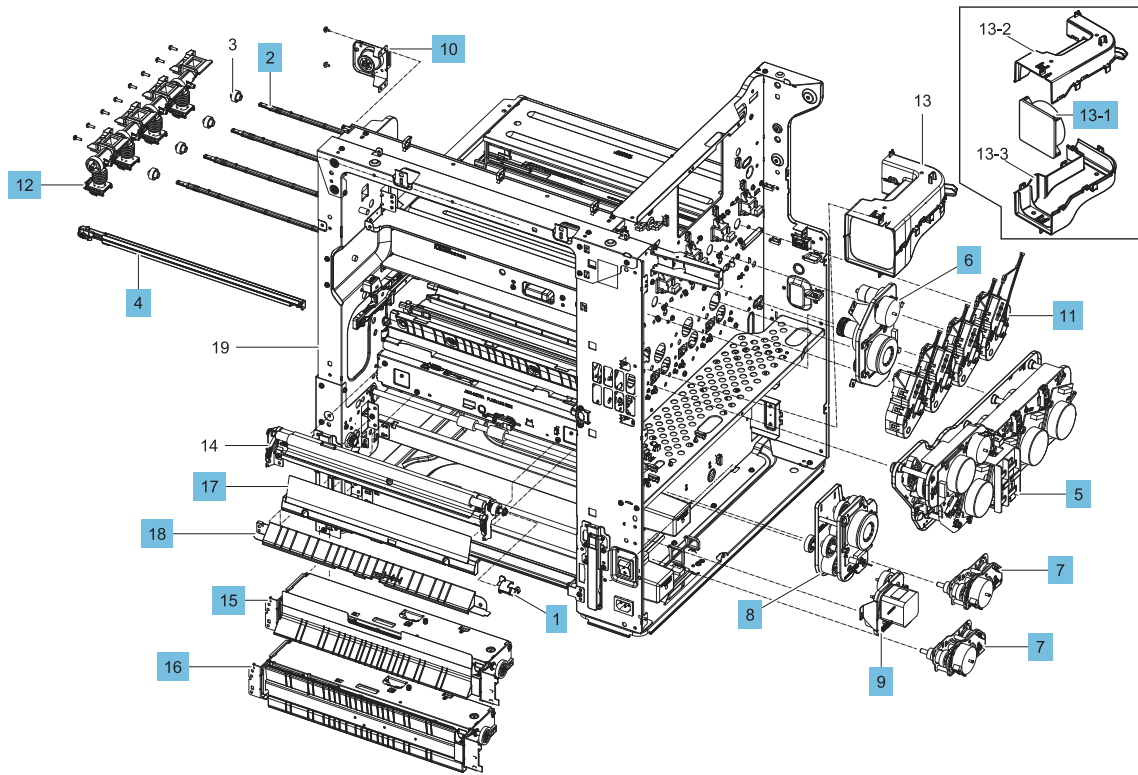




# Main engine frame

Parts diagram and parts list for the main engine frame.

Figure 2-135 Main engine frame



**Table 2-32 Main engine frame**

Ref				
No	Part number	Description	Qty	Repair procedure
1	JC61-04900A	Registration stopper	1	Not applicable
2	JC66-03164A	Feeding Duct Shaft	4	Not applicable
3	JC66-03166A	Idle feeding duct gear	4	Not applicable
4	JC93-00078C	Registration Cleaner	1	Not applicable
5	JC93-00915B	Main drive	1	<a href="#">Removal and replacement: Main drive unit on page 279</a>
6	JC93-00441A	Fuser exit drive	1	<a href="#">Removal and replacement: Fuser/exit drive assembly on page 285</a>
7	JC93-00442A	Pickup drive (For E77822, E77825, E77830)	2	Not applicable
7	5QJ90-64001	Pickup drive (For E78323, E78325, E78330)	2	Not applicable
8	JC93-00443A	Registration assembly	1	<a href="#">Removal and replacement: Registration assembly on page 357</a>
9	JC93-00444A	Feed drive	1	<a href="#">Removal and replacement: Feed drive assembly on page 289</a>
10	JC93-00445A	TCU drive	1	<a href="#">Removal and replacement: Toner collection unit drive on page 293</a>
11	JC93-00446B	Toner supply drive (For E77822, E77825, E77830)	4	<a href="#">Removal and replacement: Toner supply drive assembly on page 296</a>
11	5QJ83-64002	Toner supply drive (For E78323, E78325, E78330)	4	<a href="#">Removal and replacement: Toner supply drive assembly on page 296</a>
12	JC93-00483B	Toner Duct (For E77822, E77825, E77830)	4	<a href="#">Removal and replacement: Toner duct assembly on page 307</a>
12	5QJ94-40001	Toner Duct (For E78323, E78325, E78330)	4	<a href="#">Removal and replacement: Toner duct assembly on page 307</a>
13-1	JC93-00161A	Fan, type 7 Fuser (For E77822, E77825, E77830)	1	<a href="#">Removal and replacement: Fuser-duct fan on page 312</a>
13-1	JC31-00161A	Fan, type 7 Fuser (For E78323, E78325, E78330)	1	<a href="#">Removal and replacement: Fuser-duct fan on page 312</a>
15	JC93-00511A	Main frame first pickup	1	<a href="#">Removal and replacement: Pickup drive units on page 316</a>
16	JC93-01441A	Main frame second pickup	1	<a href="#">Removal and replacement: Pickup drive units on page 316</a>
17	JC93-00536A	Main feed first color	1	Not applicable
18	JC93-00537D	Main feed second	1	Not applicable

**Table 2-32 Main engine frame (continued)**


Ref				
No	Part number	Description	Qty	Repair procedure
Not shown	0604-001393	Feed sensor 1	1	<a href="#">Removal and replacement: Feed sensor 1 on page 320</a>
Not shown	0604-001393	Feed sensor 2	1	<a href="#">Removal and replacement: Feed sensor 2 on page 325</a>
Not shown	JC93-00895A	Automatic color registration (ACR) (For E77822, E77825, E77830)	1	<a href="#">Removal and replacement: Automatic color registration (ACR) on page 331</a>
Not shown	JC93-01803A	Automatic color registration (ACR) (For E78323, E78325, E78330)	1	<a href="#">Removal and replacement: Automatic color registration (ACR) on page 331</a>
Not shown	JC93-00492A	Sensor, toner collection unit full	1	<a href="#">Removal and replacement: Toner collection full sensor on page 303</a>
Not shown	0604-001381	Photo interrupter (fuser out sensor) (For E77822, E77825, E77830)	1	<a href="#">Removal and replacement: Fuser out sensor on page 338</a>
Not shown	0604-001393	Photo interrupter (fuser out sensor) (For E78323, E78325, E78330)	1	<a href="#">Removal and replacement: Fuser out sensor on page 338</a>
Not shown	0604-001393	Photo interrupter (duplex sensor)	1	<a href="#">Removal and replacement: Duplex sensor and loop sensor on page 341</a>
Not shown	0604-001393	Photo interrupter (loop sensor)	1	<a href="#">Removal and replacement: Duplex sensor and loop sensor on page 341</a>
Not shown	JC39-02112A	Harness, engine side for DCF with connector	1	Not applicable

## Removal and replacement: Main drive unit

This document provides the procedures to remove the main drive unit assembly.

Mean time to repair: 15 minutes

Service level: Intermediate

 **IMPORTANT:** When applicable, special installation instructions are provided for an assembly at the end of the removal procedure. Always completely read the removal instructions and follow all special installation instructions.

### Before performing service

- Disconnect the power cable.

Use the table below to identify the correct part number for your printer. To order the part, go to [www.hp.com/buy/parts](http://www.hp.com/buy/parts)

**Table 2-33** Part information

Part number	Part description
JC93-00915B	Main drive unit assembly

### Required tools

- #2 JIS screwdriver with a magnetic tip

### After performing service

#### Turn the printer power on

- Connect the power cable.
- Use the power switch to turn the power on.

### Post service test

Copy, scan, or print a document. Verify the document copies, scans, or prints correctly.

## Remove the TCU

Follow these steps to remove the TCU.

- ▲ Open the front door and remove the toner collection unit (TCU).

Figure 2-136 Remove the TCU



## Remove the imaging units

Follow these steps to remove the imaging units.

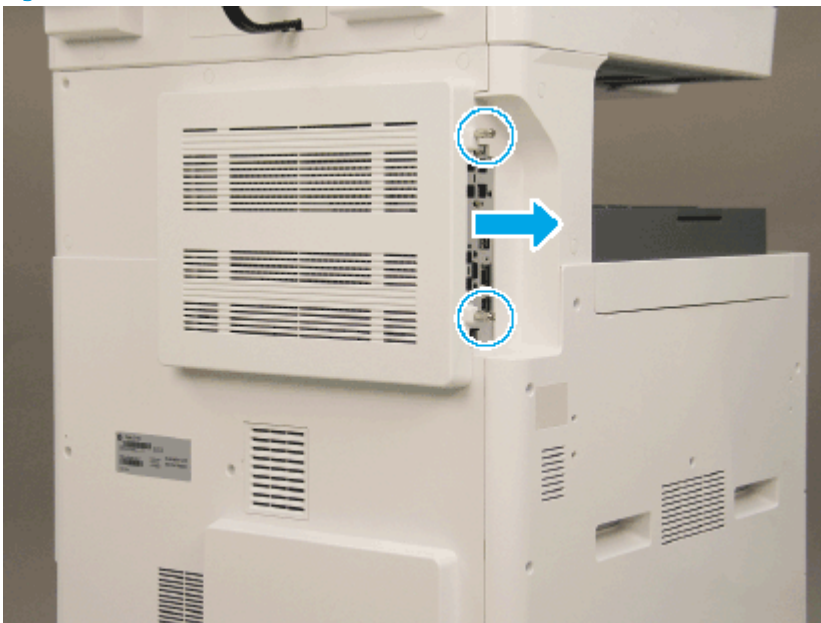
- ▲ Remove all imaging units.

## Remove the rear covers

Follow these steps to remove the rear covers.

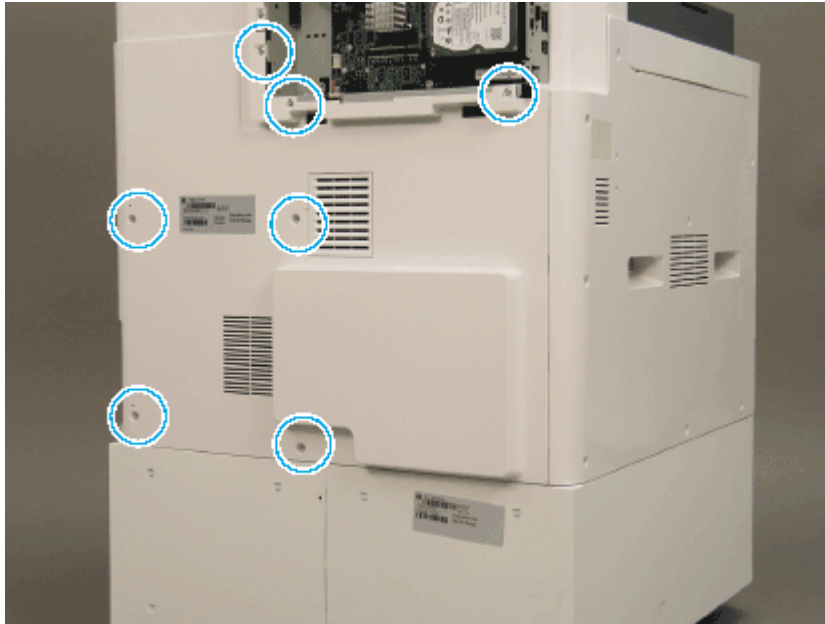
1. Unscrew two captive thumbscrews on the formatter cover. Slide the formatter cover to the left, and then to the right to remove.

Figure 2-137 Remove the formatter cover



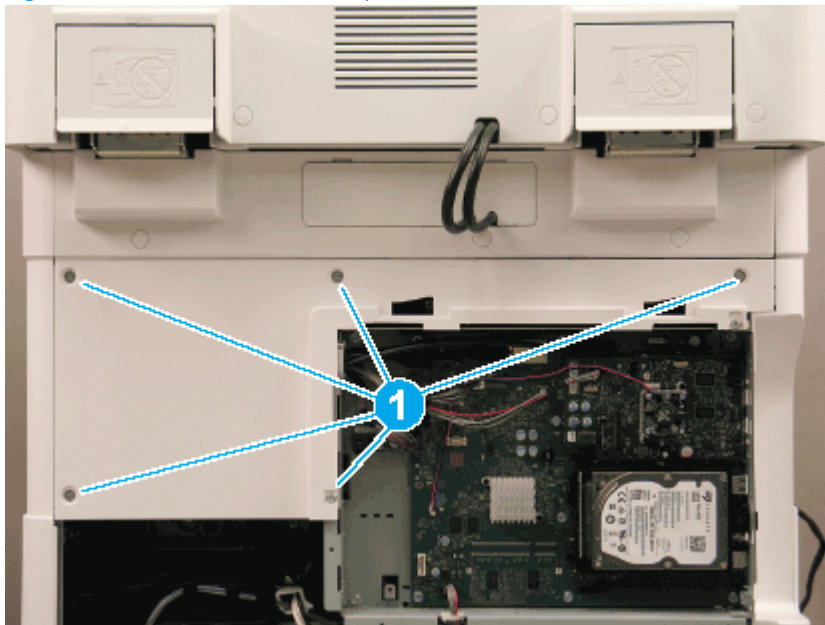
2. Remove seven screws, and then remove the rear-bottom cover.

Figure 2-138 Remove the rear-bottom cover



3. Remove six screws (callout 1), and then remove the rear-top cover.

Figure 2-139 Remove the rear-top cover



### Remove the main drive unit

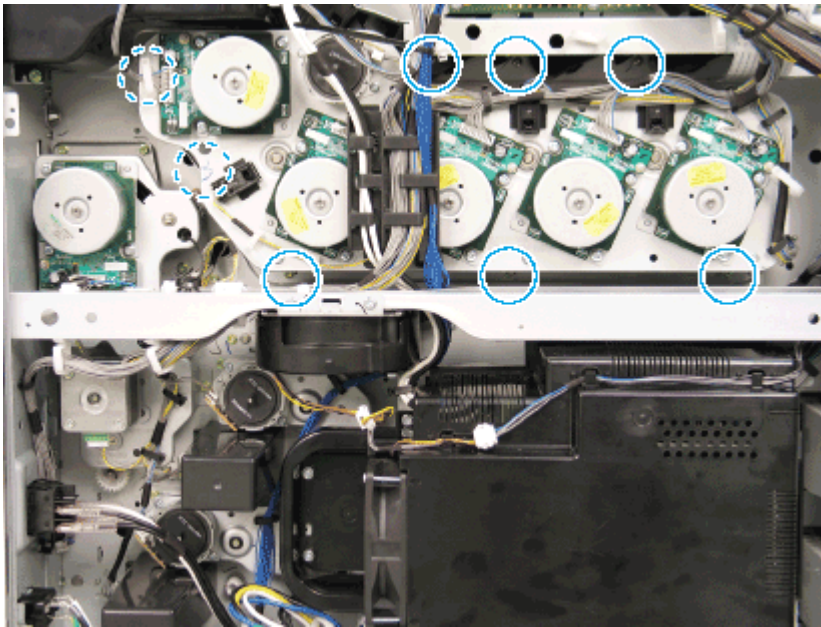
Follow these steps to remove the main drive unit.

1. Disconnect the alienation motor and the ITB motor.

2. Remove eight screws, and then remove the main drive unit.

 **IMPORTANT:** Remove and replace the screws in the order indicated on the chassis.

**Figure 2-140** Remove screws and the main drive unit

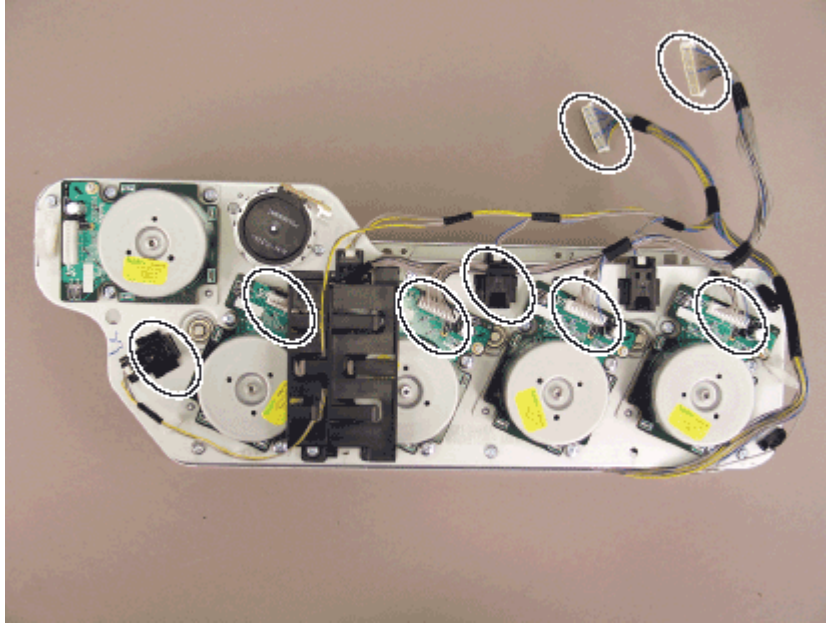




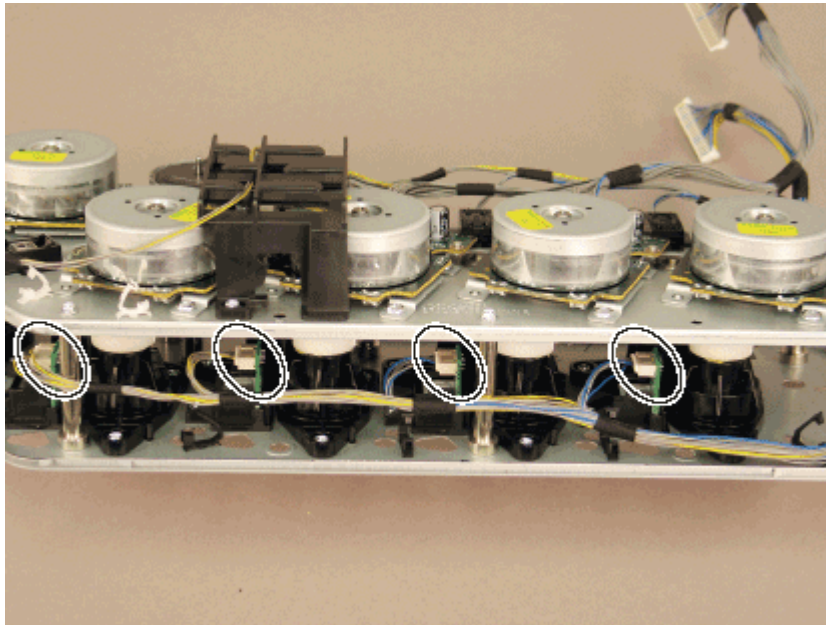
3. Remove the connector(s) for the motor(s) to be replaced.


 **NOTE:** The following graphics show *all* the connectors associated with the main motors for reference purposes.

**Figure 2-141** Main drive motor electrical connectors – top view



**Figure 2-142** Main drive motor electrical connectors – photo interrupters



 **NOTE:** To remove the photo interrupters, release the tabs on the back side. Use caution not to damage the plastic hooks.

## Unpack the replacement assembly

Follow these steps to unpack the replacement assembly.

1. Dispose of the defective part.

---

 **NOTE:** HP recommends responsible disposal of the defective part.

<http://www8.hp.com/us/en/hp-information/environment/product-recycling.html>

---

2. Unpack the replacement part from the packaging.


 **CAUTION:**  Some parts are sensitive to electrostatic discharge (ESD). Always perform service work at an ESD-protected workstation or mat. If an ESD workstation or mat is not available, touch the sheet-metal chassis to provide a static ground before touching an ESD-sensitive assembly. Protect the ESD-sensitive assemblies by placing them in ESD pouches when they are out of the printer.

 **IMPORTANT:** Make sure that all of the shipping materials (for example shipping tape) are removed from the replacement part prior to installation.

 **NOTE:** If the replacement part is a roller or pad, avoid touching the spongy part of it. Skin oils on the roller or pad can cause paper pickup and/or print-quality problems. HP recommends using disposable gloves when handling rollers or pads or washing your hands before touching rollers or pads.

---

3. To install an assembly, reverse the removal steps.

 **NOTE:** When applicable, special installation instructions are provided for an assembly at the end of the removal procedure. Always completely read the removal instructions and follow all special installation instructions.

---

## Removal and replacement: Fuser/exit drive assembly

This document provides the procedures to remove the fuser/exit drive assembly.

Mean time to repair: 15 minutes

Service level: Intermediate



**IMPORTANT:** When applicable, special installation instructions are provided for an assembly at the end of the removal procedure. Always completely read the removal instructions and follow all special installation instructions.

### Before performing service

- Disconnect the power cable.

Use the table below to identify the correct part number for your printer. To order the part, go to [www.hp.com/buy/parts](http://www.hp.com/buy/parts)

Table 2-34 Part information

Part number	Part description
JC93-00441A	Fuser/exit drive assembly

### Required tools

- #2 JIS screwdriver with a magnetic tip

### After performing service

#### Turn the printer power on

- Connect the power cable.
- Use the power switch to turn the power on.

### Post service test

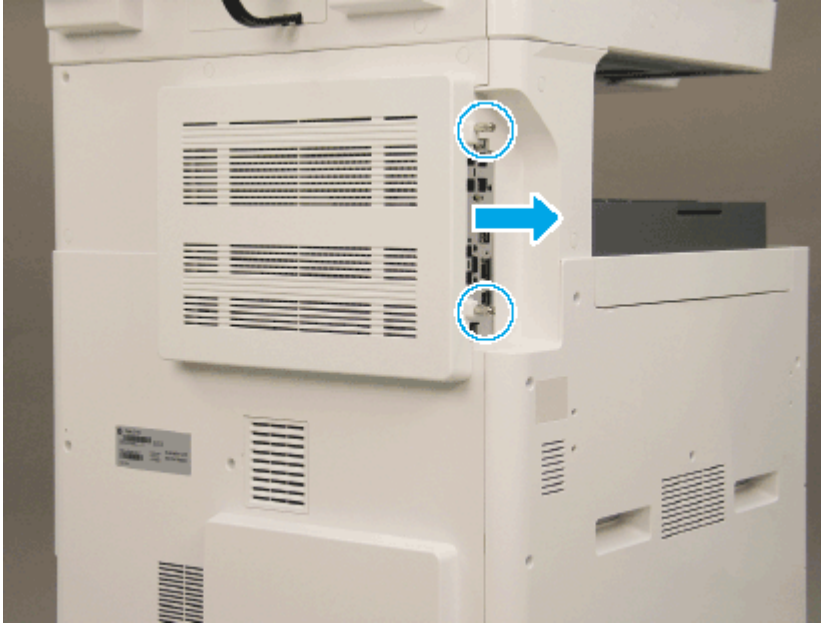
Copy, scan, or print a document. Verify the document copies, scans, or prints correctly.

### Remove the rear covers

Follow these steps to remove the rear covers.

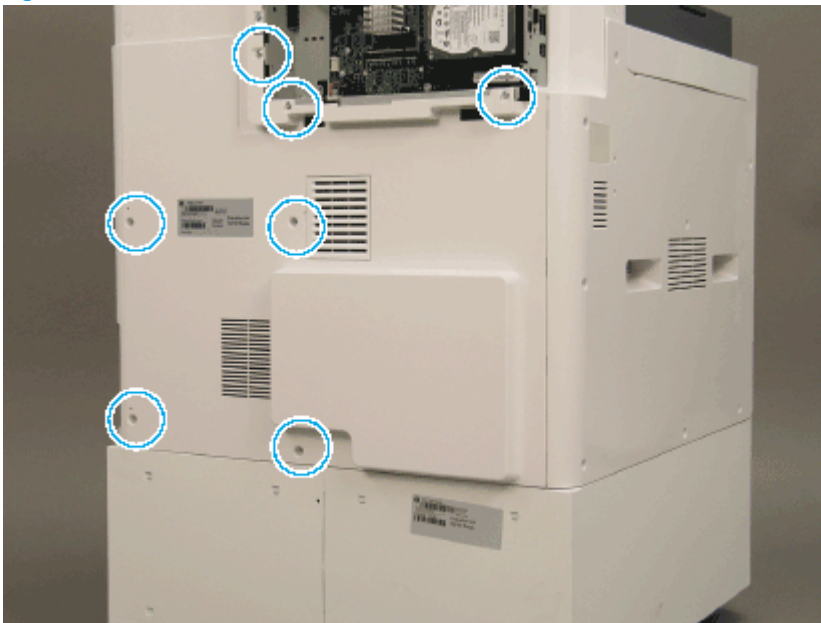
1. Unscrew two captive thumbscrews on the formatter cover. Slide the formatter cover to the left, and then to the right to remove.

Figure 2-143 Remove the formatter cover



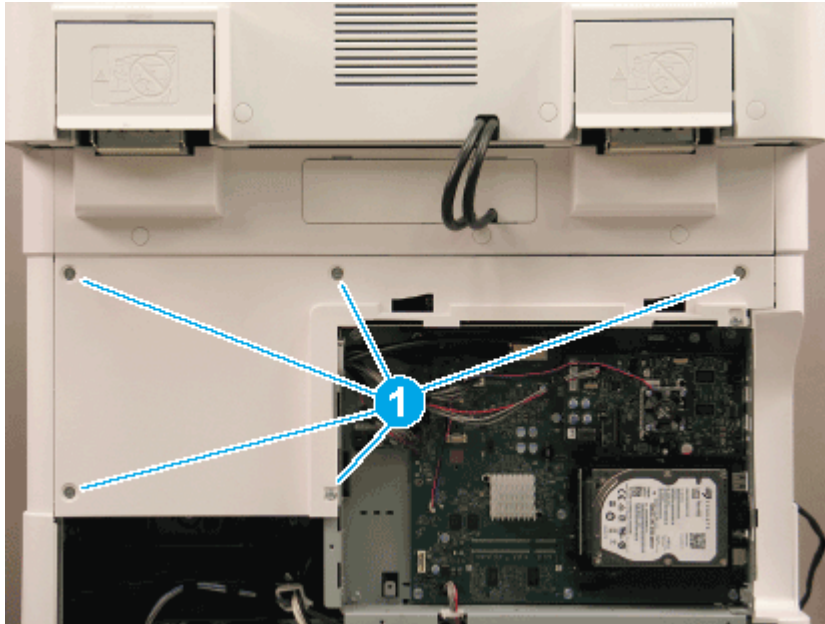
2. Remove seven screws, and then remove the rear-bottom cover.

Figure 2-144 Remove the rear-bottom cover



3. Remove six screws (callout 1), and then remove the rear-top cover.

Figure 2-145 Remove the rear-top cover

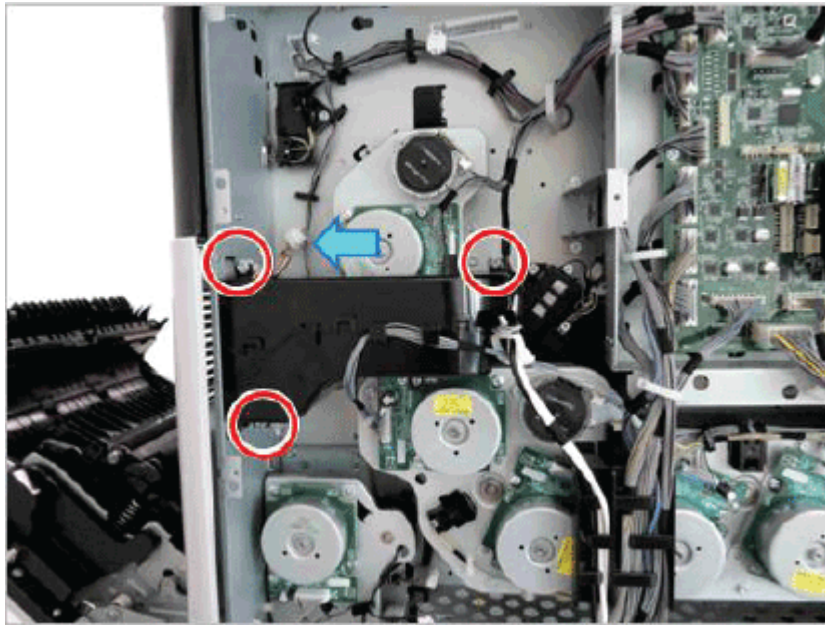


### Remove the fuser/exit drive unit

Follow these steps to remove the fuser/exit drive unit.

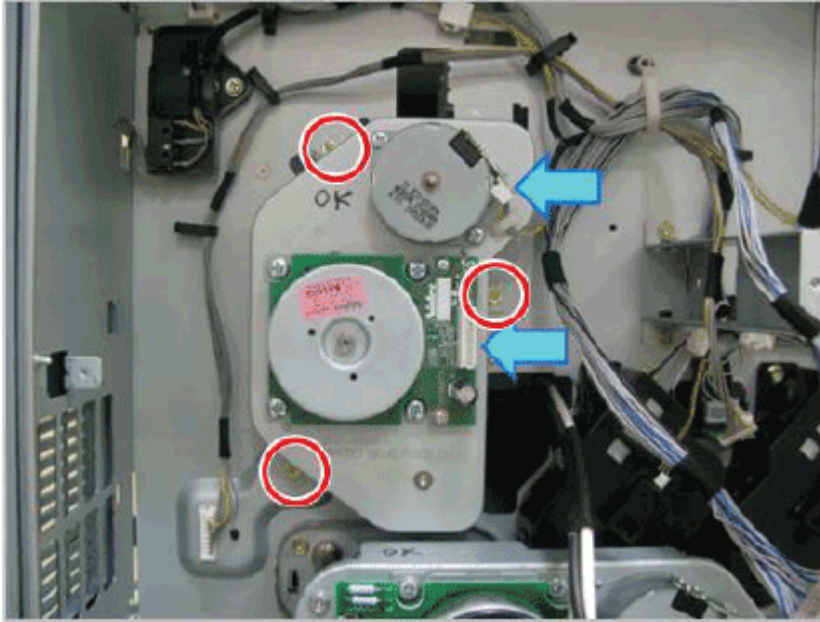
1. Disconnect the connector and remove the cable from the cable restraint. Remove the cable from the guides on the duct housing. Remove three screws, and then remove the Fuser-Duct.

Figure 2-146 Remove the fuser-duct



2. Disconnect two motor connectors. Remove three screws, and then remove the fuser/exit drive unit.

**Figure 2-147** Remove screws and the fuser/exit drive unit



## Unpack the replacement assembly



Follow these steps to unpack the replacement assembly.


1. Dispose of the defective part.


 **NOTE:** HP recommends responsible disposal of the defective part.

<http://www8.hp.com/us/en/hp-information/environment/product-recycling.html>


2. Unpack the replacement part from the packaging.

 **CAUTION:**  Some parts are sensitive to electrostatic discharge (ESD). Always perform service work at an ESD-protected workstation or mat. If an ESD workstation or mat is not available, touch the sheet-metal chassis to provide a static ground before touching an ESD-sensitive assembly. Protect the ESD-sensitive assemblies by placing them in ESD pouches when they are out of the printer.

 **IMPORTANT:** Make sure that all of the shipping materials (for example shipping tape) are removed from the replacement part prior to installation.

 **NOTE:** If the replacement part is a roller or pad, avoid touching the spongy part of it. Skin oils on the roller or pad can cause paper pickup and/or print-quality problems. HP recommends using disposable gloves when handling rollers or pads or washing your hands before touching rollers or pads.

3. To install an assembly, reverse the removal steps.


 **NOTE:** When applicable, special installation instructions are provided for an assembly at the end of the removal procedure. Always completely read the removal instructions and follow all special installation instructions.

## Removal and replacement: Feed drive assembly

This document provides the procedures to remove the Feed drive assembly .

Mean time to repair: 15 minutes

Service level: Intermediate

 **IMPORTANT:** When applicable, special installation instructions are provided for an assembly at the end of the removal procedure. Always completely read the removal instructions and follow all special installation instructions.

### Before performing service

- Disconnect the power cable.

Use the table below to identify the correct part number for your printer. To order the part, go to [www.hp.com/buy/parts](http://www.hp.com/buy/parts)

**Table 2-35** Part information

Part number	Part description
JC93-00444A	Feed drive assembly

### Required tools

- #2 JIS screwdriver with a magnetic tip

### After performing service

#### Turn the printer power on

- Connect the power cable.
- Use the power switch to turn the power on.

### Post service test

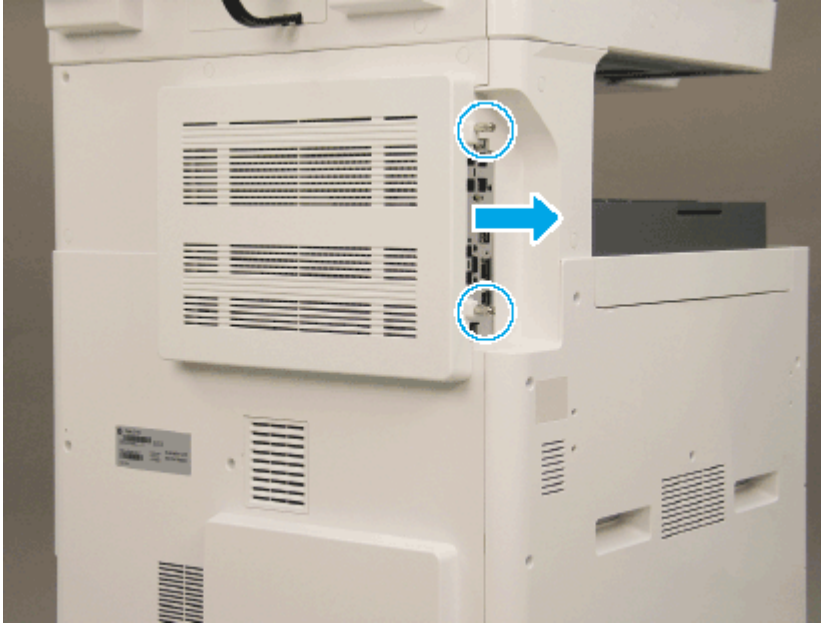
Copy, scan, or print a document. Verify the document copies, scans, or prints correctly.

### Remove the rear covers

Follow these steps to remove the rear covers.

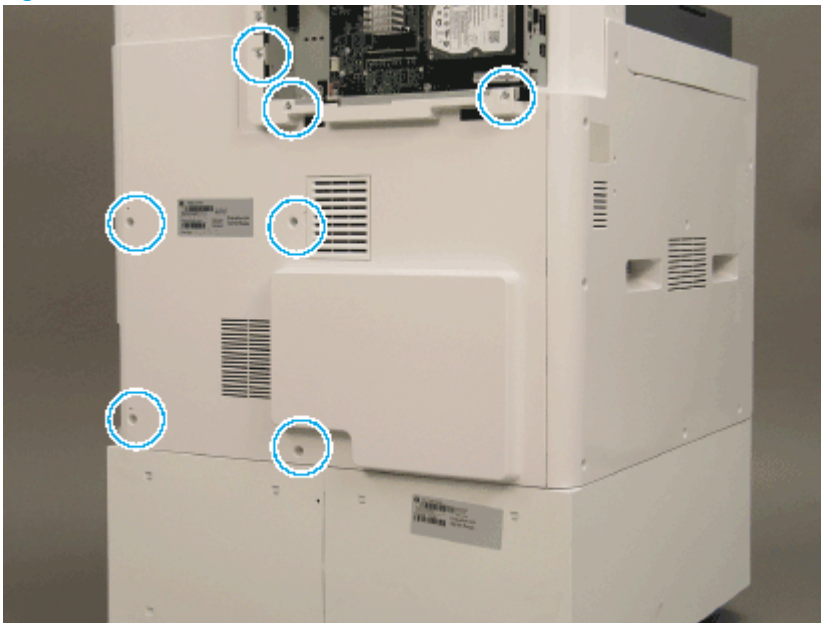
1. Unscrew two captive thumbscrews on the formatter cover. Slide the formatter cover to the left, and then to the right to remove.

Figure 2-148 Remove the formatter cover



2. Remove seven screws, and then remove the rear-bottom cover.

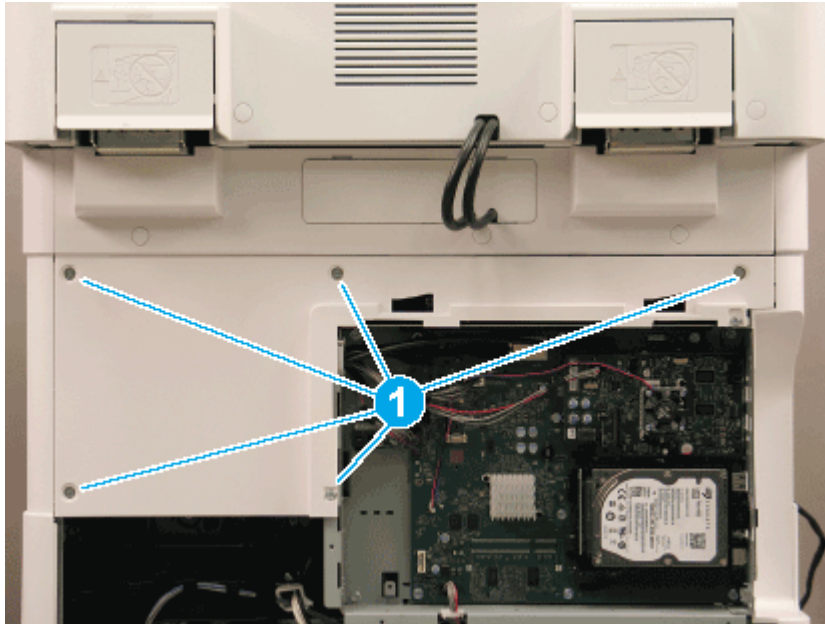
Figure 2-149 Remove the rear-bottom cover





3. Remove six screws (callout 1), and then remove the rear-top cover.

Figure 2-150 Remove the rear-top cover

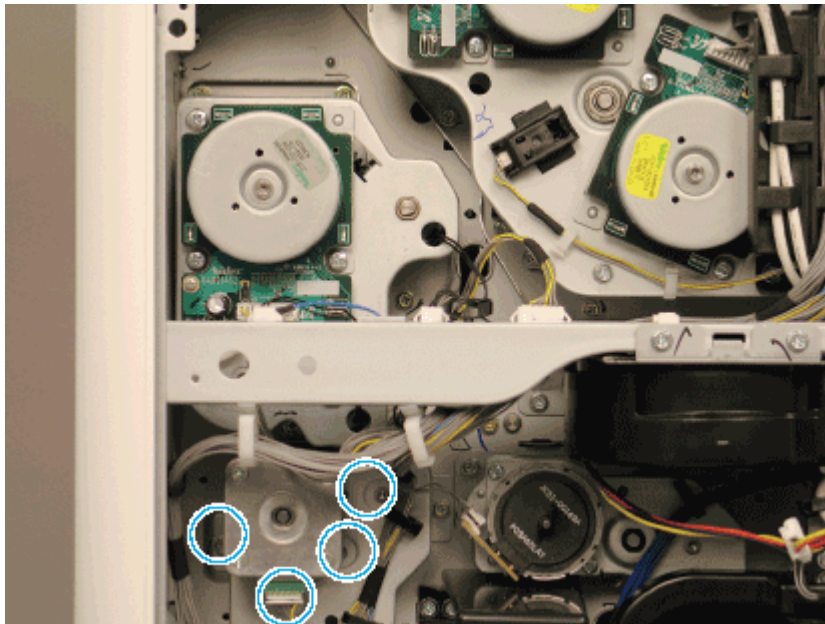


### Remove the feed drive unit

Follow these steps to remove the feed drive unit.

- ▲ Release the cable from two cable restraints and disconnect the connector. Remove three yellow screws, and then remove the Feed Drive unit.

Figure 2-151 Remove screws and feed drive unit




### Unpack the replacement assembly

Follow these steps to unpack the replacement assembly.

1. Dispose of the defective part.



---


 **NOTE:** HP recommends responsible disposal of the defective part.


<http://www8.hp.com/us/en/hp-information/environment/product-recycling.html>

---

2. Unpack the replacement part from the packaging.


 **CAUTION:**  Some parts are sensitive to electrostatic discharge (ESD). Always perform service work at an ESD-protected workstation or mat. If an ESD workstation or mat is not available, touch the sheet-metal chassis to provide a static ground before touching an ESD-sensitive assembly. Protect the ESD-sensitive assemblies by placing them in ESD pouches when they are out of the printer.

 **IMPORTANT:** Make sure that all of the shipping materials (for example shipping tape) are removed from the replacement part prior to installation.

 **NOTE:** If the replacement part is a roller or pad, avoid touching the spongy part of it. Skin oils on the roller or pad can cause paper pickup and/or print-quality problems. HP recommends using disposable gloves when handling rollers or pads or washing your hands before touching rollers or pads.

---

3. To install an assembly, reverse the removal steps.

 **NOTE:** When applicable, special installation instructions are provided for an assembly at the end of the removal procedure. Always completely read the removal instructions and follow all special installation instructions.


---

## Removal and replacement: Toner collection unit drive

This document provides the procedures to remove the toner collection unit drive assembly.

Mean time to repair: 15 minutes

Service level: Intermediate

 **IMPORTANT:** When applicable, special installation instructions are provided for an assembly at the end of the removal procedure. Always completely read the removal instructions and follow all special installation instructions.

### Before performing service

- Disconnect the power cable.

Use the table below to identify the correct part number for your printer. To order the part, go to [www.hp.com/buy/parts](http://www.hp.com/buy/parts)

**Table 2-36** Part information

Part number	Part description
JC93-00445A	Toner collection unit drive assembly

### Required tools

- #2 JIS screwdriver with a magnetic tip

### After performing service

#### Turn the printer power on

- Connect the power cable.
- Use the power switch to turn the power on.

### Post service test

Copy, scan, or print a document. Verify the document copies, scans, or prints correctly.

## Remove the toner cartridges

Follow these steps to remove the toner cartridges.

- ▲ Open the front door and remove the toner collection unit and toner cartridges.

Figure 2-152 Remove the TCU



### Remove the front inner cover

Follow these steps to remove the front inner cover.

- ▲ Remove seven screws, and then remove the front inner cover.


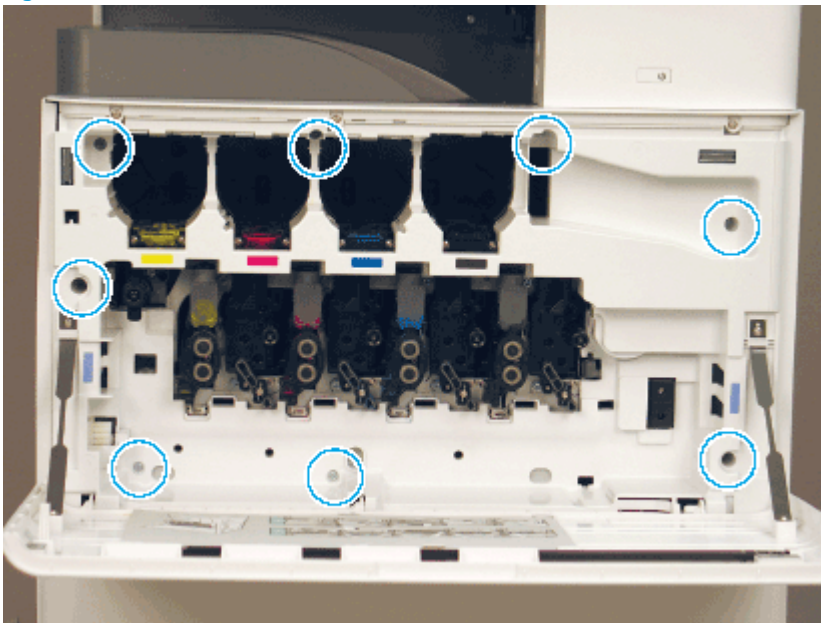
 **NOTE:** The TCU cleaning blade must be removed to remove the front inner cover.

Figure 2-153 Remove the front inner cover

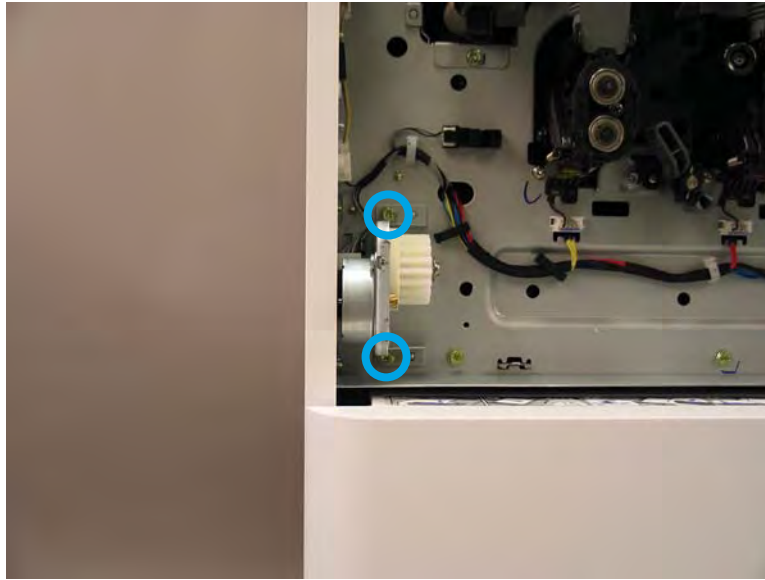


### Remove the toner collection drive unit

Follow these steps to remove the toner collection drive unit.

- ▲ Disconnect two connectors. Remove two screws, and then remove the toner collection unit drive unit.

Figure 2-154 Remove screws and toner collection unit drive unit



## Unpack the replacement assembly

Follow these steps to unpack the replacement assembly.

1. Dispose of the defective part.

---



 **NOTE:** HP recommends responsible disposal of the defective part.


<http://www8.hp.com/us/en/hp-information/environment/product-recycling.html>


---

2. Unpack the replacement part from the packaging.

---

 **CAUTION:**  Some parts are sensitive to electrostatic discharge (ESD). Always perform service work at an ESD-protected workstation or mat. If an ESD workstation or mat is not available, touch the sheet-metal chassis to provide a static ground before touching an ESD-sensitive assembly. Protect the ESD-sensitive assemblies by placing them in ESD pouches when they are out of the printer.


 **IMPORTANT:** Make sure that all of the shipping materials (for example shipping tape) are removed from the replacement part prior to installation.

 **NOTE:** If the replacement part is a roller or pad, avoid touching the spongy part of it. Skin oils on the roller or pad can cause paper pickup and/or print-quality problems. HP recommends using disposable gloves when handling rollers or pads or washing your hands before touching rollers or pads.

---

3. To install an assembly, reverse the removal steps.

---

 **NOTE:** When applicable, special installation instructions are provided for an assembly at the end of the removal procedure. Always completely read the removal instructions and follow all special installation instructions.

---


## Removal and replacement: Toner supply drive assembly

This document provides the procedures to remove the toner supply drive assembly.

 [View a video of removing the toner supply drive unit.](#)

Mean time to repair: 20 minutes

Service level: Intermediate

 **IMPORTANT:** When applicable, special installation instructions are provided for an assembly at the end of the removal procedure. Always completely read the removal instructions and follow all special installation instructions.

### Before performing service

- Disconnect the power cable.

Use the table below to identify the correct part number for your printer. To order the part, go to [www.hp.com/buy/parts](http://www.hp.com/buy/parts)

**Table 2-37 Part information**

Part number	Part description
JC93-00446B	Toner supply drive assembly (E778xx series)
5QJ83-64002	Toner supply drive assembly (E783xx series)

### Required tools

- #2 JIS screwdriver with a magnetic tip

### After performing service

#### Turn the printer power on

- Connect the power cable.
- Use the power switch to turn the power on.

### Post service test

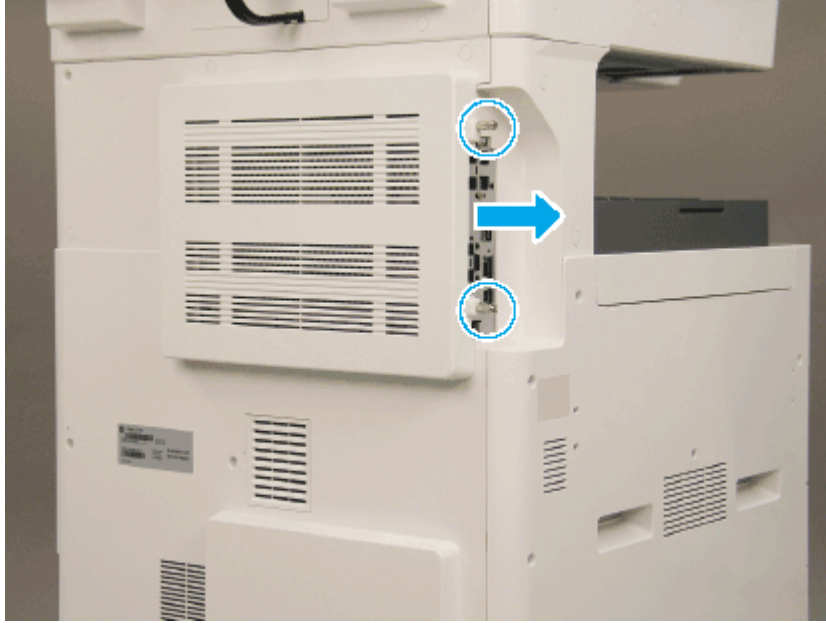
Copy, scan, or print a document. Verify the document copies, scans, or prints correctly.

### Remove the rear covers

Follow these steps to remove the rear covers.

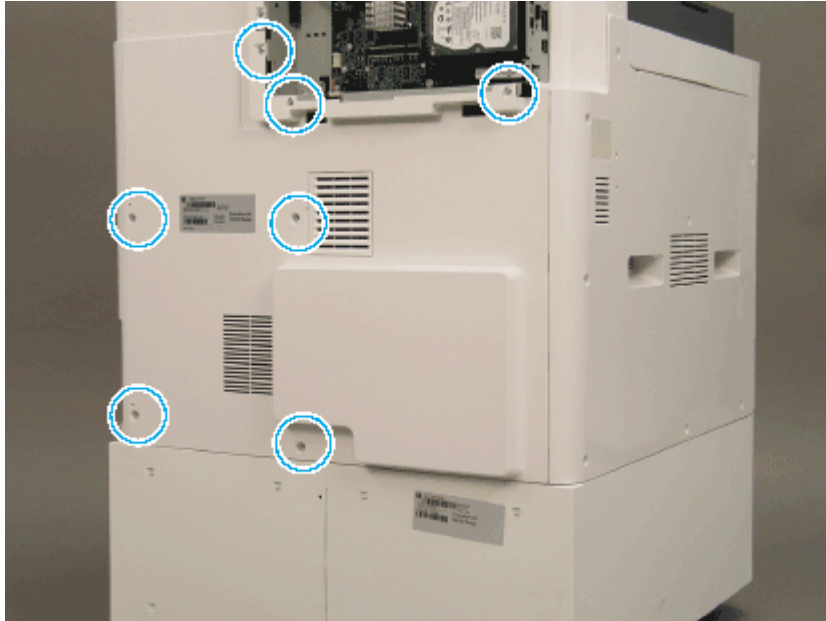
1. Unscrew two captive thumbscrews on the formatter cover. Slide the formatter cover to the left, and then to the right to remove.

Figure 2-155 Remove the formatter cover



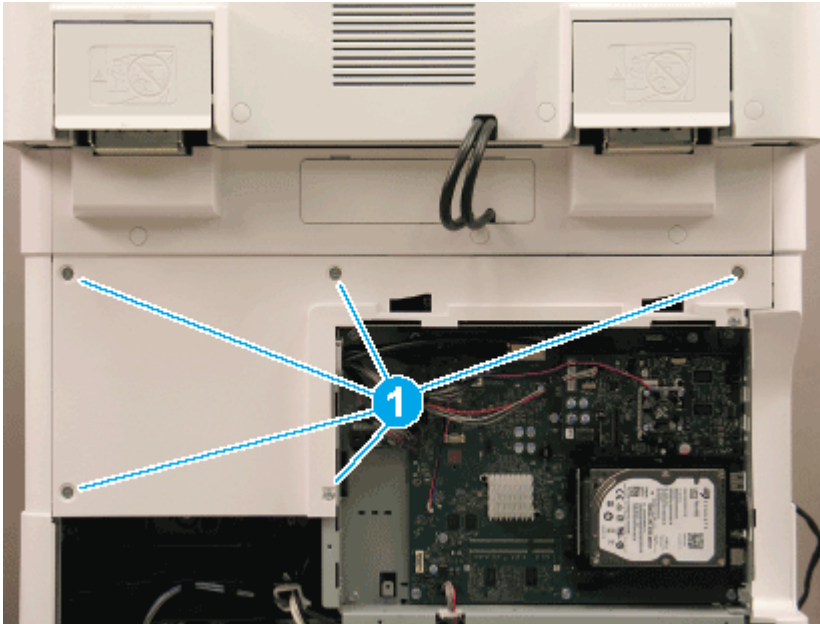
2. Remove seven screws, and then remove the rear-bottom cover.

Figure 2-156 Remove the rear-bottom cover



3. Remove six screws (callout 1), and then remove the rear-top cover.

Figure 2-157 Remove the rear-top cover

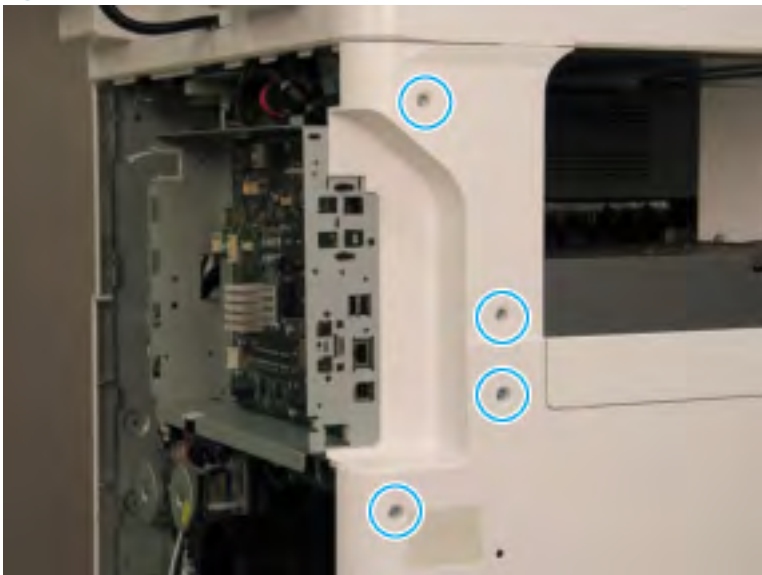


### Remove the formatter cage

Follow these steps to remove the formatter cage.

1. Disconnect ten connectors and two cable restraints.
2. Remove four screws and screw-caps, and then remove the left-upper cover.

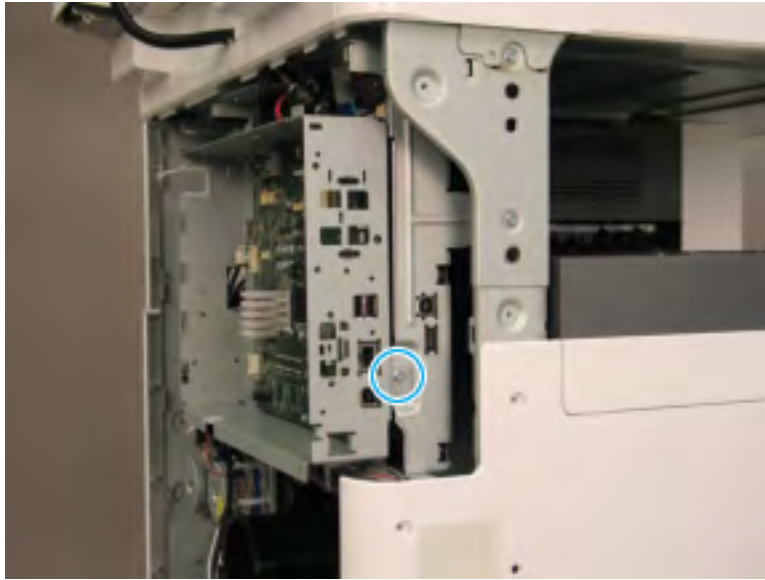
Figure 2-158 Remove the left-upper cover





3. Remove one screw from the side of the formatter cage (beneath the left-upper cover location).

Figure 2-159 Remove the formatter cage side screw



4. Remove three screws from the formatter cage face, and then release one tab to remove the formatter cage.

Figure 2-160 Remove three screws to remove the formatter cage



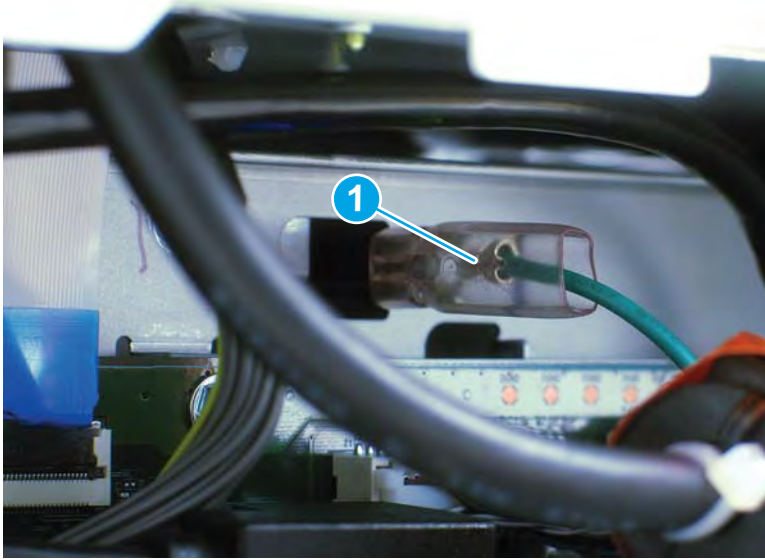
## Remove the main board cage

Follow these steps to remove the main board cage.

1. Remove the FFC retainer at the bottom-right.

2. Pinch the ground strap (callout 1) to remove it from the top of the cage.

**Figure 2-161** Remove the ground strap



3. Open seven cable retainers.
4. Remove four screws.

**Figure 2-162** Remove the main board cage screws



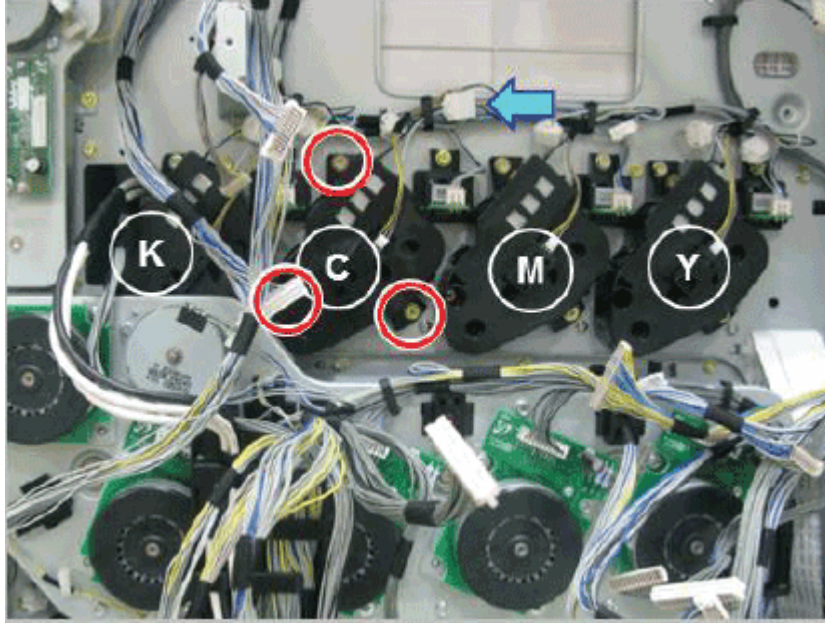
5. Lift the main board cage up slightly to release one bracket, and then pull out to remove.

### Remove the toner supply drive unit

Follow these steps to remove the toner supply drive unit.

- ▲ Disconnect two connectors, one on the body and one inline. Remove three screws, release one cable harness, and then remove the Toner Supply Drive unit by carefully releasing the snaps.

Figure 2-163 Remove the toner supply drive



 **NOTE:**

- To remove the K Toner supply drive unit, first remove the main drive unit.
- The toner supply drive units are interchangeable.

## Unpack the replacement assembly



Follow these steps to unpack the replacement assembly.


1. Dispose of the defective part.


 **NOTE:** HP recommends responsible disposal of the defective part.

<http://www8.hp.com/us/en/hp-information/environment/product-recycling.html>

2. Unpack the replacement part from the packaging.


 **CAUTION:**  Some parts are sensitive to electrostatic discharge (ESD). Always perform service work at an ESD-protected workstation or mat. If an ESD workstation or mat is not available, touch the sheet-metal chassis to provide a static ground before touching an ESD-sensitive assembly. Protect the ESD-sensitive assemblies by placing them in ESD pouches when they are out of the printer.

 **IMPORTANT:** Make sure that all of the shipping materials (for example shipping tape) are removed from the replacement part prior to installation.

 **NOTE:** If the replacement part is a roller or pad, avoid touching the spongy part of it. Skin oils on the roller or pad can cause paper pickup and/or print-quality problems. HP recommends using disposable gloves when handling rollers or pads or washing your hands before touching rollers or pads.

3. To install an assembly, reverse the removal steps.

---

 **NOTE:** When applicable, special installation instructions are provided for an assembly at the end of the removal procedure. Always completely read the removal instructions and follow all special installation instructions.


---

## Removal and replacement: Toner collection full sensor

This document provides the procedures to remove the toner collection full sensor.

Mean time to repair: 10 minutes

Service level: Basic

 **IMPORTANT:** When applicable, special installation instructions are provided for an assembly at the end of the removal procedure. Always completely read the removal instructions and follow all special installation instructions.

### Before performing service

- Disconnect the power cable.

Use the table below to identify the correct part number for your printer. To order the part, go to [www.hp.com/buy/parts](http://www.hp.com/buy/parts)

**Table 2-38** Part information

Part number	Part description
JC93-00492A	Toner collection full sensor

### Required tools

- #2 JIS screwdriver with a magnetic tip

### After performing service

#### Turn the printer power on

- Connect the power cable.
- Use the power switch to turn the power on.

### Post service test

Copy, scan, or print a document. Verify the document copies, scans, or prints correctly.

## Remove the toner cartridges and TCU

Follow these steps to remove the toner cartridges and TCU.

- ▲ Open the front door and remove the toner collection unit and toner cartridges.

Figure 2-164 Remove the TCU



### Remove the front inner cover

Follow these steps to remove the front inner cover.

- ▲ Remove seven screws, and then remove the front inner cover.


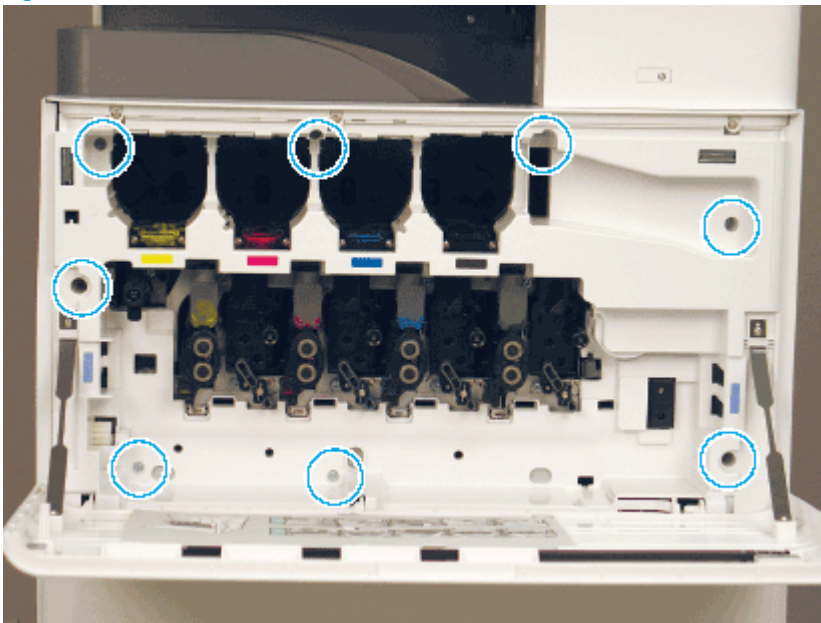
 **NOTE:** The TCU cleaning blade must be removed to remove the front inner cover.

Figure 2-165 Remove the front inner cover

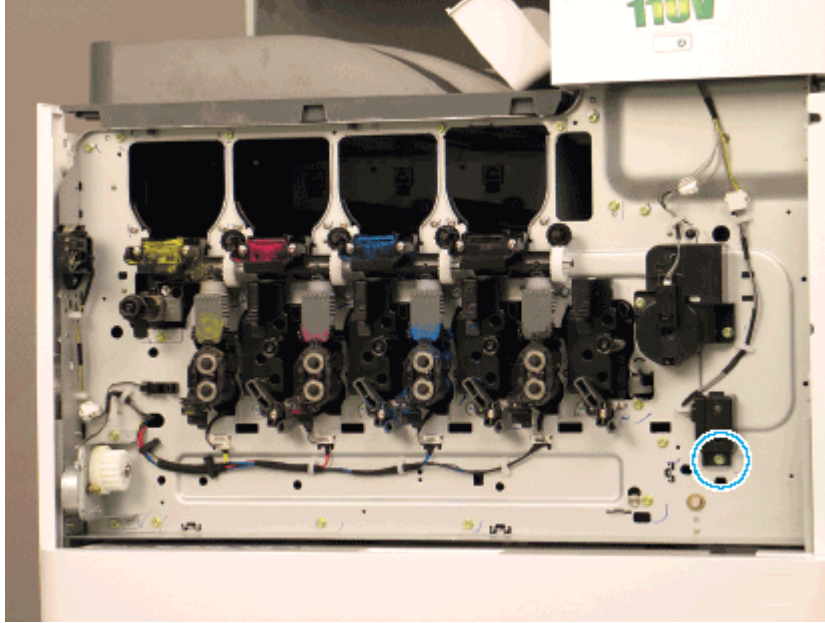


### Remove the toner collection full sensor

Follow these steps to remove the toner collection full sensor.

1. Release the cable from three restraints.
2. Disconnect one inline connector.
3. Remove one screw, and then remove the sensor.

**Figure 2-166** Remove the TCU full sensor



## Unpack the replacement assembly



Follow these steps to unpack the replacement assembly.


1. Dispose of the defective part.


 **NOTE:** HP recommends responsible disposal of the defective part.

<http://www8.hp.com/us/en/hp-information/environment/product-recycling.html>

2. Unpack the replacement part from the packaging.

 **CAUTION:**  Some parts are sensitive to electrostatic discharge (ESD). Always perform service work at an ESD-protected workstation or mat. If an ESD workstation or mat is not available, touch the sheet-metal chassis to provide a static ground before touching an ESD-sensitive assembly. Protect the ESD-sensitive assemblies by placing them in ESD pouches when they are out of the printer.

 **IMPORTANT:** Make sure that all of the shipping materials (for example shipping tape) are removed from the replacement part prior to installation.

 **NOTE:** If the replacement part is a roller or pad, avoid touching the spongy part of it. Skin oils on the roller or pad can cause paper pickup and/or print-quality problems. HP recommends using disposable gloves when handling rollers or pads or washing your hands before touching rollers or pads.

3. To install an assembly, reverse the removal steps.



---

**NOTE:** When applicable, special installation instructions are provided for an assembly at the end of the removal procedure. Always completely read the removal instructions and follow all special installation instructions.

---



## Removal and replacement: Toner duct assembly

This document provides the procedures to remove the toner duct assembly.

Mean time to repair: 15 minutes

Service level: Intermediate



**IMPORTANT:** When applicable, special installation instructions are provided for an assembly at the end of the removal procedure. Always completely read the removal instructions and follow all special installation instructions.

### Before performing service

- Disconnect the power cable.

Use the table below to identify the correct part number for your printer. To order the part, go to [www.hp.com/buy/parts](http://www.hp.com/buy/parts)

**Table 2-39** Part information

Part number	Part description
JC93-00483B	Toner duct assembly (E778xx series)
5QJ94-40001	Toner duct assembly (E783xx series)

### Required tools

- #2 JIS screwdriver with a magnetic tip

### After performing service

#### Turn the printer power on

- Connect the power cable.
- Use the power switch to turn the power on.

### Post service test

Copy, scan, or print a document. Verify the document copies, scans, or prints correctly.

## Remove the toner cartridges and TCU

Follow these steps to remove the toner cartridges and TCU.

- ▲ Open the front door and remove the toner collection unit and toner cartridges.

Figure 2-167 Remove the TCU



### Remove the front inner cover

Follow these steps to remove the front inner cover.

- ▲ Remove seven screws, and then remove the front inner cover.


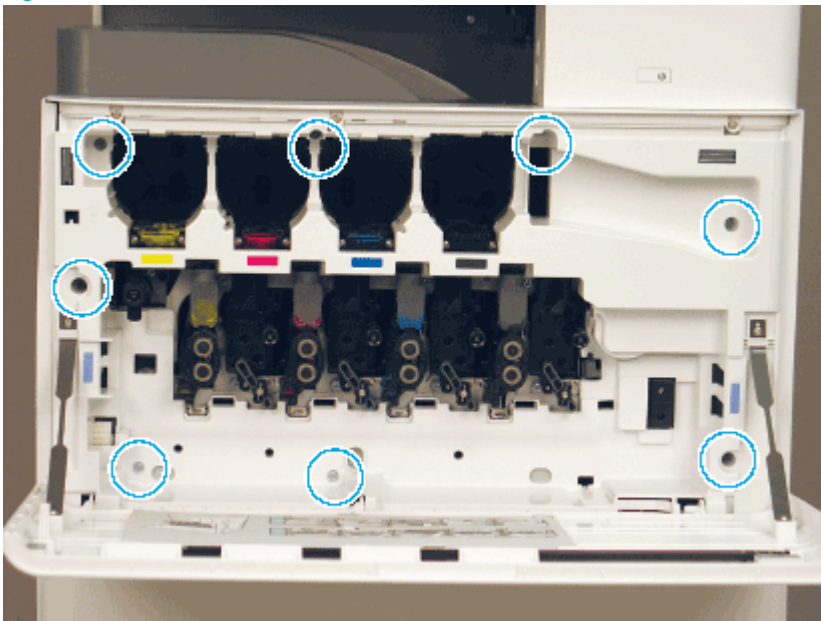
 **NOTE:** The TCU cleaning blade must be removed to remove the front inner cover.

Figure 2-168 Remove the front inner cover

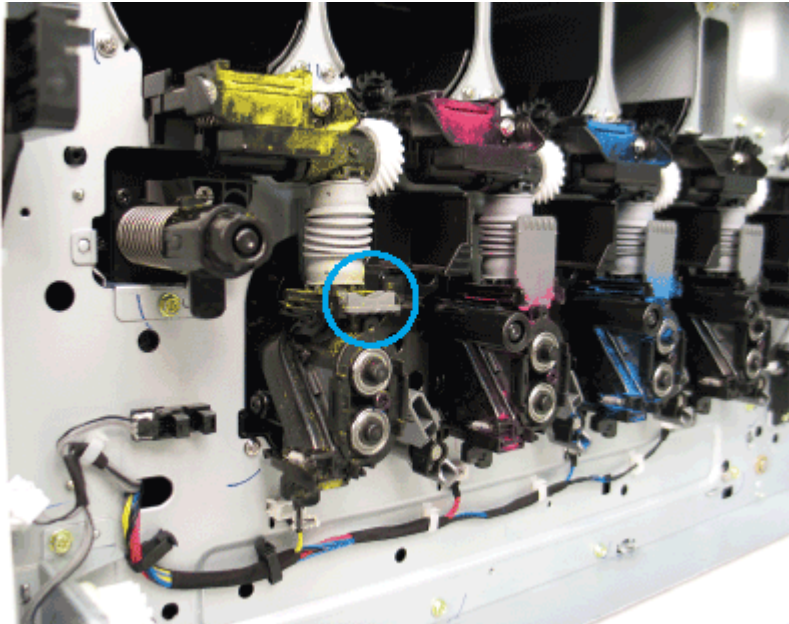


### Remove the toner duct assembly

Follow these steps to remove the toner duct assembly.

1. Close the shutter duct on the developer unit.

**Figure 2-169** Close the developer unit shutter duct for the station being replaced



2. Remove the shutter from the top of the developer unit.

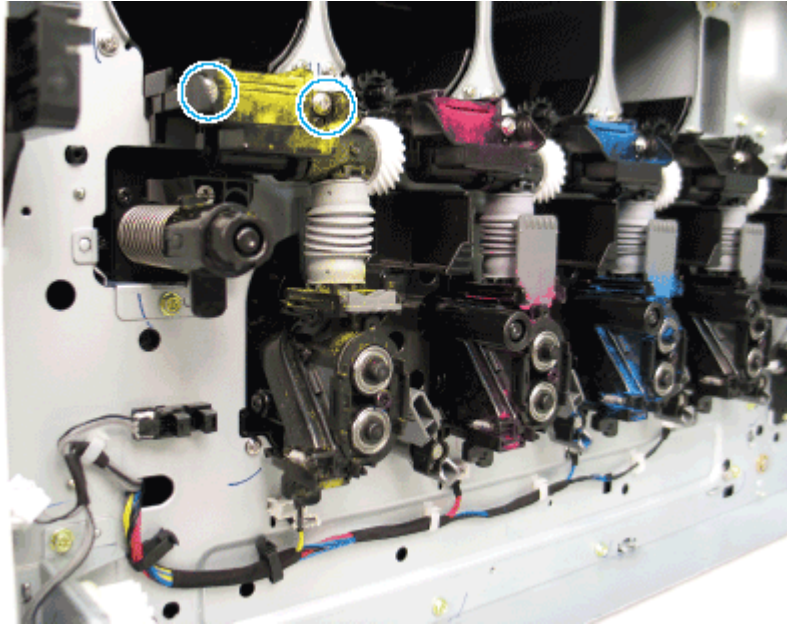
**Figure 2-170** Remove the developer unit shutter duct



3. Remove two screws, and then remove the cover at the front of the duct assembly.

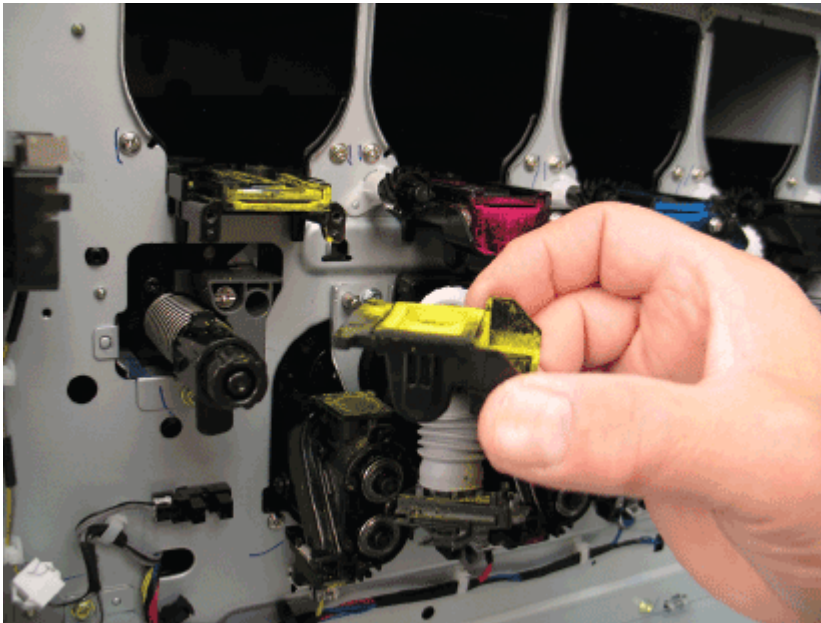
**⚠ CAUTION:** Be careful not to spill toner while removing the toner duct assembly.

**Figure 2-171** Remove the toner duct cover



4. Remove the toner duct assembly.

**Figure 2-172** Remove the toner duct assembly



**📌 IMPORTANT:** The toner supply shutters must be in the open (up) position whenever performing service in this area of the printer.

## Unpack the replacement assembly

Follow these steps to unpack the replacement assembly.

1. Dispose of the defective part.




**NOTE:** HP recommends responsible disposal of the defective part.

<http://www8.hp.com/us/en/hp-information/environment/product-recycling.html>

2. Unpack the replacement part from the packaging.



**CAUTION:**  Some parts are sensitive to electrostatic discharge (ESD). Always perform service work at an ESD-protected workstation or mat. If an ESD workstation or mat is not available, touch the sheet-metal chassis to provide a static ground before touching an ESD-sensitive assembly. Protect the ESD-sensitive assemblies by placing them in ESD pouches when they are out of the printer.



**IMPORTANT:** Make sure that all of the shipping materials (for example shipping tape) are removed from the replacement part prior to installation.



**NOTE:** If the replacement part is a roller or pad, avoid touching the spongy part of it. Skin oils on the roller or pad can cause paper pickup and/or print-quality problems. HP recommends using disposable gloves when handling rollers or pads or washing your hands before touching rollers or pads.

3. To install an assembly, reverse the removal steps.



**NOTE:** When applicable, special installation instructions are provided for an assembly at the end of the removal procedure. Always completely read the removal instructions and follow all special installation instructions.


## Removal and replacement: Fuser-duct fan

This document provides the procedures to remove the fuser-duct fan assembly.

 [View a video of removing the fuser-duct fan assembly.](#)

Mean time to repair: 15 minutes

Service level: Intermediate

 **IMPORTANT:** When applicable, special installation instructions are provided for an assembly at the end of the removal procedure. Always completely read the removal instructions and follow all special installation instructions.

### Before performing service

- Disconnect the power cable.

Use the table below to identify the correct part number for your printer. To order the part, go to [www.hp.com/buy/parts](http://www.hp.com/buy/parts)

**Table 2-40 Part information**

Part number	Part description
JC67-00570A	Upper fuser-duct fan assembly
JC67-00571A	Lower fuser-duct fan assembly
JC93-00161A	Fan-Type 7 fuser

### Required tools

- #2 JIS screwdriver with a magnetic tip

### After performing service

#### Turn the printer power on

- Connect the power cable.
- Use the power switch to turn the power on.

### Post service test

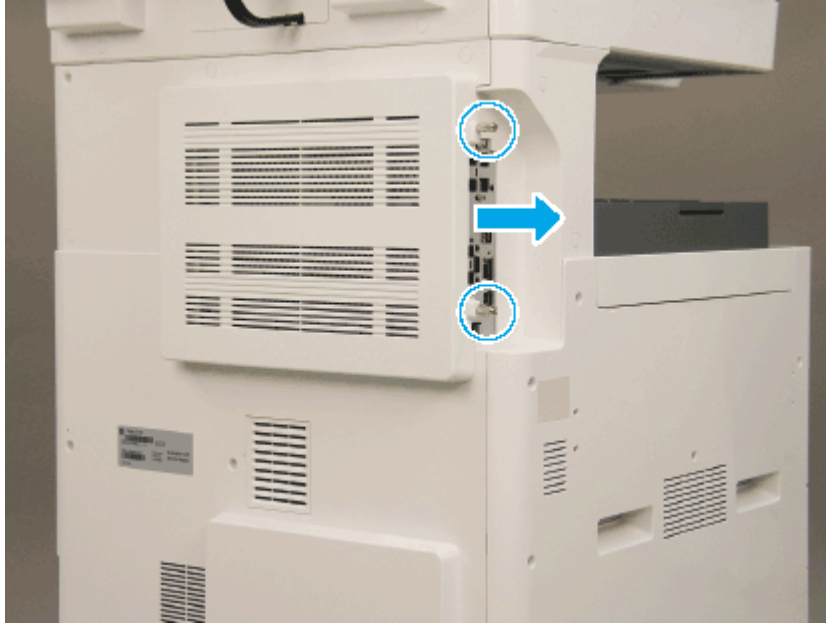
Copy, scan, or print a document. Verify the document copies, scans, or prints correctly.

### Remove the rear covers

Follow these steps to remove the rear covers.

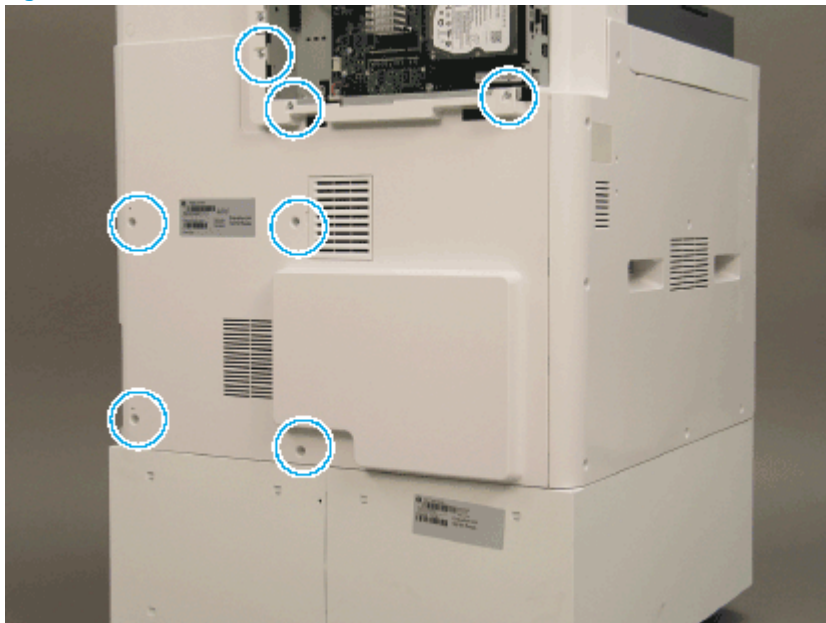
1. Unscrew two captive thumbscrews on the formatter cover. Slide the formatter cover to the left, and then to the right to remove.

Figure 2-173 Remove the formatter cover



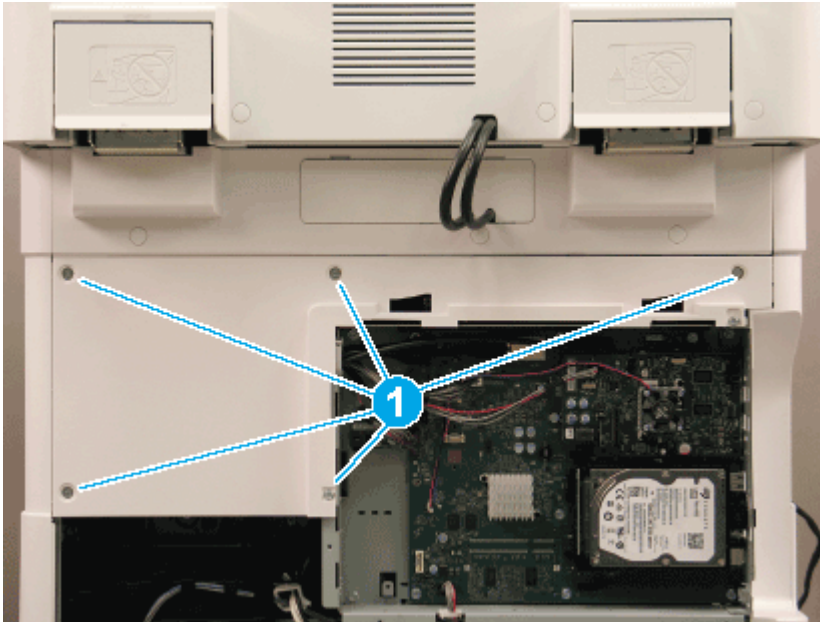
2. Remove seven screws, and then remove the rear-bottom cover.

Figure 2-174 Remove the rear-bottom cover



3. Remove six screws (callout 1), and then remove the rear-top cover.

Figure 2-175 Remove the rear-top cover

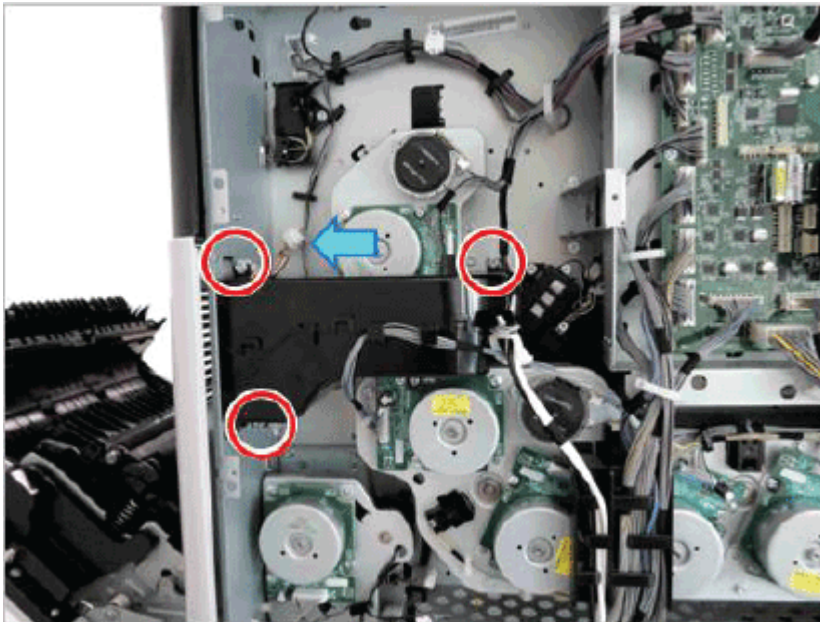


## Remove the fuser duct

Follow these steps to remove the fuser duct.

1. Disconnect the connector and remove the cable from the cable restraint. Remove the cable from the guides on the duct housing. Remove three yellow screws, and then remove the fuser-duct.

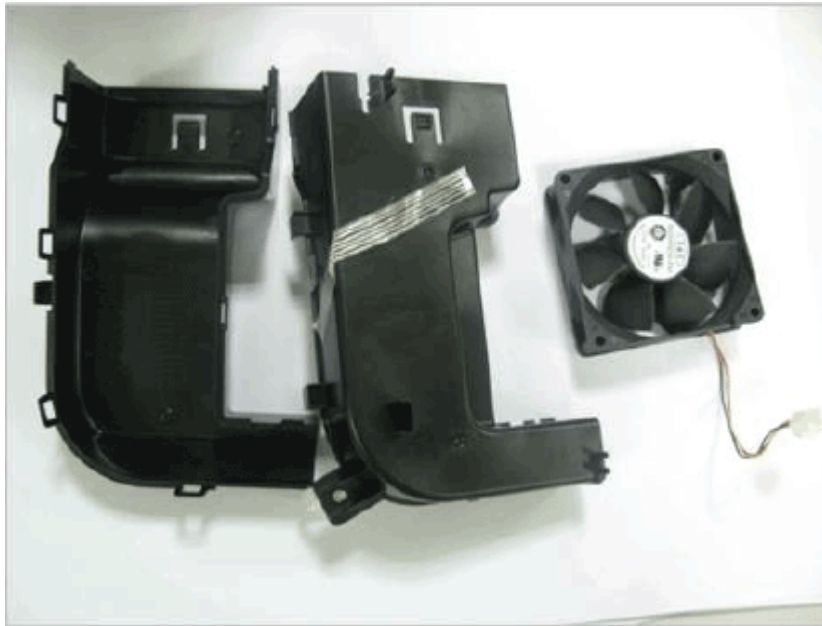
Figure 2-176 Remove the fuser-duct





2. Release the fan by separating the fuser-duct.

Figure 2-177 Separate the fuser-duct



## Unpack the replacement assembly

Follow these steps to unpack the replacement assembly.

1. Dispose of the defective part.

---



 **NOTE:** HP recommends responsible disposal of the defective part.


<http://www8.hp.com/us/en/hp-information/environment/product-recycling.html>


---

2. Unpack the replacement part from the packaging.

---

 **CAUTION:**  Some parts are sensitive to electrostatic discharge (ESD). Always perform service work at an ESD-protected workstation or mat. If an ESD workstation or mat is not available, touch the sheet-metal chassis to provide a static ground before touching an ESD-sensitive assembly. Protect the ESD-sensitive assemblies by placing them in ESD pouches when they are out of the printer.


 **IMPORTANT:** Make sure that all of the shipping materials (for example shipping tape) are removed from the replacement part prior to installation.

 **NOTE:** If the replacement part is a roller or pad, avoid touching the spongy part of it. Skin oils on the roller or pad can cause paper pickup and/or print-quality problems. HP recommends using disposable gloves when handling rollers or pads or washing your hands before touching rollers or pads.

---

3. To install an assembly, reverse the removal steps.

---

 **NOTE:** When applicable, special installation instructions are provided for an assembly at the end of the removal procedure. Always completely read the removal instructions and follow all special installation instructions.


---

## Removal and replacement: Pickup drive units

This document provides the procedures to remove the Pickup drive units.

Mean time to repair: 15 minutes

Service level: Intermediate

 **IMPORTANT:** When applicable, special installation instructions are provided for an assembly at the end of the removal procedure. Always completely read the removal instructions and follow all special installation instructions.

### Before performing service

- Disconnect the power cable.

Use the table below to identify the correct part number for your printer. To order the part, go to [www.hp.com/buy/parts](http://www.hp.com/buy/parts)

**Table 2-41** Part information

Part number	Part description
JC93-00511A	1st pickup drive assembly
JC93-01441A	2nd pickup drive assembly

### Required tools

- #2 JIS screwdriver with a magnetic tip

### After performing service

#### Turn the printer power on

- Connect the power cable.
- Use the power switch to turn the power on.

### Post service test

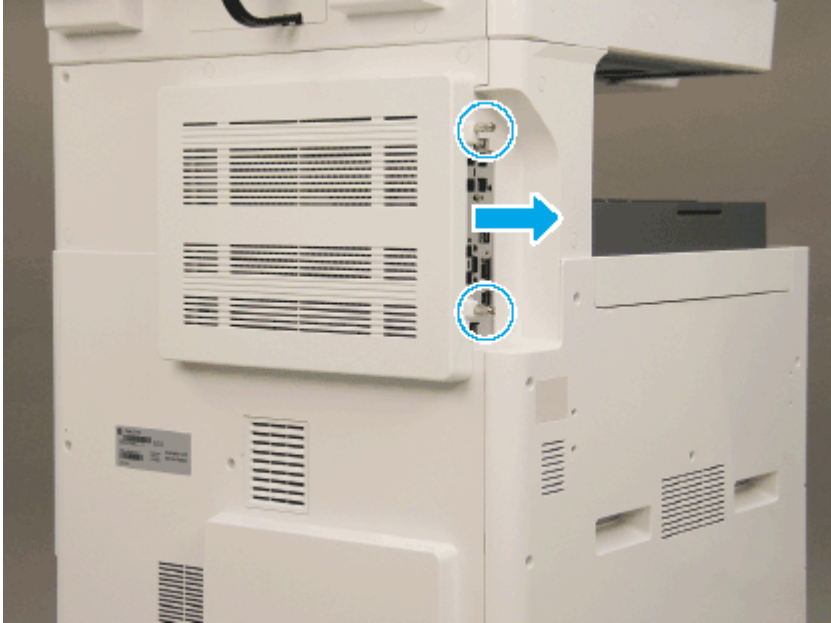
Copy, scan, or print a document. Verify the document copies, scans, or prints correctly.

### Remove the rear covers

Follow these steps to remove the rear covers.

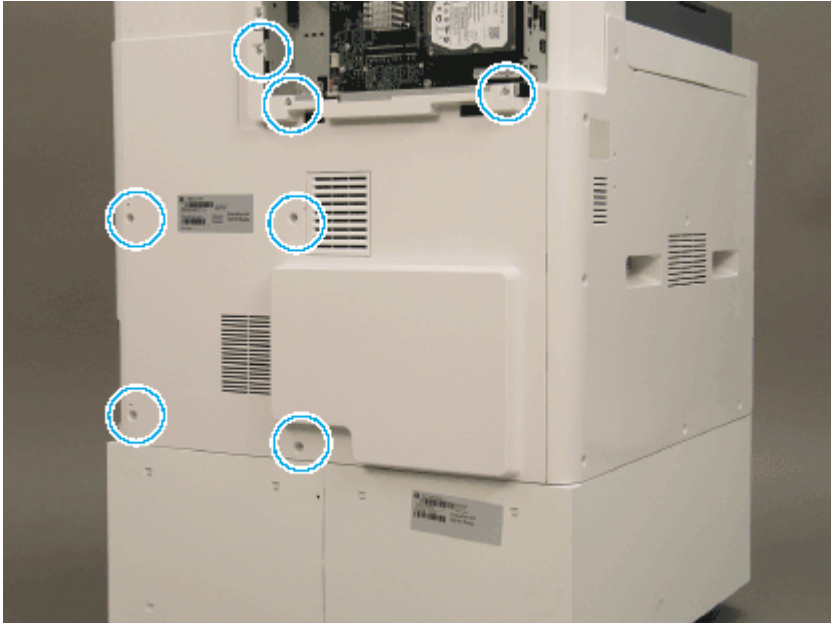
1. Unscrew two captive thumbscrews on the formatter cover. Slide the formatter cover to the left, and then to the right to remove.

Figure 2-178 Remove the formatter cover



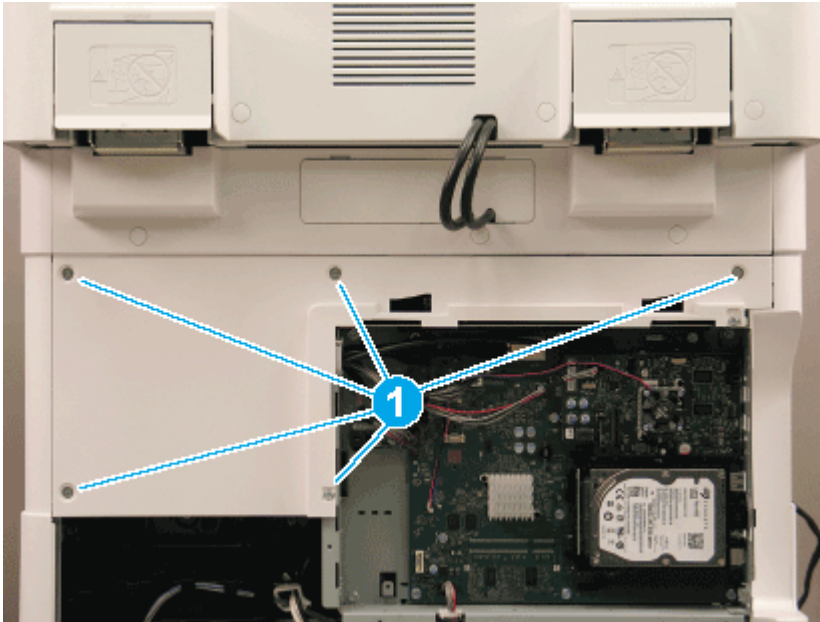
- 2. Remove seven screws, and then remove the rear-bottom cover.

Figure 2-179 Remove the rear-bottom cover



3. Remove six screws (callout 1), and then remove the rear-top cover.

Figure 2-180 Remove the rear-top cover

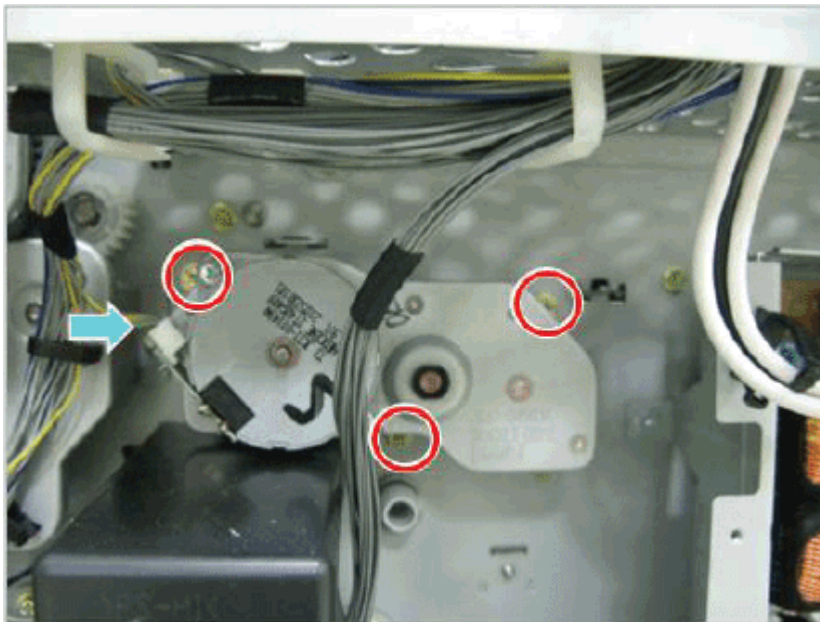


### Remove the pickup drive unit

Follow these steps to remove the pickup drive unit.

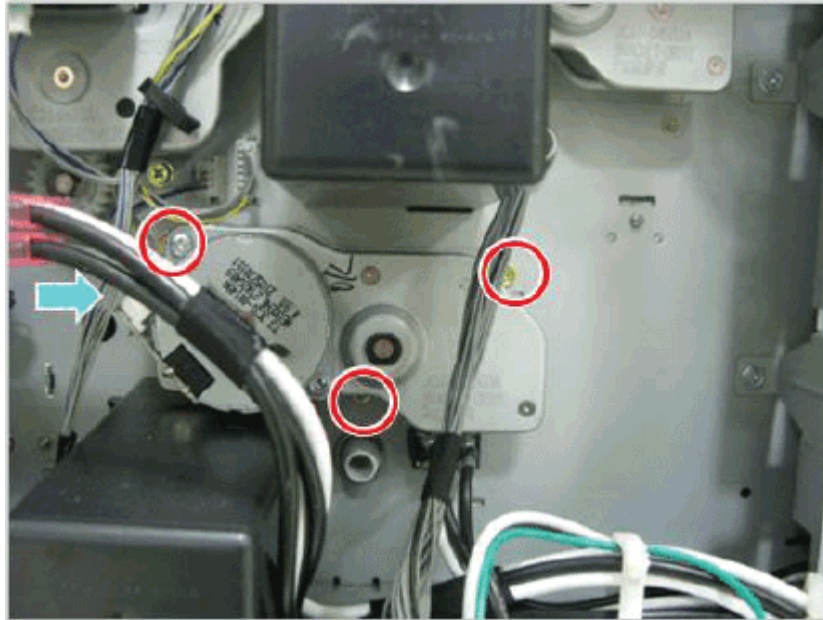
1. Release the cable from the cable restraint and disconnect the connector. Remove three yellow screws, and then remove the Pickup Drive unit 1.

Figure 2-181 Remove screws and pickup drive unit 1



2. Disconnect the connector. Remove three screws, and then remove the Pickup Drive unit 2.

Figure 2-182 Remove screws and pickup drive unit 2



## Unpack the replacement assembly



Follow these steps to unpack the replacement assembly.

1. Dispose of the defective part.


 **NOTE:** HP recommends responsible disposal of the defective part.

<http://www8.hp.com/us/en/hp-information/environment/product-recycling.html>

2. Unpack the replacement part from the packaging.

 **CAUTION:**  Some parts are sensitive to electrostatic discharge (ESD). Always perform service work at an ESD-protected workstation or mat. If an ESD workstation or mat is not available, touch the sheet-metal chassis to provide a static ground before touching an ESD-sensitive assembly. Protect the ESD-sensitive assemblies by placing them in ESD pouches when they are out of the printer.

 **IMPORTANT:** Make sure that all of the shipping materials (for example shipping tape) are removed from the replacement part prior to installation.

 **NOTE:** If the replacement part is a roller or pad, avoid touching the spongy part of it. Skin oils on the roller or pad can cause paper pickup and/or print-quality problems. HP recommends using disposable gloves when handling rollers or pads or washing your hands before touching rollers or pads.

3. To install an assembly, reverse the removal steps.

 **NOTE:** When applicable, special installation instructions are provided for an assembly at the end of the removal procedure. Always completely read the removal instructions and follow all special installation instructions.

## Removal and replacement: Feed sensor 1


This document provides the procedures to remove the feed sensor 1.

 [View a video of removing and replacing the feed sensor 1.](#)

Mean time to repair: 10 minutes

Service level: Basic

---

 **IMPORTANT:** When applicable, special installation instructions are provided for an assembly at the end of the removal procedure. Always completely read the removal instructions and follow all special installation instructions.

---

### Before performing service

- Disconnect the power cable.

Use the table below to identify the correct part number for your printer. To order the part, go to [www.hp.com/buy/parts](http://www.hp.com/buy/parts)

**Table 2-42 Part information**

Part number	Part description
0604-001393	Feed sensor 1

### Required tools

- #2 JIS screwdriver with a magnetic tip

### After performing service

#### Turn the printer power on

- Connect the power cable.
- Use the power switch to turn the power on.

### Post service test

Copy, scan, or print a document. Verify the document copies, scans, or prints correctly.

## Remove the right door

Follow these steps to remove the right door.

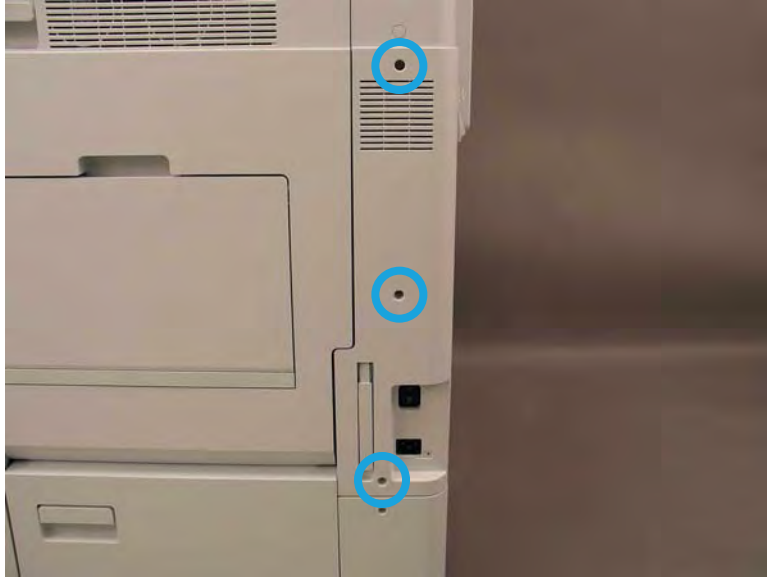
---

 **NOTE:** Remove second exit drive if installed.

---

1. Remove three screws, and then remove the cover (A).

Figure 2-183 Remove cover



2. Disconnect the right door connector.

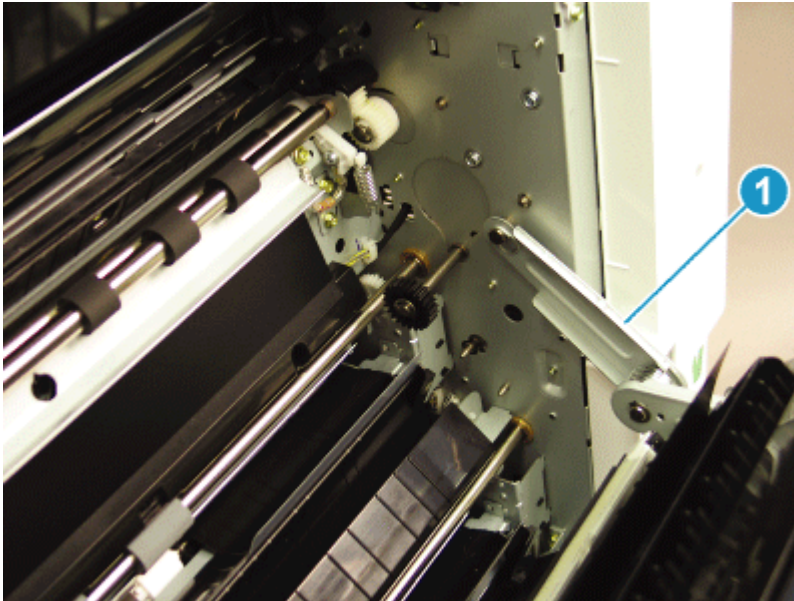
Figure 2-184 Disconnect right door connector



3. Release the right hinge (callout 1).

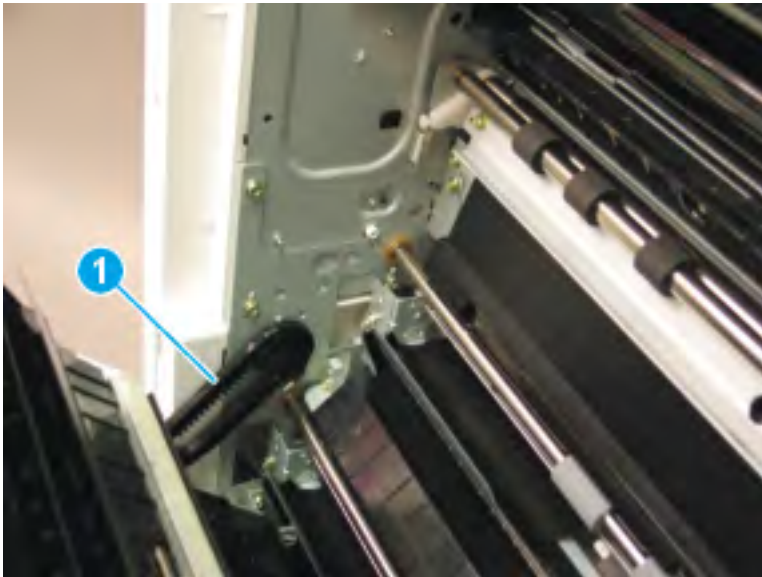
**⚠ CAUTION:** The right hinge spring tension can be dangerous. Use caution when releasing the right hinge to avoid injury.

Figure 2-185 Release right hinge



4. Release the left dampener (callout 1).

Figure 2-186 Release left dampener





5. Remove the right door.


 **NOTE:** Open the lower access door. If there is an HCl or 2x520 input device, release the dampener to clear the lower right door. Remove clockwise.

Figure 2-187 Remove right door

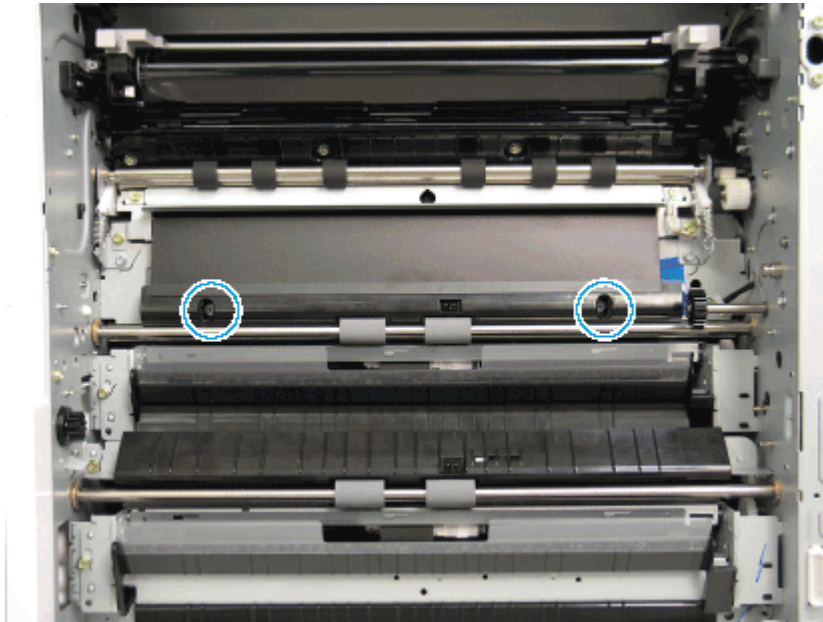


## Remove feed sensor 1

Follow these steps to remove feed sensor 1.

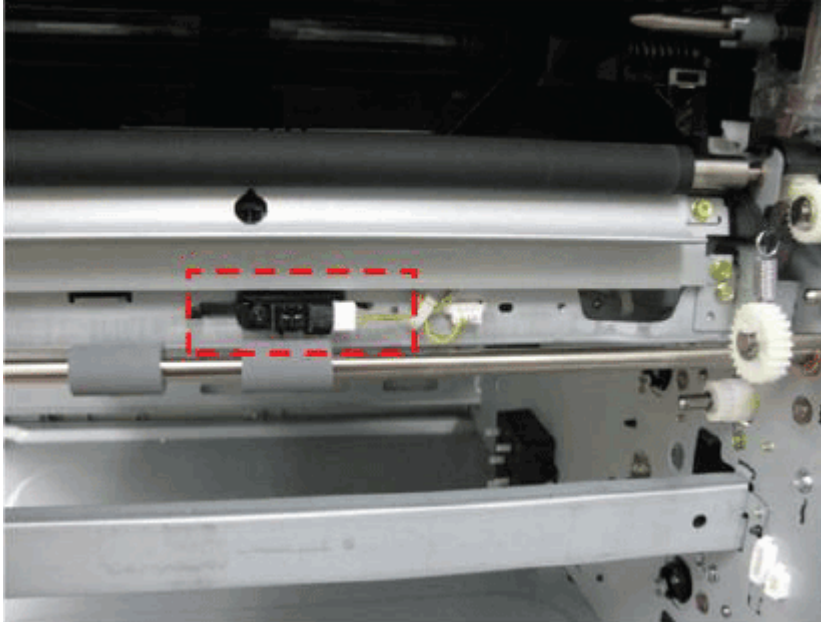
1. Remove two screws, and then remove the sensor cover.

Figure 2-188 Remove screws and sensor cover



2. Disconnect the connector, remove one screw, and then remove the feed sensor cover.

Figure 2-189 Remove feed sensor



## Unpack the replacement assembly



Follow these steps to unpack the replacement assembly.


1. Dispose of the defective part.


 **NOTE:** HP recommends responsible disposal of the defective part.

<http://www8.hp.com/us/en/hp-information/environment/product-recycling.html>


2. Unpack the replacement part from the packaging.

 **CAUTION:**  Some parts are sensitive to electrostatic discharge (ESD). Always perform service work at an ESD-protected workstation or mat. If an ESD workstation or mat is not available, touch the sheet-metal chassis to provide a static ground before touching an ESD-sensitive assembly. Protect the ESD-sensitive assemblies by placing them in ESD pouches when they are out of the printer.

 **IMPORTANT:** Make sure that all of the shipping materials (for example shipping tape) are removed from the replacement part prior to installation.

 **NOTE:** If the replacement part is a roller or pad, avoid touching the spongy part of it. Skin oils on the roller or pad can cause paper pickup and/or print-quality problems. HP recommends using disposable gloves when handling rollers or pads or washing your hands before touching rollers or pads.

3. To install an assembly, reverse the removal steps.

 **NOTE:** When applicable, special installation instructions are provided for an assembly at the end of the removal procedure. Always completely read the removal instructions and follow all special installation instructions.

## Removal and replacement: Feed sensor 2


This document provides the procedures to remove the feed sensor 2.

 [View a video of removing and replacing the feed sensor 2.](#)

Mean time to repair: 10 minutes

Service level: Basic

---

 **IMPORTANT:** When applicable, special installation instructions are provided for an assembly at the end of the removal procedure. Always completely read the removal instructions and follow all special installation instructions.

---

### Before performing service

- Disconnect the power cable.

Use the table below to identify the correct part number for your printer. To order the part, go to [www.hp.com/buy/parts](http://www.hp.com/buy/parts)

**Table 2-43 Part information**

Part number	Part description
0604-001393	Feed sensor 2

### Required tools

- #2 JIS screwdriver with a magnetic tip

### After performing service

#### Turn the printer power on

- Connect the power cable.
- Use the power switch to turn the power on.

### Post service test

Copy, scan, or print a document. Verify the document copies, scans, or prints correctly.

### Remove the right door

Follow these steps to remove the right door.

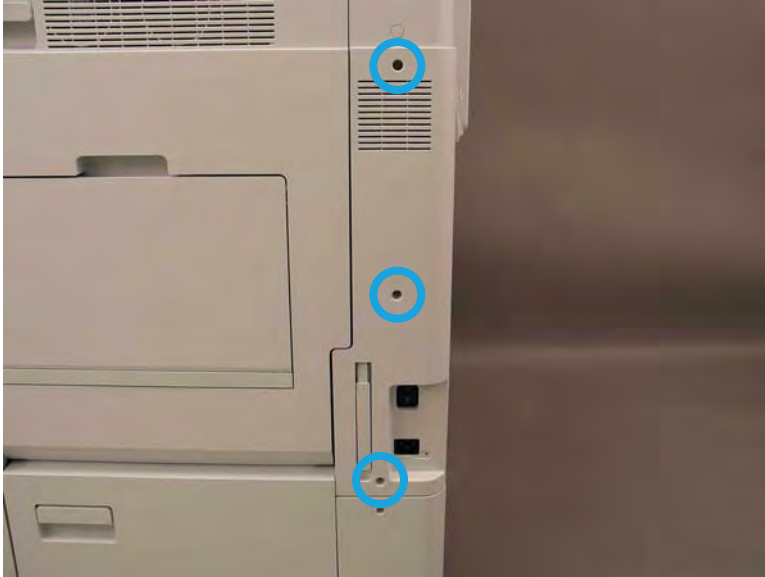
---

 **NOTE:** Remove second exit drive if installed.

---

1. Remove three screws, and then remove the cover (A).

Figure 2-190 Remove cover



2. Disconnect the right door connector.

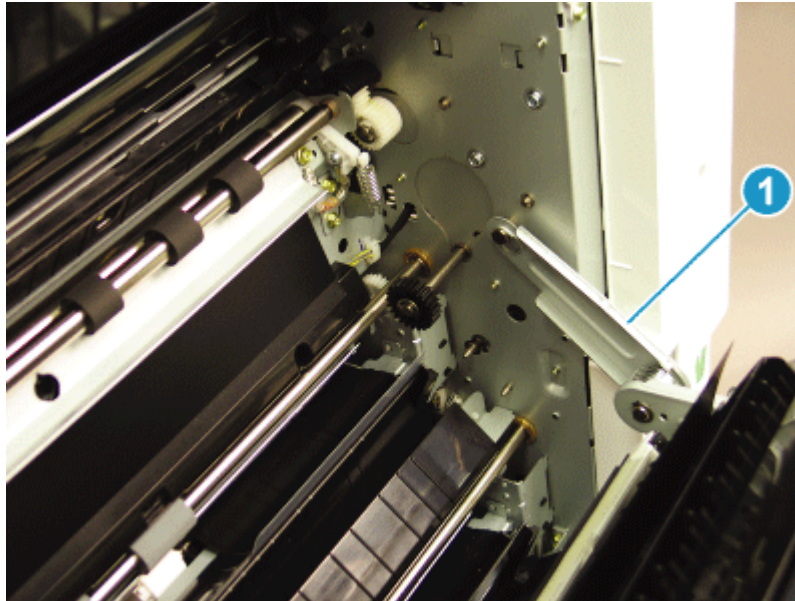
Figure 2-191 Disconnect right door connector



3. Release the right hinge (callout 1).

**⚠ CAUTION:** The right hinge spring tension can be dangerous. Use caution when releasing the right hinge to avoid injury.

Figure 2-192 Release right hinge




4. Release the left dampener (callout 1).

Figure 2-193 Release left dampener



5. Remove the right door.

 **NOTE:** Open the lower access door. If there is an HCI or 2x520 input device, release the dampener to clear the lower right door. Remove clockwise.

**Figure 2-194** Remove right door

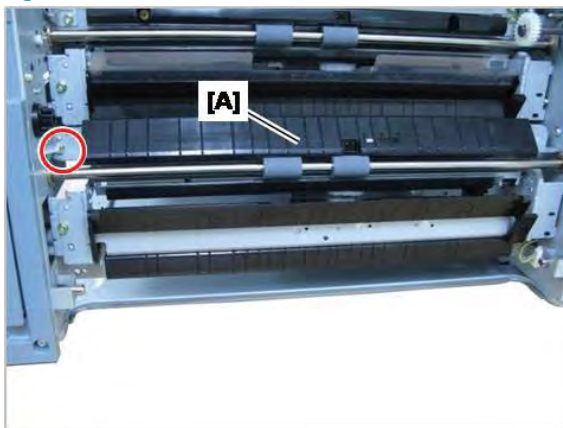


## Remove feed sensor 2

Follow these steps to remove feed sensor 2.

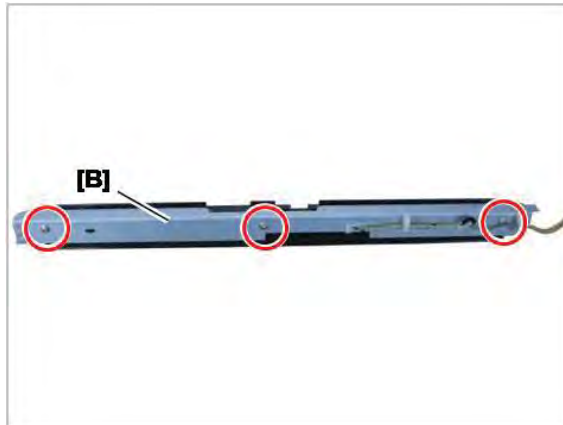
1. Remove one screw, and then remove the Feed Unit (A).

**Figure 2-195** Remove screw and feed unit



2. Remove three screws, and then remove the bracket (B).

Figure 2-196 Remove screws and bracket



3. Disconnect the connector, and then remove the feed sensor 2.

Figure 2-197 Remove feed sensor 2



### Unpack the replacement assembly

Follow these steps to unpack the replacement assembly.

1. Dispose of the defective part.



---


 **NOTE:** HP recommends responsible disposal of the defective part.


<http://www8.hp.com/us/en/hp-information/environment/product-recycling.html>

---

2. Unpack the replacement part from the packaging.


 **CAUTION:**  Some parts are sensitive to electrostatic discharge (ESD). Always perform service work at an ESD-protected workstation or mat. If an ESD workstation or mat is not available, touch the sheet-metal chassis to provide a static ground before touching an ESD-sensitive assembly. Protect the ESD-sensitive assemblies by placing them in ESD pouches when they are out of the printer.

 **IMPORTANT:** Make sure that all of the shipping materials (for example shipping tape) are removed from the replacement part prior to installation.

 **NOTE:** If the replacement part is a roller or pad, avoid touching the spongy part of it. Skin oils on the roller or pad can cause paper pickup and/or print-quality problems. HP recommends using disposable gloves when handling rollers or pads or washing your hands before touching rollers or pads.

---

3. To install an assembly, reverse the removal steps.

 **NOTE:** When applicable, special installation instructions are provided for an assembly at the end of the removal procedure. Always completely read the removal instructions and follow all special installation instructions.

---



## Removal and replacement: Automatic color registration (ACR)


This document provides the procedures to remove the automatic color registration assembly (ACR) assembly.

 [View a video of removing the automatic color registration \(ACR\) assembly.](#)

Mean time to repair: 15 minutes

Service level: Intermediate

---

 **IMPORTANT:** When applicable, special installation instructions are provided for an assembly at the end of the removal procedure. Always completely read the removal instructions and follow all special installation instructions.

---

### Before performing service

- Disconnect the power cable.

Use the table below to identify the correct part number for your printer. To order the part, go to [www.hp.com/buy/parts](http://www.hp.com/buy/parts)

**Table 2-44 Part information**

Part number	Part description
JC93-00895A	Automatic Color Registration (E778xx series)
JC93-01803A	Automatic Color Registration (E783xx series)

### Required tools

- #2 JIS screwdriver with a magnetic tip

### After performing service

#### Turn the printer power on

- Connect the power cable.
- Use the power switch to turn the power on.

### Post service test

Copy, scan, or print a document. Verify the document copies, scans, or prints correctly.

### Remove the right door

Follow these steps to remove the right door.

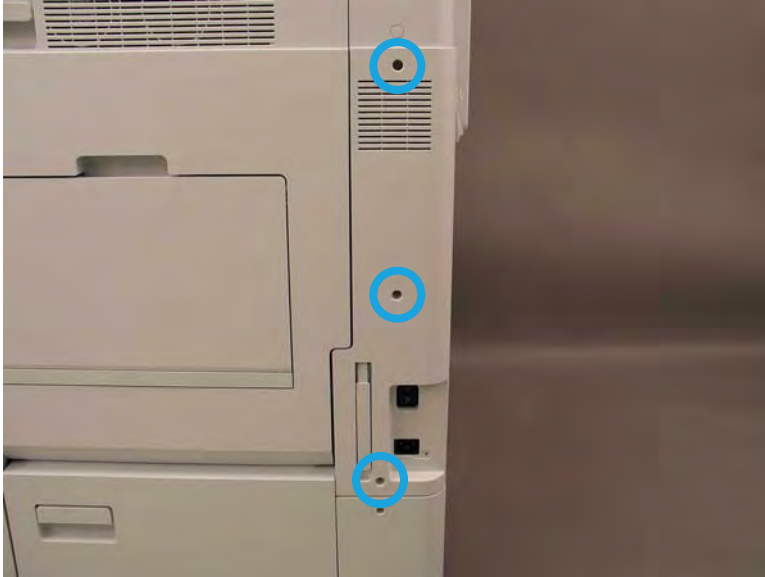
---

 **NOTE:** Remove second exit drive if installed.

---

1. Remove three screws, and then remove the cover (A).

Figure 2-198 Remove cover



2. Disconnect the right door connector.

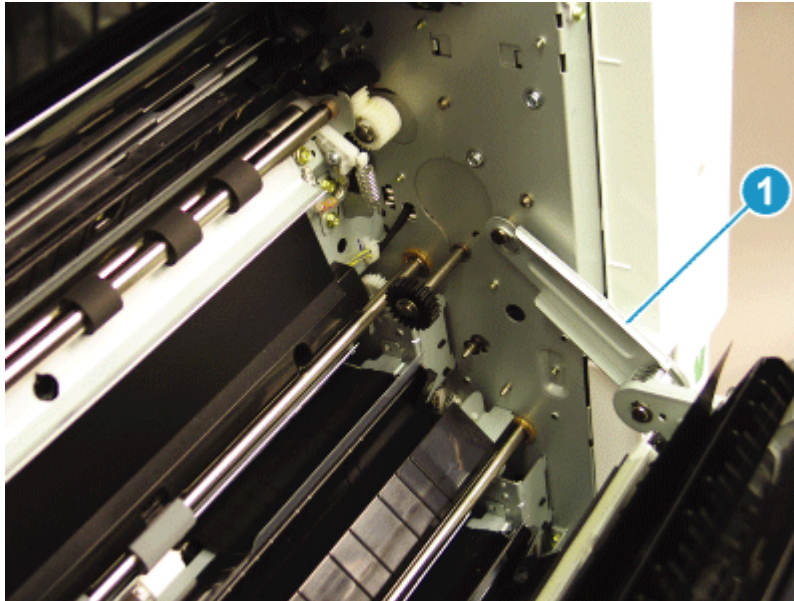
Figure 2-199 Disconnect right door connector



3. Release the right hinge (callout 1).

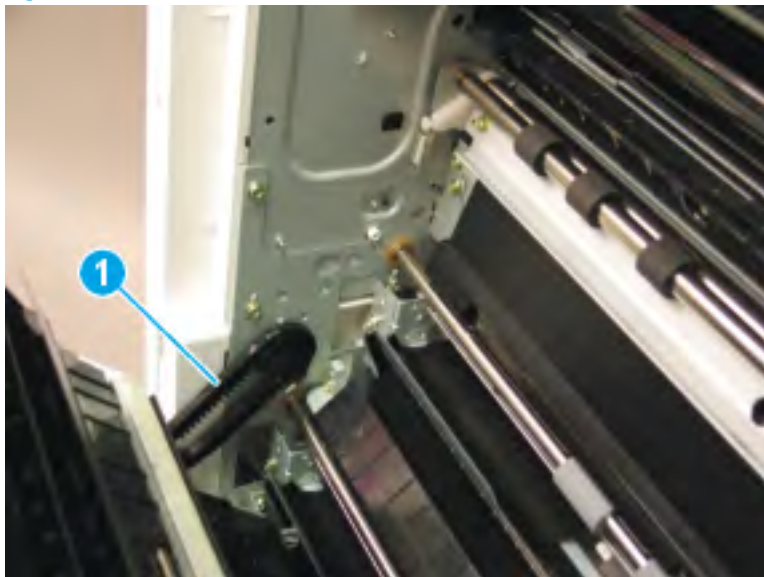
**⚠ CAUTION:** The right hinge spring tension can be dangerous. Use caution when releasing the right hinge to avoid injury.

Figure 2-200 Release right hinge




4. Release the left dampener (callout 1).

Figure 2-201 Release left dampener



5. Remove the right door.

 **NOTE:** Open the lower access door. If there is an HCI or 2x520 input device, release the dampener to clear the lower right door. Remove clockwise.

**Figure 2-202** Remove right door

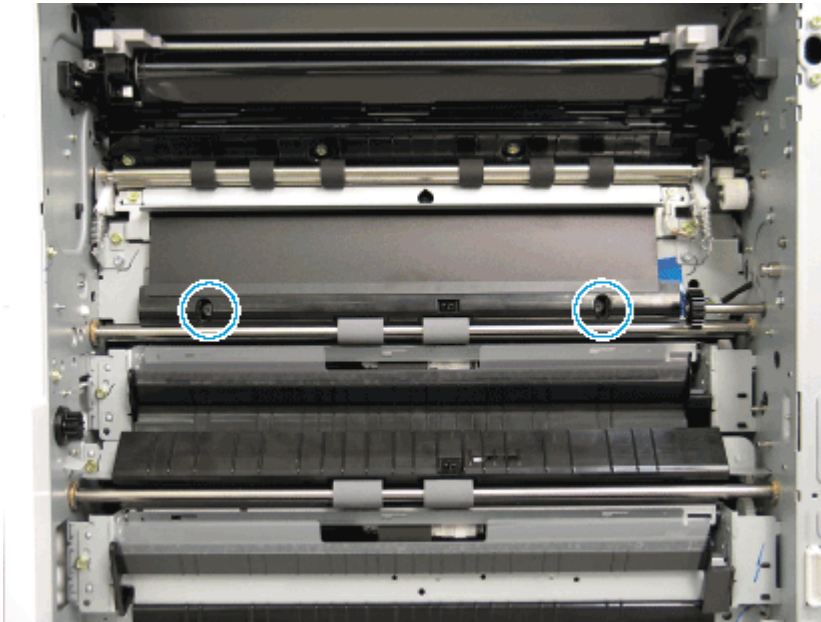


## Remove the color plane registration unit

Follow these steps to remove the color plane registration unit.

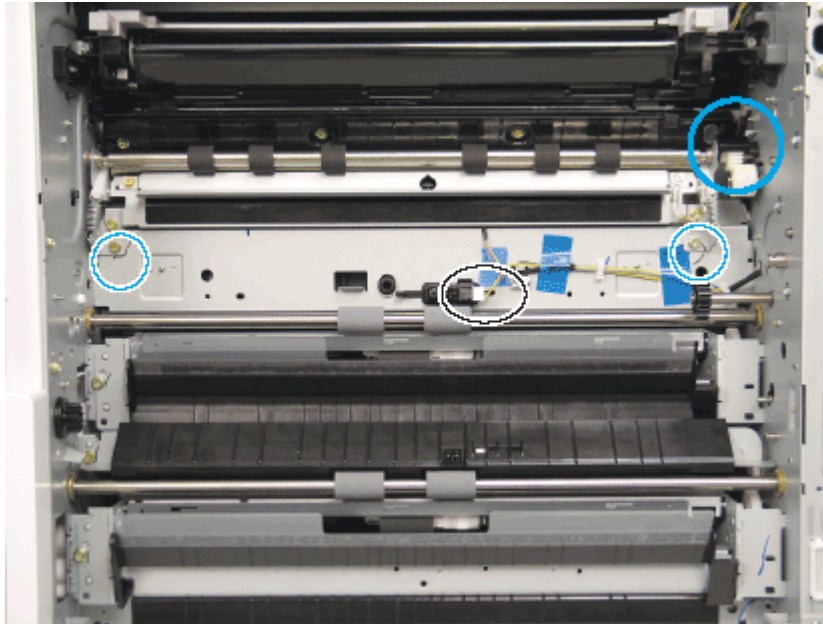
1. Remove two screws, and then remove the feed sensor cover.

**Figure 2-203** Remove the feed sensor cover




2. Remove the black plastic bushing retainer at the rear of the REGI unit, disconnect one connector, and then remove two screws at the front and rear of the REGI unit.

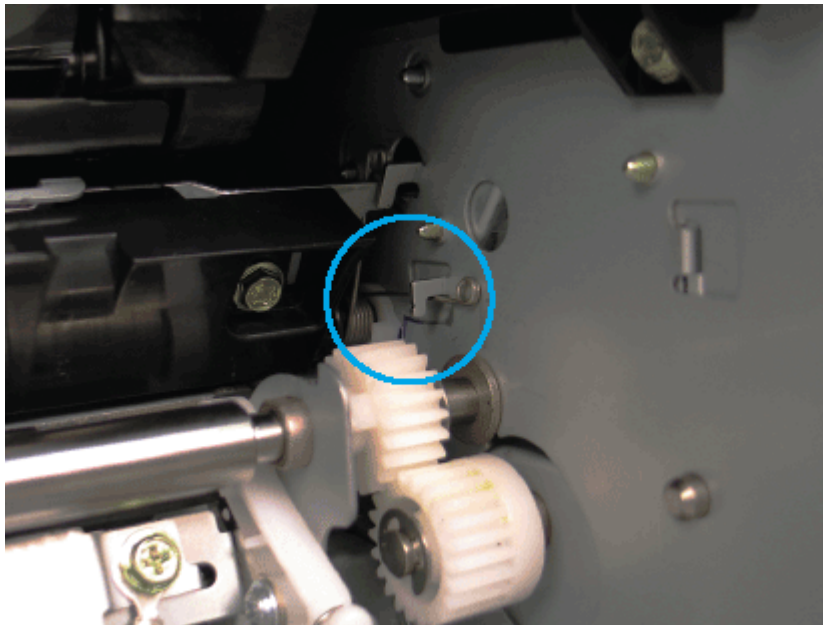
Figure 2-204 Remove the REGI unit



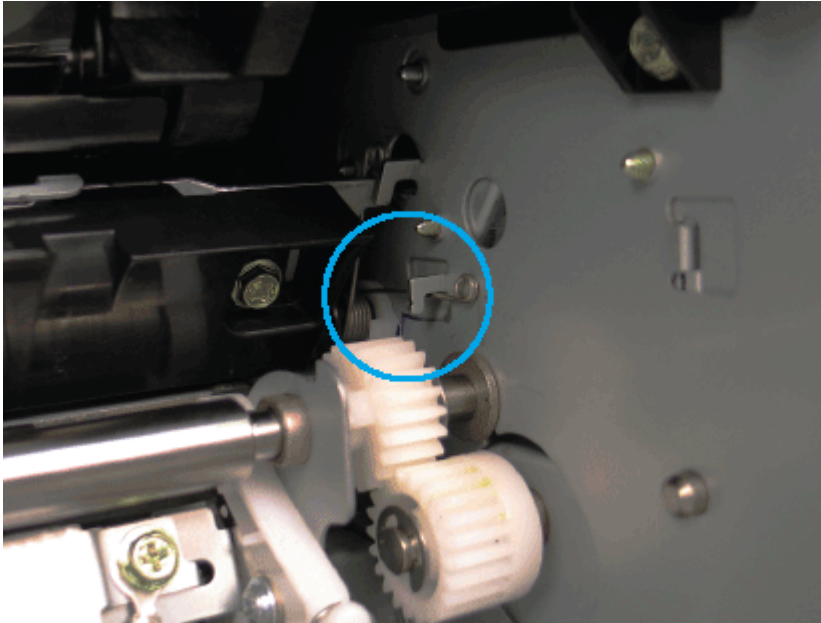
3. Release the front side of the REGI unit first, and then release the back side to remove.

 **IMPORTANT:** Note the bushings on the REGI assembly—they are not retained and can fall from the assembly during removal.

4. Locate and remove the clip at the rear (make note of the orientation of the spring and the clip before removal).



5. Release the spring from the hook at the rear.



6. Slide the shutter toward rear.
7. Remove the spring (make note of the orientation of the spring before removal).
8. Remove four screws in the cover.
9. Release the left cover at the front and slide off at the rear of the assembly.
10. Replace the sensor (remove two screws and one connector) or thermistor (remove one screw and one connector).



11. Disconnect the thermistor cable and three connectors at the sensor PCA.



**NOTE:** After replacing the CPR sensor assembly, make sure the assembly rests forward, but moves backward freely.

12. A [Color Plane Registration](#) must be performed from the [Diagnostics](#) menu whenever a sensor is replaced.

## Unpack the replacement assembly

Follow these steps to unpack the replacement assembly.

1. Dispose of the defective part.




**NOTE:** HP recommends responsible disposal of the defective part.

<http://www8.hp.com/us/en/hp-information/environment/product-recycling.html>

---

2. Unpack the replacement part from the packaging.



**CAUTION:**  Some parts are sensitive to electrostatic discharge (ESD). Always perform service work at an ESD-protected workstation or mat. If an ESD workstation or mat is not available, touch the sheet-metal chassis to provide a static ground before touching an ESD-sensitive assembly. Protect the ESD-sensitive assemblies by placing them in ESD pouches when they are out of the printer.



**IMPORTANT:** Make sure that all of the shipping materials (for example shipping tape) are removed from the replacement part prior to installation.



**NOTE:** If the replacement part is a roller or pad, avoid touching the spongy part of it. Skin oils on the roller or pad can cause paper pickup and/or print-quality problems. HP recommends using disposable gloves when handling rollers or pads or washing your hands before touching rollers or pads.

---

3. To install an assembly, reverse the removal steps.



**NOTE:** When applicable, special installation instructions are provided for an assembly at the end of the removal procedure. Always completely read the removal instructions and follow all special installation instructions.

---


## Removal and replacement: Fuser out sensor

This document provides the procedures to remove the fuser out sensor.

 [View a video of removing and replacing the fuser out sensor.](#)

Mean time to repair: 10 minutes

Service level: Basic

 **IMPORTANT:** When applicable, special installation instructions are provided for an assembly at the end of the removal procedure. Always completely read the removal instructions and follow all special installation instructions.

### Before performing service

- Disconnect the power cable.

Use the table below to identify the correct part number for your printer. To order the part, go to [www.hp.com/buy/parts](http://www.hp.com/buy/parts)

**Table 2-45 Part information**

Part number	Part description
0604-001381	Fuser out sensor (E778xx series)
0604-001393	Fuser out sensor (E783xx series)

### Required tools

- #2 JIS screwdriver with a magnetic tip

### After performing service

#### Turn the printer power on

- Connect the power cable.
- Use the power switch to turn the power on.

### Post service test

Copy, scan, or print a document. Verify the document copies, scans, or prints correctly.

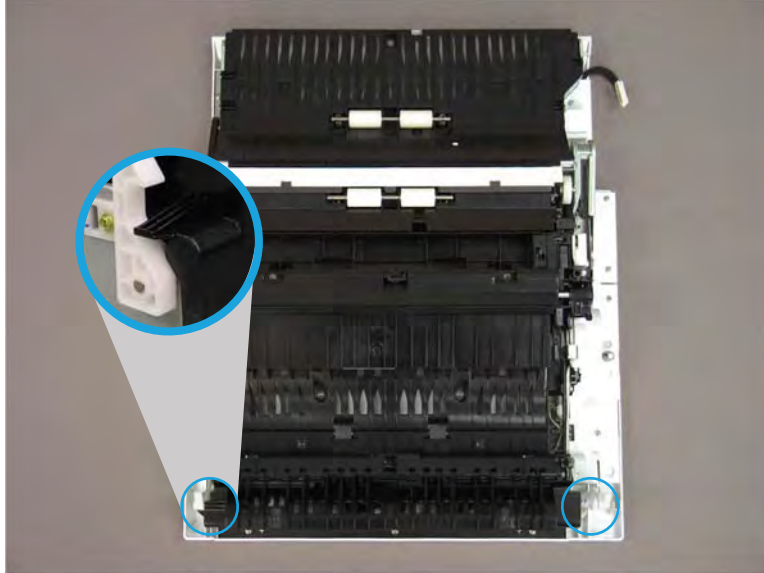
### Remove the fuser out sensor

Follow these steps to remove the fuser out sensor.

1. Remove two screws and two plastic guides. Lift up the right-door.



Figure 2-205 Lift right-door



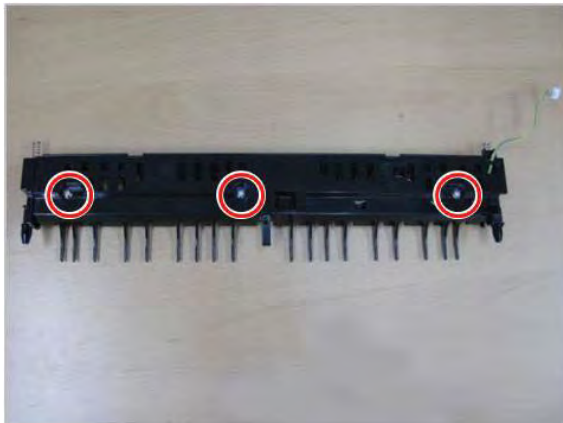
2. Disconnect the connector and remove the cable from the cable guide. Remove the right-door exit. Use caution as the springs are not retained.

Figure 2-206 Remove right-door exit




3. Remove three screws (plastic self-tapping), and then separate the right-door exit.

Figure 2-207 Remove screws and separate right-door exit



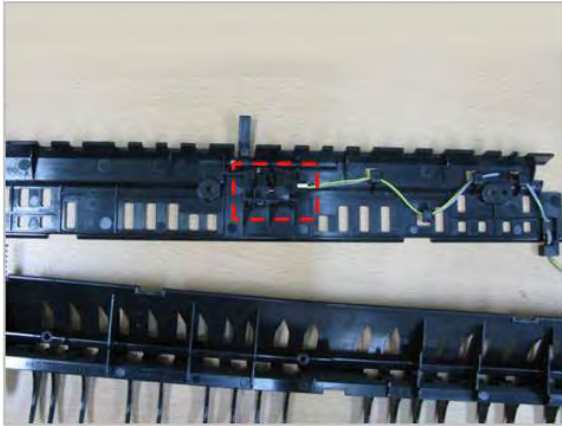
4. Disconnect the connector and remove the fuser-out sensor.

---

 **TIP:** When removing the sensor lift the flag, compress the bottom tabs and push from hole, and then rotate and release the top tabs.

---

**Figure 2-208** Disconnect connector and remove fuser-out sensor



## Unpack the replacement assembly

Follow these steps to unpack the replacement assembly.

1. Dispose of the defective part.

---



 **NOTE:** HP recommends responsible disposal of the defective part.

<http://www8.hp.com/us/en/hp-information/environment/product-recycling.html>


---

2. Unpack the replacement part from the packaging.

---

 **CAUTION:**  Some parts are sensitive to electrostatic discharge (ESD). Always perform service work at an ESD-protected workstation or mat. If an ESD workstation or mat is not available, touch the sheet-metal chassis to provide a static ground before touching an ESD-sensitive assembly. Protect the ESD-sensitive assemblies by placing them in ESD pouches when they are out of the printer.


 **IMPORTANT:** Make sure that all of the shipping materials (for example shipping tape) are removed from the replacement part prior to installation.

 **NOTE:** If the replacement part is a roller or pad, avoid touching the spongy part of it. Skin oils on the roller or pad can cause paper pickup and/or print-quality problems. HP recommends using disposable gloves when handling rollers or pads or washing your hands before touching rollers or pads.

---

3. To install an assembly, reverse the removal steps.

---

 **NOTE:** When applicable, special installation instructions are provided for an assembly at the end of the removal procedure. Always completely read the removal instructions and follow all special installation instructions.


---

## Removal and replacement: Duplex sensor and loop sensor

This document provides the procedures to remove the duplex sensor and loop sensor.


Mean time to repair: 5 minutes

Service level: Basic

 **IMPORTANT:** When applicable, special installation instructions are provided for an assembly at the end of the removal procedure. Always completely read the removal instructions and follow all special installation instructions.

### Before performing service

- Disconnect the power cable.

 **WARNING!** To avoid damage to the printer, turn the printer off, wait 30 seconds, and then remove the power cable before attempting to service the printer.

Use the table below to identify the correct part number for your printer. To order the part, go to [www.hp.com/buy/parts](http://www.hp.com/buy/parts)

Table 2-46 Part information

Part number	Part description
0604-001393	Duplex sensor
0604-001393	Loop sensor

### Required tools

- #2 JIS screwdriver with a magnetic tip

### After performing service

Turn the printer power on

- Connect the power cable.
- Use the power switch to turn the power on.

### Post service test

Copy, scan, or print a document. Verify the document copies, scans, or prints correctly.

## Remove the duplex sensor and loop sensor

Follow these steps to remove the duplex sensor and loop sensor.

1. Push down on transfer roller assembly at the front to release one tab. Move the transfer roller assembly slightly toward the back, and then release one tab. Rotate the transfer roller assembly outward to remove.

Figure 2-209 Remove transfer roller assembly



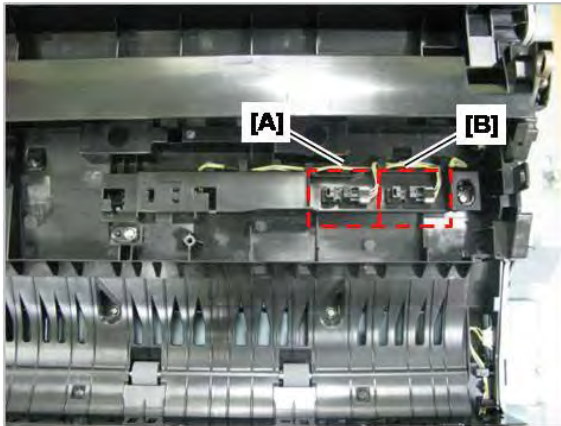
2. Remove one screw. Turn over the Guide-transfer roller Upper.

Figure 2-210 Remove screw and turn over guide-transfer roller upper



3. Remove the duplex sensor (A) and loop sensor (B). To remove the sensors, remove two screws, pinch the tabs and push to release the sensors. Use caution while handling the plastic snaps as they can become damaged when handled with force.

Figure 2-211 Remove duplex and loop sensors



## Unpack the replacement assembly

Follow these steps to unpack the replacement assembly.

1. Dispose of the defective part.




**NOTE:** HP recommends responsible disposal of the defective part.

<http://www8.hp.com/us/en/hp-information/environment/product-recycling.html>

2. Unpack the replacement part from the packaging.



**CAUTION:**  Some parts are sensitive to electrostatic discharge (ESD). Always perform service work at an ESD-protected workstation or mat. If an ESD workstation or mat is not available, touch the sheet-metal chassis to provide a static ground before touching an ESD-sensitive assembly. Protect the ESD-sensitive assemblies by placing them in ESD pouches when they are out of the printer.



**IMPORTANT:** Make sure that all of the shipping materials (for example shipping tape) are removed from the replacement part prior to installation.



**NOTE:** If the replacement part is a roller or pad, avoid touching the spongy part of it. Skin oils on the roller or pad can cause paper pickup and/or print-quality problems. HP recommends using disposable gloves when handling rollers or pads or washing your hands before touching rollers or pads.

3. To install an assembly, reverse the removal steps.



**NOTE:** When applicable, special installation instructions are provided for an assembly at the end of the removal procedure. Always completely read the removal instructions and follow all special installation instructions.

## Tray 1 registration drive

View the Tray 1 registration drive exploded view, parts list, and repair procedures.



## Tray 1 registration drive

Parts diagram and parts list for the Tray 1 registration drive.

Figure 2-212 Tray 1 registration drive

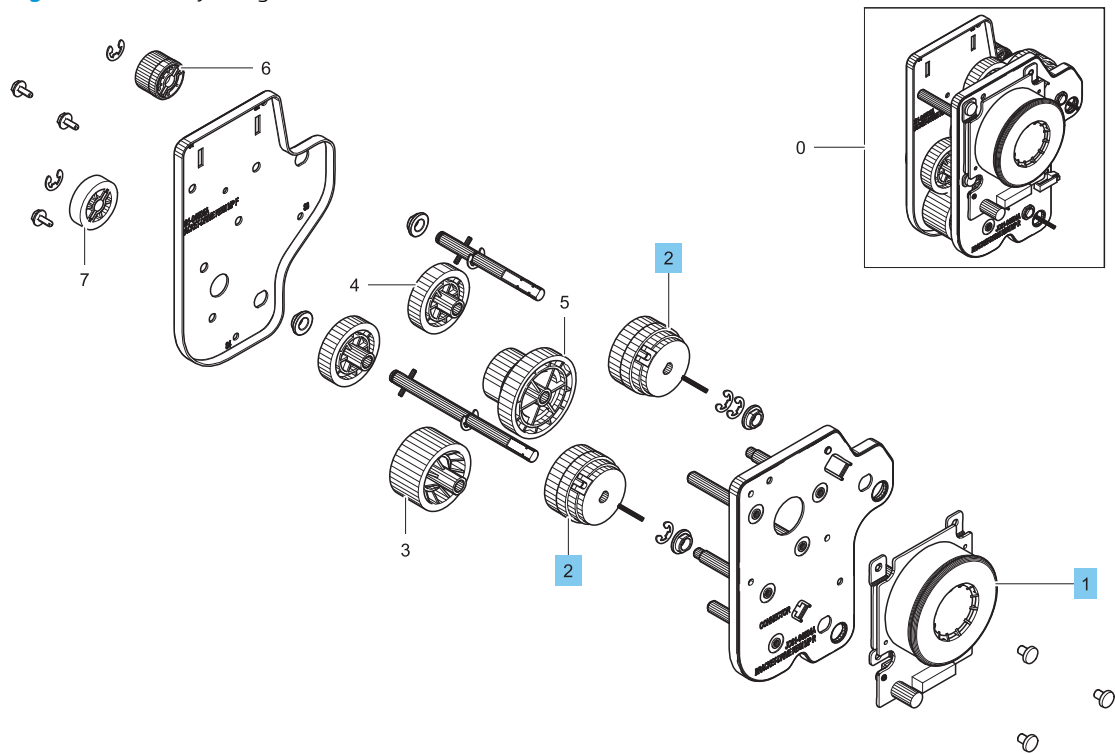




Table 2-47 Tray 1 registration drive

Ref				
No	Part number	Description	Qty	Repair procedure
1	JC31-00123B	Motor, bldc	1	Not applicable
2	JC47-00037A	Electric clutch	2	Not applicable

## Registration sub-frame

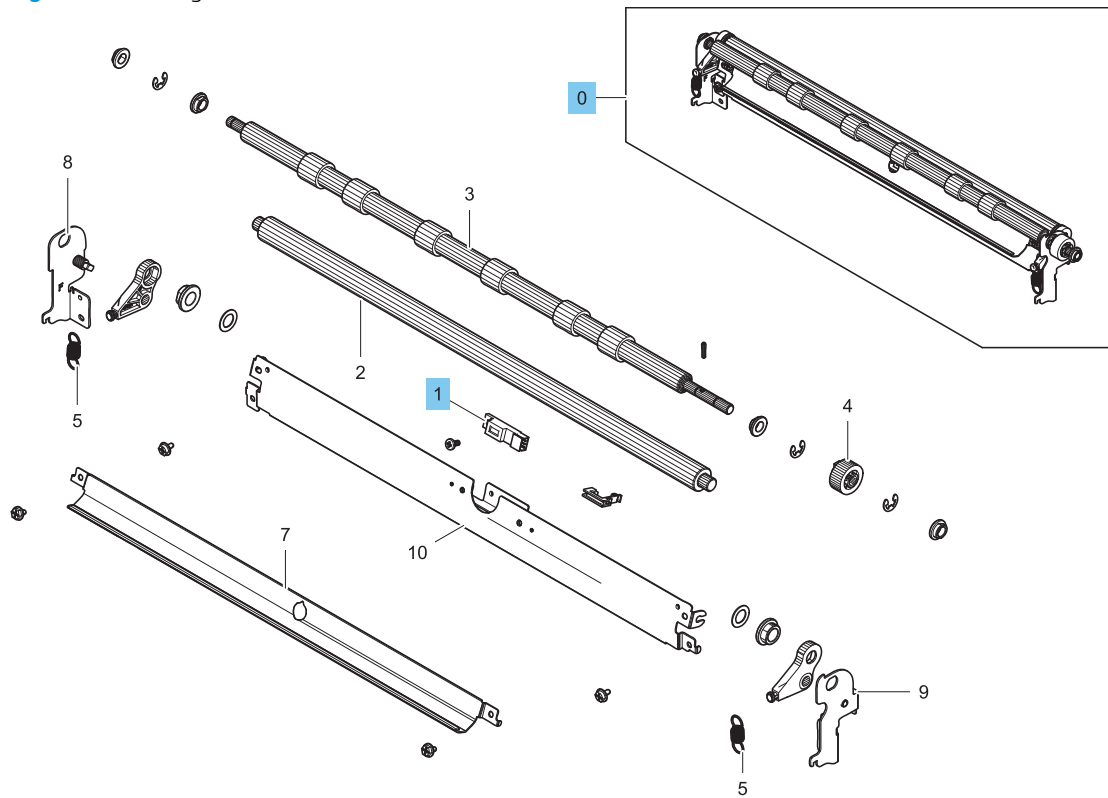
View the registration sub-frame exploded view, parts list, and repair procedures.



## Registration sub-frame

Parts diagram and parts list for the registration sub-frame.

Figure 2-213 Registration sub-frame



**Table 2-48 Registration sub-frame**

Ref				
No	Part number	Description	Qty	Repair procedure
0	JC93-00443A	Registration assembly	1	<a href="#">Removal and replacement: Registration assembly on page 357</a>
0	JC93-01371A	Registration assembly (For E77822, E77825, E77830)	1	<a href="#">Removal and replacement: Registration assembly on page 357</a>
0	8GS05-60130	Registration assembly (For E78323, E78325, E78330)	1	<a href="#">Removal and replacement: Registration assembly on page 357</a>
1	0604-001381	Photo interrupter	1	Not applicable


## Removal and replacement: Registration drive assembly

This document provides the procedures to remove the registration drive assembly.

 [View a video of removing the registration drive assembly.](#)

Mean time to repair: 20 minutes

Service level: Intermediate

 **IMPORTANT:** When applicable, special installation instructions are provided for an assembly at the end of the removal procedure. Always completely read the removal instructions and follow all special installation instructions.

### Before performing service

- Disconnect the power cable.

Use the table below to identify the correct part number for your printer. To order the part, go to [www.hp.com/buy/parts](http://www.hp.com/buy/parts)

**Table 2-49 Part information**

Part number	Part description
JC93-01371A	Registration drive assembly (For E77822, E77825, E77830)
8G505-60130	Registration drive assembly (For E78323, E78325, E78330)

### Required tools

- #2 JIS screwdriver with a magnetic tip

### After performing service

#### Turn the printer power on

- Connect the power cable.
- Use the power switch to turn the power on.

### Post service test

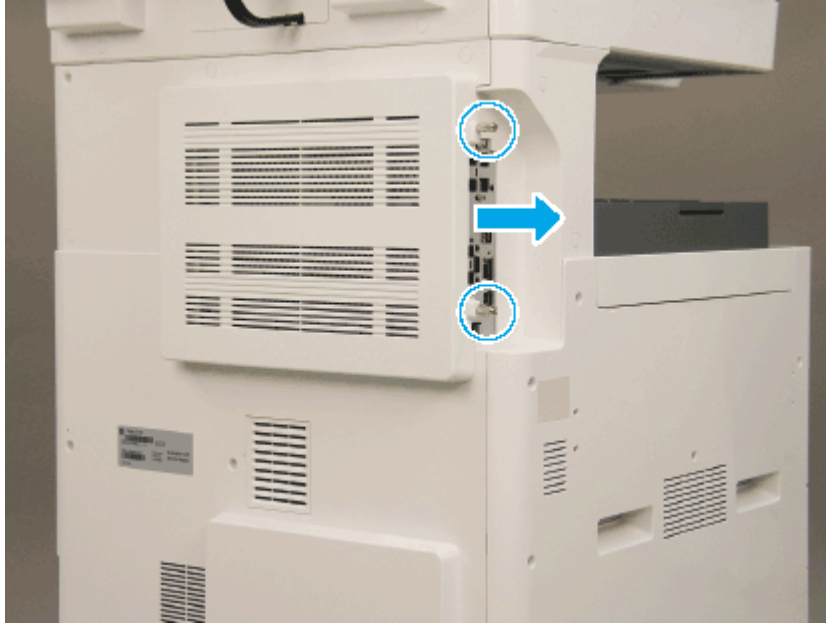
Copy, scan, or print a document. Verify the document copies, scans, or prints correctly.

### Remove the rear covers

Follow these steps to remove the rear covers.

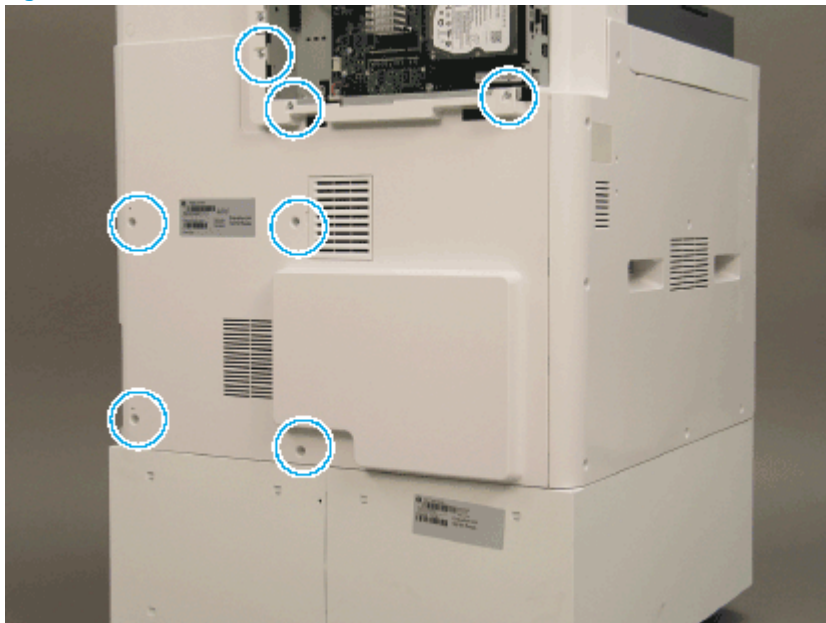
1. Unscrew two captive thumbscrews on the formatter cover. Slide the formatter cover to the left, and then to the right to remove.

Figure 2-214 Remove the formatter cover



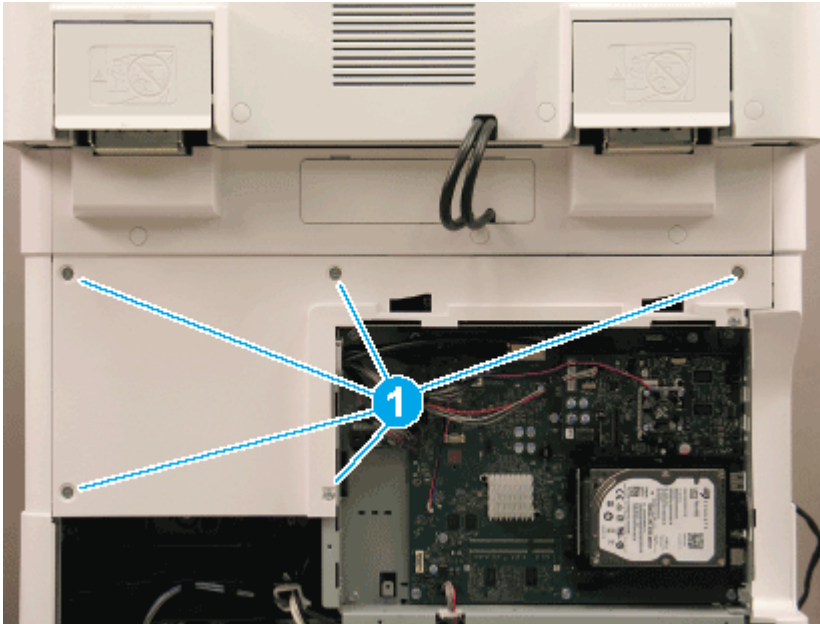
2. Remove seven screws, and then remove the rear-bottom cover.

Figure 2-215 Remove the rear-bottom cover



3. Remove six screws (callout 1), and then remove the rear-top cover.

Figure 2-216 Remove the rear-top cover



### Remove the registration drive assembly

Follow these steps to remove the registration drive unit.

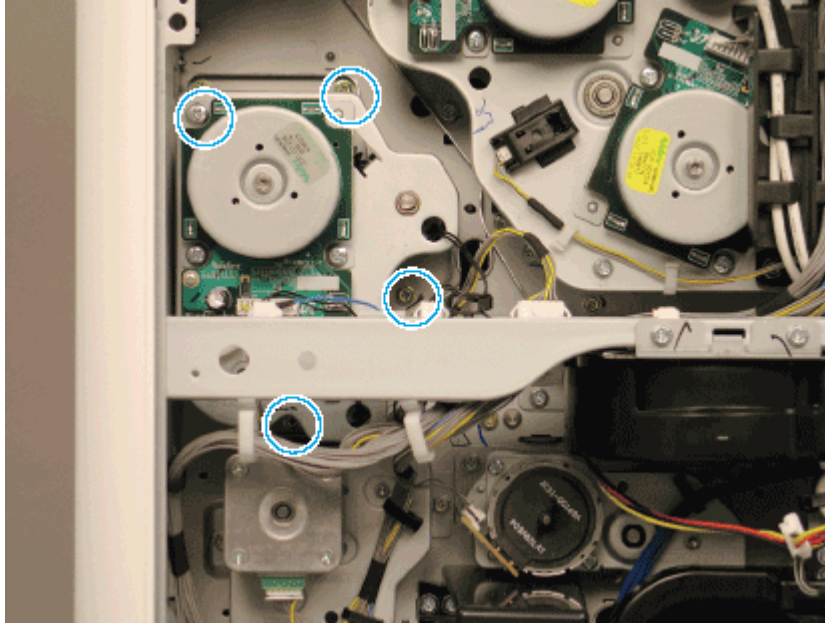
1. Disconnect three connectors, one at the motor and two at the frame.
2. Release the cables from the cable guides.




3. Remove four screws, and then remove the registration drive unit by lifting up and out at the top. Clear the white gear and the cable guide while removing.

 **IMPORTANT:** Remove and replace the screws in the order indicated on the chassis.

Figure 2-217 Remove the registration drive unit



 **NOTE:** Reinstall note: Reinstall the bottom of the unit first while clearing the white gear.

## Unpack the replacement assembly



Follow these steps to unpack the replacement assembly.


1. Dispose of the defective part.


 **NOTE:** HP recommends responsible disposal of the defective part.

<http://www8.hp.com/us/en/hp-information/environment/product-recycling.html>

2. Unpack the replacement part from the packaging.


 **CAUTION:**  Some parts are sensitive to electrostatic discharge (ESD). Always perform service work at an ESD-protected workstation or mat. If an ESD workstation or mat is not available, touch the sheet-metal chassis to provide a static ground before touching an ESD-sensitive assembly. Protect the ESD-sensitive assemblies by placing them in ESD pouches when they are out of the printer.

 **IMPORTANT:** Make sure that all of the shipping materials (for example shipping tape) are removed from the replacement part prior to installation.

 **NOTE:** If the replacement part is a roller or pad, avoid touching the spongy part of it. Skin oils on the roller or pad can cause paper pickup and/or print-quality problems. HP recommends using disposable gloves when handling rollers or pads or washing your hands before touching rollers or pads.

3. To install an assembly, reverse the removal steps.

---

 **NOTE:** When applicable, special installation instructions are provided for an assembly at the end of the removal procedure. Always completely read the removal instructions and follow all special installation instructions.

---

## Removal and replacement: Registration assembly


This document provides the procedures to remove the registration unit assembly.

 [View a video of removing and replacing the registration assembly.](#)

Mean time to repair: 15 minutes

Service level: Intermediate

---

 **IMPORTANT:** When applicable, special installation instructions are provided for an assembly at the end of the removal procedure. Always completely read the removal instructions and follow all special installation instructions.

---

### Before performing service

- Disconnect the power cable.

Use the table below to identify the correct part number for your printer. To order the part, go to [www.hp.com/buy/parts](http://www.hp.com/buy/parts)

**Table 2-50 Part information**

Part number	Part description
JC93-00443A	Registration unit assembly
JC93-01371A	Registration unit assembly (For E77822, E77825, E77830)
8GS05-60130	Registration unit assembly (For E78323, E78325, E78330)

### Required tools

- #2 JIS screwdriver with a magnetic tip

### After performing service

#### Turn the printer power on

- Connect the power cable.
- Use the power switch to turn the power on.

### Post service test

Copy, scan, or print a document. Verify the document copies, scans, or prints correctly.

## Remove the right door

Follow these steps to remove the right door.

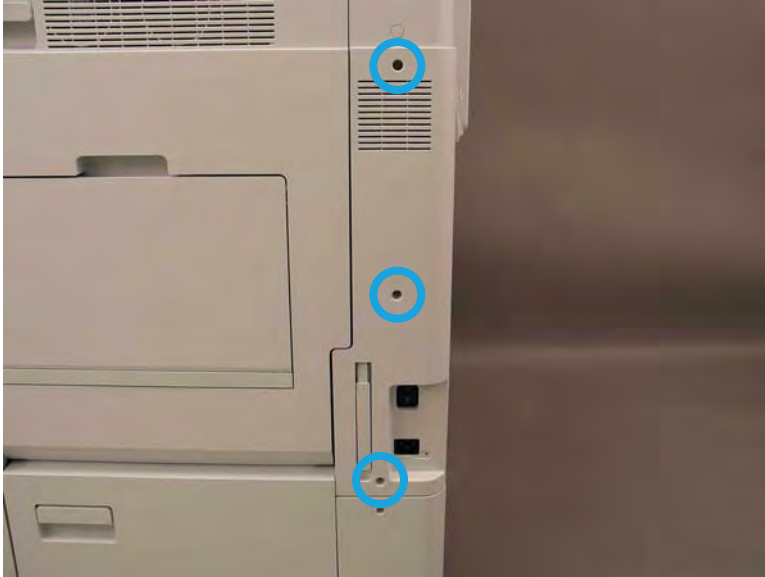
---

 **NOTE:** Remove second exit drive if installed.

---

1. Remove three screws, and then remove the cover (A).

Figure 2-218 Remove cover



2. Disconnect the right door connector.

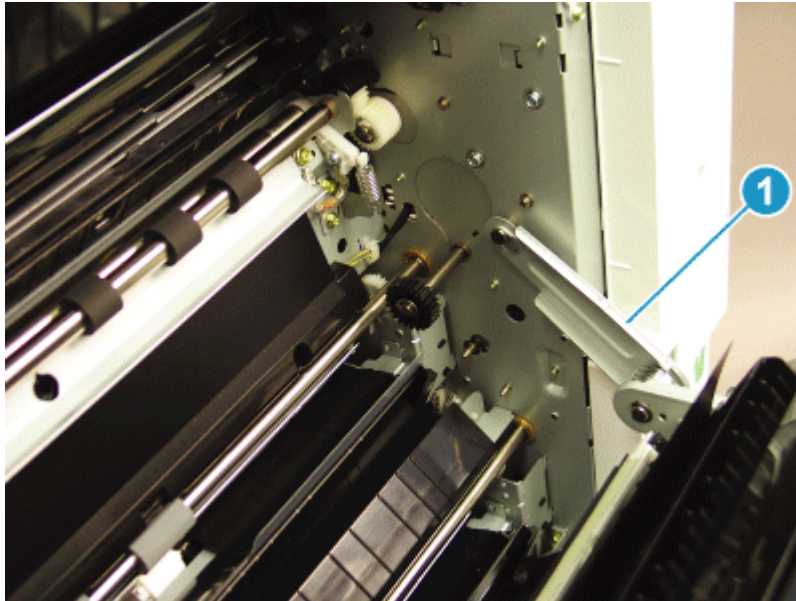
Figure 2-219 Disconnect right door connector



3. Release the right hinge (callout 1).

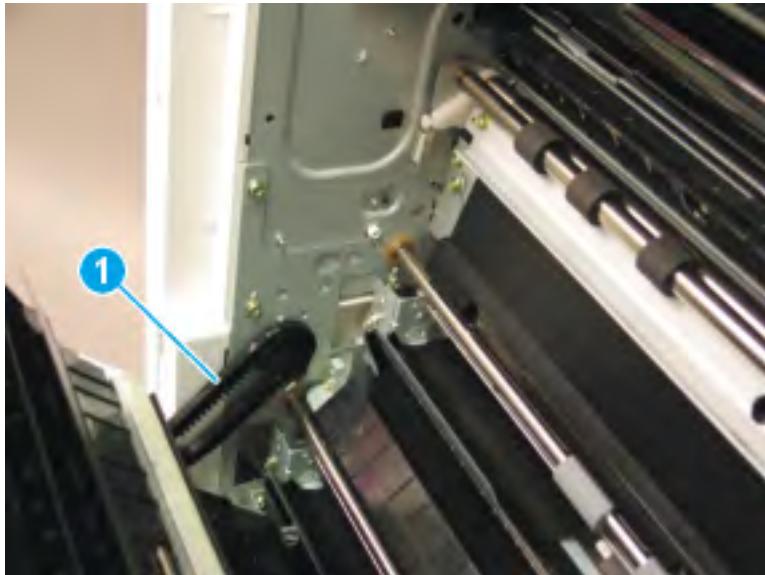
**⚠ CAUTION:** The right hinge spring tension can be dangerous. Use caution when releasing the right hinge to avoid injury.

Figure 2-220 Release right hinge




4. Release the left dampener (callout 1).

Figure 2-221 Release left dampener



5. Remove the right door.

 **NOTE:** Open the lower access door. If there is an HCI or 2x520 input device, release the dampener to clear the lower right door. Remove clockwise.

**Figure 2-222** Remove right door

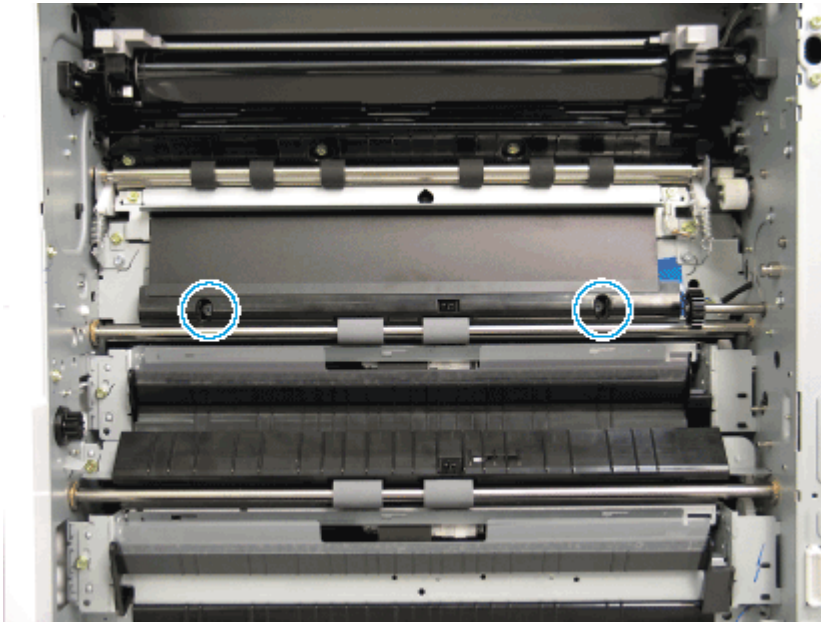


## Remove the registration unit

Follow these steps to remove the registration unit.


1. Remove two screws, and then remove the feed sensor cover.

**Figure 2-223** Remove the feed sensor cover



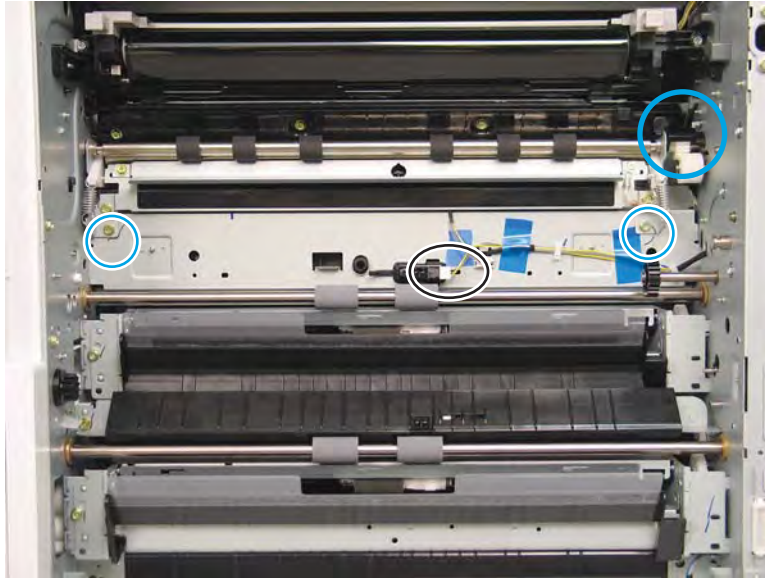
2. Do the following:
  1. Remove the black plastic bushing retainer at the rear of the assembly, disconnect one connector, and then remove two screws at the front and rear of the registration assembly.
  2. Release the front side of the registration assembly, and then release the back side to remove.

---

 **NOTE:** The bushings on the assembly are not captive and can be dislodged when handling the assembly.

---

Figure 2-224 Remove registration assembly;



## Unpack the replacement assembly

Follow these steps to unpack the replacement assembly.

1. Dispose of the defective part.



---

 **NOTE:** HP recommends responsible disposal of the defective part.


<http://www8.hp.com/us/en/hp-information/environment/product-recycling.html>

---

2. Unpack the replacement part from the packaging.

 **CAUTION:**  Some parts are sensitive to electrostatic discharge (ESD). Always perform service work at an ESD-protected workstation or mat. If an ESD workstation or mat is not available, touch the sheet-metal chassis to provide a static ground before touching an ESD-sensitive assembly. Protect the ESD-sensitive assemblies by placing them in ESD pouches when they are out of the printer.


 **IMPORTANT:** Make sure that all of the shipping materials (for example shipping tape) are removed from the replacement part prior to installation.

 **NOTE:** If the replacement part is a roller or pad, avoid touching the spongy part of it. Skin oils on the roller or pad can cause paper pickup and/or print-quality problems. HP recommends using disposable gloves when handling rollers or pads or washing your hands before touching rollers or pads.

---

3. To install an assembly, reverse the removal steps.

---

 **NOTE:** When applicable, special installation instructions are provided for an assembly at the end of the removal procedure. Always completely read the removal instructions and follow all special installation instructions.

---

## Main frame pickup

View the main frame pickup assemblies exploded view, parts list, and repair procedures.

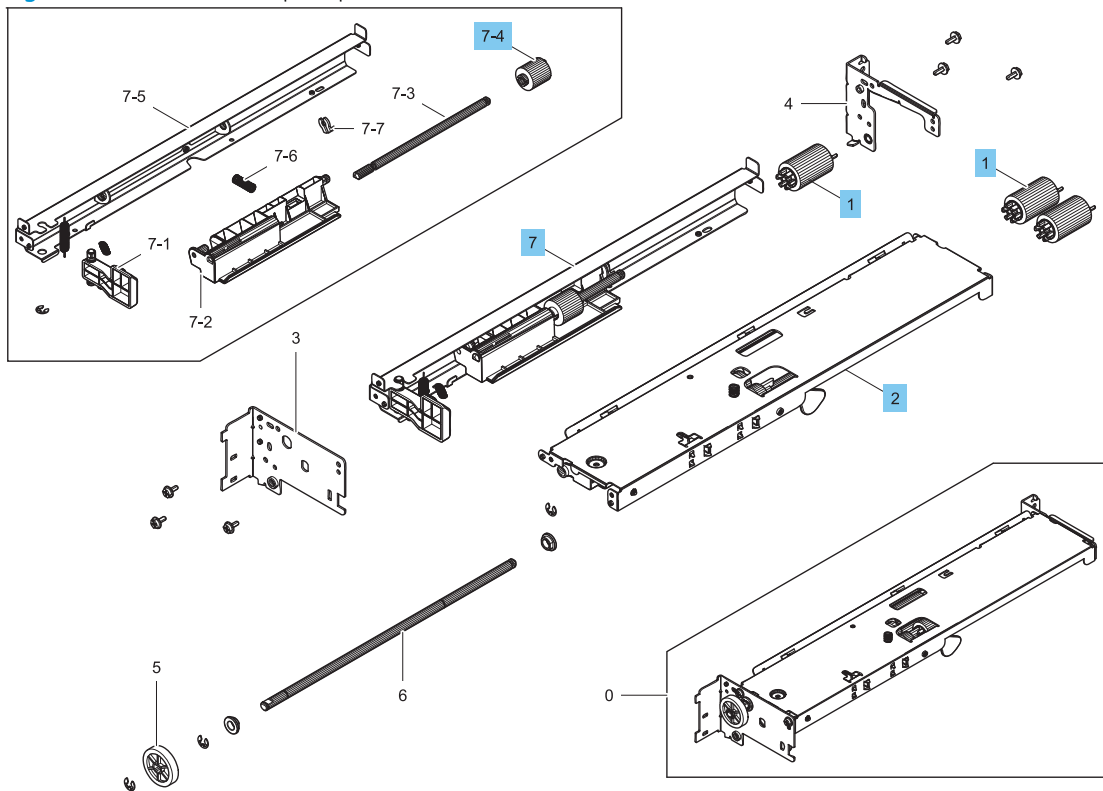




## Main frame pickup

Parts diagram and parts list for the main frame pickup.

Figure 2-225 Main frame pickup



**Table 2-51 Main frame pickup**


Ref				
No	Part number	Description	Qty	Repair procedure
0	JC93-00510A	Sub frame pickup	1	Not applicable
1	JC93-00540A	Trays 2-x rollers	3	<a href="#">Removal and replacement: Trays 2-x main rollers on page 366</a>
2	JC93-00504A	Main pickup, upper	1	<a href="#">Removal and replacement: Paper pickup assemblies and empty/level sensor on page 372</a>
7	JC93-00503A	Main pickup, lower	1	<a href="#">Removal and replacement: Paper pickup assemblies and empty/level sensor on page 372</a>
7-4	JC67-00455A	Coupler, torque limiter	1	Not applicable
Not shown	0604-001381	Photo interrupter (empty/level sensor)	1	<a href="#">Removal and replacement: Paper pickup assemblies and empty/level sensor on page 372</a>
Not shown	0604-001393	Photo interrupter (empty/level sensor) (For E78323, E78325, E78330)	1	<a href="#">Removal and replacement: Paper pickup assemblies and empty/level sensor on page 372</a>

## Removal and replacement: Trays 2-x main rollers

This document provides the procedures to remove the pickup/reverse/feed roller.

Mean time to repair: 6 minutes

Service level: Basic

 **IMPORTANT:** When applicable, special installation instructions are provided for an assembly at the end of the removal procedure. Always completely read the removal instructions and follow all special installation instructions.

### Before performing service

- Disconnect the power cable.

Use the table below to identify the correct part number for your printer. To order the part, go to [www.hp.com/buy/parts](http://www.hp.com/buy/parts)

**Table 2-52** Part information

Part number	Part description
JC93-00540A	Pickup/reverse/feed roller assembly

### Required tools

- #2 JIS screwdriver with a magnetic tip

### After performing service

#### Turn the printer power on

- Connect the power cable.
- Use the power switch to turn the power on.

### Post service test

Copy, scan, or print a document. Verify the document copies, scans, or prints correctly.

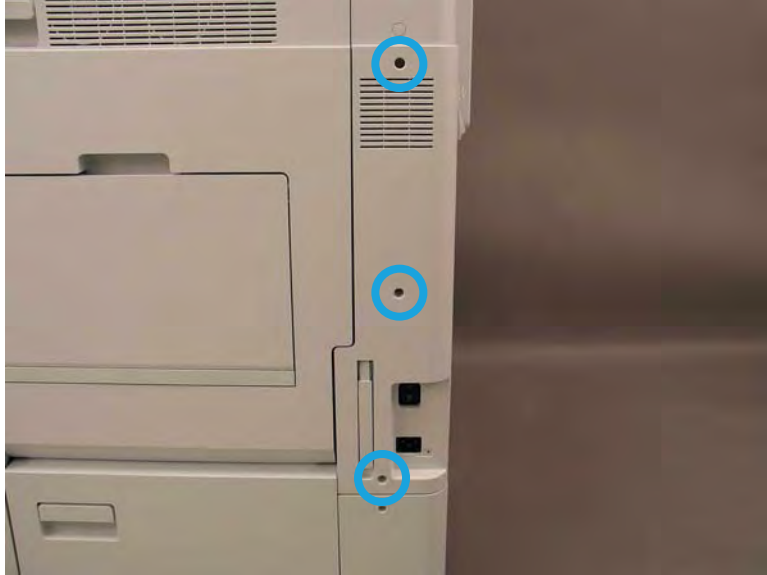
## Remove the right door

Follow these steps to remove the right door.

 **NOTE:** Remove second exit drive if installed.

1. Remove three screws, and then remove the cover (A).

Figure 2-226 Remove cover



2. Disconnect the right door connector.

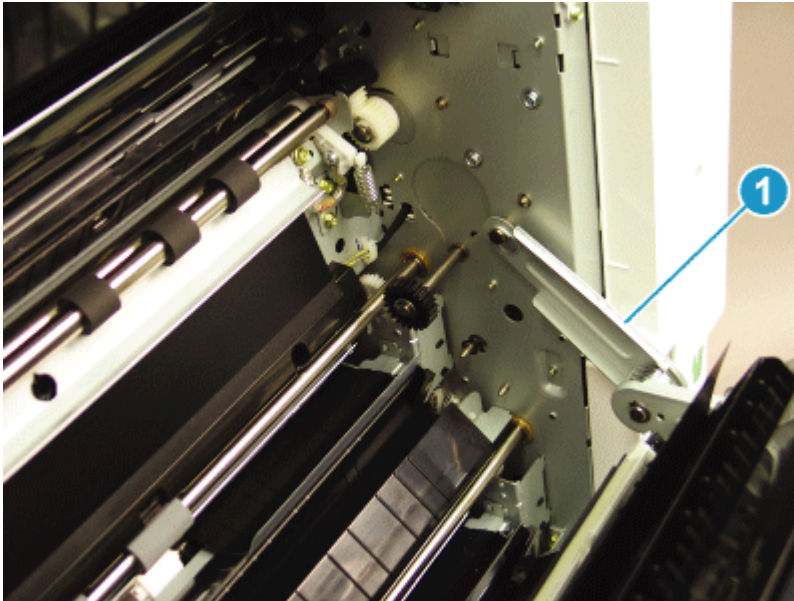
Figure 2-227 Disconnect right door connector



3. Release the right hinge (callout 1).

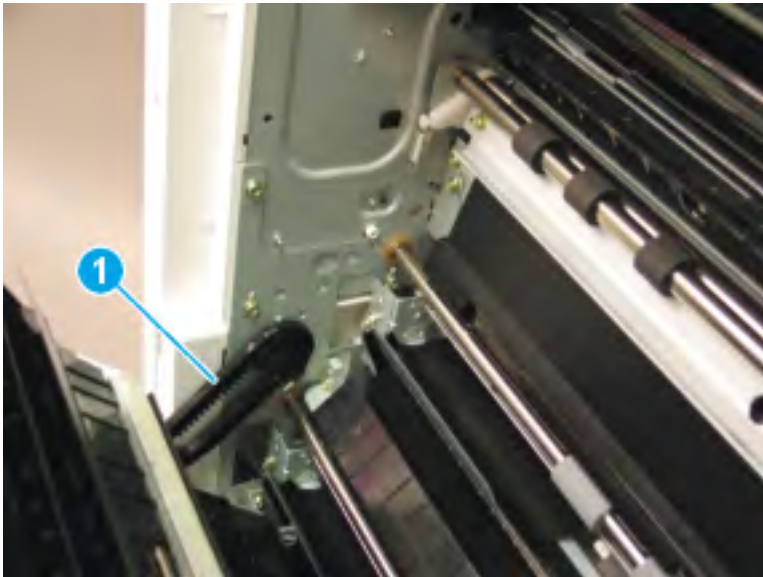
**⚠ CAUTION:** The right hinge spring tension can be dangerous. Use caution when releasing the right hinge to avoid injury.

Figure 2-228 Release right hinge



4. Release the left dampener (callout 1).

Figure 2-229 Release left dampener



5. Remove the right door.


 **NOTE:** Open the lower access door. If there is an HCI or 2x520 input device, release the dampener to clear the lower right door. Remove clockwise.

Figure 2-230 Remove right door

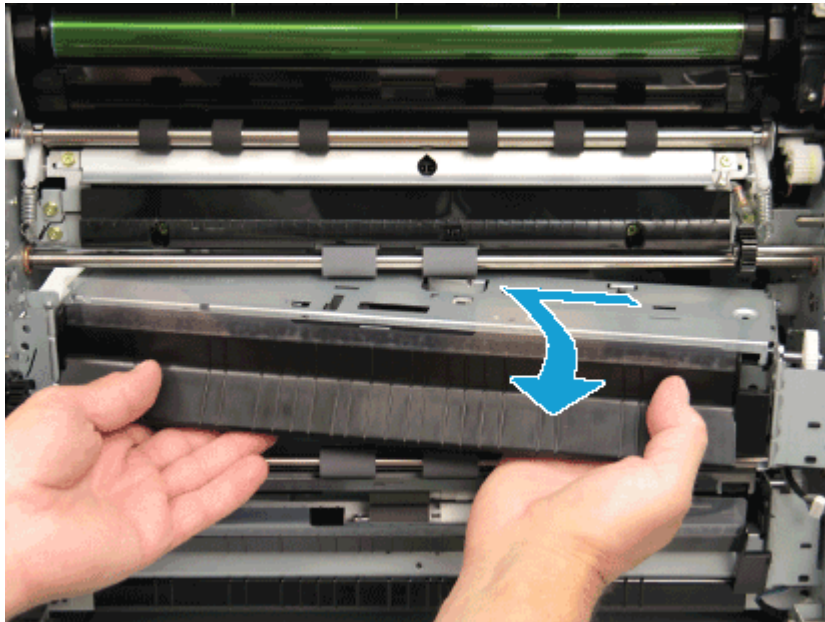


### Remove the pickup/feed/reverse roller

Follow these steps to remove the pickup/feed/reverse roller.

1. Remove one screw and disconnect one connector. Remove the pickup assembly.

Figure 2-231 Remove the pickup assembly



2. Release the small tab and remove the pickup/reverse/feed roller. Note the location of the clutches and gears.

Figure 2-232 Remove pickup/reverse/feed roller (1 of 2)

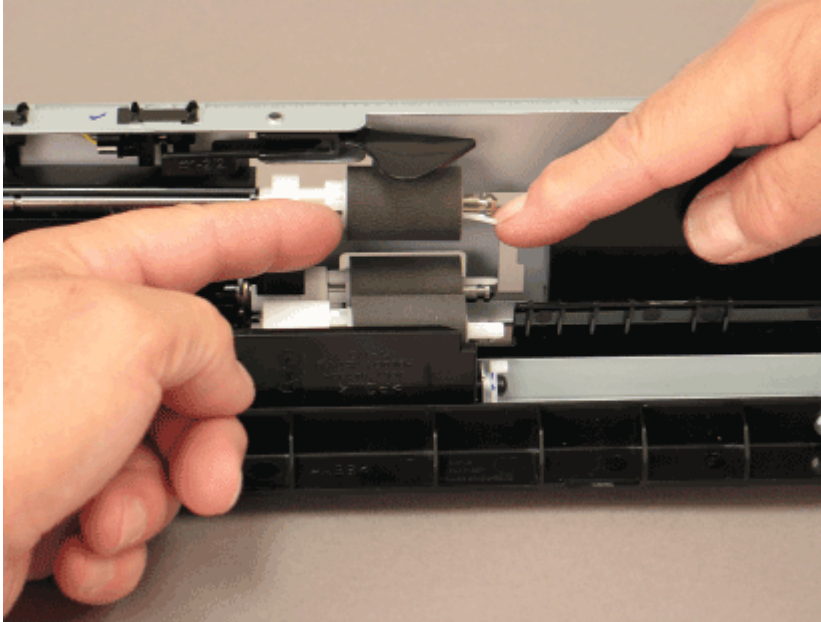
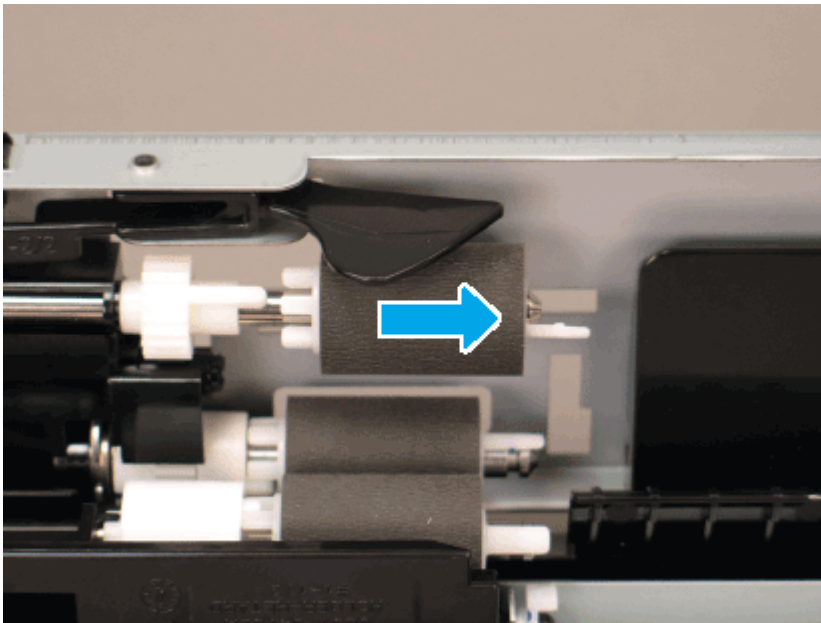


Figure 2-233 Remove pickup/reverse/feed roller (2 of 2)



 **NOTE:** It is recommended to replace all three rollers at the same time.

3. Enter service mode. Select the “Field Replacement Unit” menu item for the pickup/reverse/feed roller (Information > Supply Status > Field Replacement Unit). Select “Reset” to reset the current count to “0”.

### Unpack the replacement assembly

Follow these steps to unpack the replacement assembly.

1. Dispose of the defective part.





---

 **NOTE:** HP recommends responsible disposal of the defective part.


<http://www8.hp.com/us/en/hp-information/environment/product-recycling.html>

---

2. Unpack the replacement part from the packaging.


 **CAUTION:**  Some parts are sensitive to electrostatic discharge (ESD). Always perform service work at an ESD-protected workstation or mat. If an ESD workstation or mat is not available, touch the sheet-metal chassis to provide a static ground before touching an ESD-sensitive assembly. Protect the ESD-sensitive assemblies by placing them in ESD pouches when they are out of the printer.

 **IMPORTANT:** Make sure that all of the shipping materials (for example shipping tape) are removed from the replacement part prior to installation.

 **NOTE:** If the replacement part is a roller or pad, avoid touching the spongy part of it. Skin oils on the roller or pad can cause paper pickup and/or print-quality problems. HP recommends using disposable gloves when handling rollers or pads or washing your hands before touching rollers or pads.

---

3. To install an assembly, reverse the removal steps.

 **NOTE:** When applicable, special installation instructions are provided for an assembly at the end of the removal procedure. Always completely read the removal instructions and follow all special installation instructions.

---


## Removal and replacement: Paper pickup assemblies and empty/level sensor

This document provides the procedures to remove the paper pickup assemblies and empty/level sensor.

 [View a video of removing the paper pickup assemblies and empty/level sensor.](#)

Mean time to repair: 15 minutes

Service level: Intermediate

 **IMPORTANT:** When applicable, special installation instructions are provided for an assembly at the end of the removal procedure. Always completely read the removal instructions and follow all special installation instructions.

### Before performing service

- Disconnect the power cable.

Use the table below to identify the correct part number for your printer. To order the part, go to [www.hp.com/buy/parts](http://www.hp.com/buy/parts)

**Table 2-53 Part information**

Part number	Part description
JC93-00504A	Main Pick Up Upper
JC93-00503A	Main Pick Up Lower
0604-001381	Photo interrupter
0604-001393	Photo interrupter (E783xx series)

### Required tools

- #2 JIS screwdriver with a magnetic tip

### After performing service

#### Turn the printer power on

- Connect the power cable.
- Use the power switch to turn the power on.

### Post service test

Copy, scan, or print a document. Verify the document copies, scans, or prints correctly.

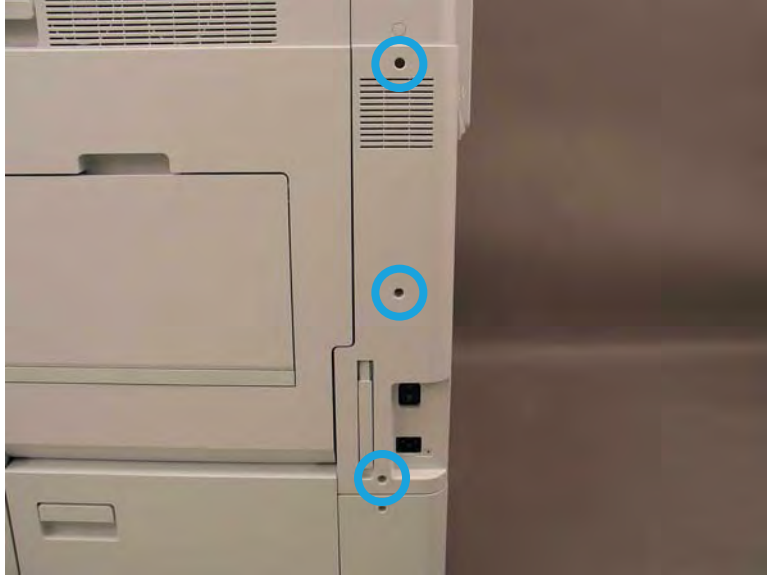
### Remove the right door

Follow these steps to remove the right door.

 **NOTE:** Remove second exit drive if installed.

1. Remove three screws, and then remove the cover (A).

Figure 2-234 Remove cover



2. Disconnect the right door connector.

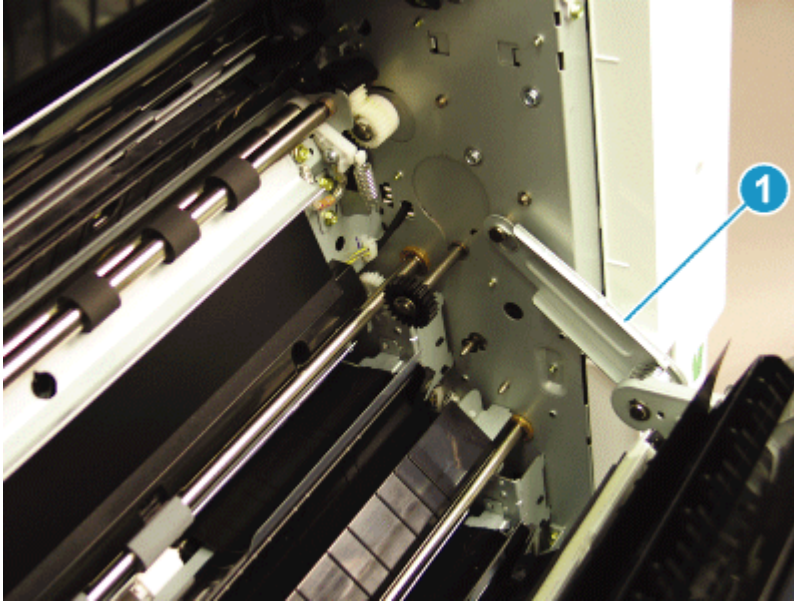
Figure 2-235 Disconnect right door connector



3. Release the right hinge (callout 1).

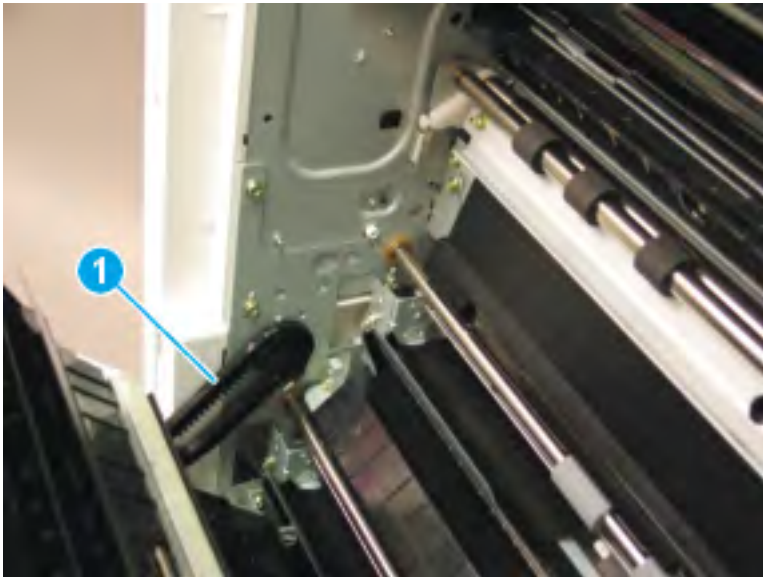
**⚠ CAUTION:** The right hinge spring tension can be dangerous. Use caution when releasing the right hinge to avoid injury.

Figure 2-236 Release right hinge




4. Release the left dampener (callout 1).

Figure 2-237 Release left dampener



5. Remove the right door.

 **NOTE:** Open the lower access door. If there is an HCI or 2x520 input device, release the dampener to clear the lower right door. Remove clockwise.

**Figure 2-238** Remove right door



### Remove the paper trays

Follow these steps to remove the paper trays.

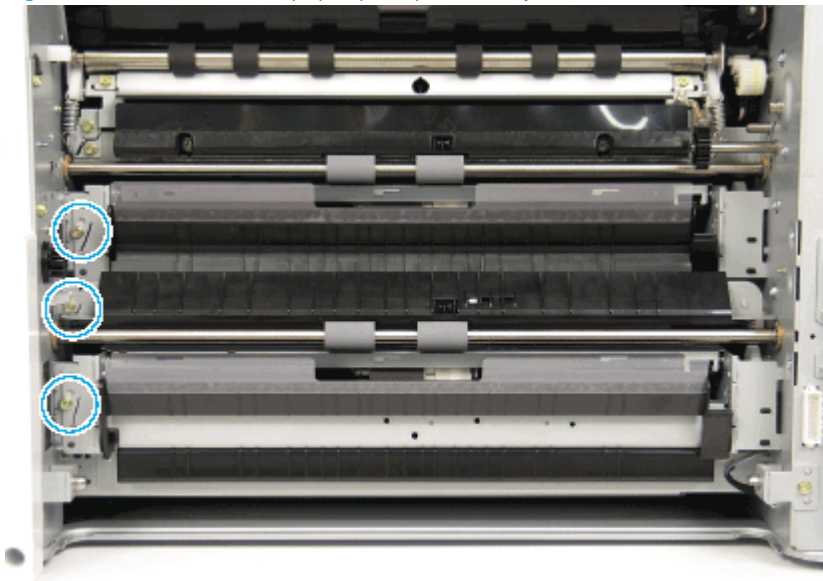
- ▲ Remove the paper trays.

### Remove the paper pickup unit

Follow these steps to remove the paper pickup unit.

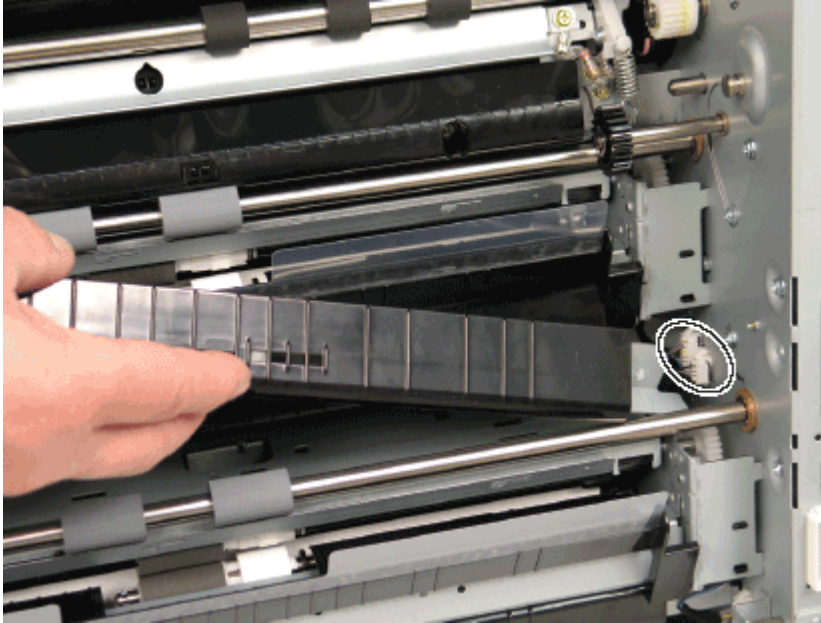
1. Remove one screw and one connector for each paper pickup assembly.

**Figure 2-239** Remove the paper pickup assembly screw(s)



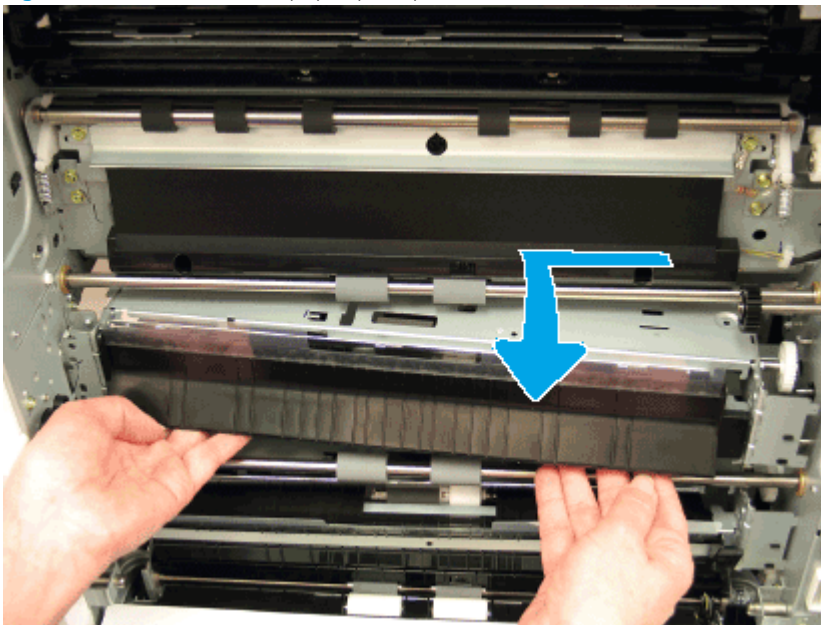
Before removing the Tray 2 paper pickup assembly, remove one screw and disconnect one connector, and then remove the feed sensor bar.

Figure 2-240 Remove the feed sensor bar



2. Remove the paper pickup assemblies.

Figure 2-241 Remove the paper pickup assemblies

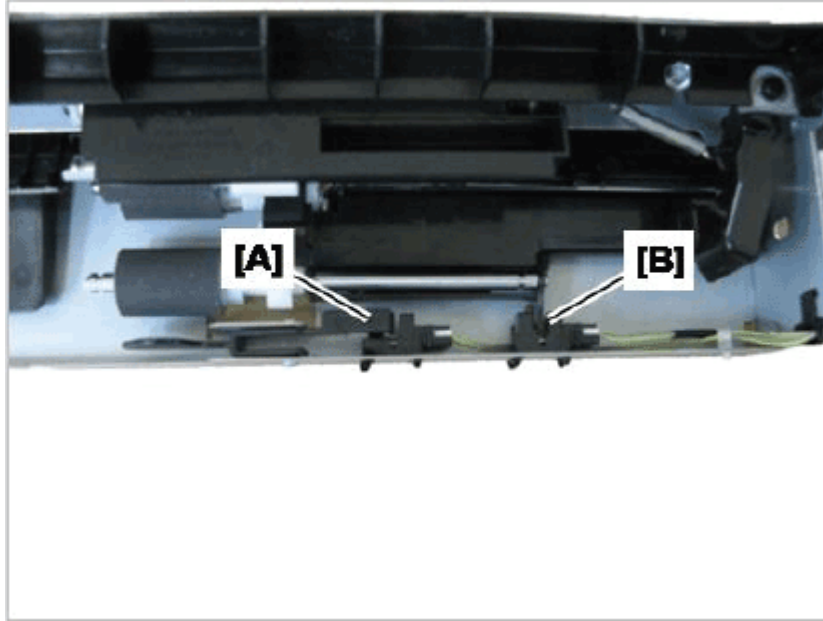


### Remove the empty and level sensors

Follow these steps to remove the empty and level sensors.

1. Release the sensor after disconnecting the connector. (Empty sensor [A], level sensor [B]).

Figure 2-242 Release the empty and level sensor



2. Remove one screw and disconnect one sensor, and then remove the sensor assembly.

## Unpack the replacement assembly

Follow these steps to unpack the replacement assembly.

1. Dispose of the defective part.

---



 **NOTE:** HP recommends responsible disposal of the defective part.


<http://www8.hp.com/us/en/hp-information/environment/product-recycling.html>


---

2. Unpack the replacement part from the packaging.

---

 **CAUTION:**  Some parts are sensitive to electrostatic discharge (ESD). Always perform service work at an ESD-protected workstation or mat. If an ESD workstation or mat is not available, touch the sheet-metal chassis to provide a static ground before touching an ESD-sensitive assembly. Protect the ESD-sensitive assemblies by placing them in ESD pouches when they are out of the printer.


 **IMPORTANT:** Make sure that all of the shipping materials (for example shipping tape) are removed from the replacement part prior to installation.

 **NOTE:** If the replacement part is a roller or pad, avoid touching the spongy part of it. Skin oils on the roller or pad can cause paper pickup and/or print-quality problems. HP recommends using disposable gloves when handling rollers or pads or washing your hands before touching rollers or pads.

---

3. To install an assembly, reverse the removal steps.

---

 **NOTE:** When applicable, special installation instructions are provided for an assembly at the end of the removal procedure. Always completely read the removal instructions and follow all special installation instructions.

---

## Main frame pickup upper

View the main frame pickup upper exploded view, parts list, and repair procedures.

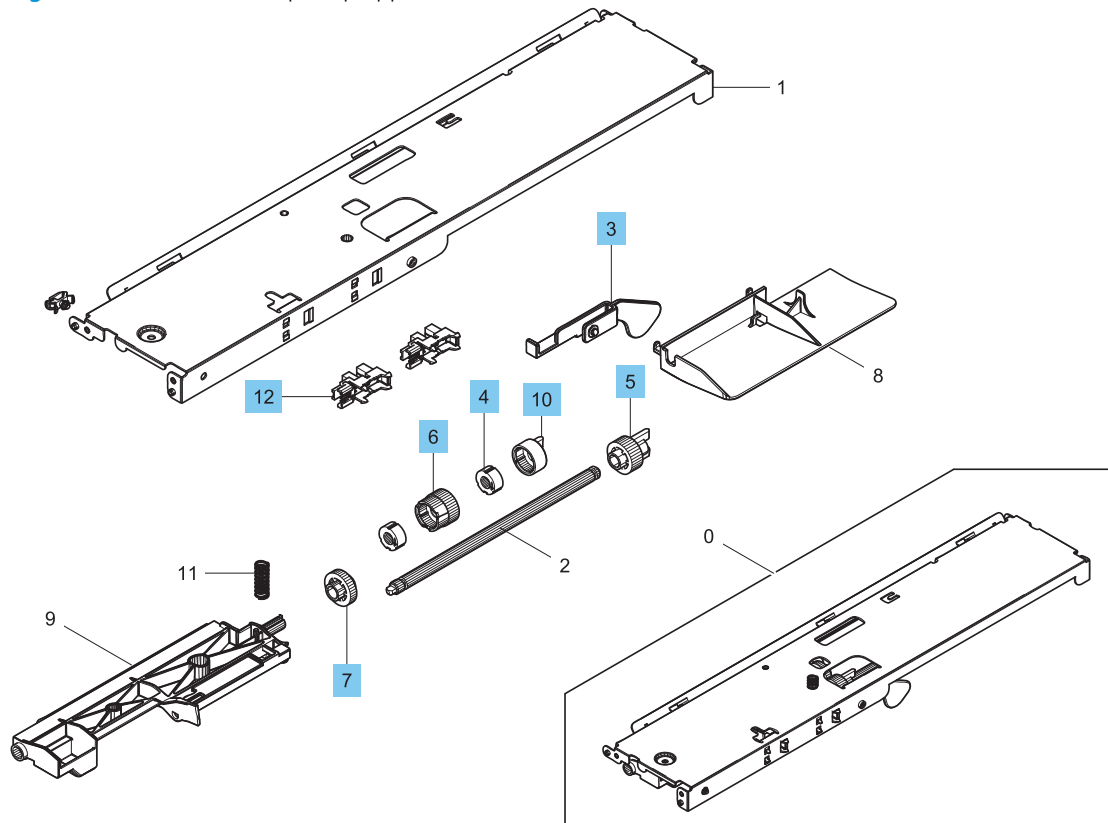




## Main frame pickup upper

Parts diagram and parts list for the main frame pickup upper.

Figure 2-243 Main frame pickup upper



**Table 2-54 Main frame pickup upper**

Ref				
No	Part number	Description	Qty	Repair procedure
3	JC66-03199A	Actuator, empty pickup	1	Not applicable
4	JC66-00977A	Clutch one way	1	Not applicable
5	JC66-00943A	Gear-m, joint	1	Not applicable
6	JC66-00941A	Gear-m, one way	1	Not applicable
7	JC66-00940A	Gear-m, idle	1	Not applicable
10	JC61-01288A	Holder-m, idle one way	1	Not applicable
12	0604-001393	Photo interrupter	2	Not applicable

## Main frame

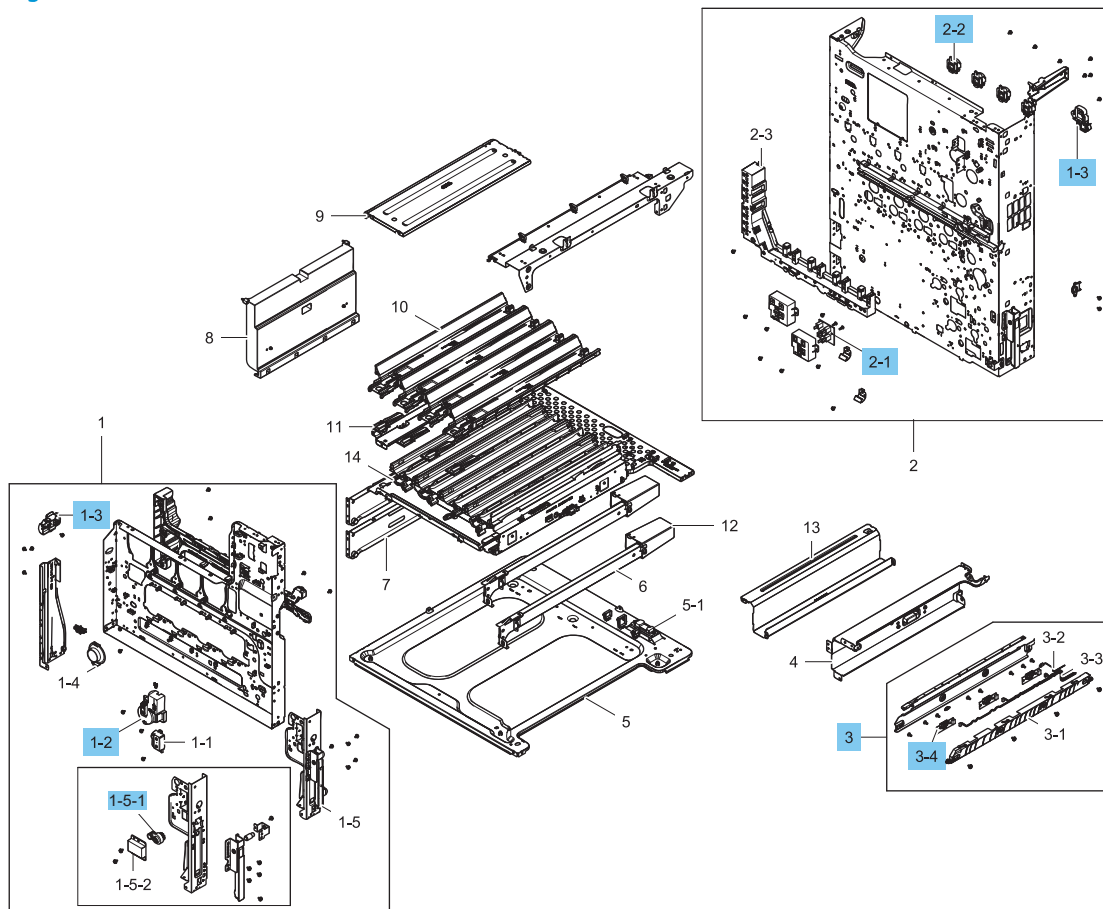
View the main frame exploded view, parts list, and repair procedures.



## Main frame

Parts diagram and parts list for the main frame.

Figure 2-244 Main frame



**Table 2-55 Main frame**

Ref				
No	Part number	Description	Qty	Repair procedure
1-2	JC93-00894A	ACR shutter drive	1	<a href="#">Removal and replacement: ACR shutter motor on page 386</a>
1-3	JC93-00466A	Front Door Switch Open	2	Not applicable
2-1	JC92-02622C	PCA Paper Size Sensor	2	<a href="#">Removal and replacement: Paper size sensor PCA on page 429</a>
2-2	JC92-02164A	PCA, toner e-label joining	4	Not applicable
3	JC93-00894A	Automatic Color Registration (ACR)	1	<a href="#">Removal and replacement: ACR shutter motor on page 386</a>
3	JC93-00895A	Automatic Color Registration (ACR) (For E77822, E77825, E77830)	1	<a href="#">Removal and replacement: ACR shutter motor on page 386</a>
3	JC93-01803A	Automatic Color Registration (ACR) (For E78323, E78325, E78330)	1	<a href="#">Removal and replacement: ACR shutter motor on page 386</a>
3-4	JC32-00014A	CTD sensor	3	Not applicable
1-5-1	5CM76-67901	Right door damper and lever kit	1	<a href="#">Removal and replacement: Right door dampener and lever kit on page 397</a>
Not shown	0604-001393	Photo interrupter (For E78323, E78325, E78330)	1	Not applicable
Not shown	JC61-04784A	Guide - Toner Cartridge (For E77822, E77825, E77830)	1	Not applicable
Not shown	5QJ83-40030	Guide - Toner Cartridge (For E78323, E78325, E78330)	1	Not applicable
Not shown	JC93-00492A	TCU presence photo sensor	1	<a href="#">Removal and replacement: TCU presence photo sensor on page 427</a>
Not shown	JC93-00494A	High-voltage rail assembly	1	<a href="#">Removal and replacement: High-voltage rail assembly on page 402</a>

## Removal and replacement: ACR shutter motor


This document provides the procedures to remove the ACR shutter motor.

 [View a video of removing the ACR shutter motor.](#)

Mean time to repair: 35 minutes

Service level: Advanced

---

 **IMPORTANT:** When applicable, special installation instructions are provided for an assembly at the end of the removal procedure. Always completely read the removal instructions and follow all special installation instructions.

---

### Before performing service

- Disconnect the power cable.

Use the table below to identify the correct part number for your printer. To order the part, go to [www.hp.com/buy/parts](http://www.hp.com/buy/parts)

**Table 2-56 Part information**

Part number	Part description
JC93-00894A	ACR shutter motor

### Required tools

- #2 JIS screwdriver with a magnetic tip

### After performing service

#### Turn the printer power on

- Connect the power cable.
- Use the power switch to turn the power on.

### Post service test

Copy, scan, or print a document. Verify the document copies, scans, or prints correctly.

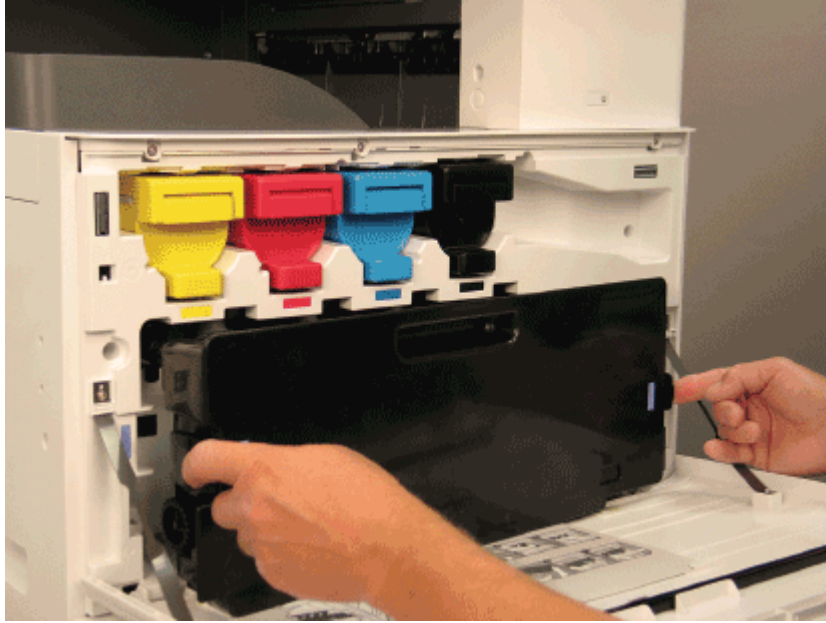
## Remove the toner cartridges and TCU

Follow these steps to remove the toner cartridges and TCU.

- ▲ Open the front door and remove the toner collection unit and toner cartridges.



Figure 2-245 Remove the TCU



### Remove the front inner cover

Follow these steps to remove the front inner cover.

- ▲ Remove seven screws, and then remove the front inner cover.


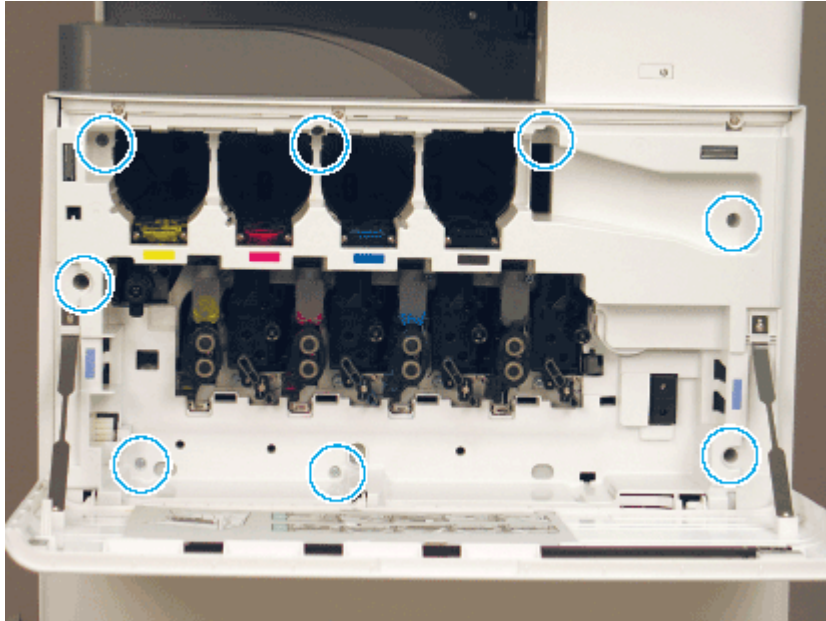
 **NOTE:** The TCU cleaning blade must be removed to remove the front inner cover.

Figure 2-246 Remove the front inner cover




## Removal and replacement: High-voltage power supply (HVPS) board

This document provides the procedures to remove the High-Voltage Power Supply (HVPS) board.

 [View a video of removing the High-voltage power supply \(HVPS\) board.](#)


Mean time to repair: 20 minutes

Service level: Intermediate

 **IMPORTANT:** When applicable, special installation instructions are provided for an assembly at the end of the removal procedure. Always completely read the removal instructions and follow all special installation instructions.

### Before performing service

- Disconnect the power cable.

 **WARNING!** To avoid damage to the printer, turn the printer off, wait 30 seconds, and then remove the power cable before attempting to service the printer.

Use the table below to identify the correct part number for your printer. To order the part, go to [www.hp.com/buy/parts](http://www.hp.com/buy/parts)

**Table 2-57 Part information**

Part number	Part description
JC44-00212C	High-Voltage Power Supply (HVPS) board (E778xx Series)
JC44-00212D	High-Voltage Power Supply (HVPS) board (E783xx Series)

### Required tools

- #2 JIS screwdriver with a magnetic tip

### After performing service

#### Turn the printer power on

- Connect the power cable.
- Use the power switch to turn the power on.

### Post service test

Copy, scan, or print a document. Verify the document copies, scans, or prints correctly.

### Remove the left cover

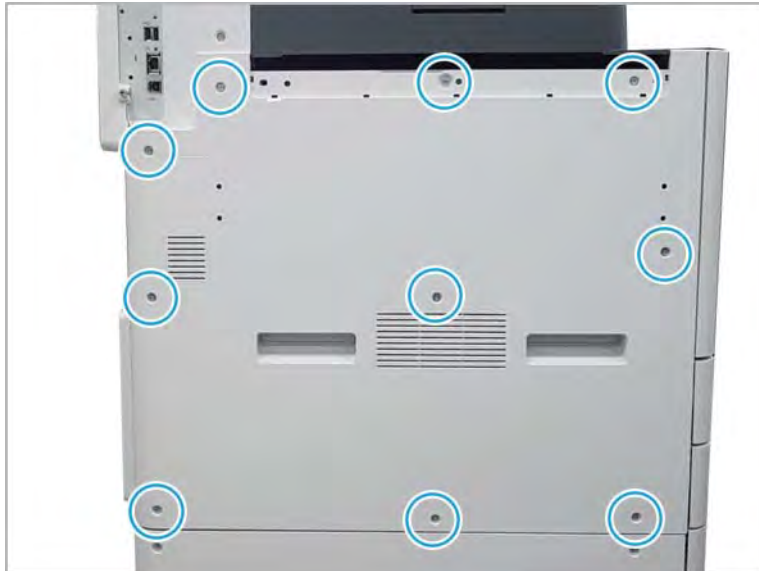
Follow these steps to remove the left cover.

- ▲ Remove the left trim cover, and then remove ten screws to remove the left cover.

Figure 2-247 Remove the left trim cover



Figure 2-248 Remove the left cover

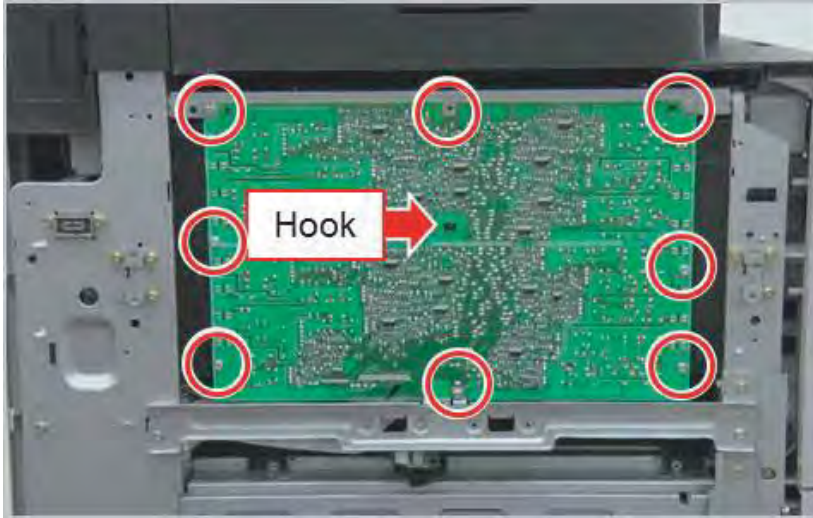


### Remove the high-voltage power supply (HVPS)

Follow these steps to remove the high-voltage power supply (HVPS).

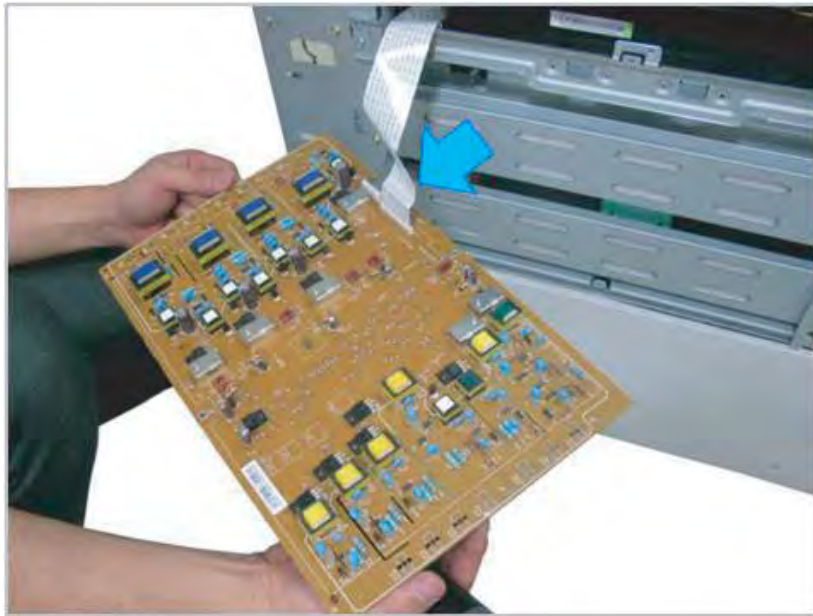
1. Remove eight screws, and then release middle hook.

Figure 2-249 Remove screws



2. Unplug the connector and then remove the HVPS.

Figure 2-250 Remove the HVPS board



### Unpack the replacement assembly

Follow these steps to unpack the replacement assembly.

1. Dispose of the defective part.



---

 **NOTE:** HP recommends responsible disposal of the defective part.


<http://www8.hp.com/us/en/hp-information/environment/product-recycling.html>

---

2. Unpack the replacement part from the packaging.


 **CAUTION:**  Some parts are sensitive to electrostatic discharge (ESD). Always perform service work at an ESD-protected workstation or mat. If an ESD workstation or mat is not available, touch the sheet-metal chassis to provide a static ground before touching an ESD-sensitive assembly. Protect the ESD-sensitive assemblies by placing them in ESD pouches when they are out of the printer.

 **IMPORTANT:** Make sure that all of the shipping materials (for example shipping tape) are removed from the replacement part prior to installation.

 **NOTE:** If the replacement part is a roller or pad, avoid touching the spongy part of it. Skin oils on the roller or pad can cause paper pickup and/or print-quality problems. HP recommends using disposable gloves when handling rollers or pads or washing your hands before touching rollers or pads.

---

3. To install an assembly, reverse the removal steps.

 **NOTE:** When applicable, special installation instructions are provided for an assembly at the end of the removal procedure. Always completely read the removal instructions and follow all special installation instructions.


---

## Removal and replacement: Laser scanner assembly

This document provides the procedures to remove the laser scanner assembly.


Mean time to repair: 10 minutes

Service level: Basic

 **IMPORTANT:** When applicable, special installation instructions are provided for an assembly at the end of the removal procedure. Always completely read the removal instructions and follow all special installation instructions.

### Before performing service

- Disconnect the power cable.

 **WARNING!** To avoid damage to the printer, turn the printer off, wait 30 seconds, and then remove the power cable before attempting to service the printer.

Use the table below to identify the correct part number for your printer. To order the part, go to [www.hp.com/buy/parts](http://www.hp.com/buy/parts)

Table 2-58 Part information

Part number	Part description
JC97-04864A	Laser scanner assembly

### Required tools

- #2 JIS screwdriver with a magnetic tip

### After performing service

#### Turn the printer power on

- Connect the power cable.
- Use the power switch to turn the power on.

### Post service test

Copy, scan, or print a document. Verify the document copies, scans, or prints correctly.

### Remove the left cover

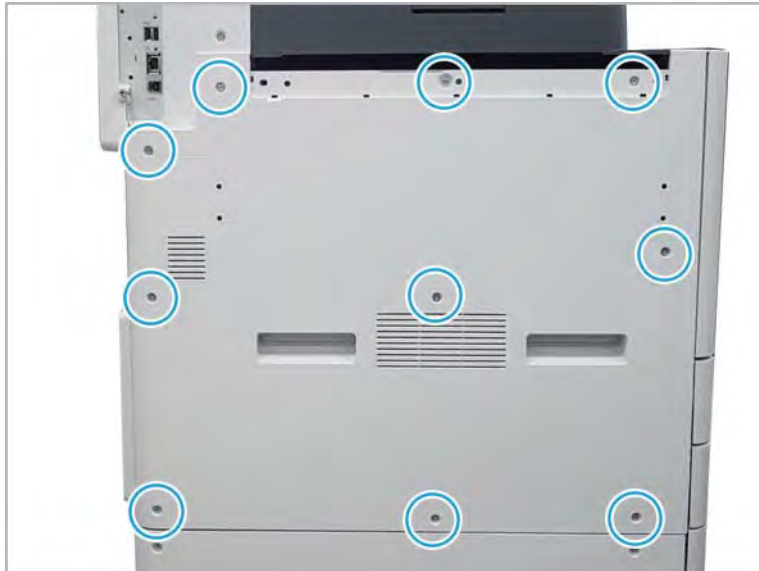
Follow these steps to remove the left cover.

- ▲ Remove the left trim cover, and then remove ten screws to remove the left cover.

Figure 2-251 Remove the left trim cover



Figure 2-252 Remove the left cover

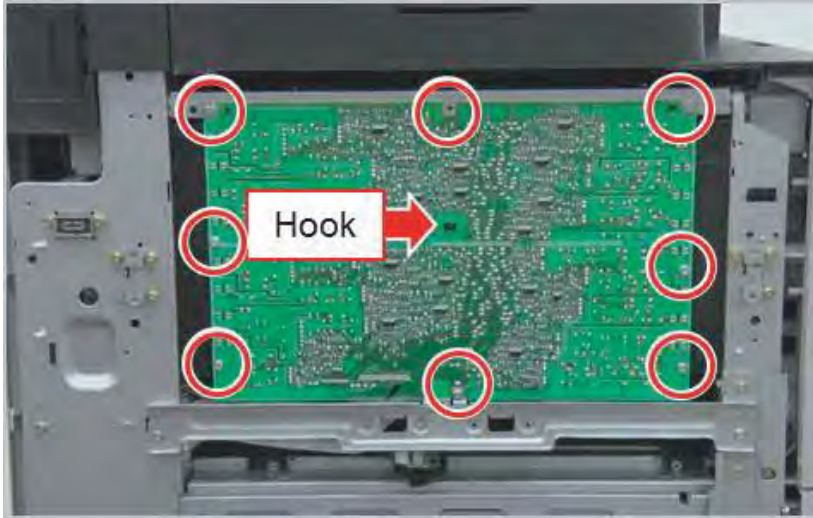


### Remove the high-voltage power supply (HVPS)

Follow these steps to remove the high-voltage power supply (HVPS).

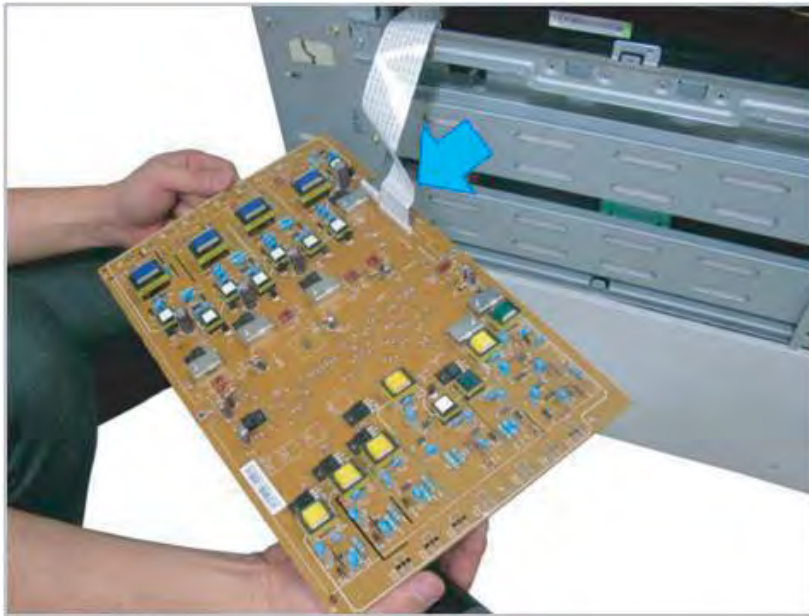
1. Remove eight screws, and then release middle hook.

Figure 2-253 Remove screws



2. Unplug the connector and then remove the HVPS.

Figure 2-254 Remove the HVPS board



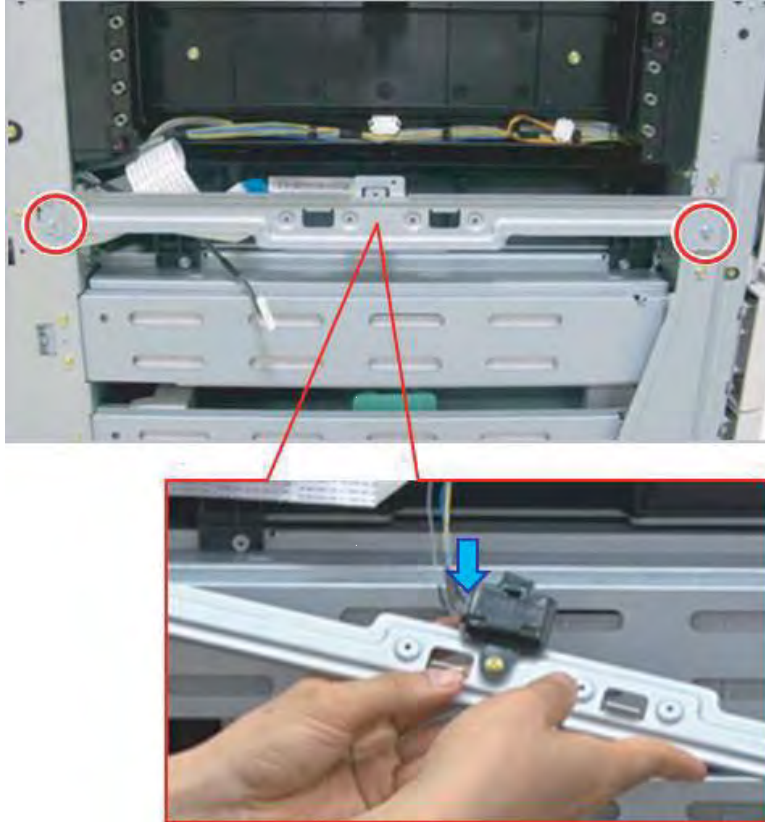
### Remove the laser scanner assembly

Follow these steps to remove the laser scanner assembly.

1. Remove two screws, and then release the bracket.

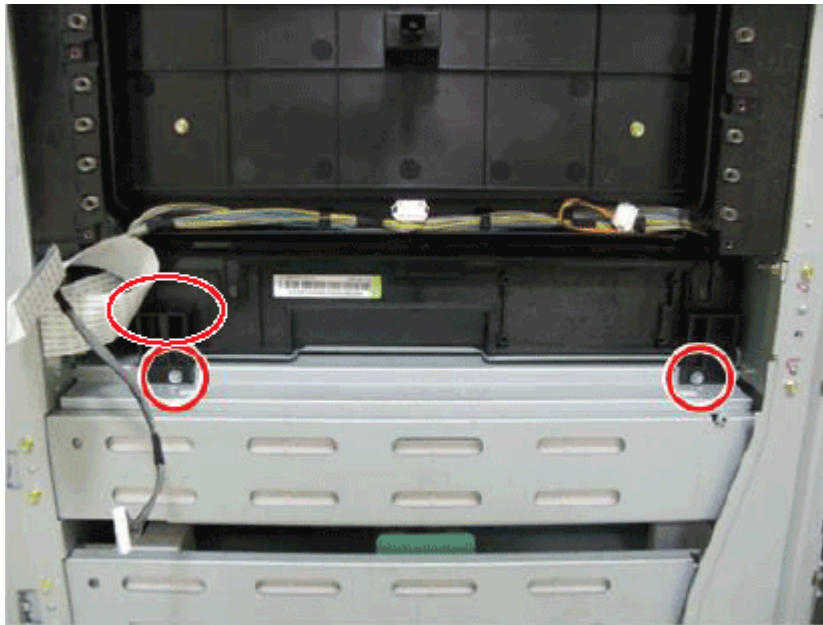


Figure 2-255 Release the bracket



2. Remove two screws and disconnect one sensor.

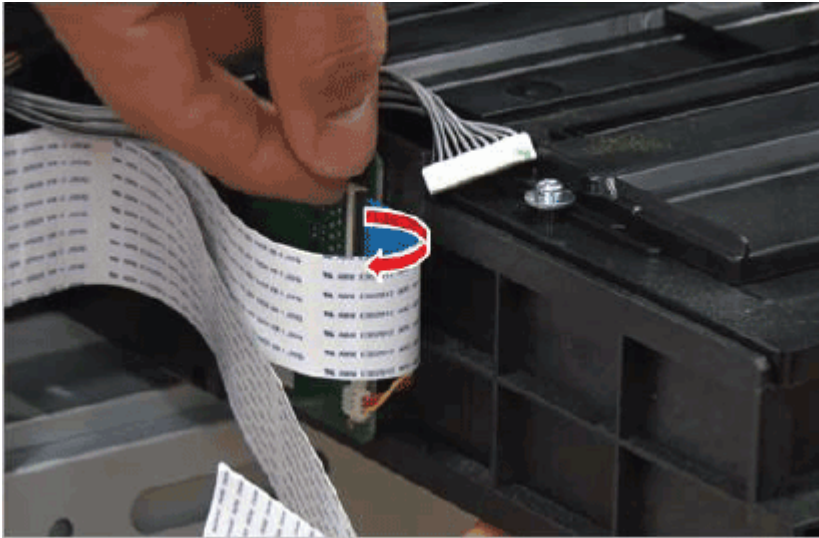
Figure 2-256 Remove the laser scanner assembly



3. Disconnect the laser scanner assembly harness at the left, and then partially remove the assembly from the chassis. Disconnect the FFC cable, and then remove the laser scanner assembly completely.

**⚠ CAUTION:** If the laser scanner assembly is removed too rough or fast, the harness can be damaged.

**Figure 2-257** Disconnect the laser scanner assembly harness and FFC cable



4. Complete a laser scanner assembly adjustment after a new laser scanner assembly has been installed.

## Unpack the replacement assembly


Follow these steps to unpack the replacement assembly.

1. Dispose of the defective part.

**📝 NOTE:** HP recommends responsible disposal of the defective part.

<http://www8.hp.com/us/en/hp-information/environment/product-recycling.html>

2. Unpack the replacement part from the packaging.

**⚠ CAUTION:**  Some parts are sensitive to electrostatic discharge (ESD). Always perform service work at an ESD-protected workstation or mat. If an ESD workstation or mat is not available, touch the sheet-metal chassis to provide a static ground before touching an ESD-sensitive assembly. Protect the ESD-sensitive assemblies by placing them in ESD pouches when they are out of the printer.

**📝 IMPORTANT:** Make sure that all of the shipping materials (for example shipping tape) are removed from the replacement part prior to installation.

**📝 NOTE:** If the replacement part is a roller or pad, avoid touching the spongy part of it. Skin oils on the roller or pad can cause paper pickup and/or print-quality problems. HP recommends using disposable gloves when handling rollers or pads or washing your hands before touching rollers or pads.

3. To install an assembly, reverse the removal steps.

**📝 NOTE:** When applicable, special installation instructions are provided for an assembly at the end of the removal procedure. Always completely read the removal instructions and follow all special installation instructions.


## Removal and replacement: Right door dampener and lever kit

Learn how to remove and replace the right door dampener.

### Before performing service

#### Turn the printer power off

- Press the power button on the front of the printer, and then turn off the power switch next to the power cable.
- A shutting-down message appears on the control-panel display.

 **WARNING!** To avoid damage to the printer, turn the power off and wait until the printer shuts down before removing the power cable.

- Disconnect the printer power cable after the printer has completely shut down (the control-panel display is blank).

Use the table below to identify the correct part number for your printer. To order the part, go to [www.hp.com/buy/parts](http://www.hp.com/buy/parts).

Table 2-59 Part information

Part number	Part description
5CM76-67901	Right door dampener and lever kit

### Required tools

- #2 JIS screwdriver with a magnetic tip

### After performing service

#### Turn the printer power on

- Connect the printer power cable.
- Turn on the power switch next to the power cable, and then press the power button on the front of the printer.
- Verify that the service performed was successful.
- Verify that the most recent firmware is installed on the printer.
- Verify that all parts are correctly reinstalled and are properly working.

### Post service test

Print any pages necessary to verify that the repair resolved the issue and did not create any new issues.

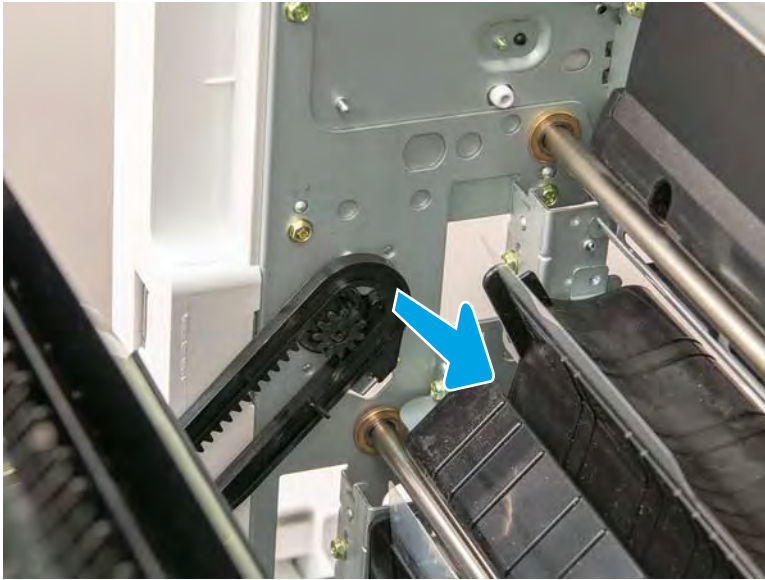
### Remove the right door dampener

Follow these steps to remove the right door dampener.

1. Remove Tray 2 and Tray 3.

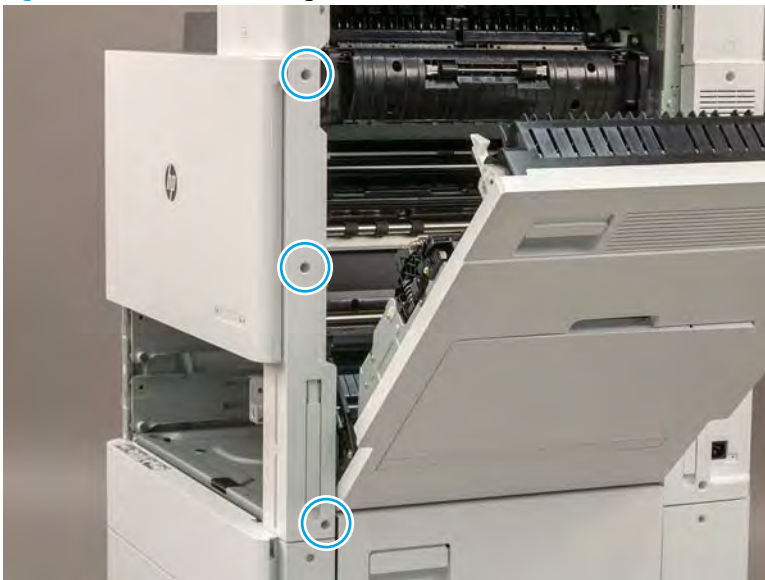
2. Open the right door, and then release the right door stopper from the damper.

Figure 2-258 Release the right door stopper




3. Remove three screws, and then remove the right front cover.

Figure 2-259 Remove the right front cover

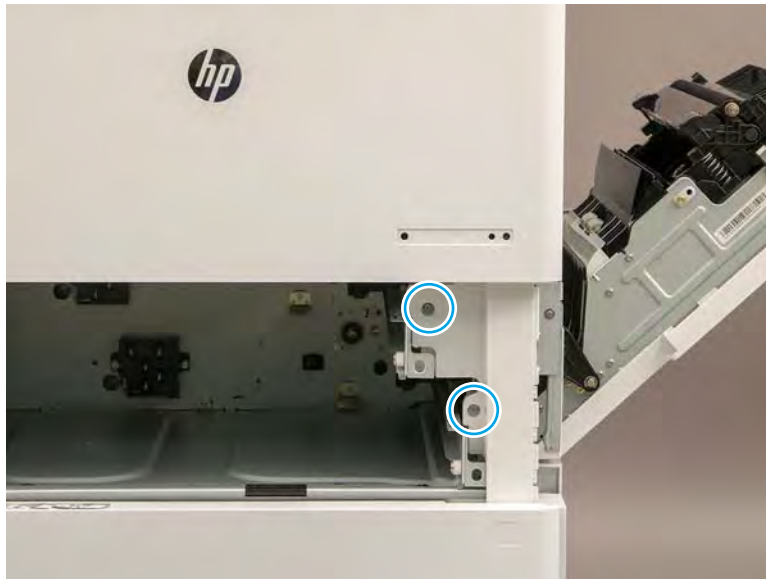


4. Remove two screws, and then remove the front lower cover.

 **TIP:** Slightly open Tray 4 to make removing the cover easier.

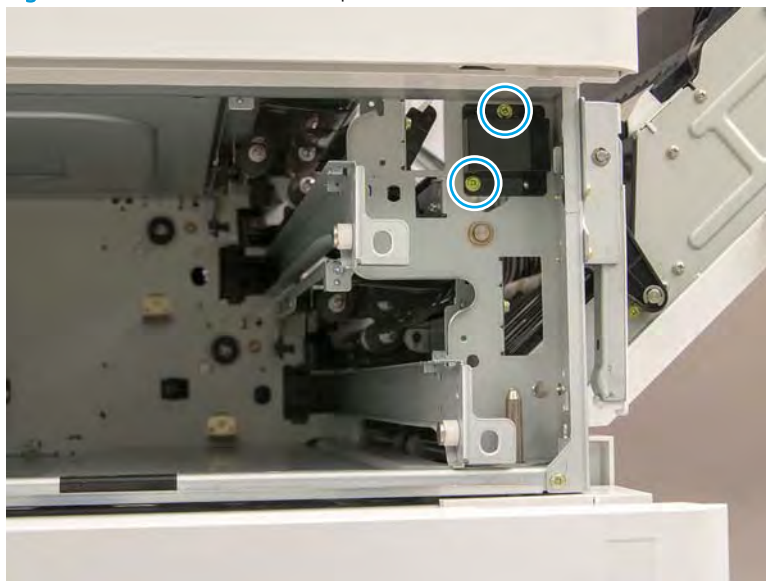
---

**Figure 2-260** Remove the front lower cover




5. Remove two screws, and then remove the dampener cover.

**Figure 2-261** Remove the dampener cover



6. Remove the dampener gear assembly.

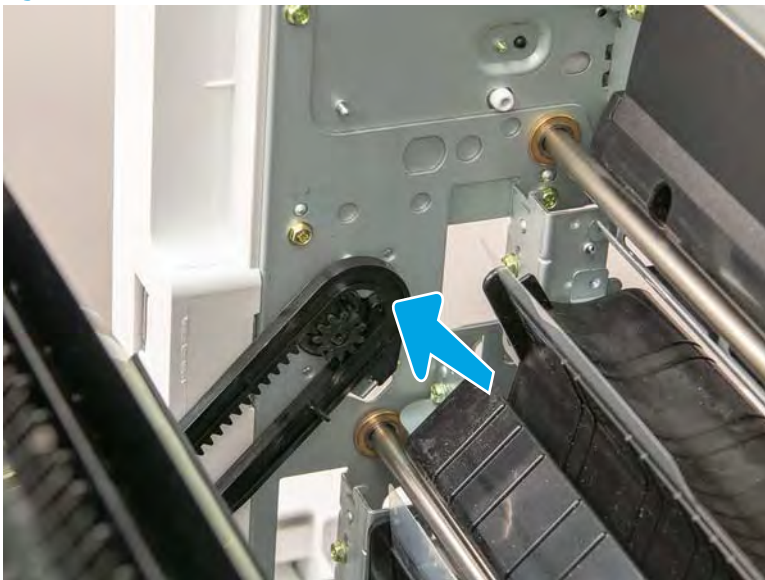
 **NOTE:** Do not discard the failed dampener. Return the assembly to HP for failure analysis.

**Figure 2-262** Remove the dampener assembly



7. **Important:** Make sure that the right door stopper is reinstalled after servicing the printer. Closing the right door without the stopper installed will damage the damper.

**Figure 2-263** Install the right door stopper



## Unpack the replacement assembly

Follow these steps to unpack the replacement assembly.

1. Dispose of the defective part.



---


 **NOTE:** HP recommends responsible disposal of the defective part.


<http://www8.hp.com/us/en/hp-information/environment/product-recycling.html>

---

2. Unpack the replacement part from the packaging.


 **CAUTION:**  Some parts are sensitive to electrostatic discharge (ESD). Always perform service work at an ESD-protected workstation or mat. If an ESD workstation or mat is not available, touch the sheet-metal chassis to provide a static ground before touching an ESD-sensitive assembly. Protect the ESD-sensitive assemblies by placing them in ESD pouches when they are out of the printer.

 **IMPORTANT:** Make sure that all of the shipping materials (for example shipping tape) are removed from the replacement part prior to installation.

 **NOTE:** If the replacement part is a roller or pad, avoid touching the spongy part of it. Skin oils on the roller or pad can cause paper pickup and/or print-quality problems. HP recommends using disposable gloves when handling rollers or pads or washing your hands before touching rollers or pads.

---

3. To install an assembly, reverse the removal steps.

 **NOTE:** When applicable, special installation instructions are provided for an assembly at the end of the removal procedure. Always completely read the removal instructions and follow all special installation instructions.

---


## Removal and replacement: High-voltage rail assembly

Learn how to remove and replace the high-voltage rail assembly.

### Before performing service

#### Turn the printer power off

- Press the power button on the front of the printer, and then turn off the power switch next to the power cable.
- A shutting-down message appears on the control-panel display.

 **WARNING!** To avoid damage to the printer, turn the power off and wait until the printer shuts down before removing the power cable.

- Disconnect the printer power cable after the printer has completely shut down (the control-panel display is blank).

Use the table below to identify the correct part number for your printer. To order the part, go to [www.hp.com/buy/parts](http://www.hp.com/buy/parts).

**Table 2-60** Part information

Part number	Part description
JC93-00494A	High-voltage rail assembly

### Required tools

- #2 JIS screwdriver with a magnetic tip

### After performing service

#### Turn the printer power on

- Connect the printer power cable.
- Turn on the power switch next to the power cable, and then press the power button on the front of the printer.
- Verify that the service performed was successful.
- Verify that the most recent firmware is installed on the printer.
- Verify that all parts are correctly reinstalled and are properly working.

### Post service test

Print any pages necessary to verify that the repair resolved the issue and did not create any new issues.

### Remove the left cover

Follow these steps to remove the left cover.

- ▲ Remove the left trim cover, and then remove ten screws to remove the left cover.



Figure 2-264 Remove the left trim cover

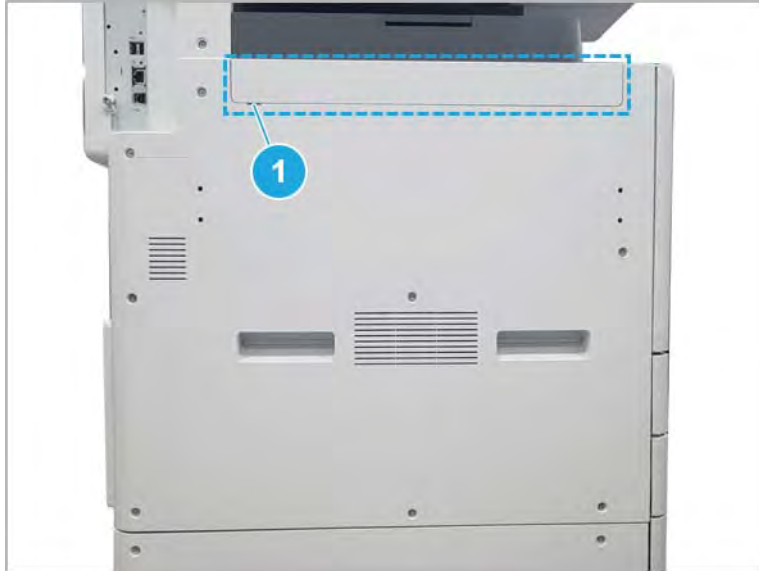
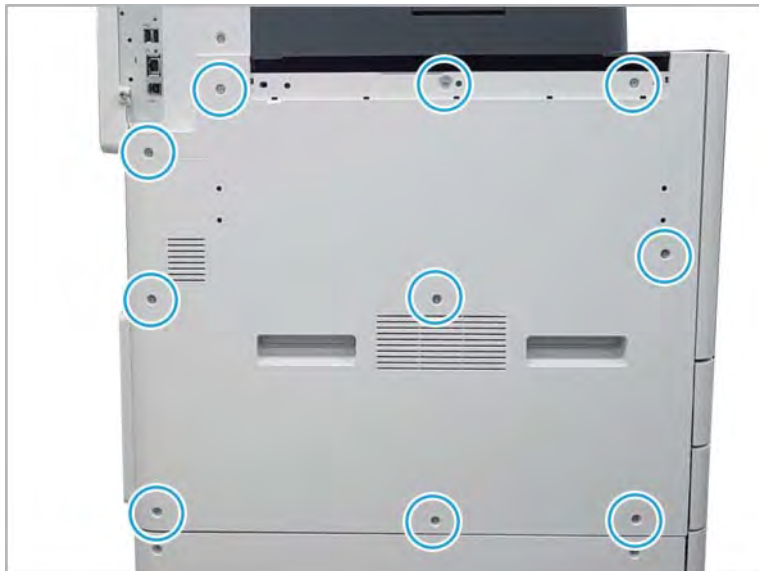


Figure 2-265 Remove the left cover

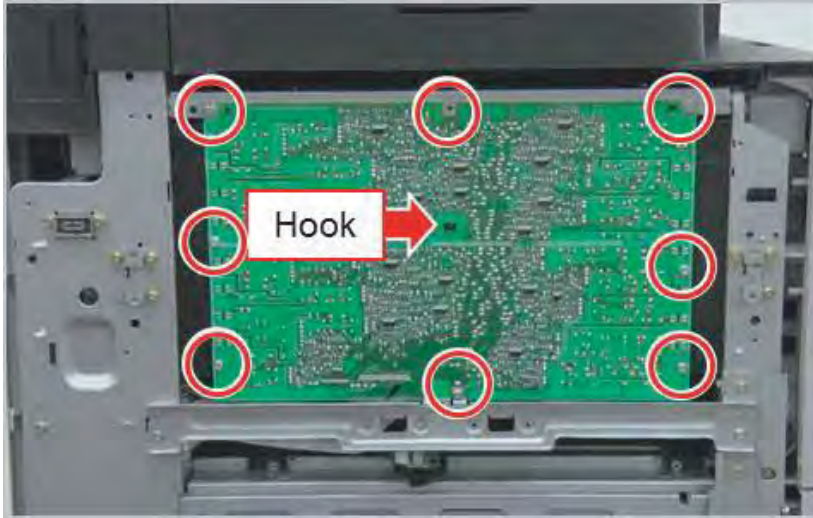


### Remove the high-voltage power supply (HVPS)

Follow these steps to remove the high-voltage power supply (HVPS).

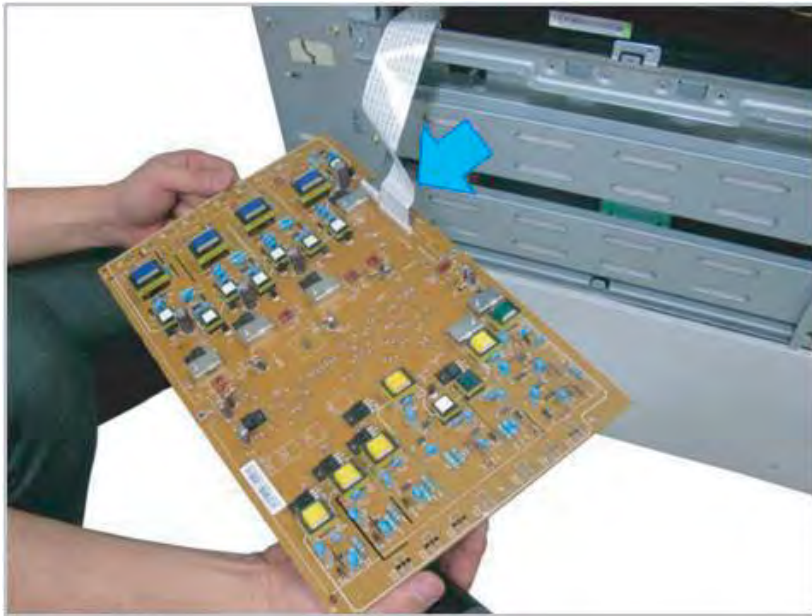
1. Remove eight screws, and then release middle hook.

Figure 2-266 Remove screws



2. Unplug the connector and then remove the HVPS.

Figure 2-267 Remove the HVPS board



## Remove the exit cover

Follow these steps to remove the exit cover.

1. Remove the inner finisher or paper pass, if installed.

2. Remove two screw-caps and two screws, and then remove the exit tray.

Figure 2-268 Remove screw-caps and screws

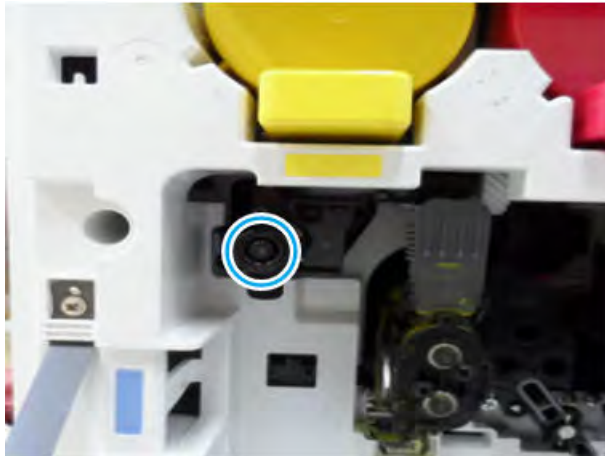


### Remove the ITB cleaner

Follow these steps to remove the ITB cleaner.

1. Open the front cover.
2. Loosen the captive screw.

Figure 2-269 Loosen screw



3. Release the ITB cleaner.

Figure 2-270 Release ITB cleaner



## Remove the right door

Follow these steps to remove the right door.

 **NOTE:** Remove second exit drive if installed.

1. Remove three screws, and then remove the cover (A).

Figure 2-271 Remove cover



2. Disconnect the right door connector.

Figure 2-272 Disconnect right door connector



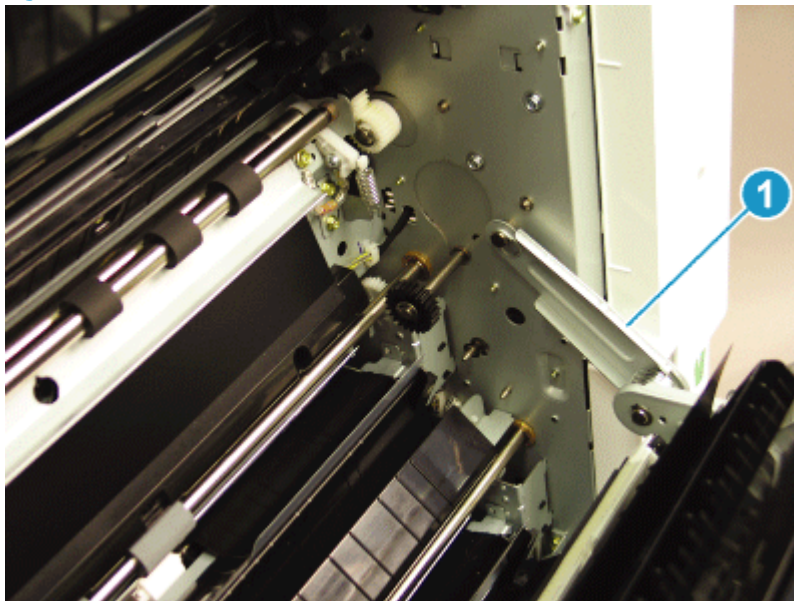
3. Release the right hinge (callout 1).

---

**⚠ CAUTION:** The right hinge spring tension can be dangerous. Use caution when releasing the right hinge to avoid injury.

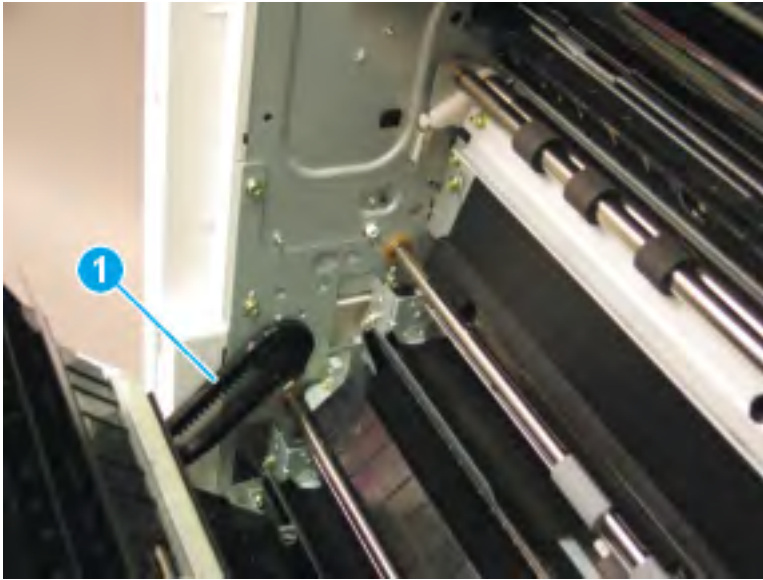
---

Figure 2-273 Release right hinge




4. Release the left dampener (callout 1).

Figure 2-274 Release left dampener



5. Remove the right door.

---

 **NOTE:** Open the lower access door. If there is an HCI or 2x520 input device, release the dampener to clear the lower right door. Remove clockwise.

---

Figure 2-275 Remove right door

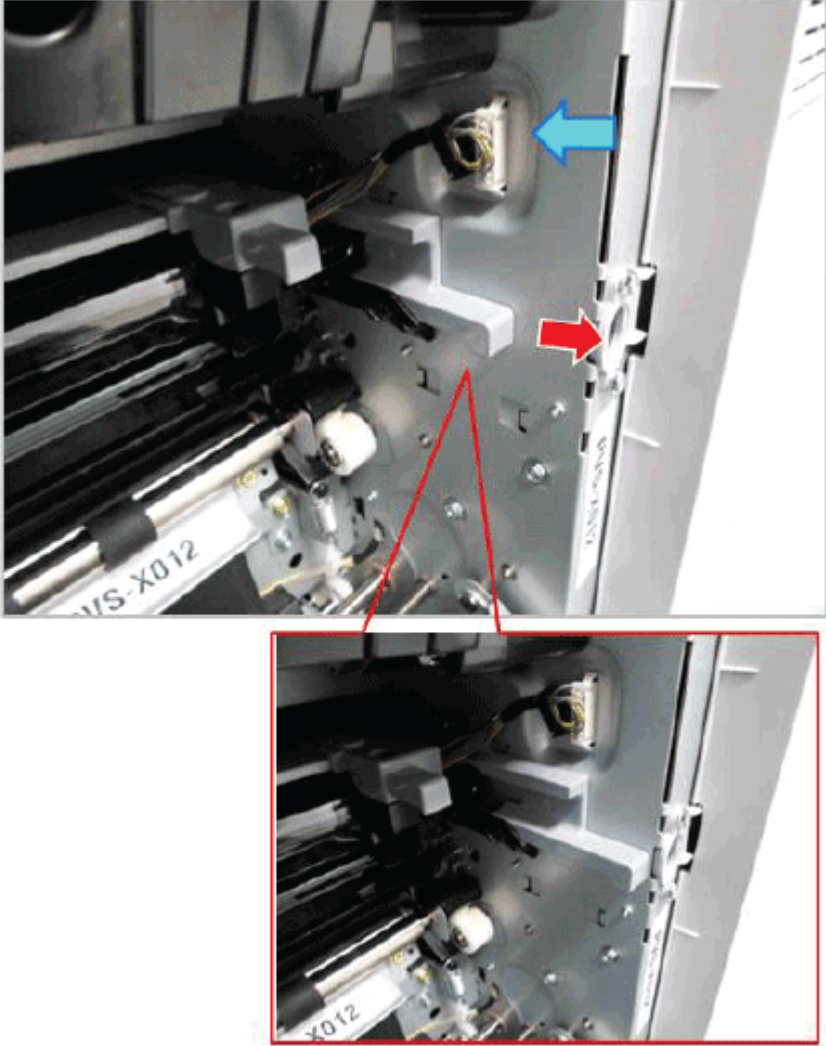


## Remove the ITB unit

Follow these steps to remove the ITB unit.

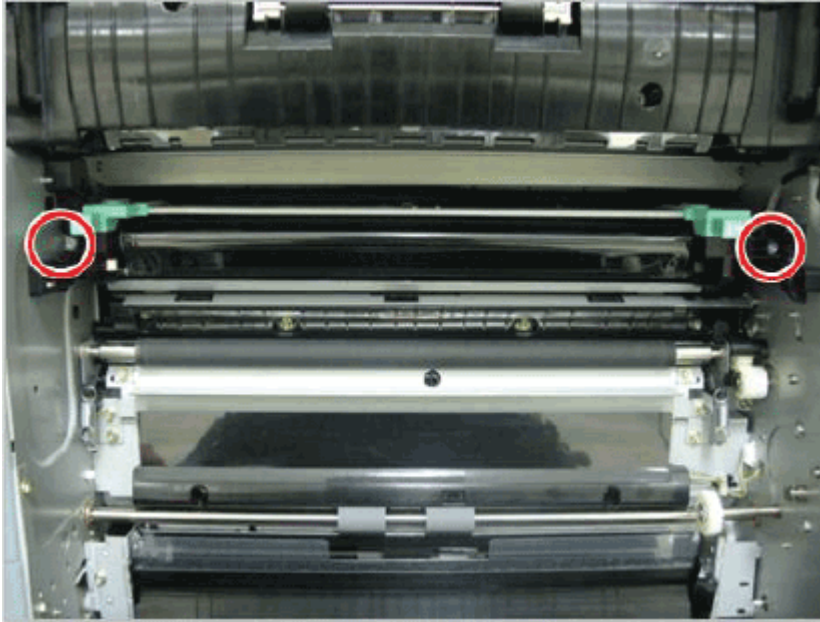
1. Disconnect the ITB connector from the right. Pull the holder to the front.

Figure 2-276 Disconnect ITB connector



2. Remove two screws.

Figure 2-277 Remove two screws

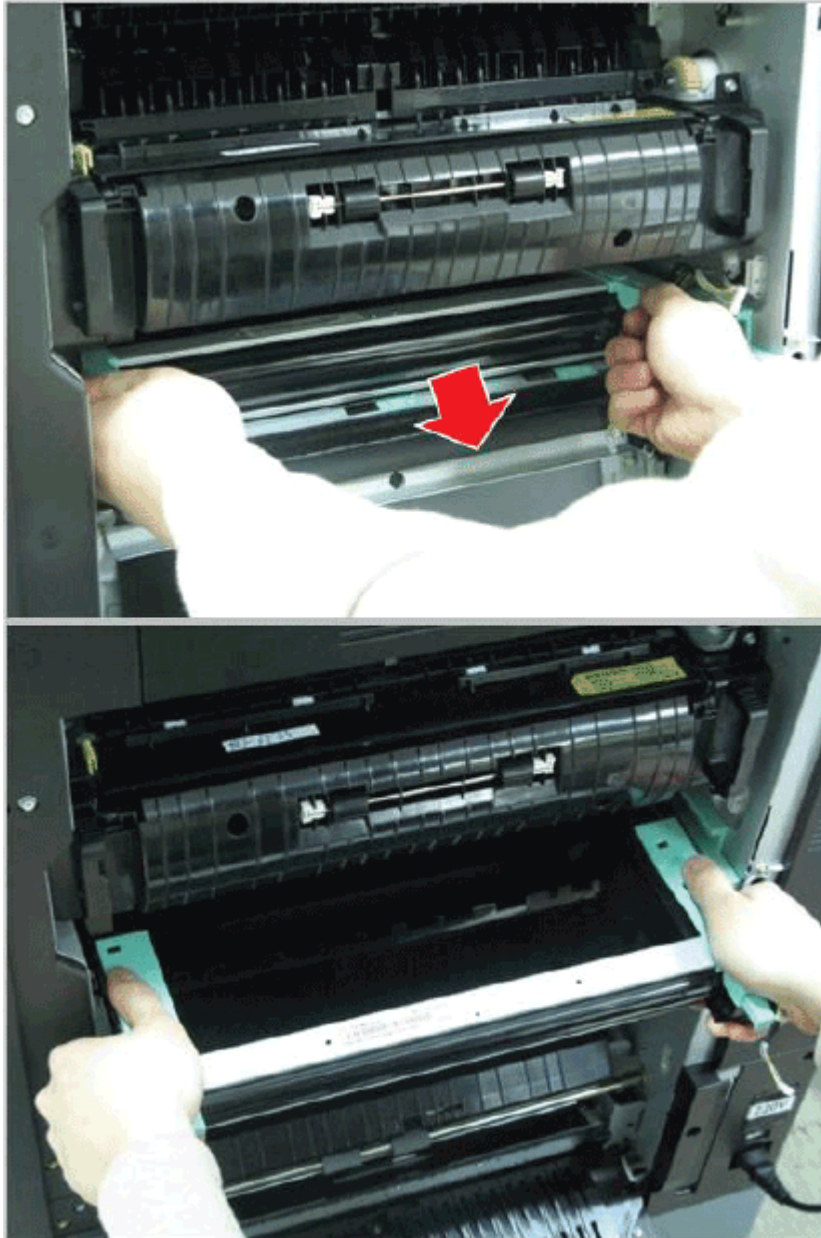




3. Remove the ITB unit until the handles are fully visible. Release the ITB unit smoothly.

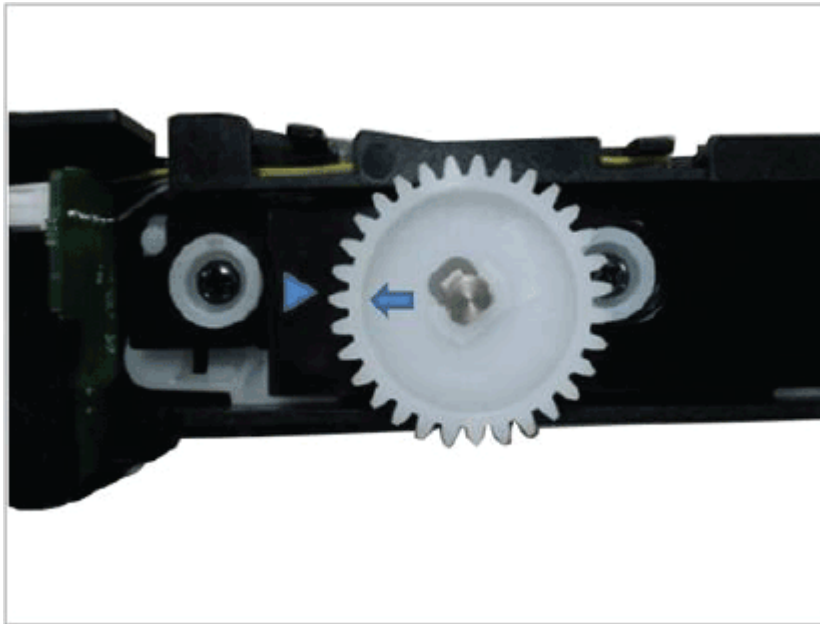
**CAUTION:** Make sure not to touch the belt surface of the ITB.

Figure 2-278 Release ITB unit



4. Before installing the new ITB unit, align the CAM position with the two arrows shown.

Figure 2-279 Align CAM



5. Install the new ITB unit, and then install the ITB cleaner.

## Remove the imaging drum

Follow these steps to remove the imaging drum.

1. Open the front cover.

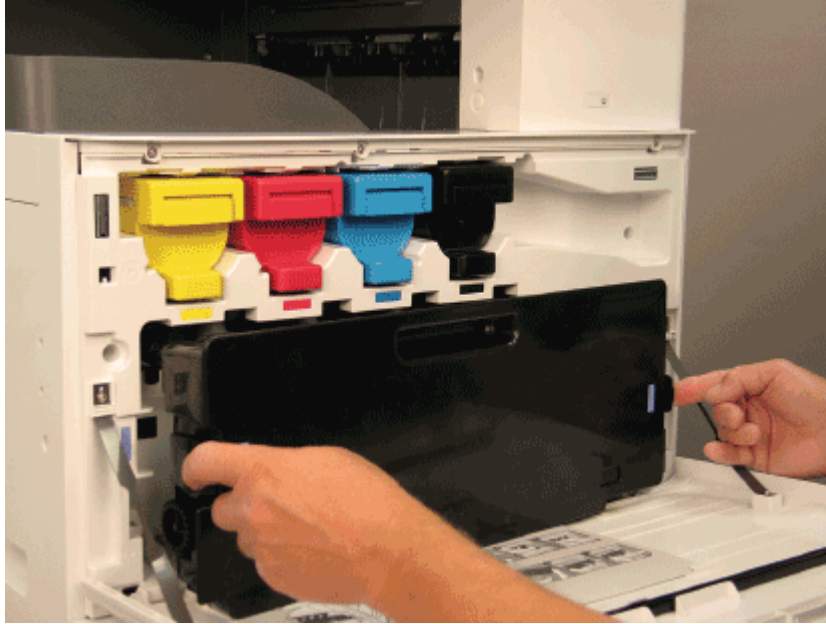
Figure 2-280 Open the front cover



2. Open the right door and make sure the latch releases.

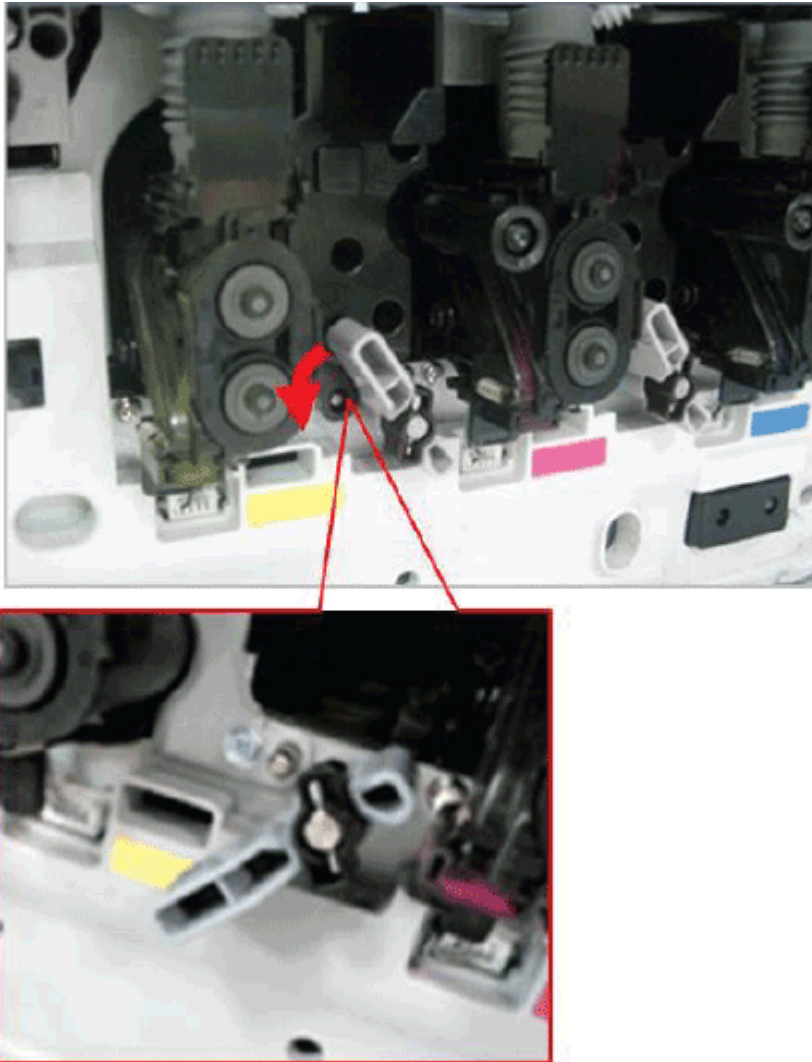
3. Remove the toner collection unit.

Figure 2-281 Remove the toner collection unit.



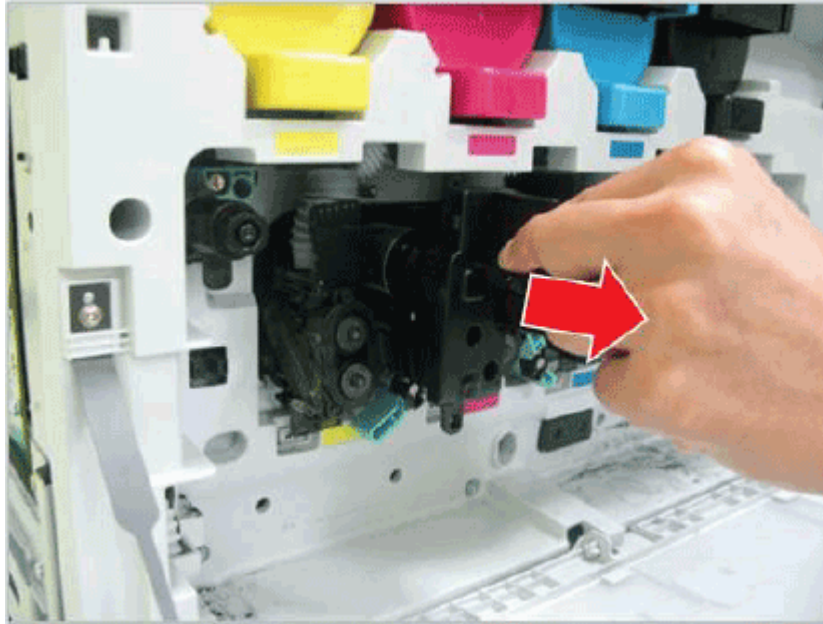
4. Turn the locking level counterclockwise.

Figure 2-282 Turn level counterclockwise




5. Remove the imaging drum.

Figure 2-283 Remove the imaging drum



6. If installing a new imaging drum, remove from the imaging drum from its packaging, and then rotate the locking lever clockwise until it makes a solid “click”.

---

 **NOTE:** If you intend to reuse an imaging drum, make sure the imaging drum surface is covered and not exposed to direct light or sunlight. Cover the imaging drum with a few sheets of paper or keep it in the original packaging until ready to install. When handling any imaging drum, do not touch the drum surface.

---

## Remove the developer unit

Follow these steps to remove the developer unit.

1. Turn off the printer. Open the front door and remove the toner collection unit.

Figure 2-284 Remove the toner collection unit



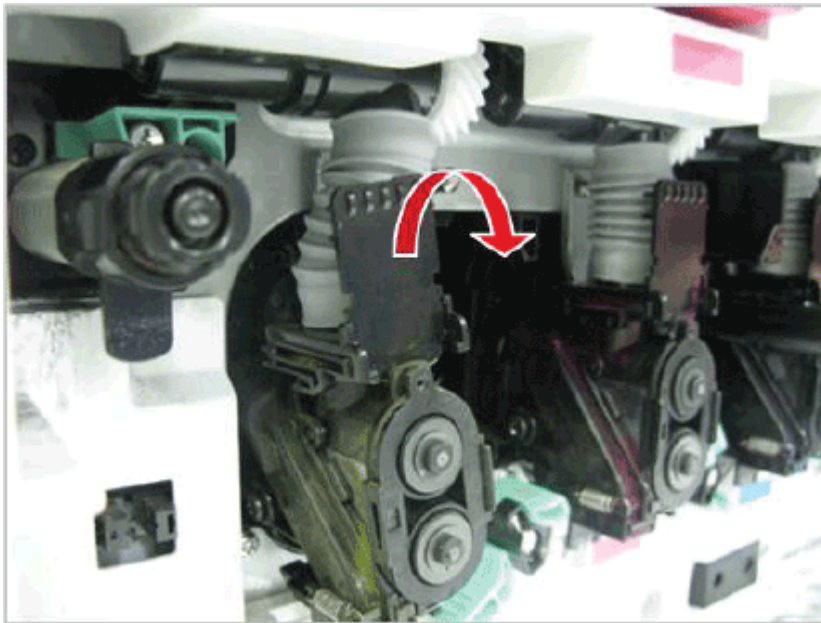
2. Remove the imaging drum that corresponds with the developer unit being replaced.
3. Fold down the toner supply shutter.

---

**⚠ CAUTION:** The toner supply cap contains toner. Use caution to avoid spilling toner during removal.

---

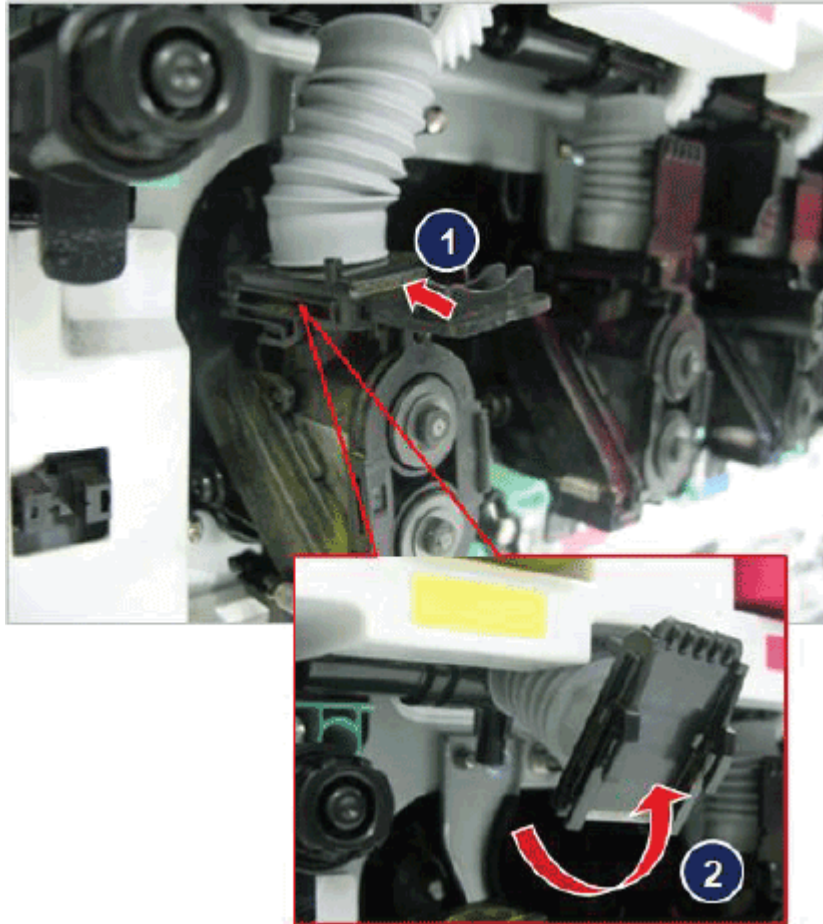
Figure 2-285 Fold down the toner supply shutter



4. Push the shutter in to close the toner supply (callout 1). Grasp the toner supply connection on the black plastic and wiggle and pull out to disengage the connection from the developing unit. Rotate the toner supply up (callout 2).

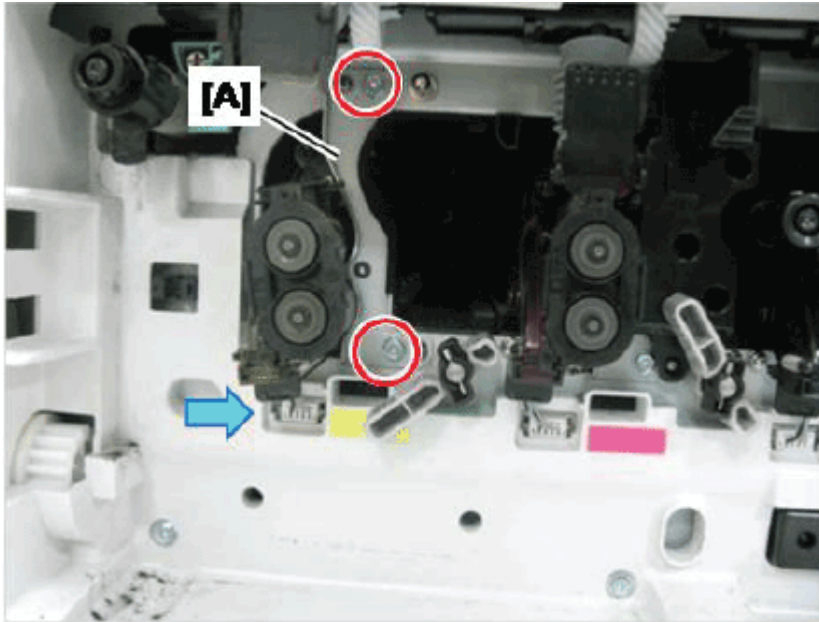
**CAUTION:** Do not compress or squeeze the gray supply pipe. This supply pipe is filled with toner and will leak if squeezed.

Figure 2-286 Rotate swivel



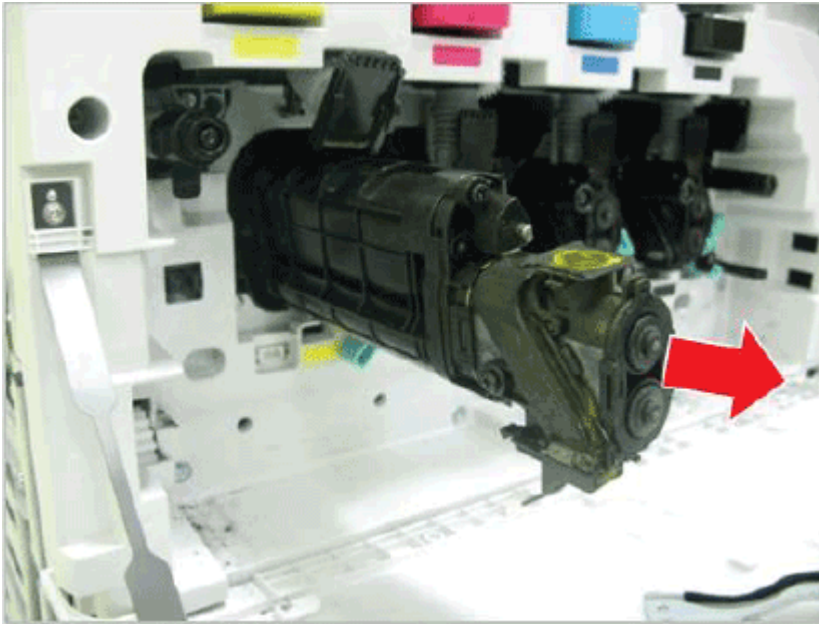
5. Remove 2 screws and then remove the bracket (A). Disconnect the connector.


Figure 2-287 Remove bracket




6. Remove the developer unit.

Figure 2-288 Remove developer unit



 **NOTE:** The carrier in this printer series developer unit cannot be changed. The entire developer unit must be replaced.

 **NOTE:** When the assembly is installed, make sure that the bracket is seated correctly and that the bracket screws are installed. Install the toner supply by swiveling down to the normal position, and make sure the toner supply shutter is pulled up to the "open" position. Reinstall the imaging drum, then reinstall the toner collection unit.



## Remove the paper dust brush

### Unpack the replacement assembly

Follow these steps to unpack the replacement assembly.

1. Dispose of the defective part.




**NOTE:** HP recommends responsible disposal of the defective part.

<http://www8.hp.com/us/en/hp-information/environment/product-recycling.html>

---

2. Unpack the replacement part from the packaging.



**CAUTION:**  Some parts are sensitive to electrostatic discharge (ESD). Always perform service work at an ESD-protected workstation or mat. If an ESD workstation or mat is not available, touch the sheet-metal chassis to provide a static ground before touching an ESD-sensitive assembly. Protect the ESD-sensitive assemblies by placing them in ESD pouches when they are out of the printer.



**IMPORTANT:** Make sure that all of the shipping materials (for example shipping tape) are removed from the replacement part prior to installation.



**NOTE:** If the replacement part is a roller or pad, avoid touching the spongy part of it. Skin oils on the roller or pad can cause paper pickup and/or print-quality problems. HP recommends using disposable gloves when handling rollers or pads or washing your hands before touching rollers or pads.

---

3. To install an assembly, reverse the removal steps.



**NOTE:** When applicable, special installation instructions are provided for an assembly at the end of the removal procedure. Always completely read the removal instructions and follow all special installation instructions.

---

## Remove the front cover and inner cover

Follow these steps to remove the front cover and inner cover.

1. Open the right door.

Figure 2-289 Open right door



2. Remove two screw-caps and two screws (callout 1).


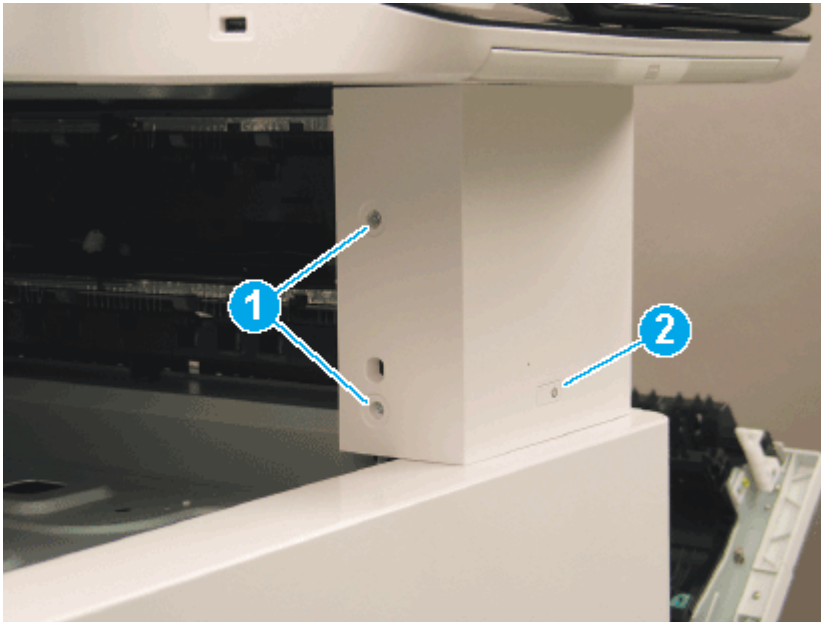
 **NOTE:** Do not dislodge the power button (callout 2) when the cover is removed.

Figure 2-290 Remove screw-caps and screws



3. GX/z models: Remove two screws.

 **NOTE:** Do not dislodge the power button when the cover is removed.

---

**Figure 2-291** Remove screws



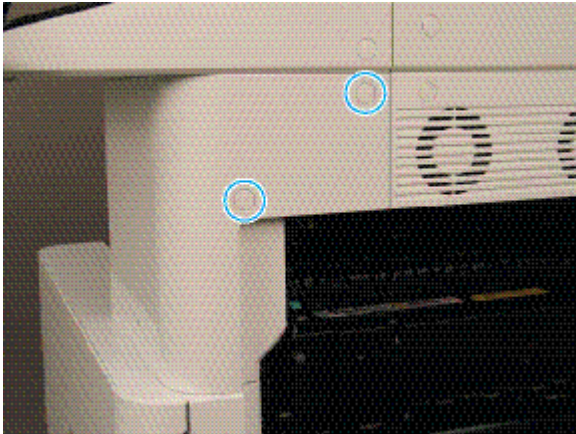
4. LX/dn Models: Remove one screw inside of right door.

**Figure 2-292** Remove one screw



5. GX/z models: Remove two screws.

Figure 2-293 Remove two screws



6. Remove the front-top cover.

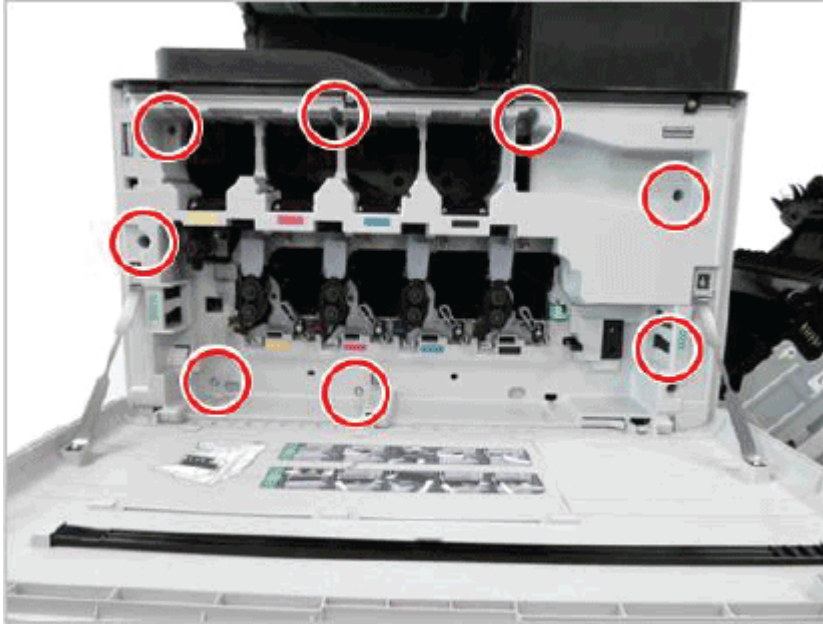
Figure 2-294 Remove the front top cover



7. Open the front door. Remove the Toner Collection Unit (TCU). Remove all toner cartridges.
8. Remove three tapping screws and remove the top front cover.


9. Remove eight screws, and then remove the front inner cover.

Figure 2-295 Remove screws and front inner cover



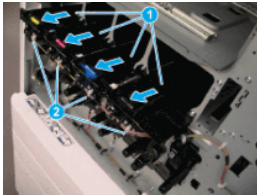
## Remove the reservoir unit

Follow these steps to remove the reservoir unit.

 **NOTE:** The toner reservoirs must be removed in this order: black, cyan, magenta, and yellow. If you are replacing the yellow reservoir, the black, cyan, and magenta reservoirs must all be removed first. Follow the instructions below to remove only those reservoirs required to reach the target reservoir.

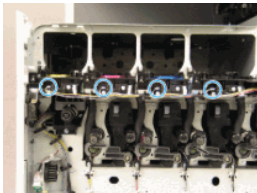
1. Close the toner reservoir shutters (callout 1), and then release the cables from the retainers (callout 2).

Figure 2-296 Close the shutters and release the cables



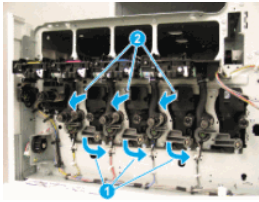
2. Disconnect four connectors.

Figure 2-297 Disconnect four connectors



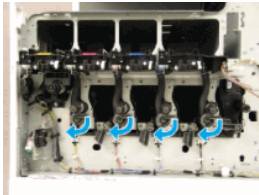
3. Lower the release levers (callout 1), and then remove the yellow, magenta, and cyan drum units (callout 2).

**Figure 2-298** Remove drum units



4. Lower and close the release levers for all of the developer units. This stops the flow of toner from the toner reservoirs to the developer units.

**Figure 2-299** Lower the developer release levers



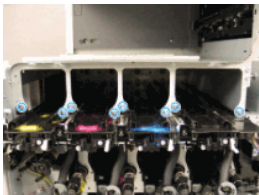
5. Release the valves from the toner connections by rotating the valves side-to-side while pulling them firmly away from the printer.

**Figure 2-300** Release the toner supply pipes



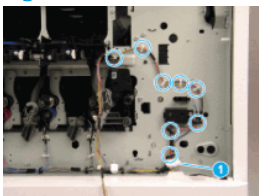
6. Remove eight screws.

**Figure 2-301** Remove eight screws





7. Disconnect one connector (callout 1), and then release the cables from eight retainers.

**Figure 2-302** Disconnect one connector and release the cables

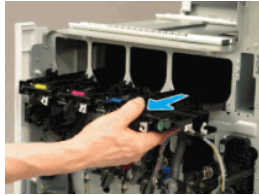


8. Remove the toner reservoir by sliding it out of the printer. The figure below shows the black toner reservoir. The procedure is the same for all of the toner reservoirs.

 **NOTE:** The toner reservoirs must be removed in this order: black, cyan, magenta, and yellow. If you are replacing the yellow reservoir, the black, cyan, and magenta reservoirs must all be removed first.

 **NOTE:** Removing the yellow toner reservoir requires removing the high voltage power supply.

**Figure 2-303** Remove the black toner reservoir

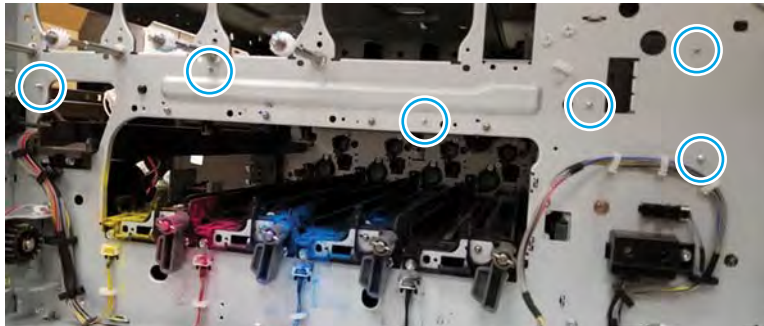


## Remove the high-voltage rail assembly

Follow these steps to remove the high-voltage rail assembly.

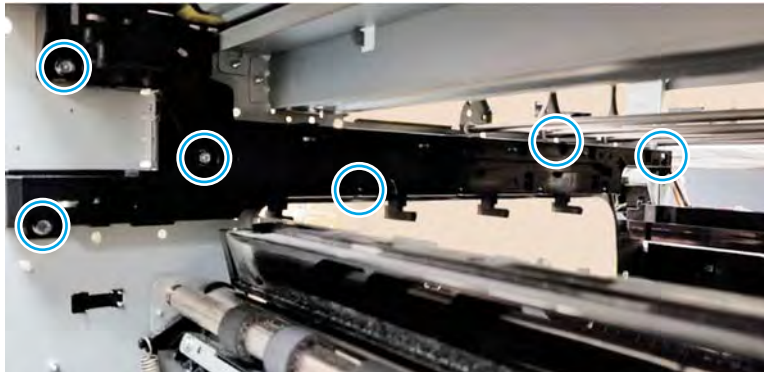
1. Before proceeding, take note from the front of the printer where the six high-voltage rail screws are located.

**Figure 2-304** Locate six screws



2. From inside the printer remove six screws, and then remove the high-voltage rail assembly.

**Figure 2-305** Remove the high-voltage rail assembly




## Unpack the replacement assembly

Follow these steps to unpack the replacement assembly.

1. Dispose of the defective part.



---


 **NOTE:** HP recommends responsible disposal of the defective part.


<http://www8.hp.com/us/en/hp-information/environment/product-recycling.html>

---

2. Unpack the replacement part from the packaging.


 **CAUTION:**  Some parts are sensitive to electrostatic discharge (ESD). Always perform service work at an ESD-protected workstation or mat. If an ESD workstation or mat is not available, touch the sheet-metal chassis to provide a static ground before touching an ESD-sensitive assembly. Protect the ESD-sensitive assemblies by placing them in ESD pouches when they are out of the printer.

 **IMPORTANT:** Make sure that all of the shipping materials (for example shipping tape) are removed from the replacement part prior to installation.

 **NOTE:** If the replacement part is a roller or pad, avoid touching the spongy part of it. Skin oils on the roller or pad can cause paper pickup and/or print-quality problems. HP recommends using disposable gloves when handling rollers or pads or washing your hands before touching rollers or pads.

---

3. To install an assembly, reverse the removal steps.

 **NOTE:** When applicable, special installation instructions are provided for an assembly at the end of the removal procedure. Always completely read the removal instructions and follow all special installation instructions.

---

## Reverse the removal steps to install the assembly


Also use the following **special installation instructions**.




## Removal and replacement: TCU presence photo sensor

Learn how to remove and replace the toner collection unit presence photo sensor.

 [View a video of how to remove and replace the toner collection unit presence photo sensor.](#)

 **IMPORTANT:** When applicable, special installation instructions are provided for an assembly at the end of the removal procedure. Always completely read the removal instructions and follow all special installation instructions.

### Before performing service

- Press the power button on the front of the printer, and then turn off the power switch next to the power cable.
- A shutting-down message appears on the control-panel display.
-  **WARNING!** To avoid damage to the printer, turn the power off and wait until the printer shuts down before removing the power cable.
- Disconnect the printer power cable after the printer has completely shut down (the control-panel display is blank).

Use the table below to identify the correct part number for your printer. To order the part, go to [www.hp.com/buy/parts](http://www.hp.com/buy/parts)

**Table 2-61 Part information**

Part number	Part description
JC93-00492A	TCU presence photo sensor

### Required tools

- #2 JIS screwdriver with a magnetic tip

### After performing service

- Connect the printer power cable.
- Turn on the power switch next to the power cable, and then press the power button on the front of the printer.
- Verify that the service performed was successful.
- Verify that the most recent firmware is installed on the printer.
- Verify that all parts are correctly reinstalled and are properly working.

### Post service test

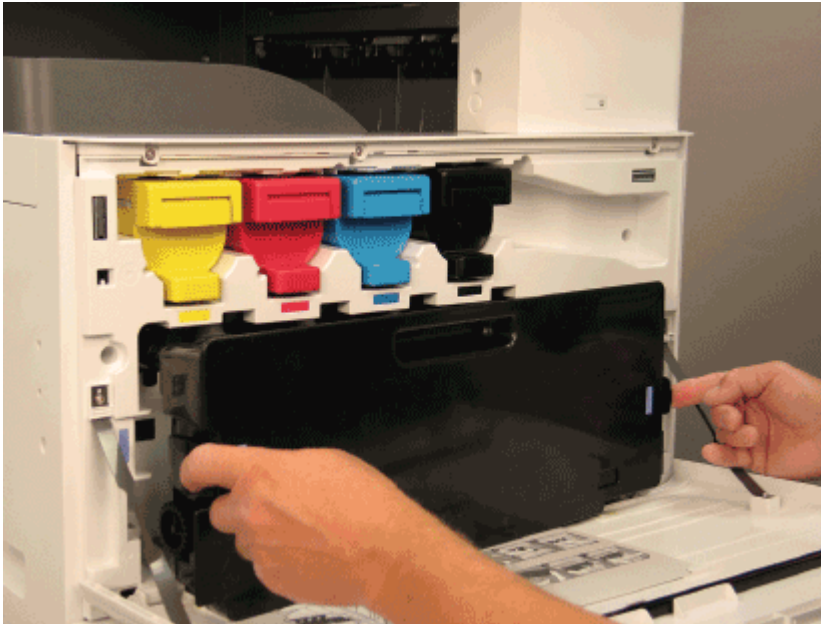
Print any pages necessary to verify that the repair resolved the issue and did not create any new issues.

## Remove the toner cartridges

Follow these steps to remove the toner cartridges.

- ▲ Open the front door and remove the toner collection unit and toner cartridges.

Figure 2-306 Remove the TCU

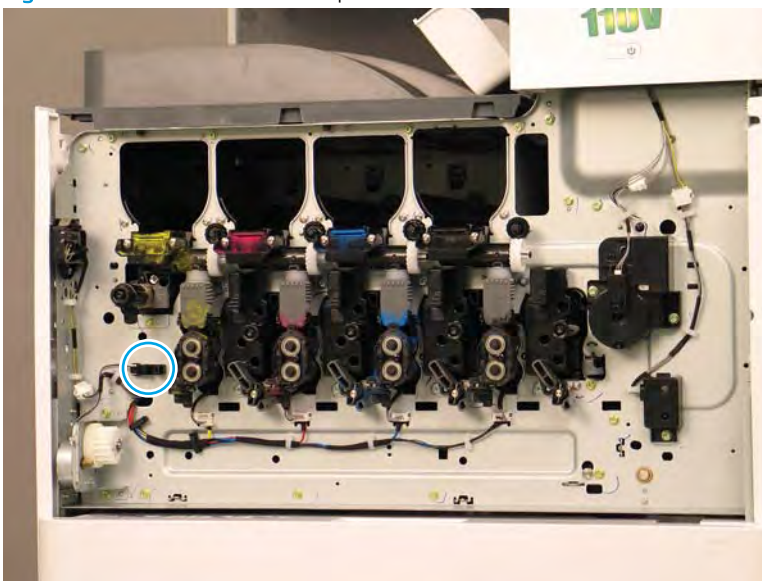


### Remove the TCU presence photo sensor

Follow these steps to remove the TCU presence photo sensor.

1. Remove the yellow imaging and developer units
2. Disconnect one connector. Reach inside the chassis and squeeze two tabs on the connector side of the sensor, and then release the hook on the right side of the sensor assembly.

Figure 2-307 Remove the TCU presence sensor




## Removal and replacement: Paper size sensor PCA

This document provides the procedures to remove the Paper Size Sensor PCA.

Mean time to repair: 20 minutes

Service level: Intermediate

 **IMPORTANT:** When applicable, special installation instructions are provided for an assembly at the end of the removal procedure. Always completely read the removal instructions and follow all special installation instructions.

### Before performing service

- Disconnect the power cable.

Use the table below to identify the correct part number for your printer. To order the part, go to [www.hp.com/buy/parts](http://www.hp.com/buy/parts)

Table 2-62 Part information

Part number	Part description
JC92-02622C	Paper Size Sensor PCA (For 77822, 77825, 77830, 78323, 78325, 78330)

### Required tools

- #2 JIS screwdriver with a magnetic tip

### After performing service

#### Turn the printer power on

- Connect the power cable.
- Use the power switch to turn the power on.

### Post service test

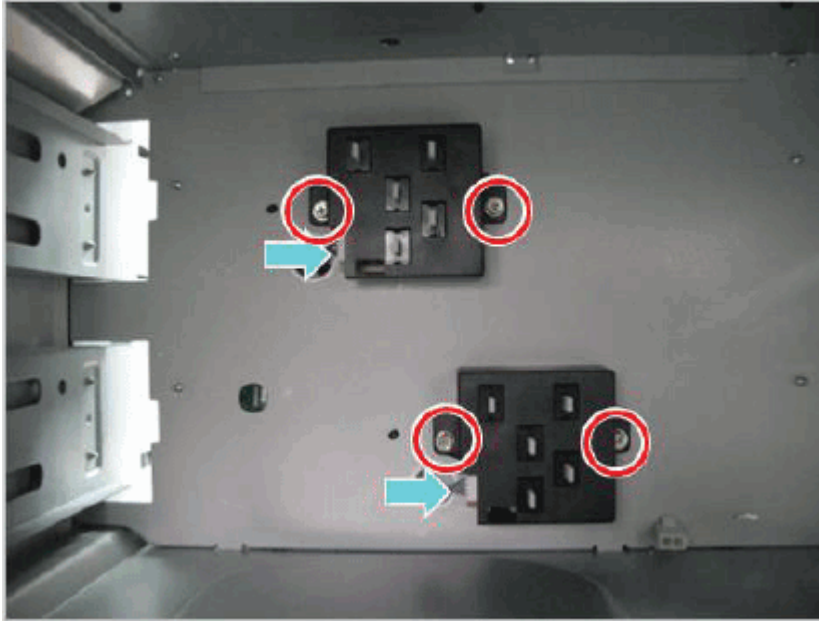
Copy, scan, or print a document. Verify the document copies, scans, or prints correctly.

## Remove the Paper Size Sensor PCA

Follow these steps to remove the Paper Size Sensor PCA.

- ▲ Do the following:
  - Remove all trays to access the inside of the printer.
  - Disconnect the connector. Remove two screws, and then remove the sensor.

Figure 2-308 Remove screws



## Unpack the replacement assembly



Follow these steps to unpack the replacement assembly.


1. Dispose of the defective part.


 **NOTE:** HP recommends responsible disposal of the defective part.

<http://www8.hp.com/us/en/hp-information/environment/product-recycling.html>


2. Unpack the replacement part from the packaging.

 **CAUTION:**  Some parts are sensitive to electrostatic discharge (ESD). Always perform service work at an ESD-protected workstation or mat. If an ESD workstation or mat is not available, touch the sheet-metal chassis to provide a static ground before touching an ESD-sensitive assembly. Protect the ESD-sensitive assemblies by placing them in ESD pouches when they are out of the printer.

 **IMPORTANT:** Make sure that all of the shipping materials (for example shipping tape) are removed from the replacement part prior to installation.

 **NOTE:** If the replacement part is a roller or pad, avoid touching the spongy part of it. Skin oils on the roller or pad can cause paper pickup and/or print-quality problems. HP recommends using disposable gloves when handling rollers or pads or washing your hands before touching rollers or pads.

3. To install an assembly, reverse the removal steps.

 **NOTE:** When applicable, special installation instructions are provided for an assembly at the end of the removal procedure. Always completely read the removal instructions and follow all special installation instructions.

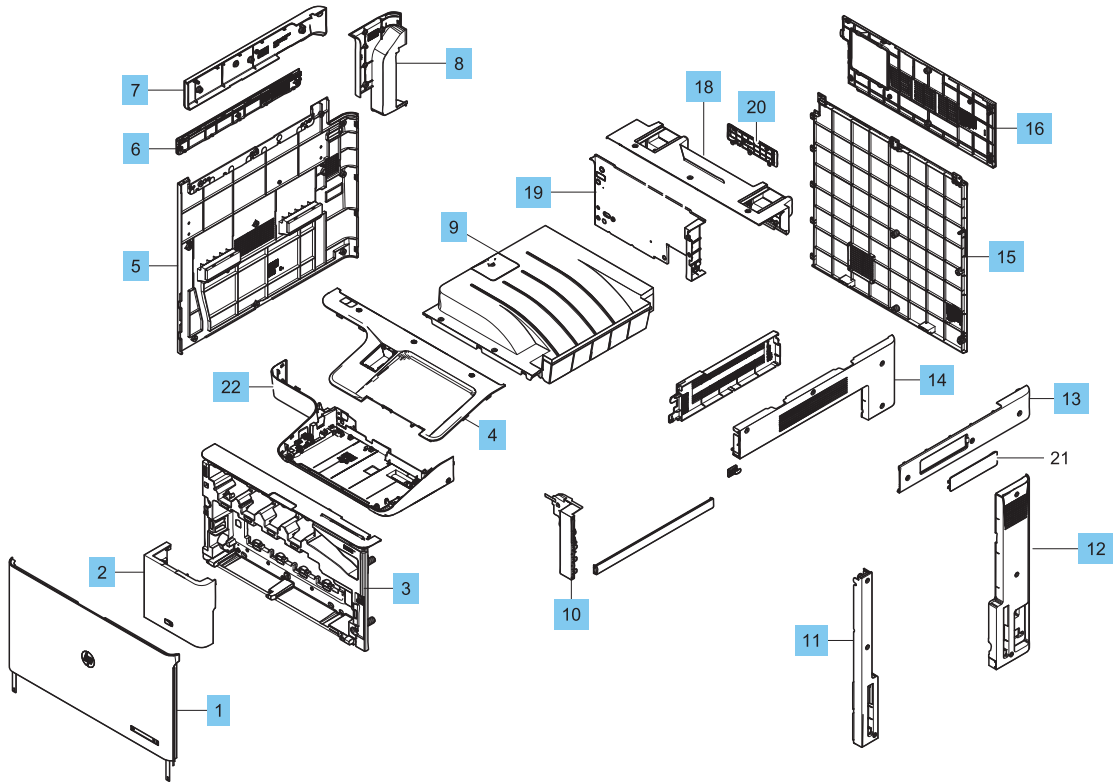
## Covers

View covers exploded view, parts list, and repair procedures.

# Covers

Parts diagram and parts list for the covers.

Figure 2-309 Covers



**Table 2-63 Covers**

Ref				
No	Part number	Description	Qty	Repair Procedure
1	JC95-02116A	Front cover	1	Not applicable
2	JC95-02082A	Right cover, middle	1	Not applicable
3	JC95-02089A	Inner cover	1	Not applicable
4	JC63-05647A	Cover, Control Panel Top	1	Not applicable
5	JC95-02085A	Left cover	1	<a href="#">Removal and replacement: Left cover on page 437</a>
6	JC63-04534B	Left cover, top	1	Not applicable
7	JC63-05576A	Left scan cover	1	Not applicable
8	JC63-05623A	Left cover, upper	1	Not applicable
9	JC95-02208A	Exit cover	1	Not applicable
10	JC63-04536B	Front cover, lower	1	Not applicable
11	JC63-04531B	Right cover, front	1	Not applicable
12	JC63-04532B	Right cover, rear	1	Not applicable
13	JC63-05575A	Right scan cover	1	Not applicable
14	JC63-04520B	Right cover, upper	1	Not applicable
15	JC63-05619A	Rear cover, lower (For E77822, E78785, E77830)	1	<a href="#">Removal and replacement: Rear covers on page 434</a>
15	8GR98-40016	Rear cover, lower (For E78323, E78325, E78330)	1	<a href="#">Removal and replacement: Rear covers on page 434</a>
16	JC63-05618A	Rear cover, upper	1	<a href="#">Removal and replacement: Rear covers on page 434</a>
18	JC63-05577A	Rear scan cover	1	Not applicable
20	JC63-04567B	Rear cover, dummy	1	Not applicable
22	JC63-05648A	Cover, control panel bottom	1	Not applicable
Not shown	B5L46-40002	Keyboard blank for non Flow	1	Not applicable
Not shown	B5L47-60102	US English Keyboard Assy	1	Not applicable
Not shown	B5L47-60103	UK English Keyboard Assy	1	Not applicable
Not shown	B5L46-40029	Bushing for Keyboard	1	Not applicable
Not shown	JC61-04626A	Strap, front cover	1	Not applicable
Not shown	JC92-02951A	PCA, USB host	1	Not applicable
Not shown	JC92-02969A	PCA, front power switch	1	Not applicable
Not shown	8GR94-60103	Front Label Kit (For 783xx dn)	1	Not applicable
Not shown	8GR98-60104	Front Label Kit (For 783xx z)	1	Not applicable


## Removal and replacement: Rear covers

This document provides the procedures to remove the rear covers.

 [View a video of removing the rear covers.](#)

Mean time to repair: 5 minutes

Service level: Basic

 **IMPORTANT:** When applicable, special installation instructions are provided for an assembly at the end of the removal procedure. Always completely read the removal instructions and follow all special installation instructions.

### Before performing service

- Disconnect the power cable.

Use the table below to identify the correct part number for your printer. To order the part, go to [www.hp.com/buy/parts](http://www.hp.com/buy/parts)

**Table 2-64 Part information**

Part number	Part description
JC63-05618A	Rear-upper cover
JC63-05619A	Rear-lower cover (E778xx series)
8GR98-40016	Rear-lower cover (E783xx series)

### Required tools

- #2 JIS screwdriver with a magnetic tip

### After performing service

#### Turn the printer power on

- Connect the power cable.
- Use the power switch to turn the power on.

### Post service test

No post service tests are required for this assembly.

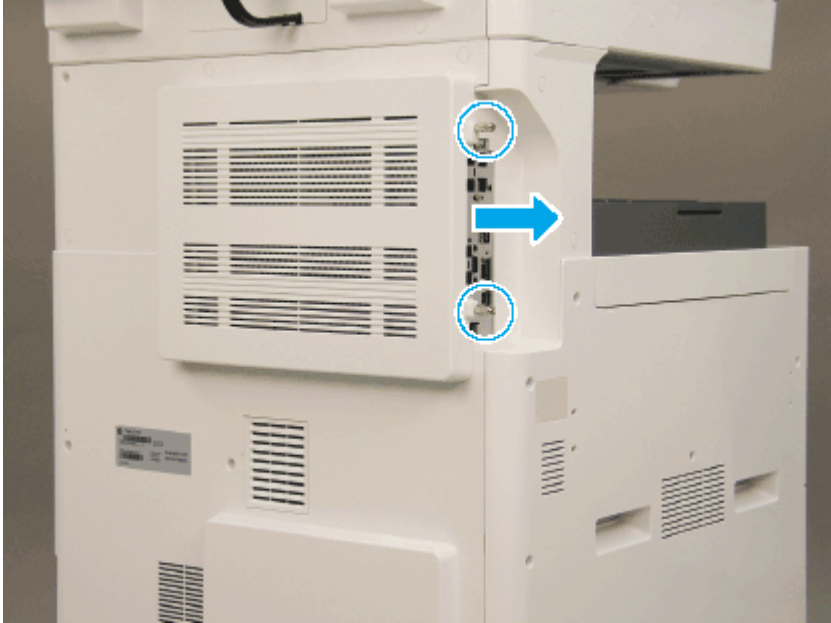
## Remove the rear covers

Follow these steps to remove the rear covers.

1. Unscrew two captive thumbscrews on the formatter cover. Slide the formatter cover to the left, and then to the right to remove.

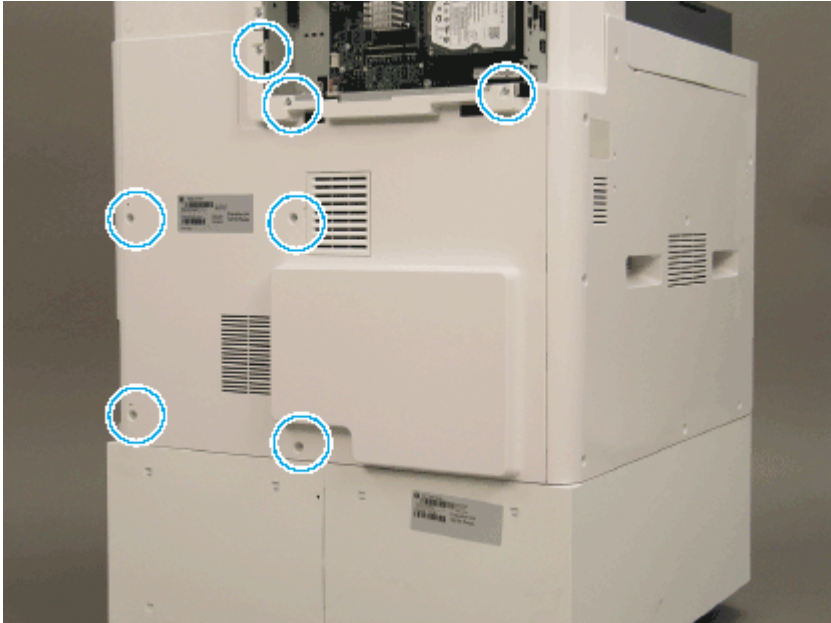


Figure 2-310 Remove the formatter cover



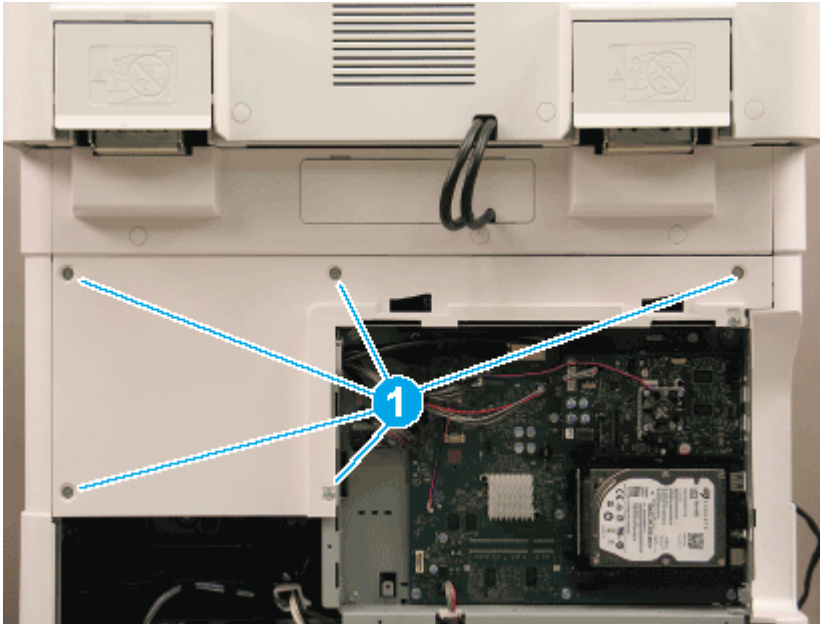
- 2. Remove seven screws, and then remove the rear-bottom cover.

Figure 2-311 Remove the rear-bottom cover



3. Remove six screws (callout 1), and then remove the rear-top cover.

Figure 2-312 Remove the rear-top cover



## Unpack the replacement assembly

Follow these steps to unpack the replacement assembly.

1. Dispose of the defective part.

---



 **NOTE:** HP recommends responsible disposal of the defective part.


<http://www8.hp.com/us/en/hp-information/environment/product-recycling.html>


---

2. Unpack the replacement part from the packaging.

---

 **CAUTION:**  Some parts are sensitive to electrostatic discharge (ESD). Always perform service work at an ESD-protected workstation or mat. If an ESD workstation or mat is not available, touch the sheet-metal chassis to provide a static ground before touching an ESD-sensitive assembly. Protect the ESD-sensitive assemblies by placing them in ESD pouches when they are out of the printer.


 **IMPORTANT:** Make sure that all of the shipping materials (for example shipping tape) are removed from the replacement part prior to installation.

 **NOTE:** If the replacement part is a roller or pad, avoid touching the spongy part of it. Skin oils on the roller or pad can cause paper pickup and/or print-quality problems. HP recommends using disposable gloves when handling rollers or pads or washing your hands before touching rollers or pads.

---

3. To install an assembly, reverse the removal steps.

---

 **NOTE:** When applicable, special installation instructions are provided for an assembly at the end of the removal procedure. Always completely read the removal instructions and follow all special installation instructions.

---

## Removal and replacement: Left cover


This document provides the procedures to remove the left cover assembly.



Mean time to repair: 5 minutes

Service level: Basic

---

 **IMPORTANT:** When applicable, special installation instructions are provided for an assembly at the end of the removal procedure. Always completely read the removal instructions and follow all special installation instructions.

---

### Before performing service

- Disconnect the power cable.

Use the table below to identify the correct part number for your printer. To order the part, go to [www.hp.com/buy/parts](http://www.hp.com/buy/parts)

**Table 2-65 Part information**

Part number	Part description
JC95-02085A	Left cover assembly

### Required tools

- #2 JIS screwdriver with a magnetic tip

### After performing service

#### Turn the printer power on

- Connect the power cable.
- Use the power switch to turn the power on.

### Post service test

No post service tests are required for this assembly.

### Remove the left cover

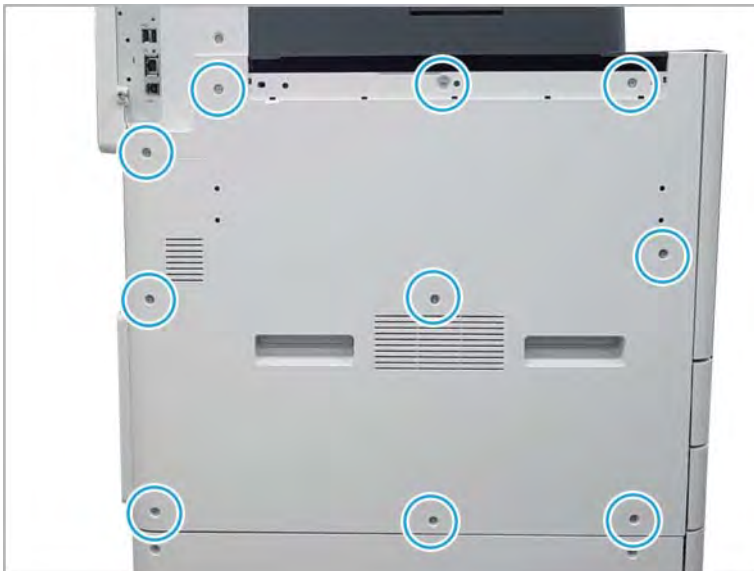
Follow these steps to remove the left cover.

- ▲ Remove the left trim cover, and then remove ten screws to remove the left cover.

Figure 2-313 Remove the left trim cover



Figure 2-314 Remove the left cover



## Unpack the replacement assembly

Follow these steps to unpack the replacement assembly.

1. Dispose of the defective part.



---

 **NOTE:** HP recommends responsible disposal of the defective part.


<http://www8.hp.com/us/en/hp-information/environment/product-recycling.html>

---

2. Unpack the replacement part from the packaging.


 **CAUTION:**  Some parts are sensitive to electrostatic discharge (ESD). Always perform service work at an ESD-protected workstation or mat. If an ESD workstation or mat is not available, touch the sheet-metal chassis to provide a static ground before touching an ESD-sensitive assembly. Protect the ESD-sensitive assemblies by placing them in ESD pouches when they are out of the printer.

 **IMPORTANT:** Make sure that all of the shipping materials (for example shipping tape) are removed from the replacement part prior to installation.

 **NOTE:** If the replacement part is a roller or pad, avoid touching the spongy part of it. Skin oils on the roller or pad can cause paper pickup and/or print-quality problems. HP recommends using disposable gloves when handling rollers or pads or washing your hands before touching rollers or pads.

---

3. To install an assembly, reverse the removal steps.

 **NOTE:** When applicable, special installation instructions are provided for an assembly at the end of the removal procedure. Always completely read the removal instructions and follow all special installation instructions.

---

## Right door

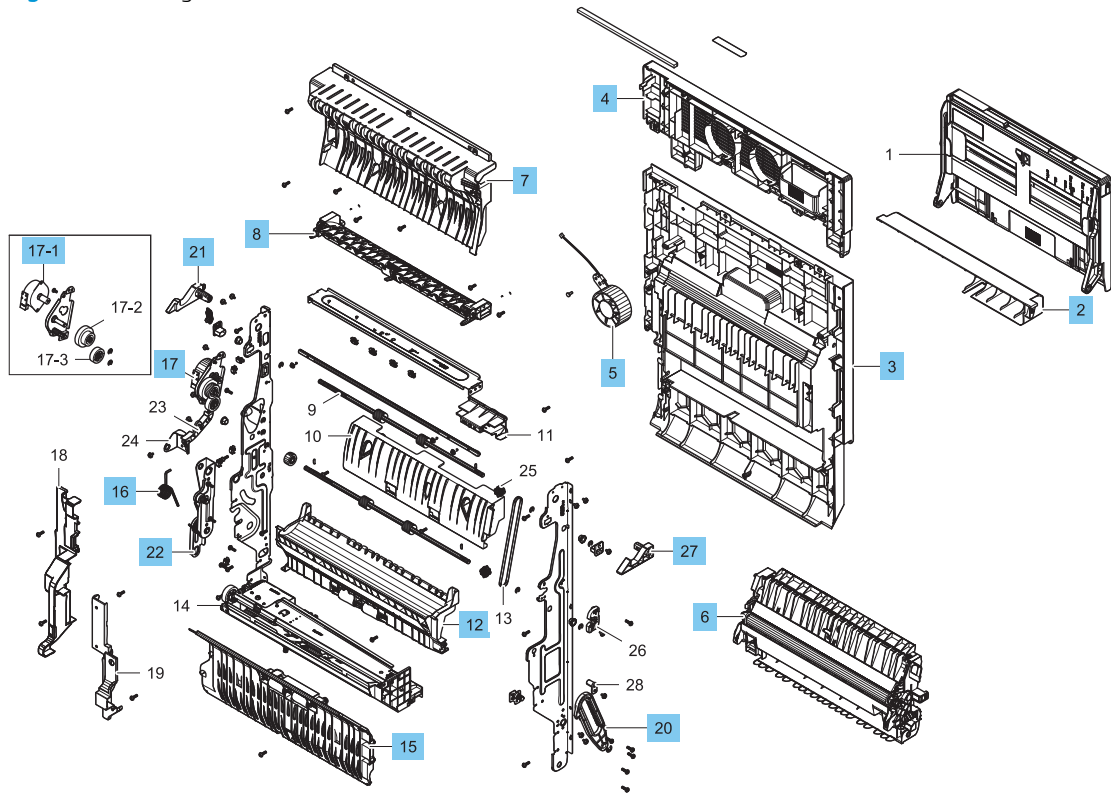
View the right door exploded view, parts list, and repair procedures.



## Right door

Parts diagram and parts list for the right door

Figure 2-315 Right door





**Table 2-66 Right door**

Ref				
No	Part number	Description	Qty	Repair procedure
2	JC63-03356C	Cover, Front Tray 1	1	Not applicable
3	JC63-04570B	Cover, Right door	1	Not applicable
4	JC63-04573B	Cover, Right door Upper (For E77822, E77825, E77830)	1	Not applicable
4	5QJ90-40014	Cover, Right door Upper (For E78323, E78325, E78330)	1	Not applicable
5	JC31-00160C	Fan, type 6	2	Not applicable
6	JC95-02081A	Right Door Feed (For E77822, E77825, E77830)	1	Not applicable
6	JC95-02292A	Right Door Feed (For E78323, E78325, E78330)	1	Not applicable
7	JC61-04795A	Duplex guide, upper (For E77822, E77825, E77830)	1	Not applicable
7	JC95-02292A	Duplex guide, upper (For E78323, E78325, E78330)	1	Not applicable
8	JC95-01509C	Right door, exit (For E77822, E77825, E77830)	1	Not applicable
8	JC90-01877A	Right door, exit (For E78323, E78325, E78330)	1	Not applicable
12	JC95-01517A	Right Door Feed Duplex	1	Not applicable
15	JC95-01516A	Right Door Take Away (For E78323, E78325, E78330)	1	Not applicable
15	JC95-02130A	Right Door Take Away (For E78323, E78325, E78330)	1	Not applicable
16	6107-003052	Spring, TS	1	Not applicable
17	JC95-01510A	Motor Right Door Duplex	1	Not applicable
17-1	JC93-00802A	Drive motor, step	1	Not applicable
20	JC66-03235A	Right Door Dampner	1	Not applicable
21	JC64-00711A	Right Rear Lock	1	Not applicable
22	JC95-02256A	Right door link rear	1	Not applicable
27	JC64-00710A	Right Door Lock	1	Not applicable
Not shown	JC63-05750A	Sensor, sheet	1	Not applicable

## Tray 1

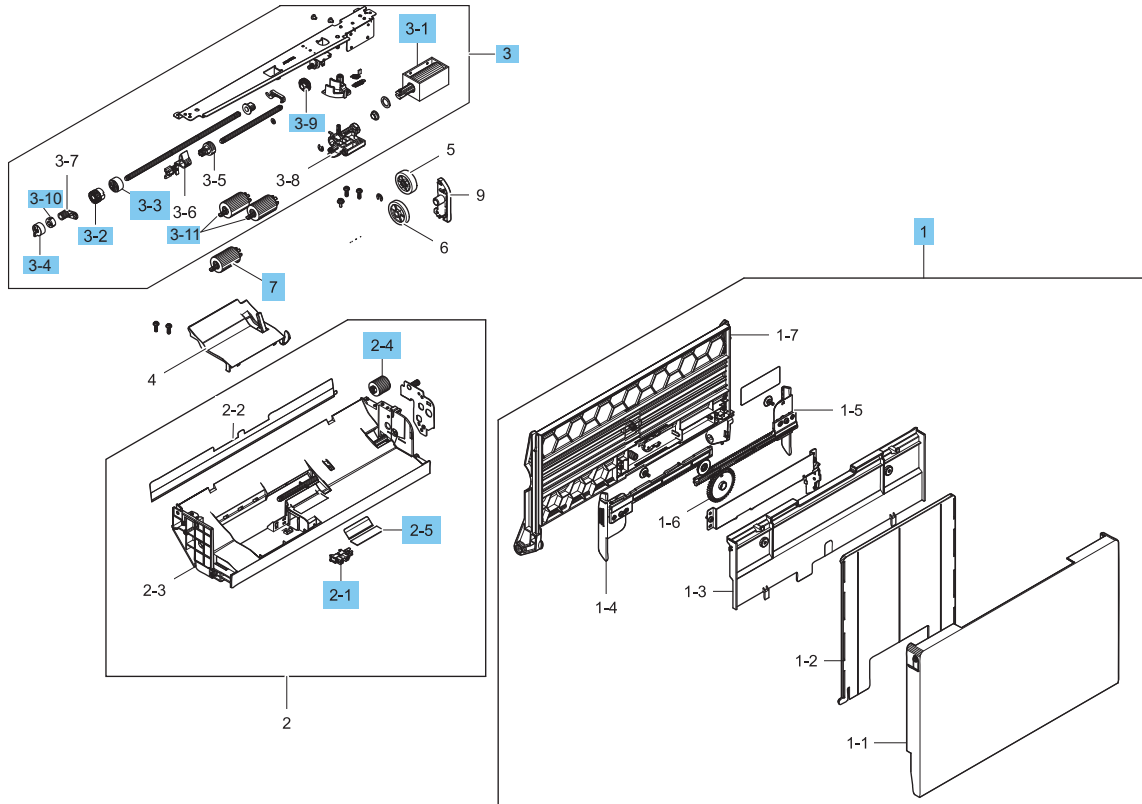
View the tray 1 exploded view, parts list, and repair procedures.



# Tray 1 rollers

Parts diagram and parts list for Tray 1 rollers.

Figure 2-316 Tray 1



**Table 2-67** Tray 1 rollers


Ref				
No	Part number	Description	Qty	Repair procedure
1	JC90-01778A	Tray 1 Door	1	<a href="#">Removal and replacement: Tray 1 unit and Tray 1 assemblies on page 452</a>
2-1	0604-001393	Photo interrupter	1	Not applicable
2-4	JC67-00455A	Coupler, Torque Limiter	1	Not applicable
2-5	JC62-01085A	Seal, pad tray 1	3	Not applicable
3	JC90-01125B	Tray1 bracket pickup	1	Not applicable
3-1	JC33-00029B	Solenoid, tray 1	1	<a href="#">Removal and replacement: Tray 1 unit and Tray 1 assemblies on page 452</a>
3-2	JC90-00918A	MP one way clutch	1	Not applicable
3-3	JC66-00977A	Clutch, one way	2	Not applicable
3-4	JC61-01288A	Holder-M_idle one way	1	Not applicable
3-9	JC66-00940A	Gear-M_idle PU	1	Not applicable
3-10	JC66-00977A	Clutch-P_one way	1	Not applicable
3-11	JC93-00540B	Frame-main pickup roller	2	<a href="#">Removal and replacement: Tray 1 rollers on page 448</a>
7	X3A92-67918	Tray 1 roller (kit)		<a href="#">Removal and replacement: Tray 1 rollers on page 448</a>
Not shown	JC95-02079A	Right door assembly (For E77822, E77825, E77830)	1	<a href="#">Removal and replacement: Tray 1 unit and Tray 1 assemblies on page 452</a>
Not shown	8GR88-60101	Right door assembly (For E78323, E78325, E78330)	1	<a href="#">Removal and replacement: Tray 1 unit and Tray 1 assemblies on page 452</a>

## Removal and replacement: Tray 1 rollers

This document provides the procedures to remove the Tray 1 rollers.

Mean time to repair: 6 minutes

Service level: Basic

 **IMPORTANT:** When applicable, special installation instructions are provided for an assembly at the end of the removal procedure. Always completely read the removal instructions and follow all special installation instructions.

### Before performing service

- Disconnect the power cable.

Use the table below to identify the correct part number for your printer. To order the part, go to [www.hp.com/buy/parts](http://www.hp.com/buy/parts)

**Table 2-68** Part information

Part number	Part description
JC93-00540B	Kit-HP LaserJet MP Roller

### Required tools

- #2 JIS screwdriver with a magnetic tip
- Small flat-blade screwdriver

### After performing service

#### Turn the printer power on

- Connect the power cable.
- Use the power switch to turn the power on.

### Post service test

Copy, scan, or print a document. Verify the document copies, scans, or prints correctly.

## Remove the Tray 1 pick/reverse/feed roller

Follow these steps to remove the Tray 1 rollers.

1. Open Tray 1. Use a small flat blade screwdriver to release the tab on the right side of the cover

 **NOTE:** The plastic tabs on the edges of the cover might require extra pressure to remove.

Figure 2-317 Remove the cover

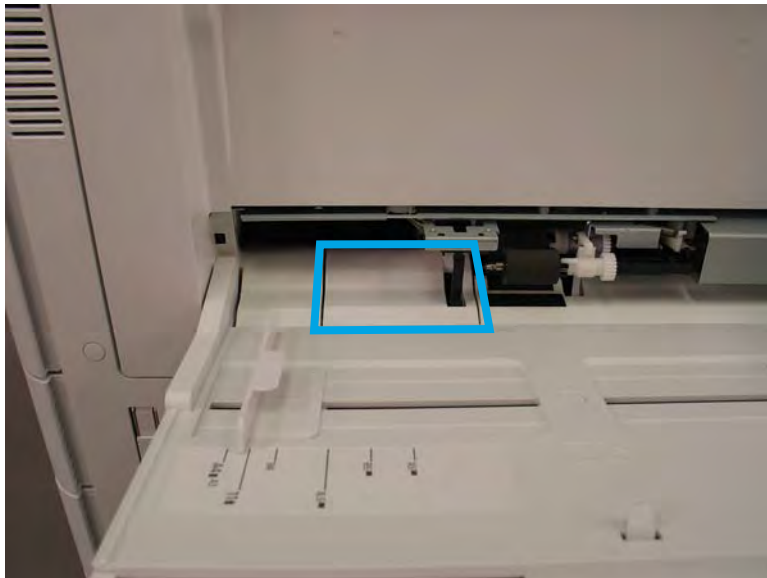


2. Remove the cover shown using a small flat blade screwdriver to release the tab on the right side of the cover.



**NOTE:** The flag, it will need to be moved out of the way to remove cover.

Figure 2-318 Remove the cover

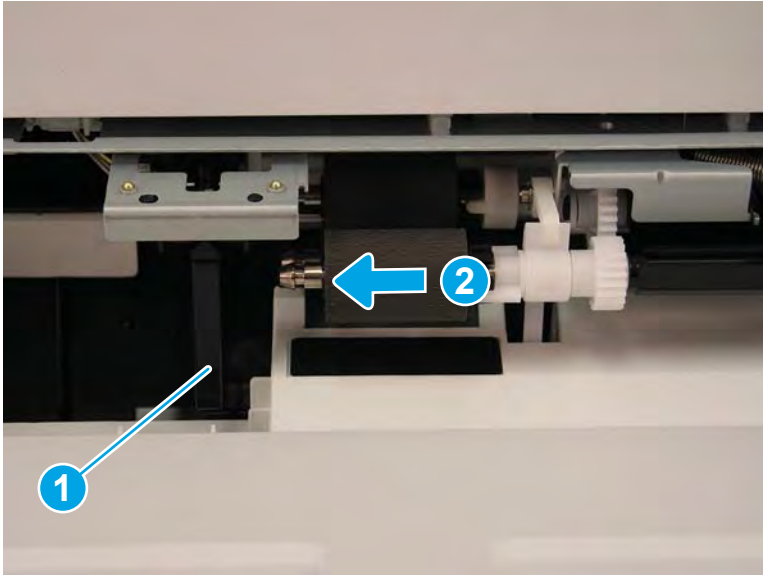


3. Release the small tab and remove the Tray 1 pick/reverse/feed roller (callout 2). Move the flag (callout 1) out of the way to release rollers.

**CAUTION:** Remove the rollers slowly to avoid loosening the parts behind the rollers. If these parts come loose, they might fall into the printer and be difficult to retrieve. Note the location of all components.

**NOTE:** HP recommends replacing all three rollers at the same time.

**Figure 2-319** Remove the Tray 1 pick/reverse/feed roller



4. After the replacement rollers are installed, follow these instructions to reset the firmware counter:
  - a. From the Home screen on the printer control panel, select the [Support Tools](#) menu.
  - b. Select the [Service](#) menu.
  - c. Make sure that [Service Access Code](#) is selected in the drop-down menu, and then enter the service access code.
  - d. Select the [Service Tools](#) menu.
  - e. Select the [Supply Status](#) menu.
  - f. Select [Field Replacement Unit](#).
  - g. Select [Tray X Rollers](#).
  - h. Select [Tray 1 Roller Kit](#).
  - i. Select [Reset](#).

## Unpack the replacement assembly

Follow these steps to unpack the replacement assembly.

1. Dispose of the defective part.





---

 **NOTE:** HP recommends responsible disposal of the defective part.


<http://www8.hp.com/us/en/hp-information/environment/product-recycling.html>

---

2. Unpack the replacement part from the packaging.


 **CAUTION:**  Some parts are sensitive to electrostatic discharge (ESD). Always perform service work at an ESD-protected workstation or mat. If an ESD workstation or mat is not available, touch the sheet-metal chassis to provide a static ground before touching an ESD-sensitive assembly. Protect the ESD-sensitive assemblies by placing them in ESD pouches when they are out of the printer.

 **IMPORTANT:** Make sure that all of the shipping materials (for example shipping tape) are removed from the replacement part prior to installation.

 **NOTE:** If the replacement part is a roller or pad, avoid touching the spongy part of it. Skin oils on the roller or pad can cause paper pickup and/or print-quality problems. HP recommends using disposable gloves when handling rollers or pads or washing your hands before touching rollers or pads.

---

3. To install an assembly, reverse the removal steps.

 **NOTE:** When applicable, special installation instructions are provided for an assembly at the end of the removal procedure. Always completely read the removal instructions and follow all special installation instructions.


---

## Removal and replacement: Tray 1 unit and Tray 1 assemblies

This document provides the procedures to remove the Tray 1 assembly.

Mean time to repair: 15 minutes

Service level: Intermediate

 **IMPORTANT:** When applicable, special installation instructions are provided for an assembly at the end of the removal procedure. Always completely read the removal instructions and follow all special installation instructions.

### Before performing service

- Disconnect the power cable.

Use the table below to identify the correct part number for your printer. To order the part, go to [www.hp.com/buy/parts](http://www.hp.com/buy/parts)

**Table 2-69** Part information

Part numbers	Part descriptions
JC95-02079A	Right door assembly (E778xx series)
8GR88-60101	Right door assembly (E783xx series)
JC90-01778A	Tray 1
JC95-02081A	Right door feed (E778xx series)
JC95-02292A	Right door feed (E783xx series)
JC33-00029B	Solenoid Tray 1

### Required tools

- #2 JIS screwdriver with a magnetic tip
- Small flat-blade screwdriver

### After performing service

#### Turn the printer power on

- Connect the power cable.
- Use the power switch to turn the power on.

### Post service test

Copy, scan, or print a document. Verify the document copies, scans, or prints correctly.

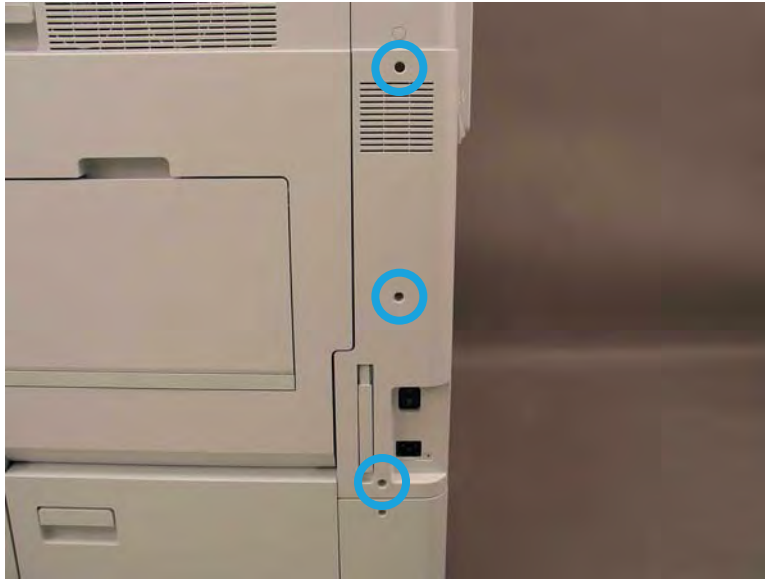
## Remove the right door

Follow these steps to remove the right door.

 **NOTE:** Remove second exit drive if installed.

1. Remove three screws, and then remove the cover (A).

Figure 2-320 Remove cover



2. Disconnect the right door connector.

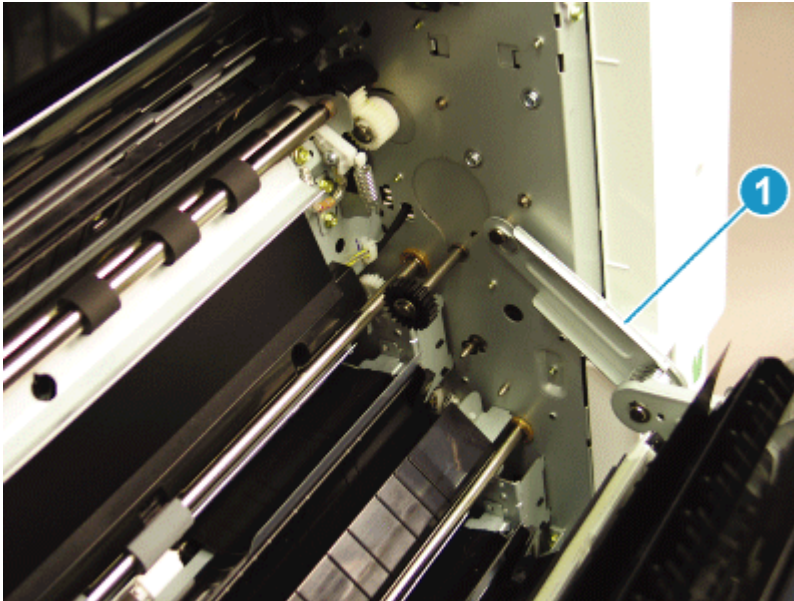
Figure 2-321 Disconnect right door connector



3. Release the right hinge (callout 1).

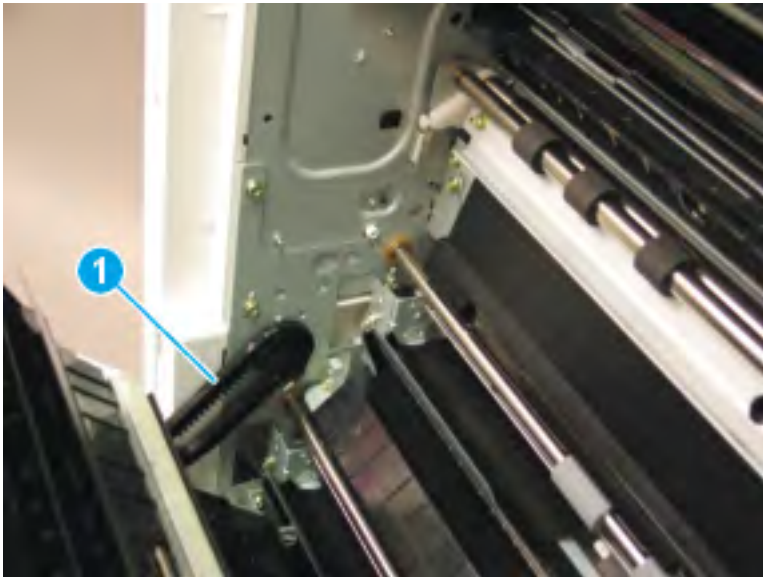
**⚠ CAUTION:** The right hinge spring tension can be dangerous. Use caution when releasing the right hinge to avoid injury.

Figure 2-322 Release right hinge



4. Release the left dampener (callout 1).

Figure 2-323 Release left dampener



5. Remove the right door.


 **NOTE:** Open the lower access door. If there is an HCI or 2x520 input device, release the dampener to clear the lower right door. Remove clockwise.

Figure 2-324 Remove right door

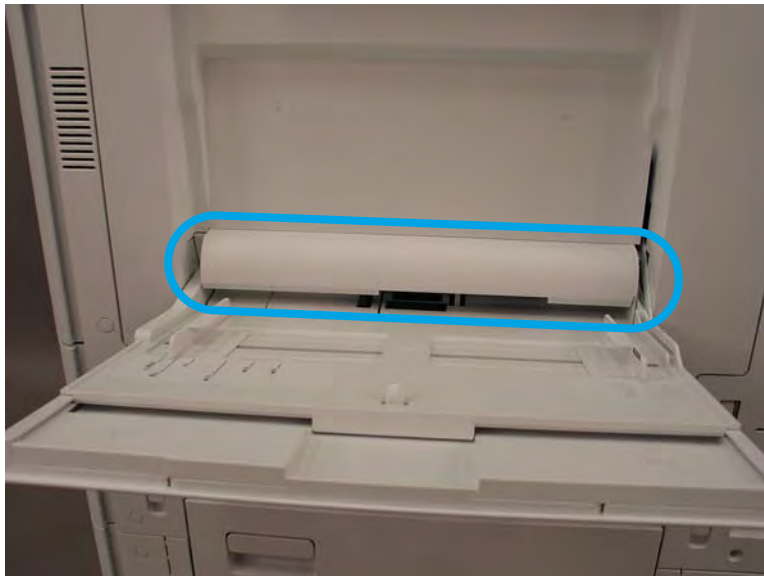


## Remove the multipurpose unit and MP assemblies

Follow these steps to remove the multipurpose unit and MP assemblies.

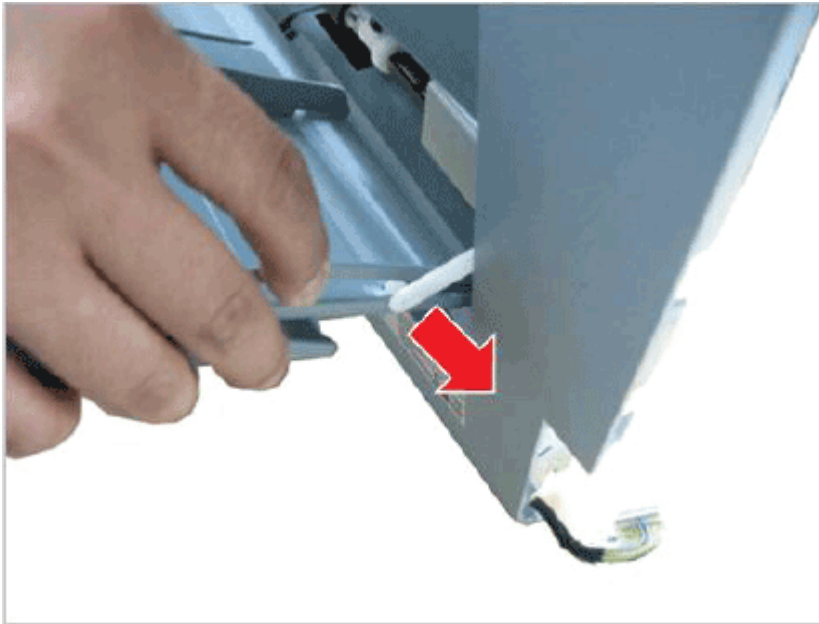
1. Open the MP tray and remove the MP roller cover. Release tabs at back of the roller cover and rotate to release.

Figure 2-325 Remove MP front cover



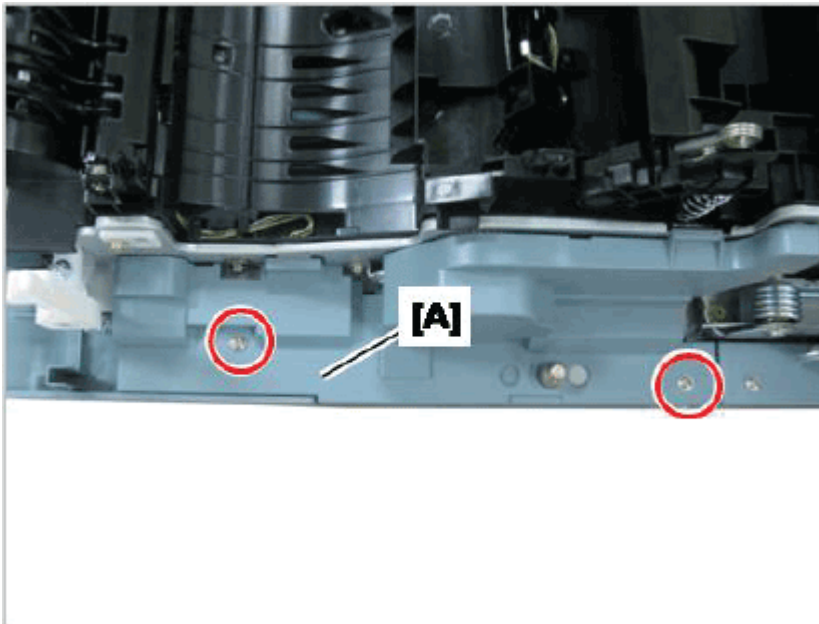
2. Open the MP tray and release the hinge from the right, flexing the linker to remove.

Figure 2-326 Open MP tray and release link



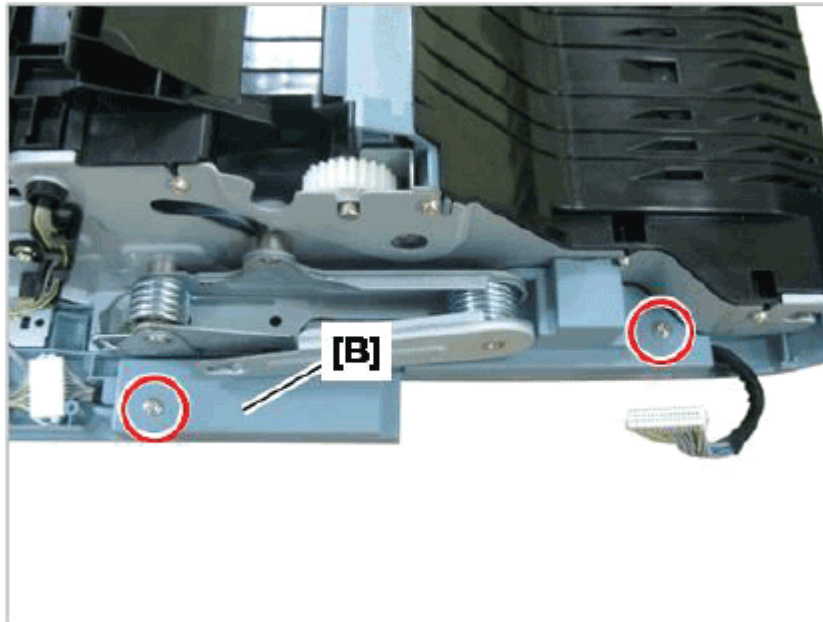
3. Remove two screws and then remove the cable cover.

Figure 2-327 Remove screws and cable cover



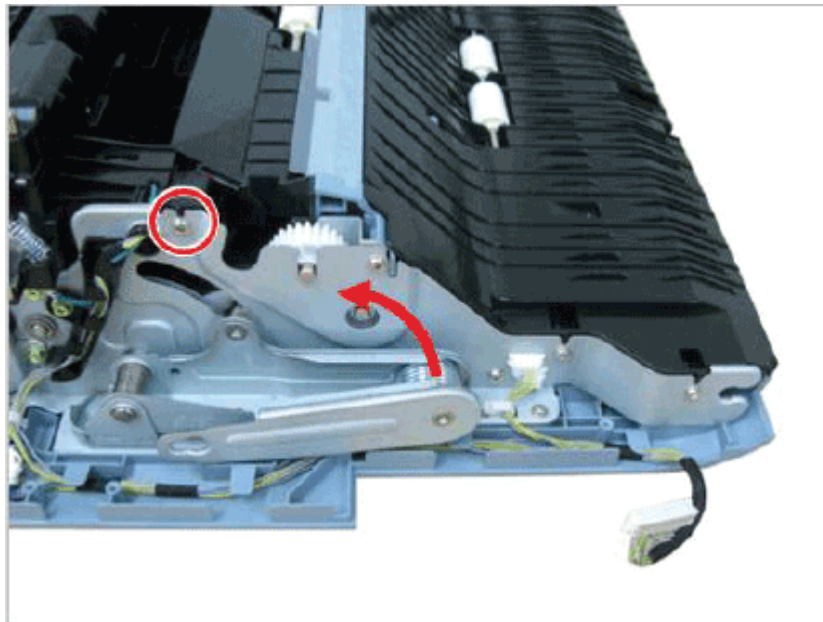
4. Remove three screws and then remove the cable cover lower.

Figure 2-328 Remove screws and cable cover lower



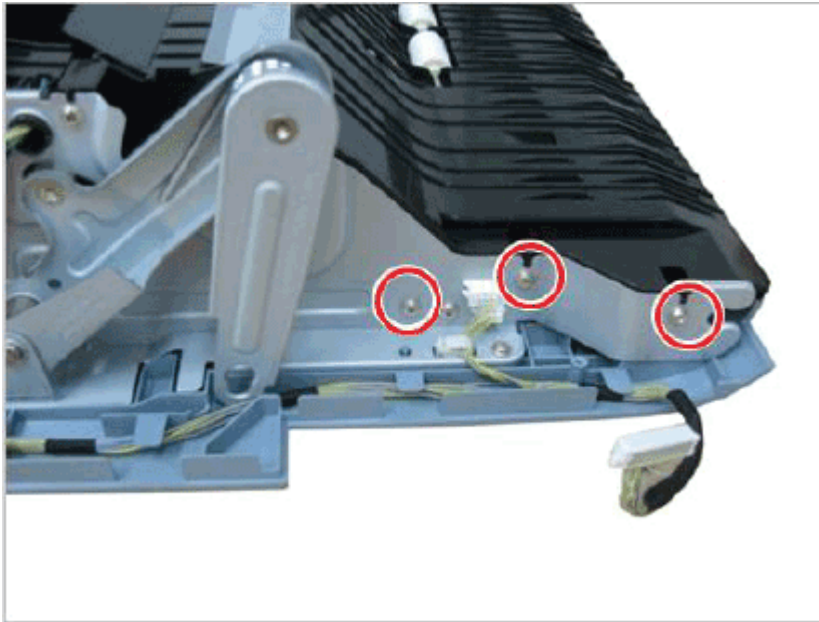
5. Remove one screw. Prop up the hinge on the door edge to keep it out of the way.

Figure 2-329 Remove screw and prop up hinge



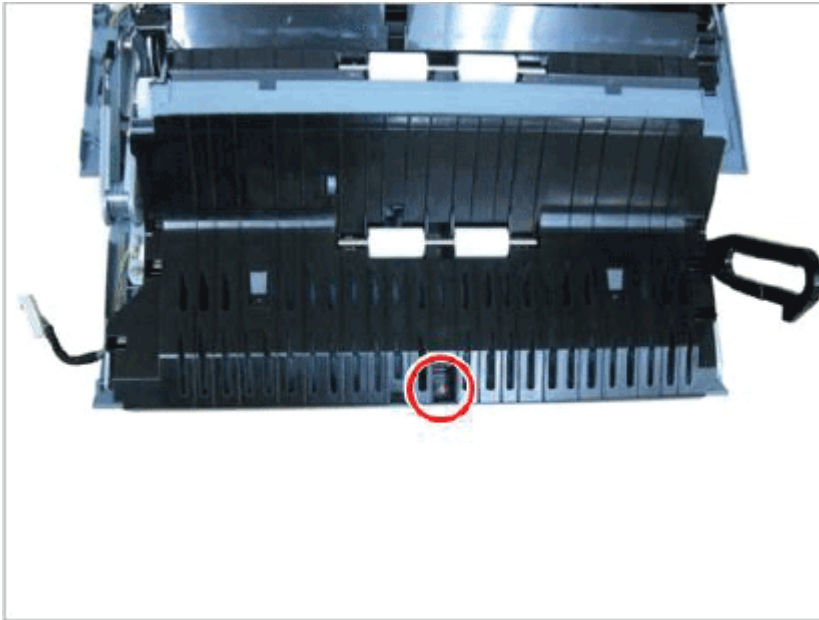
6. Remove three screws.

Figure 2-330 Remove screws



7. Remove one screw.

Figure 2-331 Remove screw





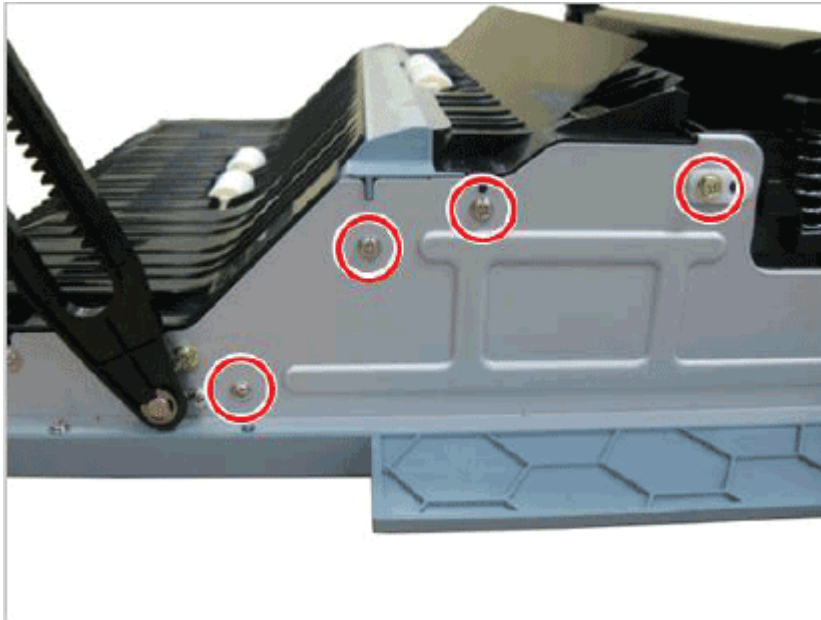
8. Remove two screws from the other side of the door.

Figure 2-332 Remove screws



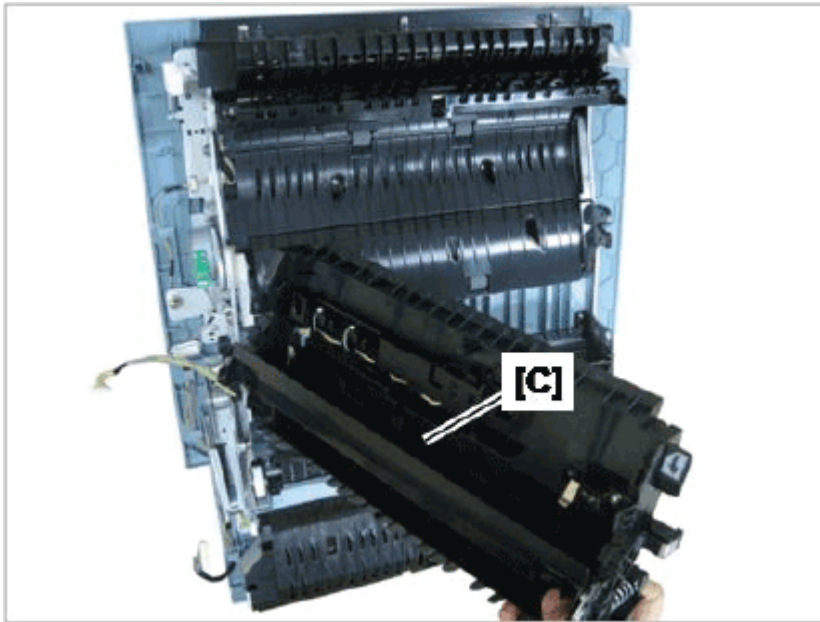
9. Remove four screws.

Figure 2-333 Remove screws



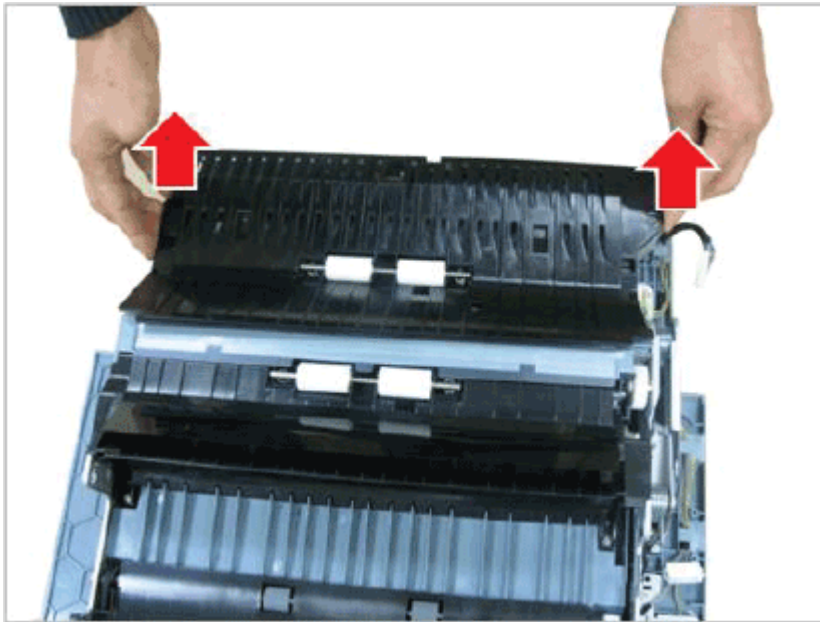
10. Swing out the guide feed (C) to the right. Remove the hinge pin from the front.

Figure 2-334 Remove hinge pin



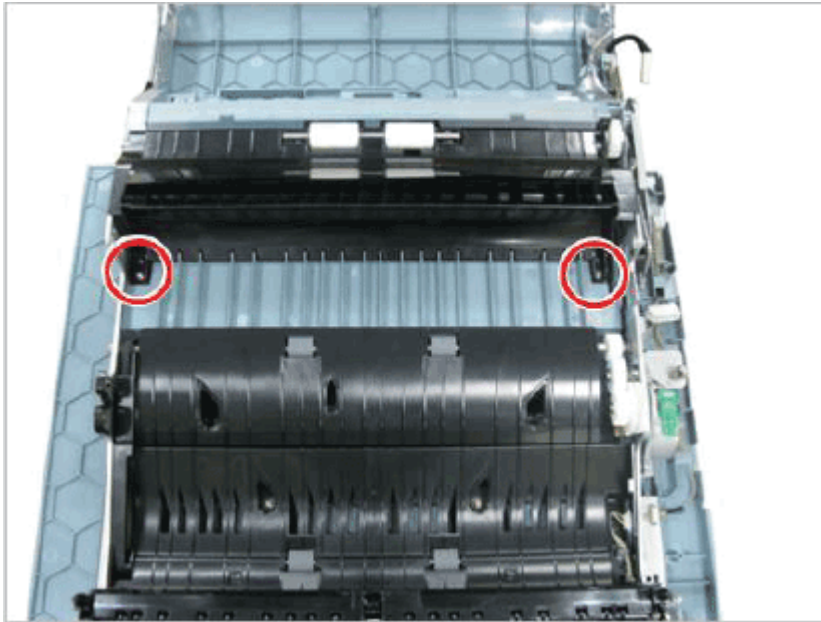
11. Gently lift up the right door.

Figure 2-335 Lift right door duplex lower



12. Remove two screws.

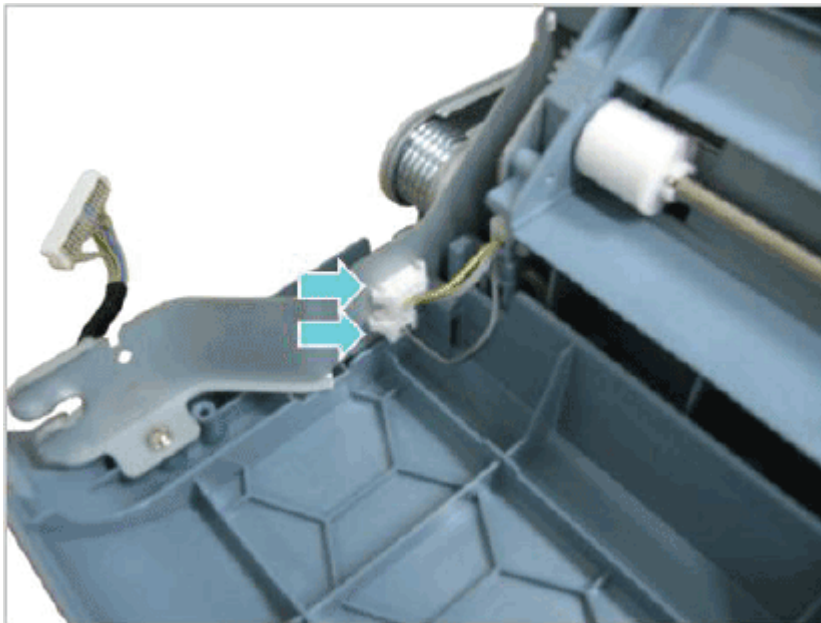
Figure 2-336 Remove screws



13. Disconnect three connectors near the hinge.

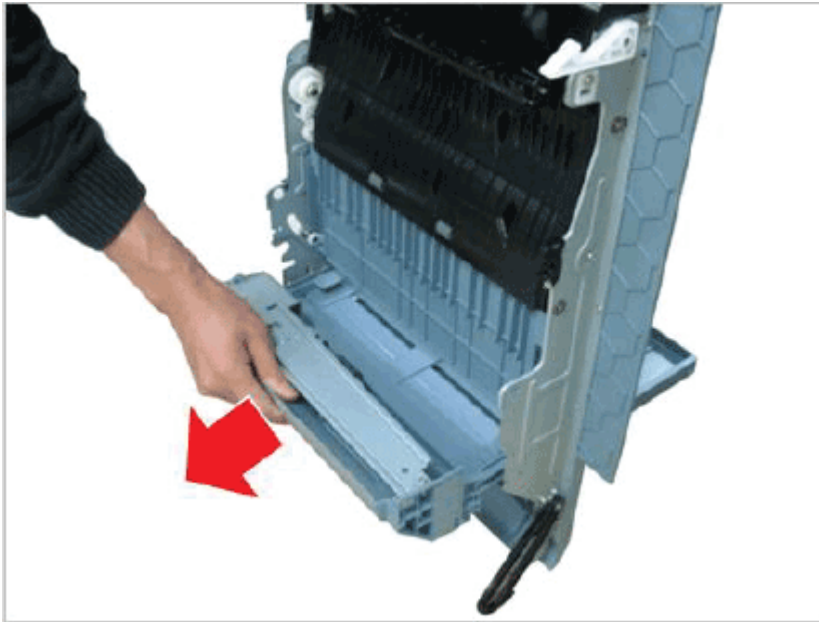
 **IMPORTANT:** Make sure the connector couplers stay attached to the door.

Figure 2-337 Disconnect connectors



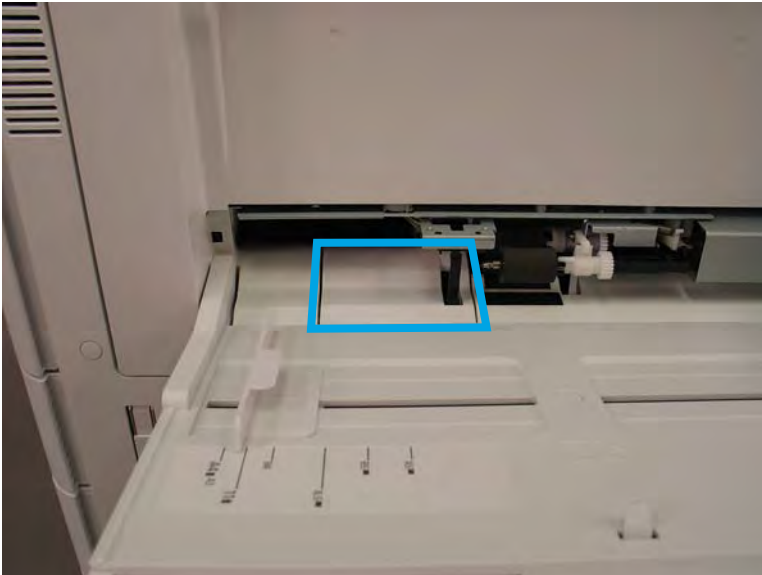
14. Remove one screw, and then remove the MP unit.

Figure 2-338 Remove screw and MP unit



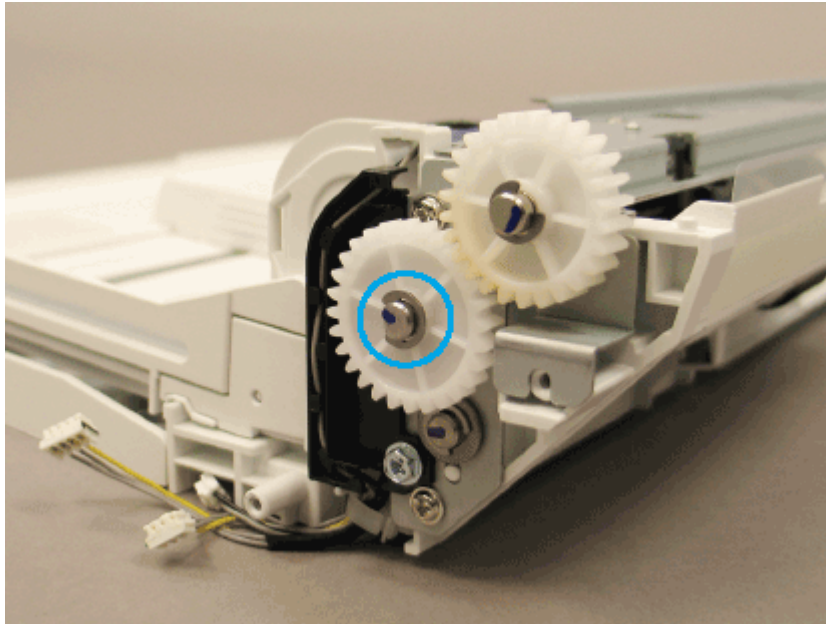
15. Remove the MP-cover base.

Figure 2-339 Remove MP-cover base



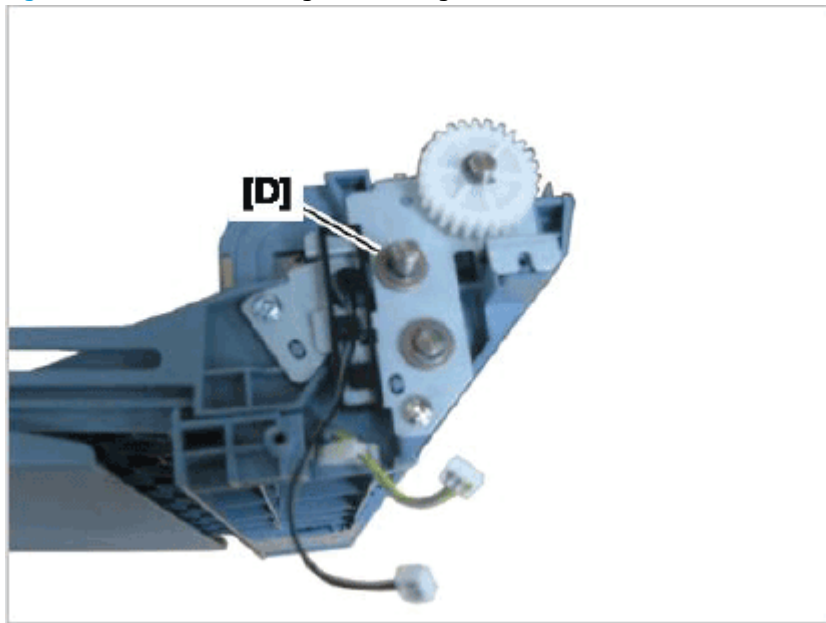
16. Remove the E-ring, and then remove the gear (C).

Figure 2-340 Remove e-ring and gear



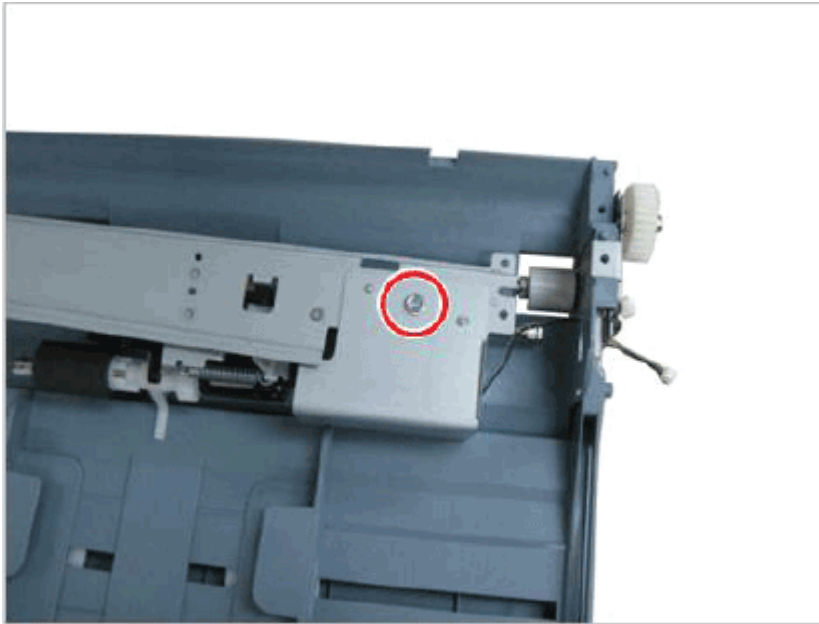
17. Remove the E-ring, and then remove the bushing (D).


Figure 2-341 Remove e-ring and bushing



18. Remove one screw, and then remove the Bracket-Solenoid.

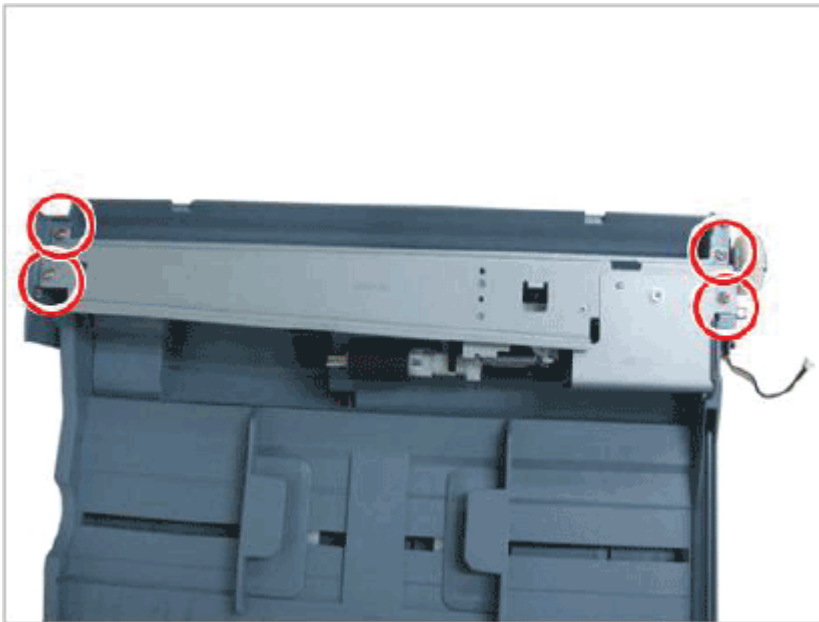
Figure 2-342 Remove screw and bracket-solenoid



 **NOTE:** Reinstallation note: Route the cable before putting the cover back on during reinstallation.

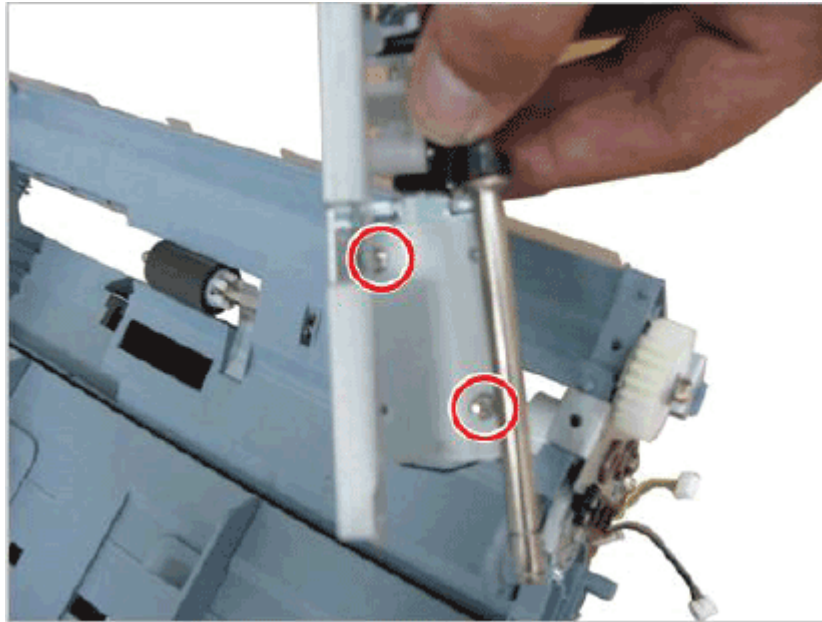
19. Remove four screws, and then release the MP bracket pickup. Release the cable from the cable harness.

Figure 2-343 Release MP bracket pickup and release cable from harness



20. Release the cable from the cable retainer, and release the cable from the cable harness. Remove two screws, and then remove the MP solenoid.

Figure 2-344 Release cable and remove MP solenoid



**NOTE:** Reinstallation note: When reinstalling, the paper stopper needs to be located in the appropriate slot in the housing.

## Unpack the replacement assembly


Follow these steps to unpack the replacement assembly.

1. Dispose of the defective part.

**NOTE:** HP recommends responsible disposal of the defective part.

<http://www8.hp.com/us/en/hp-information/environment/product-recycling.html>

2. Unpack the replacement part from the packaging.


**CAUTION:**  Some parts are sensitive to electrostatic discharge (ESD). Always perform service work at an ESD-protected workstation or mat. If an ESD workstation or mat is not available, touch the sheet-metal chassis to provide a static ground before touching an ESD-sensitive assembly. Protect the ESD-sensitive assemblies by placing them in ESD pouches when they are out of the printer.

**IMPORTANT:** Make sure that all of the shipping materials (for example shipping tape) are removed from the replacement part prior to installation.

**NOTE:** If the replacement part is a roller or pad, avoid touching the spongy part of it. Skin oils on the roller or pad can cause paper pickup and/or print-quality problems. HP recommends using disposable gloves when handling rollers or pads or washing your hands before touching rollers or pads.

3. To install an assembly, reverse the removal steps.

---

 **NOTE:** When applicable, special installation instructions are provided for an assembly at the end of the removal procedure. Always completely read the removal instructions and follow all special installation instructions.

---



## Right door output

View the right door output exploded view, parts list, and repair procedures.

## Right door output

Parts diagram and parts list for the right door output.

Figure 2-345 Right door output

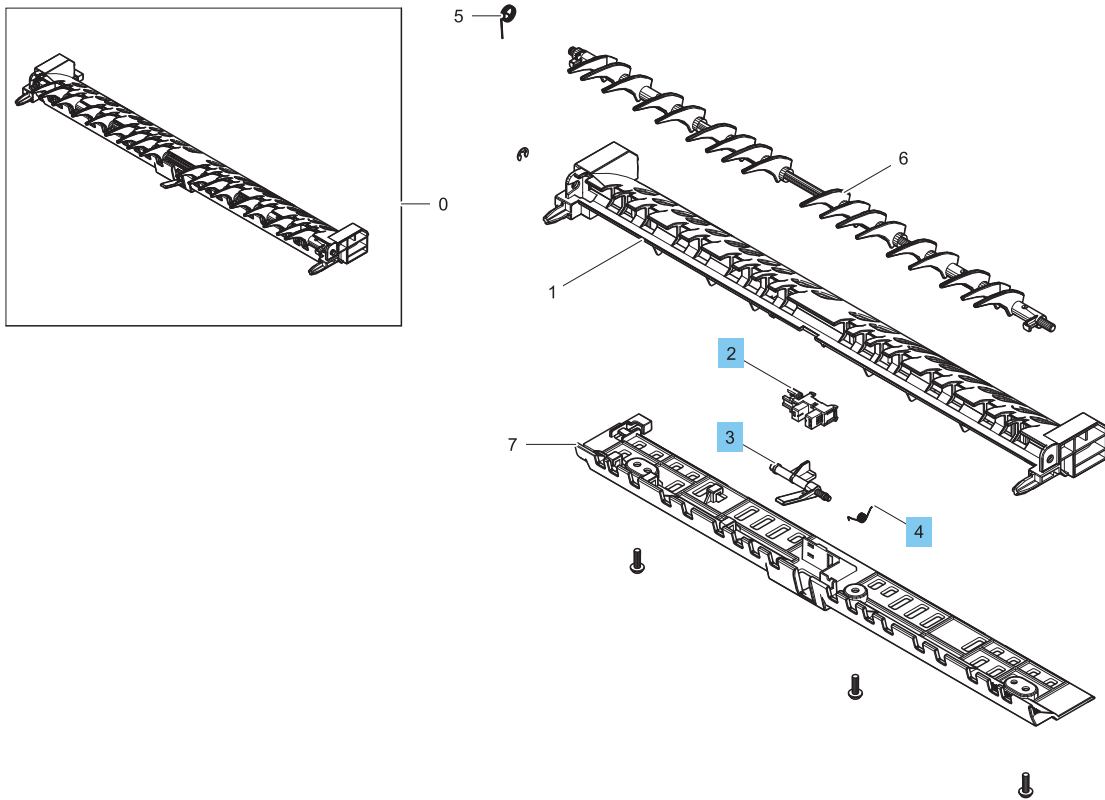


Table 2-70 Right door output

Ref				
No	Part number	Description	Qty	Repair procedure
2	0604-001393	Photo interrupter	1	Not applicable
3	JC66-03307A	Actuator, fuser out	1	Not applicable
4	6107-001737	Spring, TS	1	Not applicable

## Right door feed guide

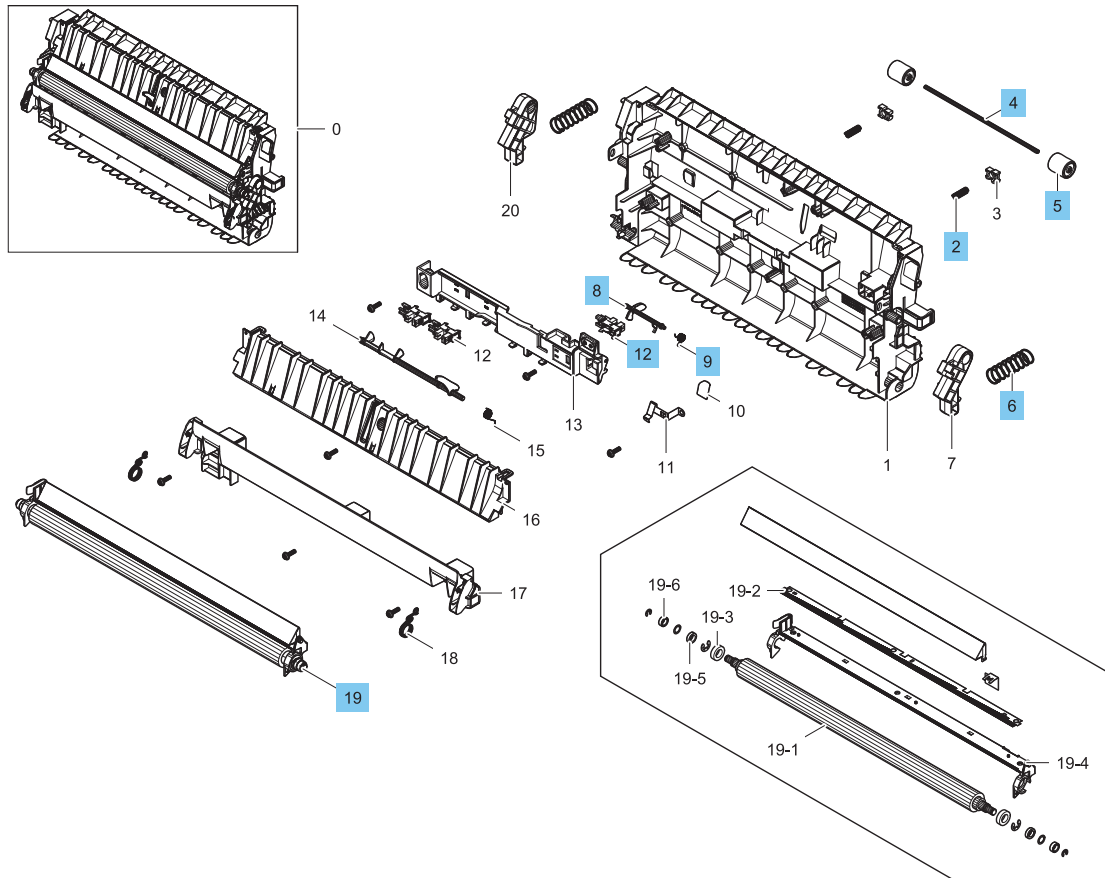
View the right door feed guide exploded view, parts list, and repair procedures.



## Right door feed guide

Parts diagram and parts list for the right door feed guide.

Figure 2-346 Right door feed guide



**Table 2-71 Right door feed guide**

Ref				
No	Part number	Description	Qty	Repair procedure
2	6107-001731	Spring, CS	2	Not applicable
4	JC66-02354A	Roller shaft	1	Not applicable
5	JC66-02289B	Idle roller	2	Not applicable
6	6107-003048	Spring, cs	2	Not applicable
8	JC66-02180A	Actuator, duplex 2	1	Not applicable
9	6107-001737	Spring, TS	1	Not applicable
12	0604-001393	Photo interrupter	1	Not applicable
19	JC95-01942A	HP LaserJet Transfer Roller (T2) (For 77822, 77825, 77830)	1	<a href="#">Removal and replacement: HP LaserJet Transfer Roller (T2) on page 474</a>
19	5QJ90-61041	HP LaserJet Transfer Roller (T2) (For 78323, 78325, 78330)	1	<a href="#">Removal and replacement: HP LaserJet Transfer Roller (T2) on page 474</a>


## Removal and replacement: HP LaserJet Transfer Roller (T2)

This document provides the procedures to remove the HP LaserJet Transfer Roller (T2).

 [View a video of removing the HP LaserJet Transfer Roller \(T2\).](#)

Mean time to repair: 15 minutes

Service level: Intermediate

 **IMPORTANT:** When applicable, special installation instructions are provided for an assembly at the end of the removal procedure. Always completely read the removal instructions and follow all special installation instructions.

### Before performing service

- Disconnect the power cable.

Use the table below to identify the correct part number for your printer. To order the part, go to [www.hp.com/buy/parts](http://www.hp.com/buy/parts)

**Table 2-72 Part information**

Part number	Part description
JC95-01942A	HP LaserJet Transfer Roller (T2) (E778xx series)
5QJ90-61041	HP LaserJet Transfer Roller (T2) (E783xx series)

### Required tools

- #2 JIS screwdriver with a magnetic tip

### After performing service

#### Turn the printer power on

- Connect the power cable.
- Use the power switch to turn the power on.

### Post service test

Copy, scan, or print a document. Verify the document copies, scans, or prints correctly.

## Remove the HP LaserJet Transfer Roller (T2)

Follow these steps to remove the HP LaserJet Transfer Roller (T2).

1. Open the right door.



2. Hold and release both sides of the HP LaserJet Transfer Roller (T2) to remove.

**Figure 2-347** Remove HP LaserJet Transfer Roller (T2)



## Unpack the replacement assembly

Follow these steps to unpack the replacement assembly.

1. Dispose of the defective part.

---



 **NOTE:** HP recommends responsible disposal of the defective part.


<http://www8.hp.com/us/en/hp-information/environment/product-recycling.html>


---

2. Unpack the replacement part from the packaging.

---

 **CAUTION:**  Some parts are sensitive to electrostatic discharge (ESD). Always perform service work at an ESD-protected workstation or mat. If an ESD workstation or mat is not available, touch the sheet-metal chassis to provide a static ground before touching an ESD-sensitive assembly. Protect the ESD-sensitive assemblies by placing them in ESD pouches when they are out of the printer.


 **IMPORTANT:** Make sure that all of the shipping materials (for example shipping tape) are removed from the replacement part prior to installation.

 **NOTE:** If the replacement part is a roller or pad, avoid touching the spongy part of it. Skin oils on the roller or pad can cause paper pickup and/or print-quality problems. HP recommends using disposable gloves when handling rollers or pads or washing your hands before touching rollers or pads.

---

3. To install an assembly, reverse the removal steps.

---

 **NOTE:** When applicable, special installation instructions are provided for an assembly at the end of the removal procedure. Always completely read the removal instructions and follow all special installation instructions.

---

## ADF (LX models)

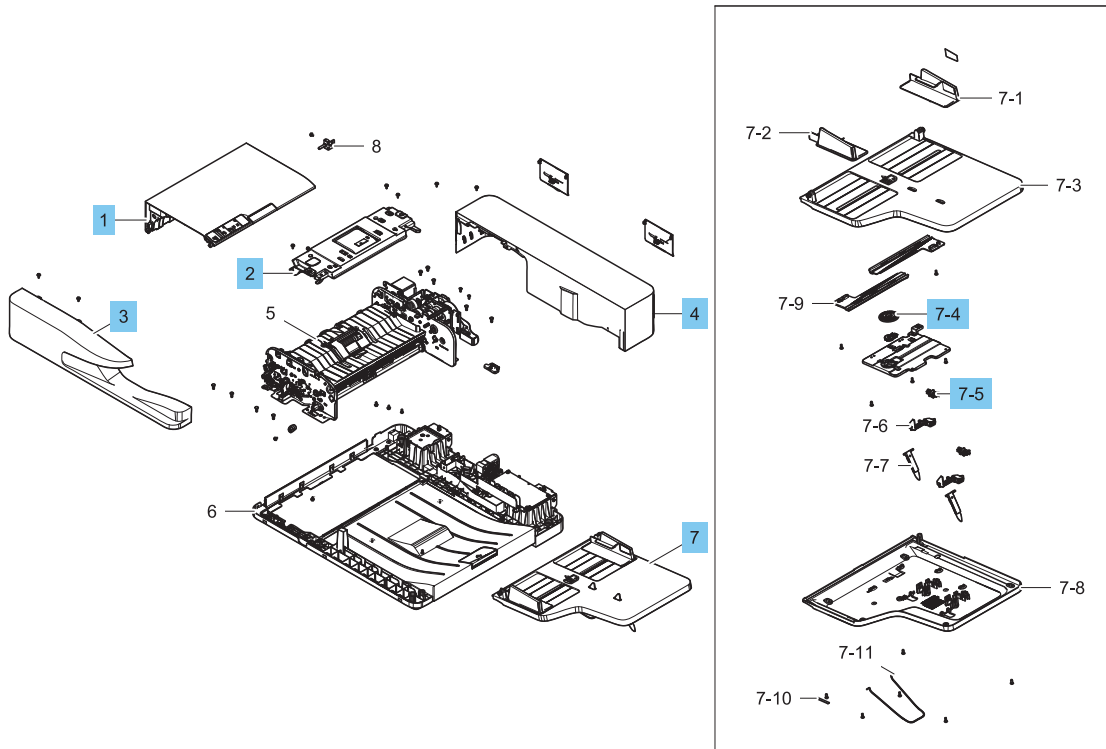
View the ADF (LX models) exploded view, parts list, and repair procedures.



## ADF (LX models)

Parts diagram and parts list for the ADF (LX models).

Figure 2-348 ADF (LX models)



**Table 2-73 ADF (LX models)**


Ref				
No	Part number	Description	Qty	Repair procedure
1	JC97-04853A	ADF cover open (LX)	1	<a href="#">Removal and replacement: Document feeder (ADF) jam access cover (LX) on page 480</a>
2	JC97-04856B	ADF pickup (LX)	1	Not applicable
3	JC63-05563A	ADF, front cover (LX)	1	Not applicable
4	JC63-05561A	ADF, cover rear (LX)	1	Not applicable
7	JC97-04859A	ADF stacker (LX) (For E77822, E77825, E77830)	1	<a href="#">Removal and replacement: Document feeder (ADF) input tray (LX) on page 484</a>
7	X3A84-60103	ADF stacker (LX) (For E78323, E78325, E78330)	1	<a href="#">Removal and replacement: Document feeder (ADF) input tray (LX) on page 484</a>
7-4	JC66-04079A	ADF pinion gear (LX)	1	Not applicable
7-5	0604-001393	Photo interrupter	1	Not applicable

## Removal and replacement: Removal and replacement: Document feeder (ADF) jam access cover (LX)

Learn how to remove and replace the document feeder jam access cover (LX).

To view a short video of this procedure, click the link below.

 [View a video of how to remove and replace the document feeder jam access cover \(LX\).](#)

 **IMPORTANT:** When applicable, special installation instructions are provided for an assembly at the end of the removal procedure. Always completely read the removal instructions and follow all special installation instructions.


Mean time to repair:

Service level:

### Before performing service

#### Turn the printer power off

- Press the power button on the front of the printer, and then turn off the power switch next to the power cable.
- A shutting-down message appears on the control-panel display.

 **WARNING!** To avoid damage to the printer, turn the power off and wait until the printer shuts down before removing the power cable.

- Disconnect the printer power cable after the printer has completely shut down (the control-panel display is blank).

Use the table below to identify the correct part number for your printer. To order the part, go to [www.hp.com/buy/parts](http://www.hp.com/buy/parts).

Table 2-74 Part information

Part number	Part description
JC97-04853A	Jam access cover (LX)

### Required tools

- #2 JIS screwdriver with a magnetic tip

### After performing service

#### Turn the printer power on

- Connect the printer power cable.
- Turn on the power switch next to the power cable, and then press the power button on the front of the printer.
- Verify that the service performed was successful.

- Verify that the most recent firmware is installed on the printer.
- Verify that all parts are correctly reinstalled and are properly working.

### Post service test

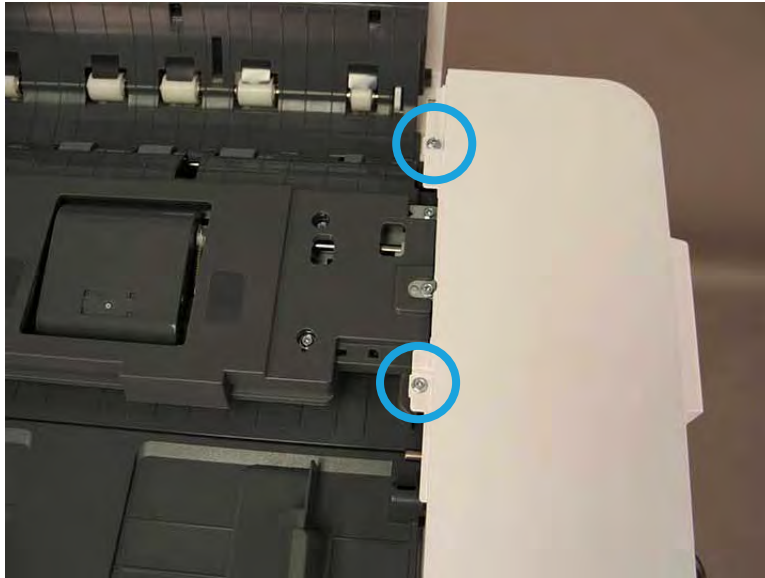
Print any pages necessary to verify that the repair resolved the issue and did not create any new issues.

### Remove the document feeder (ADF) back cover

Follow these steps to remove the document feeder (ADF) back cover.

1. Remove two screws from the top of document feeder back cover.

**Figure 2-349** Remove the document feeder back cover top screws



2. Remove 3 caps and 3 screws.

**Figure 2-350** Remove 3 caps and 3 screws.



3. Release the top back cover.

**Figure 2-351** Release the top back cover.

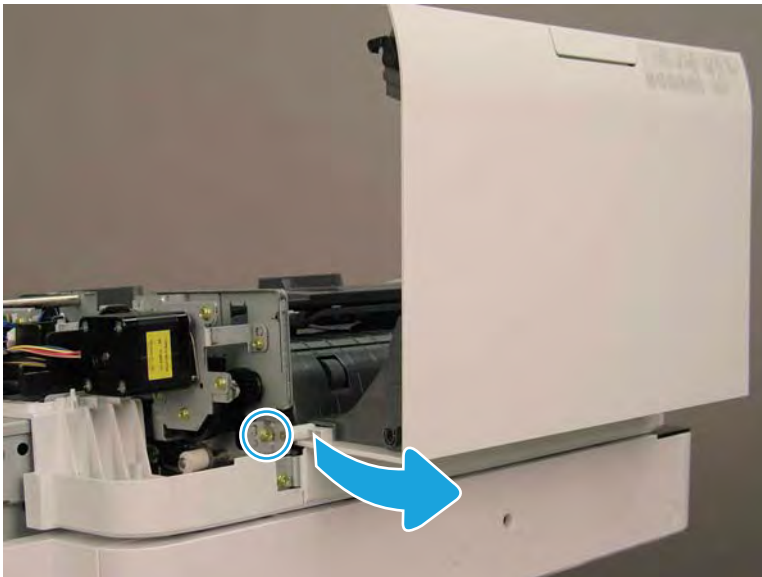


### Remove the document feeder jam access cover

Follow these steps to remove the document feeder jam access cover.

1. Open the jam access cover, and then remove one screw.

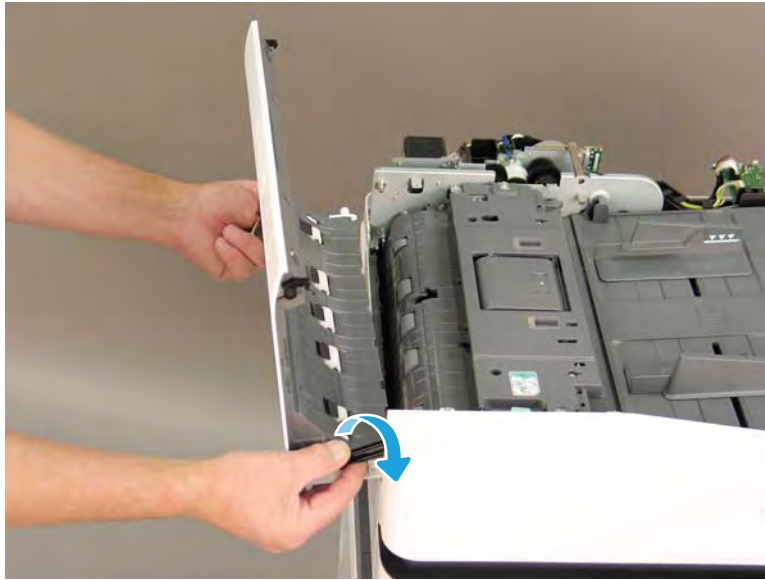
**Figure 2-352** Remove the jam access cover screw





2. Remove the pivot pin, and then pivot the cover and release the hinge to remove the jam access cover.

**Figure 2-353** Remove the jam access cover



## Unpack the replacement assembly



Follow these steps to unpack the replacement assembly.

1. Dispose of the defective part.


 **NOTE:** HP recommends responsible disposal of the defective part.

<http://www8.hp.com/us/en/hp-information/environment/product-recycling.html>


2. Unpack the replacement part from the packaging.

 **CAUTION:**  Some parts are sensitive to electrostatic discharge (ESD). Always perform service work at an ESD-protected workstation or mat. If an ESD workstation or mat is not available, touch the sheet-metal chassis to provide a static ground before touching an ESD-sensitive assembly. Protect the ESD-sensitive assemblies by placing them in ESD pouches when they are out of the printer.

 **IMPORTANT:** Make sure that all of the shipping materials (for example shipping tape) are removed from the replacement part prior to installation.

 **NOTE:** If the replacement part is a roller or pad, avoid touching the spongy part of it. Skin oils on the roller or pad can cause paper pickup and/or print-quality problems. HP recommends using disposable gloves when handling rollers or pads or washing your hands before touching rollers or pads.

3. To install an assembly, reverse the removal steps.


 **NOTE:** When applicable, special installation instructions are provided for an assembly at the end of the removal procedure. Always completely read the removal instructions and follow all special installation instructions.

## Removal and replacement: Removal and replacement: Document feeder (ADF) input tray (LX)

Learn how to remove and replace the document feeder input tray (LX).

To view a short video of this procedure, click the link below.

 [View a video of how to remove and replace the document feeder input tray \(LX\).](#)

 **IMPORTANT:** When applicable, special installation instructions are provided for an assembly at the end of the removal procedure. Always completely read the removal instructions and follow all special installation instructions.


Mean time to repair:

Service level:

### Before performing service

#### Turn the printer power off

- Press the power button on the front of the printer, and then turn off the power switch next to the power cable.
- A shutting-down message appears on the control-panel display.

 **WARNING!** To avoid damage to the printer, turn the power off and wait until the printer shuts down before removing the power cable.

- Disconnect the printer power cable after the printer has completely shut down (the control-panel display is blank).

Use the table below to identify the correct part number for your printer. To order the part, go to [www.hp.com/buy/parts](http://www.hp.com/buy/parts).

Table 2-75 Part information

Part number	Part description
JC97-04859A	ADF stacker (LX) (E778xx series)
X3A84-60103	ADF stacker (LX) E783xx series)

### Required tools

- #2 JIS screwdriver with a magnetic tip

### After performing service

#### Turn the printer power on

- Connect the printer power cable.
- Turn on the power switch next to the power cable, and then press the power button on the front of the printer.
- Verify that the service performed was successful.

- Verify that the most recent firmware is installed on the printer.
- Verify that all parts are correctly reinstalled and are properly working.

### Post service test

Print any pages necessary to verify that the repair resolved the issue and did not create any new issues.

### Remove the document feeder (ADF) front cover

Follow these steps to remove the document feeder (ADF) front cover.

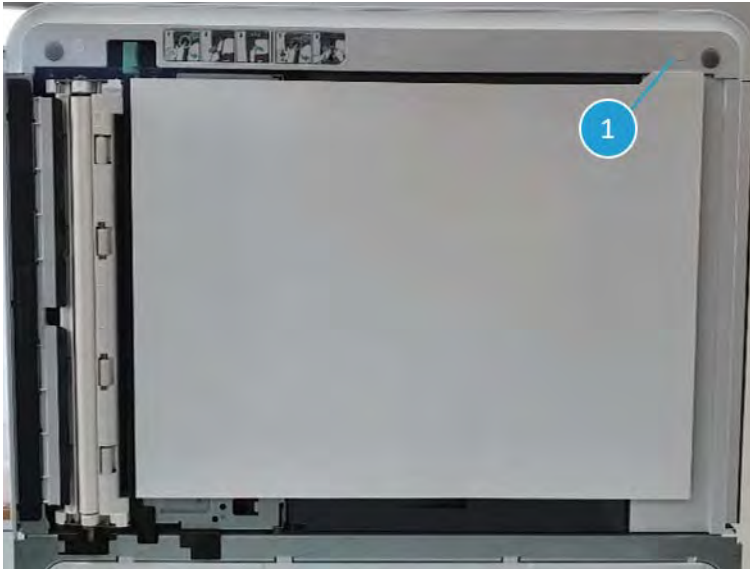
1. Remove two screws from the top of document feeder front cover.

**Figure 2-354** Remove the document feeder front cover top screws



2. Open the document feeder. Detach a sticker and then remove a screw (Callout 1) from the bottom of the document feeder front cover.

**Figure 2-355** Open the document feeder



3. Remove the document feeder front cover.

**Figure 2-356** Remove the document feeder front cover

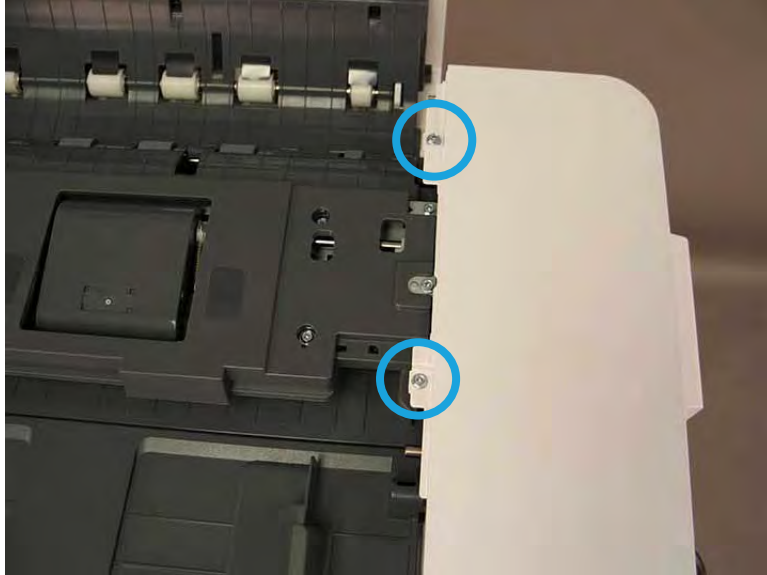


### Remove the document feeder (ADF) back cover

Follow these steps to remove the document feeder (ADF) back cover.

1. Remove two screws from the top of document feeder back cover.

Figure 2-357 Remove the document feeder back cover top screws



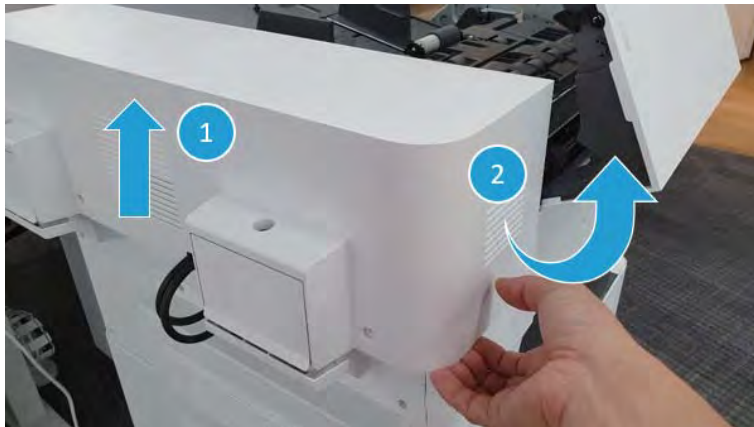
2. Remove 3 caps and 3 screws.

Figure 2-358 Remove 3 caps and 3 screws.



3. Release the top back cover.


Figure 2-359 Release the top back cover.



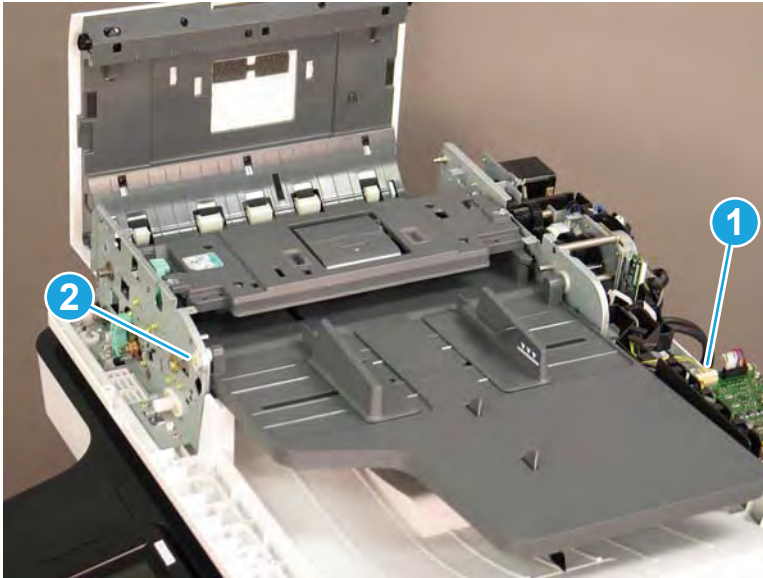
## Remove the document feeder (ADF) input tray

Follow these steps to remove the document feeder (ADF) input tray.

1. Disconnect one connector on document feeder board (callout 1), remove one screw and hinge pin (callout 2), and then remove the input tray.

 **NOTE:** Carefully guide the cable out of the chassis while removing the tray.

**Figure 2-360** Remove the input tray connector, screw, and hinge pin



## Unpack the replacement assembly



Follow these steps to unpack the replacement assembly.

1. Dispose of the defective part.


 **NOTE:** HP recommends responsible disposal of the defective part.

<http://www8.hp.com/us/en/hp-information/environment/product-recycling.html>

2. Unpack the replacement part from the packaging.


 **CAUTION:**  Some parts are sensitive to electrostatic discharge (ESD). Always perform service work at an ESD-protected workstation or mat. If an ESD workstation or mat is not available, touch the sheet-metal chassis to provide a static ground before touching an ESD-sensitive assembly. Protect the ESD-sensitive assemblies by placing them in ESD pouches when they are out of the printer.

 **IMPORTANT:** Make sure that all of the shipping materials (for example shipping tape) are removed from the replacement part prior to installation.

 **NOTE:** If the replacement part is a roller or pad, avoid touching the spongy part of it. Skin oils on the roller or pad can cause paper pickup and/or print-quality problems. HP recommends using disposable gloves when handling rollers or pads or washing your hands before touching rollers or pads.

3. To install an assembly, reverse the removal steps.

---

 **NOTE:** When applicable, special installation instructions are provided for an assembly at the end of the removal procedure. Always completely read the removal instructions and follow all special installation instructions.


---

## Removal and replacement: Removal and replacement: Contact Image Sensor (CIS) assembly

Learn how to remove and replace the document feeder CIS (LX).

To view a short video of this procedure, click the link below.

 [View a video of how to remove and replace the document feeder CIS \(LX\).](#)

 **IMPORTANT:** When applicable, special installation instructions are provided for an assembly at the end of the removal procedure. Always completely read the removal instructions and follow all special installation instructions.


Mean time to repair:

Service level:

### Before performing service

#### Turn the printer power off

- Press the power button on the front of the printer, and then turn off the power switch next to the power cable.
- A shutting-down message appears on the control-panel display.

 **WARNING!** To avoid damage to the printer, turn the power off and wait until the printer shuts down before removing the power cable.

- Disconnect the printer power cable after the printer has completely shut down (the control-panel display is blank).

Use the table below to identify the correct part number for your printer. To order the part, go to [www.hp.com/buy/parts](http://www.hp.com/buy/parts).

Table 2-76 Part information

Part number	Part description
JC97-04920A	Contact image sensor (CIS)
JC97-04722A	Contact image sensor (CIS) (E778xx series)
JC97-04920A	Contact image sensor (CIS) (E783xx series)

### Required tools

- #2 JIS screwdriver with a magnetic tip

### After performing service

#### Turn the printer power on

- Connect the printer power cable.
- Turn on the power switch next to the power cable, and then press the power button on the front of the printer.



- Verify that the service performed was successful.
- Verify that the most recent firmware is installed on the printer.
- Verify that all parts are correctly reinstalled and are properly working.

### Post service test

Print any pages necessary to verify that the repair resolved the issue and did not create any new issues.

### Remove the document feeder (ADF) front cover

Follow these steps to remove the document feeder (ADF) front cover.

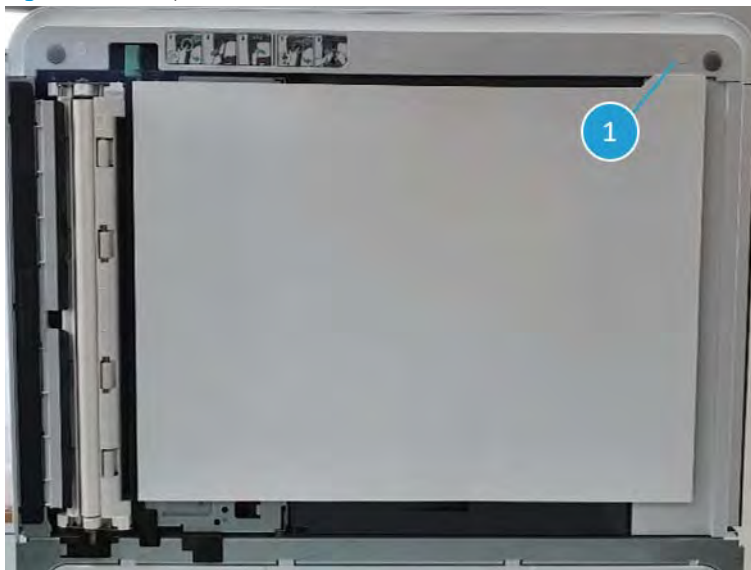
1. Remove two screws from the top of document feeder front cover.

**Figure 2-361** Remove the document feeder front cover top screws



2. Open the document feeder. Detach a sticker and then remove a screw (Callout 1) from the bottom of the document feeder front cover.

**Figure 2-362** Open the document feeder



3. Remove the document feeder front cover.

**Figure 2-363** Remove the document feeder front cover

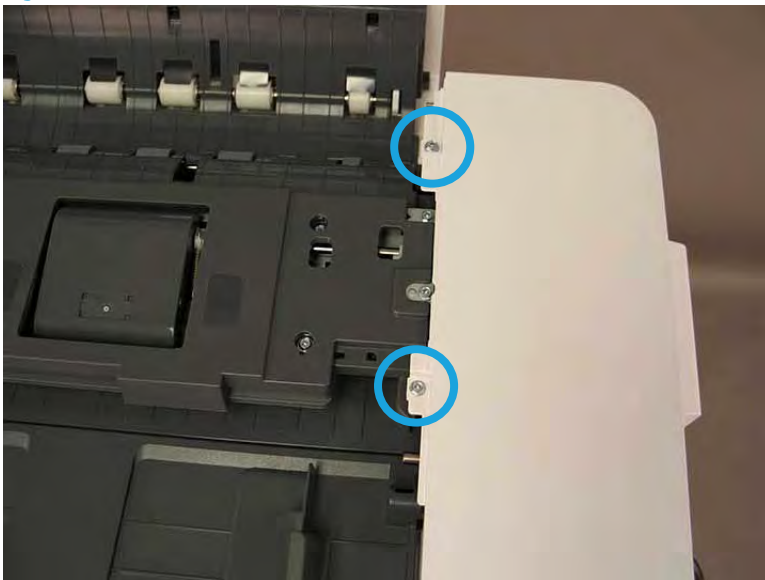


### Remove the document feeder (ADF) back cover

Follow these steps to remove the document feeder (ADF) back cover.

1. Remove two screws from the top of document feeder back cover.

**Figure 2-364** Remove the document feeder back cover top screws



2. Remove 3 caps and 3 screws.

Figure 2-365 Remove 3 caps and 3 screws.



3. Release the top back cover.

Figure 2-366 Release the top back cover.



### Remove the pick and feed roller assembly

Follow these steps to remove the pick and feed roller assembly.

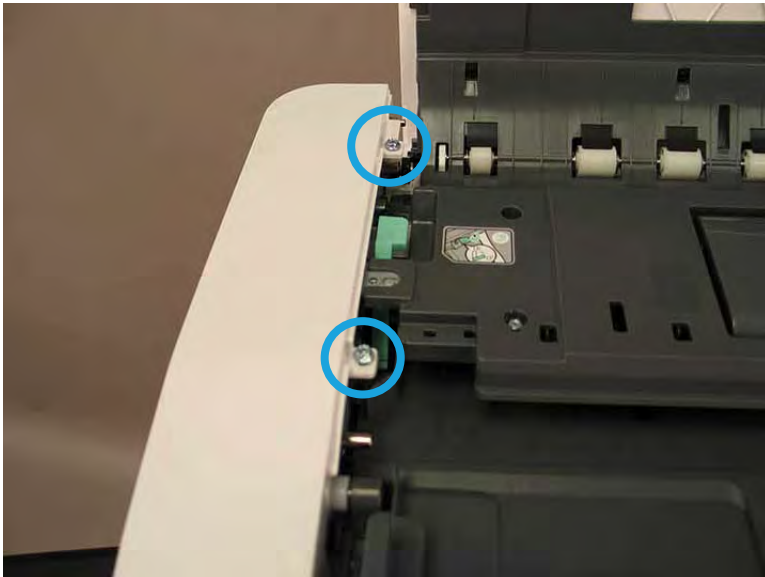
1. Remove four screws.

Figure 2-367 Remove four screws



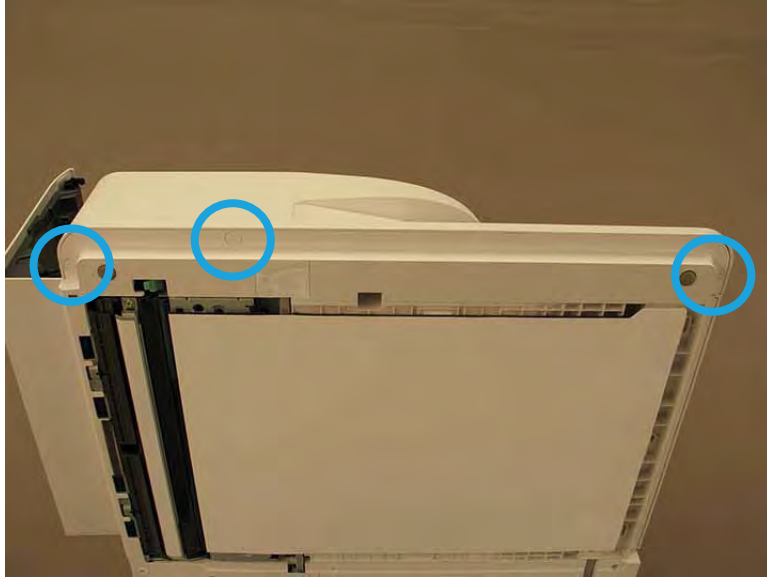
2. Remove two screws on the front cover.

Figure 2-368 Remove two screws on front cover



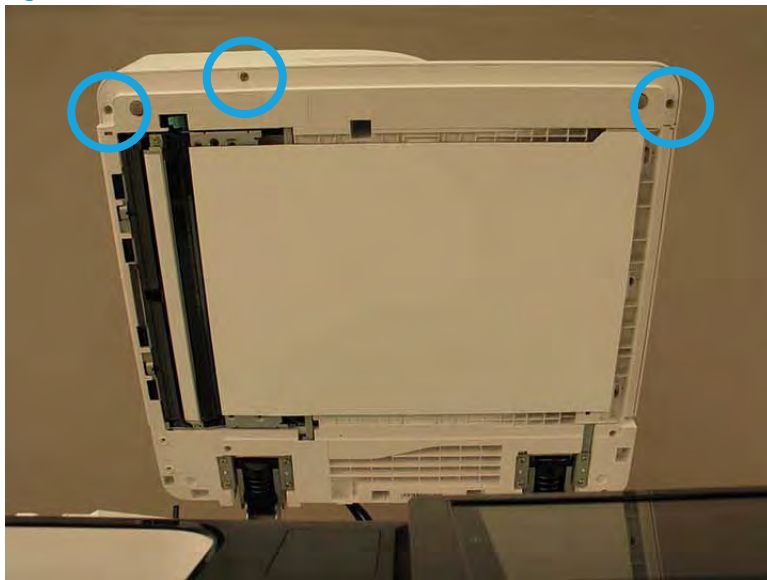
3. Open the ADF and then remove three screw caps.

Figure 2-369 Remove three screw caps



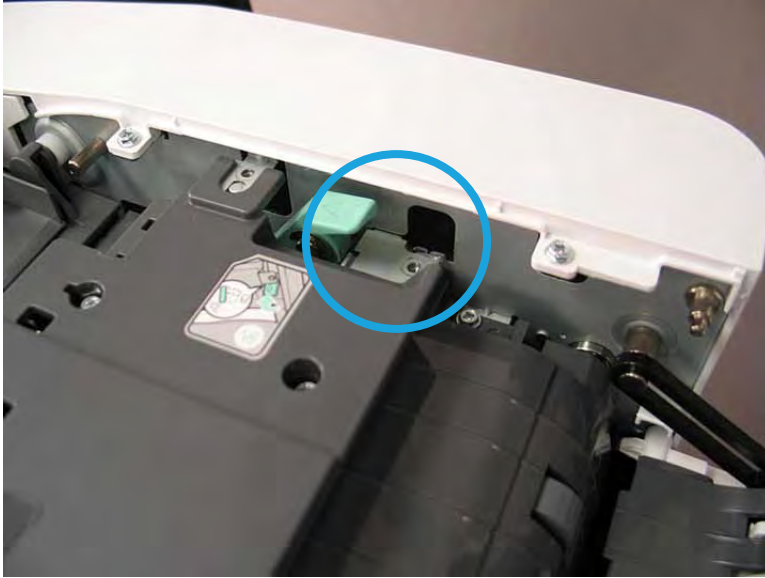
4. Remove three screws, and then remove the front cover.

Figure 2-370 Remove three screws and front cover



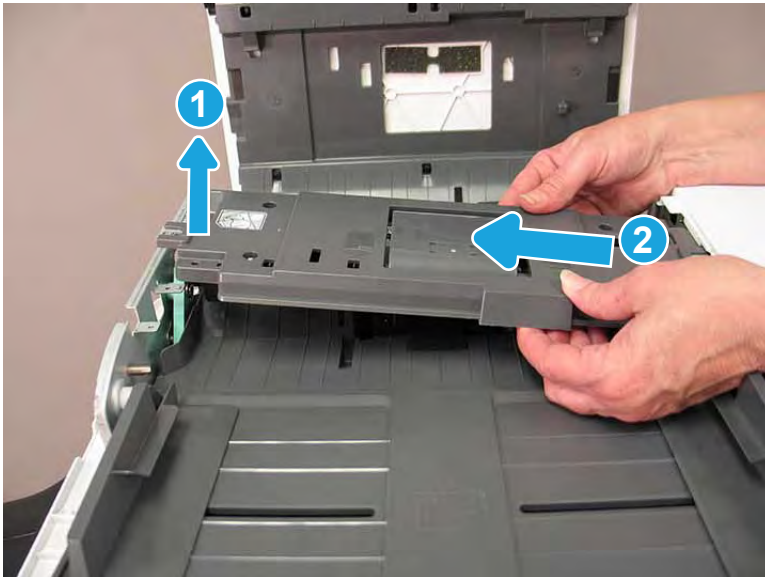
5. Rotate the pick/feed roller assembly to release the sheet metal tab from ADF frame.

**Figure 2-371** Release the sheet metal tab from ADF frame



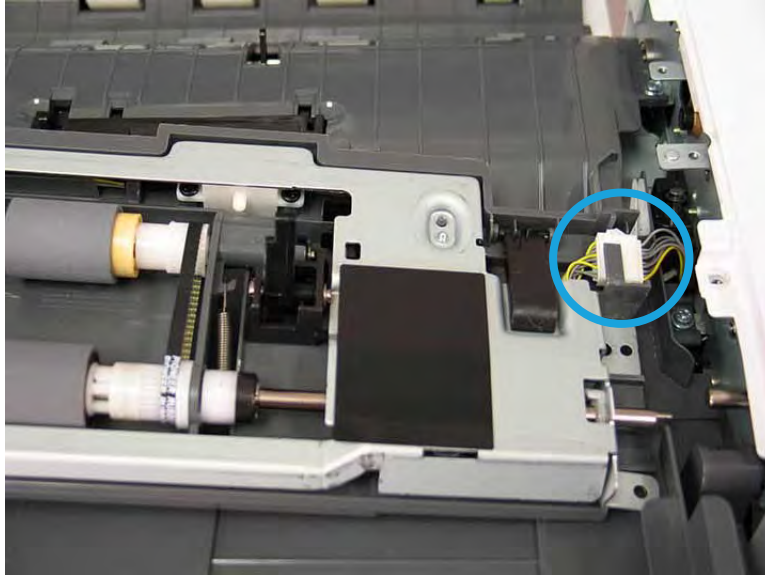
6. To remove the pick/feed roller assembly lift up on the front side (callout 1) and, then slide towards the front (callout 2) to release the pick/feed roller assembly.


**Figure 2-372** Release the pick/feed roller assembly



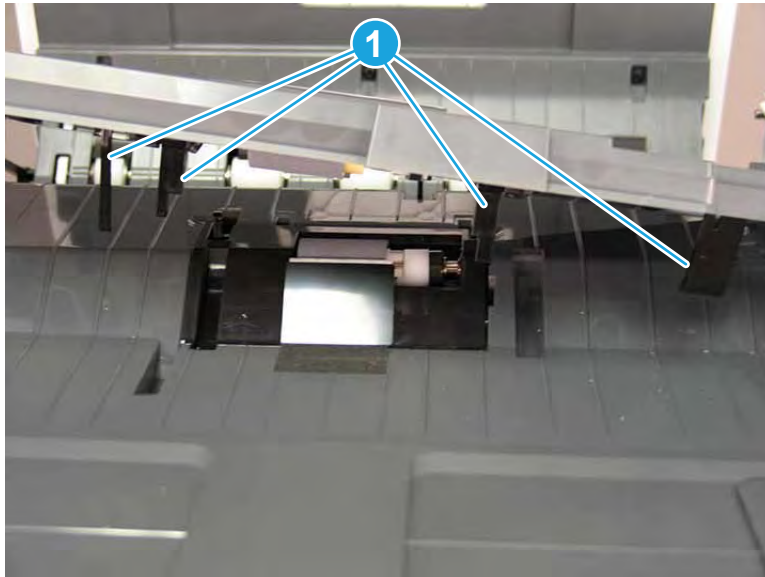
7. Rotate the roller assembly over, and then disconnect one connectors. Remove the document feeder pick roller assembly.

**Figure 2-373** Remove the document feeder pick roller assembly



-  **Reinstallation tip:** Note the four flags (callout 1) on the bottom of the pick/feed roller assembly. When reinstalling, hold up the flags while reinstall to allow for proper installation.


**Figure 2-374** Pick/Feed roller assembly four flags



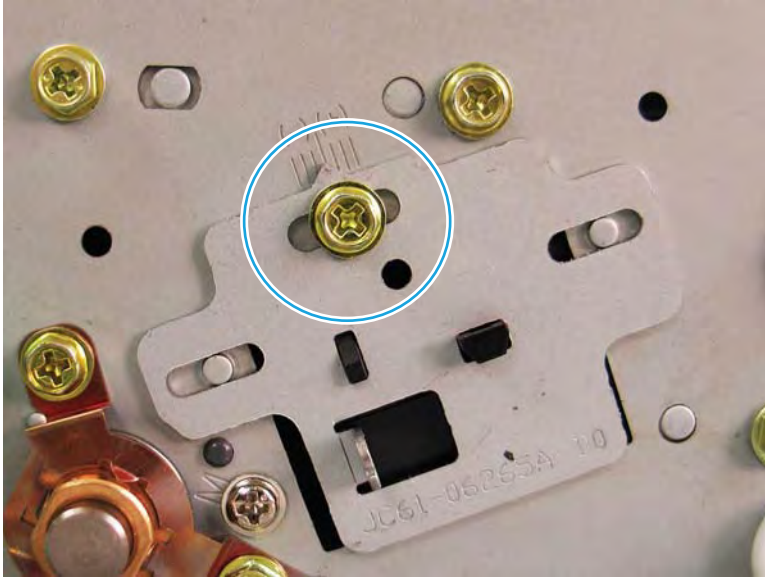
## Remove the CIS assembly

Follow these steps to remove the CIS assembly.

1. Remove one screw, and then remove the CIS front alignment cover.

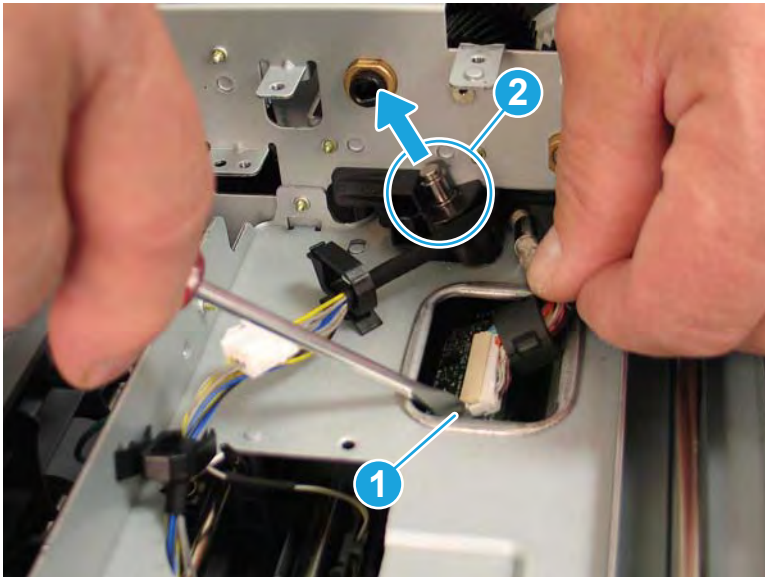
-  **Reinstallation tip:** Note the orientation of the CIS front alignment cover. The cover must be reinstalled in the same orientation.

**Figure 2-375** Remove the CIS front alignment cover screws



2. Disconnect one connector (callout 1), and then lift the alignment pin to release the CIS assembly (callout 2).

**Figure 2-376** Disconnect the CIS connector and lift the alignment pin



3. Remove the CIS assembly from the chassis.

### Unpack the replacement assembly

Follow these steps to unpack the replacement assembly.

1. Dispose of the defective part.





---

 **NOTE:** HP recommends responsible disposal of the defective part.


<http://www8.hp.com/us/en/hp-information/environment/product-recycling.html>

---

2. Unpack the replacement part from the packaging.


 **CAUTION:**  Some parts are sensitive to electrostatic discharge (ESD). Always perform service work at an ESD-protected workstation or mat. If an ESD workstation or mat is not available, touch the sheet-metal chassis to provide a static ground before touching an ESD-sensitive assembly. Protect the ESD-sensitive assemblies by placing them in ESD pouches when they are out of the printer.

 **IMPORTANT:** Make sure that all of the shipping materials (for example shipping tape) are removed from the replacement part prior to installation.

 **NOTE:** If the replacement part is a roller or pad, avoid touching the spongy part of it. Skin oils on the roller or pad can cause paper pickup and/or print-quality problems. HP recommends using disposable gloves when handling rollers or pads or washing your hands before touching rollers or pads.

---

3. To install an assembly, reverse the removal steps.

 **NOTE:** When applicable, special installation instructions are provided for an assembly at the end of the removal procedure. Always completely read the removal instructions and follow all special installation instructions.

---


## Removal and replacement: Removal and replacement: Document feeder (ADF) main motor (LX)

Learn how to remove and replace the document feeder main motor (LX).

To view a short video of this procedure, click the link below.

 [View a video of this procedure for HP Color LaserJet MFP.](#)

 [View a video of this procedure for HP LaserJet MFP](#)

 **IMPORTANT:** When applicable, special installation instructions are provided for an assembly at the end of the removal procedure. Always completely read the removal instructions and follow all special installation instructions.


Mean time to repair:

Service level:

### Before performing service

#### Turn the printer power off

- Press the power button on the front of the printer, and then turn off the power switch next to the power cable.
- A shutting-down message appears on the control-panel display.

 **WARNING!** To avoid damage to the printer, turn the power off and wait until the printer shuts down before removing the power cable.

- Disconnect the printer power cable after the printer has completely shut down (the control-panel display is blank).

Use the table below to identify the correct part number for your printer. To order the part, go to [www.hp.com/buy/parts](http://www.hp.com/buy/parts).

Table 2-77 Part information

Part number	Part description
JC31-00163A	Main motor assembly (LX)

### Required tools

- #2 JIS screwdriver with a magnetic tip

### After performing service

#### Turn the printer power on

- Connect the printer power cable.
- Turn on the power switch next to the power cable, and then press the power button on the front of the printer.
- Verify that the service performed was successful.

- Verify that the most recent firmware is installed on the printer.
- Verify that all parts are correctly reinstalled and are properly working.

### Post service test

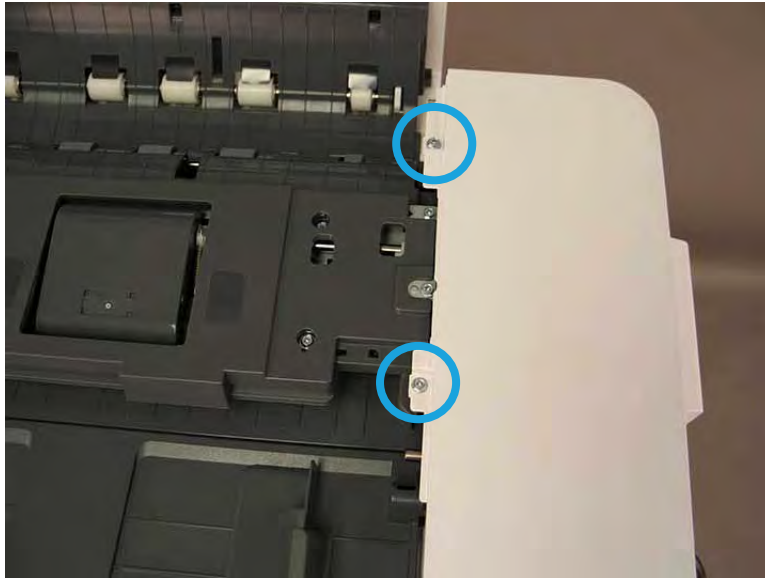
Print any pages necessary to verify that the repair resolved the issue and did not create any new issues.

### Remove the document feeder (ADF) back cover

Follow these steps to remove the document feeder (ADF) back cover.

1. Remove two screws from the top of document feeder back cover.

**Figure 2-377** Remove the document feeder back cover top screws



2. Remove 3 caps and 3 screws.

**Figure 2-378** Remove 3 caps and 3 screws.



3. Release the top back cover.

**Figure 2-379** Release the top back cover.

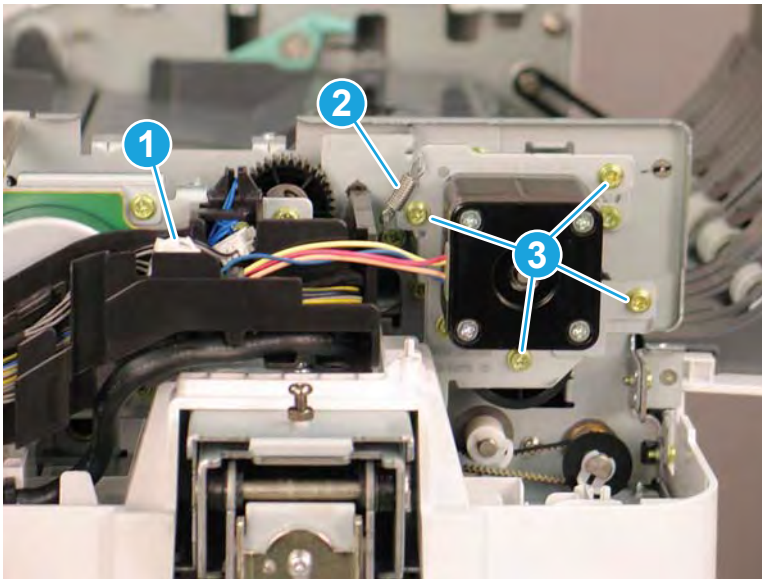


## Remove the main motor

Follow these steps to remove the main motor:

1. Disconnect one connector (callout 1), remove the tension spring (callout 2), and then remove four screws (callout 3).

**Figure 2-380** Remove the main motor connector, spring, and screws



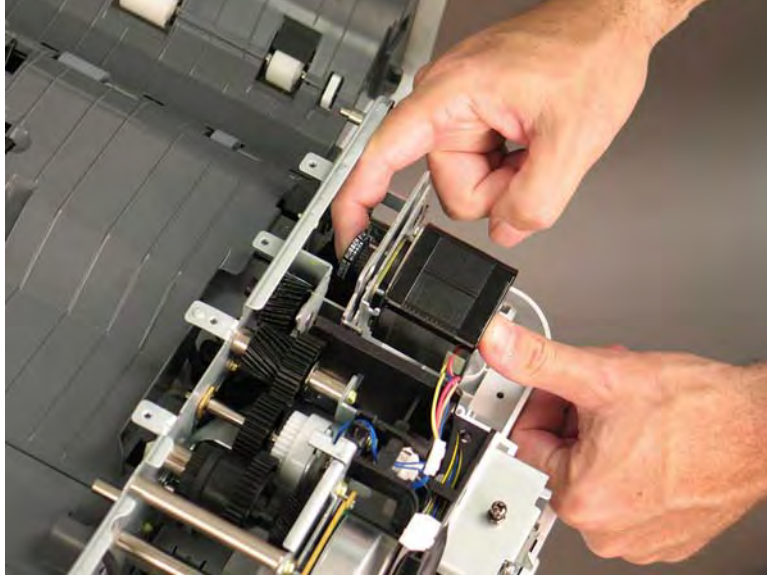
2. Carefully lift the motor out while releasing the gear belt.

---

 **Reinstallation tip:**

- a. Reinstall the motor and lift the gear belt up to engage the motor pulley.
  - b. Loosely install the motor mount screws.
  - c. Install the tension spring.
  - d. Tighten the motor mount screws just enough so that the tension spring (not the motor mount screws) is providing the tension to the belt.
-

Figure 2-381 Main motor and gear belt



## Remove the CIS assembly

Follow these steps to remove the CIS assembly.

1. Remove one screw, and then remove the CIS front alignment cover.


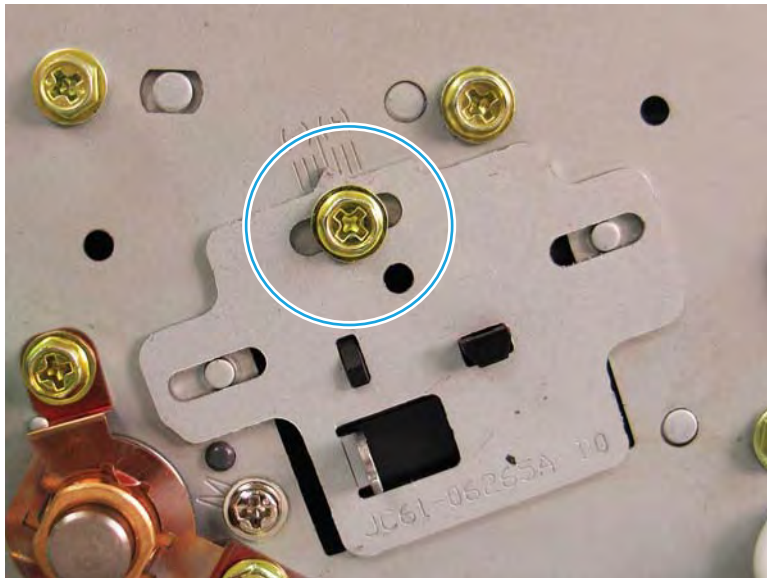
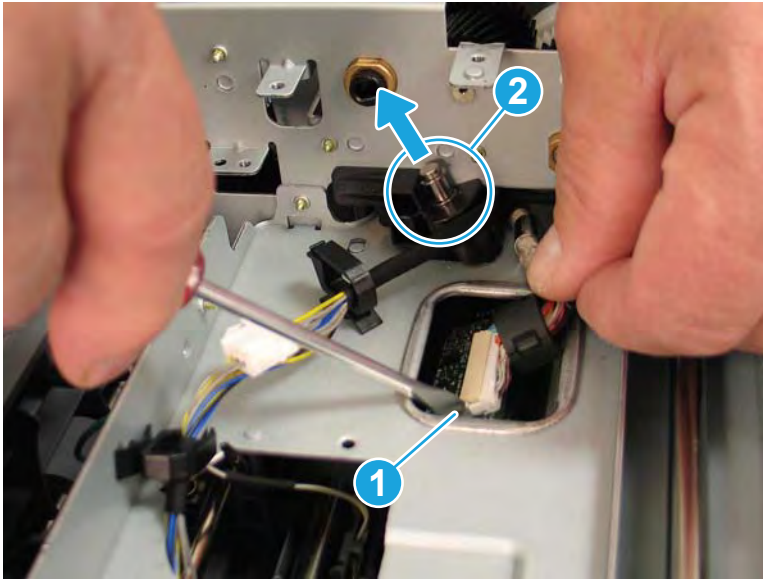
 **Reinstallation tip:** Note the orientation of the CIS front alignment cover. The cover must be reinstalled in the same orientation.

Figure 2-382 Remove the CIS front alignment cover screws



2. Disconnect one connector (callout 1), and then lift the alignment pin to release the CIS assembly (callout 2).

**Figure 2-383** Disconnect the CIS connector and lift the alignment pin



3. Remove the CIS assembly from the chassis.

## Unpack the replacement assembly



Follow these steps to unpack the replacement assembly.


1. Dispose of the defective part.


 **NOTE:** HP recommends responsible disposal of the defective part.

<http://www8.hp.com/us/en/hp-information/environment/product-recycling.html>


2. Unpack the replacement part from the packaging.

 **CAUTION:**  Some parts are sensitive to electrostatic discharge (ESD). Always perform service work at an ESD-protected workstation or mat. If an ESD workstation or mat is not available, touch the sheet-metal chassis to provide a static ground before touching an ESD-sensitive assembly. Protect the ESD-sensitive assemblies by placing them in ESD pouches when they are out of the printer.

 **IMPORTANT:** Make sure that all of the shipping materials (for example shipping tape) are removed from the replacement part prior to installation.

 **NOTE:** If the replacement part is a roller or pad, avoid touching the spongy part of it. Skin oils on the roller or pad can cause paper pickup and/or print-quality problems. HP recommends using disposable gloves when handling rollers or pads or washing your hands before touching rollers or pads.

3. To install an assembly, reverse the removal steps.

 **NOTE:** When applicable, special installation instructions are provided for an assembly at the end of the removal procedure. Always completely read the removal instructions and follow all special installation instructions.

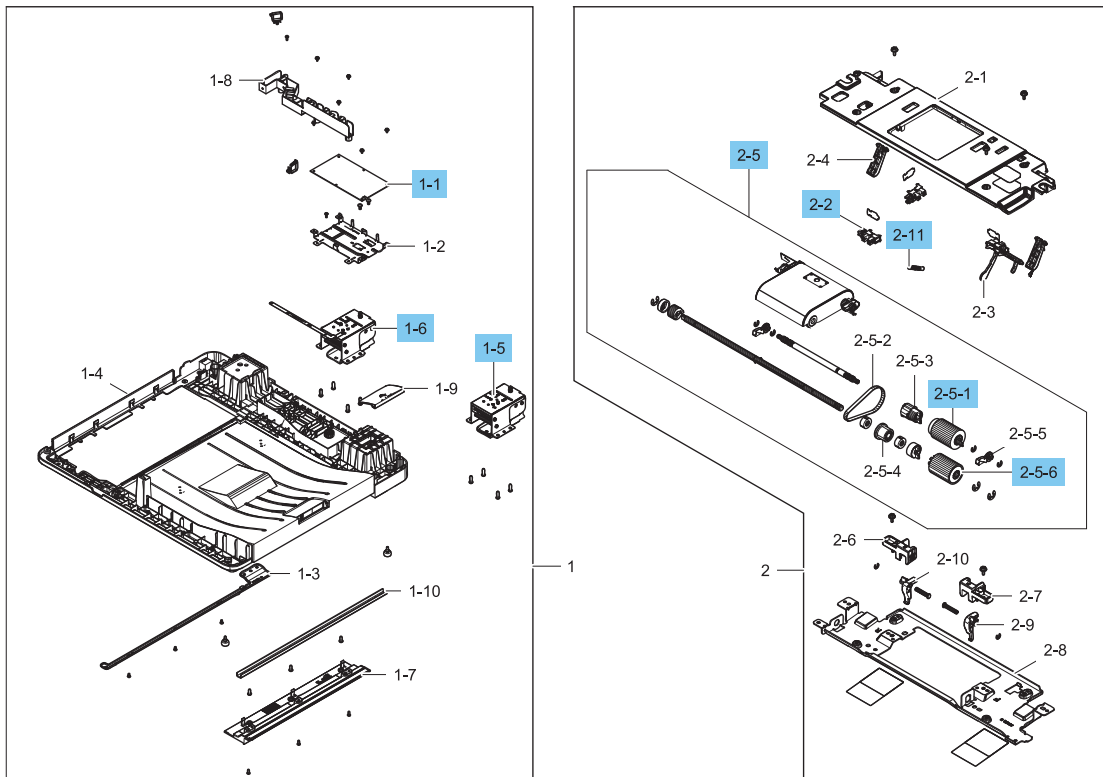
## ADF exterior and ADF pickup (LX models)

View the ADF exterior and ADF pickup (LX models) exploded view, parts list, and repair procedures.

## ADF exterior and ADF pickup (LX)

Parts diagram and parts list for the ADF exterior and ADF pickup (LX models).

Figure 2-384 ADF exterior and ADF pickup (LX models)





**Table 2-78** ADF exterior and ADF pickup (LX models)


Ref				
No	Part number	Description	Qty	Repair procedure
1-1	JC92-02962A	LX PCA	1	<a href="#">Removal and replacement: Document feeder (ADF) PCA (LX) on page 508</a>
1-5	JC97-04528A	LX, hinge r	1	Not applicable
1-6	JC97-04527A	LX, hinge l	1	Not applicable
2-2	0604-001393	Photo interrupter	1	Not applicable
2-5	JC97-04857A	Pick Roller Assy - LX	1	<a href="#">Removal and replacement: Document feeder (ADF) pick/feed roller assembly (LX) on page 512</a>
2-5-1	JC97-04099A	LX pick roller	1	Not applicable
2-5-6	JC97-04860A	LX feed roller	1	Not applicable

## Removal and replacement: Removal and replacement: Document feeder (ADF) PCA (LX)

Learn how to remove and replace the document feeder PCA (LX).

To view a short video of this procedure, click the link below.

 [View a video of how to remove and replace the document feeder PCA \(LX\).](#)

 **IMPORTANT:** When applicable, special installation instructions are provided for an assembly at the end of the removal procedure. Always completely read the removal instructions and follow all special installation instructions.

Mean time to repair:

Service level:

### Before performing service

#### Turn the printer power off

- Press the power button on the front of the printer, and then turn off the power switch next to the power cable.
- A shutting-down message appears on the control-panel display.

 **WARNING!** To avoid damage to the printer, turn the power off and wait until the printer shuts down before removing the power cable.

- Disconnect the printer power cable after the printer has completely shut down (the control-panel display is blank).

Use the table below to identify the correct part number for your printer. To order the part, go to [www.hp.com/buy/parts](http://www.hp.com/buy/parts).

**Table 2-79 Part information**

Part number	Part description
JC92-02962A	Document feeder PCA assembly (LX)

### Required tools

- #2 JIS screwdriver with a magnetic tip

### After performing service

#### Turn the printer power on

- Connect the printer power cable.
- Turn on the power switch next to the power cable, and then press the power button on the front of the printer.
- Verify that the service performed was successful.

- Verify that the most recent firmware is installed on the printer.
- Verify that all parts are correctly reinstalled and are properly working.

### Post service test

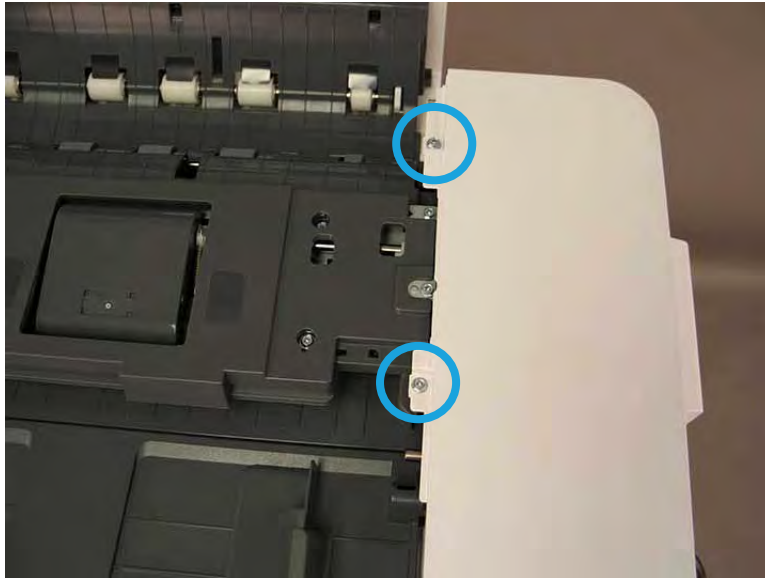
Print any pages necessary to verify that the repair resolved the issue and did not create any new issues.

### Remove the document feeder (ADF) back cover

Follow these steps to remove the document feeder (ADF) back cover.

1. Remove two screws from the top of document feeder back cover.

**Figure 2-385** Remove the document feeder back cover top screws



2. Remove 3 caps and 3 screws.

**Figure 2-386** Remove 3 caps and 3 screws.



3. Release the top back cover.

**Figure 2-387** Release the top back cover.

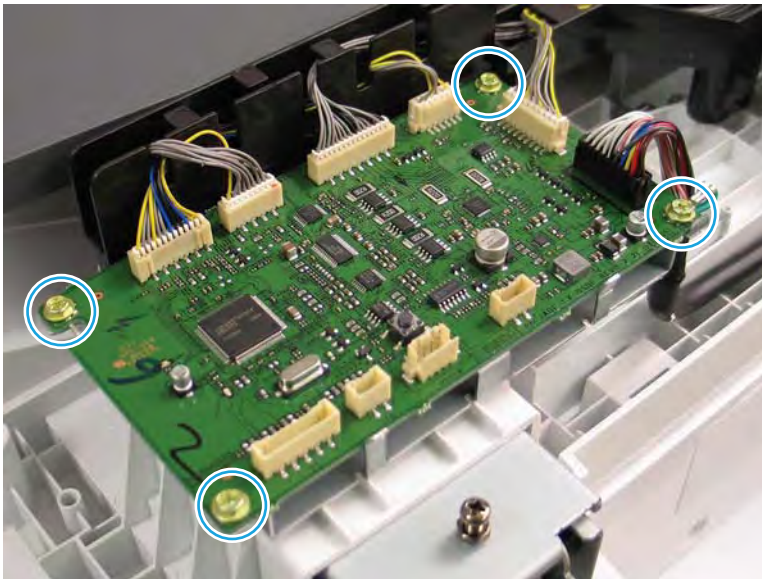


### Remove the document feeder (ADF) PCA

Follow these steps to remove the document feeder (ADF) PCA.

- ▲ Disconnect six connectors and the ground wire from PCA, remove four screws, and then remove the document feeder PCA (LX).

**Figure 2-388** Document feeder PCA (LX)



### Unpack the replacement assembly

Follow these steps to unpack the replacement assembly.

1. Dispose of the defective part.



---

 **NOTE:** HP recommends responsible disposal of the defective part.


<http://www8.hp.com/us/en/hp-information/environment/product-recycling.html>

---

2. Unpack the replacement part from the packaging.


 **CAUTION:**  Some parts are sensitive to electrostatic discharge (ESD). Always perform service work at an ESD-protected workstation or mat. If an ESD workstation or mat is not available, touch the sheet-metal chassis to provide a static ground before touching an ESD-sensitive assembly. Protect the ESD-sensitive assemblies by placing them in ESD pouches when they are out of the printer.

 **IMPORTANT:** Make sure that all of the shipping materials (for example shipping tape) are removed from the replacement part prior to installation.

 **NOTE:** If the replacement part is a roller or pad, avoid touching the spongy part of it. Skin oils on the roller or pad can cause paper pickup and/or print-quality problems. HP recommends using disposable gloves when handling rollers or pads or washing your hands before touching rollers or pads.

---

3. To install an assembly, reverse the removal steps.

 **NOTE:** When applicable, special installation instructions are provided for an assembly at the end of the removal procedure. Always completely read the removal instructions and follow all special installation instructions.


---

## Removal and replacement: Removal and replacement: Document feeder (ADF) pick/feed roller assembly (LX)

Learn how to remove and replace the document feeder pickup/feed roller assembly (LX/du models).

To view a short video of this procedure, click the link below.

 [View a video of how to remove and replace the document feeder pickup/feed roller assembly \(LX\).](#)

 **IMPORTANT:** When applicable, special installation instructions are provided for an assembly at the end of the removal procedure. Always completely read the removal instructions and follow all special installation instructions.


Mean time to repair:

Service level:

### Before performing service

#### Turn the printer power off

- Press the power button on the front of the printer, and then turn off the power switch next to the power cable.
- A shutting-down message appears on the control-panel display.

 **WARNING!** To avoid damage to the printer, turn the power off and wait until the printer shuts down before removing the power cable.

- Disconnect the printer power cable after the printer has completely shut down (the control-panel display is blank).

Use the table below to identify the correct part number for your printer. To order the part, go to [www.hp.com/buy/parts](http://www.hp.com/buy/parts).

Table 2-80 Part information

Part number	Part description
JC97-04857A	Pick feed roller assembly (LX)

### Required tools

- #2 JIS screwdriver with a magnetic tip

### After performing service

#### Turn the printer power on

- Connect the printer power cable.
- Turn on the power switch next to the power cable, and then press the power button on the front of the printer.
- Verify that the service performed was successful.

- Verify that the most recent firmware is installed on the printer.
- Verify that all parts are correctly reinstalled and are properly working.

### Post service test

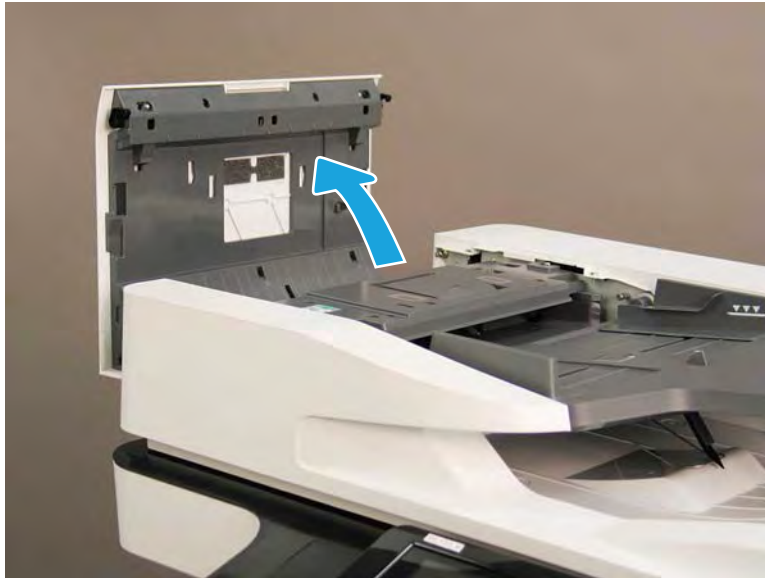
Print any pages necessary to verify that the repair resolved the issue and did not create any new issues.

### Remove the document feeder (ADF) (LX/du models) pick and feed roller assembly

Follow these steps to remove the document feeder (ADF) (LX/du models) pick and feed roller assembly.

1. Open the document feeder cover.

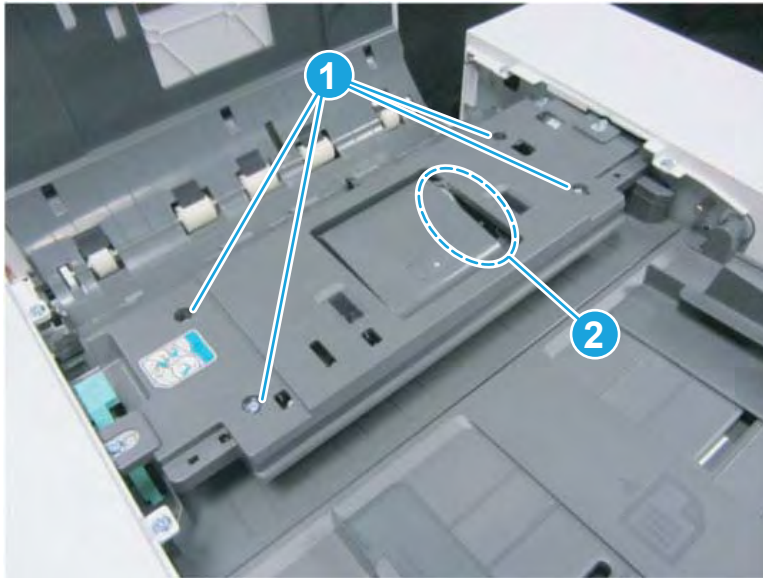
**Figure 2-389** Open the document feeder cover



2. Remove four screws in the document feeder pick roller assembly cover.

 **NOTE:** Remove one spring (callout 2; not shown)

**Figure 2-390** Remove the document feeder cover screws



3. Rotate the document feeder pickup cover up, and then disconnect one connector (callout 1).

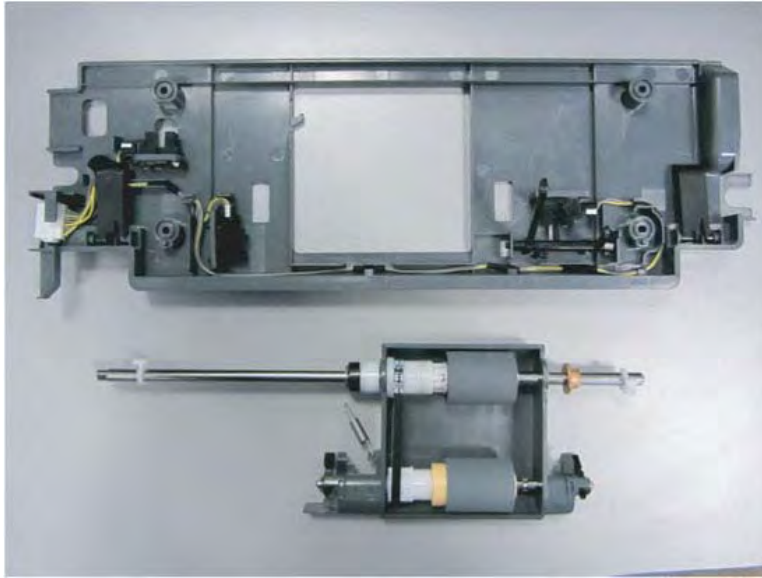
**Figure 2-391** Turn the cover over and disconnect connector






4. Before proceeding, take note of the removed roller cover and the roller assembly.

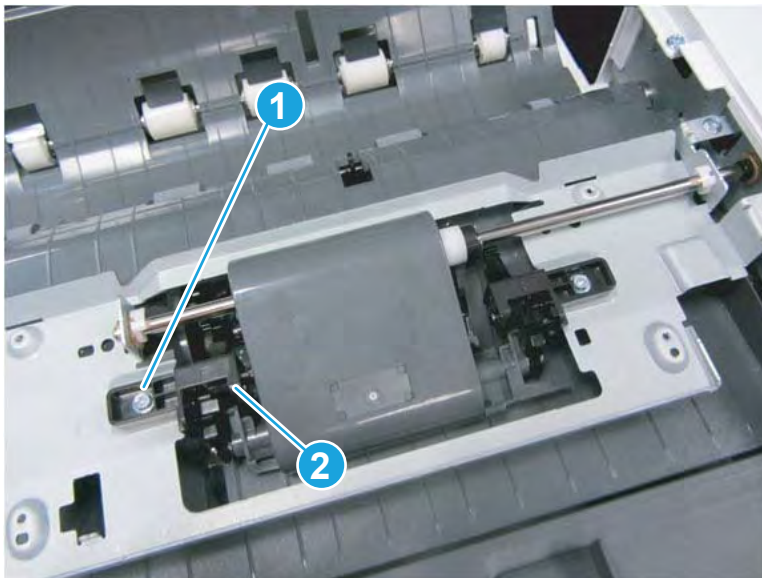
**Figure 2-392** Document feeder pick roller cover and roller assembly



5. Remove one screw (callout 1), and then remove the sensor flag bracket (callout 2).

 **Reinstallation tip:** When the roller assembly is reinstalled, make sure that the sensor flags (on both sides of the assembly) are correctly installed and move freely.

**Figure 2-393** Remove one screw and the sensor flag bracket

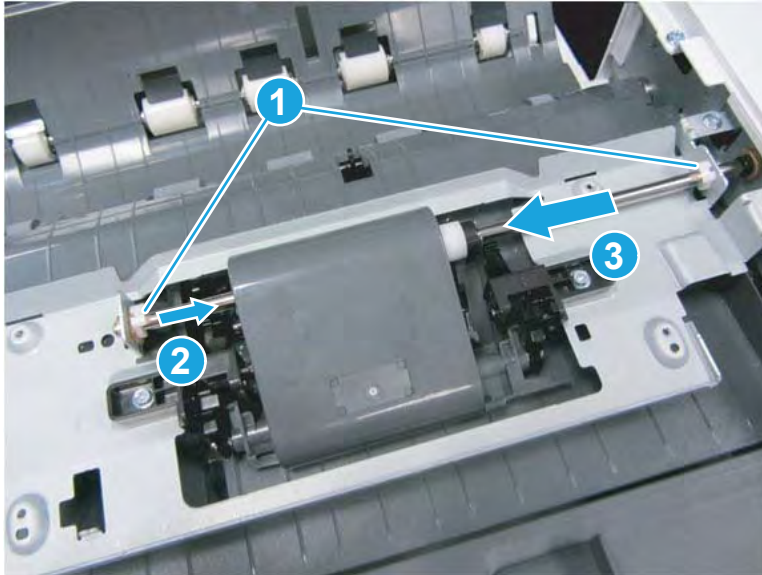


6. Release two plastic clips (callout 1), slide bushing toward roller assembly (callout 2), and then slide the shaft towards front of printer to release it (callout 3). Remove the roller assembly.

**CAUTION:** Do not damage the sensor flags when handling the roller assembly.

**NOTE:** The bushing is not captive. Do not lose it when handling the roller assembly.

**Figure 2-394** Remove the document feeder pick roller assembly clips



## Unpack the replacement assembly


Follow these steps to unpack the replacement assembly.

1. Dispose of the defective part.

**NOTE:** HP recommends responsible disposal of the defective part.

<http://www8.hp.com/us/en/hp-information/environment/product-recycling.html>

2. Unpack the replacement part from the packaging.


**CAUTION:**  Some parts are sensitive to electrostatic discharge (ESD). Always perform service work at an ESD-protected workstation or mat. If an ESD workstation or mat is not available, touch the sheet-metal chassis to provide a static ground before touching an ESD-sensitive assembly. Protect the ESD-sensitive assemblies by placing them in ESD pouches when they are out of the printer.

**IMPORTANT:** Make sure that all of the shipping materials (for example shipping tape) are removed from the replacement part prior to installation.

**NOTE:** If the replacement part is a roller or pad, avoid touching the spongy part of it. Skin oils on the roller or pad can cause paper pickup and/or print-quality problems. HP recommends using disposable gloves when handling rollers or pads or washing your hands before touching rollers or pads.

3. To install an assembly, reverse the removal steps.

---

 **NOTE:** When applicable, special installation instructions are provided for an assembly at the end of the removal procedure. Always completely read the removal instructions and follow all special installation instructions.

---

## ADF main frame assembly (LX models)

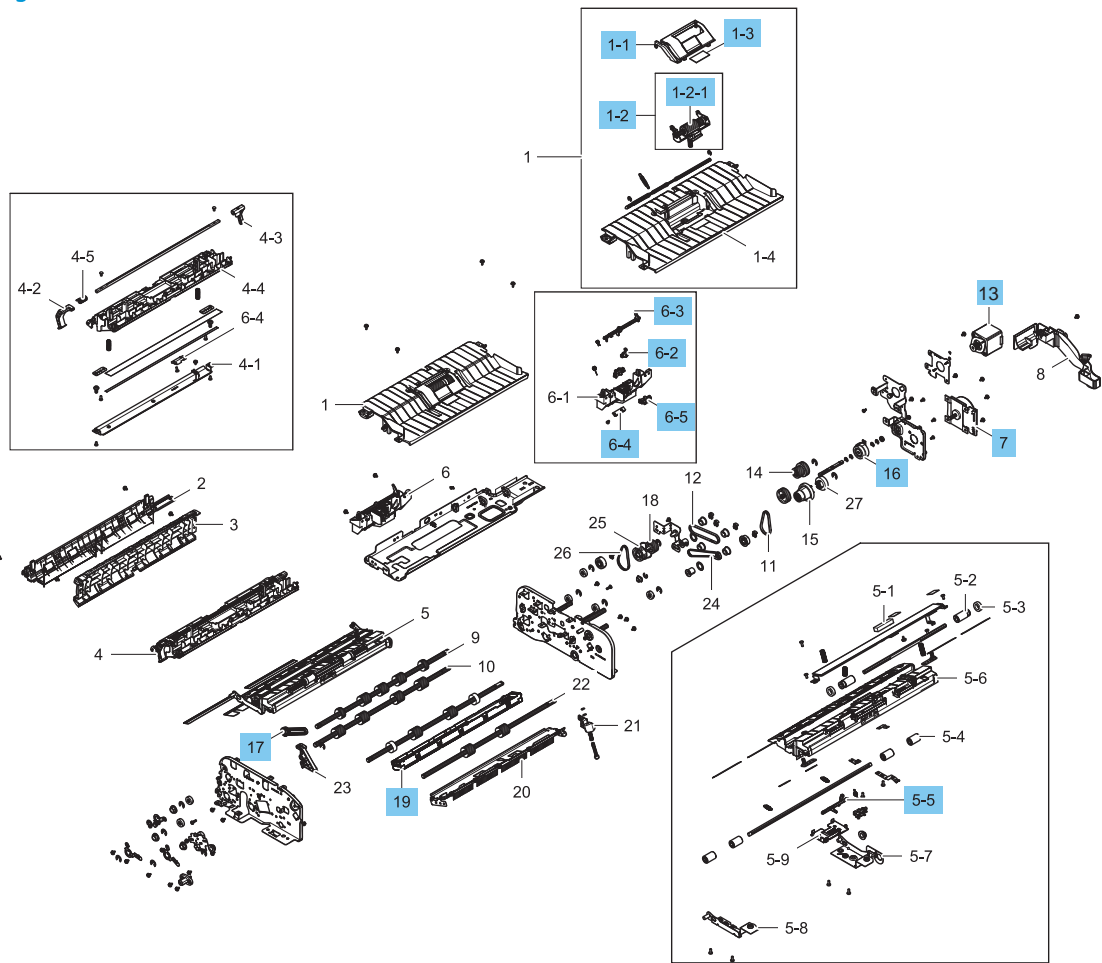
View the ADF main frame assembly (LX models) exploded view, parts list, and repair procedures.



## ADF main frame assembly (LX/du models)

Parts diagram and parts list for the ADF main frame assembly (LX models).

Figure 2-395 ADF main frame (LX models)



**Table 2-81 ADF main frame assembly (LX models)**

Ref				
No	Part number	Description	Qty	Repair procedure
1-1	JC97-04586A	LX separation housing	1	Not applicable
1-2	JC97-04852A	ADF LX separation roller	1	<a href="#">Removal and replacement: Document feeder (ADF) separation roller assembly (LX) on page 522</a>
1-2-1	JC97-04861A	ADF LX separation sub roller		Not applicable
1-3	JC69-01326A	Friction pad	1	Not applicable
5-5	JC66-04104A	Actuator, output <sup>1</sup>	1	Not applicable
6-2	JC66-04105A	Actuator, feed out	1	Not applicable
6-3	JC66-04103A	Actuator, registration	1	Not applicable
6-4	0604-001381	Photo interrupter	1	Not applicable
6-5	0604-001393	Photo interrupter <sup>1</sup>	1	Not applicable
7	JC31-00156C	Feed motor assembly (Motor, bldc type 1)	1	<a href="#">Removal and replacement: Document feeder (ADF) feed motor (LX) on page 529</a>
13	JC31-00163A	Motor - Step main	1	Not applicable
16	JC47-00038A	LX - Motor feed DC	1	Not applicable
17	JC66-04100A	LX - Link Cover Open	1	Not applicable
19	JC97-04920A	Contact Image Sensor (CIS)	1	Not applicable
19	JC97-04722A	Contact Image Sensor (CIS) (E778xx series)	1	Not applicable
19	JC97-04920A	Contact Image Sensor (CIS) (E783xx series)	1	Not applicable


<sup>1</sup>Early models only during original release. This part removed from newer models.

## Removal and replacement: Removal and replacement: Document feeder (ADF) separation roller assembly (LX)

Learn how to remove and replace the document feeder separation roller assembly (LX).

To view a short video of this procedure, click the link below.

 [View a video of how to remove and replace the document feeder separation roller assembly \(LX\).](#)

 **IMPORTANT:** When applicable, special installation instructions are provided for an assembly at the end of the removal procedure. Always completely read the removal instructions and follow all special installation instructions.


Mean time to repair:

Service level:

### Before performing service

#### Turn the printer power off

- Press the power button on the front of the printer, and then turn off the power switch next to the power cable.
- A shutting-down message appears on the control-panel display.

 **WARNING!** To avoid damage to the printer, turn the power off and wait until the printer shuts down before removing the power cable.

- Disconnect the printer power cable after the printer has completely shut down (the control-panel display is blank).

Use the table below to identify the correct part number for your printer. To order the part, go to [www.hp.com/buy/parts](http://www.hp.com/buy/parts).

Table 2-82 Part information

Part number	Part description
JC97-04852A	ADF separation roller assembly (LX)

### Required tools

- #2 JIS screwdriver with a magnetic tip

### After performing service

#### Turn the printer power on

- Connect the printer power cable.
- Turn on the power switch next to the power cable, and then press the power button on the front of the printer.
- Verify that the service performed was successful.



- Verify that the most recent firmware is installed on the printer.
- Verify that all parts are correctly reinstalled and are properly working.

### Post service test

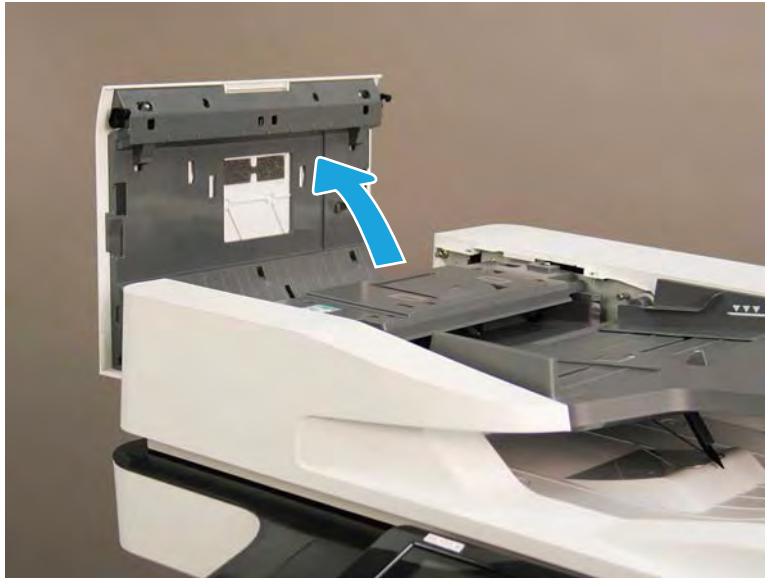
Print any pages necessary to verify that the repair resolved the issue and did not create any new issues.

### Remove the document feeder (ADF) (LX/du models) pick and feed roller assembly

Follow these steps to remove the document feeder (ADF) (LX/du models) pick and feed roller assembly.

1. Open the document feeder cover.

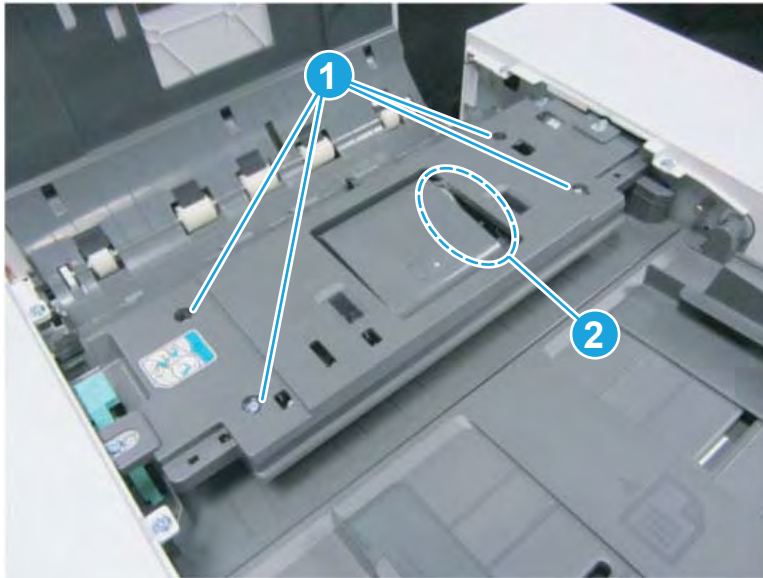
**Figure 2-396** Open the document feeder cover



2. Remove four screws in the document feeder pick roller assembly cover.

 **NOTE:** Remove one spring (callout 2; not shown)

**Figure 2-397** Remove the document feeder cover screws



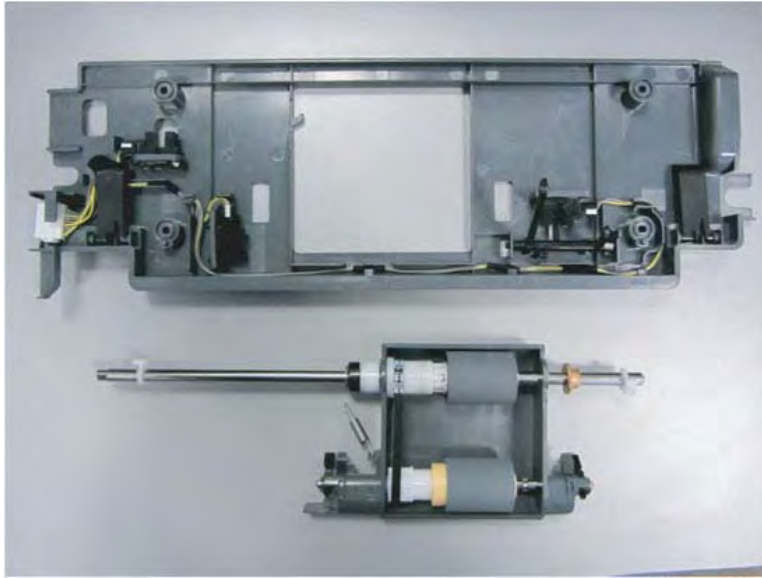
3. Rotate the document feeder pickup cover up, and then disconnect one connector (callout 1).

**Figure 2-398** Turn the cover over and disconnect connector




4. Before proceeding, take note of the removed roller cover and the roller assembly.

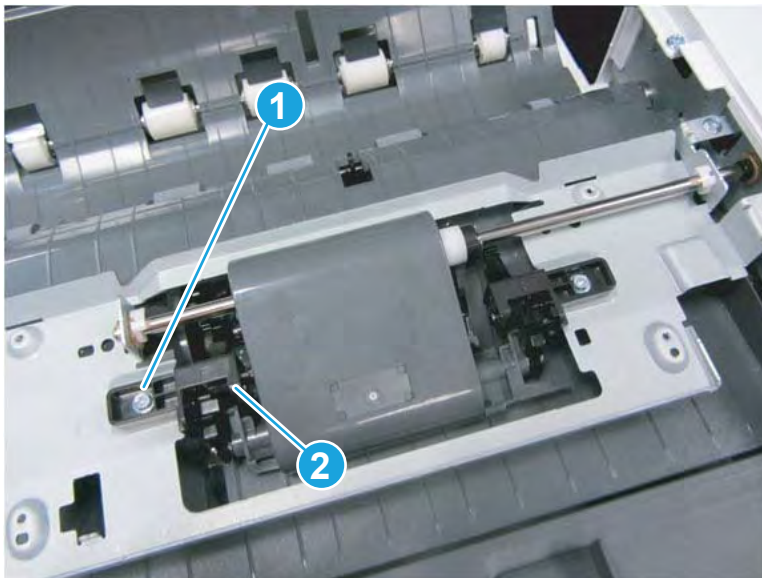
**Figure 2-399** Document feeder pick roller cover and roller assembly



5. Remove one screw (callout 1), and then remove the sensor flag bracket (callout 2).

 **Reinstallation tip:** When the roller assembly is reinstalled, make sure that the sensor flags (on both sides of the assembly) are correctly installed and move freely.

**Figure 2-400** Remove one screw and the sensor flag bracket

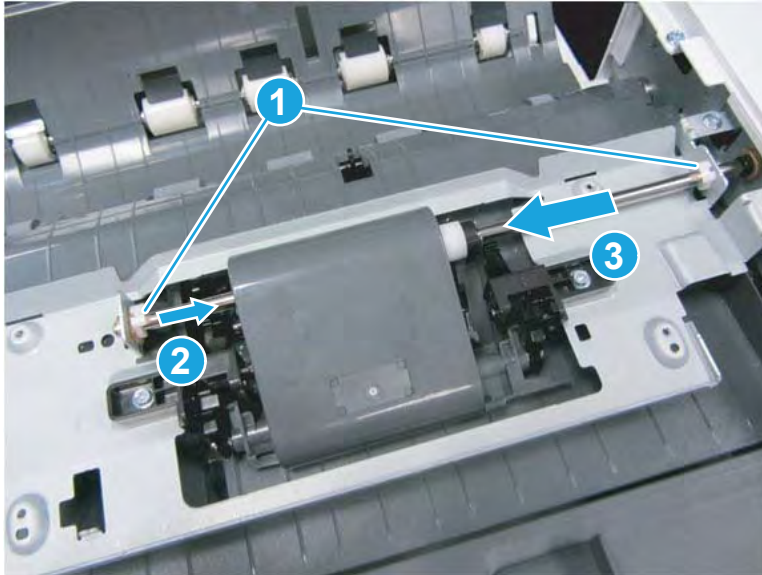


6. Release two plastic clips (callout 1), slide bushing toward roller assembly (callout 2), and then slide the shaft towards front of printer to release it (callout 3). Remove the roller assembly.

**⚠ CAUTION:** Do not damage the sensor flags when handling the roller assembly.

**📝 NOTE:** The bushing is not captive. Do not lose it when handling the roller assembly.

**Figure 2-401** Remove the document feeder pick roller assembly clips

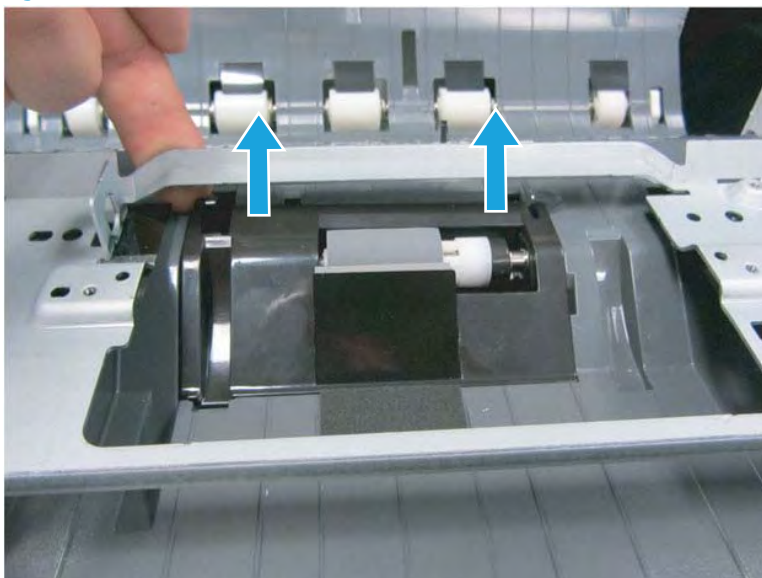


### Remove the LX document feeder separation roller

Follow these steps to remove the LX document feeder separation roller.

1. Rotate the separation roller cover up to release it, and then remove the cover.

**Figure 2-402** Remove the separation roller cover



2. Before proceeding, take note of the removed roller cover and the roller assembly.

**Figure 2-403** Document feeder separation roller cover and roller assembly

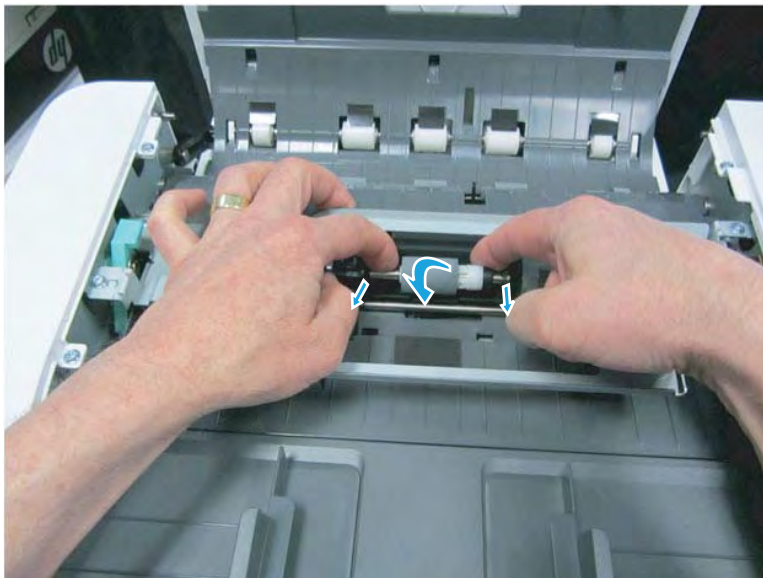


3. Release two claws, and then remove the separation roller assembly.



**NOTE:** The separation roller assembly spring under the roller is not captive.

**Figure 2-404** Remove the separation roller assembly



4. When the assembly is reinstalled, make sure that the spring is correctly seated in the holder.

Figure 2-405 Separation roller assembly spring



## Unpack the replacement assembly

Follow these steps to unpack the replacement assembly.

1. Dispose of the defective part.

---



 **NOTE:** HP recommends responsible disposal of the defective part.


<http://www8.hp.com/us/en/hp-information/environment/product-recycling.html>


---

2. Unpack the replacement part from the packaging.

---

 **CAUTION:**  Some parts are sensitive to electrostatic discharge (ESD). Always perform service work at an ESD-protected workstation or mat. If an ESD workstation or mat is not available, touch the sheet-metal chassis to provide a static ground before touching an ESD-sensitive assembly. Protect the ESD-sensitive assemblies by placing them in ESD pouches when they are out of the printer.


 **IMPORTANT:** Make sure that all of the shipping materials (for example shipping tape) are removed from the replacement part prior to installation.

 **NOTE:** If the replacement part is a roller or pad, avoid touching the spongy part of it. Skin oils on the roller or pad can cause paper pickup and/or print-quality problems. HP recommends using disposable gloves when handling rollers or pads or washing your hands before touching rollers or pads.

---

3. To install an assembly, reverse the removal steps.

---

 **NOTE:** When applicable, special installation instructions are provided for an assembly at the end of the removal procedure. Always completely read the removal instructions and follow all special installation instructions.


---

## Removal and replacement: Removal and replacement: Document feeder (ADF) feed motor (LX)

Learn how to remove and replace the document feeder feed motor (LX).

To view a short video of this procedure, click the link below.

 [View a video of how to remove and replace the document feeder feed motor \(LX\).](#)

 **IMPORTANT:** When applicable, special installation instructions are provided for an assembly at the end of the removal procedure. Always completely read the removal instructions and follow all special installation instructions.


Mean time to repair:

Service level:

### Before performing service

#### Turn the printer power off

- Press the power button on the front of the printer, and then turn off the power switch next to the power cable.
- A shutting-down message appears on the control-panel display.

 **WARNING!** To avoid damage to the printer, turn the power off and wait until the printer shuts down before removing the power cable.

- Disconnect the printer power cable after the printer has completely shut down (the control-panel display is blank).

Use the table below to identify the correct part number for your printer. To order the part, go to [www.hp.com/buy/parts](http://www.hp.com/buy/parts).

Table 2-83 Part information

Part number	Part description
JC31-00156C	Feed motor assembly (LX) (bldc type 1)

### Required tools

- #2 JIS screwdriver with a magnetic tip

### After performing service

#### Turn the printer power on

- Connect the printer power cable.
- Turn on the power switch next to the power cable, and then press the power button on the front of the printer.
- Verify that the service performed was successful.

- Verify that the most recent firmware is installed on the printer.
- Verify that all parts are correctly reinstalled and are properly working.

### Post service test

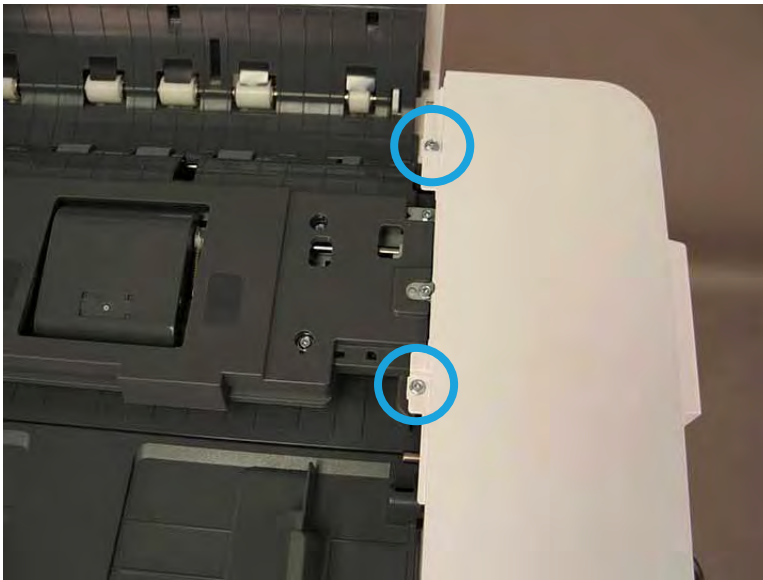
Print any pages necessary to verify that the repair resolved the issue and did not create any new issues.

### Remove the document feeder (ADF) back cover

Follow these steps to remove the document feeder (ADF) back cover.

1. Remove two screws from the top of document feeder back cover.

**Figure 2-406** Remove the document feeder back cover top screws



2. Remove 3 caps and 3 screws.

**Figure 2-407** Remove 3 caps and 3 screws.





3. Release the top back cover.

Figure 2-408 Release the top back cover.

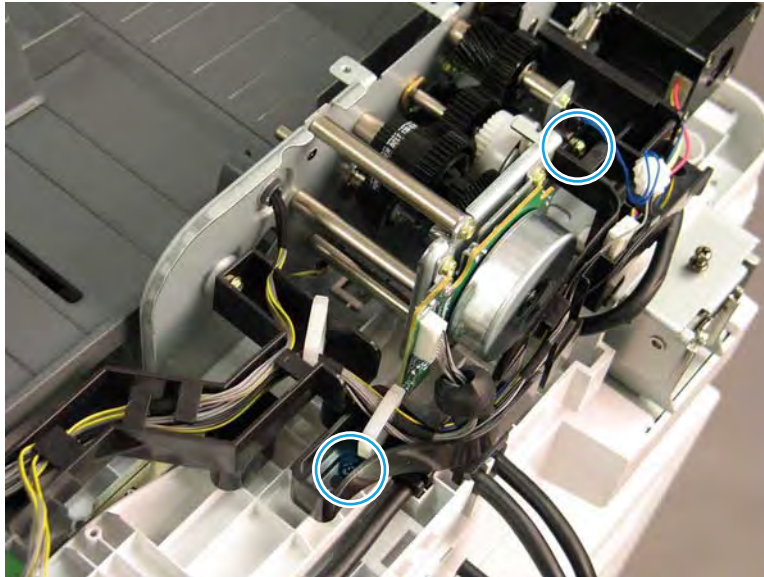


### Remove the feed motor

Follow these steps to remove the feed motor.

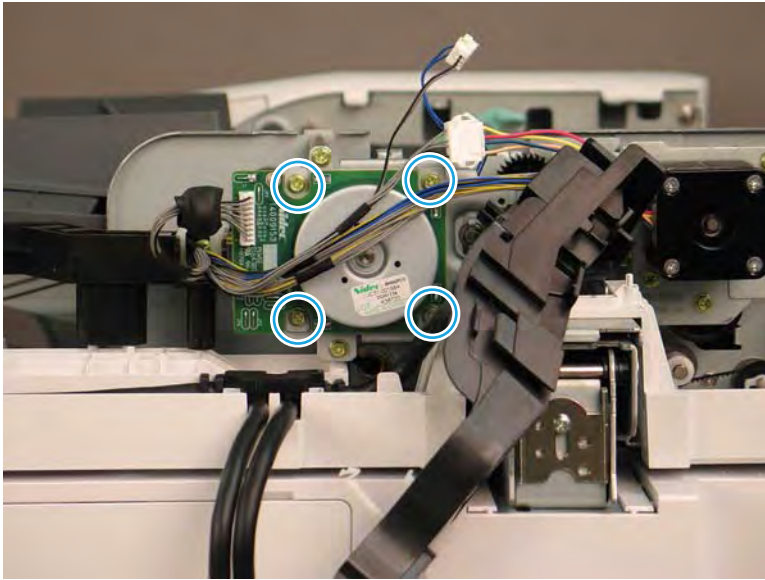
1. Loosen the cables in the cable guide, remove two screws and then move the cable guide out of the way.

Figure 2-409 Feed motor cable guide



2. Disconnect one connector, remove four screws, and then carefully lift the motor out to remove.

**Figure 2-410** Remove the feed motor



## Unpack the replacement assembly

Follow these steps to unpack the replacement assembly.

1. Dispose of the defective part.

---



 **NOTE:** HP recommends responsible disposal of the defective part.

<http://www8.hp.com/us/en/hp-information/environment/product-recycling.html>


---

2. Unpack the replacement part from the packaging.

---

 **CAUTION:**  Some parts are sensitive to electrostatic discharge (ESD). Always perform service work at an ESD-protected workstation or mat. If an ESD workstation or mat is not available, touch the sheet-metal chassis to provide a static ground before touching an ESD-sensitive assembly. Protect the ESD-sensitive assemblies by placing them in ESD pouches when they are out of the printer.


 **IMPORTANT:** Make sure that all of the shipping materials (for example shipping tape) are removed from the replacement part prior to installation.

 **NOTE:** If the replacement part is a roller or pad, avoid touching the spongy part of it. Skin oils on the roller or pad can cause paper pickup and/or print-quality problems. HP recommends using disposable gloves when handling rollers or pads or washing your hands before touching rollers or pads.

---

3. To install an assembly, reverse the removal steps.

---

 **NOTE:** When applicable, special installation instructions are provided for an assembly at the end of the removal procedure. Always completely read the removal instructions and follow all special installation instructions.

---

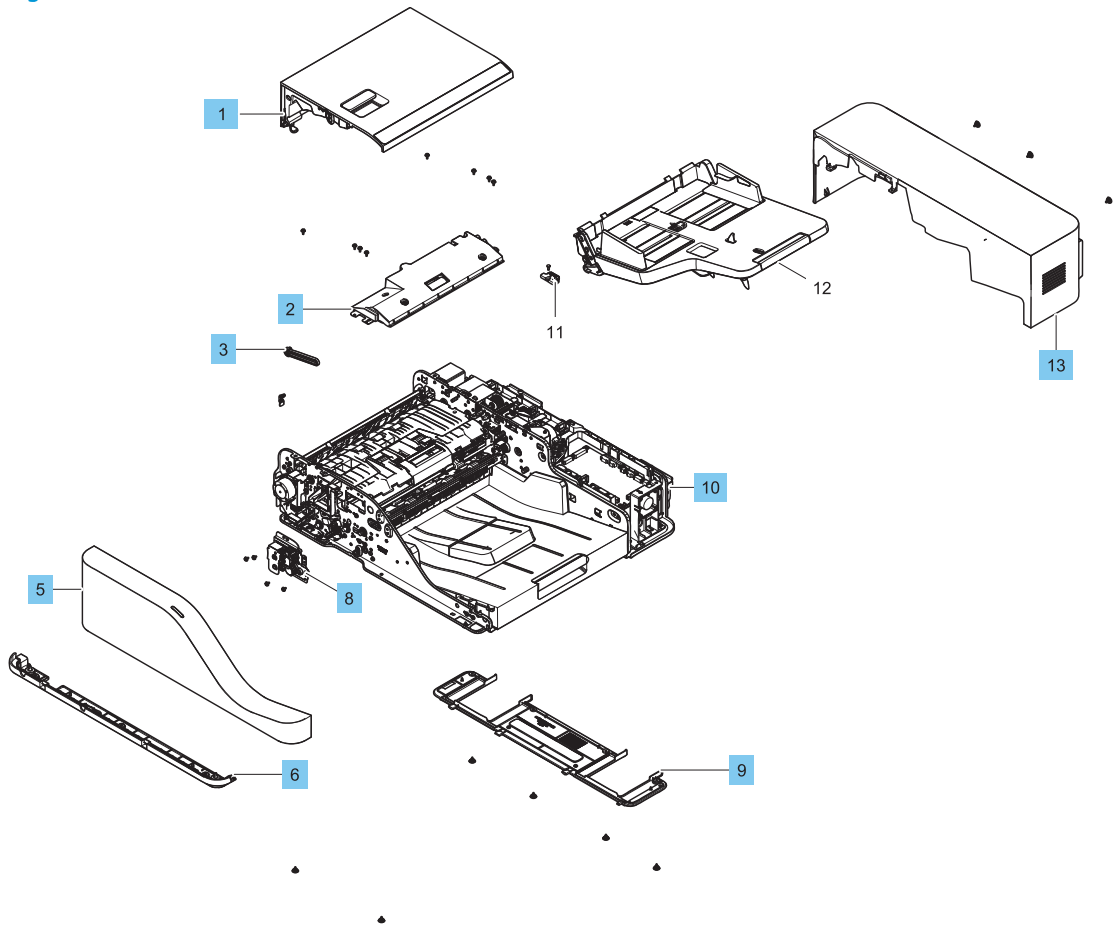
## Flow ADF (GX/z)

View the flow ADF (GX/z) exploded view, parts list, and repair procedures.

## ADF (GX/z)

Parts diagram and parts list for the ADF (GX/z).

Figure 2-411 ADF (GX/z)



**Table 2-84 ADF/ Scanner GX/z**

Ref				
No	Part number	Description	Qty	Repair procedure
1	JC97-04869A	GX/z ADF open cover	1	Not applicable
2	JC97-04872A	GX/z ADF pickup upper	1	Not applicable
3	JC66-02270A	GX/z ADF cover hinge	1	Not applicable
5	JC97-04881A	GX/z ADF front cover	1	Not applicable
6	JC97-04879A	GX/z ADF dummy front	1	Not applicable
8	JC97-04692A	GX/z ADF damper	1	Not applicable
9	JC97-04880A	GX/z ADF cover, bottom	1	Not applicable
10	JC97-04883A	GX/z ADF main frame	1	Not applicable
12	JC97-04658C	GX/z ADF Stacker	1	Not applicable
13	JC63-05566A	GX/z ADF cover, rear	1	Not applicable

## Removal and replacement: Document feeder input tray (GX)

This document provides the procedures to remove the input tray assembly.



[View a video of removing and replacing the input tray \(E77820-E77830\).](#)

Mean time to repair: 20 minutes

Service level: Intermediate



**IMPORTANT:** When applicable, special installation instructions are provided for an assembly at the end of the removal procedure. Always completely read the removal instructions and follow all special installation instructions.

### Before performing service

- Disconnect the power cable.

Use the table below to identify the correct part number for your printer. To order the part, go to [www.hp.com/buy/parts](http://www.hp.com/buy/parts)

**Table 2-85 Part information**

Part number	Part description
JC97-04658C	Input tray assembly

### Required tools

- #2 JIS screwdriver with a magnetic tip

### After performing service

#### Turn the printer power on

- Connect the power cable.
- Use the power switch to turn the power on.

### Post service test

Copy, scan, or print a document. Verify the document copies, scans, or prints correctly.

## Remove the document feeder (ADF) front cover

Follow these steps to remove the document feeder (ADF) front cover.

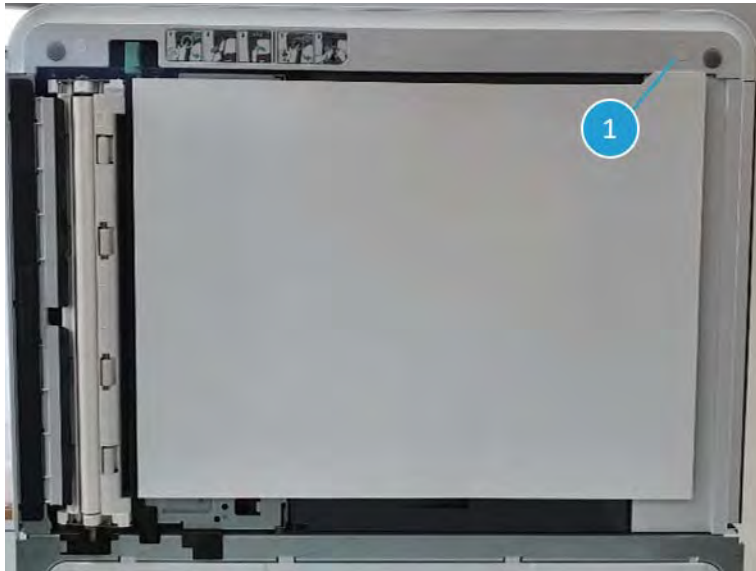
1. Remove two screws from the top of document feeder front cover.

Figure 2-412 Remove the document feeder front cover top screws



2. Open the document feeder. Detach a sticker and then remove a screw (Callout 1) from the bottom of the document feeder front cover.

Figure 2-413 Open the document feeder



3. Remove the document feeder front cover.

**Figure 2-414** Remove the document feeder front cover

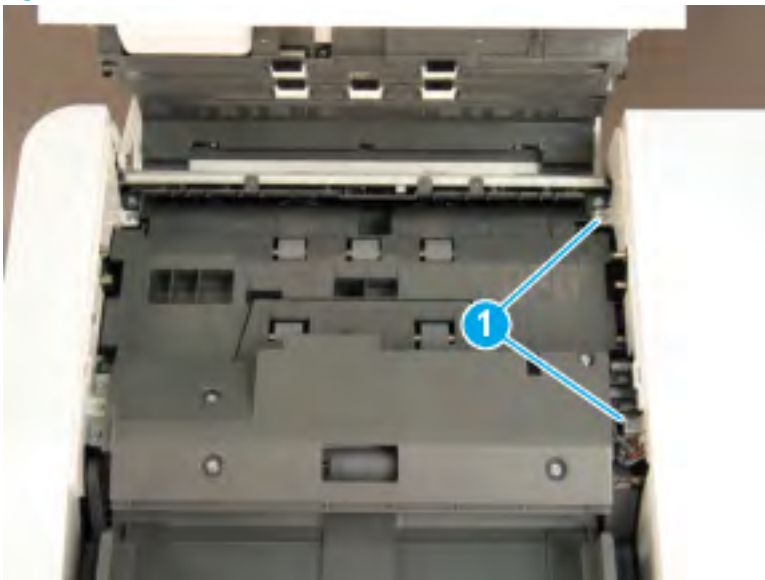


### Remove the document feeder back cover

Follow these steps to remove the document feeder back cover.

1. Remove two screws from the top of document feeder back cover.

**Figure 2-415** Remove the document feeder back cover top screws





2. Remove three screws from the bottom of the document feeder back cover, and then remove the document feeder back cover.

**Figure 2-416** Remove the document feeder back cover bottom screws

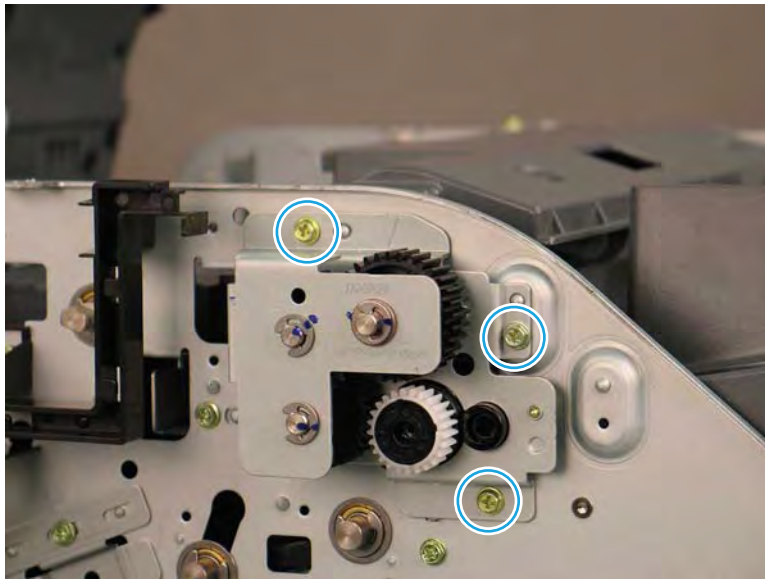


### Remove the dampening unit

Follow these steps to remove the dampening unit.

- ▲ Remove three screws, and then remove the dampening unit.

**Figure 2-417** Remove the document feeder dampening unit

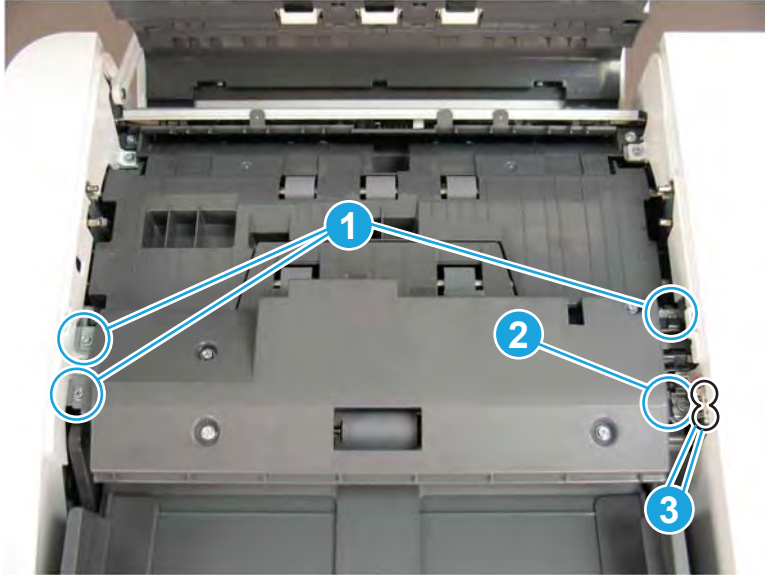


### Remove the document feeder pickup and feed assembly

Follow these steps to remove the document feeder pickup and feed assembly.

1. Remove 4 screws.

Figure 2-418 Remove 4 screws.




2. Remove 2 cables (callout 1) then remove the document feeder pickup roller assembly

Figure 2-419 Remove the pickup roller assembly



---

 **TIP:** Re-assembly

- Make sure shape of both the holes on the assembly and the shafts at the frame.



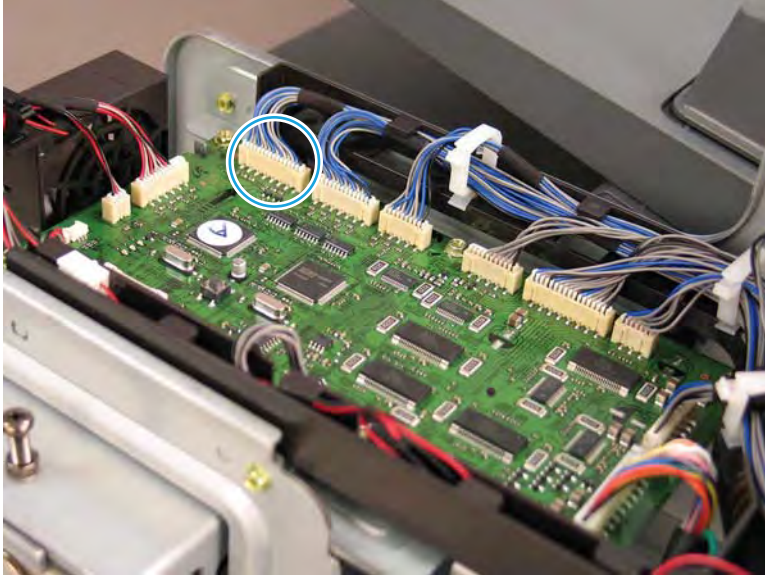
---

## Remove the input tray

Follow these steps to remove the input tray.

1. Disconnect the document feeder PCA connector, and then remove cable from guide.

Figure 2-420 Disconnect the document feeder PCA connector



2. Lift the tray from the front, and pivot the tray outward to remove.

## Removal and replacement: Contact Image Sensor (CIS) assembly


This document provides the procedures to remove the CIS assembly.

 [View a video of removing and replacing the CIS \(E77820-E77830\).](#)

Mean time to repair: 20 minutes

Service level: Intermediate

---

 **IMPORTANT:** When applicable, special installation instructions are provided for an assembly at the end of the removal procedure. Always completely read the removal instructions and follow all special installation instructions.

---

### Before performing service

- Disconnect the power cable.

Use the table below to identify the correct part number for your printer. To order the part, go to [www.hp.com/buy/parts](http://www.hp.com/buy/parts)

**Table 2-86 Part information**

Part number	Part description
0605-001246	Contact Image Sensor (CIS) assembly

### Required tools

- #2 JIS screwdriver with a magnetic tip

### After performing service

#### Turn the printer power on

- Connect the power cable.
- Use the power switch to turn the power on.

### Post service test

Copy, scan, or print a document. Verify the document copies, scans, or prints correctly.

## Remove the document feeder (ADF) front cover

Follow these steps to remove the document feeder (ADF) front cover.

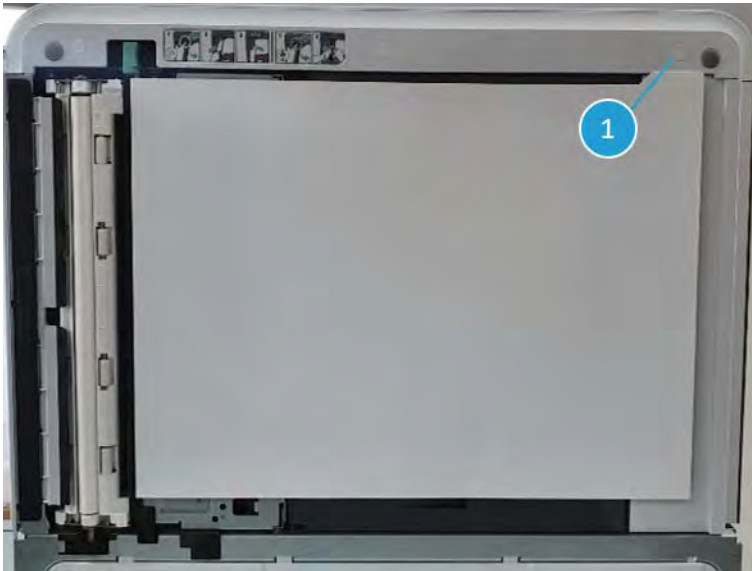
1. Remove two screws from the top of document feeder front cover.

Figure 2-421 Remove the document feeder front cover top screws



2. Open the document feeder. Detach a sticker and then remove a screw (Callout 1) from the bottom of the document feeder front cover.

Figure 2-422 Open the document feeder



3. Remove the document feeder front cover.

Figure 2-423 Remove the document feeder front cover

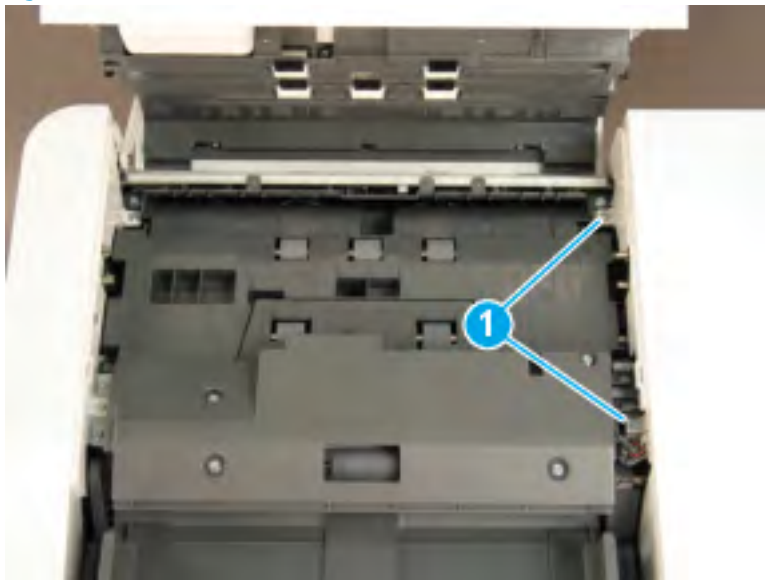


### Remove the document feeder back cover

Follow these steps to remove the document feeder back cover.

1. Remove two screws from the top of document feeder back cover.

Figure 2-424 Remove the document feeder back cover top screws



2. Remove three screws from the bottom of the document feeder back cover, and then remove the document feeder back cover.

**Figure 2-425** Remove the document feeder back cover bottom screws

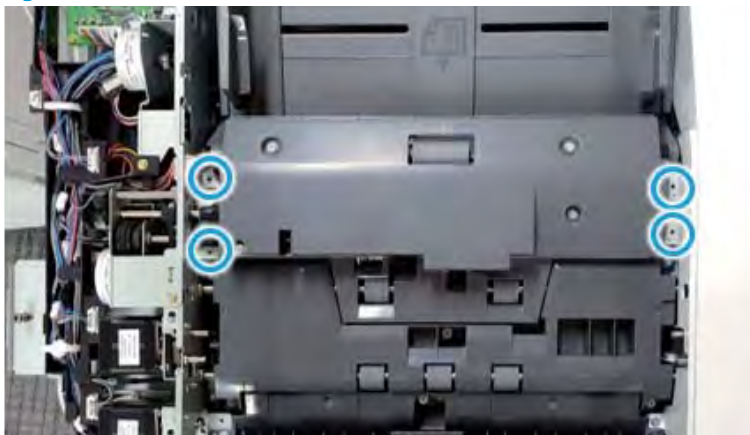


### Remove the document feeder pickup and feed assembly

Follow these steps to remove the document feeder pickup and feed assembly.

1. Remove 4 screws.

**Figure 2-426** Remove 4 screws.




2. Remove 2 cables (callout 1) then remove the document feeder pickup roller assembly



Figure 2-427 Remove the pickup roller assembly



 **TIP:** Re-assembly

- Make sure shape of both the holes on the assembly and the shafts at the frame.

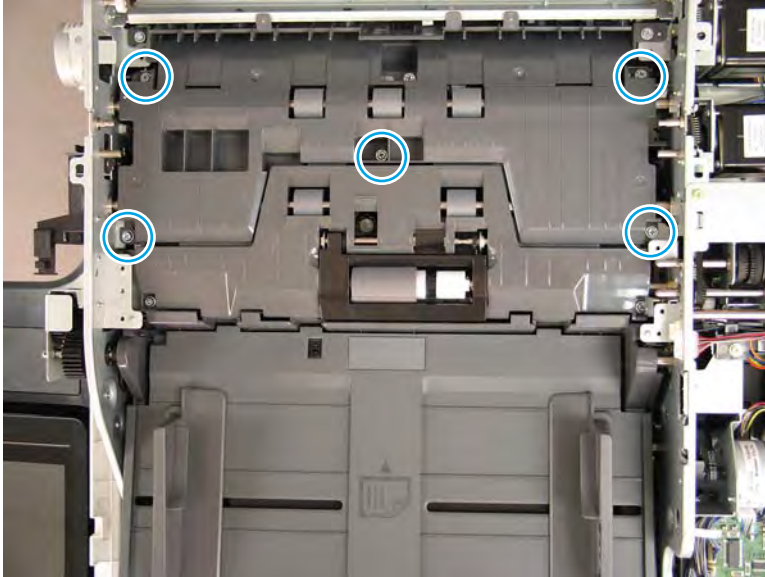


## Remove the paper path cover

Follow these steps to remove the paper path cover.

- ▲ Remove five screws, and then remove the paper path cover.

Figure 2-428 Remove the document feeder paper path cover



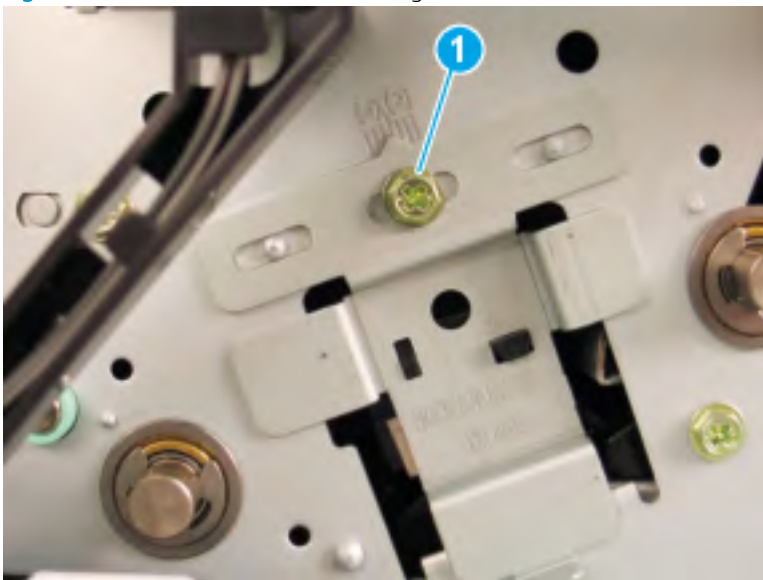
## Remove the CIS assembly

Follow these steps to remove the CIS assembly.

1. Remove one screw, and then remove the CIS front alignment cover.

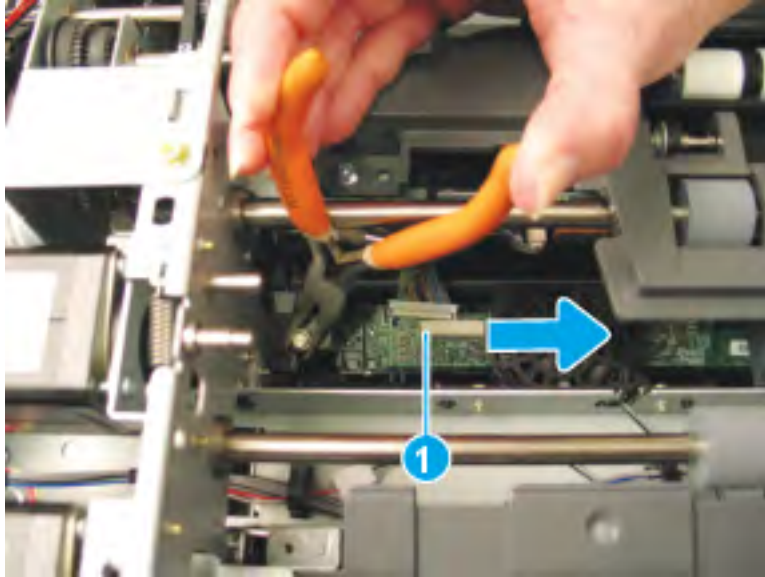
 **TIP:** Note the orientation of the CIS front alignment cover for reinstallation; the cover must be reinstalled with the same orientation.

Figure 2-429 Remove the CIS front alignment cover screws



2. Do the following:
  - a. Disconnect one connector (callout 1).
  - b. Use a pair of needle nose pliers to pull up on the metal pin, and then slide the CIS as shown below to remove it.

Figure 2-430 Remove the CIS



3. Remove the CIS assembly from the chassis.

## Unpack the replacement assembly

Follow these steps to unpack the replacement assembly.

1. Dispose of the defective part.

---



 **NOTE:** HP recommends responsible disposal of the defective part.


<http://www8.hp.com/us/en/hp-information/environment/product-recycling.html>


---

2. Unpack the replacement part from the packaging.

---

 **CAUTION:**  Some parts are sensitive to electrostatic discharge (ESD). Always perform service work at an ESD-protected workstation or mat. If an ESD workstation or mat is not available, touch the sheet-metal chassis to provide a static ground before touching an ESD-sensitive assembly. Protect the ESD-sensitive assemblies by placing them in ESD pouches when they are out of the printer.


 **IMPORTANT:** Make sure that all of the shipping materials (for example shipping tape) are removed from the replacement part prior to installation.

 **NOTE:** If the replacement part is a roller or pad, avoid touching the spongy part of it. Skin oils on the roller or pad can cause paper pickup and/or print-quality problems. HP recommends using disposable gloves when handling rollers or pads or washing your hands before touching rollers or pads.

---

3. To install an assembly, reverse the removal steps.

---

 **NOTE:** When applicable, special installation instructions are provided for an assembly at the end of the removal procedure. Always completely read the removal instructions and follow all special installation instructions.

---

## Flow ADF open cover (GX/sGX)

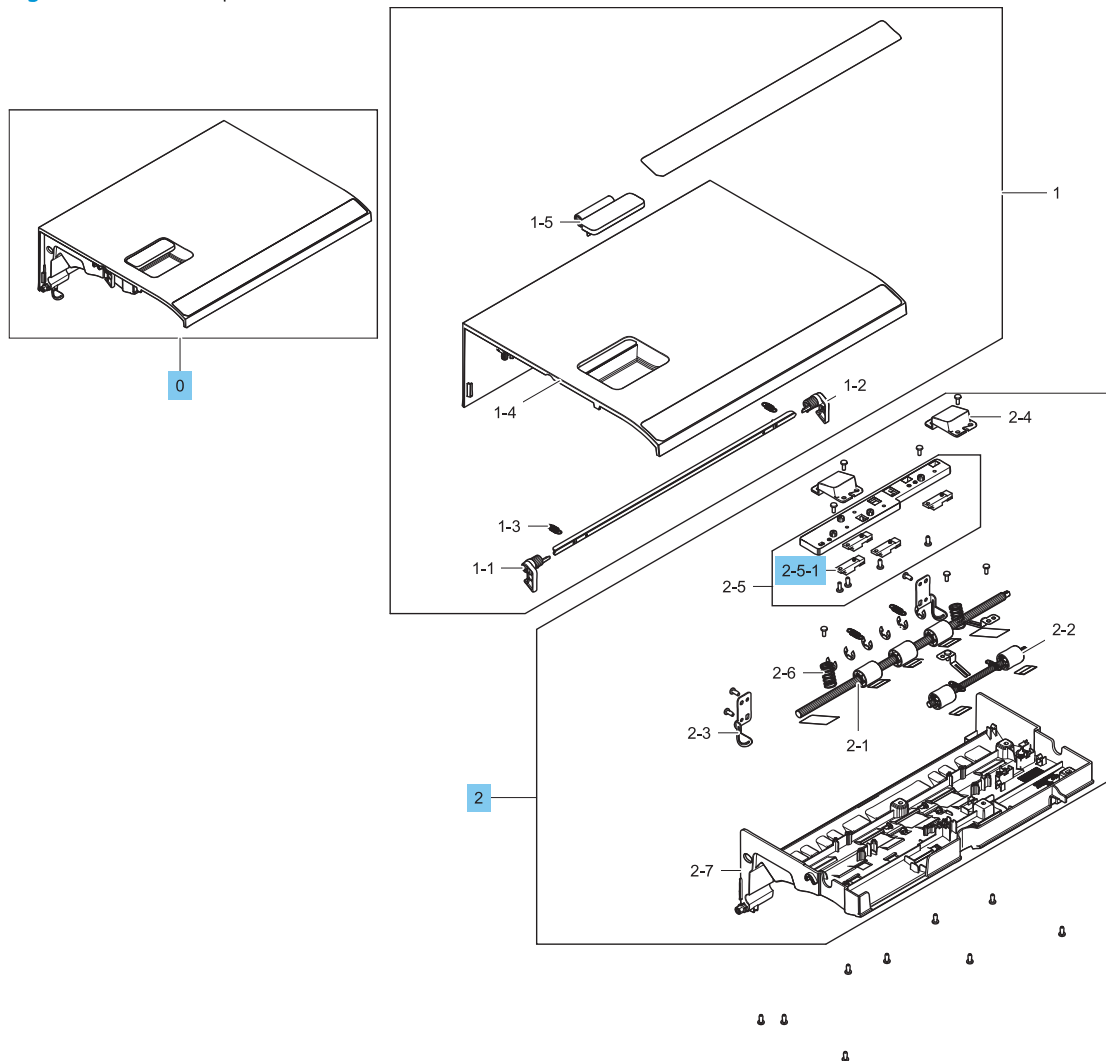
View the flow ADF open cover (GX/sGX) exploded view, parts list, and repair procedures.



## Flow ADF open cover (GX/z)

Parts diagram and parts list for the ADF open cover (GX/z).

Figure 2-431 ADF open cover (GX/z)



**Table 2-87** Flow ADF open cover

Ref				
No	Part number	Description	Qty	Repair procedure
0	JC97-04869A	Cover, open (GX/z)	1	<a href="#">Removal and replacement: Document feeder jam access cover (GX) on page 554</a>
2	JC97-04696B	Cover, open lower (GX/z)	1	Not applicable
2-5-1	0604-001381	Photo-interrupter	4	Not applicable

## Removal and replacement: Document feeder jam access cover (GX)

This document provides the procedures to remove the jam access cover assembly.


 [View a video of removing and replacing the jam access cover \(E72520-E72530\).](#)

 [View a video of removing and replacing the jam access cover \(E77820-E77830\).](#)

Mean time to repair: 15 minutes

Service level: Intermediate

---

 **IMPORTANT:** When applicable, special installation instructions are provided for an assembly at the end of the removal procedure. Always completely read the removal instructions and follow all special installation instructions.

---

### Before performing service

- Disconnect the power cable.

Use the table below to identify the correct part number for your printer. To order the part, go to [www.hp.com/buy/parts](http://www.hp.com/buy/parts)

**Table 2-88** Part information

Part number	Part description
JC97-04869A	Jam access cover assembly

### Required tools

- #2 JIS screwdriver with a magnetic tip

### After performing service

#### Turn the printer power on

- Connect the power cable.
- Use the power switch to turn the power on.

### Post service test

Copy, scan, or print a document. Verify the document copies, scans, or prints correctly.

### Remove the document feeder (ADF) front cover

Follow these steps to remove the document feeder (ADF) front cover.

1. Remove two screws from the top of document feeder front cover.

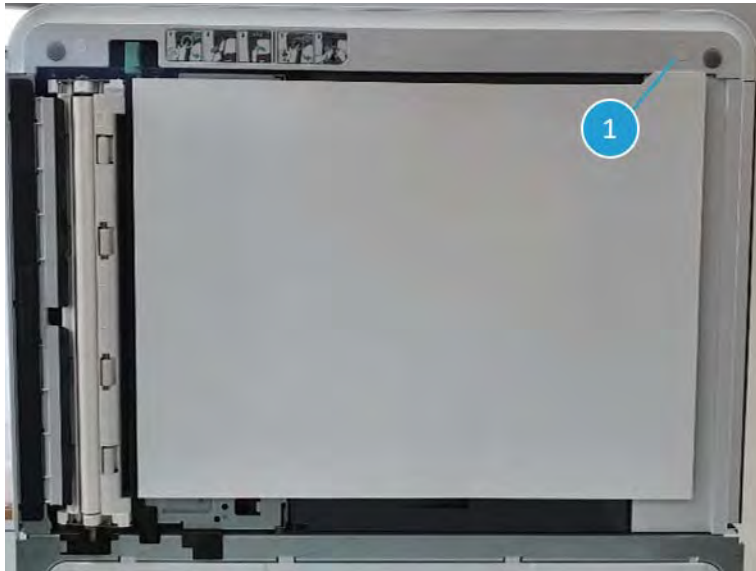


Figure 2-432 Remove the document feeder front cover top screws



2. Open the document feeder. Detach a sticker and then remove a screw (Callout 1) from the bottom of the document feeder front cover.

Figure 2-433 Open the document feeder



3. Remove the document feeder front cover.

**Figure 2-434** Remove the document feeder front cover

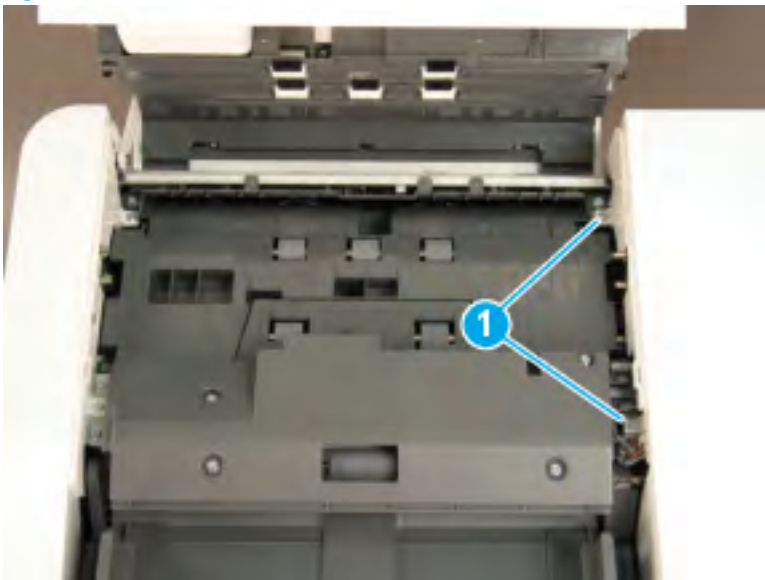


### Remove the document feeder back cover

Follow these steps to remove the document feeder back cover.

1. Remove two screws from the top of document feeder back cover.

**Figure 2-435** Remove the document feeder back cover top screws



2. Remove three screws from the bottom of the document feeder back cover, and then remove the document feeder back cover.

**Figure 2-436** Remove the document feeder back cover bottom screws



### Remove the document feeder jam access cover

Follow these steps to remove the document feeder jam access cover.

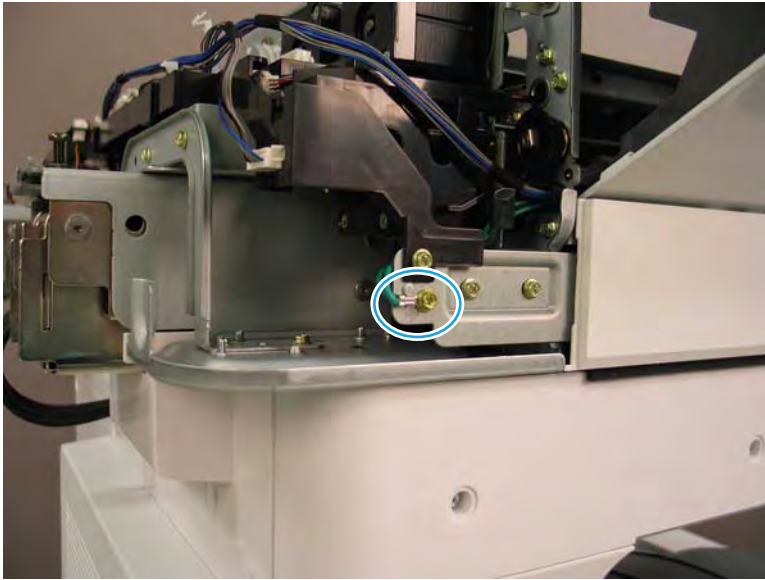
1. Disconnect connector at document feeder PCA and route cable out.

**Figure 2-437** Disconnect one connector



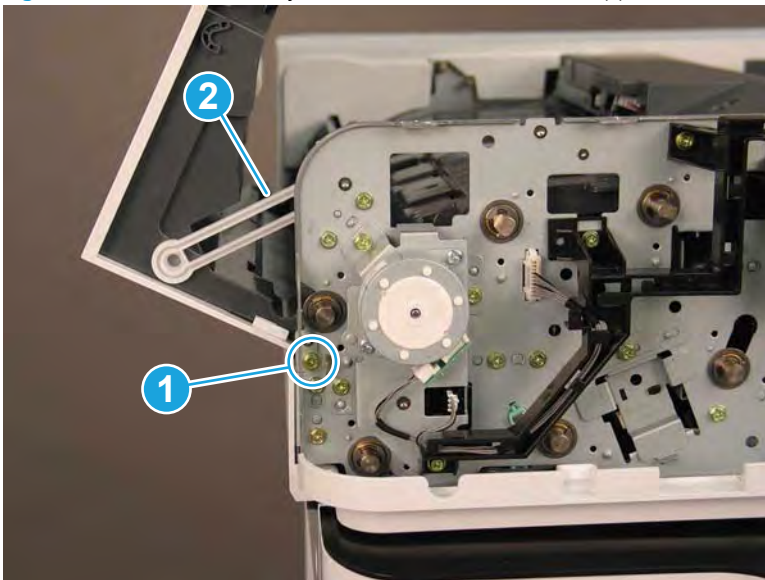
2. Disconnect the ground wire.

**Figure 2-438** Remove the jam access cover ground wire



3. Remove one screw (callout 1), remove hinge (pivot) pin, and then remove door arm support (callout 2)

**Figure 2-439** Remove the jam access cover door arm support



4. Remove the jam access cover.

### Unpack the replacement assembly

Follow these steps to unpack the replacement assembly.

1. Dispose of the defective part.



---

 **NOTE:** HP recommends responsible disposal of the defective part.


<http://www8.hp.com/us/en/hp-information/environment/product-recycling.html>

---

2. Unpack the replacement part from the packaging.


 **CAUTION:**  Some parts are sensitive to electrostatic discharge (ESD). Always perform service work at an ESD-protected workstation or mat. If an ESD workstation or mat is not available, touch the sheet-metal chassis to provide a static ground before touching an ESD-sensitive assembly. Protect the ESD-sensitive assemblies by placing them in ESD pouches when they are out of the printer.

 **IMPORTANT:** Make sure that all of the shipping materials (for example shipping tape) are removed from the replacement part prior to installation.

 **NOTE:** If the replacement part is a roller or pad, avoid touching the spongy part of it. Skin oils on the roller or pad can cause paper pickup and/or print-quality problems. HP recommends using disposable gloves when handling rollers or pads or washing your hands before touching rollers or pads.

---

3. To install an assembly, reverse the removal steps.

 **NOTE:** When applicable, special installation instructions are provided for an assembly at the end of the removal procedure. Always completely read the removal instructions and follow all special installation instructions.

---

## ADF upper pickup (GX/z)

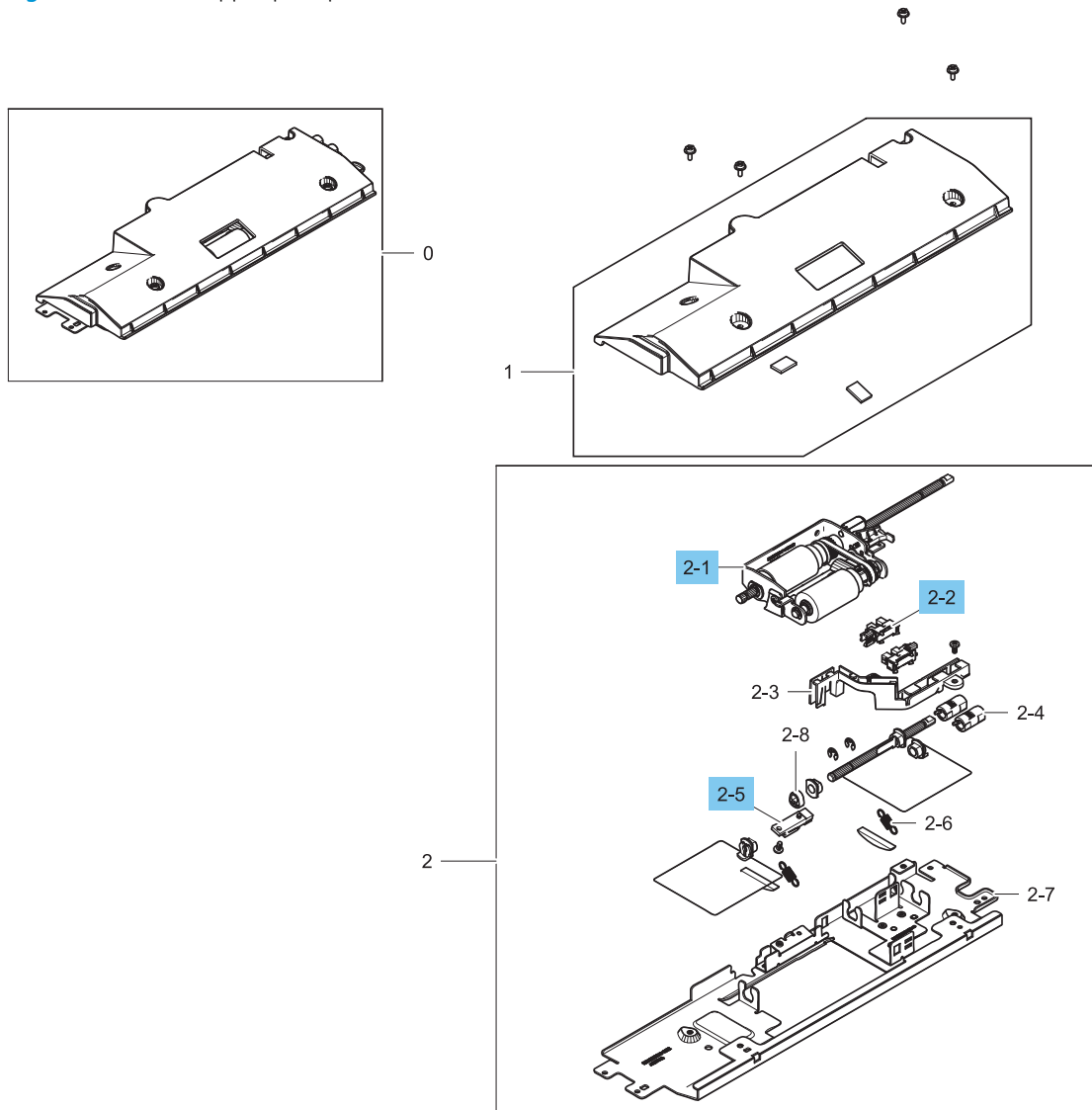
View the ADF upper pickup (GX/z) exploded view, parts list, and repair procedures.



## ADF upper pickup (GX/z)

Parts diagram and parts list for the ADF upper pickup (GX/z).

Figure 2-440 ADF upper pickup (GX/z)





**Table 2-89** ADF upper pickup (GX/z)

Ref				
No	Part number	Description	Qty	Repair procedure
2-1	JC97-04650A	GX/z ADF, sub-pickup	1	<a href="#">Removal and replacement: Flow document feeder pick roller assembly (GX) on page 564</a>
2-2	0604-001393	Photo-interrupter	1	Not applicable
2-5	0604-001381	Photo-interrupter	1	Not applicable
Not shown	JC97-04915A	Document feeder separation roller assembly (GX/z models)	1	<a href="#">Removal and replacement: ADF separation roller assembly (GX) on page 569</a>

## Removal and replacement: Flow document feeder pick roller assembly (GX)

This document provides the procedures to remove the flow document feeder pickup roller assembly.



[View a video of removing and replacing the pick roller \(E77822-E77830\).](#)

Mean time to repair: 10 minutes

Service level: Basic



**IMPORTANT:** When applicable, special installation instructions are provided for an assembly at the end of the removal procedure. Always completely read the removal instructions and follow all special installation instructions.

### Before performing service

- Disconnect the power cable.

Use the table below to identify the correct part number for your printer. To order the part, go to [www.hp.com/buy/parts](http://www.hp.com/buy/parts)

**Table 2-90 Part information**

Part number	Part description
JC97-04650A	Pick roller assembly (GX/z models)

### Required tools

- #2 JIS screwdriver with a magnetic tip

### After performing service

#### Turn the printer power on

- Connect the power cable.
- Use the power switch to turn the power on.

### Post service test

Copy, scan, or print a document. Verify the document copies, scans, or prints correctly.

## Remove the flow ADF pickup roller assembly

Follow these steps to remove the flow ADF pickup roller assembly.

1. Open the document feeder top cover.
2. Remove the pickup roller assembly:
  - a. Remove 4 screws.

Figure 2-441 Remove 4 screws.




- b. Remove 2 cables (callout 1) then remove the document feeder pickup roller assembly

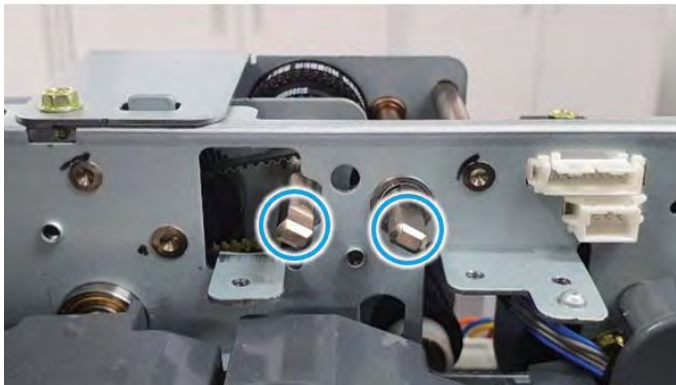
Figure 2-442 Remove the pickup roller assembly



---

 **TIP:** Re-assembly

- Make sure shape of both the holes on the assembly and the shafts at the frame.

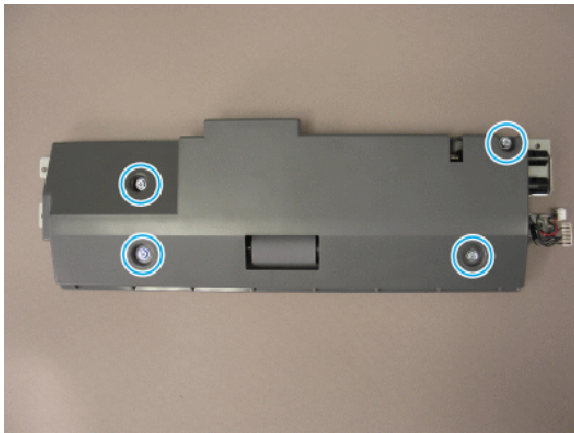


---


3. Remove the pickup rollers:

- a. Remove four screws and then remove the cover.

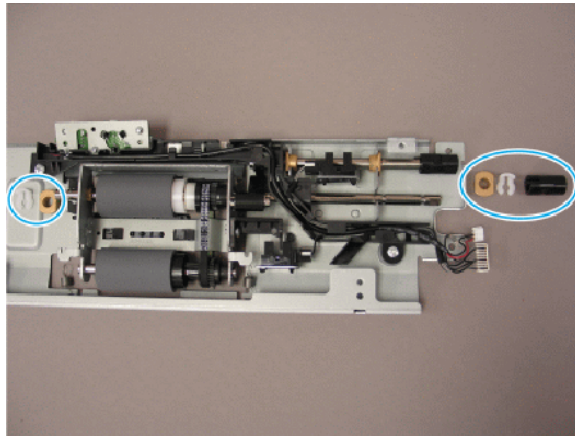
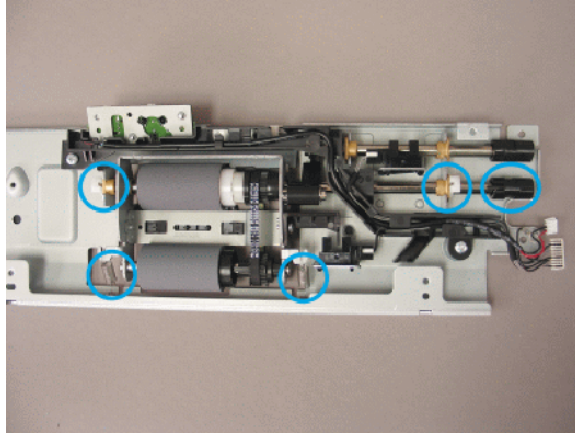
**Figure 2-443** Remove the pickup roller assembly cover



- b. Remove two plastic clips and two bushings, disconnect two springs, and then remove the shaft coupler.

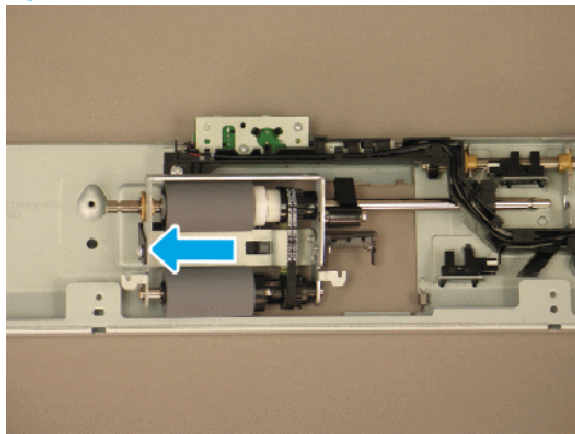
 **NOTE:** The shaft is engaged in the coupler.

**Figure 2-444** Remove the pickup roller components



- c. Slide the roller shaft and then remove the pickup roller assembly.

**Figure 2-445** Remove the pickup roller assembly



- 4. Reverse the removal steps to install the assembly.

## Unpack the replacement assembly

Follow these steps to unpack the replacement assembly.

1. Dispose of the defective part.




**NOTE:** HP recommends responsible disposal of the defective part.

<http://www8.hp.com/us/en/hp-information/environment/product-recycling.html>

---

2. Unpack the replacement part from the packaging.



**CAUTION:**  Some parts are sensitive to electrostatic discharge (ESD). Always perform service work at an ESD-protected workstation or mat. If an ESD workstation or mat is not available, touch the sheet-metal chassis to provide a static ground before touching an ESD-sensitive assembly. Protect the ESD-sensitive assemblies by placing them in ESD pouches when they are out of the printer.



**IMPORTANT:** Make sure that all of the shipping materials (for example shipping tape) are removed from the replacement part prior to installation.



**NOTE:** If the replacement part is a roller or pad, avoid touching the spongy part of it. Skin oils on the roller or pad can cause paper pickup and/or print-quality problems. HP recommends using disposable gloves when handling rollers or pads or washing your hands before touching rollers or pads.

---

3. To install an assembly, reverse the removal steps.



**NOTE:** When applicable, special installation instructions are provided for an assembly at the end of the removal procedure. Always completely read the removal instructions and follow all special installation instructions.

---

## Reverse the removal steps to install the assembly

Also use the following **special installation instructions**.

## Removal and replacement: ADF separation roller assembly (GX)


This document provides the procedures to remove the flow document feeder separation roller assembly.

 [View a video of removing and replacing the separation roller \(E72525-E72535\).](#)

 [View a video of removing and replacing the separation roller \(E77822-E77830\).](#)

Mean time to repair: 10 minutes

Service level: Basic

 **IMPORTANT:** When applicable, special installation instructions are provided for an assembly at the end of the removal procedure. Always completely read the removal instructions and follow all special installation instructions.

### Before performing service

- Disconnect the power cable.

Use the table below to identify the correct part number for your printer. To order the part, go to [www.hp.com/buy/parts](http://www.hp.com/buy/parts)

Table 2-91 Part information

Part number	Part description
JC97-04915A	Separation roller assembly (GX/z)

### Required tools

- #2 JIS screwdriver with a magnetic tip

### After performing service

#### Turn the printer power on

- Connect the power cable.
- Use the power switch to turn the power on.

### Post service test

Copy, scan, or print a document. Verify the document copies, scans, or prints correctly.

## Remove the flow ADF pickup roller assembly

Follow these steps to remove the flow ADF pickup roller assembly.

1. Open the document feeder top cover.
2. Remove the pickup roller assembly:
  - a. Remove 4 screws.

Figure 2-446 Remove 4 screws.



- b. Remove 2 cables (callout 1) then remove the document feeder pickup roller assembly

Figure 2-447 Remove the pickup roller assembly

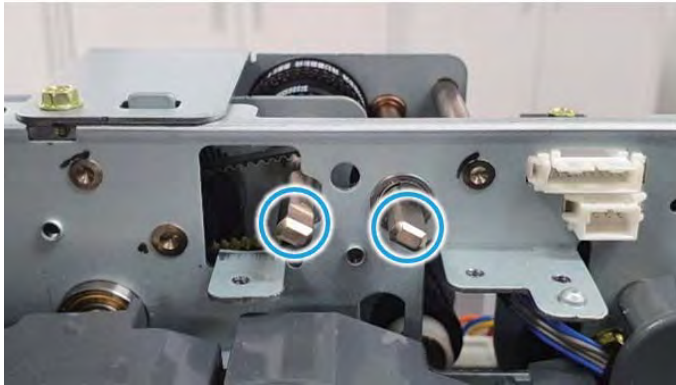




---

💡 **TIP:** Re-assembly

- Make sure shape of both the holes on the assembly and the shafts at the frame.

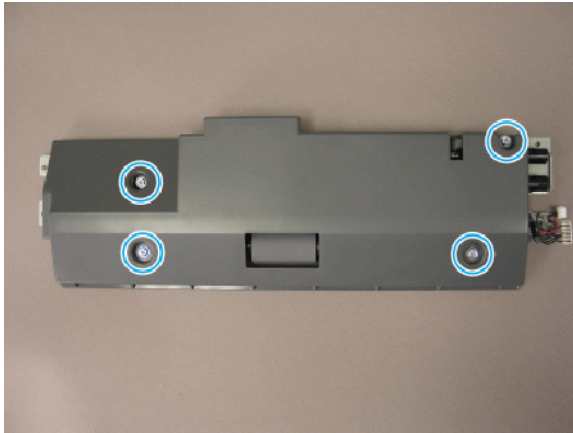


---


3. Remove the pickup rollers:

- a. Remove four screws and then remove the cover.

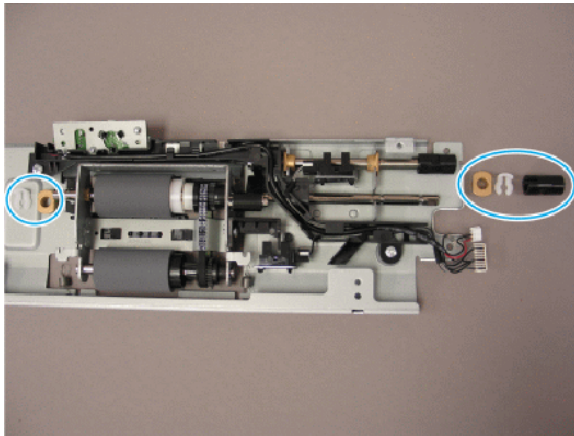
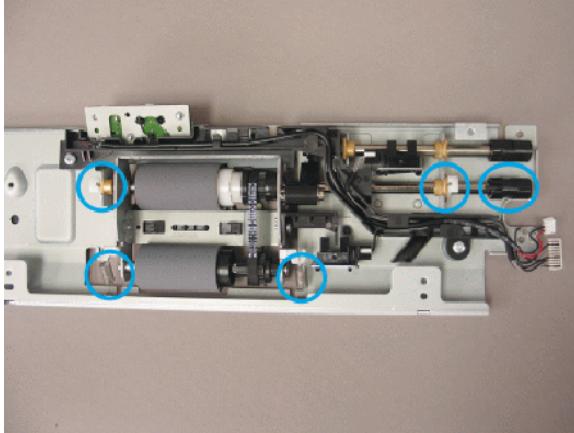
**Figure 2-448** Remove the pickup roller assembly cover



- b. Remove two plastic clips and two bushings, disconnect two springs, and then remove the shaft coupler.

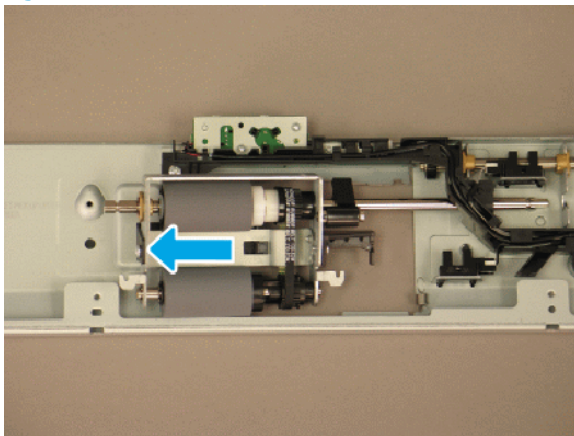
 **NOTE:** The shaft is engaged in the coupler.

**Figure 2-449** Remove the pickup roller components



- c. Slide the roller shaft and then remove the pickup roller assembly.

**Figure 2-450** Remove the pickup roller assembly



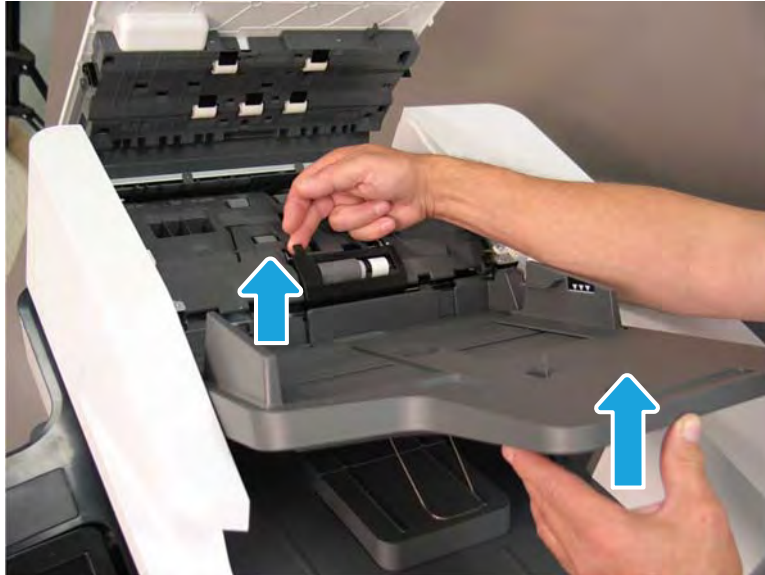
4. Reverse the removal steps to install the assembly.

## Remove the flow ADF separation roller assembly

Follow these steps to remove the flow ADF separation roller assembly.

1. Slightly lift the input tray, and then remove the separation roller cover.

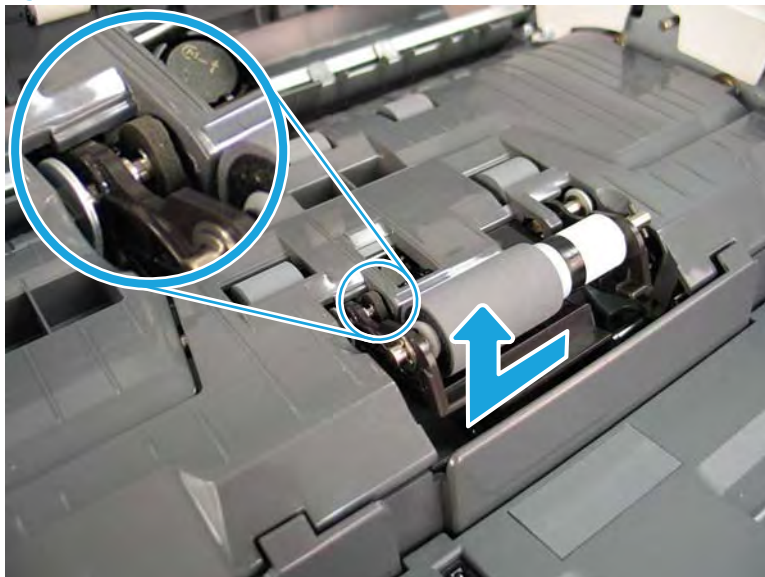
**Figure 2-451** Remove the separation roller cover



2. Remove one plastic clip.

 **NOTE:** The shaft is engaged in the coupler.

**Figure 2-452** Remove one plastic clip



3. Slide the roller assembly to the front, and then pull up to release the claws from the shaft.

 **Reinstallation tip:** Position the spring and shaft before attaching the claws to the shaft.

---

**Figure 2-453** Release the separation roller



4. Remove the separation roller.


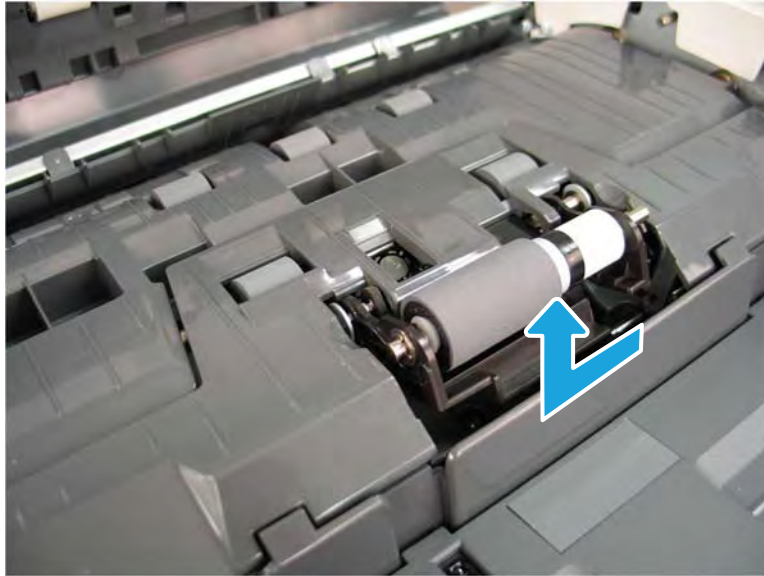
 **NOTE:** Make sure that the sponge washer (circled in a previous step) is retained during the removal of the roller assembly—it might fall off.

Figure 2-454 Remove the separation roller



 **TIP:** Re-assembly tip

Put the spring to the arrow direction at the bottom of the holder.



Insert the spring at the hole carefully.



Push the separation roller assembly to the bottom (Callout 1), then insert the assembly (2 joints) to the shaft (Callout 2)

## Unpack the replacement assembly

Follow these steps to unpack the replacement assembly.

1. Dispose of the defective part.




**NOTE:** HP recommends responsible disposal of the defective part.

<http://www8.hp.com/us/en/hp-information/environment/product-recycling.html>

---

2. Unpack the replacement part from the packaging.



**CAUTION:**  Some parts are sensitive to electrostatic discharge (ESD). Always perform service work at an ESD-protected workstation or mat. If an ESD workstation or mat is not available, touch the sheet-metal chassis to provide a static ground before touching an ESD-sensitive assembly. Protect the ESD-sensitive assemblies by placing them in ESD pouches when they are out of the printer.



**IMPORTANT:** Make sure that all of the shipping materials (for example shipping tape) are removed from the replacement part prior to installation.



**NOTE:** If the replacement part is a roller or pad, avoid touching the spongy part of it. Skin oils on the roller or pad can cause paper pickup and/or print-quality problems. HP recommends using disposable gloves when handling rollers or pads or washing your hands before touching rollers or pads.

---

3. To install an assembly, reverse the removal steps.



**NOTE:** When applicable, special installation instructions are provided for an assembly at the end of the removal procedure. Always completely read the removal instructions and follow all special installation instructions.

---

## Reverse the removal steps to install the assembly

Also use the following **special installation instructions**.

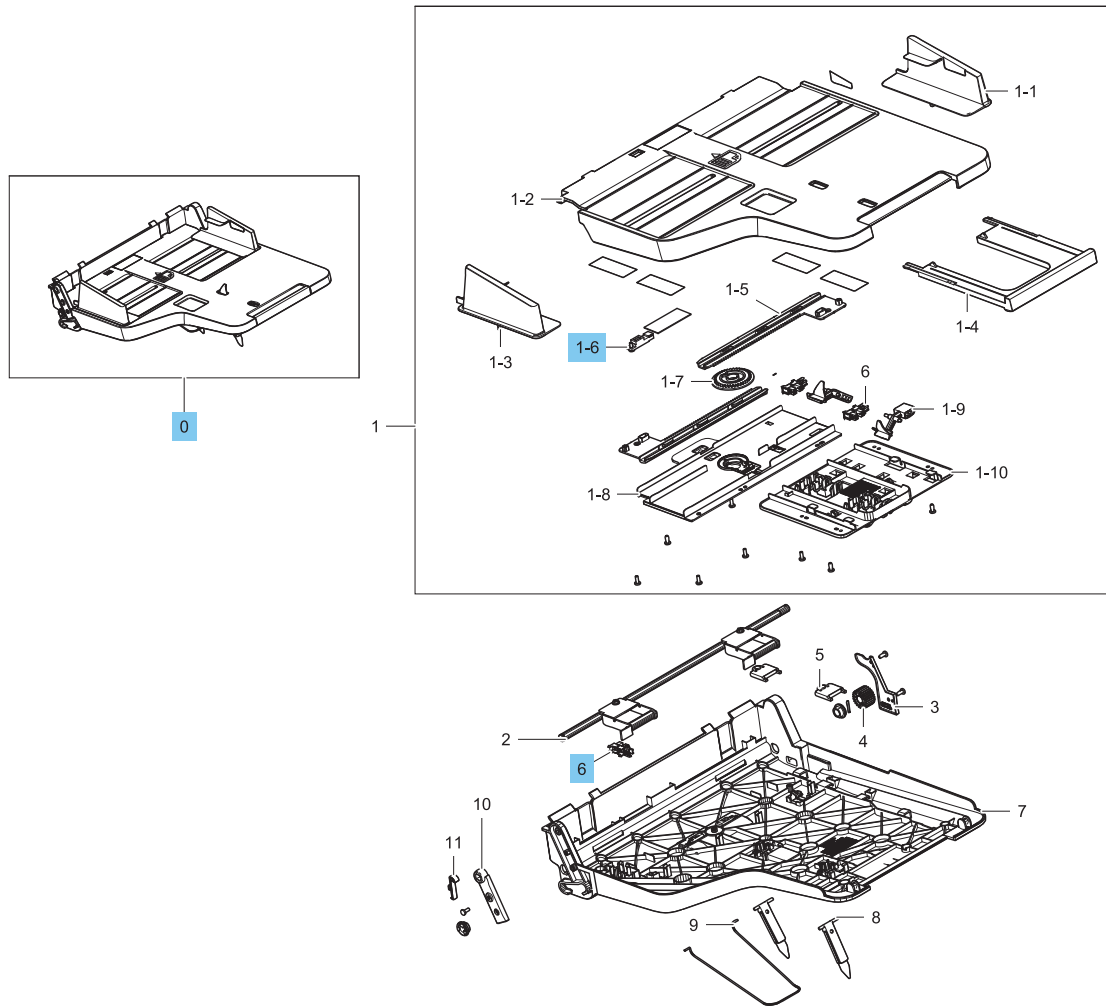
## Flow ADF stacker (GX/z)

View the flow ADF stacker (GX/z) exploded view, parts list, and repair procedures.

# Flow ADF stacker (GX/sGX)

Parts diagram and parts list for the flow ADF stacker (GX/sGX).

Figure 2-455 Flow ADF stacker (GX/sGX)





**Table 2-92** Flow ADF stacker

Ref				
No	Part number	Description	Qty	Repair procedure
0	JC97-04658C	GX/z Flow ADF stacker	1	<a href="#">Removal and replacement: Document feeder input tray (GX) on page 536</a>
1-6	0604-001381	Photo-interrupter	1	Not applicable
6	0604-001393	Photo-interrupter	1	Not applicable
Not shown	JC82-00693A	Flow ADF - stacker upper CM	1	Not applicable

## Flow ADF main frame (GX/z)

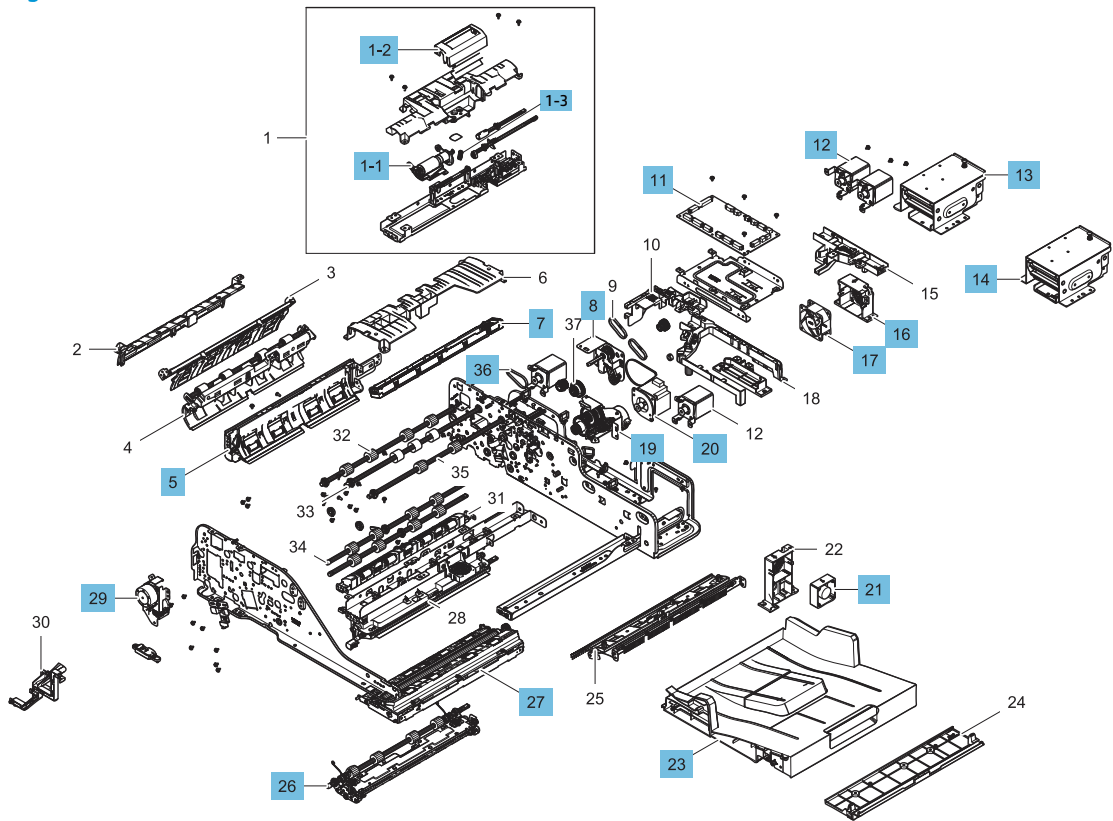
View the flow ADF main frame (GX/z) exploded view, parts list, and repair procedures.



## ADF main frame (GX/z)

Parts diagram and parts list for the ADF main frame (GX/z)

Figure 2-456 ADF main frame (GX/z)



**Table 2-93 ADF main frame (GX/z)**

Ref	Part number	Description	Qty	Repair procedure
1-1	JC97-04915A	GX Separation Roller Assy	1	<a href="#">Removal and replacement: ADF separation roller assembly (GX) on page 569</a>
1-2	JC97-04652A	GX ADF - Separation Roller Cover	1	Not applicable
1-3	JC61-08235A	Spring CS	1	Not applicable
5	JC97-04656B	GX ADF scan in lower	1	Not applicable
7	0605-001246	Contact Image Sensor (CIS) assembly	1	Not applicable
8	JC97-04681A	GX ADF, pickup release drive	1	<a href="#">Removal and replacement: Document feeder rear motors (GX) on page 589</a>
11	JC92-02964A	GX ADF, PCA	1	<a href="#">Removal and replacement: PCA-ADF HIC (GX) on page 612</a>
12	JC97-04680A	GX ADF, feed drive motor	4	<a href="#">Removal and replacement: Document feeder rear motors (GX) on page 589</a>
13	JC97-04640A	GX ADF, hinge L	1	Not applicable
14	JC97-04641A	GX ADF, hinge R	1	Not applicable
16	JC61-07694A	GX Fan motor housing	1	Not applicable
17	JC31-00168A	Fan, ADF CIS	1	<a href="#">Removal and replacement: Document feeder contact image sensor (CIS) fan (GX) on page 601</a>
19	JC97-04679A	GX ADF, lift drive	1	<a href="#">Removal and replacement: Document feeder rear motors (GX) on page 589</a>
20	JC31-00177A	GX Step motor, ip	1	<a href="#">Removal and replacement: Document feeder front motor (GX) on page 585</a>
21	JC31-00146A	Fan type 4, ADF PCA (GX)	1	<a href="#">Removal and replacement: Document feeder PCA fan (GX) on page 598</a>
23	JC97-04668B	GX ADF - Input Tray	1	Not applicable
26	JC97-04687A	GX ADF, white simplex roller	1	Not applicable
27	JC97-04830A	GX ADF scan out	1	Not applicable
29	JC97-04682A	GX ADF - Motor Drive Release Scan	1	Not applicable
36	6602-001730	Timing belt, gear	3	Not applicable
Not shown	JC92-02965A	PCA - ADF HIC (GX only)	1	<a href="#">Removal and replacement: Flow ADF ultrasonic sensor with PCA (GX) on page 604</a>

**Table 2-93** ADF main frame (GX/z) (continued)

Ref				
No	Part number	Description	Qty	Repair procedure
Not shown	JC92-02967A	PCA - ADF Receiver (GX only)	1	<a href="#">Removal and replacement: Flow ADF ultrasonic sensor with PCA (GX) on page 604</a>
Not shown	JC92-02966A	PCA - ADF Transmitter (GX only)	1	<a href="#">Removal and replacement: Flow ADF ultrasonic sensor with PCA (GX) on page 604</a>

# Removal and replacement: Removal and replacement: Document feeder front motor (GX)

This document provides the procedures to remove the front motor assembly.



[View a video of removing and replacing the motor \(E77820-E77830\).](#)

Mean time to repair: 25 minutes

Service level: Advanced



**IMPORTANT:** When applicable, special installation instructions are provided for an assembly at the end of the removal procedure. Always completely read the removal instructions and follow all special installation instructions.

## Before performing service

- Disconnect the power cable.

Use the table below to identify the correct part number for your printer. To order the part, go to [www.hp.com/buy/parts](http://www.hp.com/buy/parts)

Table 2-94 Part information

Part number	Part description
JC31-00177A	Front motor assembly

## Required tools

- #2 JIS screwdriver with a magnetic tip

## After performing service

### Turn the printer power on

- Connect the power cable.
- Use the power switch to turn the power on.

## Post service test

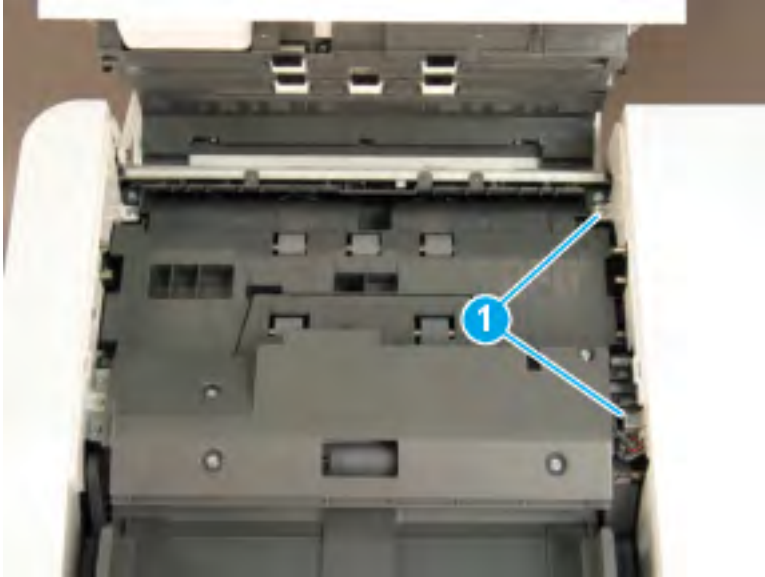
Copy, scan, or print a document. Verify the document copies, scans, or prints correctly.

## Remove the document feeder back cover

Follow these steps to remove the document feeder back cover.

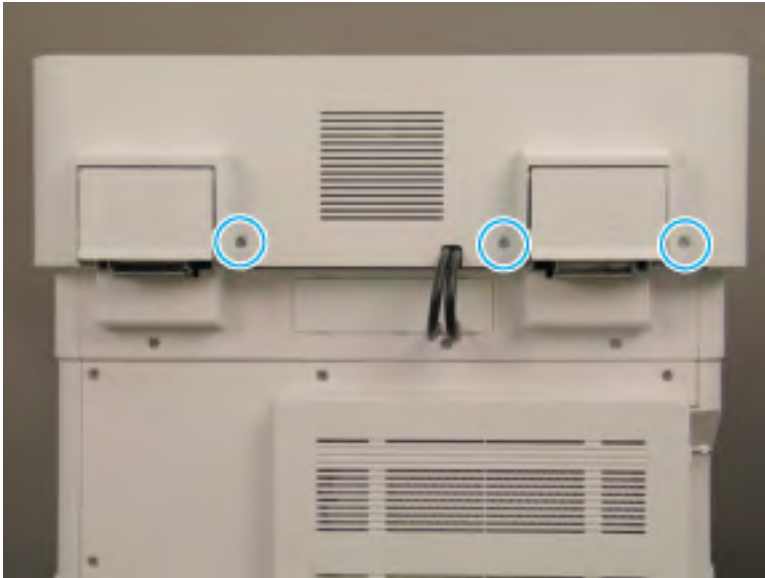
1. Remove two screws from the top of document feeder back cover.

Figure 2-457 Remove the document feeder back cover top screws



2. Remove three screws from the bottom of the document feeder back cover, and then remove the document feeder back cover.

Figure 2-458 Remove the document feeder back cover bottom screws



### Remove the front motor

Follow these steps to remove the front motor.

- ▲ Remove two screws and disconnect one connector, and then remove the motor.

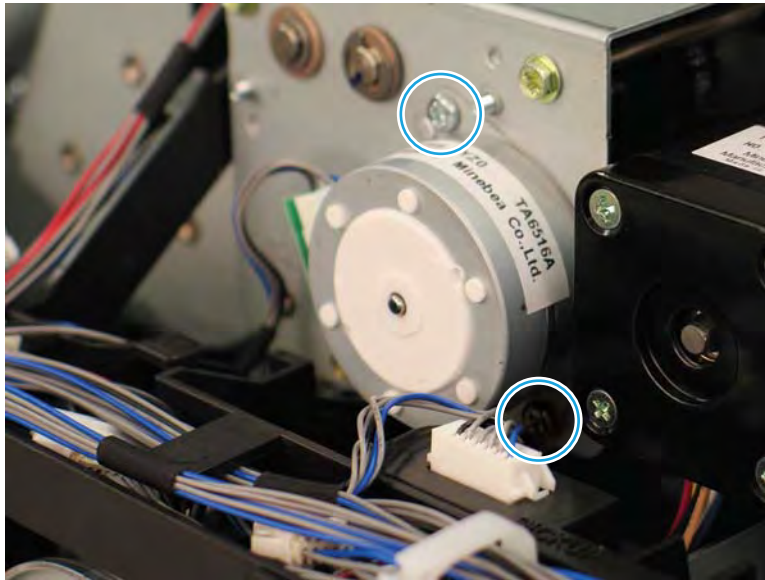


---

 **Reinstallation tip:**

- a. Reinstall the motor and lift the gear belt up to engage the motor pulley.
  - b. Loosely install the motor mount screws.
  - c. Install the tension spring.
  - d. Tighten the motor mount screws just enough so that the tension spring (not the motor mount screws) is providing the tension to the belt.
- 

**Figure 2-459** Remove the document feeder front motor



## Unpack the replacement assembly

Follow these steps to unpack the replacement assembly.

1. Dispose of the defective part.

---



 **NOTE:** HP recommends responsible disposal of the defective part.


<http://www8.hp.com/us/en/hp-information/environment/product-recycling.html>


---

2. Unpack the replacement part from the packaging.

---

 **CAUTION:**  Some parts are sensitive to electrostatic discharge (ESD). Always perform service work at an ESD-protected workstation or mat. If an ESD workstation or mat is not available, touch the sheet-metal chassis to provide a static ground before touching an ESD-sensitive assembly. Protect the ESD-sensitive assemblies by placing them in ESD pouches when they are out of the printer.


 **IMPORTANT:** Make sure that all of the shipping materials (for example shipping tape) are removed from the replacement part prior to installation.

 **NOTE:** If the replacement part is a roller or pad, avoid touching the spongy part of it. Skin oils on the roller or pad can cause paper pickup and/or print-quality problems. HP recommends using disposable gloves when handling rollers or pads or washing your hands before touching rollers or pads.

---

3. To install an assembly, reverse the removal steps.

---

 **NOTE:** When applicable, special installation instructions are provided for an assembly at the end of the removal procedure. Always completely read the removal instructions and follow all special installation instructions.

---

## Removal and replacement: Document feeder rear motors (GX)


This document provides the procedures to remove the rear motor assemblies.

 [View a video of removing and replacing the motors \(E72520-E72530\).](#)

 [View a video of removing and replacing the motors \(E77820-E77830\).](#)

Mean time to repair: 15 minutes

Service level: Intermediate

 **IMPORTANT:** When applicable, special installation instructions are provided for an assembly at the end of the removal procedure. Always completely read the removal instructions and follow all special installation instructions.

### Before performing service

- Disconnect the power cable.

Use the table below to identify the correct part number for your printer. To order the part, go to [www.hp.com/buy/parts](http://www.hp.com/buy/parts)

**Table 2-95** Part information

Part number	Part description
JC97-04679A	Motor 1 - Flow ADF drive
JC97-04681A	Motor 2 -Flow ADF drive release pickup
JC97-04680A	Pickup motor
C97-04680A	Pre_REGI motor
JC97-04680A	Exit motor
JC97-04680A	Feed motor
JC31-00177A	REGI motor

### Required tools

- #2 JIS screwdriver with a magnetic tip

### After performing service

#### Turn the printer power on

- Connect the power cable.
- Use the power switch to turn the power on.

### Post service test

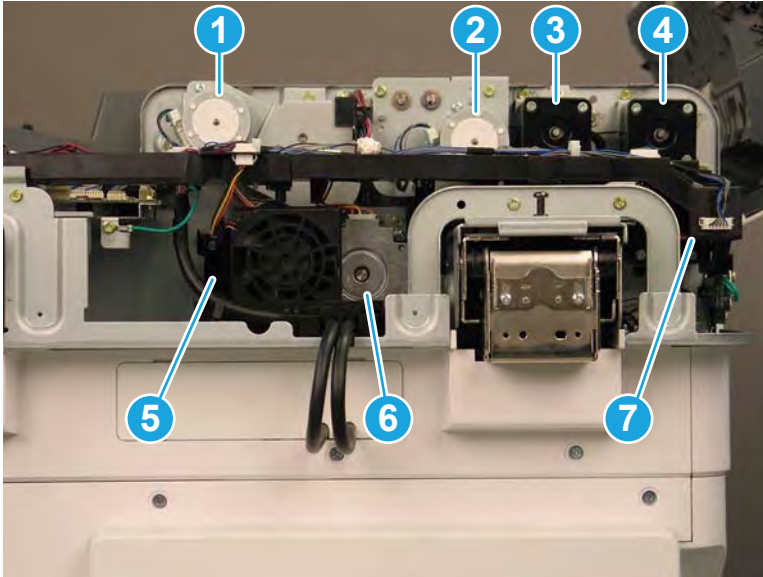
Copy, scan, or print a document. Verify the document copies, scans, or prints correctly.

## Identify the document feeder motors

Follow these steps to identify the document feeder motors.

- ▲ Use the figure below to locate the motor.

Figure 2-460 Document feeder motors identification



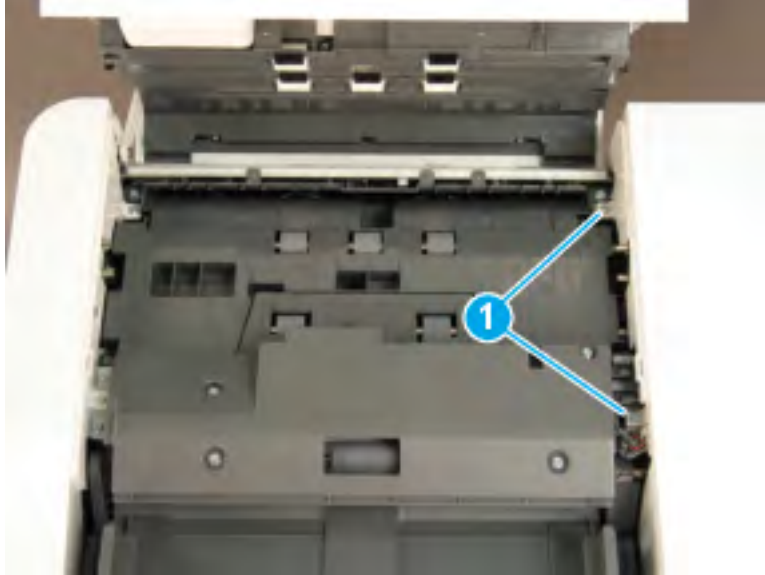
Callout	Description
1	Motor 1
2	Motor 2
3	Pickup motor
4	Pre-REGI motor
5	Exit motor
6	Feed motor
7	REGI motor

## Remove the document feeder back cover

Follow these steps to remove the document feeder back cover.

1. Remove two screws from the top of document feeder back cover.

Figure 2-461 Remove the document feeder back cover top screws



2. Remove three screws from the bottom of the document feeder back cover, and then remove the document feeder back cover.

Figure 2-462 Remove the document feeder back cover bottom screws



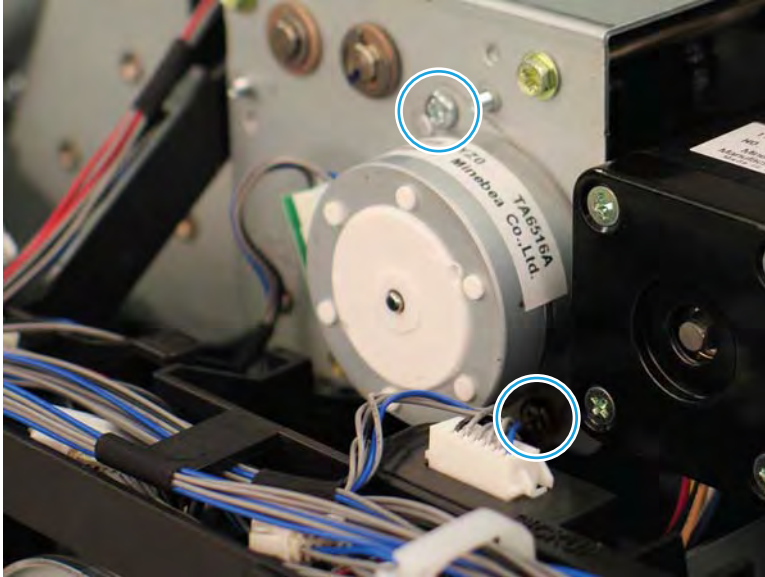
## Remove motors 1 and 2

Follow these steps to remove motors 1 and 2.

- ▲ Remove two screws and one connector, and then remove the motor.

 **Reinstallation tip:** Reinstall the motor and lift the gear belt up to engage the motor pulley.

Figure 2-463 Remove the motor



## Remove the pickup and pre-REGI motors

Follow these steps to remove the pickup and pre-REGI motors.

1. Loosen the cable retainer, and then disconnect one connector from the motor.


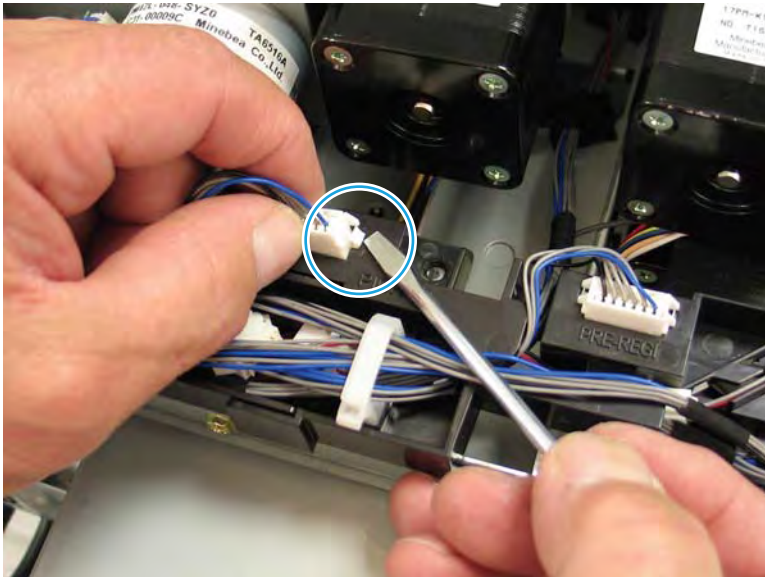
 **TIP:** Remove the connector harness from the retainer, and then disconnect the connector.

Figure 2-464 Disconnect one connector



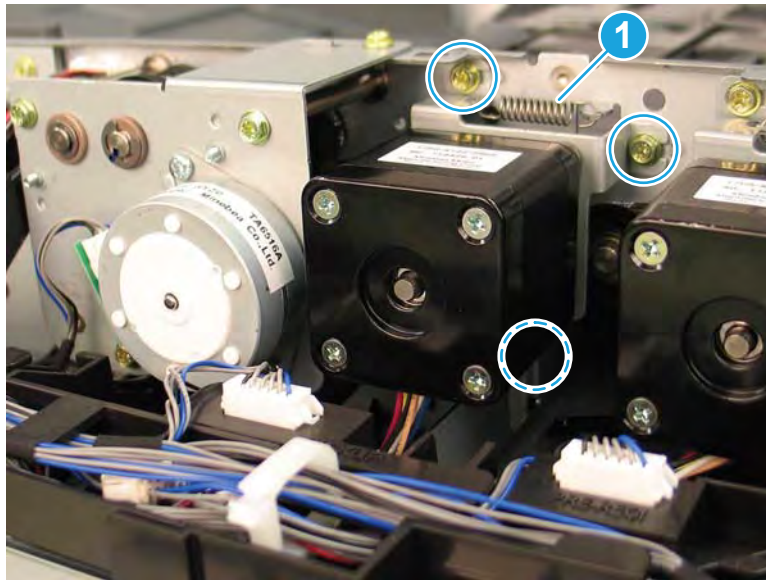
2. Remove one spring (callout 1), and then loosen (but do not remove) three screws. Slide the pickup motor off the screws to remove it.

---

 **NOTE:**

- Reinstall the motor on the motor mounting screws, and then lift the gear belt up to engage the motor pulley.
  - Install the tension spring.
  - Tighten the motor mount screws just enough so that the tension spring (not the motor mount screws) is providing the tension to the belt.
- 

Figure 2-465 Pickup motor



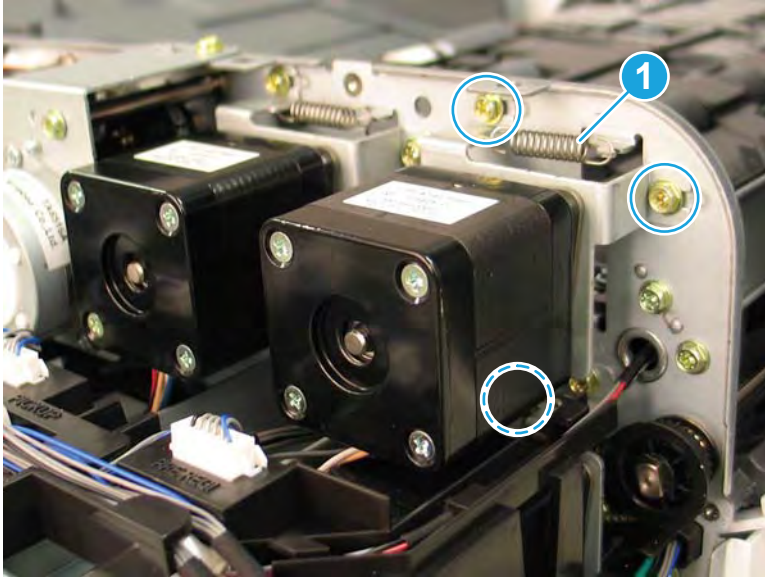
3. Remove one spring (callout 1), and then loosen (but do not remove) three screws. Slide the pre-REGI motor off the screws to remove it.

---

 **NOTE:**

- Reinstall the motor on the motor mounting screws, and then lift the gear belt up to engage the motor pulley.
  - Install the tension spring.
  - Tighten the motor mount screws just enough so that the tension spring (not the motor mount screws) is providing the tension to the belt.
-

Figure 2-466 Pre-REGI motor

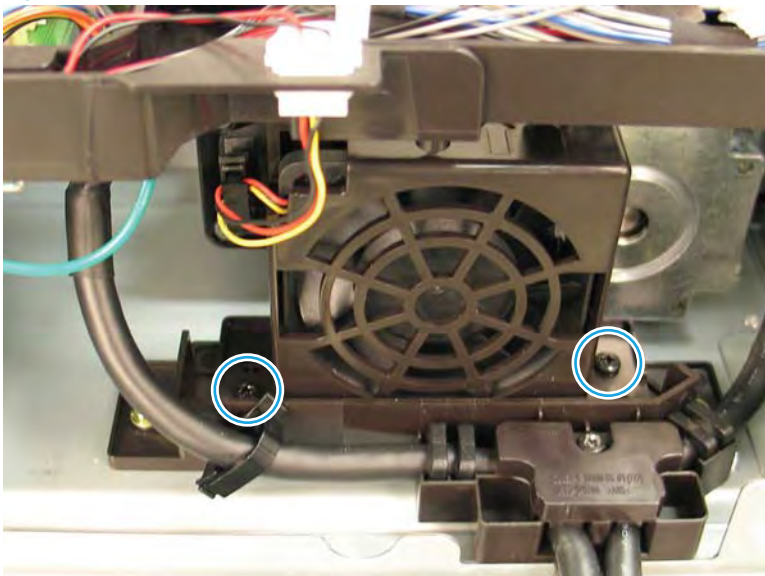


### Remove the exit motor

Follow these steps to remove the exit motor.

1. Remove two screws and one connector, and then remove the CIS fan.

Figure 2-467 Remove the main fan



2. Remove the spring (callout 1), disconnect one connector (callout 2), loosen three screws, and then remove the exit motor.

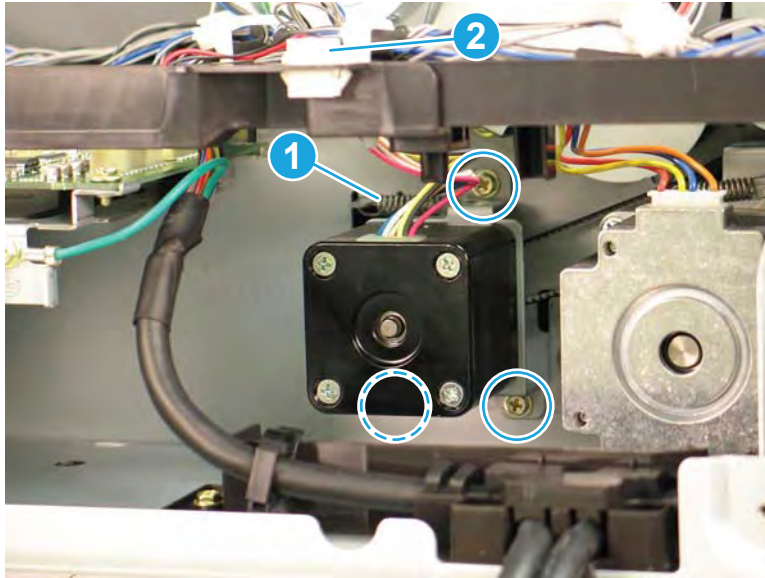


---

 **Reinstallation tip:**

- a. Reinstall the motor and lift the gear belt up to engage the motor pulley.
  - b. Install the tension spring.
  - c. Tighten the motor mount screws just enough so that the tension spring (not the motor mount screws) is providing the tension to the belt.
- 

**Figure 2-468** Remove the motor

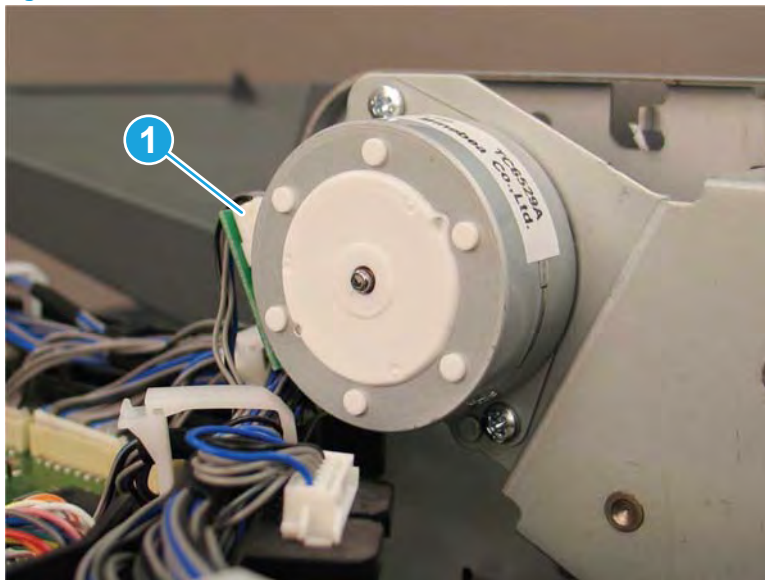


### Remove the feed motor

Follow these steps to remove the feed motor.

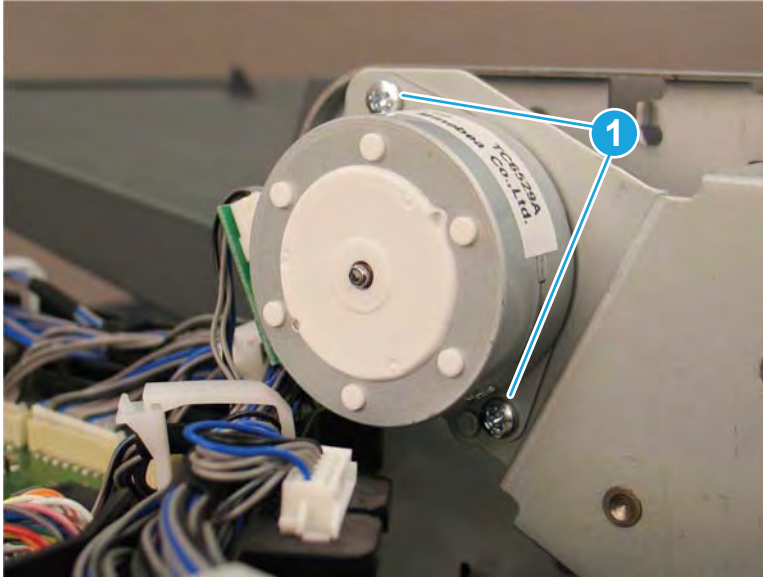
1. Disconnect one connector (callout 1).

**Figure 2-469** Disconnect one connector



2. Remove two screws, and then remove motor.

Figure 2-470 Remove the motor



## Remove the REGI motor

Follow these steps to remove the REGI motor.

1. Remove the rear cover.
2. Remove the Pre-REGI motor.
3. Disconnect one connector from the motor.

---

💡 **TIP:** Remove the connector harness from the cable retainer, and then disconnect the connector.

---

4. Remove one spring, loosen (do not remove) 3 screws, and then slide the motor off the screws to remove it.

---

💡 **Reinstallation tip:**

- a. Reinstall the motor and lift the gear belt up to engage the motor pulley.
  - b. Install the tension spring.
  - c. Tighten the motor mount screws just enough so that the tension spring (not the motor mount screws) is providing the tension to the belt.
- 

## Unpack the replacement assembly

Follow these steps to unpack the replacement assembly.

1. Dispose of the defective part.



---

 **NOTE:** HP recommends responsible disposal of the defective part.


<http://www8.hp.com/us/en/hp-information/environment/product-recycling.html>

---

2. Unpack the replacement part from the packaging.


 **CAUTION:**  Some parts are sensitive to electrostatic discharge (ESD). Always perform service work at an ESD-protected workstation or mat. If an ESD workstation or mat is not available, touch the sheet-metal chassis to provide a static ground before touching an ESD-sensitive assembly. Protect the ESD-sensitive assemblies by placing them in ESD pouches when they are out of the printer.

 **IMPORTANT:** Make sure that all of the shipping materials (for example shipping tape) are removed from the replacement part prior to installation.

 **NOTE:** If the replacement part is a roller or pad, avoid touching the spongy part of it. Skin oils on the roller or pad can cause paper pickup and/or print-quality problems. HP recommends using disposable gloves when handling rollers or pads or washing your hands before touching rollers or pads.

---

3. To install an assembly, reverse the removal steps.

 **NOTE:** When applicable, special installation instructions are provided for an assembly at the end of the removal procedure. Always completely read the removal instructions and follow all special installation instructions.

---

## Removal and replacement: Document feeder PCA fan (GX)


This document provides the procedures to remove the document feeder PCA fan assembly.

 [View a video of removing and replacing the fan \(E77820-E77830\).](#)

Mean time to repair: 15 minutes

Service level: Intermediate

---

 **IMPORTANT:** When applicable, special installation instructions are provided for an assembly at the end of the removal procedure. Always completely read the removal instructions and follow all special installation instructions.

---

### Before performing service

- Disconnect the power cable.

Use the table below to identify the correct part number for your printer. To order the part, go to [www.hp.com/buy/parts](http://www.hp.com/buy/parts)

**Table 2-96 Part information**

Part number	Part description
JC31-00146A	Document feeder PCA fan assembly

### Required tools

- #2 JIS screwdriver with a magnetic tip

### After performing service

#### Turn the printer power on

- Connect the power cable.
- Use the power switch to turn the power on.

### Post service test

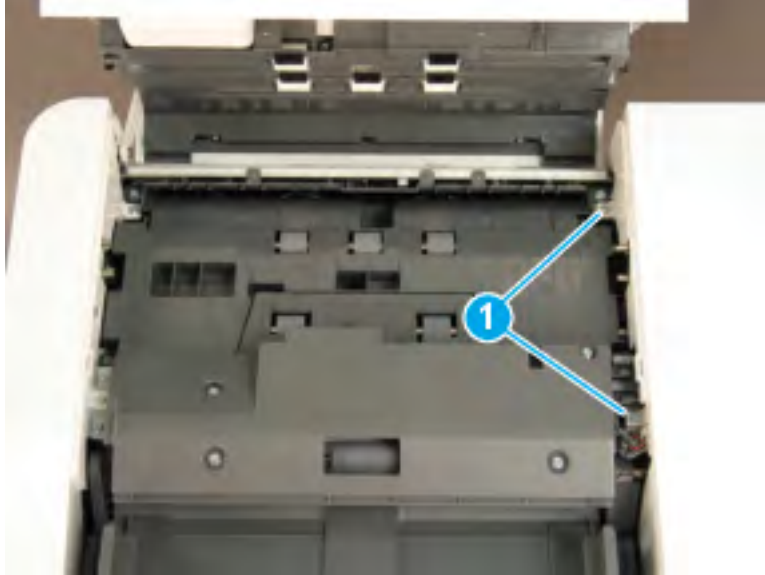
Copy, scan, or print a document. Verify the document copies, scans, or prints correctly.

### Remove the document feeder back cover

Follow these steps to remove the document feeder back cover.

1. Remove two screws from the top of document feeder back cover.

Figure 2-471 Remove the document feeder back cover top screws



2. Remove three screws from the bottom of the document feeder back cover, and then remove the document feeder back cover.

Figure 2-472 Remove the document feeder back cover bottom screws



## Remove the document feeder PCA fan

Follow these steps to remove the document feeder PCA fan.

- ▲ Disconnect one connector (callout 1) and then release two tabs (callout 2) to remove the fan.


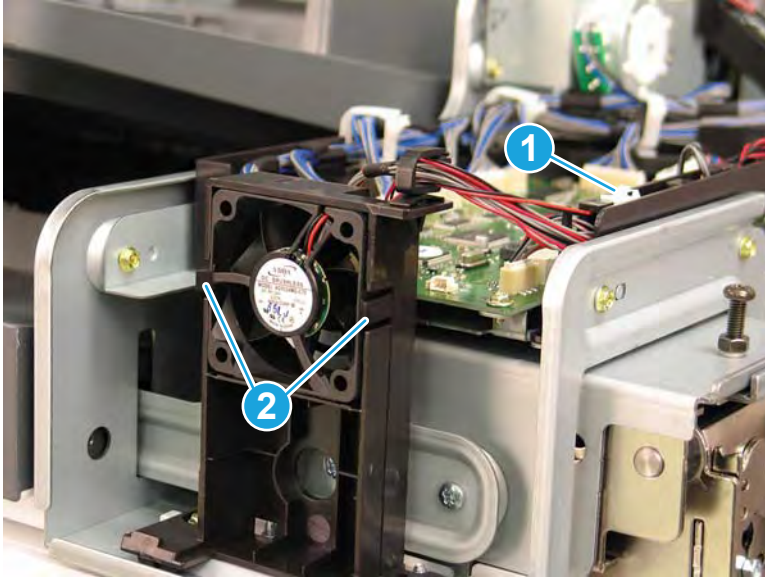
 **Reinstallation tip:** Install the fan with the correct orientation when reinstalling.

Figure 2-473 Remove the document feeder PCA fan connector



## Unpack the replacement assembly



Follow these steps to unpack the replacement assembly.

1. Dispose of the defective part.


 **NOTE:** HP recommends responsible disposal of the defective part.

<http://www8.hp.com/us/en/hp-information/environment/product-recycling.html>


2. Unpack the replacement part from the packaging.

 **CAUTION:**  Some parts are sensitive to electrostatic discharge (ESD). Always perform service work at an ESD-protected workstation or mat. If an ESD workstation or mat is not available, touch the sheet-metal chassis to provide a static ground before touching an ESD-sensitive assembly. Protect the ESD-sensitive assemblies by placing them in ESD pouches when they are out of the printer.

 **IMPORTANT:** Make sure that all of the shipping materials (for example shipping tape) are removed from the replacement part prior to installation.

 **NOTE:** If the replacement part is a roller or pad, avoid touching the spongy part of it. Skin oils on the roller or pad can cause paper pickup and/or print-quality problems. HP recommends using disposable gloves when handling rollers or pads or washing your hands before touching rollers or pads.

3. To install an assembly, reverse the removal steps.

 **NOTE:** When applicable, special installation instructions are provided for an assembly at the end of the removal procedure. Always completely read the removal instructions and follow all special installation instructions.


## Removal and replacement: Document feeder contact image sensor (CIS) fan (GX)

This document provides the procedures to remove the CIS fan assembly.

 [View a video of removing and replacing the fan \(E77820-E77830\).](#)

Mean time to repair: 20 minutes

Service level: Intermediate

 **IMPORTANT:** When applicable, special installation instructions are provided for an assembly at the end of the removal procedure. Always completely read the removal instructions and follow all special installation instructions.

### Before performing service

- Disconnect the power cable.

Use the table below to identify the correct part number for your printer. To order the part, go to [www.hp.com/buy/parts](http://www.hp.com/buy/parts)

**Table 2-97 Part information**

Part number	Part description
JC31-00168A	CIS fan

### Required tools

- #2 JIS screwdriver with a magnetic tip

### After performing service

#### Turn the printer power on

- Connect the power cable.
- Use the power switch to turn the power on.

### Post service test

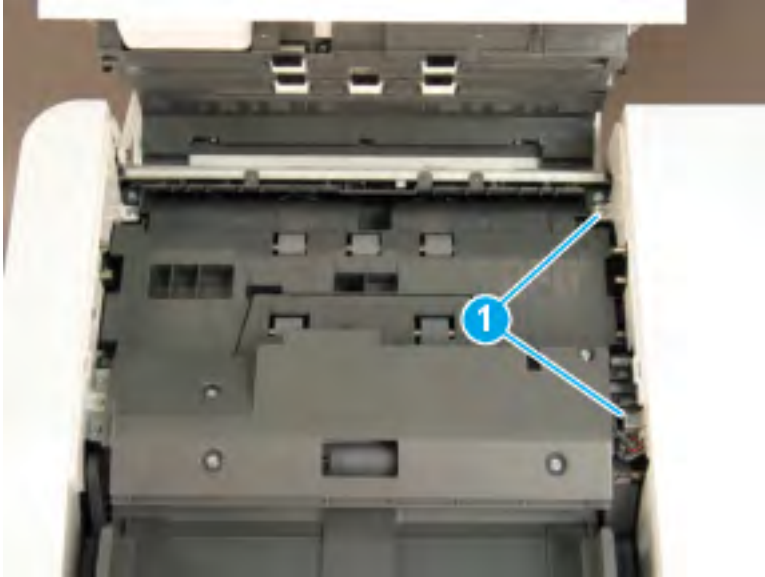
Copy, scan, or print a document. Verify the document copies, scans, or prints correctly.

### Remove the document feeder back cover

Follow these steps to remove the document feeder back cover.

1. Remove two screws from the top of document feeder back cover.

Figure 2-474 Remove the document feeder back cover top screws



2. Remove three screws from the bottom of the document feeder back cover, and then remove the document feeder back cover.

Figure 2-475 Remove the document feeder back cover bottom screws



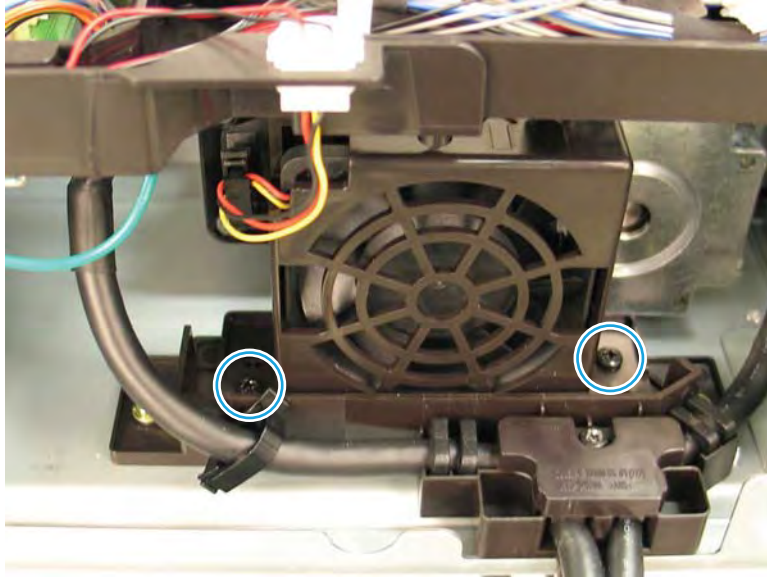
### Remove the document feeder CIS fan

Follow these steps to remove the document feeder CIS fan.

- ▲ Remove one connector, and then remove two mounting screws to remove the fan.



Figure 2-476 Remove the document feeder CIS fan



## Unpack the replacement assembly



Follow these steps to unpack the replacement assembly.


1. Dispose of the defective part.


 **NOTE:** HP recommends responsible disposal of the defective part.

<http://www8.hp.com/us/en/hp-information/environment/product-recycling.html>


2. Unpack the replacement part from the packaging.

 **CAUTION:**  Some parts are sensitive to electrostatic discharge (ESD). Always perform service work at an ESD-protected workstation or mat. If an ESD workstation or mat is not available, touch the sheet-metal chassis to provide a static ground before touching an ESD-sensitive assembly. Protect the ESD-sensitive assemblies by placing them in ESD pouches when they are out of the printer.

 **IMPORTANT:** Make sure that all of the shipping materials (for example shipping tape) are removed from the replacement part prior to installation.

 **NOTE:** If the replacement part is a roller or pad, avoid touching the spongy part of it. Skin oils on the roller or pad can cause paper pickup and/or print-quality problems. HP recommends using disposable gloves when handling rollers or pads or washing your hands before touching rollers or pads.

3. To install an assembly, reverse the removal steps.

 **NOTE:** When applicable, special installation instructions are provided for an assembly at the end of the removal procedure. Always completely read the removal instructions and follow all special installation instructions.

## Removal and replacement: Flow ADF ultrasonic sensor with PCA (GX)


This document provides the procedures to remove the ultrasonic sensor with PCA assembly.

 [View a video of removing and replacing the sensor \(E72520-E72530\).](#)

E77820-E77830:

Mean time to repair: 15 minutes

Service level: Intermediate

 **IMPORTANT:** When applicable, special installation instructions are provided for an assembly at the end of the removal procedure. Always completely read the removal instructions and follow all special installation instructions.

### Before performing service

- Disconnect the power cable.

Use the table below to identify the correct part number for your printer. To order the part, go to [www.hp.com/buy/parts](http://www.hp.com/buy/parts)

Table 2-98 Part information

Part number	Part description
JC92-02965A	PCA- ADF HIC (GX only)
JC92-02967A	PCA- ADF Receiver (GX only)
JC92-02966A	PCA- ADF Transmitter (GX only)

### Required tools

- #2 JIS screwdriver with a magnetic tip

### After performing service

#### Turn the printer power on

- Connect the power cable.
- Use the power switch to turn the power on.

### Post service test

Copy, scan, or print a document. Verify the document copies, scans, or prints correctly.

### Remove the document feeder (ADF) front cover

Follow these steps to remove the document feeder (ADF) front cover.

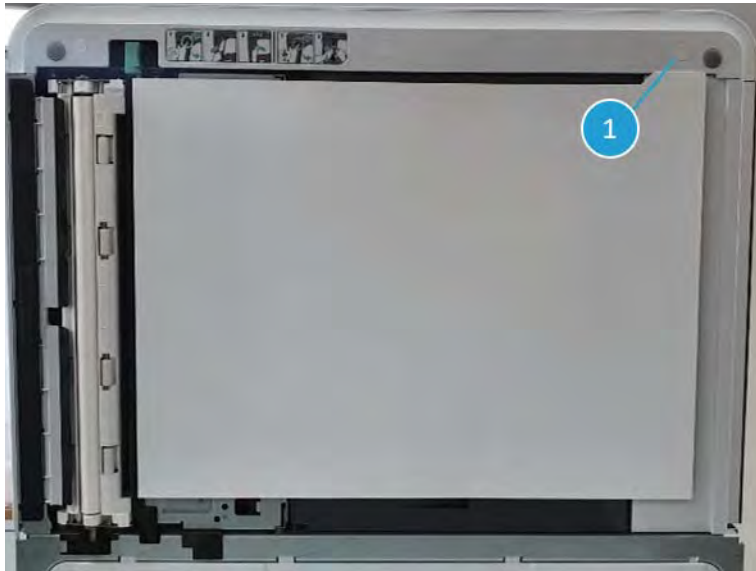
1. Remove two screws from the top of document feeder front cover.

Figure 2-477 Remove the document feeder front cover top screws



2. Open the document feeder. Detach a sticker and then remove a screw (Callout 1) from the bottom of the document feeder front cover.

Figure 2-478 Open the document feeder



3. Remove the document feeder front cover.

**Figure 2-479** Remove the document feeder front cover

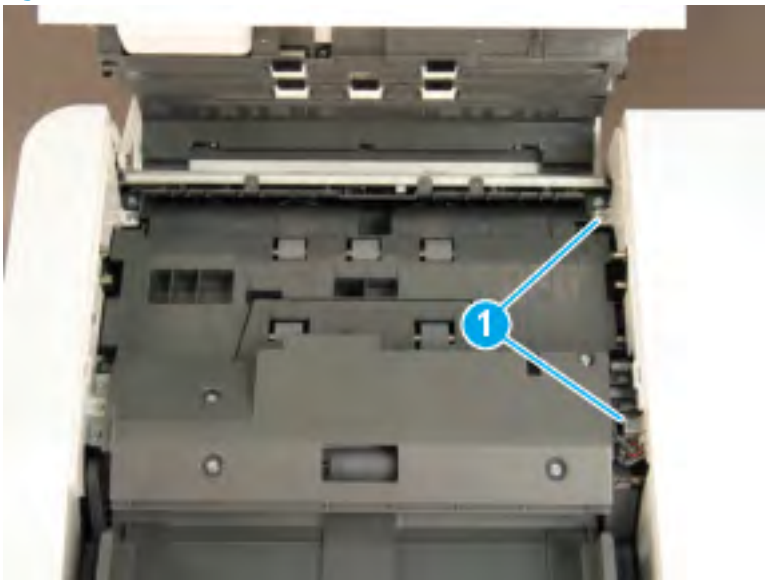


### Remove the document feeder back cover

Follow these steps to remove the document feeder back cover.

1. Remove two screws from the top of document feeder back cover.

**Figure 2-480** Remove the document feeder back cover top screws



2. Remove three screws from the bottom of the document feeder back cover, and then remove the document feeder back cover.

**Figure 2-481** Remove the document feeder back cover bottom screws

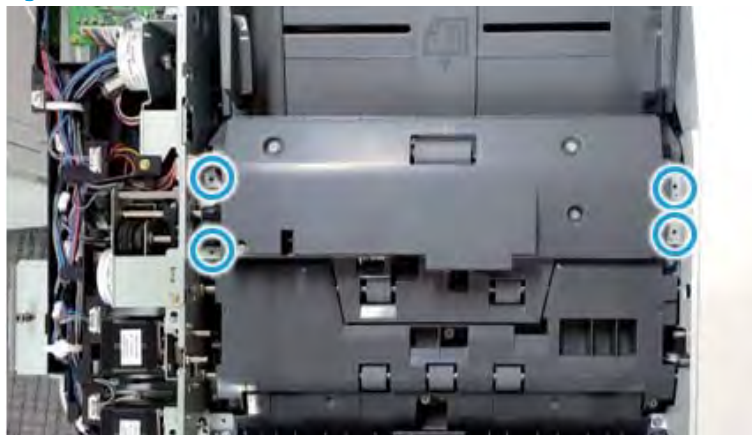


### Remove the document feeder pickup and feed assembly

Follow these steps to remove the document feeder pickup and feed assembly.

1. Remove 4 screws.

**Figure 2-482** Remove 4 screws.



2. Remove 2 cables (callout 1) then remove the document feeder pickup roller assembly

Figure 2-483 Remove the pickup roller assembly



 **TIP:** Re-assembly

- Make sure shape of both the holes on the assembly and the shafts at the frame.

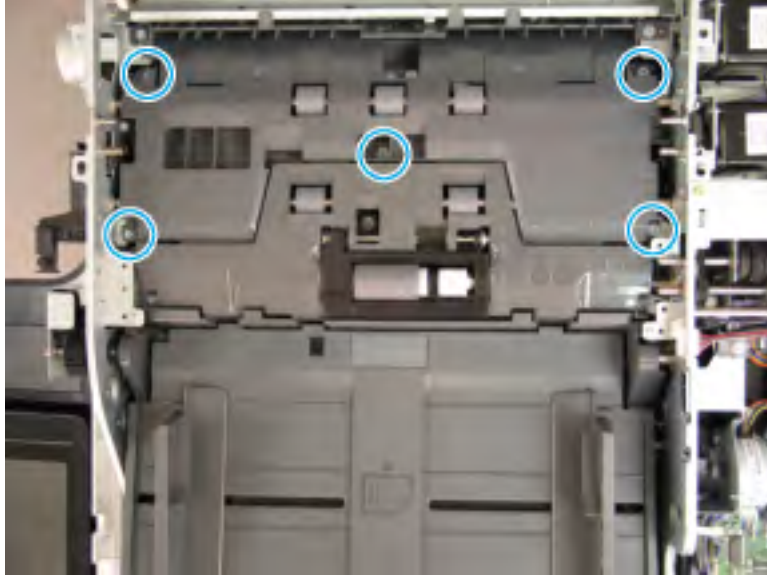


## Remove the document feeder paper path cover

Follow these steps to remove the document feeder paper path cover.

- ▲ Remove five screws, and then remove the paper path cover.

Figure 2-484 Remove the document feeder paper path cover

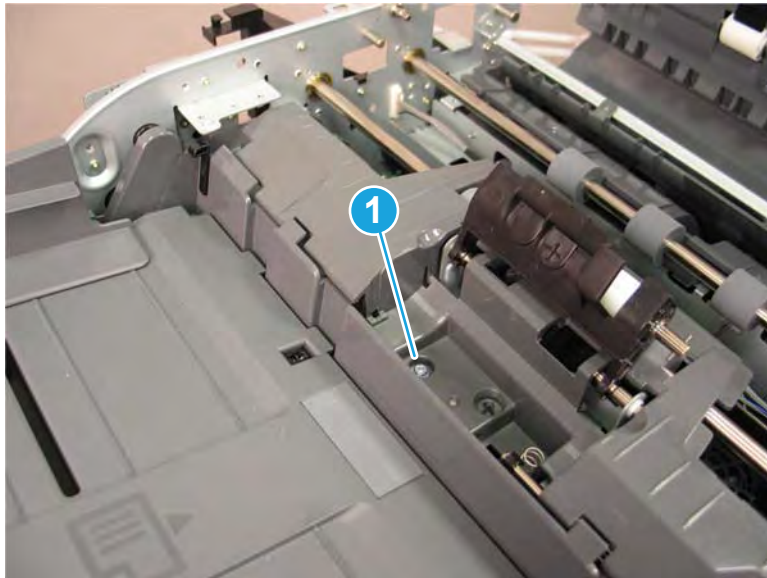


### Remove the ultrasonic sensor with PCA

Follow these steps to remove the ultrasonic sensor with PCA.

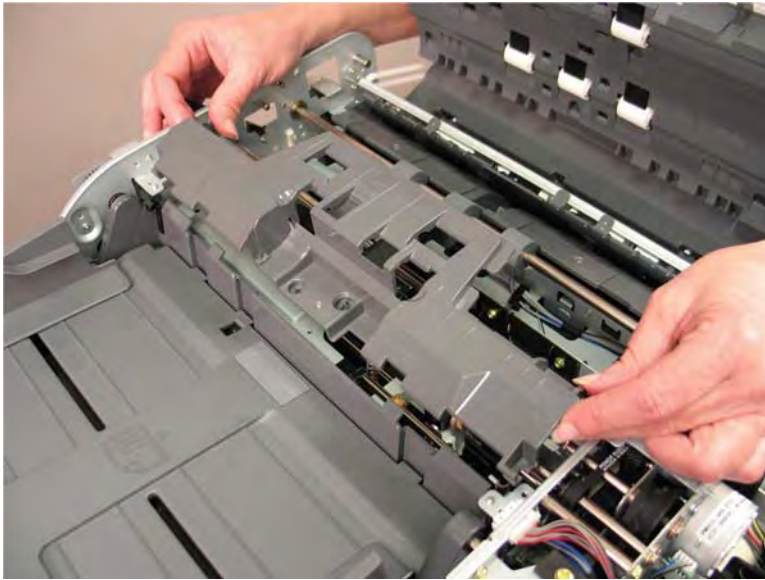
1. Remove the separation roller, and then remove one screw (callout 1).

Figure 2-485 Remove one screw



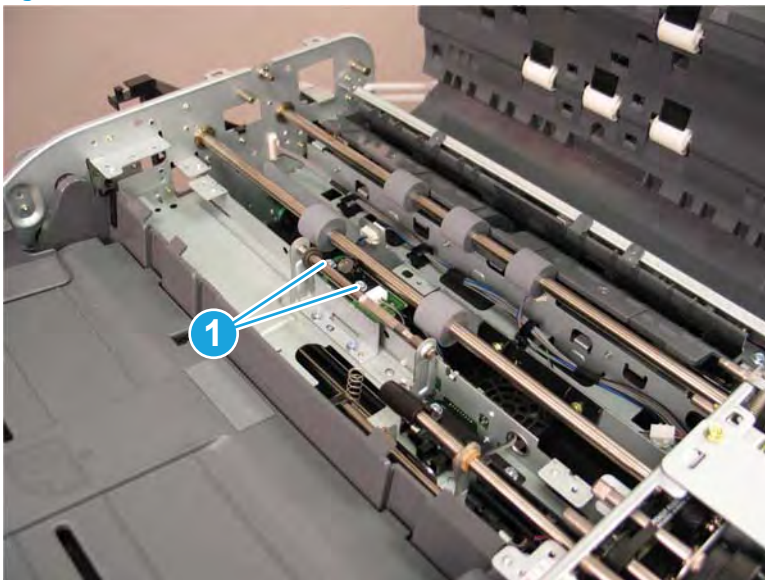
2. Remove the pick/feed cover.

Figure 2-486 Remove the pick/feed cover



3. Remove two screws (callout 1), and then remove the ultrasonic sensor.

Figure 2-487 Remove the ultrasonic sensor



### Unpack the replacement assembly

Follow these steps to unpack the replacement assembly.

1. Dispose of the defective part.





---


 **NOTE:** HP recommends responsible disposal of the defective part.


<http://www8.hp.com/us/en/hp-information/environment/product-recycling.html>

---

2. Unpack the replacement part from the packaging.


 **CAUTION:**  Some parts are sensitive to electrostatic discharge (ESD). Always perform service work at an ESD-protected workstation or mat. If an ESD workstation or mat is not available, touch the sheet-metal chassis to provide a static ground before touching an ESD-sensitive assembly. Protect the ESD-sensitive assemblies by placing them in ESD pouches when they are out of the printer.

 **IMPORTANT:** Make sure that all of the shipping materials (for example shipping tape) are removed from the replacement part prior to installation.

 **NOTE:** If the replacement part is a roller or pad, avoid touching the spongy part of it. Skin oils on the roller or pad can cause paper pickup and/or print-quality problems. HP recommends using disposable gloves when handling rollers or pads or washing your hands before touching rollers or pads.

---

3. To install an assembly, reverse the removal steps.

 **NOTE:** When applicable, special installation instructions are provided for an assembly at the end of the removal procedure. Always completely read the removal instructions and follow all special installation instructions.

---

## Removal and replacement: PCA-ADF HIC (GX)


This document provides the procedures to remove the document feeder PCA.

 [View a video fo removing and replacing the PCA \(E72520-E72530\).](#)

 [View a video fo removing and replacing the PCA \(E77820-E77830\).](#)

Mean time to repair: 15 minutes

Service level: Intermediate

 **IMPORTANT:** When applicable, special installation instructions are provided for an assembly at the end of the removal procedure. Always completely read the removal instructions and follow all special installation instructions.

### Before performing service

- Disconnect the power cable.

Use the table below to identify the correct part number for your printer. To order the part, go to [www.hp.com/buy/parts](http://www.hp.com/buy/parts)

**Table 2-99** Part information

Part number	Part description
JC92-02962A	Document feeder PCA assembly

### Required tools

- #2 JIS screwdriver with a magnetic tip

### After performing service

#### Turn the printer power on

- Connect the power cable.
- Use the power switch to turn the power on.

### Post service test

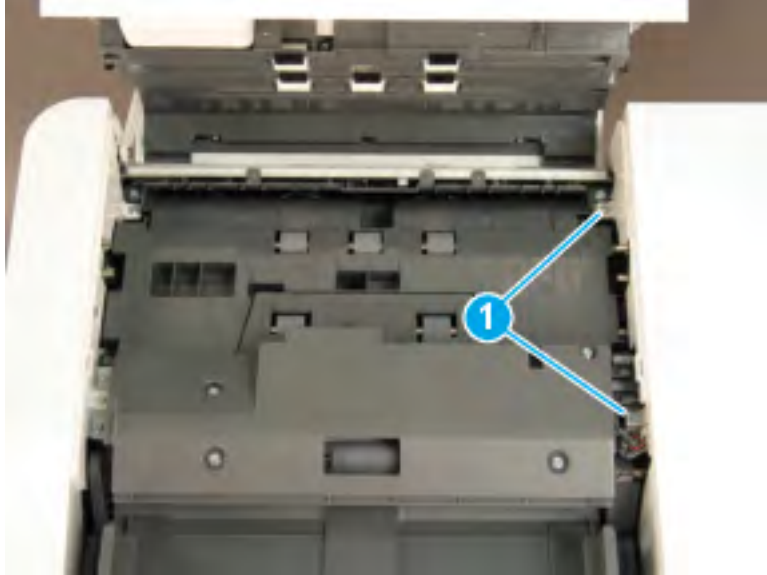
Copy, scan, or print a document. Verify the document copies, scans, or prints correctly.

### Remove the document feeder back cover

Follow these steps to remove the document feeder back cover.

1. Remove two screws from the top of document feeder back cover.

Figure 2-488 Remove the document feeder back cover top screws



2. Remove three screws from the bottom of the document feeder back cover, and then remove the document feeder back cover.

Figure 2-489 Remove the document feeder back cover bottom screws



### Remove the document feeder PCA

Follow these steps to remove the document feeder PCA.

1. Disconnect six connectors and the ground wire from PCA, and then remove four screws.

Figure 2-490 Document feeder PCA



2. Remove the document feeder PCA.

## Unpack the replacement assembly

Follow these steps to unpack the replacement assembly.

1. Dispose of the defective part.

---



 **NOTE:** HP recommends responsible disposal of the defective part.

<http://www8.hp.com/us/en/hp-information/environment/product-recycling.html>


---

2. Unpack the replacement part from the packaging.

---

 **CAUTION:**  Some parts are sensitive to electrostatic discharge (ESD). Always perform service work at an ESD-protected workstation or mat. If an ESD workstation or mat is not available, touch the sheet-metal chassis to provide a static ground before touching an ESD-sensitive assembly. Protect the ESD-sensitive assemblies by placing them in ESD pouches when they are out of the printer.


 **IMPORTANT:** Make sure that all of the shipping materials (for example shipping tape) are removed from the replacement part prior to installation.

 **NOTE:** If the replacement part is a roller or pad, avoid touching the spongy part of it. Skin oils on the roller or pad can cause paper pickup and/or print-quality problems. HP recommends using disposable gloves when handling rollers or pads or washing your hands before touching rollers or pads.

---

3. To install an assembly, reverse the removal steps.

---

 **NOTE:** When applicable, special installation instructions are provided for an assembly at the end of the removal procedure. Always completely read the removal instructions and follow all special installation instructions.

---

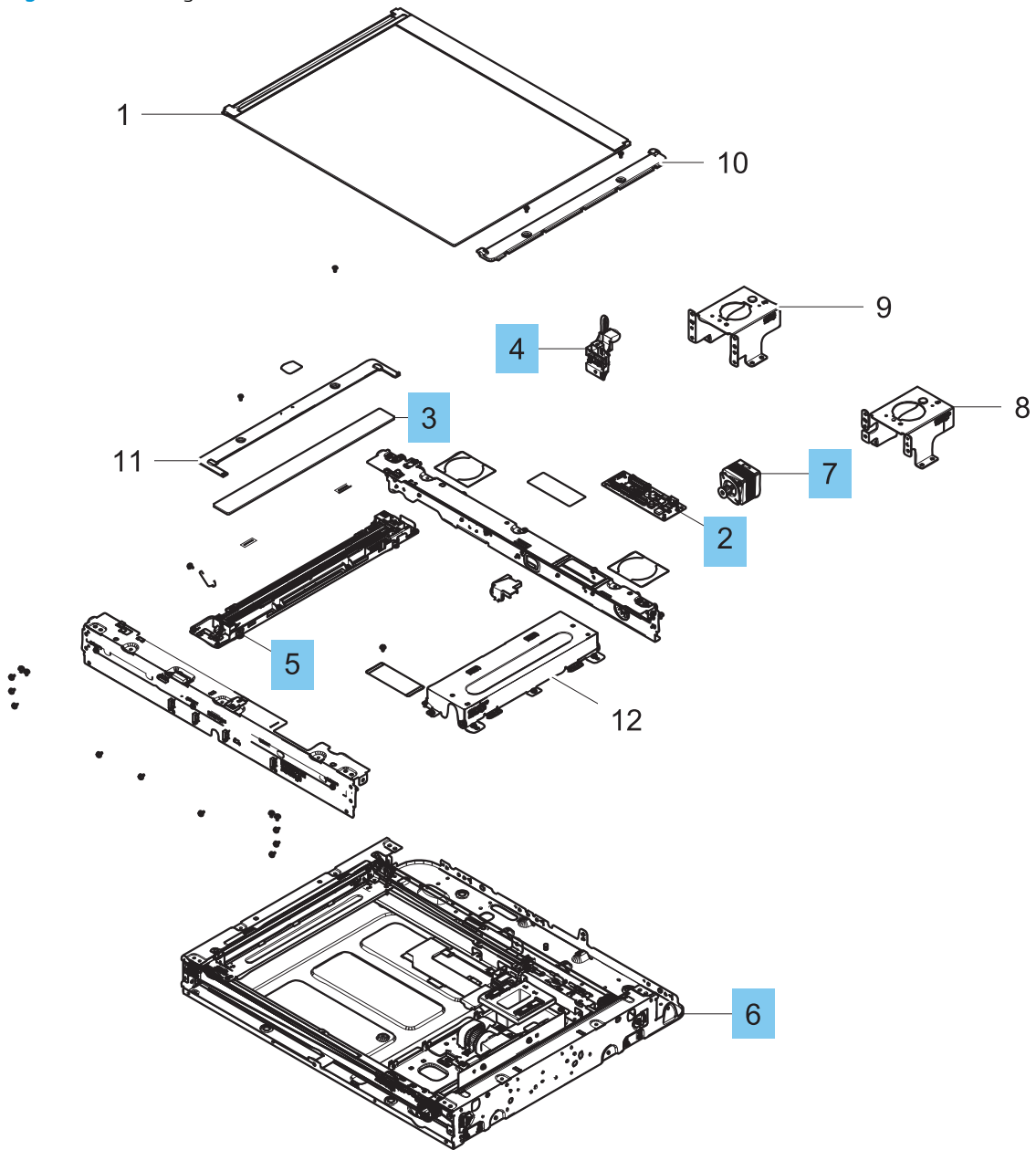
## Image scanner

View the image scanner exploded view, parts list, and repair procedures.

## Image scanner

Parts diagram and parts list for the image scanner.

Figure 2-491 Image scanner



**Table 2-100 Image scanner**

Ref				
No	Part number	Description	Qty	Repair procedure
2	JC92-02781A	PCA - Scan Joint	1	Not applicable
3	JC01-00101A	SSA Tempered Glass	1	Not applicable
4	JC97-04516A	Image scanner open sensor	1	Not applicable
5	JC97-04521A	Scanner - FR Lamp	1	Not applicable
6	JC97-04515A	Image scanner, lower	1	Not applicable
7	JC31-00158A	Step motor, ip	1	Not applicable

## Image scanner assembly

View the image scanner assembly exploded view, parts list, and repair procedures.

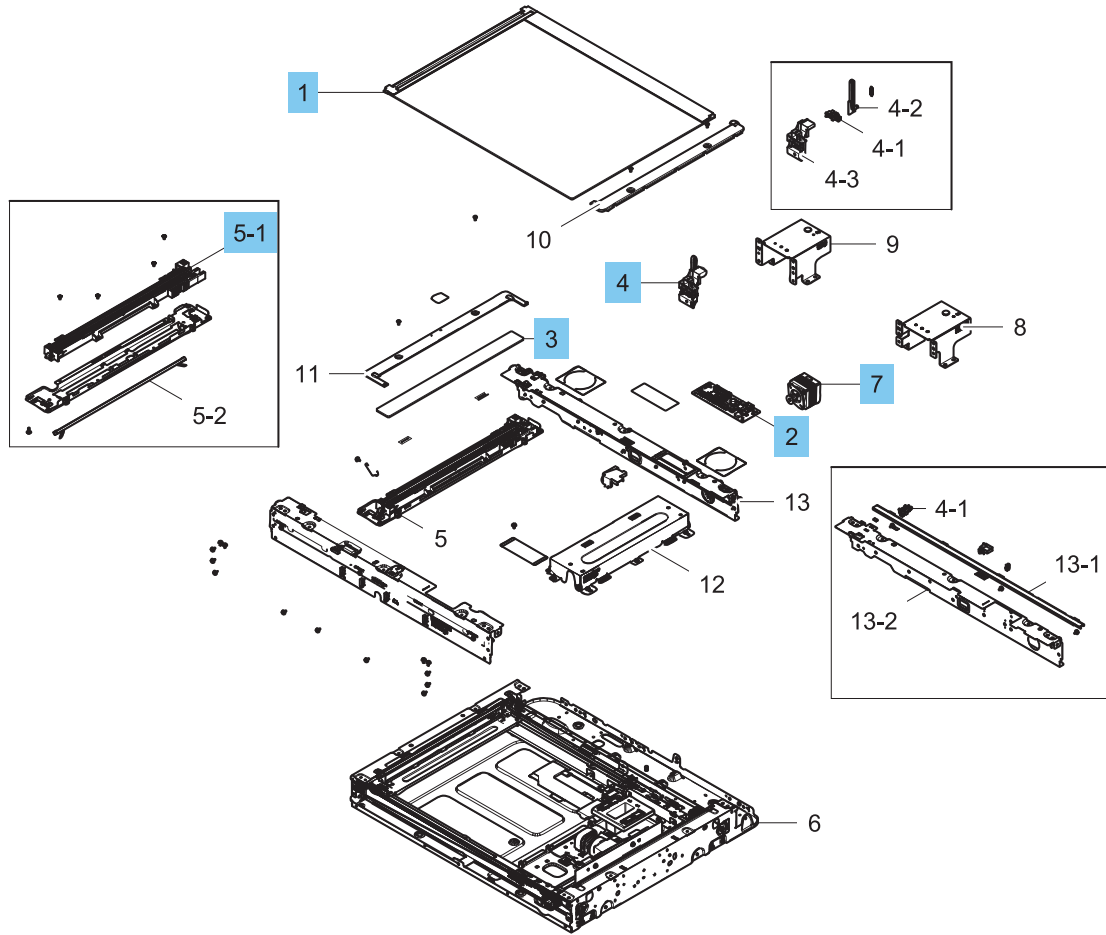




# Image scanner assembly

Parts diagram and parts list for the image scanner assembly.

Figure 2-492 Image scanner assembly




**Table 2-101 Image scanner assembly**

Ref				
No	Part number	Description	Qty	Repair procedure
1	JC97-04522B	Image scanner scan glass	1	<a href="#">Removal and replacement: Scan glass on page 622</a>
2	JC92-02781A	PCA scanner	1	Not applicable
3	JC01-00101A	Tempered scan glass	1	Not applicable
4	JC97-04516A	Scanner assembly-DDC and lens	2	Not applicable
5-1	JC97-04521A	Image scanner lamp	1	<a href="#">HP LaserJet Managed MFP E72525-E72535, E77822-E77830 - Removal and replacement: Scanner LED lamp module on page 625</a>
7	JC31-00158A	Step motor, ip	1	Not applicable

## Removal and replacement: Scan glass

Learn how to remove and replace the scanner glass.

 **IMPORTANT:** When applicable, special installation instructions are provided for an assembly at the end of the removal procedure. Always completely read the removal instructions and follow all special installation instructions.


Mean time to repair:

Service level:

### Before performing service

#### Turn the printer power off

- Press the power button on the front of the printer, and then turn off the power switch next to the power cable.
- A shutting-down message appears on the control-panel display.

 **WARNING!** To avoid damage to the printer, turn the power off and wait until the printer shuts down before removing the power cable.

- Disconnect the printer power cable after the printer has completely shut down (the control-panel display is blank).

Use the table below to identify the correct part number for your printer. To order the part, go to [www.hp.com/buy/parts](http://www.hp.com/buy/parts).

Table 2-102 Part information

Part number	Part description
JC97-04522B	Scanner glass

### Required tools

- #2 JIS screwdriver with a magnetic tip

### After performing service

#### Turn the printer power on

- Connect the printer power cable.
- Turn on the power switch next to the power cable, and then press the power button on the front of the printer.
- Verify that the service performed was successful.
- Verify that the most recent firmware is installed on the printer.
- Verify that all parts are correctly reinstalled and are properly working.

## Post service test

Print any pages necessary to verify that the repair resolved the issue and did not create any new issues.

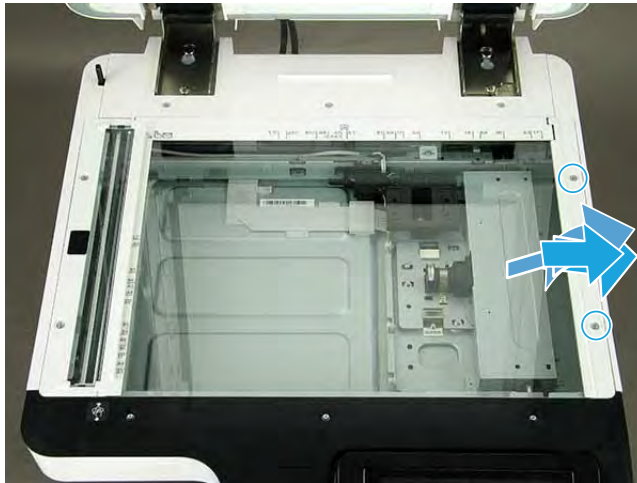
## Remove the scanner glass

Follow these steps to remove the scanner glass.

**CAUTION:** Make sure not to be contaminated in scanner while scanner glass is removed.

Open the document-feeder cover, remove two screws, and then slide the scanner glass to the right to remove it.

**Figure 2-493** Remove scanner glass



## Unpack the replacement assembly


Follow these steps to unpack the replacement assembly.

1. Dispose of the defective part.

**NOTE:** HP recommends responsible disposal of the defective part.

<http://www8.hp.com/us/en/hp-information/environment/product-recycling.html>

2. Unpack the replacement part from the packaging.


**CAUTION:**  Some parts are sensitive to electrostatic discharge (ESD). Always perform service work at an ESD-protected workstation or mat. If an ESD workstation or mat is not available, touch the sheet-metal chassis to provide a static ground before touching an ESD-sensitive assembly. Protect the ESD-sensitive assemblies by placing them in ESD pouches when they are out of the printer.

**IMPORTANT:** Make sure that all of the shipping materials (for example shipping tape) are removed from the replacement part prior to installation.

**NOTE:** If the replacement part is a roller or pad, avoid touching the spongy part of it. Skin oils on the roller or pad can cause paper pickup and/or print-quality problems. HP recommends using disposable gloves when handling rollers or pads or washing your hands before touching rollers or pads.

3. To install an assembly, reverse the removal steps.

---


 **NOTE:** When applicable, special installation instructions are provided for an assembly at the end of the removal procedure. Always completely read the removal instructions and follow all special installation instructions.

---


# HP LaserJet Managed MFP E72525-E72535, E77822-E77830 - Removal and replacement: Scanner LED lamp module

This document provides the procedures to remove the LED lamp module assembly.

E72520-E72530:

 [https://players.brightcove.net/1160438706001/SyKVJeRXx\\_default/index.html?videoId=ref:REFIDPH0000000357](https://players.brightcove.net/1160438706001/SyKVJeRXx_default/index.html?videoId=ref:REFIDPH0000000357)


E77820-E77830:

 [https://players.brightcove.net/1160438706001/SyKVJeRXx\\_default/index.html?videoId=ref:REFIDPH0000000283](https://players.brightcove.net/1160438706001/SyKVJeRXx_default/index.html?videoId=ref:REFIDPH0000000283)

Mean time to repair: 45 minutes

Service level: Advanced

---

 **IMPORTANT:** When applicable, special installation instructions are provided for an assembly at the end of the removal procedure. Always completely read the removal instructions and follow all special installation instructions.

---

## Before performing service

- Disconnect the power cable.

Use the table below to identify the correct part number for your printer. To order the part, go to [www.hp.com/buy/parts](http://www.hp.com/buy/parts)

**Table 2-103** Part information

LED lamp module assembly part number	
JC97-04521A	LED lamp module assembly

## Required tools

- #2 JIS screwdriver with a magnetic tip

## After performing service

### Turn the printer power on

- Connect the power cable.
- Use the power switch to turn the power on.

## Post service test

Copy, scan, or print a document. Verify the document copies, scans, or prints correctly.

## Remove the scanner glass

Follow these steps to remove the scanner glass.

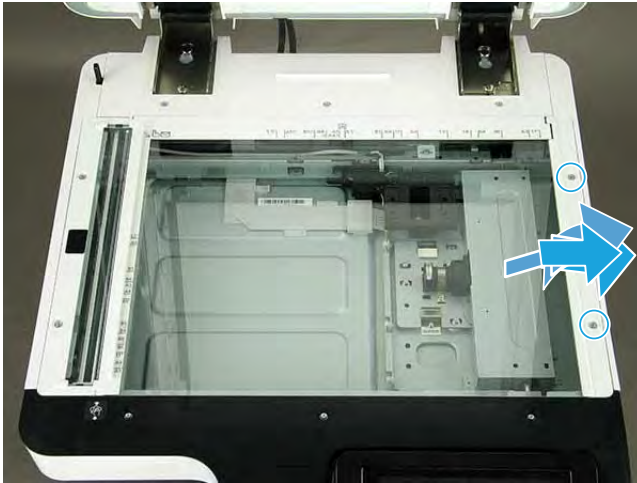
---

**CAUTION:** Make sure not to be contaminated in scanner while scanner glass is removed.

---

Open the document-feeder cover, remove two screws, and then slide the scanner glass to the right to remove it.

**Figure 2-494** Remove scanner glass



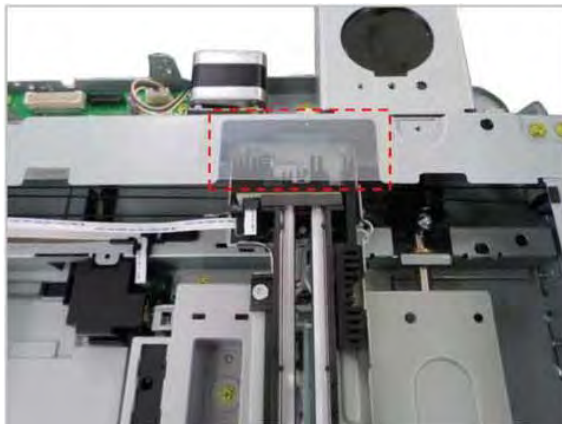
## Remove the LED lamp module

Follow these steps to remove the LED lamp module.

- CAUTION:** Make sure not to be contaminated in scanner while scanner glass is removed. then remove the LED lamp module.
- 

Remove the transparent tape.

**Figure 2-495** Remove transparent tape





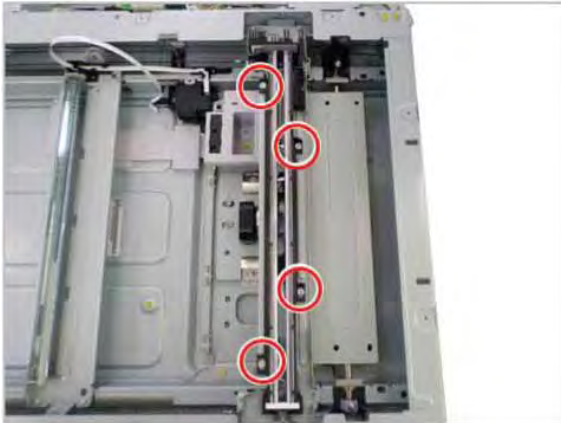
2. Disconnect the flat cable.

Figure 2-496 Disconnect cable



3. Remove four screws. Remove the LED lamp module.

Figure 2-497 Remove screws and release LED lamp module



## Unpack the replacement assembly

Follow these steps to unpack the replacement assembly.

1. Dispose of the defective part.

---

 **NOTE:** HP recommends responsible disposal of the defective part.

<http://www8.hp.com/us/en/hp-information/environment/product-recycling.html>

---

2. Unpack the replacement part from the packaging.


 **CAUTION:**  Some parts are sensitive to electrostatic discharge (ESD). Always perform service work at an ESD-protected workstation or mat. If an ESD workstation or mat is not available, touch the sheet-metal chassis to provide a static ground before touching an ESD-sensitive assembly. Protect the ESD-sensitive assemblies by placing them in ESD pouches when they are out of the printer.

 **IMPORTANT:** Make sure that all of the shipping materials (for example shipping tape) are removed from the replacement part prior to installation.

 **NOTE:** If the replacement part is a roller or pad, avoid touching the spongy part of it. Skin oils on the roller or pad can cause paper pickup and/or print-quality problems. HP recommends using disposable gloves when handling rollers or pads or washing your hands before touching rollers or pads.

---

3. To install an assembly, reverse the removal steps.

 **NOTE:** When applicable, special installation instructions are provided for an assembly at the end of the removal procedure. Always completely read the removal instructions and follow all special installation instructions.

---

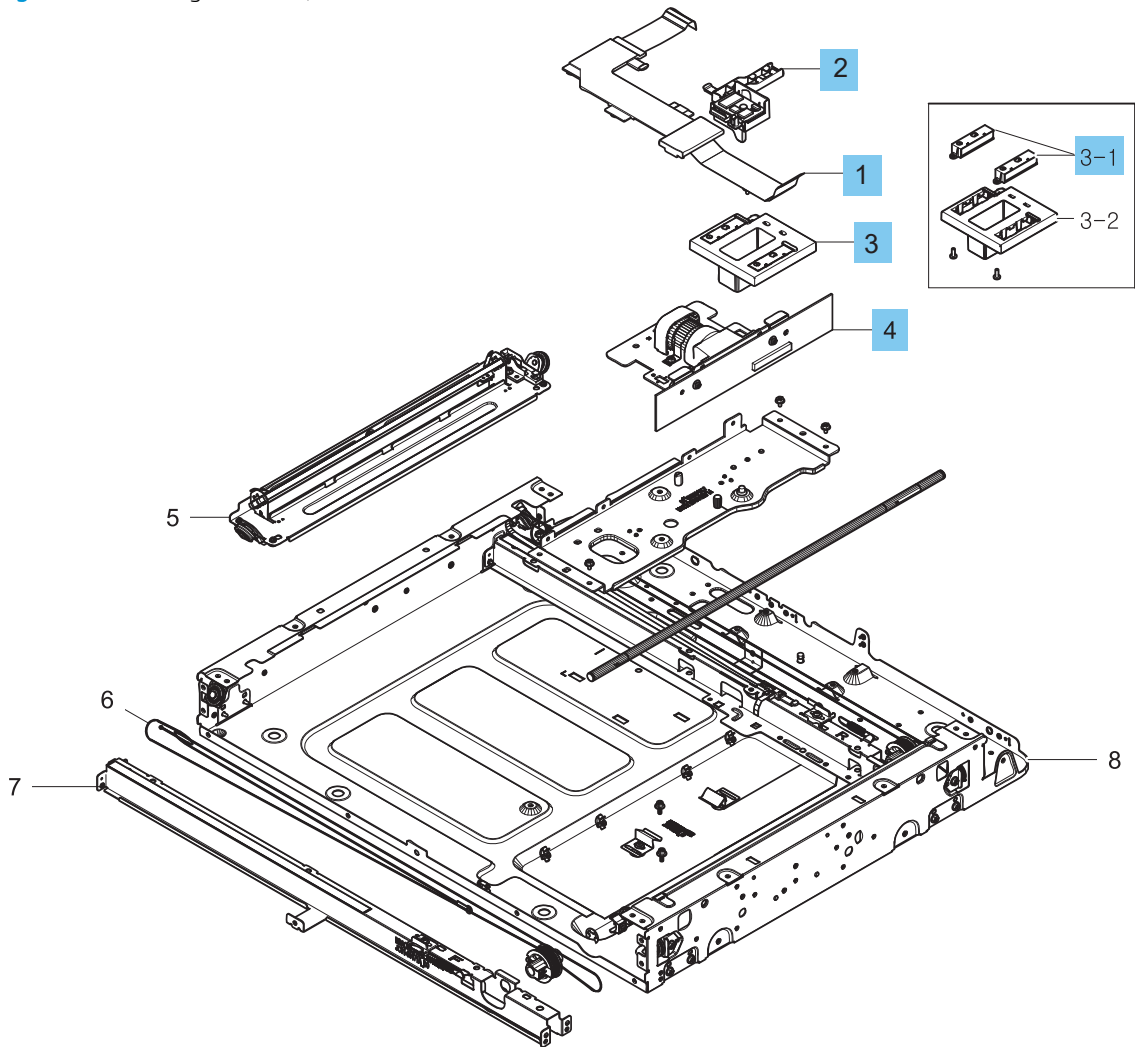
## Image scanner, lower (LX)

View the image scanner, lower (LX) exploded view, parts list, and repair procedures.

## Image scanner, lower (LX)

Parts diagram and parts list for the lower image scanner.

Figure 2-498 Image scanner, lower (LX)




**Table 2-104 Image scanner, lower (LX)**

Ref				
No	Part number	Description	Qty	Repair procedure
1	JC97-04509A	Image scanner, ffc ccd	1	Not applicable
2	JC97-04512A	Image scanner guide harness	1	Not applicable
3	JC97-04507A	Image scanner, APS	1	<a href="#">Removal and replacement: Scanner APS sensor on page 636</a>
3-1	604-001453	Photo interrupter	2	Not applicable
4	JC97-04523B	Image scanner lens	1	<a href="#">Removal and replacement: Scanner assembly – CCD and lens on page 632</a>

## Removal and replacement: Scanner assembly – CCD and lens

Learn how to remove and replace the scanner CDD and lens.

 [View a video of how to remove and replace the scanner CDD and lens \(E72525-72535\).](#)

 **IMPORTANT:** When applicable, special installation instructions are provided for an assembly at the end of the removal procedure. Always completely read the removal instructions and follow all special installation instructions.


Mean time to repair:

Service level:

### Before performing service

#### Turn the printer power off

- Press the power button on the front of the printer, and then turn off the power switch next to the power cable.
- A shutting-down message appears on the control-panel display.

 **WARNING!** To avoid damage to the printer, turn the power off and wait until the printer shuts down before removing the power cable.

- Disconnect the printer power cable after the printer has completely shut down (the control-panel display is blank).

Use the table below to identify the correct part number for your printer. To order the part, go to [www.hp.com/buy/parts](http://www.hp.com/buy/parts).

Table 2-105 Part information

Part number	Part description
JC97-04523B	Scanner assembly -CDD and lens

### Required tools

- #2 JIS screwdriver with a magnetic tip

### After performing service

#### Turn the printer power on

- Connect the printer power cable.
- Turn on the power switch next to the power cable, and then press the power button on the front of the printer.
- Verify that the service performed was successful.
- Verify that the most recent firmware is installed on the printer.
- Verify that all parts are correctly reinstalled and are properly working.

## Post service test

Print any pages necessary to verify that the repair resolved the issue and did not create any new issues.

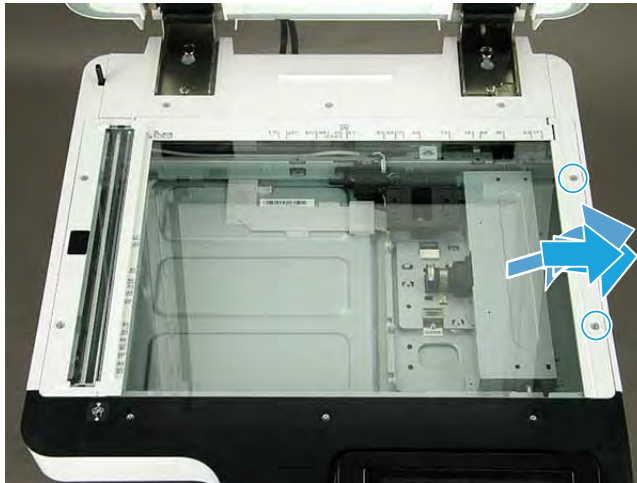
## Remove the scanner glass

Follow these steps to remove the scanner glass.

**CAUTION:** Make sure not to be contaminated in scanner while scanner glass is removed.

Open the document-feeder cover, remove two screws, and then slide the scanner glass to the right to remove it.

Figure 2-499 Remove scanner glass

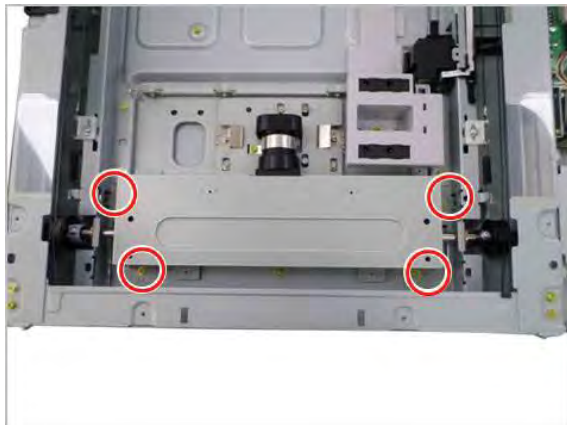


## Remove the scanner assembly CDD and lens

Follow these steps to remove the scanner assembly CDD and lens.

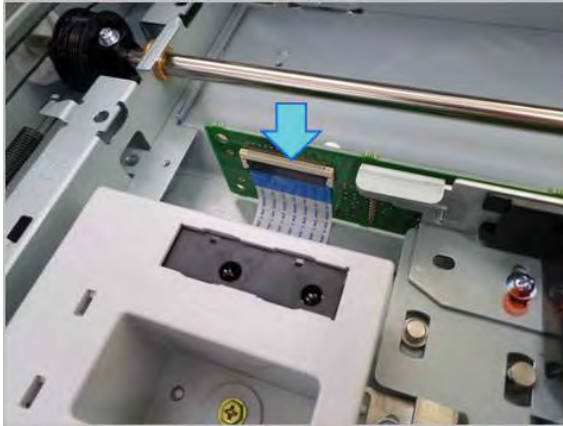
1. Remove four screws, and then release the imaging unit cover.

Figure 2-500 Remove screws and release imaging unit cover



2. Disconnect the flat cable.

Figure 2-501 Disconnect flat cable



3. Remove two screws and release the scanner assembly CDD and lens.

**⚠ CAUTION:** Do not remove or adjust the other two screws shown as they require factory setting only.

Figure 2-502 Remove screws and release scanner imaging unit



4. Place Imaging unit according to label number as -1/0/+1 then assemble plate-spring after assembly of FFC into Imaging unit.

**⚠ CAUTION:** Do not remove or adjust the other two screws shown as they require factory setting only.

Figure 2-503 Place Imaging unit according to label number as -1/0/+1





## Unpack the replacement assembly

Follow these steps to unpack the replacement assembly.

1. Dispose of the defective part.




**NOTE:** HP recommends responsible disposal of the defective part.

<http://www8.hp.com/us/en/hp-information/environment/product-recycling.html>

---

2. Unpack the replacement part from the packaging.



**CAUTION:**  Some parts are sensitive to electrostatic discharge (ESD). Always perform service work at an ESD-protected workstation or mat. If an ESD workstation or mat is not available, touch the sheet-metal chassis to provide a static ground before touching an ESD-sensitive assembly. Protect the ESD-sensitive assemblies by placing them in ESD pouches when they are out of the printer.



**IMPORTANT:** Make sure that all of the shipping materials (for example shipping tape) are removed from the replacement part prior to installation.



**NOTE:** If the replacement part is a roller or pad, avoid touching the spongy part of it. Skin oils on the roller or pad can cause paper pickup and/or print-quality problems. HP recommends using disposable gloves when handling rollers or pads or washing your hands before touching rollers or pads.

---

3. To install an assembly, reverse the removal steps.



**NOTE:** When applicable, special installation instructions are provided for an assembly at the end of the removal procedure. Always completely read the removal instructions and follow all special installation instructions.

---

## Removal and replacement: Scanner APS sensor


This document provides the procedures to remove the APS sensor assembly.

 [View a video of removing and replacing the sensor \(E77820-E77830\).](#)

Mean time to repair: 25 minutes

Service level: Advanced

---

 **IMPORTANT:** When applicable, special installation instructions are provided for an assembly at the end of the removal procedure. Always completely read the removal instructions and follow all special installation instructions.

---

### Before performing service

- Disconnect the power cable.

Use the table below to identify the correct part number for your printer. To order the part, go to [www.hp.com/buy/parts](http://www.hp.com/buy/parts)

**Table 2-106** Part information

Part number	Part description
JC97-04507A	APS sensor assembly

### Required tools

- #2 JIS screwdriver with a magnetic tip

### After performing service

#### Turn the printer power on

- Connect the power cable.
- Use the power switch to turn the power on.

### Post service test

Copy, scan, or print a document. Verify the document copies, scans, or prints correctly.

## Remove the scanner glass

Follow these steps to remove the scanner glass.

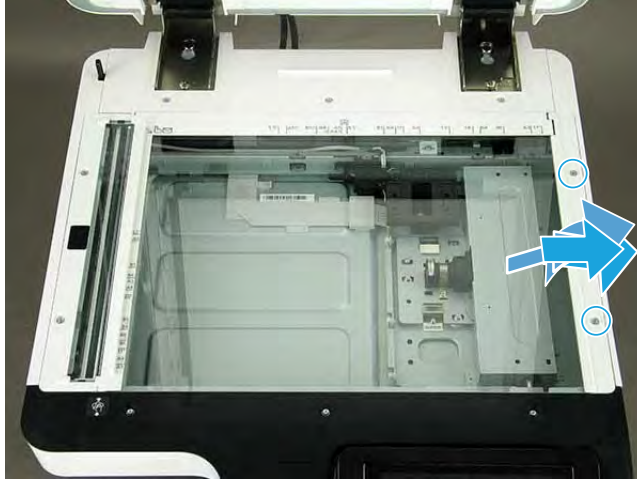
---

 **CAUTION:** Make sure not to be contaminated in scanner while scanner glass is removed.

---

Open the document-feeder cover, remove two screws, and then slide the scanner glass to the right to remove it.

Figure 2-504 Remove scanner glass

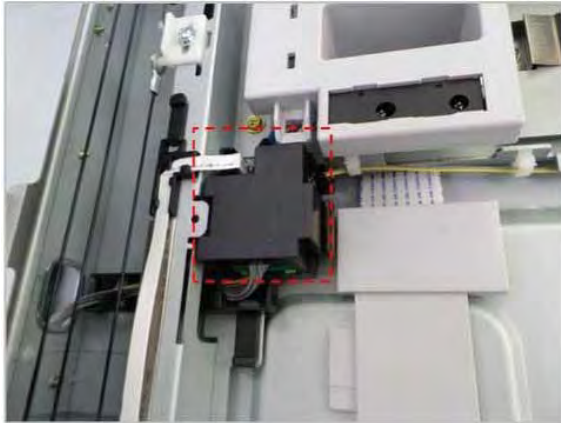


### Remove the APS sensor

Follow these steps to remove the APS sensor.

1. Remove the joint board cover.

Figure 2-505 Remove joint board cover



2. Remove one screw.

Figure 2-506 Remove screw



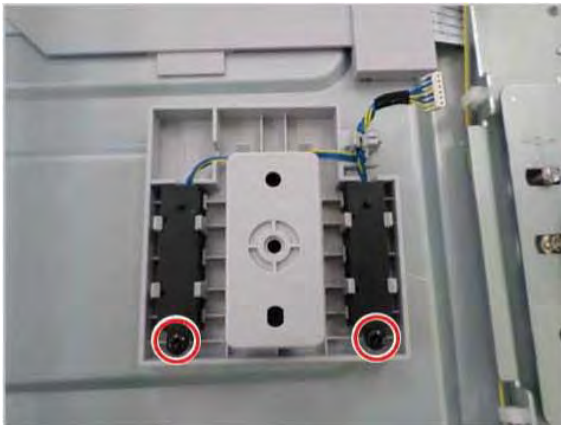
3. Disconnect the harness.

Figure 2-507 Disconnect harness



4. Remove two screws. Release the APS sensor.

Figure 2-508 Remove screws and release APS sensor



## Unpack the replacement assembly

Follow these steps to unpack the replacement assembly.

1. Dispose of the defective part.



---

 **NOTE:** HP recommends responsible disposal of the defective part.


<http://www8.hp.com/us/en/hp-information/environment/product-recycling.html>

---

2. Unpack the replacement part from the packaging.


 **CAUTION:**  Some parts are sensitive to electrostatic discharge (ESD). Always perform service work at an ESD-protected workstation or mat. If an ESD workstation or mat is not available, touch the sheet-metal chassis to provide a static ground before touching an ESD-sensitive assembly. Protect the ESD-sensitive assemblies by placing them in ESD pouches when they are out of the printer.

 **IMPORTANT:** Make sure that all of the shipping materials (for example shipping tape) are removed from the replacement part prior to installation.

 **NOTE:** If the replacement part is a roller or pad, avoid touching the spongy part of it. Skin oils on the roller or pad can cause paper pickup and/or print-quality problems. HP recommends using disposable gloves when handling rollers or pads or washing your hands before touching rollers or pads.

---

3. To install an assembly, reverse the removal steps.

 **NOTE:** When applicable, special installation instructions are provided for an assembly at the end of the removal procedure. Always completely read the removal instructions and follow all special installation instructions.

---

## Second Exit (Optional)

View the second exit repair procedures.

### Remove the second exit (Optional)

Follow these steps to remove the second exit.

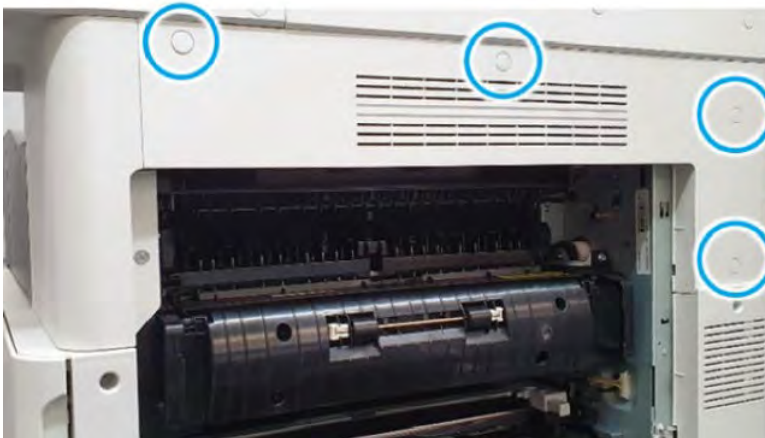
1. Open the right door, then remove the 1 screw.

**Figure 2-509** Remove the screw



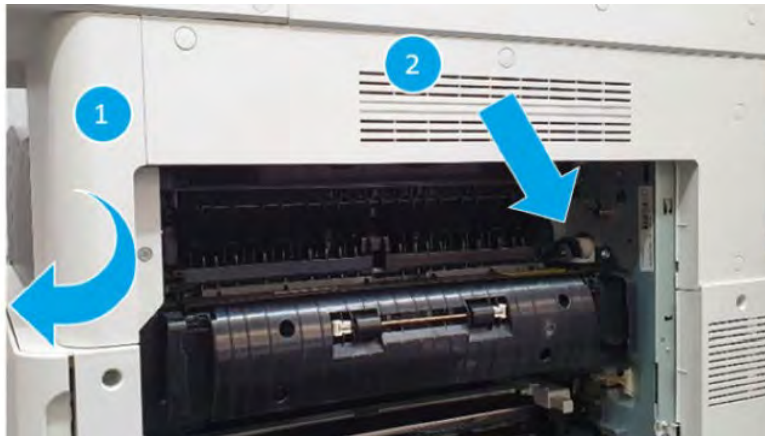
2. Remove 4 caps, then remove 4 screws.

**Figure 2-510** Remove the screws



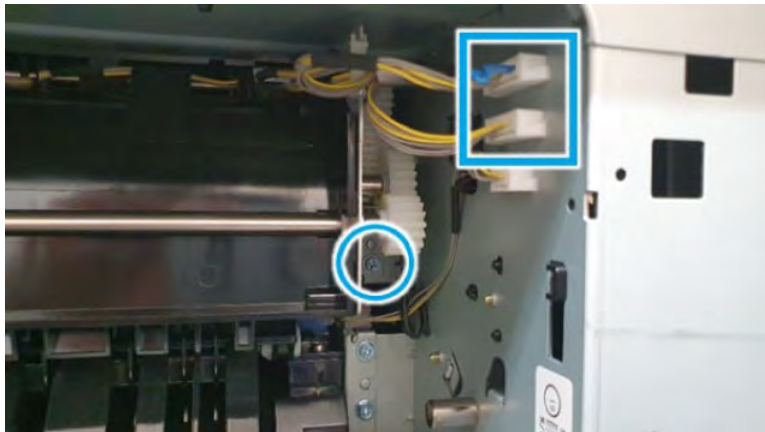
3. Pull the cover (callout 1) to the arrow direction carefully, and pull out the cover (callout 2).

Figure 2-511 Remove the cover



4. Remove 2 connectors, then remove 1 screw.

Figure 2-512 Remove the connectors and the screw



5. Pull the left side of the second exit unit (Callout 1), then remove second exit unit.

Figure 2-513 Remove the second exit unit



## Remove the return gate solenoid (Optional)

Follow these steps to remove the return gate solenoid.

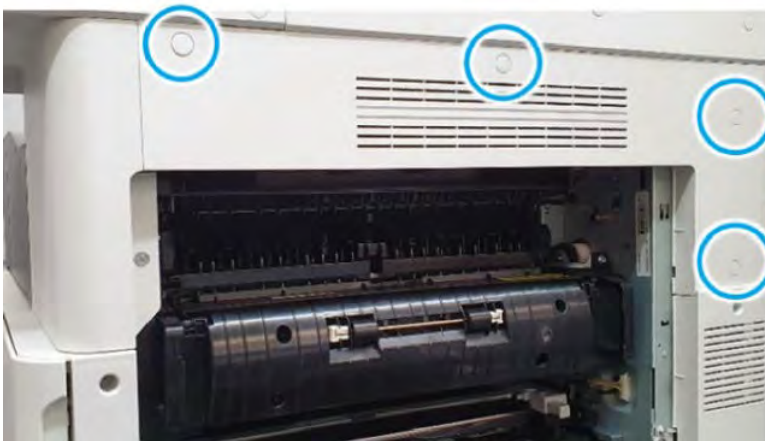
1. Open the right door, then remove the 1 screw.

Figure 2-514 Remove the screw



2. Remove 4 caps, then remove 4 screws.

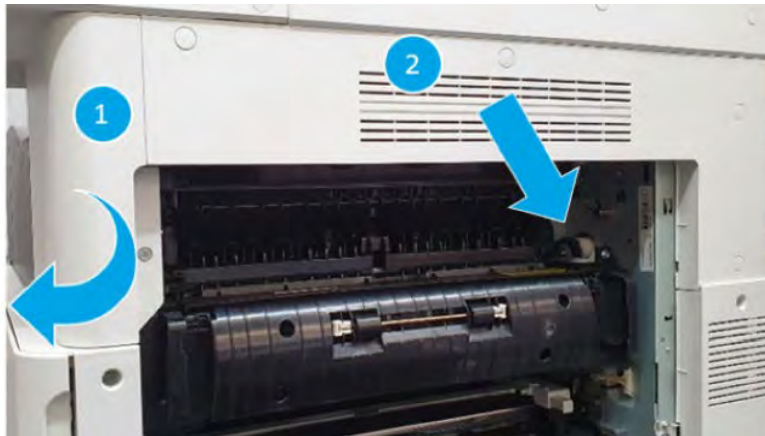
Figure 2-515 Remove the screws





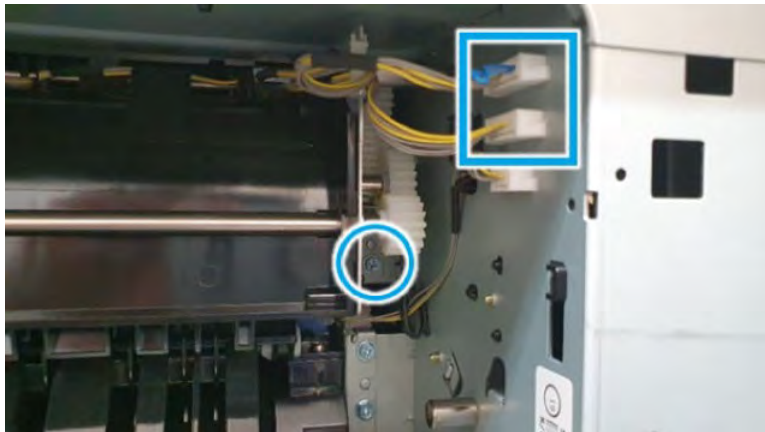
3. Pull the cover (callout 1) to the arrow direction carefully, and pull out the cover (callout 2).

Figure 2-516 Remove the cover



4. Remove 2 cables, then remove 1 screw.

Figure 2-517 Remove the connectors and the screw



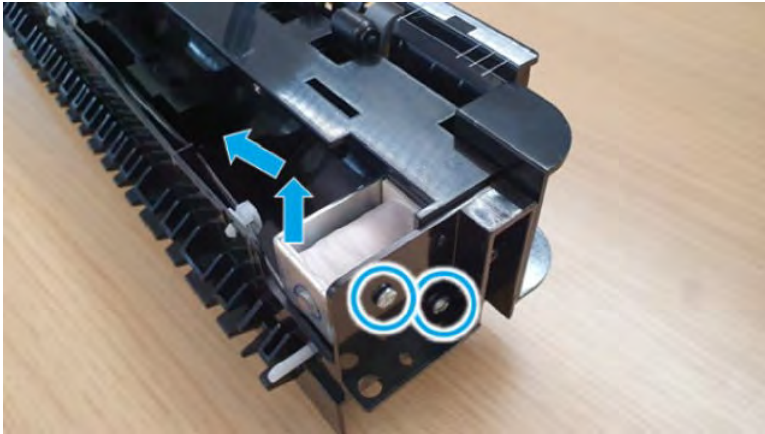
5. Pull the left side of the second exit unit (Callout 1), then remove second exit unit.

Figure 2-518 Remove the second exit unit



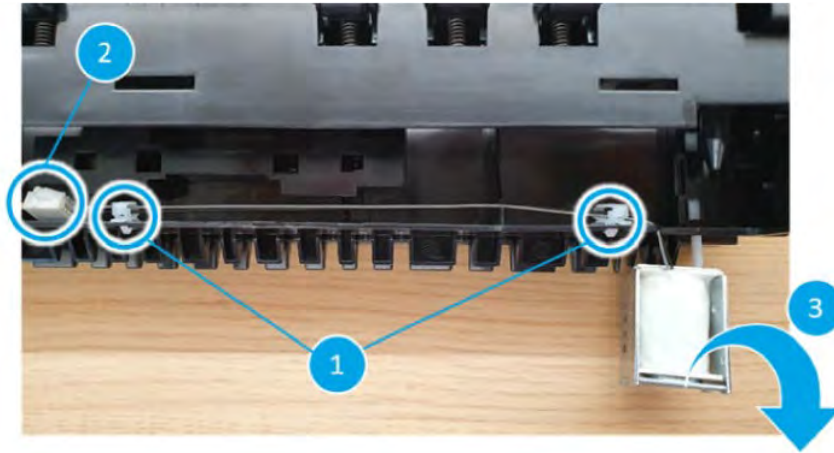
6. Remove 2 screws, then pull out the solenoid to the arrow direction carefully.

Figure 2-519 Remove the screws



7. Remove 2 hooks(Callout 1) and 1 plug(Callout 2). Then remove the solenoid(Callout 3)

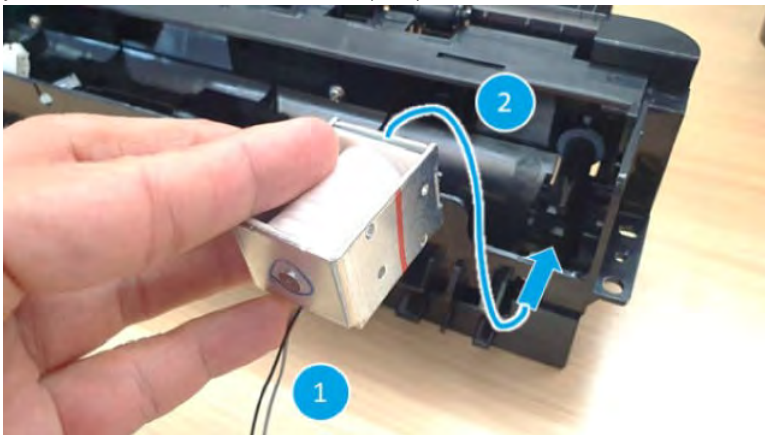
Figure 2-520 Remove the solenoid



**TIP:** Reassembly tip

Be sure the wiring harness should be located under the solenoid (Callout 1)

you must assemble the arrow-shaped plastic into the hole in the solenoid (Callout 2)



## Dual cassette feeder (DCF)

Learn about the dual cassette feeder (DCF) exploded diagrams, parts lists, and repair procedures.

## DCF main

View the DCF main exploded view, parts list, and repair procedures.

## DCF main

Parts diagram and parts list for the DCF main.

Figure 2-521 DCF main

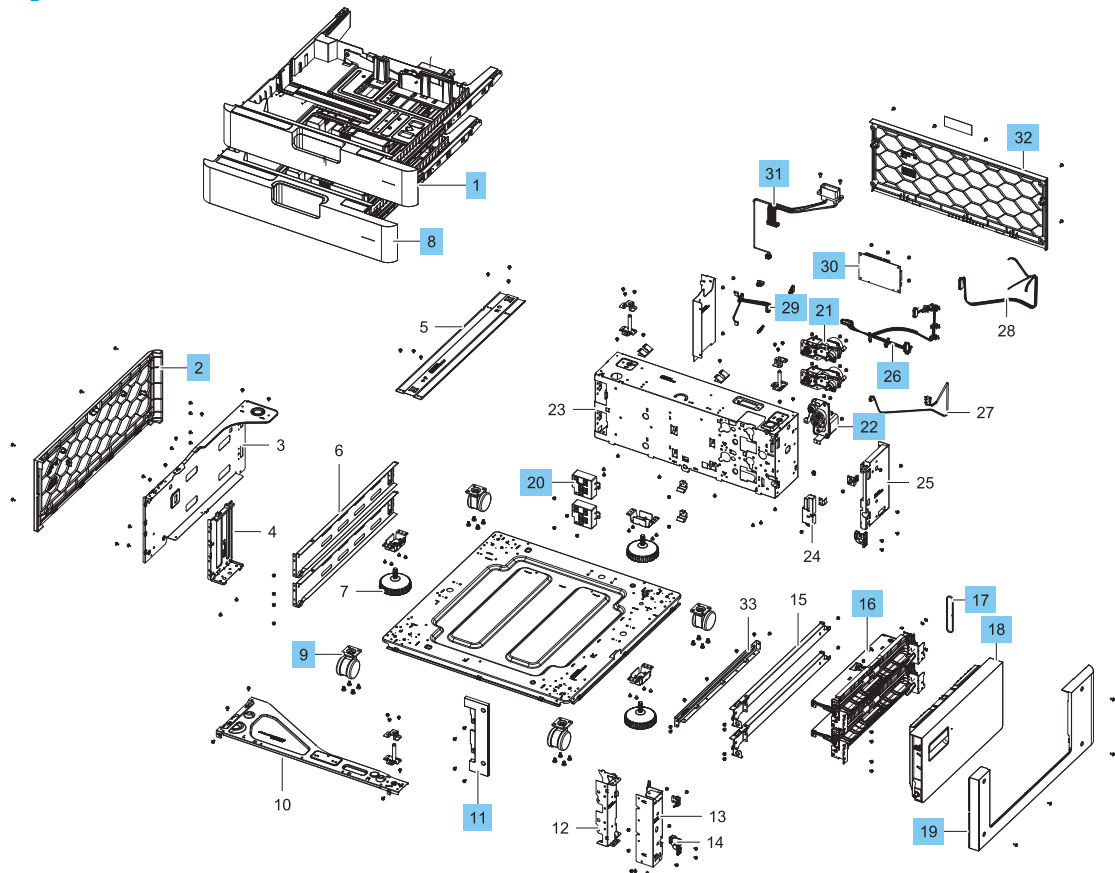


Table 2-107 DCF main


Ref				
No	Part number	Description	Qty	Repair procedure
1	JC90-01666A	Cassette, four		Not applicable
2	JC63-04607B	DCF, left cover		Not applicable
8	JC90-01664A	Cassette five		Not applicable
9	6109-001138	Caster wheel	4	Not applicable
11	JC63-04606B	DCF, front cover	2	Not applicable
16	JC93-00513A	Main pickup	2	Not applicable
17	6602-003185	Timing belt, gear	1	Not applicable
18	JC90-01285A	Right Door	1	<a href="#">Removal and replacement: Dual-cassette feeder (DCF) right door on page 650</a>
19	JC63-04605B	DCF, right cover	1	Not applicable
20	JC93-00018A	Rear auto-size holder	2	Not applicable
21	JC93-00442B	Drive assembly - main, (DCF pickup motor)	1	<a href="#">Removal and replacement: Dual-cassette feeder (DCF) pickup motor on page 660</a>
22	JC93-00447A	Drive Feed Assy (DCF motor)	1	<a href="#">Removal and replacement: Dual-cassette feeder (DCF) motor on page 656</a>
26	JC39-01692A	Drive Feed Assy	1	Not applicable
29	JC39-01695A	Cable, DCR Size Sensor	1	Not applicable
30	JC92-02978A	PCA - MX4 DCF	1	<a href="#">Removal and replacement: Dual-cassette feeder (DCF) PCA on page 653</a>
31	JC39-01690A	IF Cable	1	Not applicable
32	JC63-04604B	DCF, rear cover	1	<a href="#">Removal and replacement: Dual-cassette feeder (DCF) rear cover on page 648</a>
Not shown	JC92-02622C	PCA Paper Size Sensor	1	Not applicable
Not shown	JC92-02978A	PCA, dual cassette feeder (DCF)		<a href="#">Removal and replacement: Dual-cassette feeder (DCF) PCA on page 653</a>

## Removal and replacement: Dual-cassette feeder (DCF) rear cover

This document provides the procedures to remove the dual cassette feeder (DCF) rear cover assembly.


Mean time to repair: 5 minutes

Service level: Basic

 **IMPORTANT:** When applicable, special installation instructions are provided for an assembly at the end of the removal procedure. Always completely read the removal instructions and follow all special installation instructions.

### Before performing service

- Disconnect the power cable.

 **WARNING!** To avoid damage to the printer, turn the printer off, wait 30 seconds, and then remove the power cable before attempting to service the printer.

Use the table below to identify the correct part number for your printer. To order the part, go to [www.hp.com/buy/parts](http://www.hp.com/buy/parts)

Table 2-108 Part information

Part number	Part description
JC63-04604B	Dual cassette feeder (DCF) rear cover assembly

### Required tools

- #2 JIS screwdriver with a magnetic tip

### After performing service

#### Turn the printer power on

- Connect the power cable.
- Use the power switch to turn the power on.

### Post service test

Copy, scan, or print a document. Verify the document copies, scans, or prints correctly.

### Remove the dual cassette feeder (DCF) rear cover

Follow these steps to remove the dual cassette feeder (DCF) rear cover.

- ▲ Remove four screw caps and four screws, and then remove the rear cover.

Figure 2-522 Remove the DCF rear cover



### Unpack the replacement assembly



Follow these steps to unpack the replacement assembly.


1. Dispose of the defective part.


 **NOTE:** HP recommends responsible disposal of the defective part.

<http://www8.hp.com/us/en/hp-information/environment/product-recycling.html>


2. Unpack the replacement part from the packaging.

 **CAUTION:**  Some parts are sensitive to electrostatic discharge (ESD). Always perform service work at an ESD-protected workstation or mat. If an ESD workstation or mat is not available, touch the sheet-metal chassis to provide a static ground before touching an ESD-sensitive assembly. Protect the ESD-sensitive assemblies by placing them in ESD pouches when they are out of the printer.

 **IMPORTANT:** Make sure that all of the shipping materials (for example shipping tape) are removed from the replacement part prior to installation.

 **NOTE:** If the replacement part is a roller or pad, avoid touching the spongy part of it. Skin oils on the roller or pad can cause paper pickup and/or print-quality problems. HP recommends using disposable gloves when handling rollers or pads or washing your hands before touching rollers or pads.

3. To install an assembly, reverse the removal steps.


 **NOTE:** When applicable, special installation instructions are provided for an assembly at the end of the removal procedure. Always completely read the removal instructions and follow all special installation instructions.

## Removal and replacement: Dual-cassette feeder (DCF) right door

This document provides the procedures to remove the dual cassette feeder (DCF) right door assembly.


Meant time to repair: 5 minutes

Service level: Basic

 **IMPORTANT:** When applicable, special installation instructions are provided for an assembly at the end of the removal procedure. Always completely read the removal instructions and follow all special installation instructions.

### Before performing service

- Disconnect the power cable.

 **WARNING!** To avoid damage to the printer, turn the printer off, wait 30 seconds, and then remove the power cable before attempting to service the printer.

Use the table below to identify the correct part number for your printer. To order the part, go to [www.hp.com/buy/parts](http://www.hp.com/buy/parts)

Table 2-109 Part information

Part number	Part description
JC90-01285A	DCF right door

### Required tools

- #2 JIS screwdriver with a magnetic tip

### After performing service

#### Turn the printer power on

- Connect the power cable.
- Use the power switch to turn the power on.

### Post service test

Copy, scan, or print a document. Verify the document copies, scans, or prints correctly.

### Remove the DCF right door

Follow these steps to remove the DCF right door.

1. Remove four screw caps and four screws, and then remove the lower right cover.

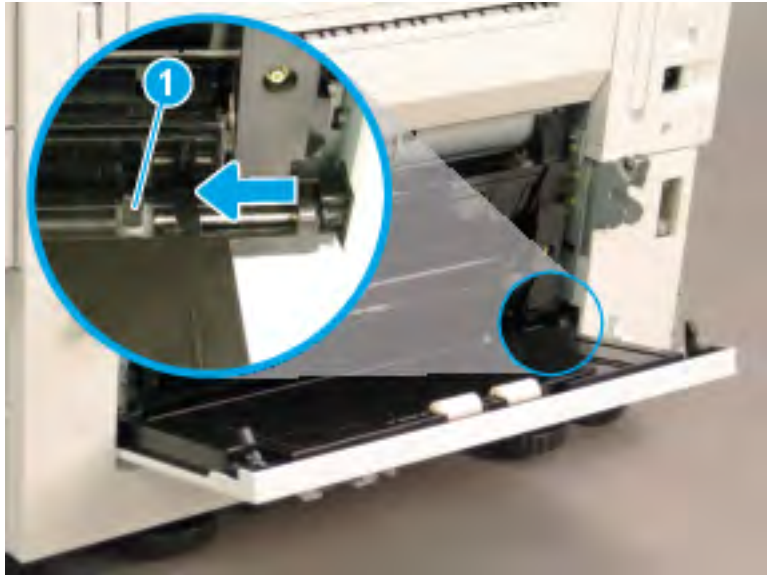


Figure 2-523 Remove the lower right cover



2. Open the DCF right door and slide the hinge pin to the left. Make sure that the pin slides under the tab (callout 1).

Figure 2-524 Slide the hinge pin



3. Rotate the right edge of the door away from the feeder (callout 1), and then slide the door to the right to remove it (callout 2).

**Figure 2-525** Remove the DCF right door



### Unpack the replacement assembly



Follow these steps to unpack the replacement assembly.


1. Dispose of the defective part.


 **NOTE:** HP recommends responsible disposal of the defective part.

<http://www8.hp.com/us/en/hp-information/environment/product-recycling.html>


2. Unpack the replacement part from the packaging.

 **CAUTION:**  Some parts are sensitive to electrostatic discharge (ESD). Always perform service work at an ESD-protected workstation or mat. If an ESD workstation or mat is not available, touch the sheet-metal chassis to provide a static ground before touching an ESD-sensitive assembly. Protect the ESD-sensitive assemblies by placing them in ESD pouches when they are out of the printer.

 **IMPORTANT:** Make sure that all of the shipping materials (for example shipping tape) are removed from the replacement part prior to installation.

 **NOTE:** If the replacement part is a roller or pad, avoid touching the spongy part of it. Skin oils on the roller or pad can cause paper pickup and/or print-quality problems. HP recommends using disposable gloves when handling rollers or pads or washing your hands before touching rollers or pads.

3. To install an assembly, reverse the removal steps.

 **NOTE:** When applicable, special installation instructions are provided for an assembly at the end of the removal procedure. Always completely read the removal instructions and follow all special installation instructions.

## Removal and replacement: Dual-cassette feeder (DCF) PCA

This document provides the procedures to remove the dual cassette feeder (DCF) PCA assembly.

Mean time to repair: 15 minutes

Service level: Intermediate



**IMPORTANT:** When applicable, special installation instructions are provided for an assembly at the end of the removal procedure. Always completely read the removal instructions and follow all special installation instructions.

### Before performing service

- Disconnect the power cable.



**WARNING!** To avoid damage to the printer, turn the printer off, wait 30 seconds, and then remove the power cable before attempting to service the printer.

Use the table below to identify the correct part number for your printer. To order the part, go to [www.hp.com/buy/parts](http://www.hp.com/buy/parts)

**Table 2-110** Part information

Part number	Part description
JC92-02978A	Dual cassette feeder (DCF) PCA assembly

### Required tools

- #2 JIS screwdriver with a magnetic tip

### After performing service

#### Turn the printer power on

- Connect the power cable.
- Use the power switch to turn the power on.

### Post service test

Copy, scan, or print a document. Verify the document copies, scans, or prints correctly.

### Remove the dual cassette feeder (DCF) rear cover

Follow these steps to remove the dual cassette feeder (DCF) rear cover.

- ▲ Remove four screw caps and four screws, and then remove the rear cover.

Figure 2-526 Remove the DCF rear cover

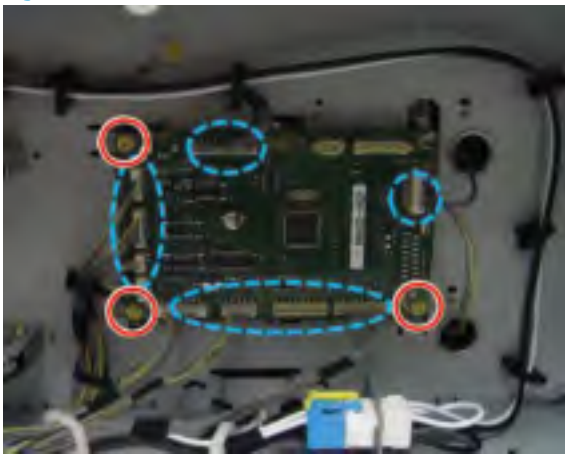


### Remove the DCF PCA

Follow these steps to remove the DCF PCA.

- ▲ Disconnect eight connectors, remove three screws, and then remove the DCF PCA.

Figure 2-527 Remove the DCF PCA



### Unpack the replacement assembly

Follow these steps to unpack the replacement assembly.

1. Dispose of the defective part.



---

 **NOTE:** HP recommends responsible disposal of the defective part.


<http://www8.hp.com/us/en/hp-information/environment/product-recycling.html>

---

2. Unpack the replacement part from the packaging.


 **CAUTION:**  Some parts are sensitive to electrostatic discharge (ESD). Always perform service work at an ESD-protected workstation or mat. If an ESD workstation or mat is not available, touch the sheet-metal chassis to provide a static ground before touching an ESD-sensitive assembly. Protect the ESD-sensitive assemblies by placing them in ESD pouches when they are out of the printer.

 **IMPORTANT:** Make sure that all of the shipping materials (for example shipping tape) are removed from the replacement part prior to installation.

 **NOTE:** If the replacement part is a roller or pad, avoid touching the spongy part of it. Skin oils on the roller or pad can cause paper pickup and/or print-quality problems. HP recommends using disposable gloves when handling rollers or pads or washing your hands before touching rollers or pads.

---

3. To install an assembly, reverse the removal steps.

 **NOTE:** When applicable, special installation instructions are provided for an assembly at the end of the removal procedure. Always completely read the removal instructions and follow all special installation instructions.


---

## Removal and replacement: Dual-cassette feeder (DCF) motor

This document provides the procedures to remove the DCF motor assembly.


Mean time to repair: 10 minutes

Service level: Basic

 **IMPORTANT:** When applicable, special installation instructions are provided for an assembly at the end of the removal procedure. Always completely read the removal instructions and follow all special installation instructions.

### Before performing service

- Disconnect the power cable.

 **WARNING!** To avoid damage to the printer, turn the printer off, wait 30 seconds, and then remove the power cable before attempting to service the printer.

Use the table below to identify the correct part number for your printer. To order the part, go to [www.hp.com/buy/parts](http://www.hp.com/buy/parts)

**Table 2-111** Part information

Part number	Part description
JC93-00447A	DCF motor

### Required tools

- #2 JIS screwdriver with a magnetic tip

### After performing service

#### Turn the printer power on

- Connect the power cable.
- Use the power switch to turn the power on.

### Post service test

Copy, scan, or print a document. Verify the document copies, scans, or prints correctly.

### Remove the dual cassette feeder (DCF) rear cover

Follow these steps to remove the dual cassette feeder (DCF) rear cover.

- ▲ Remove four screw caps and four screws, and then remove the rear cover.

Figure 2-528 Remove the DCF rear cover



### Remove the DCF motor

Follow these steps to remove the DCF motor.

1. Disconnect two connectors, and then open one retainer.

Figure 2-529 Disconnect two connectors and open one retainer



2. Remove three screws, and then remove the feed drive unit.

**Figure 2-530** Remove the feed drive unit



3. Remove two screws, and then remove the feed motor.

**Figure 2-531** Remove the feed motor



### Unpack the replacement assembly

Follow these steps to unpack the replacement assembly.

1. Dispose of the defective part.





---

 **NOTE:** HP recommends responsible disposal of the defective part.


<http://www8.hp.com/us/en/hp-information/environment/product-recycling.html>

---

2. Unpack the replacement part from the packaging.


 **CAUTION:**  Some parts are sensitive to electrostatic discharge (ESD). Always perform service work at an ESD-protected workstation or mat. If an ESD workstation or mat is not available, touch the sheet-metal chassis to provide a static ground before touching an ESD-sensitive assembly. Protect the ESD-sensitive assemblies by placing them in ESD pouches when they are out of the printer.

 **IMPORTANT:** Make sure that all of the shipping materials (for example shipping tape) are removed from the replacement part prior to installation.

 **NOTE:** If the replacement part is a roller or pad, avoid touching the spongy part of it. Skin oils on the roller or pad can cause paper pickup and/or print-quality problems. HP recommends using disposable gloves when handling rollers or pads or washing your hands before touching rollers or pads.

---

3. To install an assembly, reverse the removal steps.

 **NOTE:** When applicable, special installation instructions are provided for an assembly at the end of the removal procedure. Always completely read the removal instructions and follow all special installation instructions.


---

## Removal and replacement: Dual-cassette feeder (DCF) pickup motor

This document provides the procedures to remove the DCF pickup motor assembly.


Mean time to repair: 10 minutes

Service level: Basic

 **IMPORTANT:** When applicable, special installation instructions are provided for an assembly at the end of the removal procedure. Always completely read the removal instructions and follow all special installation instructions.

### Before performing service

- Disconnect the power cable.

 **WARNING!** To avoid damage to the printer, turn the printer off, wait 30 seconds, and then remove the power cable before attempting to service the printer.

Use the table below to identify the correct part number for your printer. To order the part, go to [www.hp.com/buy/parts](http://www.hp.com/buy/parts)

**Table 2-112** Part information

Part number	Part description
JC93-00442B	DCF pickup motor assembly

### Required tools

- #2 JIS screwdriver with a magnetic tip

### After performing service

#### Turn the printer power on

- Connect the power cable.
- Use the power switch to turn the power on.

### Post service test

Copy, scan, or print a document. Verify the document copies, scans, or prints correctly.

### Remove the dual cassette feeder (DCF) rear cover

Follow these steps to remove the dual cassette feeder (DCF) rear cover.

- ▲ Remove four screw caps and four screws, and then remove the rear cover.

Figure 2-532 Remove the DCF rear cover

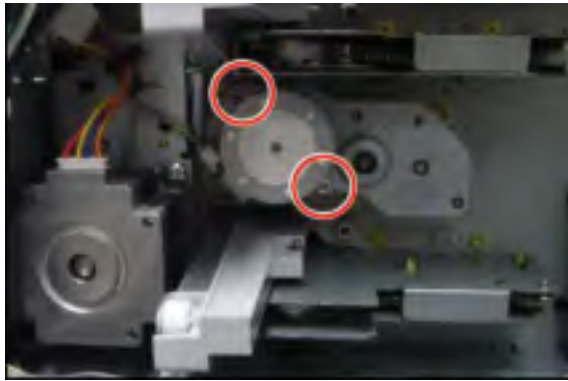


### Remove the DCF pickup motor

Follow these steps to remove the DCF pickup motor.

- ▲ Disconnect the motor connector, remove two screws, and then remove the DCF pickup motor.

Figure 2-533 Remove the DCF pickup motor



### Unpack the replacement assembly

Follow these steps to unpack the replacement assembly.

1. Dispose of the defective part.

---



 **NOTE:** HP recommends responsible disposal of the defective part.


<http://www8.hp.com/us/en/hp-information/environment/product-recycling.html>


---

2. Unpack the replacement part from the packaging.

---

 **CAUTION:**  Some parts are sensitive to electrostatic discharge (ESD). Always perform service work at an ESD-protected workstation or mat. If an ESD workstation or mat is not available, touch the sheet-metal chassis to provide a static ground before touching an ESD-sensitive assembly. Protect the ESD-sensitive assemblies by placing them in ESD pouches when they are out of the printer.


 **IMPORTANT:** Make sure that all of the shipping materials (for example shipping tape) are removed from the replacement part prior to installation.

 **NOTE:** If the replacement part is a roller or pad, avoid touching the spongy part of it. Skin oils on the roller or pad can cause paper pickup and/or print-quality problems. HP recommends using disposable gloves when handling rollers or pads or washing your hands before touching rollers or pads.

---

3. To install an assembly, reverse the removal steps.

---

 **NOTE:** When applicable, special installation instructions are provided for an assembly at the end of the removal procedure. Always completely read the removal instructions and follow all special installation instructions.

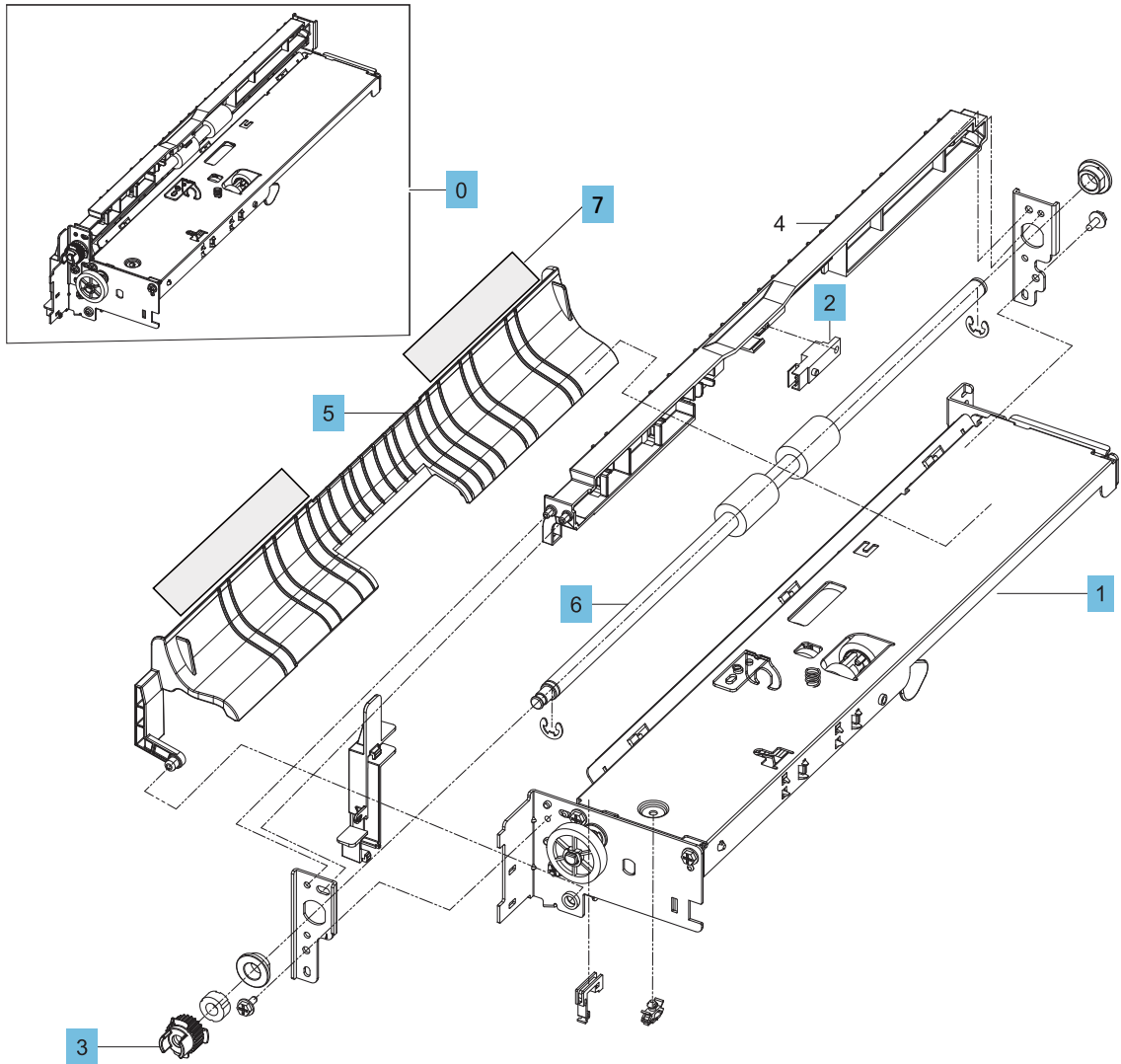
---



## DCF main frame pickup 1

Parts diagram and parts list for the main frame pickup 1.

Figure 2-534 DCF main frame pickup 1



**Table 2-113** DCF main frame pickup 1

Ref				
No	Part number	Description	Qty	Repair procedure
0	JC93-00513A	DCF, main pickup	2	Not applicable
1	JC93-00510A	Main Pickup Sub Assy	2	Not applicable
2	0640-001381	Photo interrupter	2	Not applicable
3	JC66-03288A	Feed pulley	2	Not applicable
5	JC61-04717A	Second pickup guide	2	Not applicable
6	JC66-03287A	Idle feed roller	2	Not applicable
7	JC63-03342A	Feed Mylar	2	Not applicable

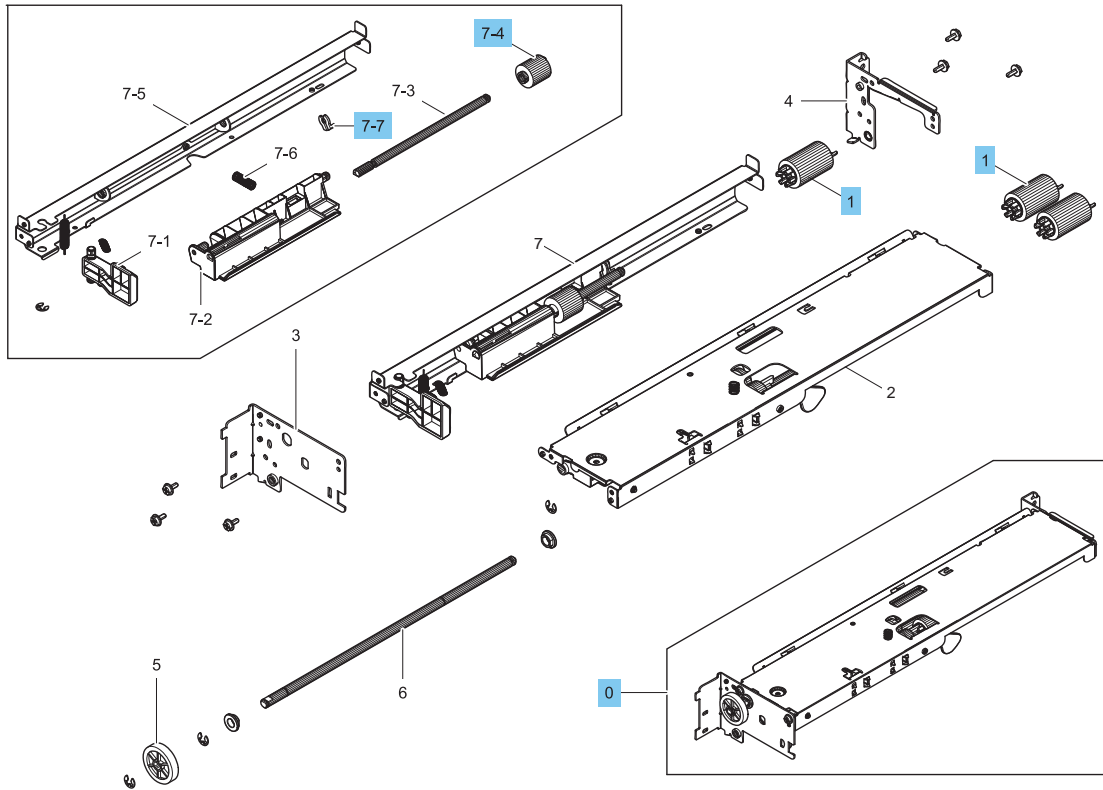
## DCF main frame pickup

View the DCF main frame pickup exploded view, parts list, and repair procedures.

## DCF main frame pickup

Parts diagram and parts list for the DCF main frame pickup.

Figure 2-535 DCF main frame pickup





**Table 2-114 DCF main frame pickup**


Ref				
No	Part number	Description	Qty	Repair procedure
0	JC93-00510A	Main Pickup lower and upper	2	<a href="#">Removal and replacement: Dual-cassette feeder (DCF) pickup units on page 668</a>
1	JC93-00540A	Tray 2-x rollers	6	Not applicable
7-4	JC67-00455A	Coupler, torque limiter	2	Not applicable
7-7	JC61-01367A	Fixer, e-ring	2	Not applicable

## Removal and replacement: Dual-cassette feeder (DCF) pickup units

This document provides the procedures to remove the dual cassette feeder (DCF) pickup units assembly.


Mean time to repair: 15 minutes

Service level: Intermediate

 **IMPORTANT:** When applicable, special installation instructions are provided for an assembly at the end of the removal procedure. Always completely read the removal instructions and follow all special installation instructions.

### Before performing service

- Disconnect the power cable.

 **WARNING!** To avoid damage to the printer, turn the printer off, wait 30 seconds, and then remove the power cable before attempting to service the printer.

Use the table below to identify the correct part number for your printer. To order the part, go to [www.hp.com/buy/parts](http://www.hp.com/buy/parts)

**Table 2-115** Part information

Part number	Part description
JC93-00510A	Dual cassette feeder (DCF) pickup units assembly

### Required tools

- #2 JIS screwdriver with a magnetic tip

### After performing service

#### Turn the printer power on

- Connect the power cable.
- Use the power switch to turn the power on.

### Post service test

Copy, scan, or print a document. Verify the document copies, scans, or prints correctly.

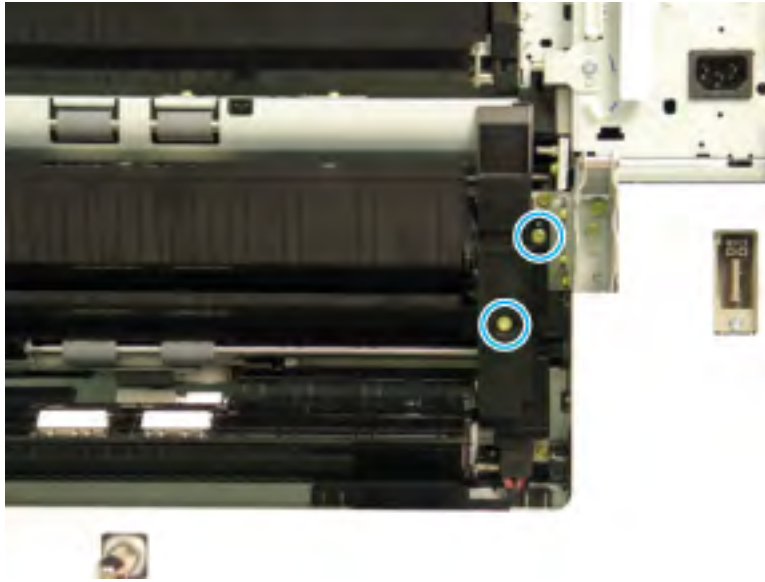
### Remove the Dual cassette feeder (DCF) pickup units

Follow these steps to remove the Dual cassette feeder (DCF) pickup units.

1. Remove the DCF right door.

2. Remove two screws, and then remove the cable cover.

Figure 2-536 Remove two screws and the cable cover



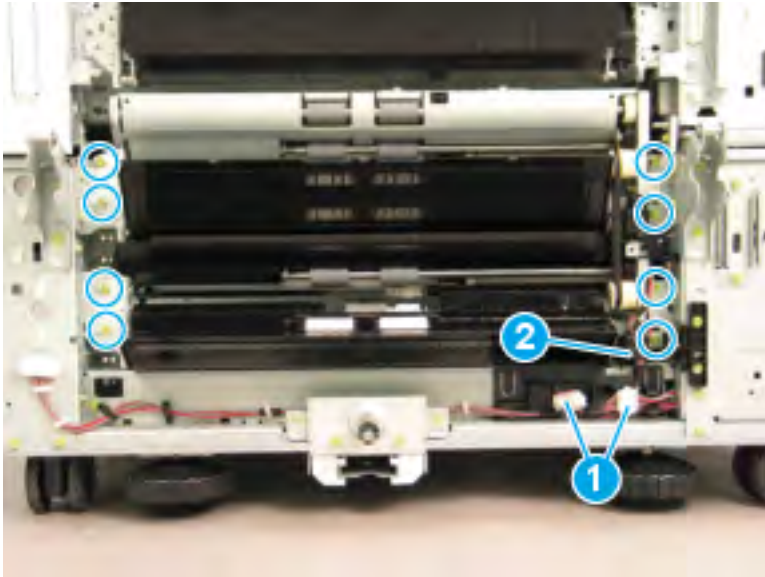
3. At the front of the printer, remove five screws, and then remove two brackets.

Figure 2-537 Remove five screws and two brackets



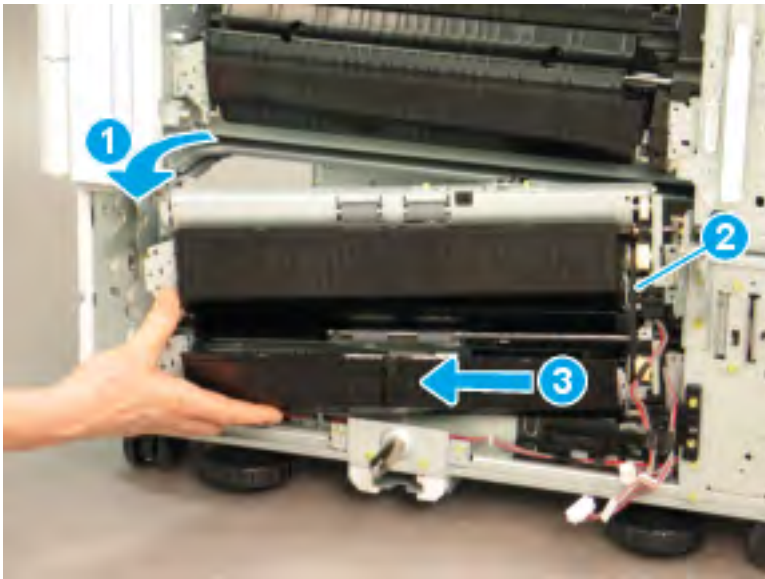
4. Disconnect two connectors (callout 1), and then remove the wire harness from the cable guide (callout 2). Remove eight screws (callout 3).

**Figure 2-538** Disconnect two connectors and remove eight screws



5. Rotate both pickup units away from the feeder on the left (callout 1). Release the belt (callout 2) that connects the two units. Slide the pickup units to the left (callout 3) to remove them.

**Figure 2-539** Remove the pickup units



### Unpack the replacement assembly

Follow these steps to unpack the replacement assembly.

1. Dispose of the defective part.



---

 **NOTE:** HP recommends responsible disposal of the defective part.


<http://www8.hp.com/us/en/hp-information/environment/product-recycling.html>

---

2. Unpack the replacement part from the packaging.


 **CAUTION:**  Some parts are sensitive to electrostatic discharge (ESD). Always perform service work at an ESD-protected workstation or mat. If an ESD workstation or mat is not available, touch the sheet-metal chassis to provide a static ground before touching an ESD-sensitive assembly. Protect the ESD-sensitive assemblies by placing them in ESD pouches when they are out of the printer.

 **IMPORTANT:** Make sure that all of the shipping materials (for example shipping tape) are removed from the replacement part prior to installation.

 **NOTE:** If the replacement part is a roller or pad, avoid touching the spongy part of it. Skin oils on the roller or pad can cause paper pickup and/or print-quality problems. HP recommends using disposable gloves when handling rollers or pads or washing your hands before touching rollers or pads.

---

3. To install an assembly, reverse the removal steps.

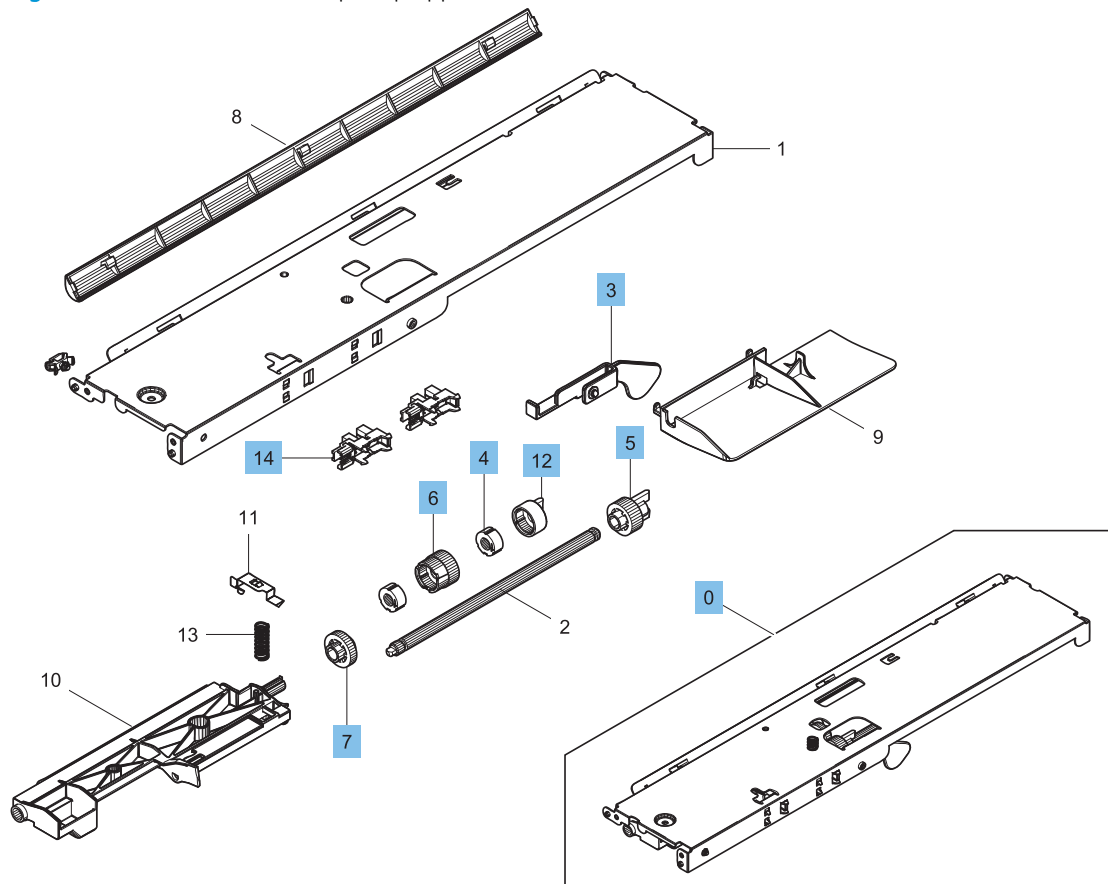
 **NOTE:** When applicable, special installation instructions are provided for an assembly at the end of the removal procedure. Always completely read the removal instructions and follow all special installation instructions.

---

## DCF main frame pickup, upper

Parts diagram and parts list for the main frame pickup upper.

Figure 2-540 DCF main frame pickup upper



**Table 2-116 DCF main frame pickup upper**

Ref				
No	Part number	Description	Qty	Repair procedure
0	JC93-00504A	Main frame pickup, upper	2	Not applicable
3	JC66-03199A	Actuator, empty pickup	2	Not applicable
4	JC66-00977A	Clutch one way	4	Not applicable
5	JC66-00943A	Gear-m, joint	2	Not applicable
6	JC66-00941A	Gear-m, one way	2	Not applicable
7	JC66-00940A	Gear-m, idle	2	Not applicable
12	JC61-01288A	Holder-m, idle one way	2	Not applicable
14	0604-001393	Photo interrupter	4	Not applicable

## High-capacity input (HCI) tray (workgroup)

View the high-capacity input (HCI) tray (workgroup) exploded diagrams and parts lists.



## HCI main

View the HCI main exploded view, parts list, and repair procedures.

## HCI main

Parts diagram and parts list for the HCI main.

Figure 2-541 HCI main

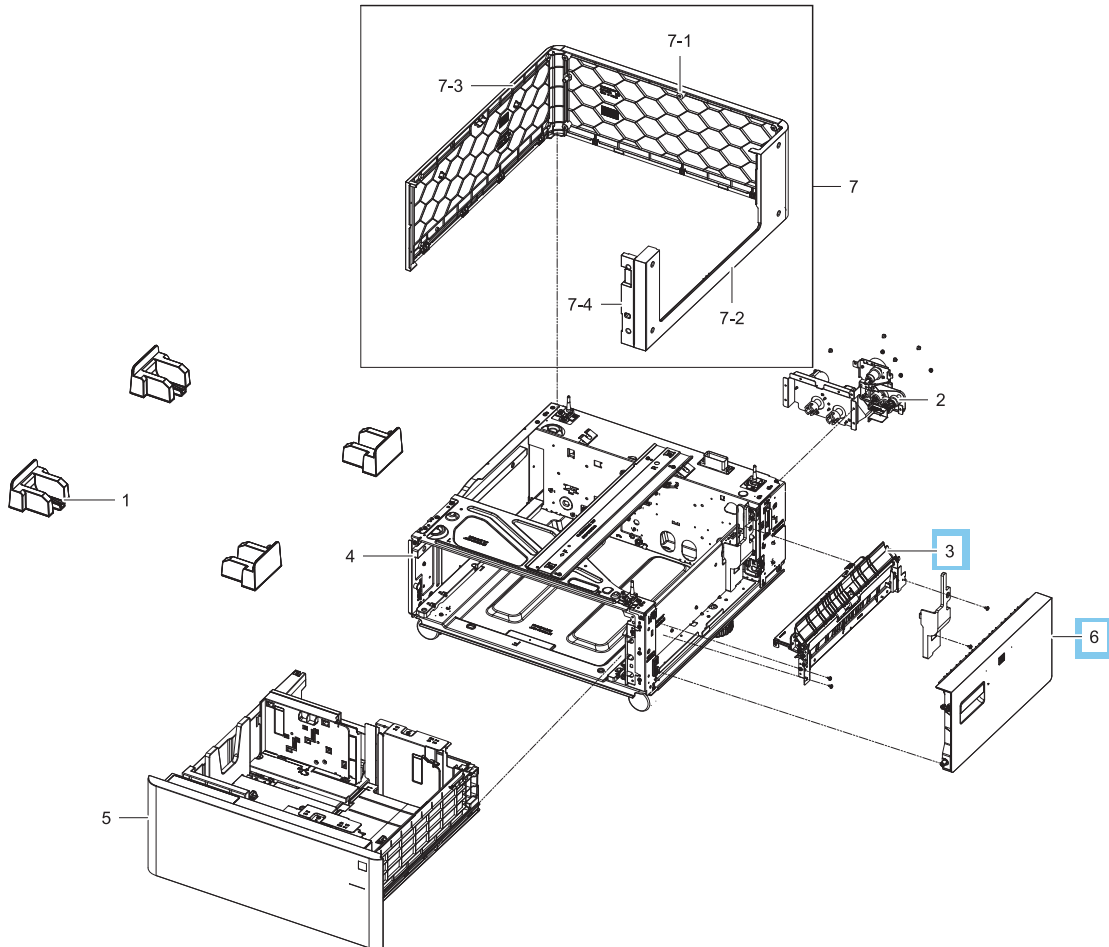


Table 2-117 HCl main

Ref				
No	Part number	Description	Qty	Repair procedure
3	JC90-01727A	Sub-pickup (HCl)	1	<a href="#">Removal and replacement: HCl sub - pickup on page 677</a>
6	JC90-01734A	Takeaway (HCl) (right door)	1	<a href="#">Removal and replacement: HCl right door on page 687</a>

## Removal and replacement: HCI sub - pickup

This document provides the procedures to remove the HCI sub-pickup.



[View a video of removing and replacing the sub-pickup assembly.](#)

Mean time to repair:

Service level:



**IMPORTANT:** When applicable, special installation instructions are provided for an assembly at the end of the removal procedure. Always completely read the removal instructions and follow all special installation instructions.

### Before performing service

- Disconnect the power cable.



**WARNING!** To avoid damage to the printer, turn the printer off, wait 30 seconds, and then remove the power cable before attempting to service the printer.

Use the table below to identify the correct part number for your printer. To order the part, go to [www.hp.com/buy/parts](http://www.hp.com/buy/parts)

**Table 2-118** Part information

Part number	Part description
JC90-01727A	HCI sub - pickup

### Required tools

- #2 JIS screwdriver with a magnetic tip

### After performing service

#### Turn the printer power on

- Connect the power cable.
- Turn on the power switch next to the power cable, and then press the power button on the front of the printer.
- Verify that the service performed was successful.
- Verify that the most recent firmware is installed on the printer.
- Verify that all parts are correctly reinstalled and are properly working.

### Post service test

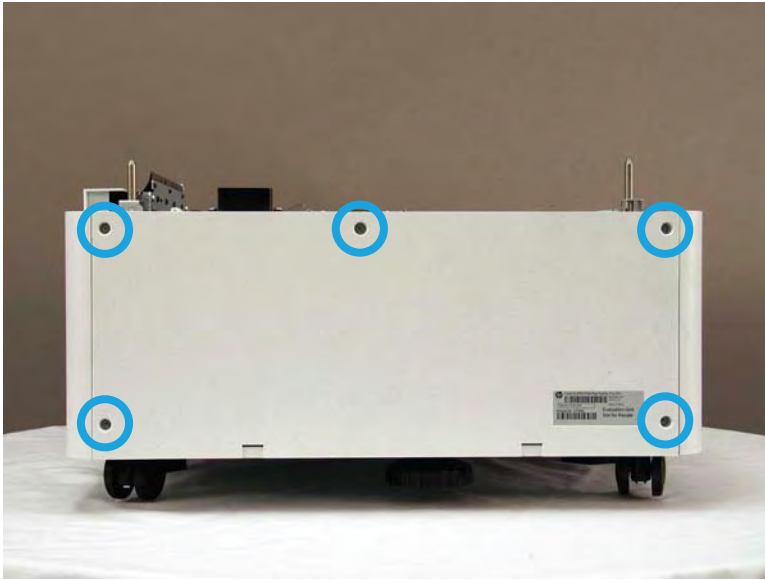
Print any pages necessary to verify that the repair resolved the issue and did not create any new issues.

### Remove the HCI rear cover

Follow these steps to remove the Remove the HCI rear cover.

- ▲ Remove five screw caps (if installed), remove five screws, and then remove the rear cover.

Figure 2-542 Remove the HCI rear cover

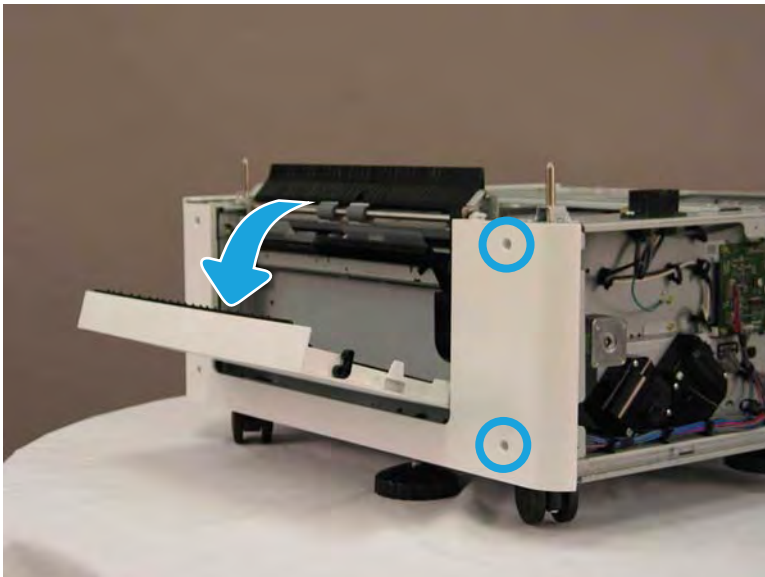


#### Remove the HCI drive assembly - feed

Follow these steps to remove the Remove the HCI drive assembly - feed.

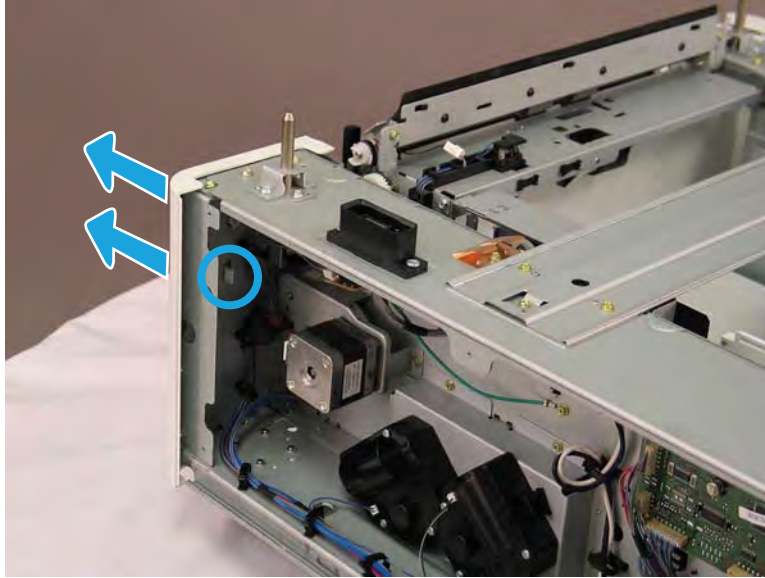
1. Open the right door, and then remove two screws.

Figure 2-543 Remove two screws



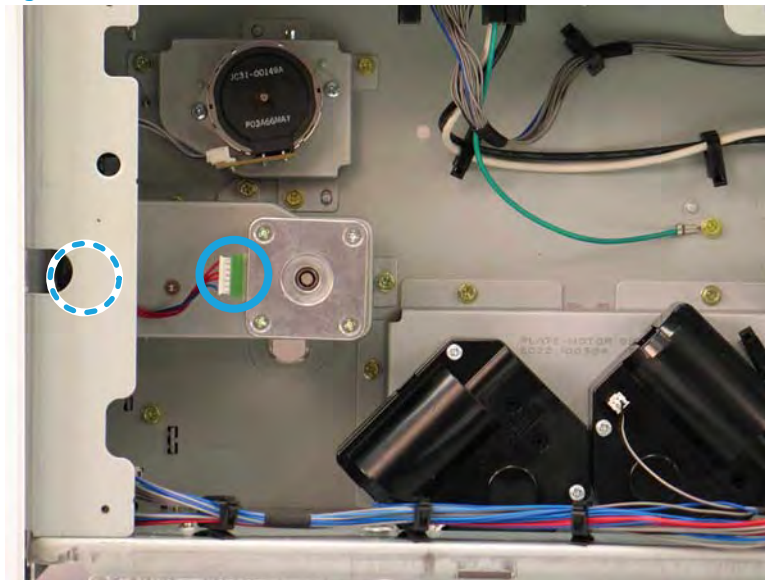
2. Release one tab, and then separate the rear edge of the right cover from the chassis.

Figure 2-544 Separate the rear edge of the right cover from the chassis



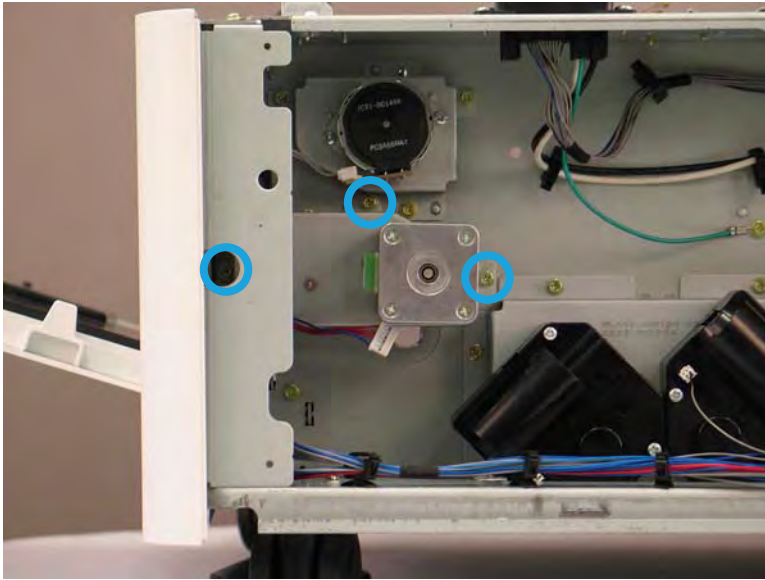
3. Disconnect one connector, and then release the wire harness from the retainer.

Figure 2-545 Disconnect one connector



4. Remove three screws, and then remove the HCI drive assembly - feed.

**Figure 2-546** Remove the HCI drive assembly - feed



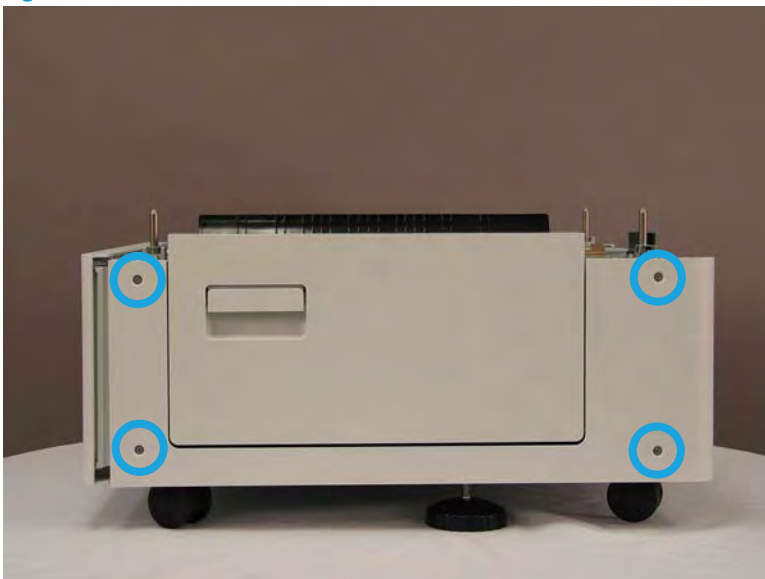
#### Remove the HCI right door

Follow these steps to remove the Remove the HCI right door.

1. Remove four screw caps (if installed), and then remove four screws.

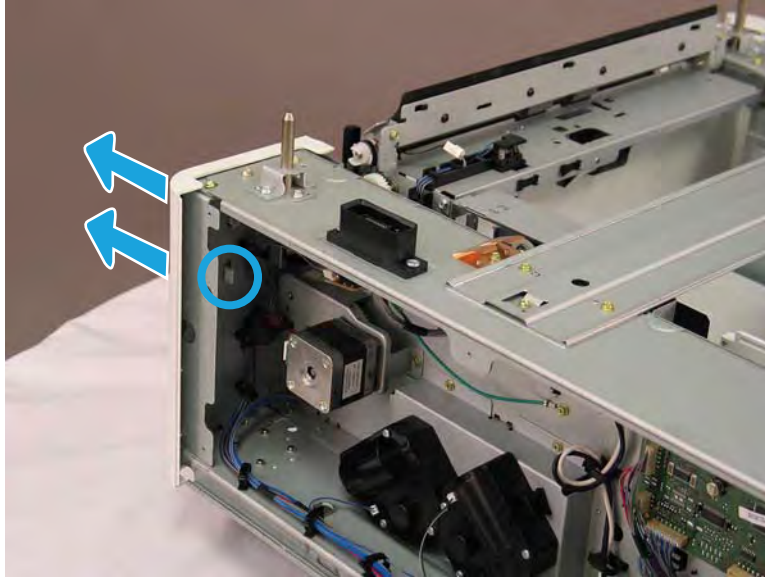
 **NOTE:** If the feed drive assembly is removed, there are only two screws that secure this cover.

**Figure 2-547** Remove four screws



2. Release one tab, and then separate the rear edge of the right cover from the chassis.

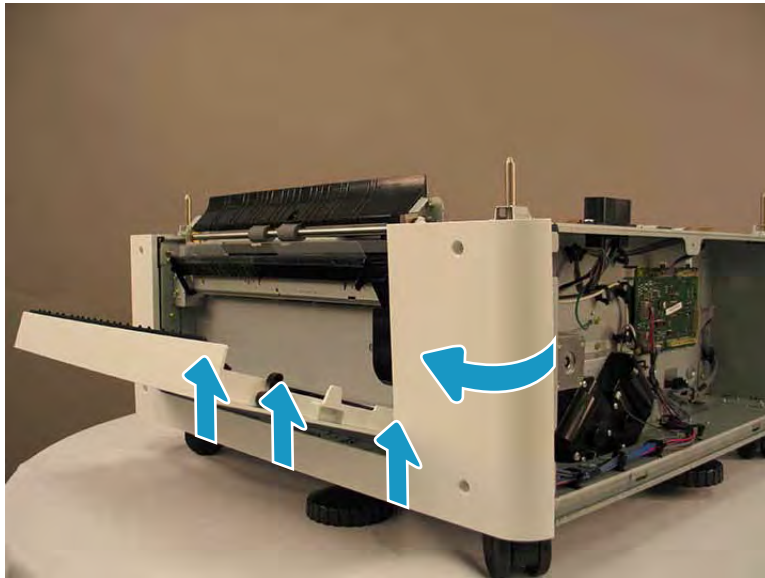
Figure 2-548 Separate the rear edge of the right cover from the chassis



3. Lift up on the cover while rotating it away from the chassis to release three bosses.

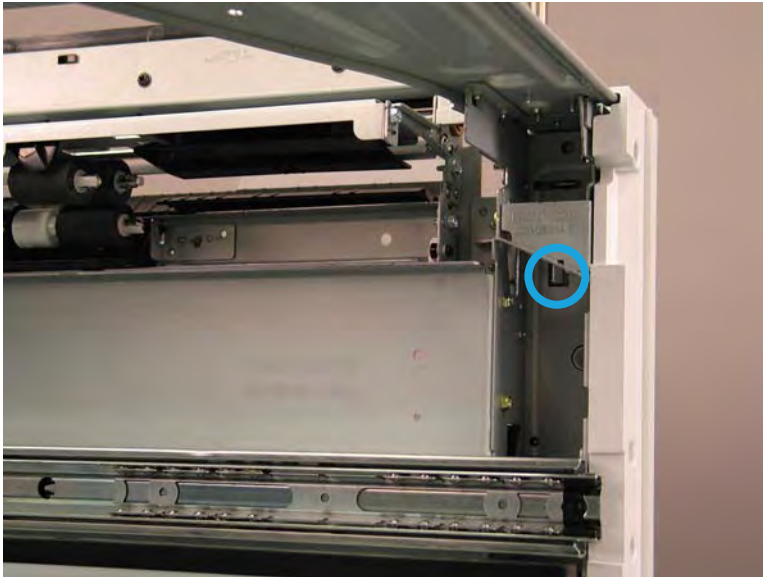
**⚠ CAUTION:** Do not attempt to fully remove the cover. Stop as shown below. Fully removing the cover at this step will damage the remaining tab and boss on the cover

Figure 2-549 Release three bosses



4. If the tray was not removed prior to servicing the HCI, remove it now. Look in the tray cavity and locate the right cover front tab. Release this tab.

Figure 2-550 Release one tab



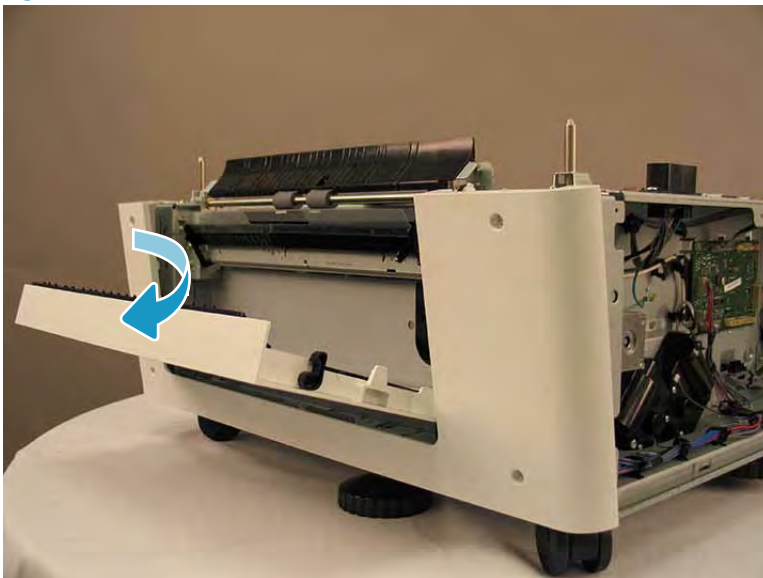
5. Remove the HCI right cover.

---

 **NOTE:** The HCI right door will not stay in the latched position when this cover is removed.

---

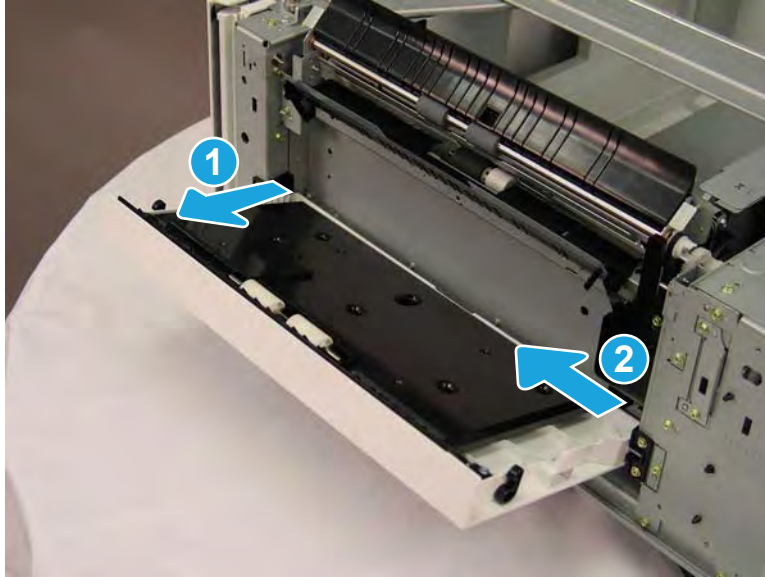
Figure 2-551 Remove the HCI right cover





6. Rotate the right door front hinge pin out of the holder, and then slide the right door towards the front of the HCI to release the rear hinge pin and remove the door.

Figure 2-552 Remove the HCI right door

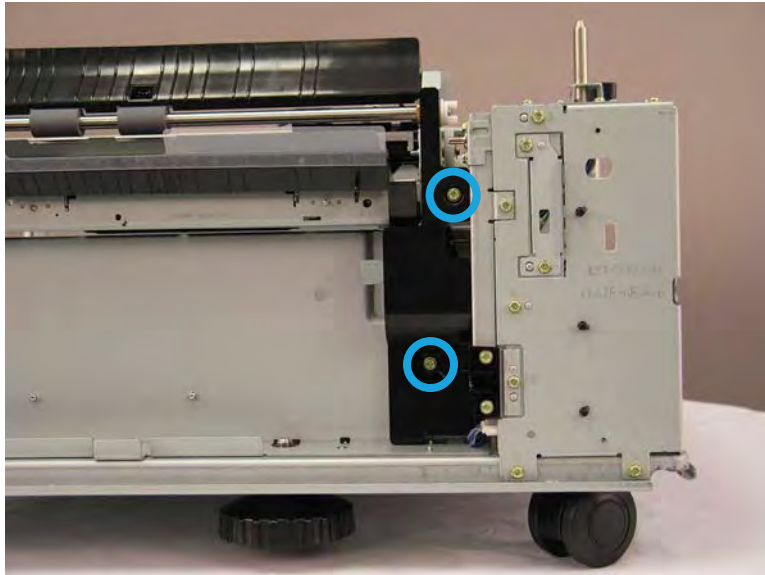


#### Remove the HCI drive assembly -sub pulley

Follow these steps to remove the Remove the HCI drive assembly -sub pulley.

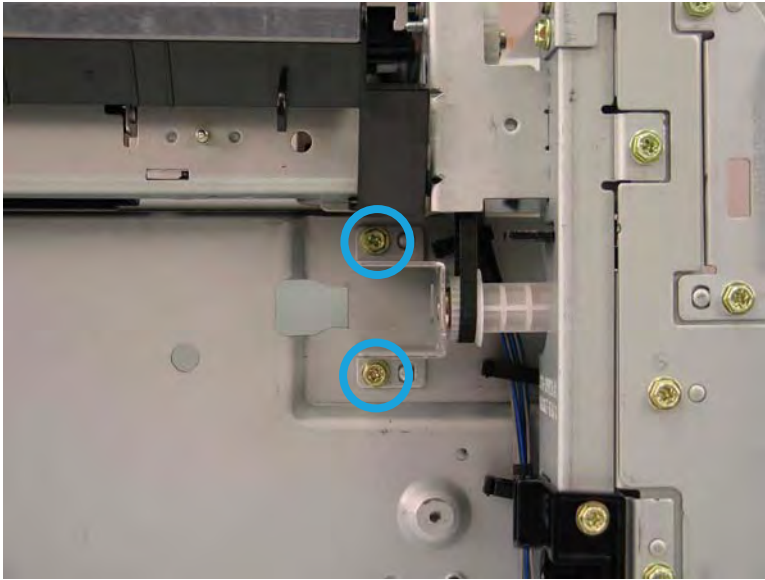
1. Remove two screws, and then remove the black-plastic cover.

Figure 2-553 Remove the cover



2. Remove two screws, and then remove the drive assembly - sub-pulley.

**Figure 2-554** Remove the HCI drive assembly - sub-pulley

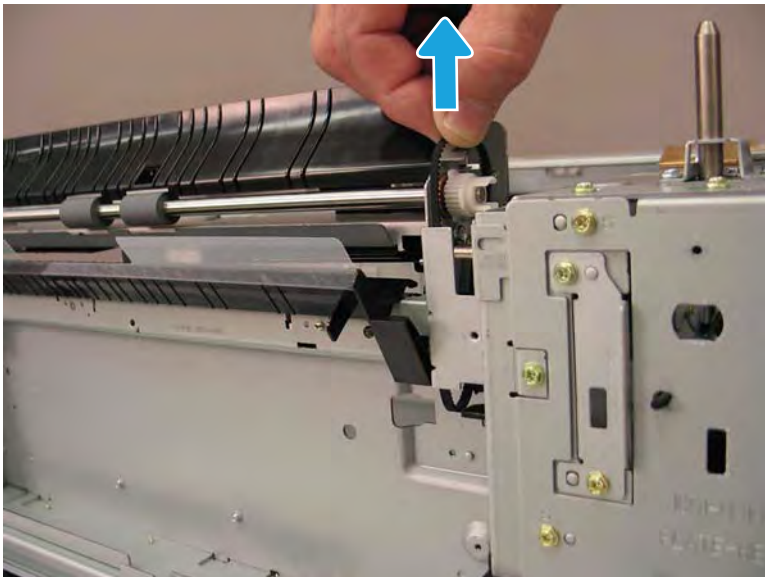


### Remove the HCI belt - timing gear

Follow these steps to remove the Remove the HCI belt - timing gear.

- ▲ Remove the belt from the drive gear, and then remove it.

**Figure 2-555** Remove the belt - timing gear

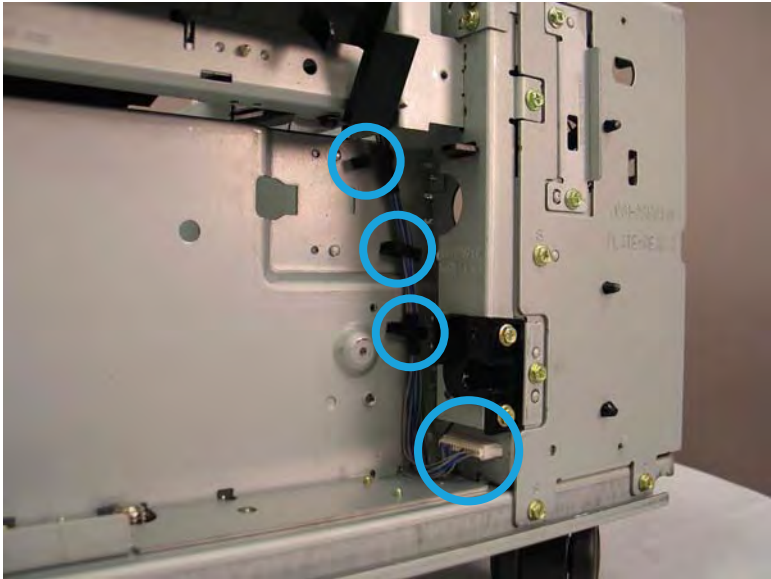


### Remove the HCI sub - pickup

Follow these steps to remove the Remove the HCI sub - pickup.

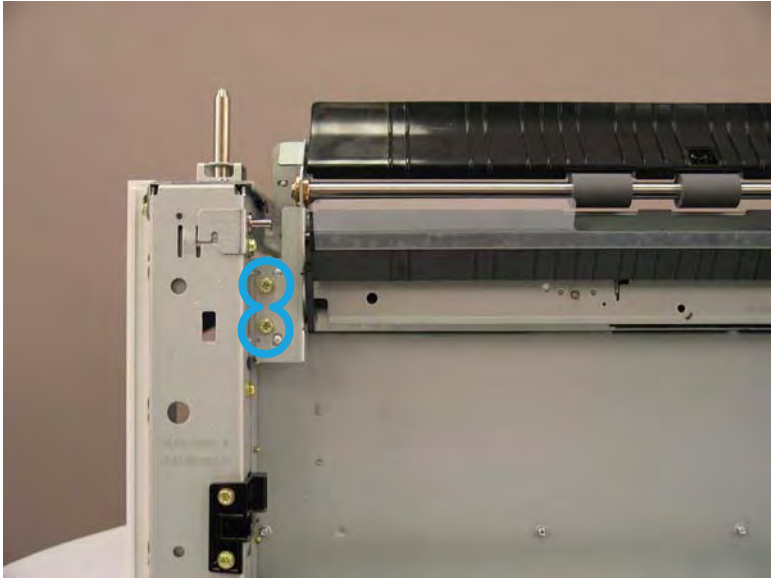
1. Disconnect one connector, and then release three retainers.

Figure 2-556 Disconnect one connector



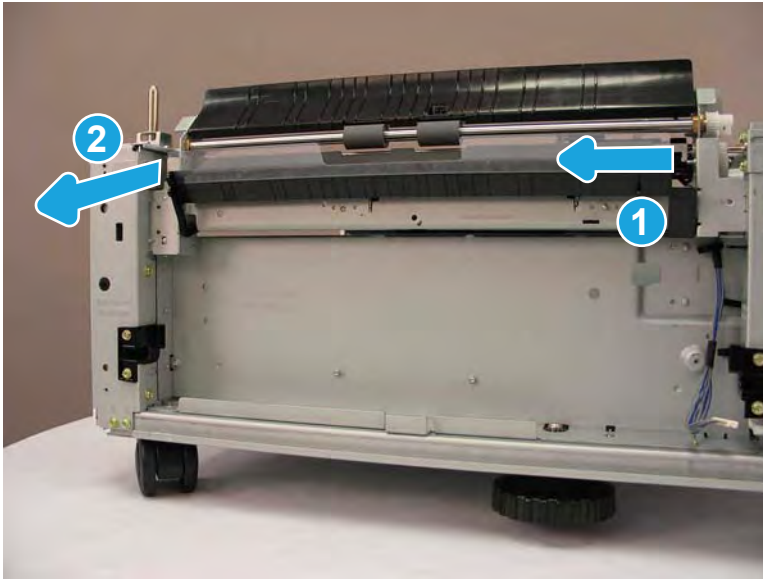
- 2. Remove two screws.

Figure 2-557 Remove two screws



3. Rotate the front end of the sub - pickup away from the HCI, and then slide it toward the front to remove it.

Figure 2-558 Remove the sub - pickup



### Unpack the replacement assembly



Follow these steps to unpack the replacement assembly.


1. Dispose of the defective part.


 **NOTE:** HP recommends responsible disposal of the defective part.

<http://www8.hp.com/us/en/hp-information/environment/product-recycling.html>


2. Unpack the replacement part from the packaging.

 **CAUTION:**  Some parts are sensitive to electrostatic discharge (ESD). Always perform service work at an ESD-protected workstation or mat. If an ESD workstation or mat is not available, touch the sheet-metal chassis to provide a static ground before touching an ESD-sensitive assembly. Protect the ESD-sensitive assemblies by placing them in ESD pouches when they are out of the printer.

 **IMPORTANT:** Make sure that all of the shipping materials (for example shipping tape) are removed from the replacement part prior to installation.

 **NOTE:** If the replacement part is a roller or pad, avoid touching the spongy part of it. Skin oils on the roller or pad can cause paper pickup and/or print-quality problems. HP recommends using disposable gloves when handling rollers or pads or washing your hands before touching rollers or pads.

3. To install an assembly, reverse the removal steps.

 **NOTE:** When applicable, special installation instructions are provided for an assembly at the end of the removal procedure. Always completely read the removal instructions and follow all special installation instructions.

## Removal and replacement: HCI right door

This document provides the procedures to remove the HCI right door.



[View a video of removing and replacing the sub-right door.](#)

Mean time to repair:

Service level:



**IMPORTANT:** When applicable, special installation instructions are provided for an assembly at the end of the removal procedure. Always completely read the removal instructions and follow all special installation instructions.

### Before performing service

- Disconnect the power cable.



**WARNING!** To avoid damage to the printer, turn the printer off, wait 30 seconds, and then remove the power cable before attempting to service the printer.

Use the table below to identify the correct part number for your printer. To order the part, go to [www.hp.com/buy/parts](http://www.hp.com/buy/parts)

**Table 2-119** Part information

Part number	Part description
JC90-01734A	HCI right door

### Required tools

- #2 JIS screwdriver with a magnetic tip

### After performing service

#### Turn the printer power on

- Connect the power cable.
- Turn on the power switch next to the power cable, and then press the power button on the front of the printer.
- Verify that the service performed was successful.
- Verify that the most recent firmware is installed on the printer.
- Verify that all parts are correctly reinstalled and are properly working.

### Post service test

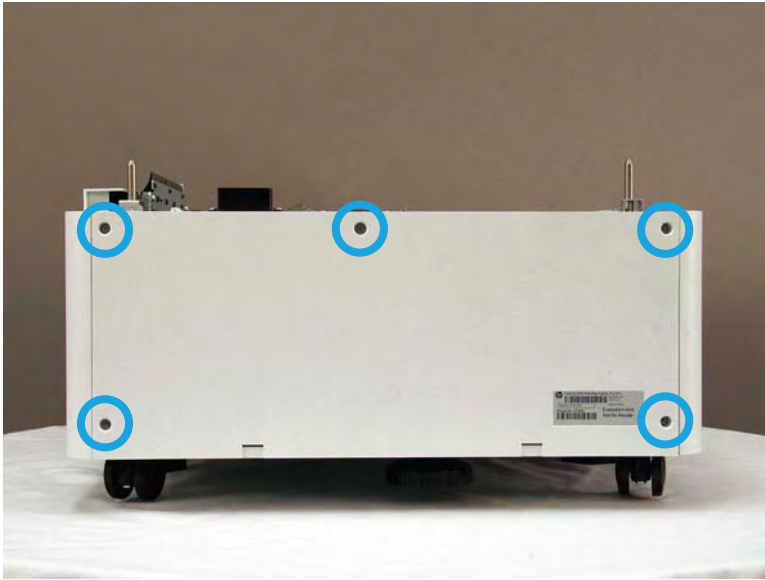
Print any pages necessary to verify that the repair resolved the issue and did not create any new issues.

### Remove the HCI rear cover

Follow these steps to remove the Remove the HCI rear cover.

- ▲ Remove five screw caps (if installed), remove five screws, and then remove the rear cover.

Figure 2-559 Remove the HCI rear cover



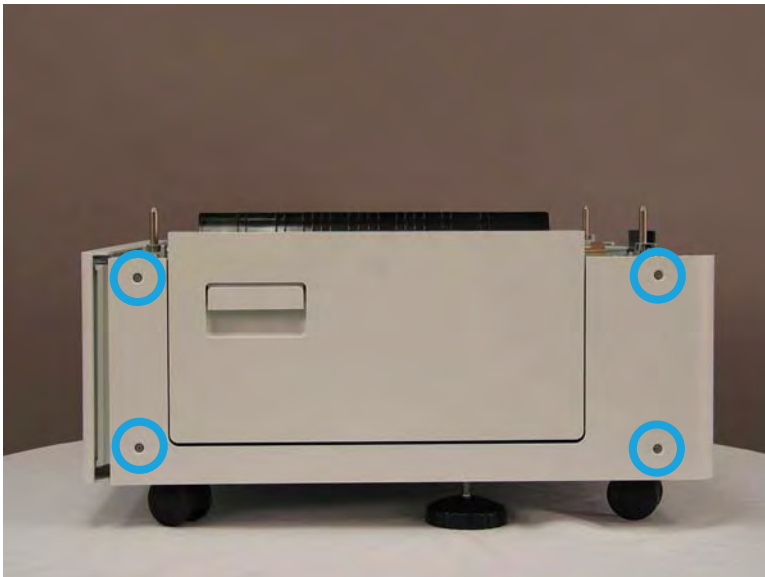
### Remove the HCI right door

Follow these steps to remove the Remove the HCI right door.

1. Remove four screw caps (if installed), and then remove four screws.

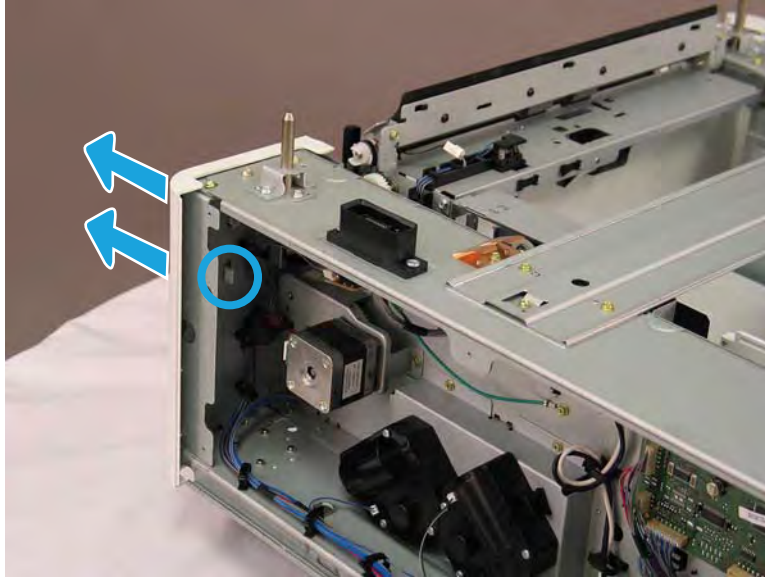
 **NOTE:** If the feed drive assembly is removed, there are only two screws that secure this cover.

Figure 2-560 Remove four screws



2. Release one tab, and then separate the rear edge of the right cover from the chassis.

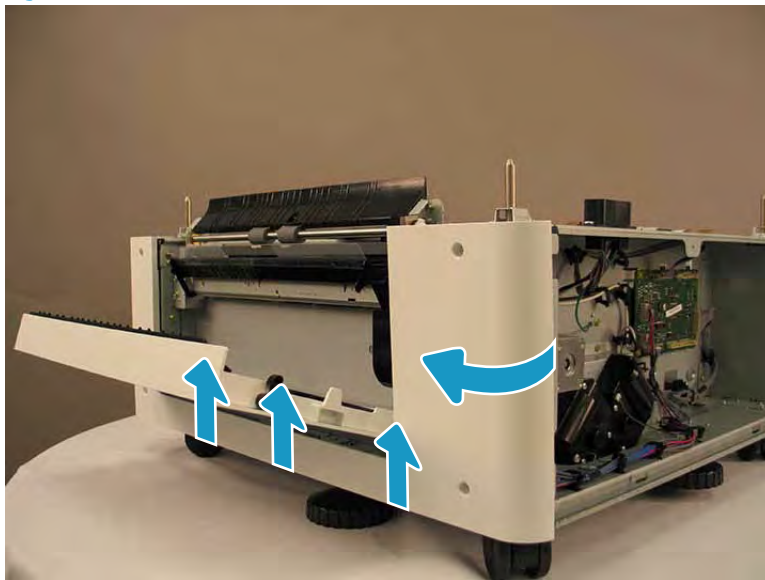
**Figure 2-561** Separate the rear edge of the right cover from the chassis



3. Lift up on the cover while rotating it away from the chassis to release three bosses.

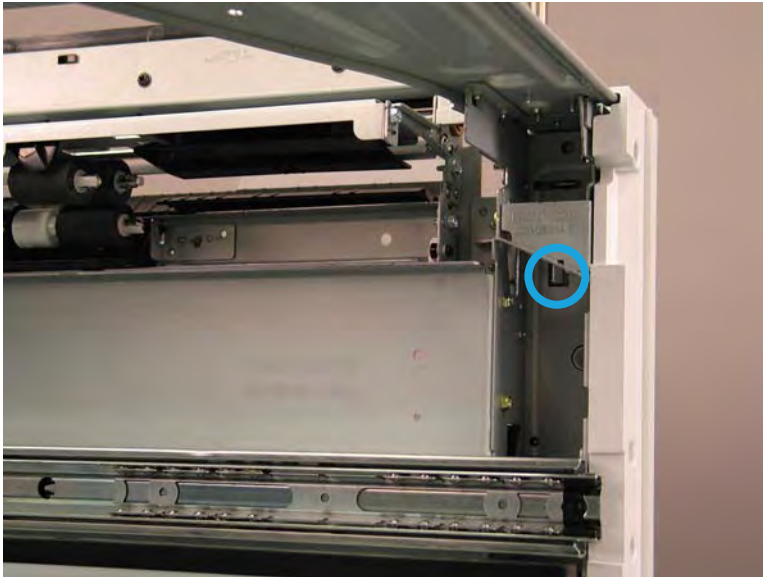
**⚠ CAUTION:** Do not attempt to fully remove the cover. Stop as shown below. Fully removing the cover at this step will damage the remaining tab and boss on the cover

**Figure 2-562** Release three bosses



4. If the tray was not removed prior to servicing the HCI, remove it now. Look in the tray cavity and locate the right cover front tab. Release this tab.

Figure 2-563 Release one tab



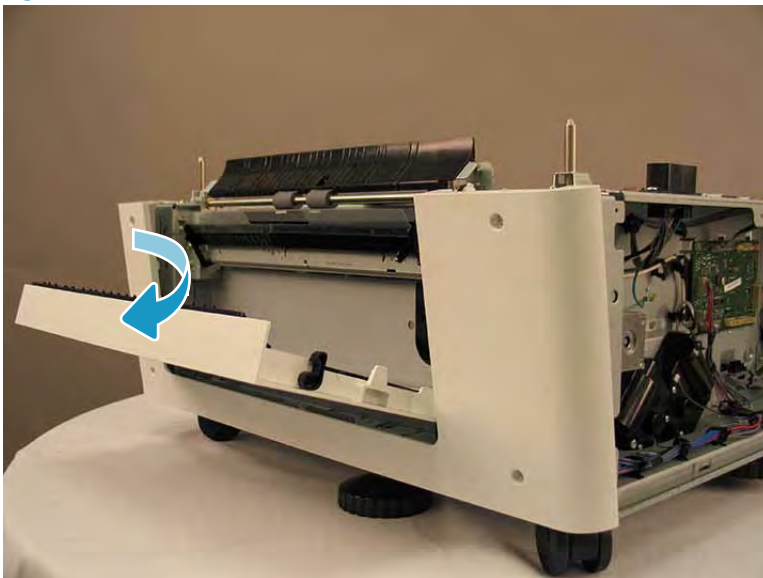
5. Remove the HCI right cover.

---

 **NOTE:** The HCI right door will not stay in the latched position when this cover is removed.

---

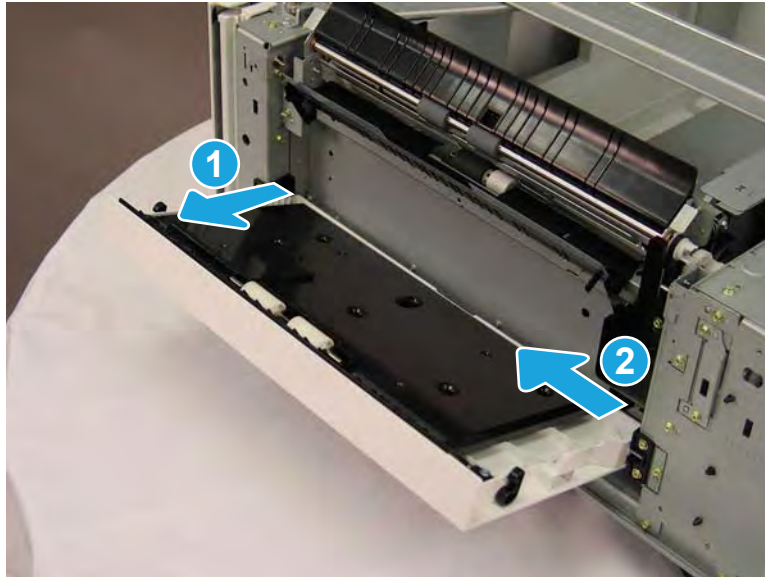
Figure 2-564 Remove the HCI right cover





6. Rotate the right door front hinge pin out of the holder, and then slide the right door towards the front of the HCI to release the rear hinge pin and remove the door.

**Figure 2-565** Remove the HCI right door



### Unpack the replacement assembly

Follow these steps to unpack the replacement assembly.

1. Dispose of the defective part.

---



 **NOTE:** HP recommends responsible disposal of the defective part.

<http://www8.hp.com/us/en/hp-information/environment/product-recycling.html>


---

2. Unpack the replacement part from the packaging.

---

 **CAUTION:**  Some parts are sensitive to electrostatic discharge (ESD). Always perform service work at an ESD-protected workstation or mat. If an ESD workstation or mat is not available, touch the sheet-metal chassis to provide a static ground before touching an ESD-sensitive assembly. Protect the ESD-sensitive assemblies by placing them in ESD pouches when they are out of the printer.


 **IMPORTANT:** Make sure that all of the shipping materials (for example shipping tape) are removed from the replacement part prior to installation.

 **NOTE:** If the replacement part is a roller or pad, avoid touching the spongy part of it. Skin oils on the roller or pad can cause paper pickup and/or print-quality problems. HP recommends using disposable gloves when handling rollers or pads or washing your hands before touching rollers or pads.

---

3. To install an assembly, reverse the removal steps.

---

 **NOTE:** When applicable, special installation instructions are provided for an assembly at the end of the removal procedure. Always completely read the removal instructions and follow all special installation instructions.

---

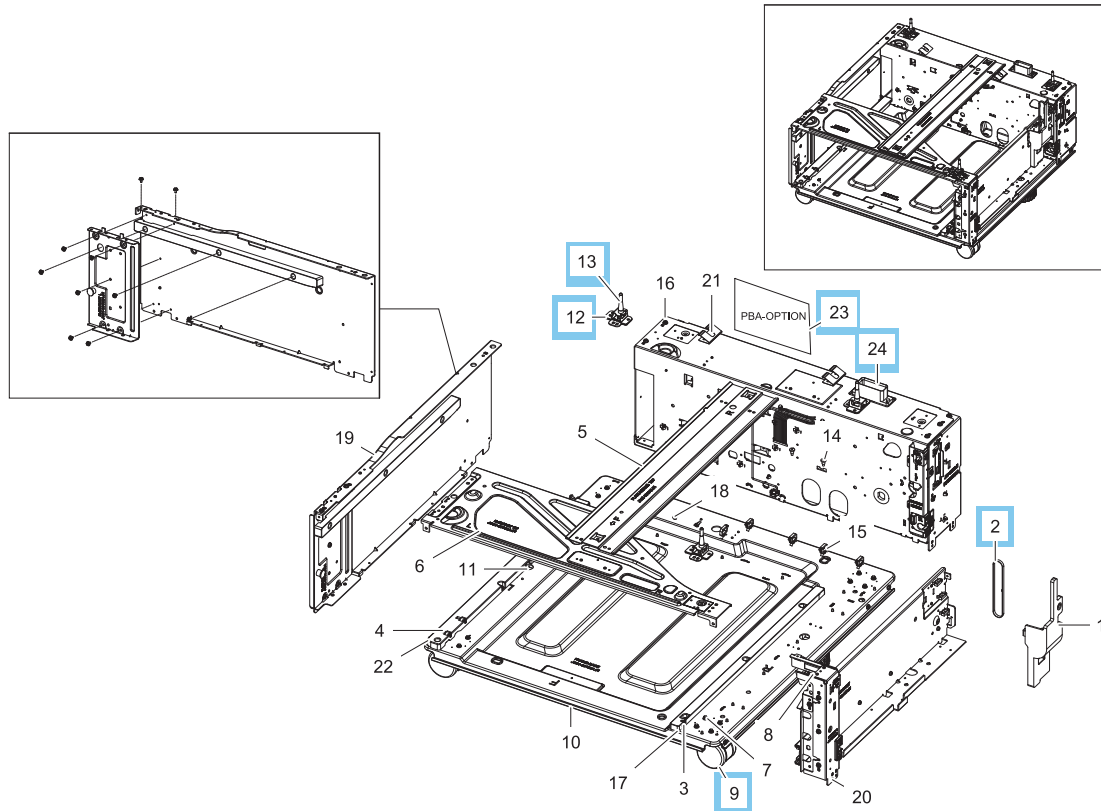
## HCI sub - frame

View the HCI sub - frame exploded view, parts list, and repair procedures.

## HCI sub - frame

Parts diagram and parts list for the HCI sub - frame.

Figure 2-566 HCI sub - frame



**Table 2-120 HCI sub - frame**

Ref				
No	Part number	Description	Qty	Repair procedure
2	6602-003185	Belt timing gear (HCI)	1	<a href="#">Removal and replacement: HCI belt - timing gear on page 694</a>
9	6109-001138	Caster wheel (HCI)	4	<a href="#">Removal and replacement: HCI caster wheel on page 709</a>
12	JC61-04660A	Plate guide post upper (HCI)	3	<a href="#">Removal and replacement: HCI guide post and guide post plate on page 711</a>
13	JC61-04659A	Plate guide post (HCI)	3	<a href="#">Removal and replacement: HCI guide post and guide post plate on page 711</a>
23	JC92-02738G	Printed circuit assembly (HCI)	1	<a href="#">Removal and replacement: HCI PCA on page 703</a>
24	JC39-02600A	Main electrical connector (HCI)	3	<a href="#">Removal and replacement: HCI main electrical connector on page 706</a>


## Removal and replacement: HCI belt - timing gear

This document provides the procedures to remove the HCI belt - timing gear.

 [View a video of removing and replacing the belt - timing gear.](#)


Mean time to repair:

Service level:

 **IMPORTANT:** When applicable, special installation instructions are provided for an assembly at the end of the removal procedure. Always completely read the removal instructions and follow all special installation instructions.

### Before performing service

- Disconnect the power cable.

 **WARNING!** To avoid damage to the printer, turn the printer off, wait 30 seconds, and then remove the power cable before attempting to service the printer.

Use the table below to identify the correct part number for your printer. To order the part, go to [www.hp.com/buy/parts](http://www.hp.com/buy/parts)

Table 2-121 Part information

Part number	Part description
6602-003185	HCI belt - timing gear

### Required tools

- #2 JIS screwdriver with a magnetic tip

### After performing service

#### Turn the printer power on

- Connect the power cable.
- Turn on the power switch next to the power cable, and then press the power button on the front of the printer.
- Verify that the service performed was successful.
- Verify that the most recent firmware is installed on the printer.
- Verify that all parts are correctly reinstalled and are properly working.

### Post service test

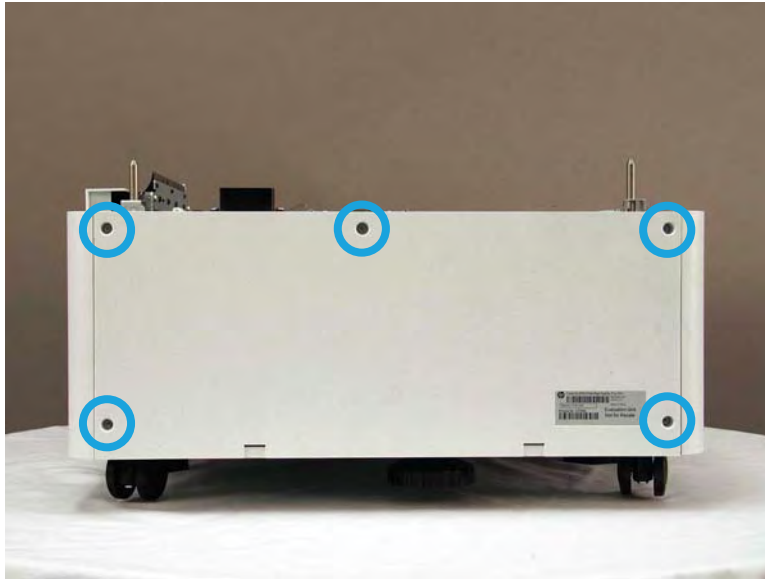
Print any pages necessary to verify that the repair resolved the issue and did not create any new issues.

### Remove the HCI rear cover

Follow these steps to remove the Remove the HCI rear cover.

- ▲ Remove five screw caps (if installed), remove five screws, and then remove the rear cover.

Figure 2-567 Remove the HCI rear cover

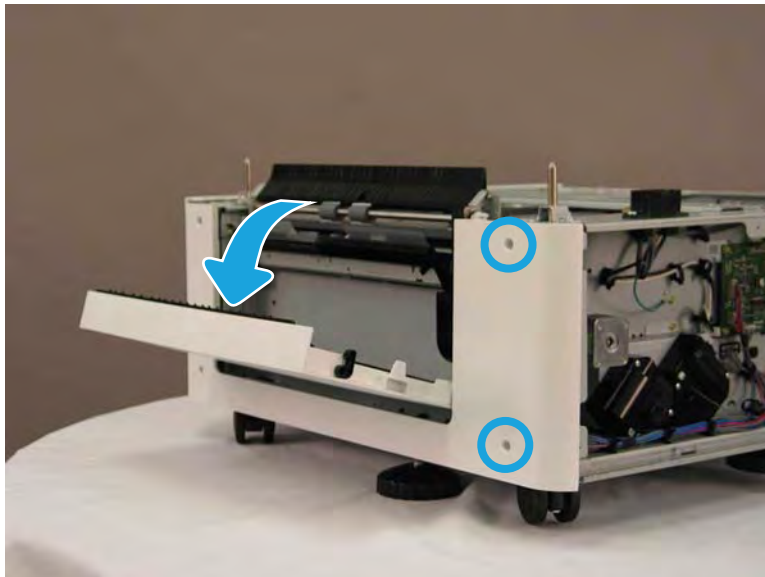


#### Remove the HCI drive assembly - feed

Follow these steps to remove the Remove the HCI drive assembly - feed.

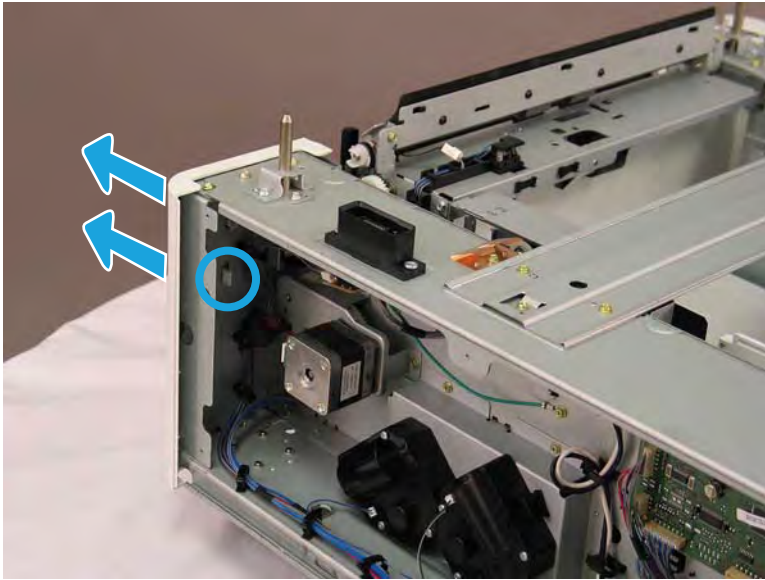
1. Open the right door, and then remove two screws.

Figure 2-568 Remove two screws



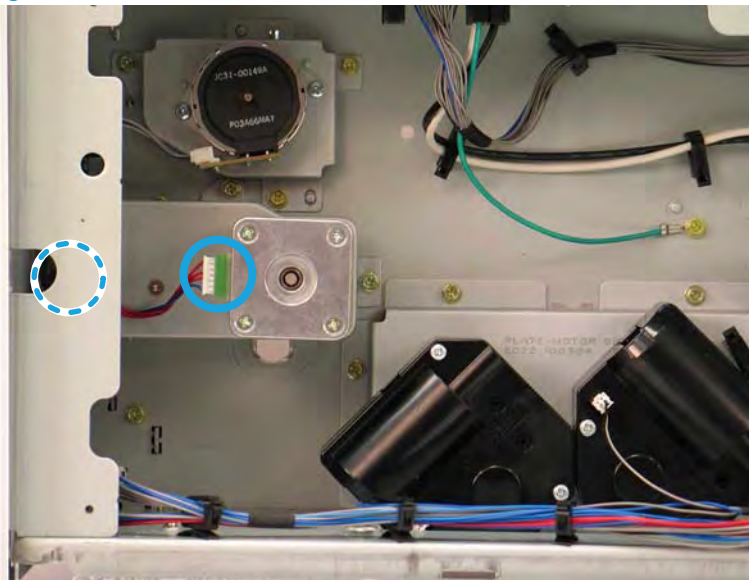
2. Release one tab, and then separate the rear edge of the right cover from the chassis.

**Figure 2-569** Separate the rear edge of the right cover from the chassis



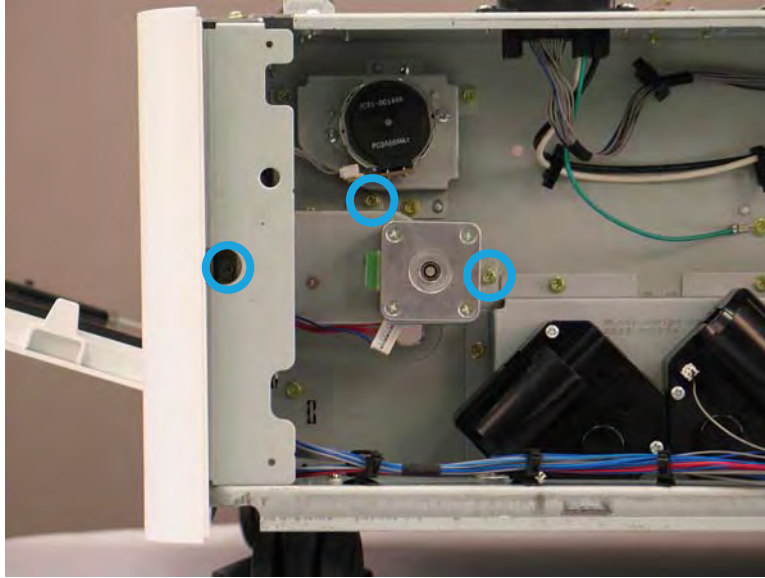
3. Disconnect one connector, and then release the wire harness from the retainer.

**Figure 2-570** Disconnect one connector



4. Remove three screws, and then remove the HCI drive assembly - feed.

Figure 2-571 Remove the HCI drive assembly - feed



#### Remove the HCI right door

Follow these steps to remove the Remove the HCI right door.

1. Remove four screw caps (if installed), and then remove four screws.


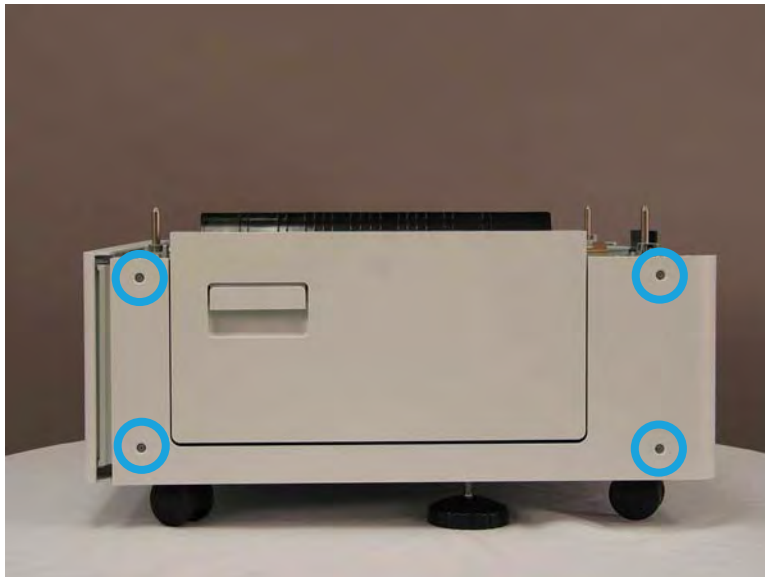
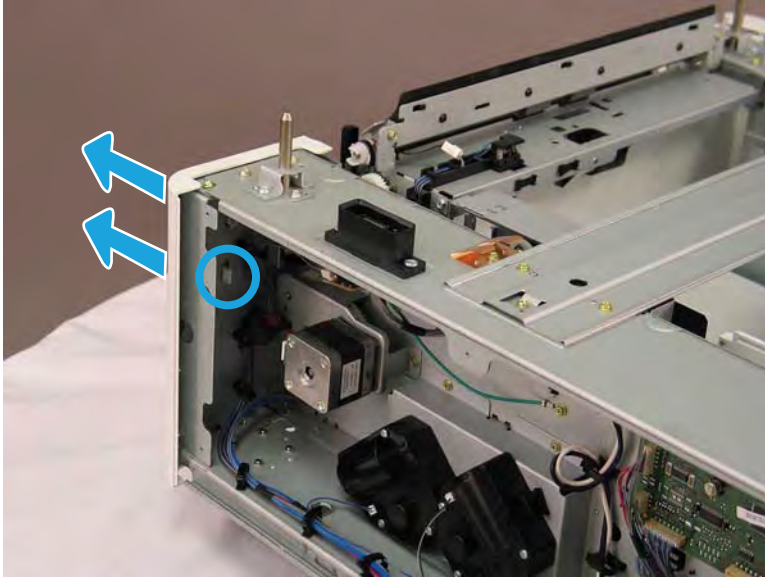
 **NOTE:** If the feed drive assembly is removed, there are only two screws that secure this cover.

Figure 2-572 Remove four screws



2. Release one tab, and then separate the rear edge of the right cover from the chassis.

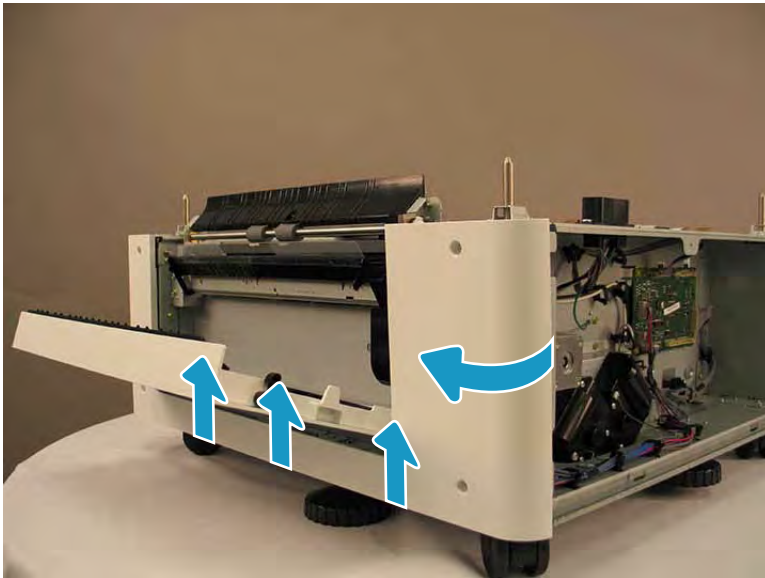
**Figure 2-573** Separate the rear edge of the right cover from the chassis



3. Lift up on the cover while rotating it away from the chassis to release three bosses.

**CAUTION:** Do not attempt to fully remove the cover. Stop as shown below. Fully removing the cover at this step will damage the remaining tab and boss on the cover

**Figure 2-574** Release three bosses





4. If the tray was not removed prior to servicing the HCI, remove it now. Look in the tray cavity and locate the right cover front tab. Release this tab.

Figure 2-575 Release one tab



5. Remove the HCI right cover.


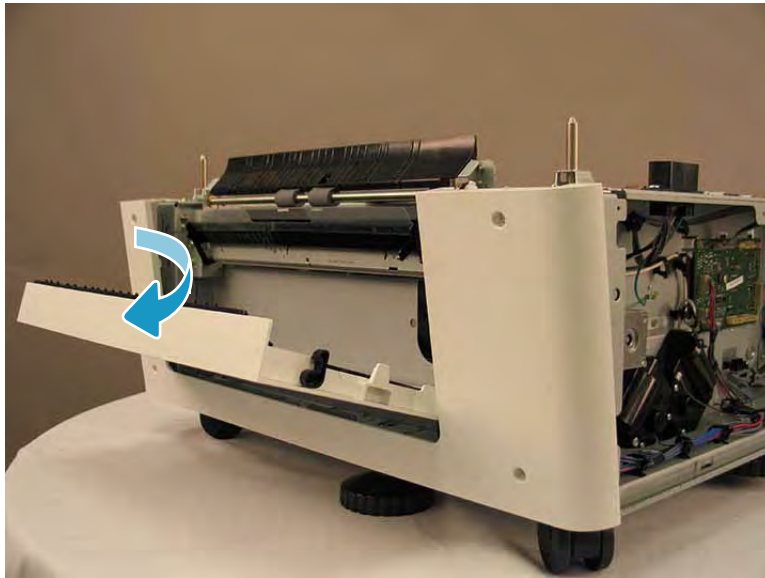
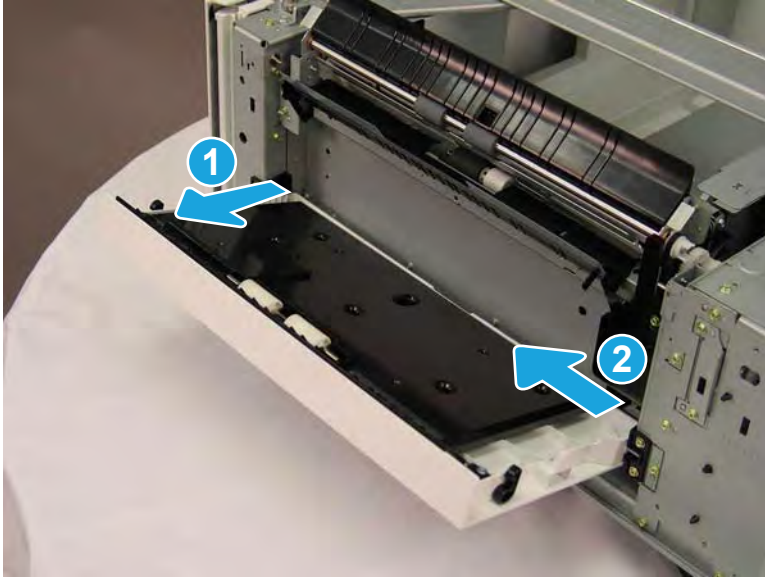
 **NOTE:** The HCI right door will not stay in the latched position when this cover is removed.

Figure 2-576 Remove the HCI right cover



6. Rotate the right door front hinge pin out of the holder, and then slide the right door towards the front of the HCI to release the rear hinge pin and remove the door.

Figure 2-577 Remove the HCI right door

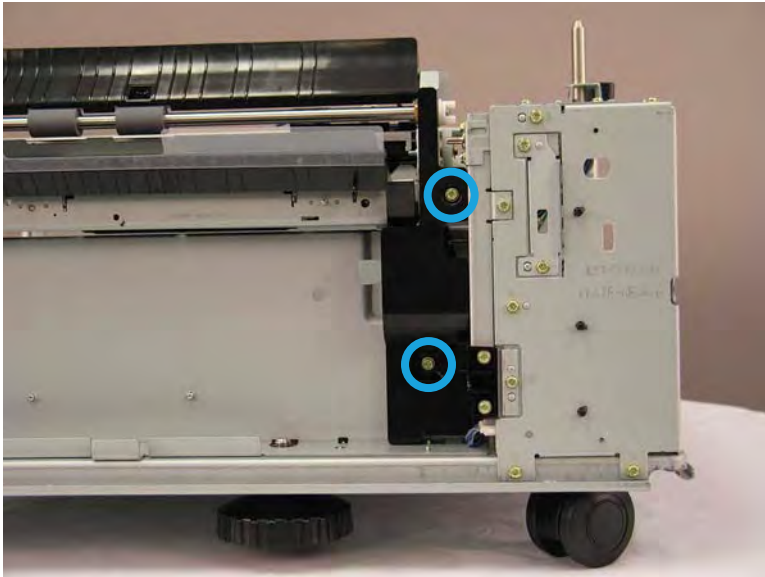


#### Remove the HCI drive assembly -sub pulley

Follow these steps to remove the Remove the HCI drive assembly -sub pulley.

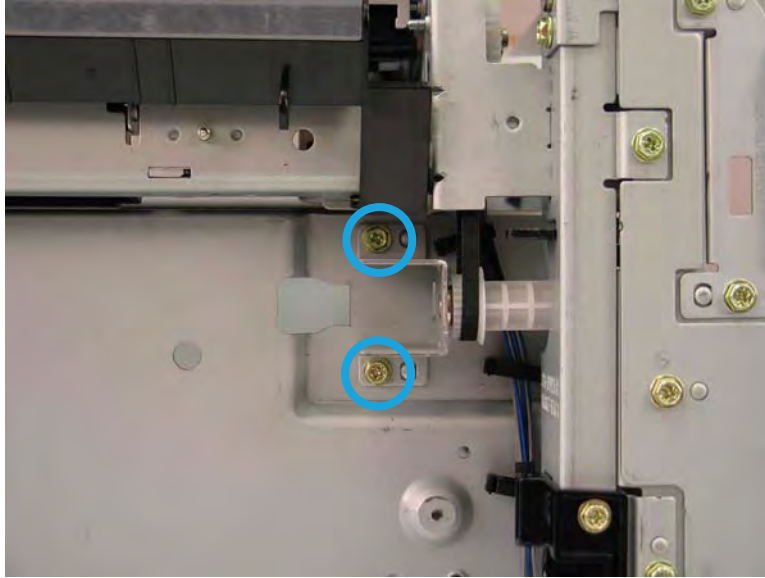
1. Remove two screws, and then remove the black-plastic cover.

Figure 2-578 Remove the cover



2. Remove two screws, and then remove the drive assembly - sub-pulley.

**Figure 2-579** Remove the HCI drive assembly - sub-pulley

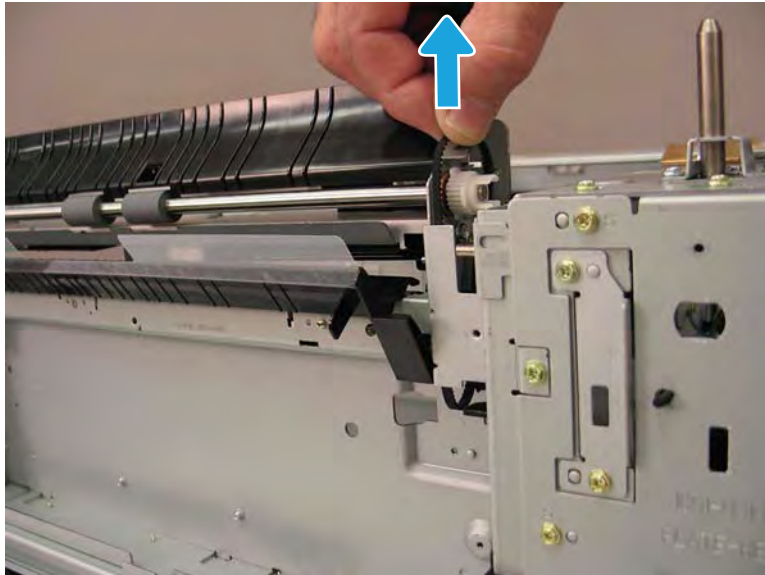


### Remove the HCI belt - timing gear

Follow these steps to remove the Remove the HCI belt - timing gear.

- ▲ Remove the belt from the drive gear, and then remove it.

**Figure 2-580** Remove the belt - timing gear



### Unpack the replacement assembly

Follow these steps to unpack the replacement assembly.

1. Dispose of the defective part.



---


 **NOTE:** HP recommends responsible disposal of the defective part.


<http://www8.hp.com/us/en/hp-information/environment/product-recycling.html>

---

2. Unpack the replacement part from the packaging.


 **CAUTION:**  Some parts are sensitive to electrostatic discharge (ESD). Always perform service work at an ESD-protected workstation or mat. If an ESD workstation or mat is not available, touch the sheet-metal chassis to provide a static ground before touching an ESD-sensitive assembly. Protect the ESD-sensitive assemblies by placing them in ESD pouches when they are out of the printer.

 **IMPORTANT:** Make sure that all of the shipping materials (for example shipping tape) are removed from the replacement part prior to installation.

 **NOTE:** If the replacement part is a roller or pad, avoid touching the spongy part of it. Skin oils on the roller or pad can cause paper pickup and/or print-quality problems. HP recommends using disposable gloves when handling rollers or pads or washing your hands before touching rollers or pads.

---

3. To install an assembly, reverse the removal steps.

 **NOTE:** When applicable, special installation instructions are provided for an assembly at the end of the removal procedure. Always completely read the removal instructions and follow all special installation instructions.

---


## Removal and replacement: HCI PCA

This document provides the procedures to remove the HCI PCA.




Mean time to repair:

Service level:

 **IMPORTANT:** When applicable, special installation instructions are provided for an assembly at the end of the removal procedure. Always completely read the removal instructions and follow all special installation instructions.

### Before performing service

- Disconnect the power cable.

 **WARNING!** To avoid damage to the printer, turn the printer off, wait 30 seconds, and then remove the power cable before attempting to service the printer.

Use the table below to identify the correct part number for your printer. To order the part, go to [www.hp.com/buy/parts](http://www.hp.com/buy/parts)

**Table 2-122 Part information**

Part number	Part description
JC92-02738G	HCI PCA

### Required tools

- #2 JIS screwdriver with a magnetic tip

### After performing service

#### Turn the printer power on

- Connect the power cable.
- Turn on the power switch next to the power cable, and then press the power button on the front of the printer.
- Verify that the service performed was successful.
- Verify that the most recent firmware is installed on the printer.
- Verify that all parts are correctly reinstalled and are properly working.

### Post service test

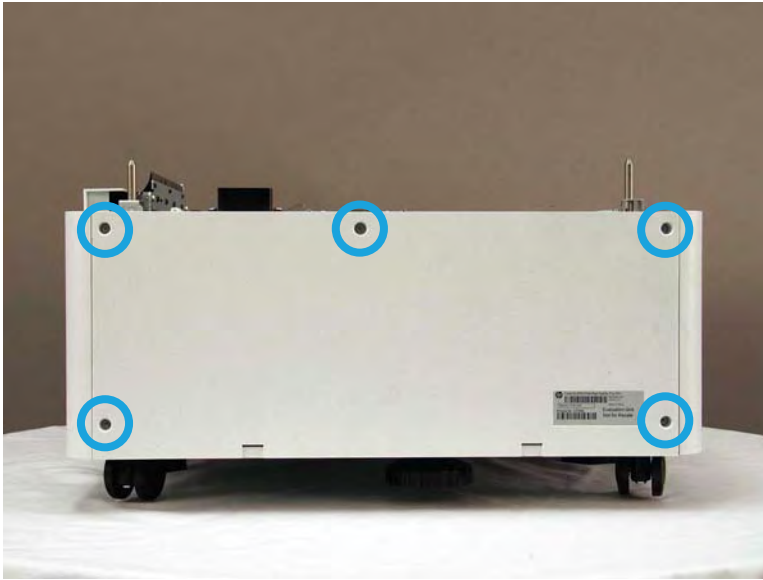
Print any pages necessary to verify that the repair resolved the issue and did not create any new issues.

### Remove the HCI rear cover

Follow these steps to remove the Remove the HCI rear cover.

- ▲ Remove five screw caps (if installed), remove five screws, and then remove the rear cover.

Figure 2-581 Remove the HCI rear cover

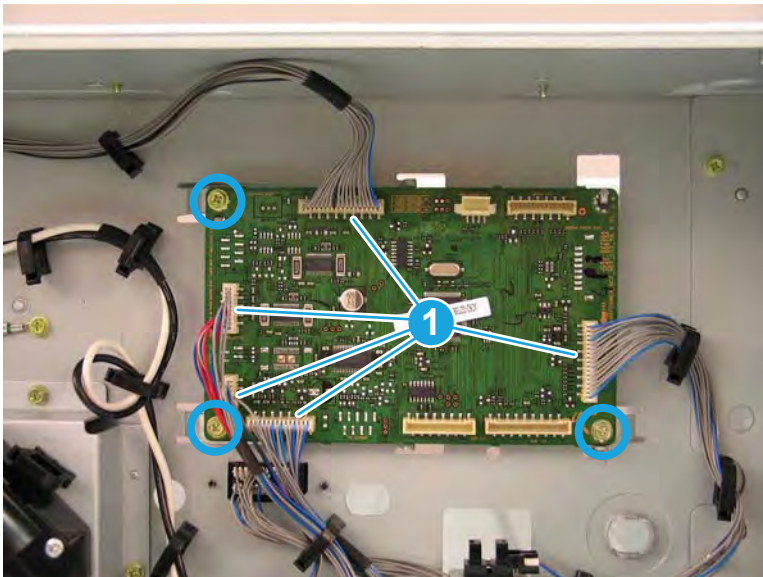


### Remove the HCI PCA

Follow these steps to remove the HCI PCA.

- ▲ Disconnect five connectors (callout 1), remove three screws, and then remove the HCI PCA.

Figure 2-582 Remove the HCI PCA



### Unpack the replacement assembly

Follow these steps to unpack the replacement assembly.

1. Dispose of the defective part.



---


 **NOTE:** HP recommends responsible disposal of the defective part.


<http://www8.hp.com/us/en/hp-information/environment/product-recycling.html>

---

2. Unpack the replacement part from the packaging.


 **CAUTION:**  Some parts are sensitive to electrostatic discharge (ESD). Always perform service work at an ESD-protected workstation or mat. If an ESD workstation or mat is not available, touch the sheet-metal chassis to provide a static ground before touching an ESD-sensitive assembly. Protect the ESD-sensitive assemblies by placing them in ESD pouches when they are out of the printer.

 **IMPORTANT:** Make sure that all of the shipping materials (for example shipping tape) are removed from the replacement part prior to installation.

 **NOTE:** If the replacement part is a roller or pad, avoid touching the spongy part of it. Skin oils on the roller or pad can cause paper pickup and/or print-quality problems. HP recommends using disposable gloves when handling rollers or pads or washing your hands before touching rollers or pads.

---

3. To install an assembly, reverse the removal steps.

 **NOTE:** When applicable, special installation instructions are provided for an assembly at the end of the removal procedure. Always completely read the removal instructions and follow all special installation instructions.

---


## Removal and replacement: HCl main electrical connector

This document provides the procedures to remove the HCl main electrical connector.

 [View a video of removing and replacing the main electrical connector.](#)


Mean time to repair:

Service level:

 **IMPORTANT:** When applicable, special installation instructions are provided for an assembly at the end of the removal procedure. Always completely read the removal instructions and follow all special installation instructions.

### Before performing service

- Disconnect the power cable.

 **WARNING!** To avoid damage to the printer, turn the printer off, wait 30 seconds, and then remove the power cable before attempting to service the printer.

Use the table below to identify the correct part number for your printer. To order the part, go to [www.hp.com/buy/parts](http://www.hp.com/buy/parts)

Table 2-123 Part information

Part number	Part description
JC39-02600A	HCl main electrical connector

### Required tools

- #2 JIS screwdriver with a magnetic tip

### After performing service

#### Turn the printer power on

- Connect the power cable.
- Turn on the power switch next to the power cable, and then press the power button on the front of the printer.
- Verify that the service performed was successful.
- Verify that the most recent firmware is installed on the printer.
- Verify that all parts are correctly reinstalled and are properly working.

### Post service test

Print any pages necessary to verify that the repair resolved the issue and did not create any new issues.

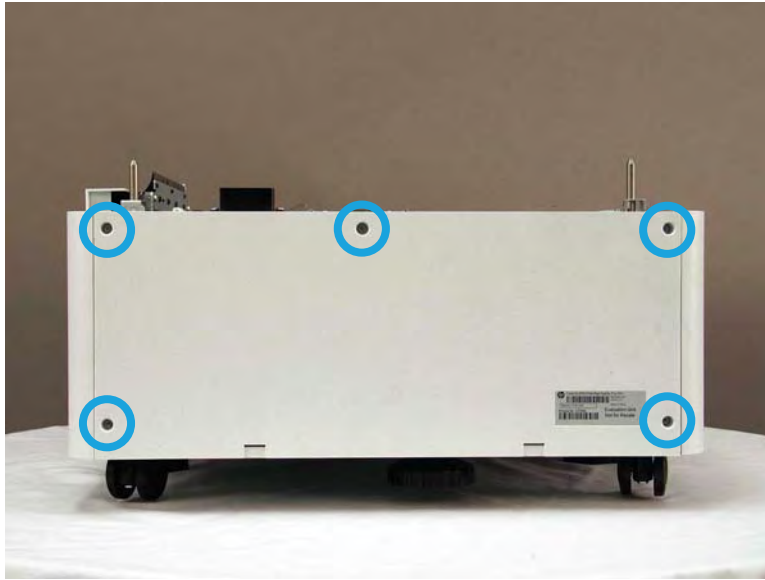
### Remove the HCl rear cover

Follow these steps to remove the Remove the HCl rear cover.



- ▲ Remove five screw caps (if installed), remove five screws, and then remove the rear cover.

Figure 2-583 Remove the HCI rear cover

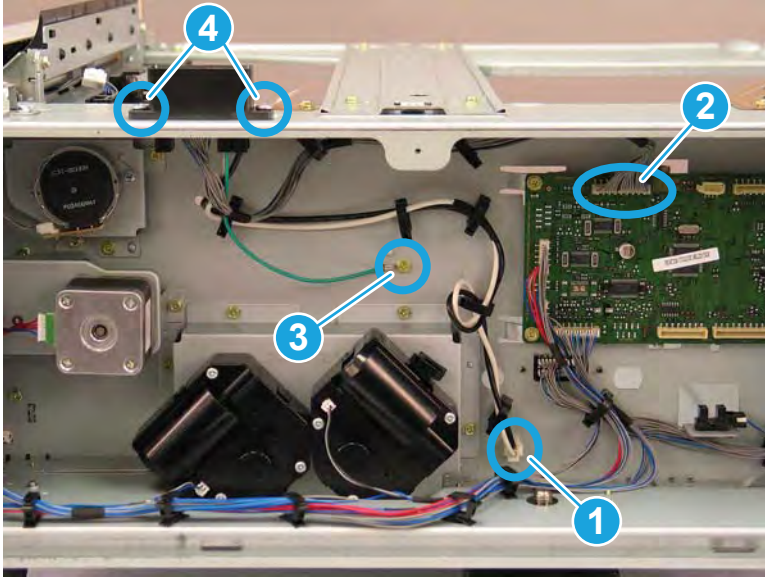


### Remove the main electrical connector

Follow these steps to remove the HCI main electrical connector.

- ▲ Do the following:
  1. Squeeze two tabs and release one connector (callout 1; black and white wire harness) from the chassis, and then release five retainers.
  2. Disconnect one connector (callout 2; on the HCI PCA), and then release two retainers.
  3. Remove one ground screw (callout 3; green wire).
  4. Remove two shoulder screws (callout 4; main electrical connector), and then remove the main connector.

Figure 2-584 Remove the HCI main electrical connector



### Unpack the replacement assembly



Follow these steps to unpack the replacement assembly.

1. Dispose of the defective part.


 **NOTE:** HP recommends responsible disposal of the defective part.

<http://www8.hp.com/us/en/hp-information/environment/product-recycling.html>


2. Unpack the replacement part from the packaging.

 **CAUTION:**  Some parts are sensitive to electrostatic discharge (ESD). Always perform service work at an ESD-protected workstation or mat. If an ESD workstation or mat is not available, touch the sheet-metal chassis to provide a static ground before touching an ESD-sensitive assembly. Protect the ESD-sensitive assemblies by placing them in ESD pouches when they are out of the printer.

 **IMPORTANT:** Make sure that all of the shipping materials (for example shipping tape) are removed from the replacement part prior to installation.

 **NOTE:** If the replacement part is a roller or pad, avoid touching the spongy part of it. Skin oils on the roller or pad can cause paper pickup and/or print-quality problems. HP recommends using disposable gloves when handling rollers or pads or washing your hands before touching rollers or pads.

3. To install an assembly, reverse the removal steps.

 **NOTE:** When applicable, special installation instructions are provided for an assembly at the end of the removal procedure. Always completely read the removal instructions and follow all special installation instructions.


## Removal and replacement: HCI caster wheel

This document provides the procedures to remove the HCI caster.




Mean time to repair:

Service level:

 **IMPORTANT:** When applicable, special installation instructions are provided for an assembly at the end of the removal procedure. Always completely read the removal instructions and follow all special installation instructions.

### Before performing service

- Disconnect the power cable.

 **WARNING!** To avoid damage to the printer, turn the printer off, wait 30 seconds, and then remove the power cable before attempting to service the printer.

Use the table below to identify the correct part number for your printer. To order the part, go to [www.hp.com/buy/parts](http://www.hp.com/buy/parts)

**Table 2-124 Part information**

Part number	Part description
6109-001138	HCI caster wheel

### Required tools

- #2 JIS screwdriver with a magnetic tip

### After performing service

#### Turn the printer power on

- Connect the power cable.
- Turn on the power switch next to the power cable, and then press the power button on the front of the printer.
- Verify that the service performed was successful.
- Verify that the most recent firmware is installed on the printer.
- Verify that all parts are correctly reinstalled and are properly working.

### Post service test

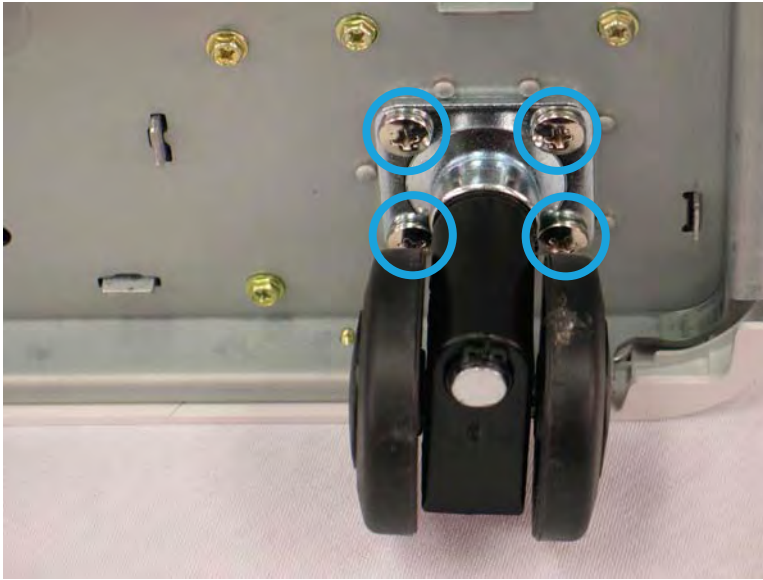
Print any pages necessary to verify that the repair resolved the issue and did not create any new issues.

### Remove the HCI caster wheel

Follow these steps to remove the HCI caster.

- ▲ Carefully position the HCI on its side, remove four screws, and then remove the HCI caster wheel.

Figure 2-585 Remove the HCI caster wheel



### Unpack the replacement assembly



Follow these steps to unpack the replacement assembly.


1. Dispose of the defective part.


 **NOTE:** HP recommends responsible disposal of the defective part.

<http://www8.hp.com/us/en/hp-information/environment/product-recycling.html>


2. Unpack the replacement part from the packaging.

 **CAUTION:**  Some parts are sensitive to electrostatic discharge (ESD). Always perform service work at an ESD-protected workstation or mat. If an ESD workstation or mat is not available, touch the sheet-metal chassis to provide a static ground before touching an ESD-sensitive assembly. Protect the ESD-sensitive assemblies by placing them in ESD pouches when they are out of the printer.

 **IMPORTANT:** Make sure that all of the shipping materials (for example shipping tape) are removed from the replacement part prior to installation.

 **NOTE:** If the replacement part is a roller or pad, avoid touching the spongy part of it. Skin oils on the roller or pad can cause paper pickup and/or print-quality problems. HP recommends using disposable gloves when handling rollers or pads or washing your hands before touching rollers or pads.

3. To install an assembly, reverse the removal steps.

 **NOTE:** When applicable, special installation instructions are provided for an assembly at the end of the removal procedure. Always completely read the removal instructions and follow all special installation instructions.

## Removal and replacement: HCI guide post and guide post plate

This document provides the procedures to remove the HCI guide post and guide post plate.



[View a video of removing and replacing the guide post and guide post plate.](#)

Mean time to repair:

Service level:



**IMPORTANT:** When applicable, special installation instructions are provided for an assembly at the end of the removal procedure. Always completely read the removal instructions and follow all special installation instructions.

### Before performing service

- Disconnect the power cable.



**WARNING!** To avoid damage to the printer, turn the printer off, wait 30 seconds, and then remove the power cable before attempting to service the printer.

Use the table below to identify the correct part number for your printer. To order the part, go to [www.hp.com/buy/parts](http://www.hp.com/buy/parts)

**Table 2-125 Part information**

Part number	Part description
JC61-04660A	HCI guide post
JC61-04659A	HCI guide post plate

### Required tools

- #2 JIS screwdriver with a magnetic tip

### After performing service

#### Turn the printer power on

- Connect the power cable.
- Turn on the power switch next to the power cable, and then press the power button on the front of the printer.
- Verify that the service performed was successful.
- Verify that the most recent firmware is installed on the printer.
- Verify that all parts are correctly reinstalled and are properly working.

### Post service test

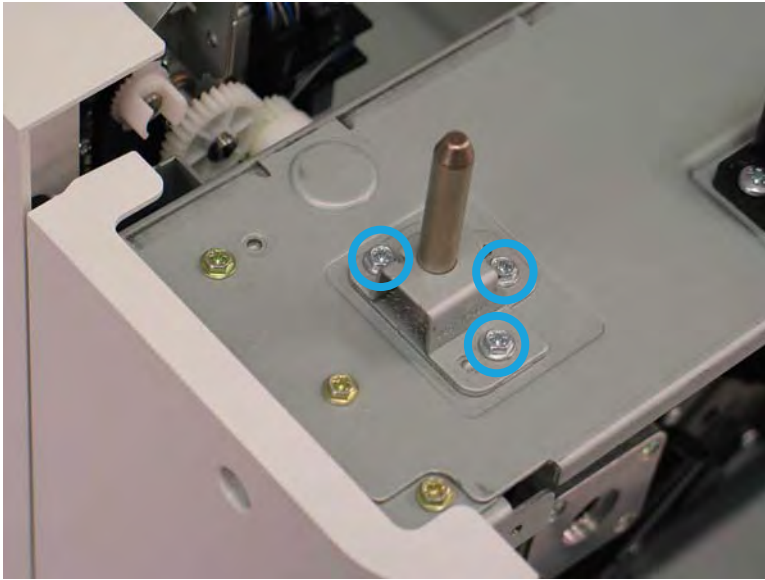
Print any pages necessary to verify that the repair resolved the issue and did not create any new issues.

### Remove the HCI guide post upper and guide post plates

Follow these steps to remove the HCI guide post upper and guide post plates.

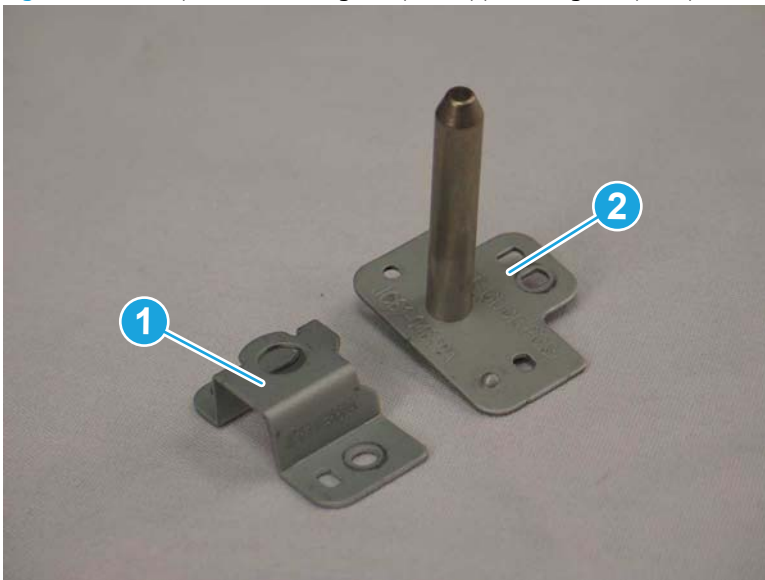
1. Remove four screws, and then remove the HCI guide post upper and guide post plates.

**Figure 2-586** Remove the HCI guide post upper and guide post plates



2. Separate the guide post upper (callout 1) and guide post (callout 2) plates.

**Figure 2-587** Separate the HCI guide post upper and guide post plates



### Unpack the replacement assembly

Follow these steps to unpack the replacement assembly.

1. Dispose of the defective part.



---


 **NOTE:** HP recommends responsible disposal of the defective part.


<http://www8.hp.com/us/en/hp-information/environment/product-recycling.html>

---

2. Unpack the replacement part from the packaging.


 **CAUTION:**  Some parts are sensitive to electrostatic discharge (ESD). Always perform service work at an ESD-protected workstation or mat. If an ESD workstation or mat is not available, touch the sheet-metal chassis to provide a static ground before touching an ESD-sensitive assembly. Protect the ESD-sensitive assemblies by placing them in ESD pouches when they are out of the printer.

 **IMPORTANT:** Make sure that all of the shipping materials (for example shipping tape) are removed from the replacement part prior to installation.

 **NOTE:** If the replacement part is a roller or pad, avoid touching the spongy part of it. Skin oils on the roller or pad can cause paper pickup and/or print-quality problems. HP recommends using disposable gloves when handling rollers or pads or washing your hands before touching rollers or pads.

---

3. To install an assembly, reverse the removal steps.

 **NOTE:** When applicable, special installation instructions are provided for an assembly at the end of the removal procedure. Always completely read the removal instructions and follow all special installation instructions.

---

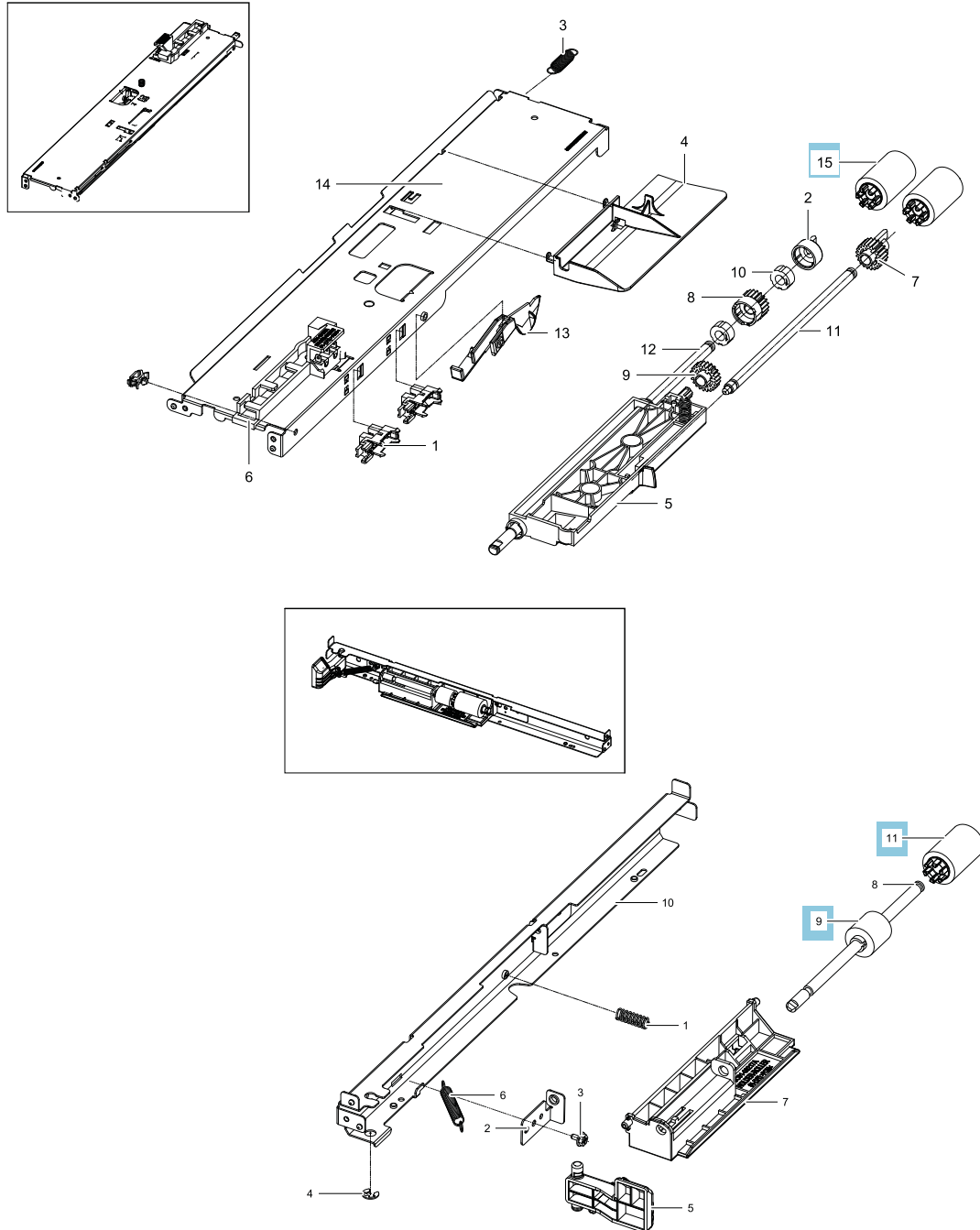
## HCI sub - pickup upper/lower

View the HCI sub - pickup upper/lower exploded view, parts list, and repair procedures.

## HCI sub - pickup upper/lower

Parts diagram and parts list for the HCI sub - pickup upper/lower.

Figure 2-588 HCI sub - pickup upper/lower





**Table 2-126** HCl sub - pickup upper/lower

Ref				
No	Part number	Description	Qty	Repair procedure
9	JC67-00455A	HCl kit - HP LaserJet E7 tray 2-z rollers (coupler torque limiter) (HCl)	1	<a href="#">Removal and replacement: HCl kit - HP LaserJet E7 tray rollers on page 716</a>
11	JC93-00504A	HCl kit - HP LaserJet E7 tray 2-x rollers (separation) (HCl)	2	<a href="#">Removal and replacement: HCl kit - HP LaserJet E7 tray rollers on page 716</a>
15	JC93-00540A	HCl kit - HP LaserJet E7 tray 2-z rollers (pick/feed) (HCl)	1	<a href="#">Removal and replacement: HCl kit - HP LaserJet E7 tray rollers on page 716</a>


## Removal and replacement: HCI kit - HP LaserJet E7 tray rollers

This document provides the procedures to remove the HCI kit - HP LaserJet E7 tray rollers.

 [View a video of removing and replacing the HP LaserJet E7 tray rollers.](#)


Mean time to repair:

Service level:

 **IMPORTANT:** When applicable, special installation instructions are provided for an assembly at the end of the removal procedure. Always completely read the removal instructions and follow all special installation instructions.

### Before performing service

- Disconnect the power cable.

 **WARNING!** To avoid damage to the printer, turn the printer off, wait 30 seconds, and then remove the power cable before attempting to service the printer.

Use the table below to identify the correct part number for your printer. To order the part, go to [www.hp.com/buy/parts](http://www.hp.com/buy/parts)

Table 2-127 Part information

Part number	Part description
JC67-00455A	HCI kit — HP LaserJet E7 tray 2-z rollers (coupler torque limiter) (HCI)
JC93-00504A	HCI kit — HP LaserJet E7 tray 2-z rollers (separation) (HCI)
JC93-00540A	HCI kit — HP LaserJet E7 tray 2-z rollers (pick/feed) (HCI)

### Required tools

- #2 JIS screwdriver with a magnetic tip

### After performing service

#### Turn the printer power on

- Connect the power cable.
- Turn on the power switch next to the power cable, and then press the power button on the front of the printer.
- Verify that the service performed was successful.
- Verify that the most recent firmware is installed on the printer.
- Verify that all parts are correctly reinstalled and are properly working.

### Post service test

Print any pages necessary to verify that the repair resolved the issue and did not create any new issues.

## Remove the HCI tray

Follow these steps to remove the HCI tray.

1. Pull the tray fully out of the HCI, and then at the left side of the tray release the hook lever on the tray.

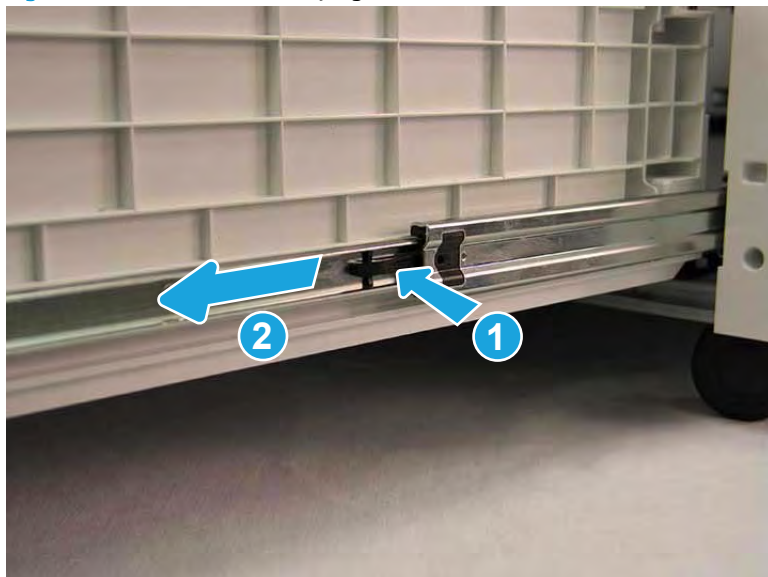
 **TIP:** Slightly pull out on the left side of the tray so that the hook lever remains unlatched.

**Figure 2-589** Release the tray left side hook lever



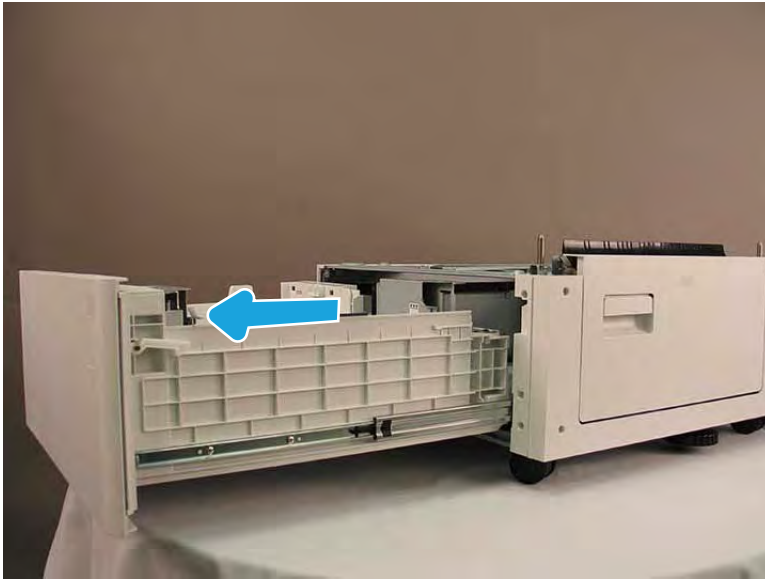
2. At the right side of the tray push in on the slide lock (callout 1) to release it, and then pull the tray away from the HCI (callout 2).

**Figure 2-590** Release the tray right-side slide lock



3. Continue to slide the tray away from the HCI to remove it.

Figure 2-591 Remove the tray

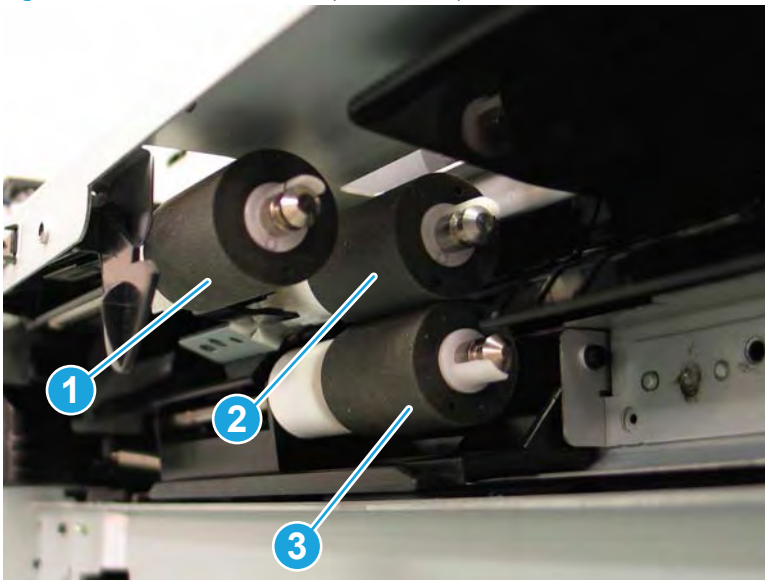


#### Remove the HCI LaserJet E7 tray rollers

Follow these steps to remove the HCI E7 tray rollers.

1. Look up into the tray cavity, and locate the feed (callout 1), pick (callout 2), and separation (callout 3) rollers.

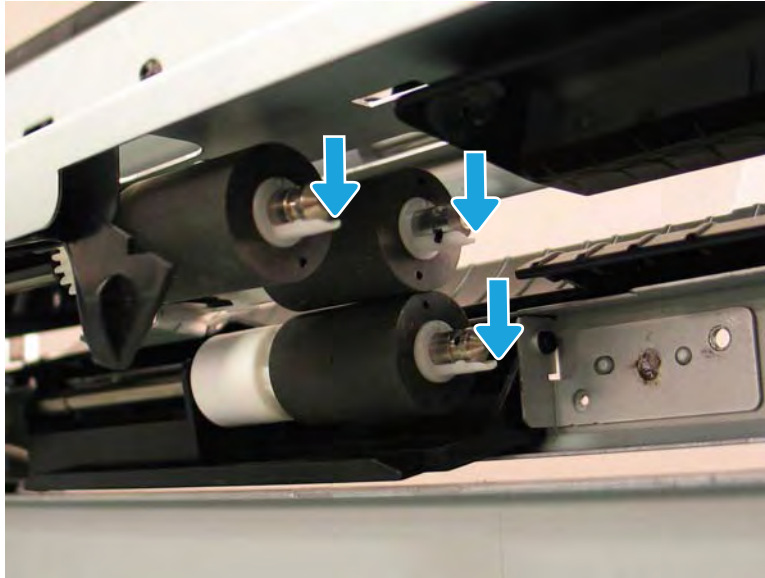
Figure 2-592 Locate the feed, pick, and separation rollers




2. Release one tab (for each roller), and then slide the roller off of the shaft.

 **NOTE:** Open the right door before attempting to remove the rollers.

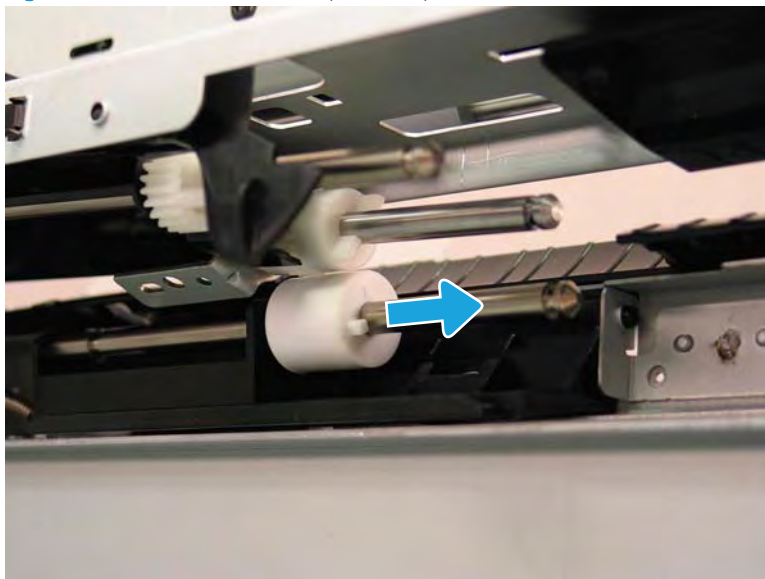
**Figure 2-593** Remove the rollers



3. Slide the coupler (torque limiter) off of the separation roller shaft.

 **Reinstallation tip:** When the coupler (torque limiter) is installed, make sure it is fully seated on the separation roller shaft. If it is not fully seated, the separation roller will not correctly install on the shaft.

**Figure 2-594** Remove the coupler (torque limiter)



### Unpack the replacement assembly

Follow these steps to unpack the replacement assembly.

1. Dispose of the defective part.



---


 **NOTE:** HP recommends responsible disposal of the defective part.


<http://www8.hp.com/us/en/hp-information/environment/product-recycling.html>

---

2. Unpack the replacement part from the packaging.


 **CAUTION:**  Some parts are sensitive to electrostatic discharge (ESD). Always perform service work at an ESD-protected workstation or mat. If an ESD workstation or mat is not available, touch the sheet-metal chassis to provide a static ground before touching an ESD-sensitive assembly. Protect the ESD-sensitive assemblies by placing them in ESD pouches when they are out of the printer.

 **IMPORTANT:** Make sure that all of the shipping materials (for example shipping tape) are removed from the replacement part prior to installation.

 **NOTE:** If the replacement part is a roller or pad, avoid touching the spongy part of it. Skin oils on the roller or pad can cause paper pickup and/or print-quality problems. HP recommends using disposable gloves when handling rollers or pads or washing your hands before touching rollers or pads.

---

3. To install an assembly, reverse the removal steps.

 **NOTE:** When applicable, special installation instructions are provided for an assembly at the end of the removal procedure. Always completely read the removal instructions and follow all special installation instructions.

---

## HCI drive

View the HCI drive exploded view, parts list, and repair procedures.

## HCI drive

Parts diagram and parts list for the HCI drive.

Figure 2-595 HCI drive

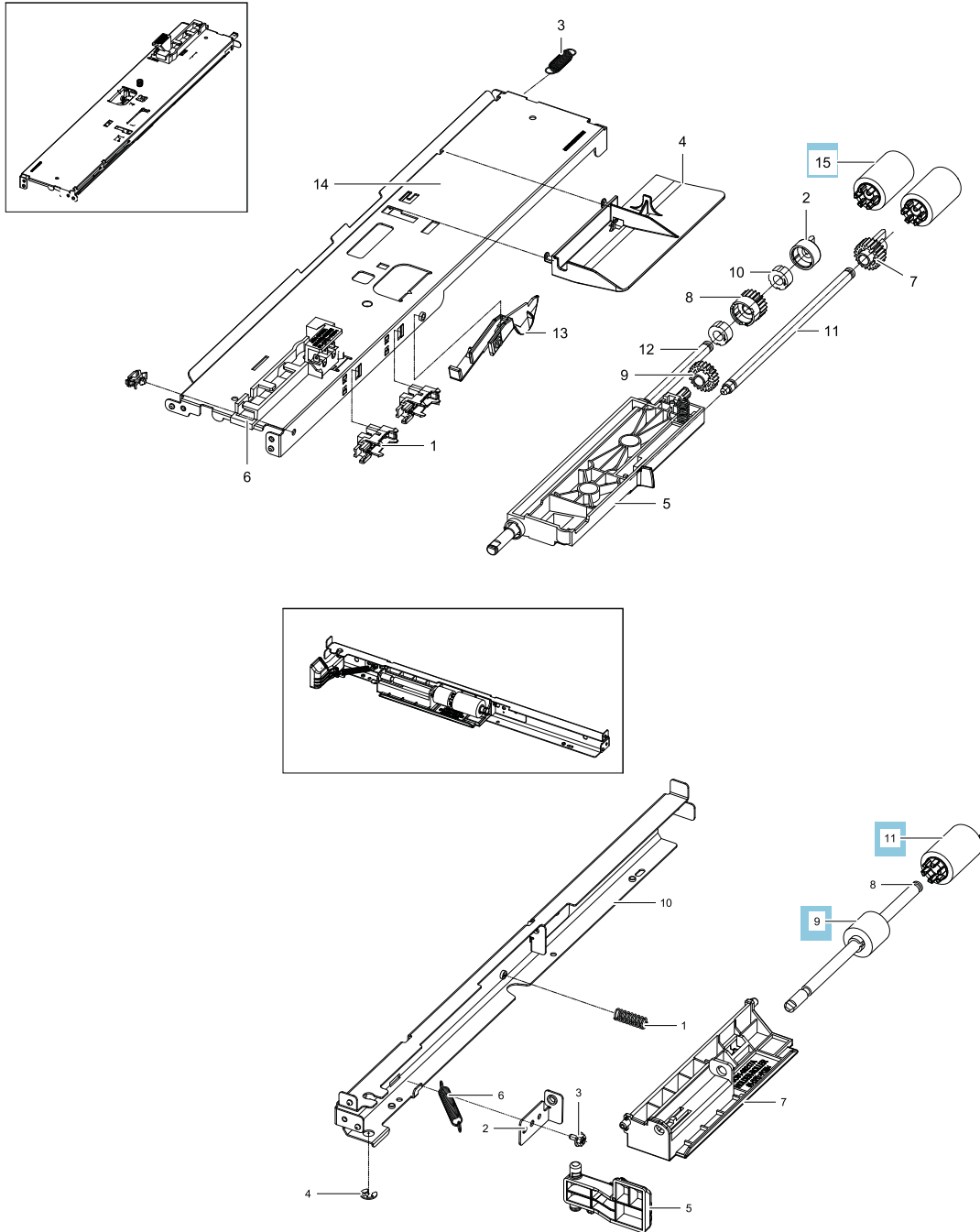


Table 2-128 HCl drive

Ref				
No	Part number	Description	Qty	Repair procedure
1	JC93-00447A	Drive assembly - feed (HCl)	1	<a href="#">Removal and replacement: HCl drive assembly - feed on page 723</a>
1-6	JC31-00033B	Motor - feed (HCl)	1	<a href="#">Removal and replacement: HCl motor - feed drive on page 727</a>
2-3	JC31-00109A	Motor - lifter drive right (HCl)	1	<a href="#">Removal and replacement: HCl motor - lift drive right and motor - lift drive left on page 732</a>
2-3	JC31-00125A	Motor - lifter drive left (HCl)	1	<a href="#">Removal and replacement: HCl motor - lift drive right and motor - lift drive left on page 732</a>
3	JC93-01465A	Drive assembly- sub-pulley (HCl)	1	<a href="#">Removal and replacement: HCl drive assembly - sub-pulley on page 738</a>
4-5	JC93-00452A	Motor - step drive (HCl) (For E77822, E77825, E77830)	1	<a href="#">Removal and replacement: HCl motor - step drive on page 735</a>
4-5	5QJ90-64002	Motor - step drive (HCl) (For E78323, E78325, E78330)	1	<a href="#">Removal and replacement: HCl motor - step drive on page 735</a>



## Removal and replacement: HCI drive assembly - feed

This document provides the procedures to remove the HCI drive assembly - feed.



[View a video of removing and replacing the drive assembly - feed.](#)

Mean time to repair:

Service level:



**IMPORTANT:** When applicable, special installation instructions are provided for an assembly at the end of the removal procedure. Always completely read the removal instructions and follow all special installation instructions.

### Before performing service

- Disconnect the power cable.



**WARNING!** To avoid damage to the printer, turn the printer off, wait 30 seconds, and then remove the power cable before attempting to service the printer.

Use the table below to identify the correct part number for your printer. To order the part, go to [www.hp.com/buy/parts](http://www.hp.com/buy/parts)

**Table 2-129** Part information

Part number	Part description
JC93-00447A	HCI drive assembly - feed

### Required tools

- #2 JIS screwdriver with a magnetic tip

### After performing service

#### Turn the printer power on

- Connect the power cable.
- Turn on the power switch next to the power cable, and then press the power button on the front of the printer.
- Verify that the service performed was successful.
- Verify that the most recent firmware is installed on the printer.
- Verify that all parts are correctly reinstalled and are properly working.

### Post service test

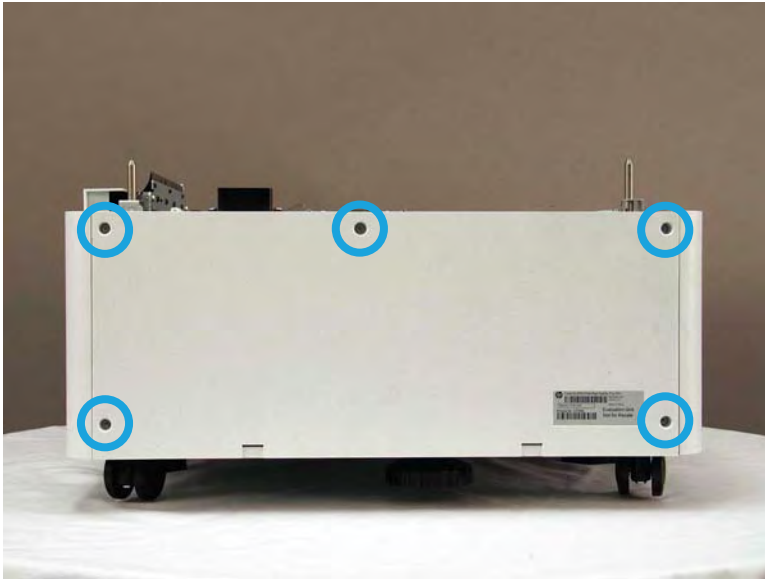
Print any pages necessary to verify that the repair resolved the issue and did not create any new issues.

### Remove the HCI rear cover

Follow these steps to remove the Remove the HCI rear cover.

- ▲ Remove five screw caps (if installed), remove five screws, and then remove the rear cover.

Figure 2-596 Remove the HCI rear cover

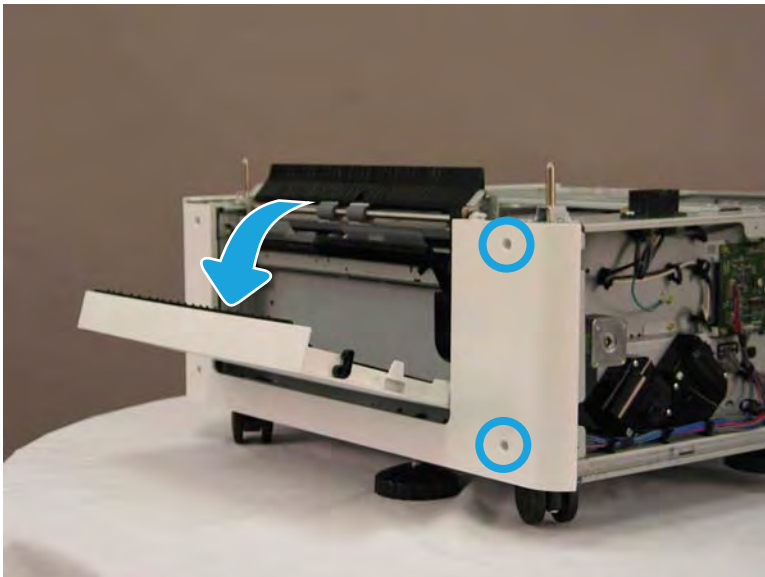


#### Remove the HCI drive assembly - feed

Follow these steps to remove the Remove the HCI drive assembly - feed.

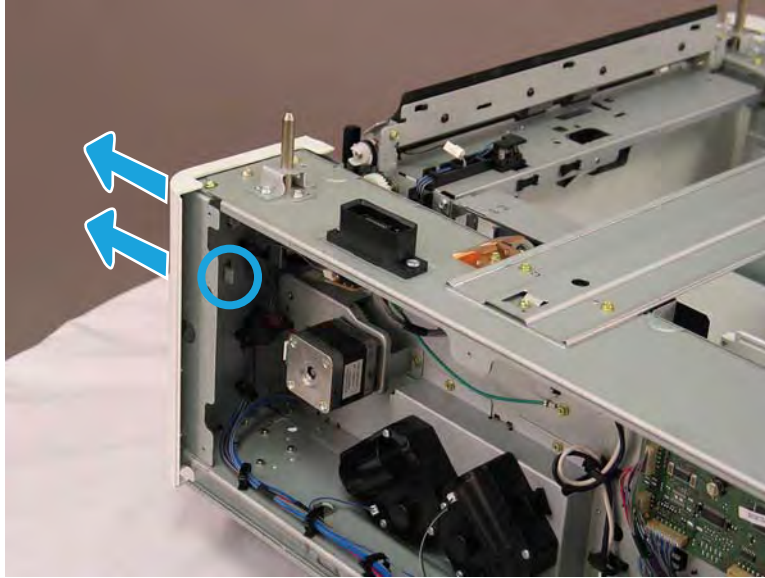
1. Open the right door, and then remove two screws.

Figure 2-597 Remove two screws



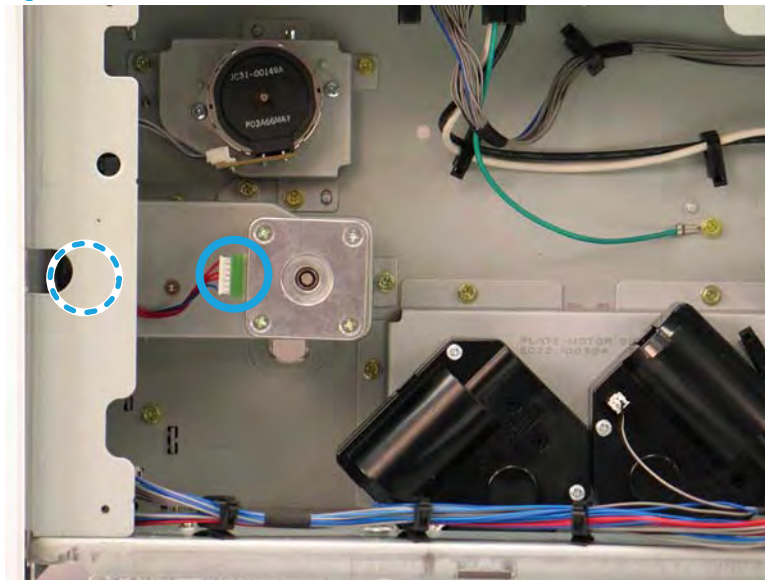
2. Release one tab, and then separate the rear edge of the right cover from the chassis.

Figure 2-598 Separate the rear edge of the right cover from the chassis



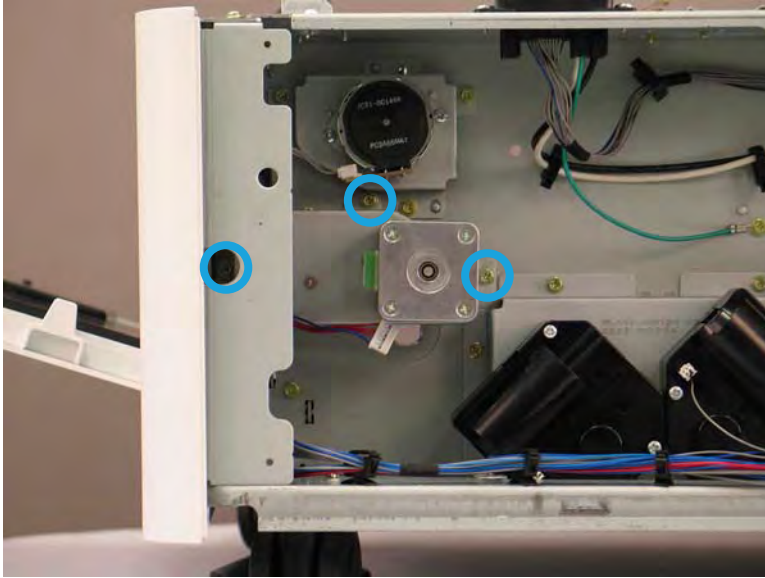
3. Disconnect one connector, and then release the wire harness from the retainer.

Figure 2-599 Disconnect one connector



4. Remove three screws, and then remove the HCI drive assembly - feed.

**Figure 2-600** Remove the HCI drive assembly - feed



### Unpack the replacement assembly



Follow these steps to unpack the replacement assembly.


1. Dispose of the defective part.


 **NOTE:** HP recommends responsible disposal of the defective part.

<http://www8.hp.com/us/en/hp-information/environment/product-recycling.html>


2. Unpack the replacement part from the packaging.

 **CAUTION:**  Some parts are sensitive to electrostatic discharge (ESD). Always perform service work at an ESD-protected workstation or mat. If an ESD workstation or mat is not available, touch the sheet-metal chassis to provide a static ground before touching an ESD-sensitive assembly. Protect the ESD-sensitive assemblies by placing them in ESD pouches when they are out of the printer.

 **IMPORTANT:** Make sure that all of the shipping materials (for example shipping tape) are removed from the replacement part prior to installation.

 **NOTE:** If the replacement part is a roller or pad, avoid touching the spongy part of it. Skin oils on the roller or pad can cause paper pickup and/or print-quality problems. HP recommends using disposable gloves when handling rollers or pads or washing your hands before touching rollers or pads.

3. To install an assembly, reverse the removal steps.

 **NOTE:** When applicable, special installation instructions are provided for an assembly at the end of the removal procedure. Always completely read the removal instructions and follow all special installation instructions.

## Removal and replacement: HCI motor - feed drive

This document provides the procedures to remove the HCI motor - feed drive.



[View a video of removing and replacing the motor - feed drive.](#)

Mean time to repair:

Service level:



**IMPORTANT:** When applicable, special installation instructions are provided for an assembly at the end of the removal procedure. Always completely read the removal instructions and follow all special installation instructions.

### Before performing service

- Disconnect the power cable.



**WARNING!** To avoid damage to the printer, turn the printer off, wait 30 seconds, and then remove the power cable before attempting to service the printer.

Use the table below to identify the correct part number for your printer. To order the part, go to [www.hp.com/buy/parts](http://www.hp.com/buy/parts)

**Table 2-130 Part information**

Part number	Part description
JC31-00033B	HCI motor - feed drive

### Required tools

- #2 JIS screwdriver with a magnetic tip

### After performing service

#### Turn the printer power on

- Connect the power cable.
- Turn on the power switch next to the power cable, and then press the power button on the front of the printer.
- Verify that the service performed was successful.
- Verify that the most recent firmware is installed on the printer.
- Verify that all parts are correctly reinstalled and are properly working.

### Post service test

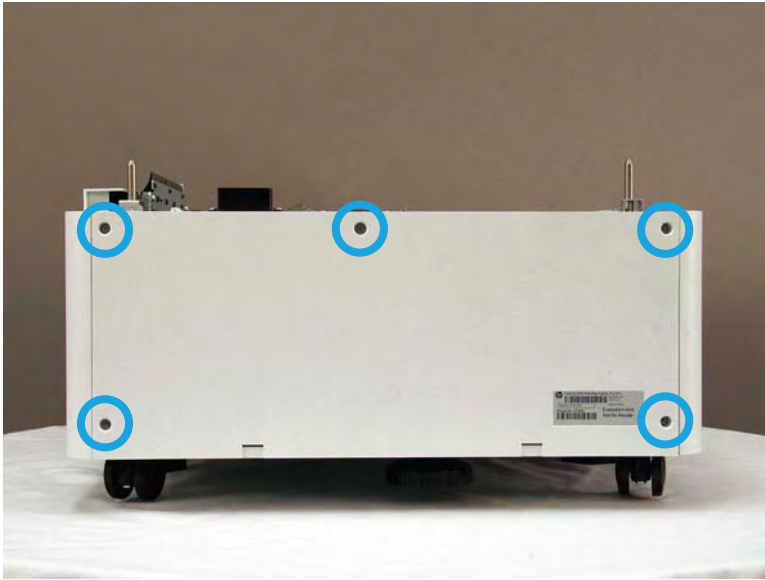
Print any pages necessary to verify that the repair resolved the issue and did not create any new issues.

### Remove the HCI rear cover

Follow these steps to remove the Remove the HCI rear cover.

- ▲ Remove five screw caps (if installed), remove five screws, and then remove the rear cover.

Figure 2-601 Remove the HCI rear cover

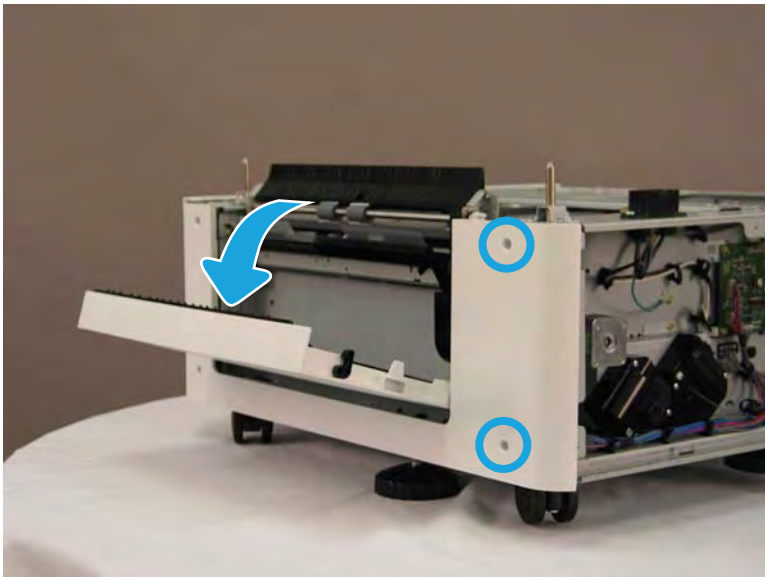


#### Remove the HCI drive assembly - feed

Follow these steps to remove the Remove the HCI drive assembly - feed.

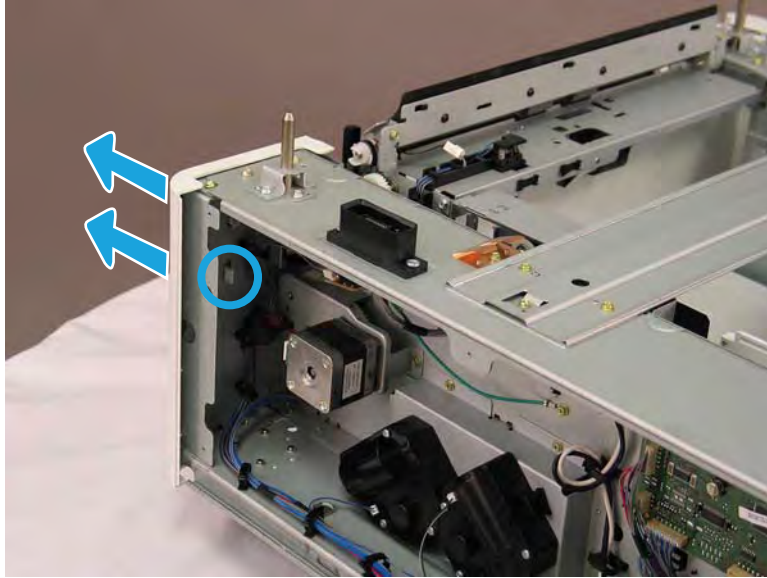
1. Open the right door, and then remove two screws.

Figure 2-602 Remove two screws



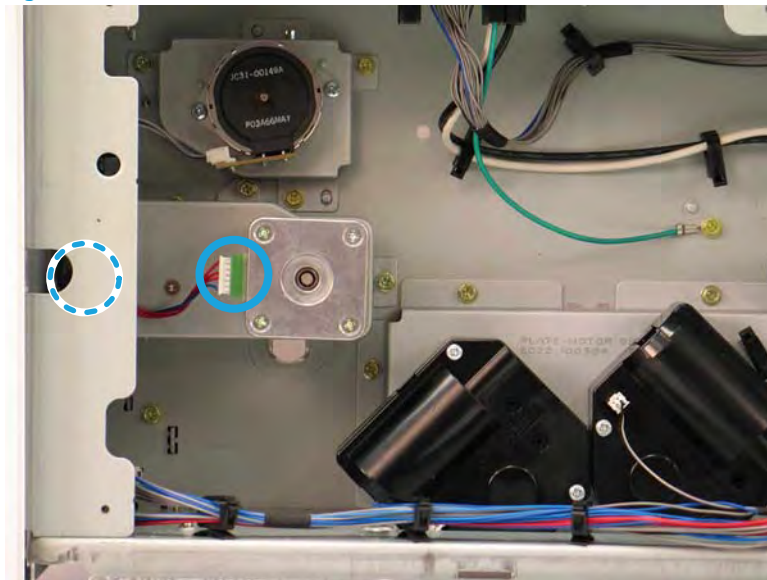
2. Release one tab, and then separate the rear edge of the right cover from the chassis.

Figure 2-603 Separate the rear edge of the right cover from the chassis



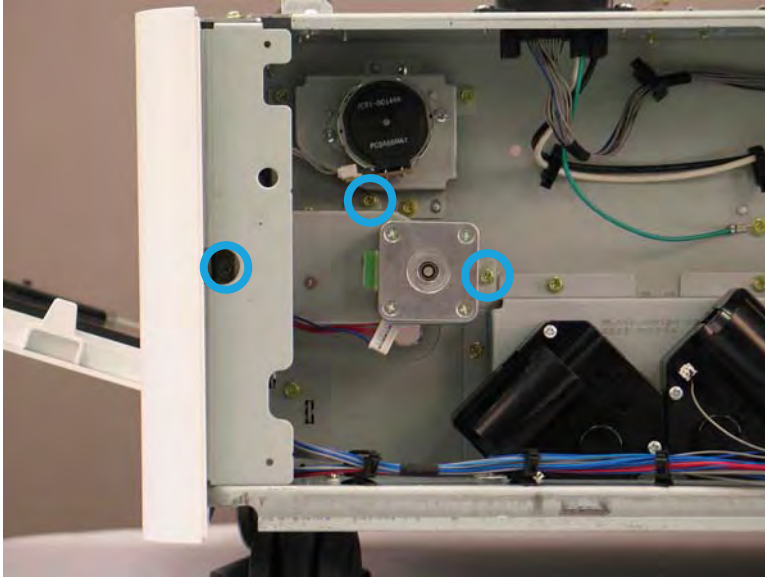
3. Disconnect one connector, and then release the wire harness from the retainer.

Figure 2-604 Disconnect one connector



4. Remove three screws, and then remove the HCI drive assembly - feed.

**Figure 2-605** Remove the HCI drive assembly - feed

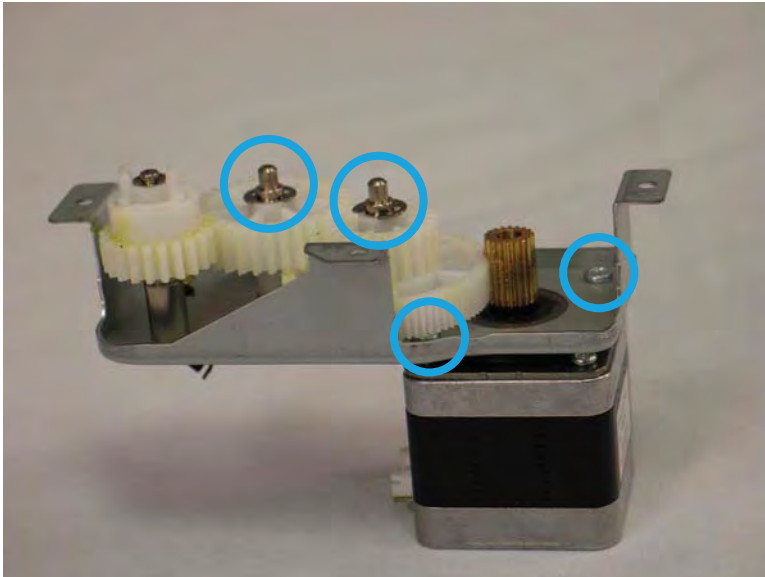


#### Remove the HCI motor - feed drive

Follow these steps to remove the HCI motor - feed drive.

- ▲ Remove two e-rings, remove two gears, and then remove two screws to separate the HCI motor - feed drive.

**Figure 2-606** Remove the HCI motor - feed drive



#### Unpack the replacement assembly

Follow these steps to unpack the replacement assembly.

1. Dispose of the defective part.





---

 **NOTE:** HP recommends responsible disposal of the defective part.


<http://www8.hp.com/us/en/hp-information/environment/product-recycling.html>

---

2. Unpack the replacement part from the packaging.


 **CAUTION:**  Some parts are sensitive to electrostatic discharge (ESD). Always perform service work at an ESD-protected workstation or mat. If an ESD workstation or mat is not available, touch the sheet-metal chassis to provide a static ground before touching an ESD-sensitive assembly. Protect the ESD-sensitive assemblies by placing them in ESD pouches when they are out of the printer.

 **IMPORTANT:** Make sure that all of the shipping materials (for example shipping tape) are removed from the replacement part prior to installation.

 **NOTE:** If the replacement part is a roller or pad, avoid touching the spongy part of it. Skin oils on the roller or pad can cause paper pickup and/or print-quality problems. HP recommends using disposable gloves when handling rollers or pads or washing your hands before touching rollers or pads.

---

3. To install an assembly, reverse the removal steps.

 **NOTE:** When applicable, special installation instructions are provided for an assembly at the end of the removal procedure. Always completely read the removal instructions and follow all special installation instructions.

---


## Removal and replacement: HCI motor - lift drive right and motor - lift drive left

This document provides the procedures to remove the HCI motor - lift drive right and motor - lift drive left.

 [View a video of removing and replacing the motor - lift drive right and motor - lift drive left.](#)


Mean time to repair:

Service level:

 **IMPORTANT:** When applicable, special installation instructions are provided for an assembly at the end of the removal procedure. Always completely read the removal instructions and follow all special installation instructions.

### Before performing service

- Disconnect the power cable.

 **WARNING!** To avoid damage to the printer, turn the printer off, wait 30 seconds, and then remove the power cable before attempting to service the printer.

Use the table below to identify the correct part number for your printer. To order the part, go to [www.hp.com/buy/parts](http://www.hp.com/buy/parts)

**Table 2-131 Part information**

Part number	Part description
JC31-00109A	HCI motor - lift drive right
JC31-00125A	HCI motor - lift drive left

### Required tools

- #2 JIS screwdriver with a magnetic tip

### After performing service

#### Turn the printer power on

- Connect the power cable.
- Turn on the power switch next to the power cable, and then press the power button on the front of the printer.
- Verify that the service performed was successful.
- Verify that the most recent firmware is installed on the printer.
- Verify that all parts are correctly reinstalled and are properly working.

### Post service test

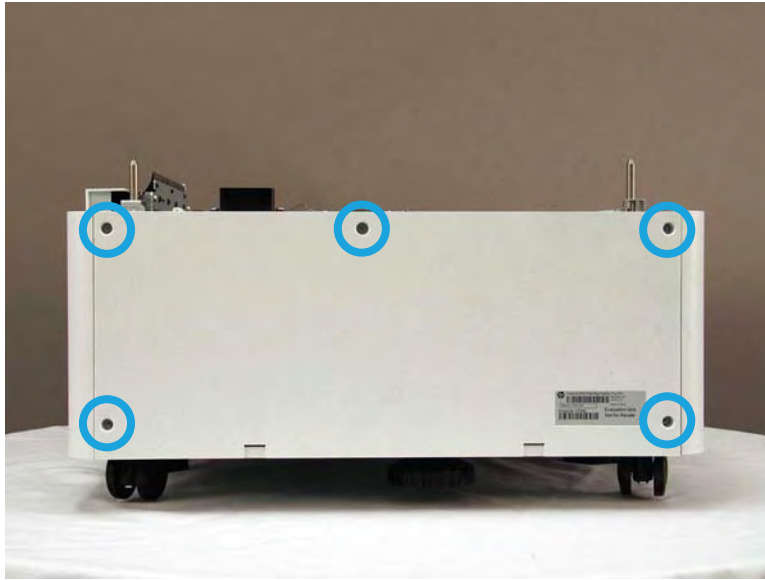
Print any pages necessary to verify that the repair resolved the issue and did not create any new issues.

### Remove the HCI rear cover

Follow these steps to remove the Remove the HCI rear cover.

- ▲ Remove five screw caps (if installed), remove five screws, and then remove the rear cover.

Figure 2-607 Remove the HCI rear cover




### Remove the HCI motor - lift drive right and motor - lift drive left

Follow these steps to remove the Remove the HCI motor - lift drive right and motor - lift drive left.

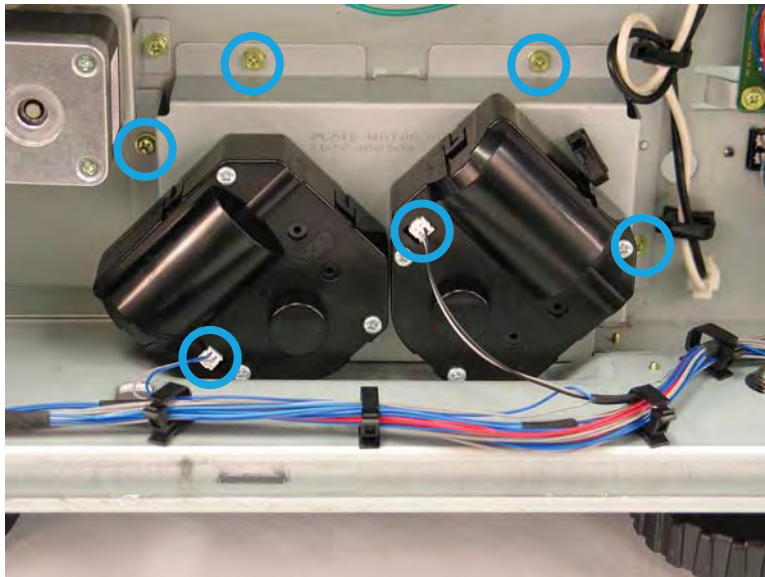
1. Disconnect two connectors, remove four screws, and the remove the HCI motor - lift drive right and motor - lift drive left.

---

 **NOTE:** It might take some force to release the assembly from the chassis.

---

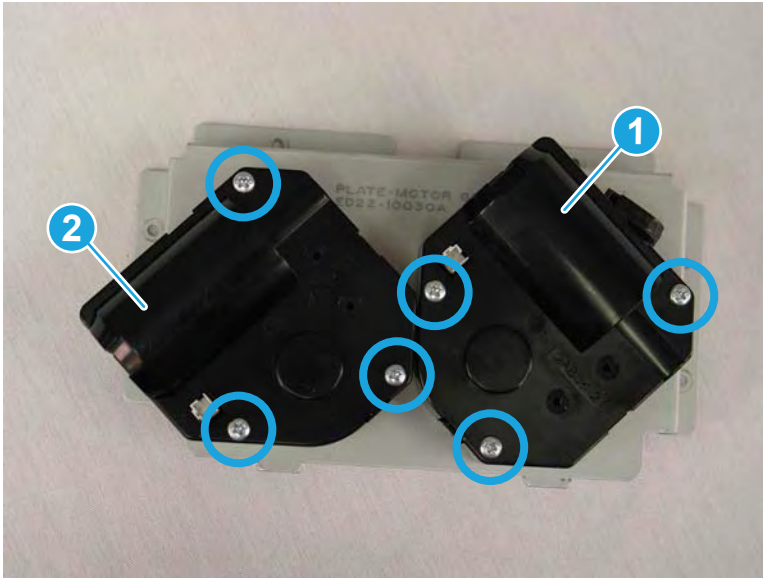
Figure 2-608 Remove the HCI motor - lift drive right and motor - lift drive left



2. Do one or both of the following:

- To remove the right-lift drive motor (callout 1): remove three screws.
- To remove the left-lift drive motor (callout 2): remove three screws.

**Figure 2-609** Remove the HCI tray right- and left-lift drive motors



### Unpack the replacement assembly

Follow these steps to unpack the replacement assembly.

1. Dispose of the defective part.




**NOTE:** HP recommends responsible disposal of the defective part.

<http://www8.hp.com/us/en/hp-information/environment/product-recycling.html>

2. Unpack the replacement part from the packaging.



**CAUTION:**  Some parts are sensitive to electrostatic discharge (ESD). Always perform service work at an ESD-protected workstation or mat. If an ESD workstation or mat is not available, touch the sheet-metal chassis to provide a static ground before touching an ESD-sensitive assembly. Protect the ESD-sensitive assemblies by placing them in ESD pouches when they are out of the printer.



**IMPORTANT:** Make sure that all of the shipping materials (for example shipping tape) are removed from the replacement part prior to installation.



**NOTE:** If the replacement part is a roller or pad, avoid touching the spongy part of it. Skin oils on the roller or pad can cause paper pickup and/or print-quality problems. HP recommends using disposable gloves when handling rollers or pads or washing your hands before touching rollers or pads.

3. To install an assembly, reverse the removal steps.



**NOTE:** When applicable, special installation instructions are provided for an assembly at the end of the removal procedure. Always completely read the removal instructions and follow all special installation instructions.

## Removal and replacement: HCI motor - step drive

This document provides the procedures to remove the HCI motor - step drive.



[View a video of removing and replacing the motor - step drive.](#)

Mean time to repair:

Service level:



**IMPORTANT:** When applicable, special installation instructions are provided for an assembly at the end of the removal procedure. Always completely read the removal instructions and follow all special installation instructions.

### Before performing service

- Disconnect the power cable.



**WARNING!** To avoid damage to the printer, turn the printer off, wait 30 seconds, and then remove the power cable before attempting to service the printer.

Use the table below to identify the correct part number for your printer. To order the part, go to [www.hp.com/buy/parts](http://www.hp.com/buy/parts)

**Table 2-132** Part information

Part number	Part description
JC93-00452A	HCI motor - step drive (E778xx series)
5QJ90-64002	HCI motor - step drive (E783xx series)

### Required tools

- #2 JIS screwdriver with a magnetic tip

### After performing service

#### Turn the printer power on

- Connect the power cable.
- Turn on the power switch next to the power cable, and then press the power button on the front of the printer.
- Verify that the service performed was successful.
- Verify that the most recent firmware is installed on the printer.
- Verify that all parts are correctly reinstalled and are properly working.

### Post service test

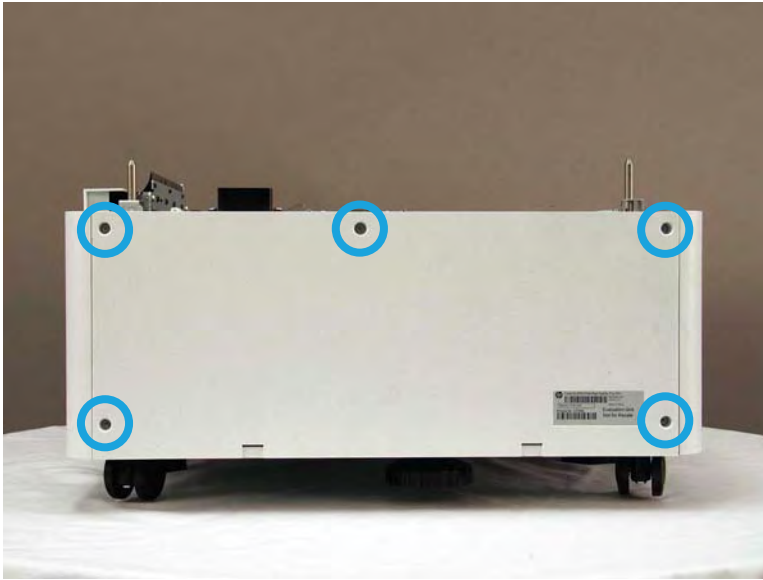
Print any pages necessary to verify that the repair resolved the issue and did not create any new issues.

### Remove the HCI rear cover

Follow these steps to remove the Remove the HCI rear cover.

- ▲ Remove five screw caps (if installed), remove five screws, and then remove the rear cover.

Figure 2-610 Remove the HCI rear cover



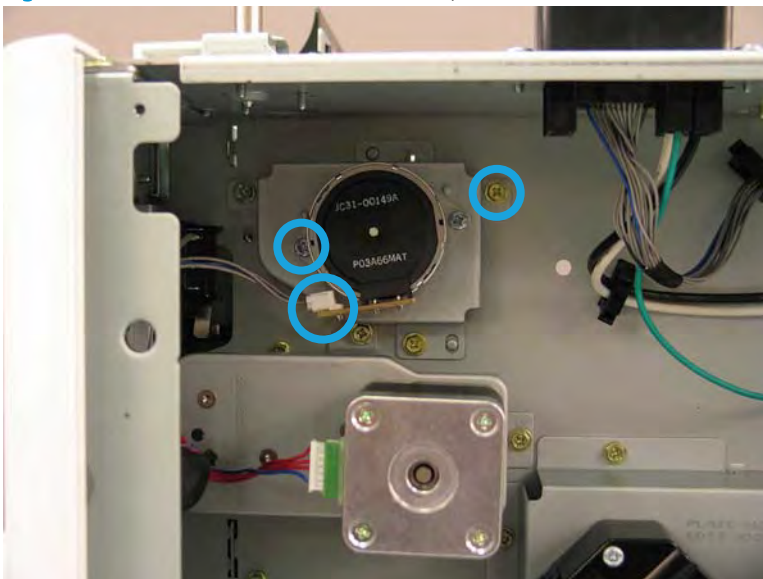
### Remove the HCI motor - step drive

Follow these steps to remove the HCI motor - step drive.

- ▲ Disconnect the one connector, remove two screws, and remove the HCI motor - step drive.

💡 **TIP:** It might be easier to disconnect the connector after the motor is removed from the bracket.

Figure 2-611 Remove the HCI motor - step drive



### Unpack the replacement assembly

Follow these steps to unpack the replacement assembly.

1. Dispose of the defective part.



---


 **NOTE:** HP recommends responsible disposal of the defective part.


<http://www8.hp.com/us/en/hp-information/environment/product-recycling.html>

---

2. Unpack the replacement part from the packaging.


 **CAUTION:**  Some parts are sensitive to electrostatic discharge (ESD). Always perform service work at an ESD-protected workstation or mat. If an ESD workstation or mat is not available, touch the sheet-metal chassis to provide a static ground before touching an ESD-sensitive assembly. Protect the ESD-sensitive assemblies by placing them in ESD pouches when they are out of the printer.

 **IMPORTANT:** Make sure that all of the shipping materials (for example shipping tape) are removed from the replacement part prior to installation.

 **NOTE:** If the replacement part is a roller or pad, avoid touching the spongy part of it. Skin oils on the roller or pad can cause paper pickup and/or print-quality problems. HP recommends using disposable gloves when handling rollers or pads or washing your hands before touching rollers or pads.

---

3. To install an assembly, reverse the removal steps.

 **NOTE:** When applicable, special installation instructions are provided for an assembly at the end of the removal procedure. Always completely read the removal instructions and follow all special installation instructions.

---


## Removal and replacement: HCI drive assembly - sub-pulley

This document provides the procedures to remove the HCI drive assembly - sub-pulley.

 [View a video of removing and replacing the sub-pulley.](#)


Mean time to repair:

Service level:

 **IMPORTANT:** When applicable, special installation instructions are provided for an assembly at the end of the removal procedure. Always completely read the removal instructions and follow all special installation instructions.

### Before performing service

- Disconnect the power cable.

 **WARNING!** To avoid damage to the printer, turn the printer off, wait 30 seconds, and then remove the power cable before attempting to service the printer.

Use the table below to identify the correct part number for your printer. To order the part, go to [www.hp.com/buy/parts](http://www.hp.com/buy/parts)

Table 2-133 Part information

Part number	Part description
JC93-01465A	HCI drive assembly - sub-pulley

### Required tools

- #2 JIS screwdriver with a magnetic tip

### After performing service

#### Turn the printer power on

- Connect the power cable.
- Turn on the power switch next to the power cable, and then press the power button on the front of the printer.
- Verify that the service performed was successful.
- Verify that the most recent firmware is installed on the printer.
- Verify that all parts are correctly reinstalled and are properly working.

### Post service test

Print any pages necessary to verify that the repair resolved the issue and did not create any new issues.

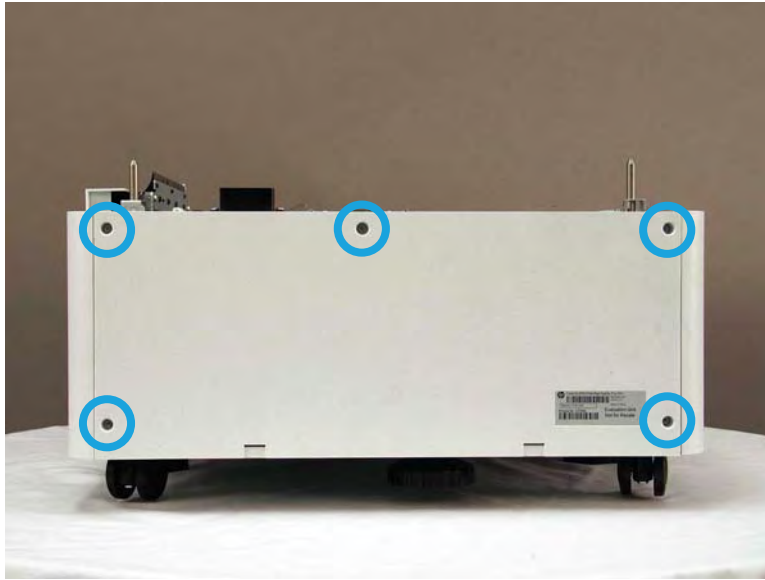
### Remove the HCI rear cover

Follow these steps to remove the Remove the HCI rear cover.



- ▲ Remove five screw caps (if installed), remove five screws, and then remove the rear cover.

Figure 2-612 Remove the HCI rear cover

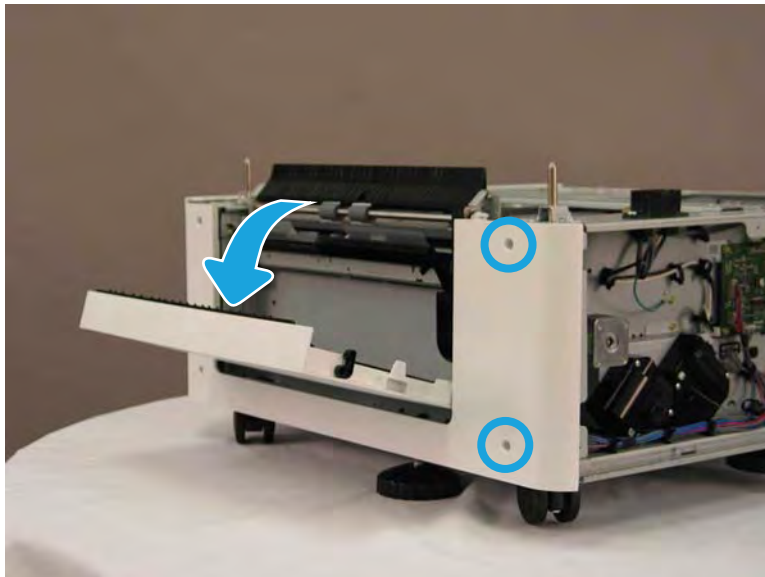


#### Remove the HCI drive assembly - feed

Follow these steps to remove the Remove the HCI drive assembly - feed.

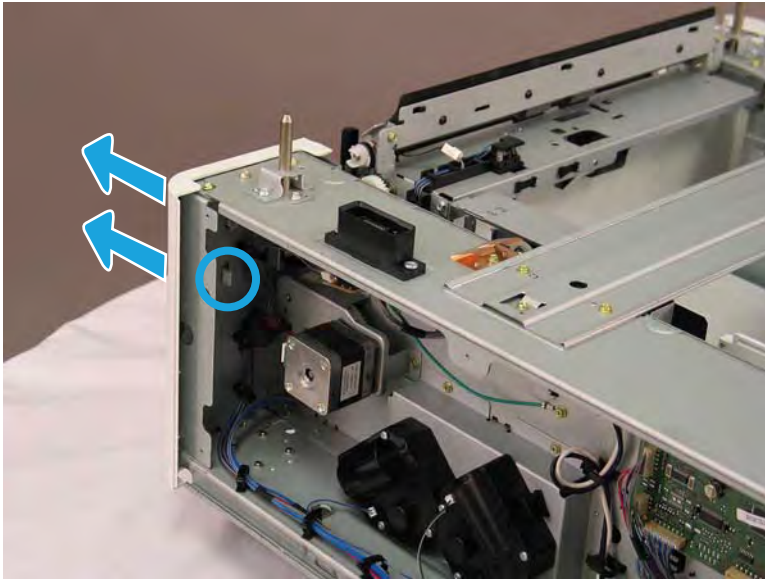
1. Open the right door, and then remove two screws.

Figure 2-613 Remove two screws



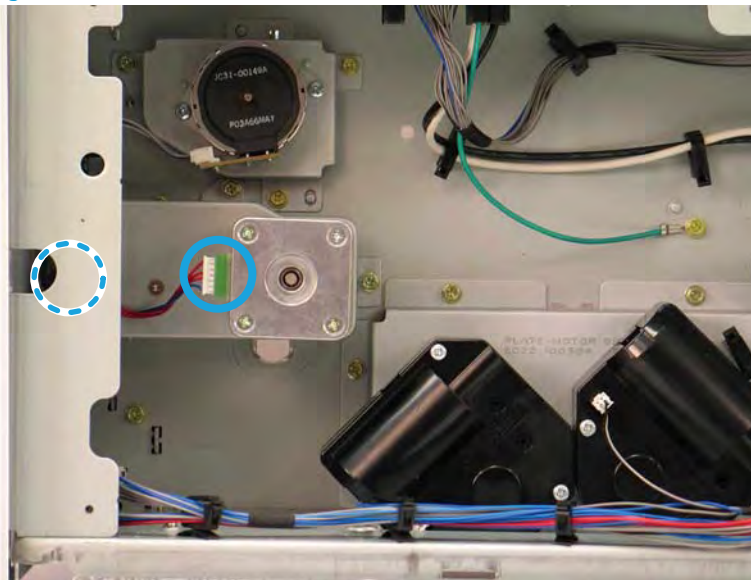
2. Release one tab, and then separate the rear edge of the right cover from the chassis.

Figure 2-614 Separate the rear edge of the right cover from the chassis



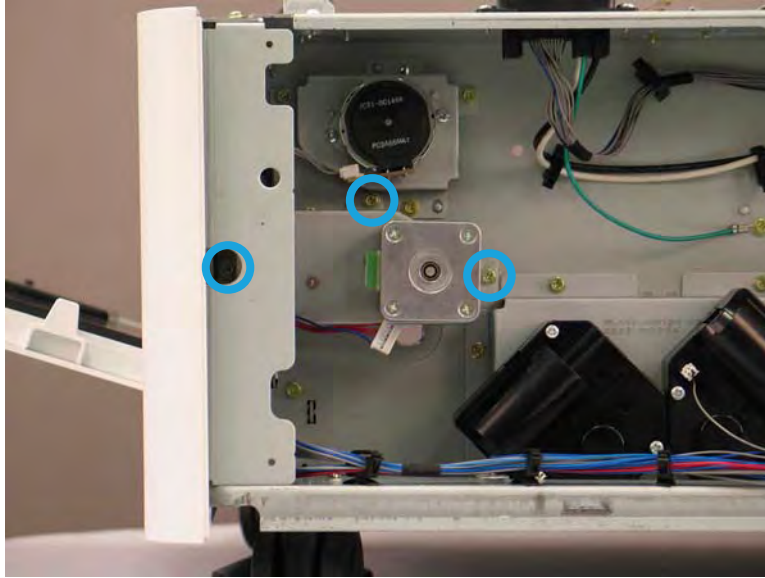
3. Disconnect one connector, and then release the wire harness from the retainer.

Figure 2-615 Disconnect one connector



4. Remove three screws, and then remove the HCI drive assembly - feed.

Figure 2-616 Remove the HCI drive assembly - feed



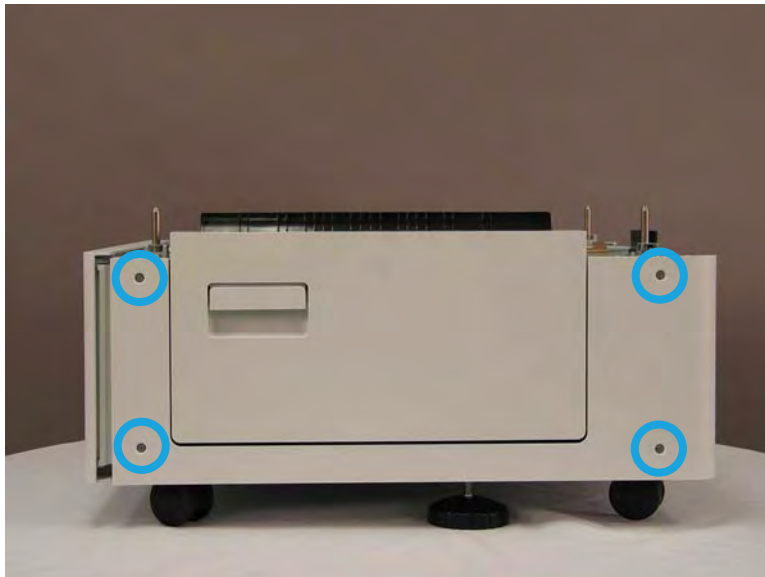
#### Remove the HCI right door

Follow these steps to remove the Remove the HCI right door.

1. Remove four screw caps (if installed), and then remove four screws.

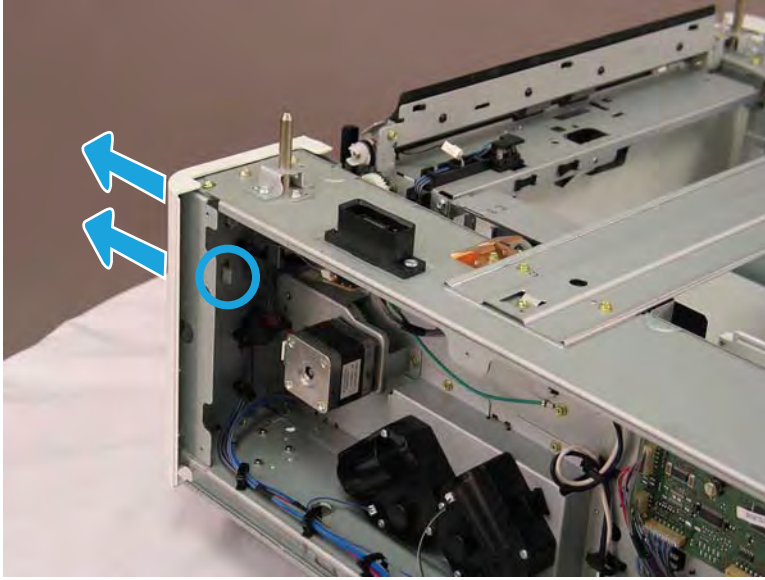
 **NOTE:** If the feed drive assembly is removed, there are only two screws that secure this cover.

Figure 2-617 Remove four screws



2. Release one tab, and then separate the rear edge of the right cover from the chassis.

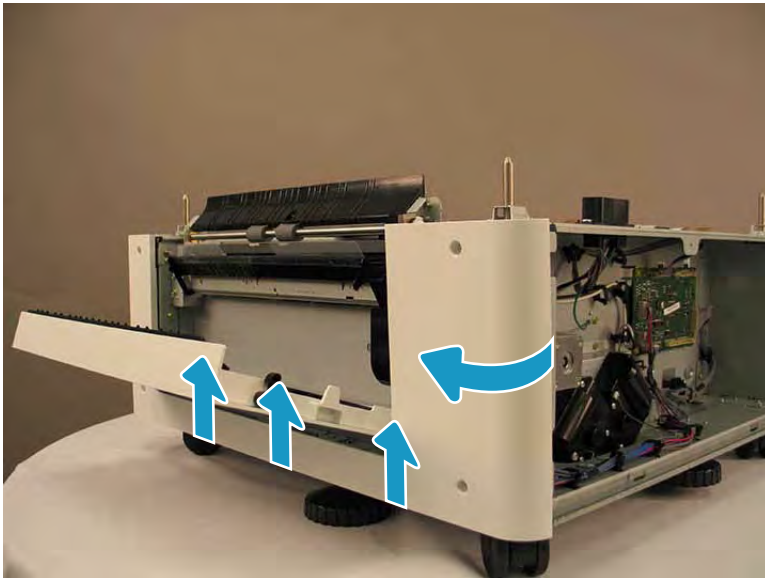
**Figure 2-618** Separate the rear edge of the right cover from the chassis



3. Lift up on the cover while rotating it away from the chassis to release three bosses.

**CAUTION:** Do not attempt to fully remove the cover. Stop as shown below. Fully removing the cover at this step will damage the remaining tab and boss on the cover

**Figure 2-619** Release three bosses



4. If the tray was not removed prior to servicing the HCI, remove it now. Look in the tray cavity and locate the right cover front tab. Release this tab.

Figure 2-620 Release one tab



5. Remove the HCI right cover.


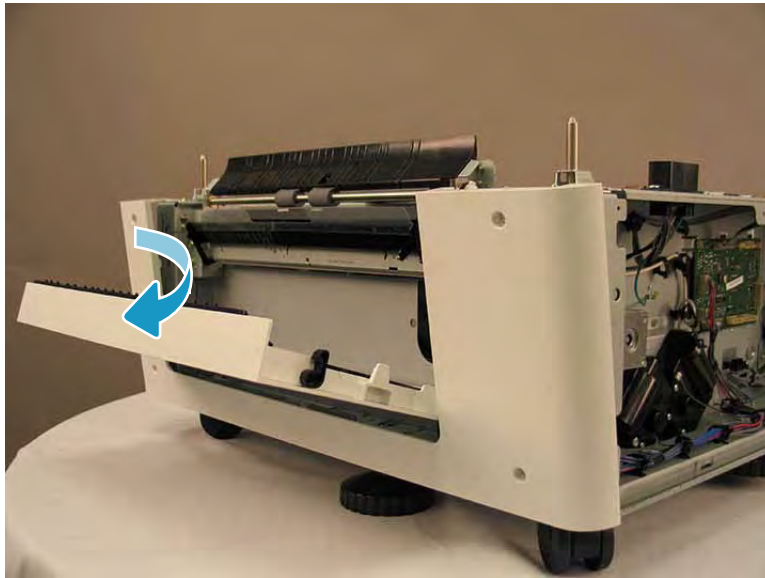
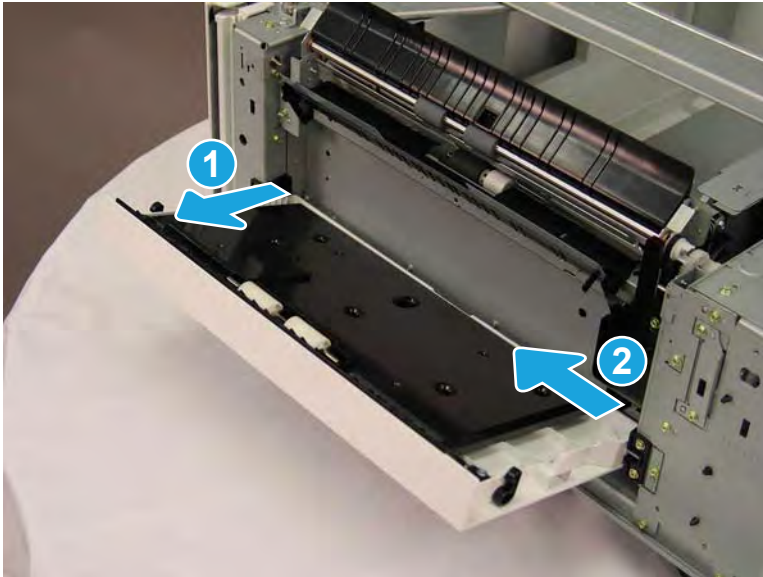
 **NOTE:** The HCI right door will not stay in the latched position when this cover is removed.

Figure 2-621 Remove the HCI right cover



6. Rotate the right door front hinge pin out of the holder, and then slide the right door towards the front of the HCI to release the rear hinge pin and remove the door.

Figure 2-622 Remove the HCI right door

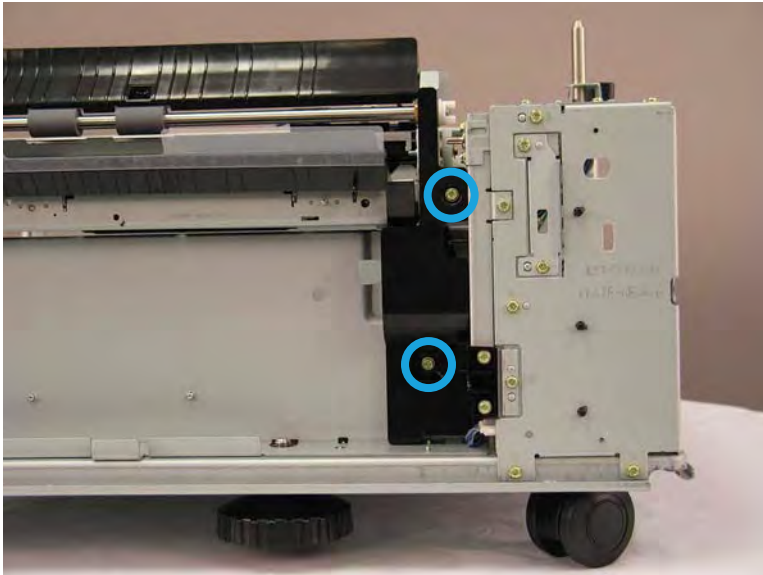


#### Remove the HCI drive assembly -sub pulley

Follow these steps to remove the Remove the HCI drive assembly -sub pulley.

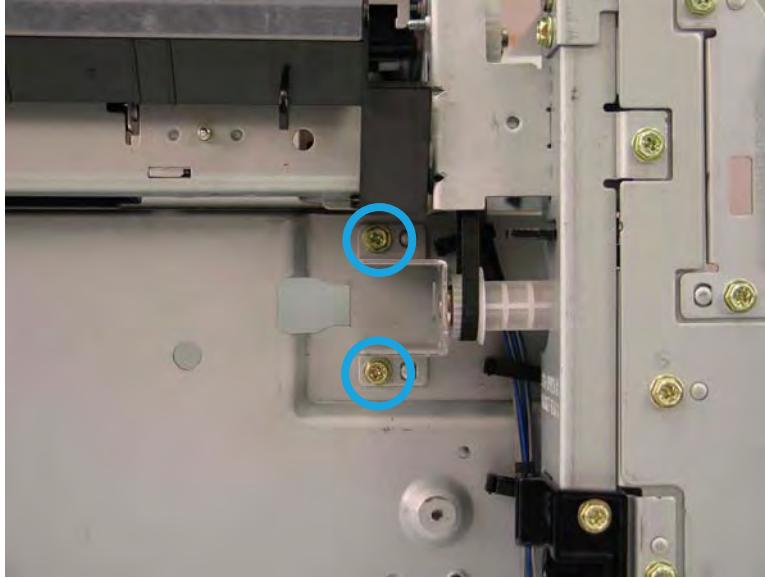
1. Remove two screws, and then remove the black-plastic cover.

Figure 2-623 Remove the cover



2. Remove two screws, and then remove the drive assembly - sub-pulley.

**Figure 2-624** Remove the HCI drive assembly - sub-pulley



### Unpack the replacement assembly



Follow these steps to unpack the replacement assembly.


1. Dispose of the defective part.


 **NOTE:** HP recommends responsible disposal of the defective part.

<http://www8.hp.com/us/en/hp-information/environment/product-recycling.html>


2. Unpack the replacement part from the packaging.

 **CAUTION:**  Some parts are sensitive to electrostatic discharge (ESD). Always perform service work at an ESD-protected workstation or mat. If an ESD workstation or mat is not available, touch the sheet-metal chassis to provide a static ground before touching an ESD-sensitive assembly. Protect the ESD-sensitive assemblies by placing them in ESD pouches when they are out of the printer.

 **IMPORTANT:** Make sure that all of the shipping materials (for example shipping tape) are removed from the replacement part prior to installation.

 **NOTE:** If the replacement part is a roller or pad, avoid touching the spongy part of it. Skin oils on the roller or pad can cause paper pickup and/or print-quality problems. HP recommends using disposable gloves when handling rollers or pads or washing your hands before touching rollers or pads.

3. To install an assembly, reverse the removal steps.

 **NOTE:** When applicable, special installation instructions are provided for an assembly at the end of the removal procedure. Always completely read the removal instructions and follow all special installation instructions.

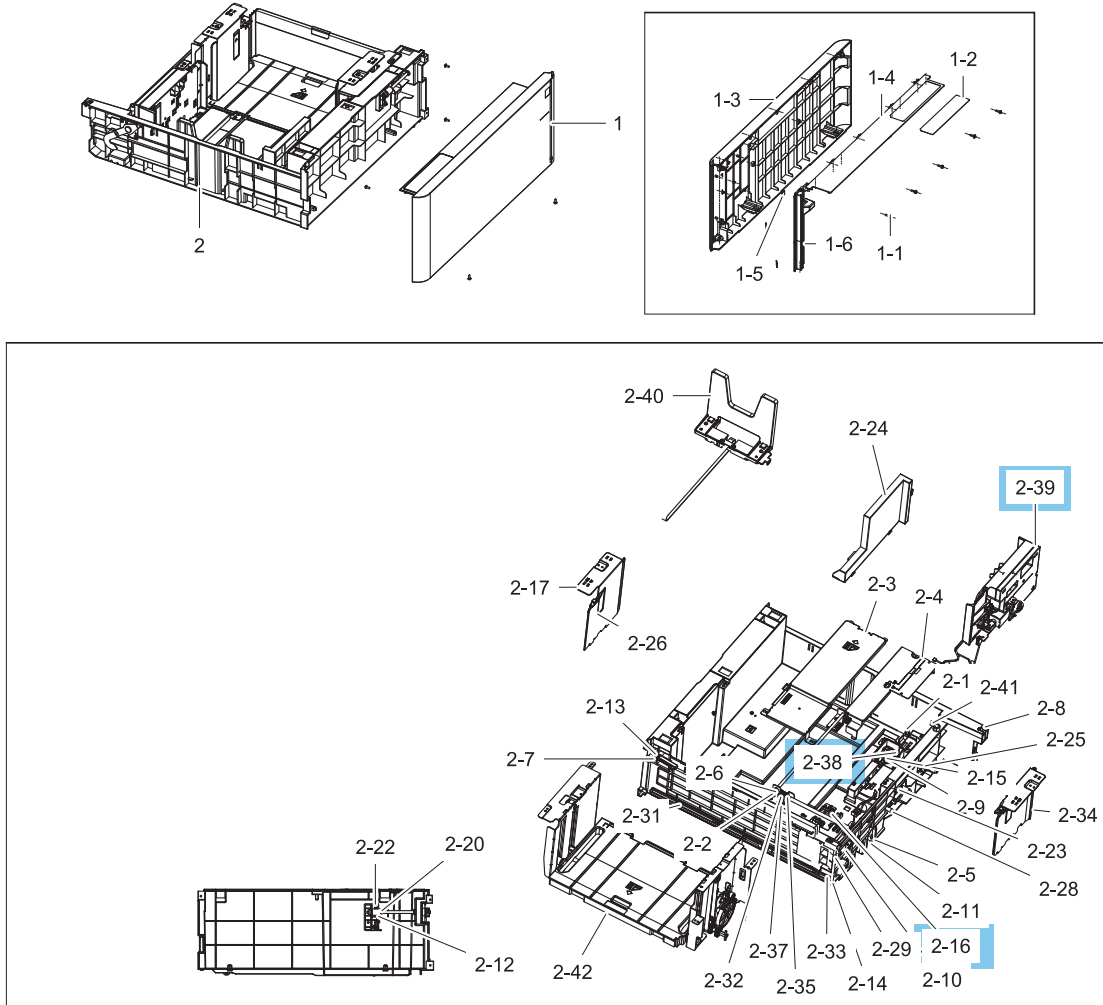
## HCI sub - cassette

View the HCI sub - cassette exploded view, parts list, and repair procedures.

## HCI sub - cassette

Parts diagram and parts list for the HCI sub - cassette.

Figure 2-625 HCI sub - cassette





**Table 2-134** HCI sub - cassette

Ref				
No	Part number	Description	Qty	Repair procedure
2-16	JC81-07468A	Bracket sensor (HCI)	1	<a href="#">Removal and replacement: HCI photo interrupter and sensor bracket on page 755</a>
2-38	0604-001393	Photo interrupter (HCI)	1	<a href="#">Removal and replacement: HCI photo interrupter and sensor bracket on page 755</a>
2-39	JC90-01723A	Sub-paper side right (HCI)	1	<a href="#">Removal and replacement: HCI sub-paper side right on page 748</a>

## Removal and replacement: HCI sub-paper side right

This document provides the procedures to remove the HCI sub-paper side right.



[View a video of removing and replacing the sub-paper side right.](#)

Mean time to repair:

Service level:



**IMPORTANT:** When applicable, special installation instructions are provided for an assembly at the end of the removal procedure. Always completely read the removal instructions and follow all special installation instructions.

### Before performing service

- Disconnect the power cable.



**WARNING!** To avoid damage to the printer, turn the printer off, wait 30 seconds, and then remove the power cable before attempting to service the printer.

Use the table below to identify the correct part number for your printer. To order the part, go to [www.hp.com/buy/parts](http://www.hp.com/buy/parts)

Table 2-135 Part information

Part number	Part description
JC90-01723A	HCI sub-paper side right

### Required tools

- #2 JIS screwdriver with a magnetic tip

### After performing service

#### Turn the printer power on

- Connect the power cable.
- Turn on the power switch next to the power cable, and then press the power button on the front of the printer.
- Verify that the service performed was successful.
- Verify that the most recent firmware is installed on the printer.
- Verify that all parts are correctly reinstalled and are properly working.


### Post service test

Print any pages necessary to verify that the repair resolved the issue and did not create any new issues.

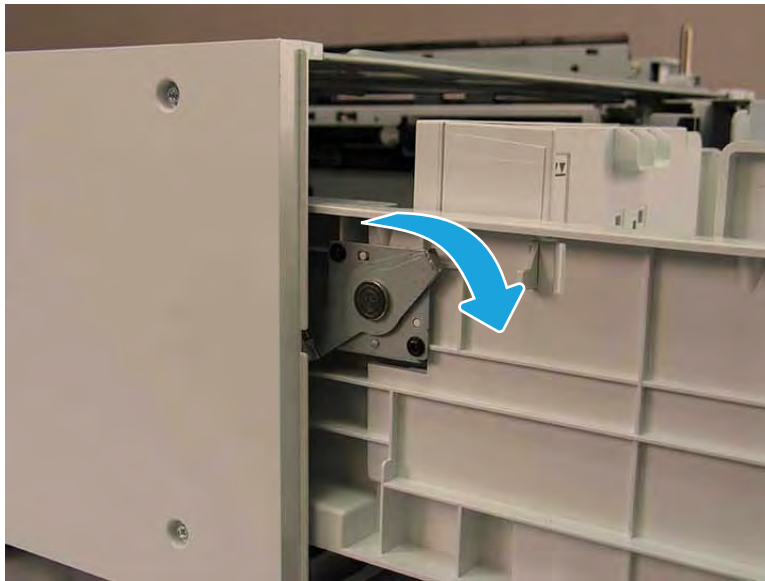
### Remove the HCI tray

Follow these steps to remove the HCI tray.

1. Pull the tray fully out of the HCI, and then at the left side of the tray release the hook lever on the tray.

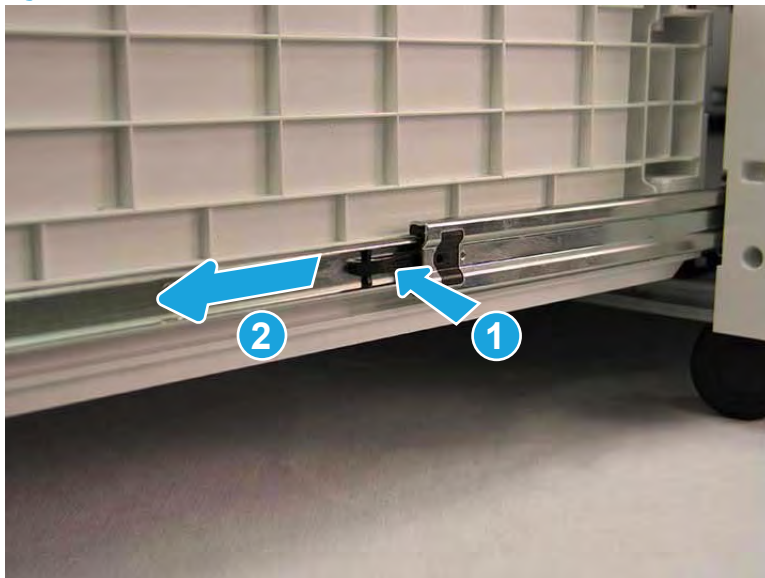
 **TIP:** Slightly pull out on the left side of the tray so that the hook lever remains unlatched.

**Figure 2-626** Release the tray left side hook lever



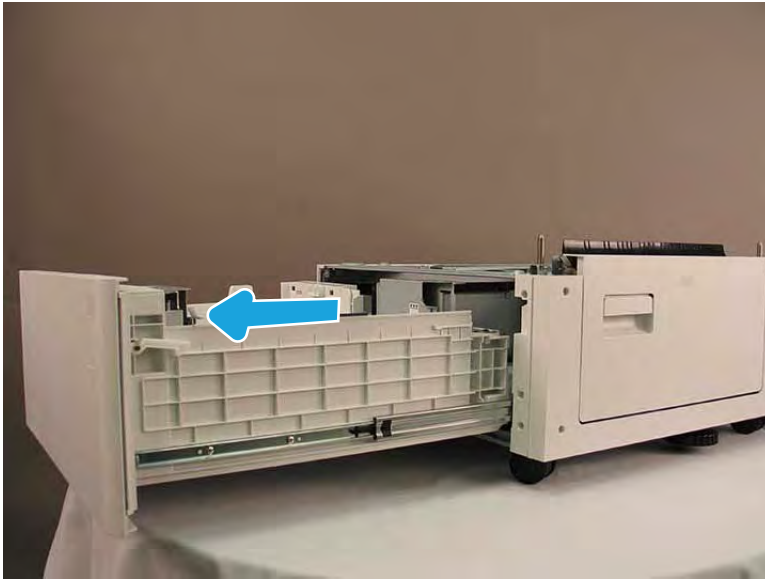
2. At the right side of the tray push in on the slide lock (callout 1) to release it, and then pull the tray away from the HCI (callout 2).

**Figure 2-627** Release the tray right-side slide lock



3. Continue to slide the tray away from the HCI to remove it.

Figure 2-628 Remove the tray

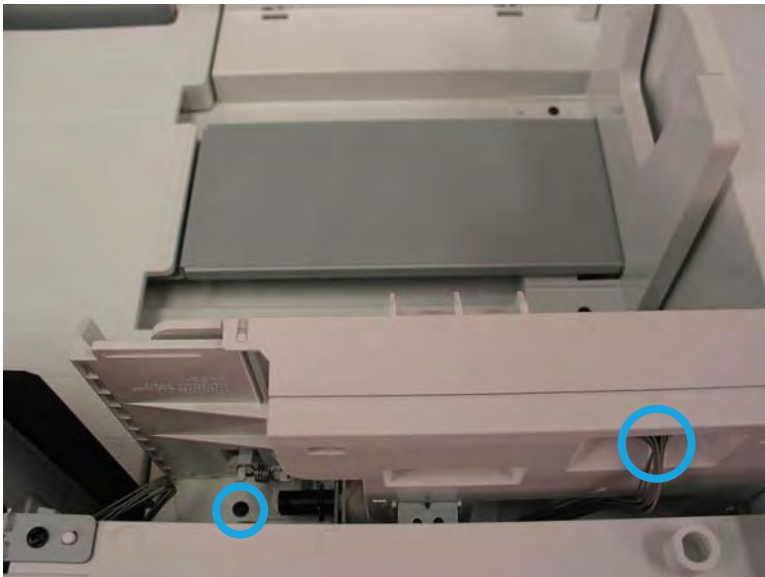


#### Remove the HCI sub-paper side right

Follow these steps to remove the HCI sub-paper side right.

1. Look into the tray, disconnect one connector, and then remove one screw.

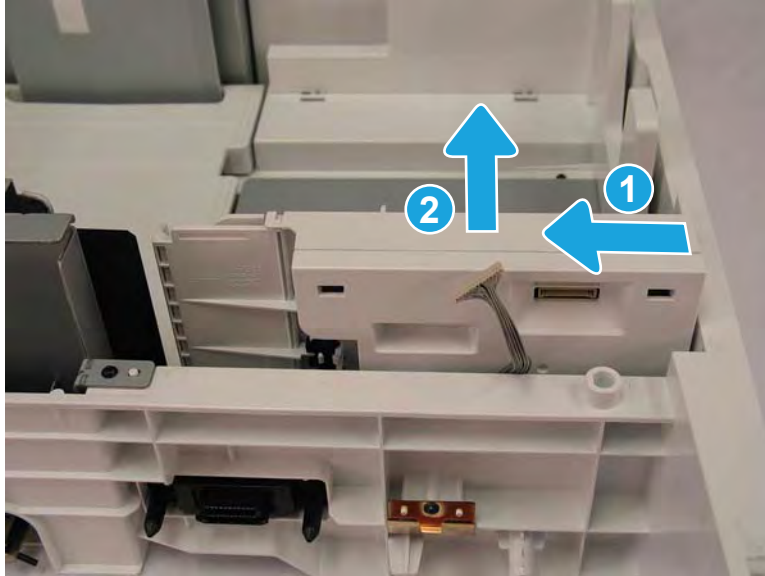
Figure 2-629 Disconnect connector and remove one screw



2. Slide the sub-paper side right assembly to the left to release it, and then slightly lit it up.

**⚠ CAUTION:** Do not attempt to completely remove the assembly. It is still attached to the tray by a wire harness and ground wire.

**Figure 2-630** Release the sub-paper side right assembly



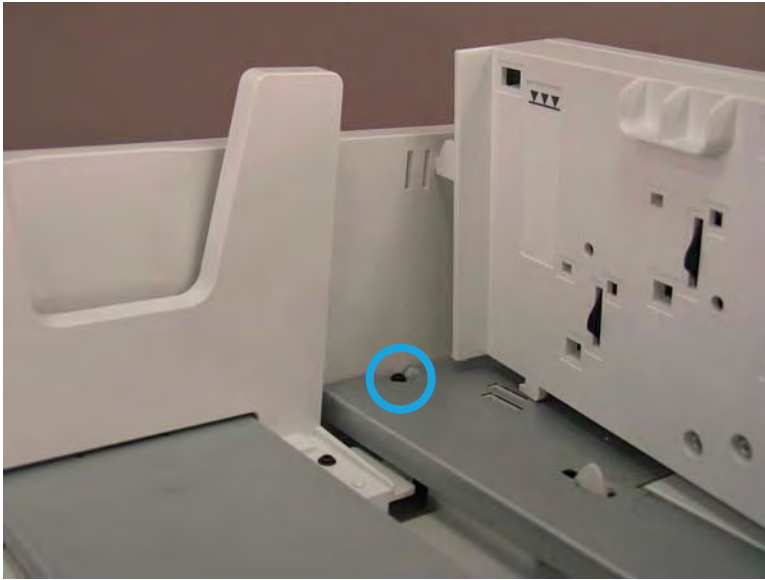
3. Remove one screw, and then release the wire harness from the retainer.

**Figure 2-631** Remove one screw and release the wire harness



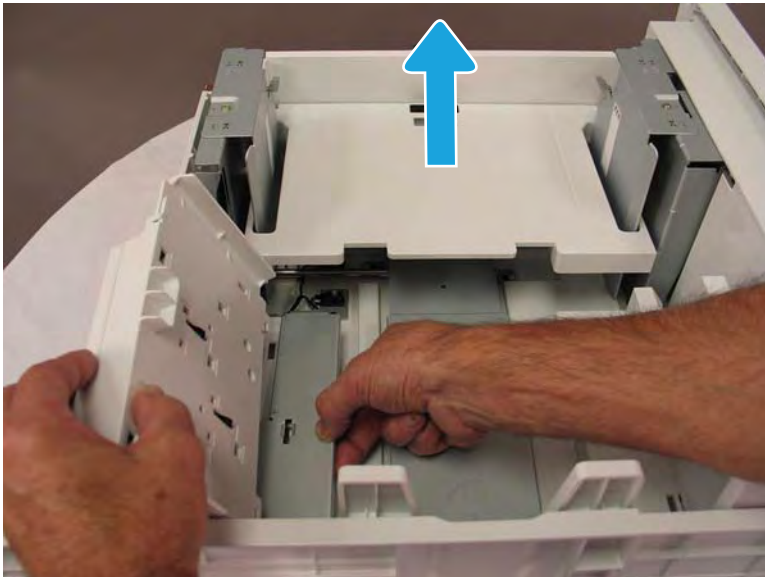
4. Remove one screw.

Figure 2-632 Remove one screw



5. Raise the paper shelf, hold the sub-paper side right assembly up and out of the way, and then remove the sheet-metal cover.

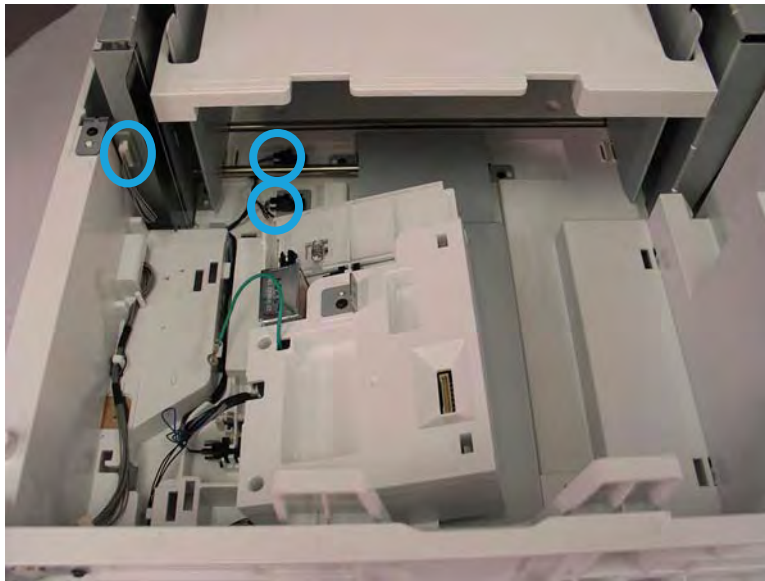
Figure 2-633 Remove the cover



6. Disconnect three connectors, and then release the wire harness from the retainers.

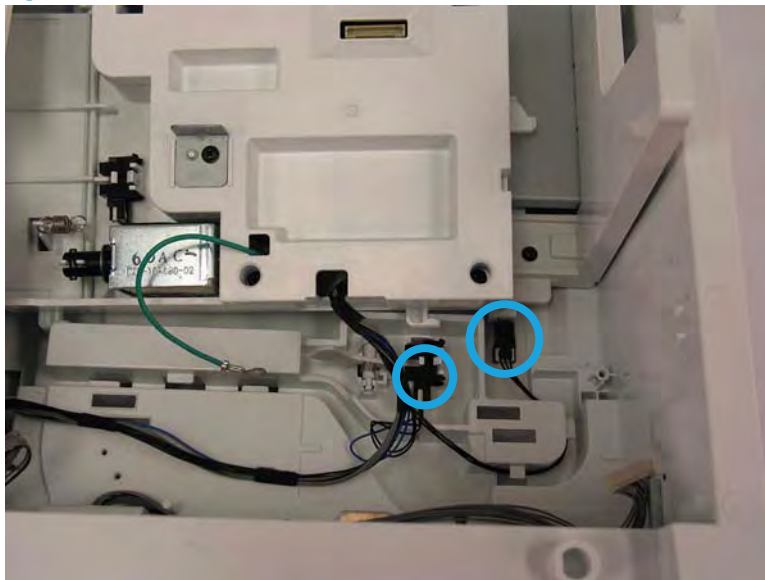
 **TIP:** Fully raise the paper shelf to access two connectors.

**Figure 2-634** Disconnect three connectors



7. Disconnect two connectors, release the wire harnesses from the guides, and then remove the sub-paper side right assembly.

**Figure 2-635** Remove the sub-paper side right assembly



### Unpack the replacement assembly

Follow these steps to unpack the replacement assembly.

1. Dispose of the defective part.



---


 **NOTE:** HP recommends responsible disposal of the defective part.


<http://www8.hp.com/us/en/hp-information/environment/product-recycling.html>

---

2. Unpack the replacement part from the packaging.


 **CAUTION:**  Some parts are sensitive to electrostatic discharge (ESD). Always perform service work at an ESD-protected workstation or mat. If an ESD workstation or mat is not available, touch the sheet-metal chassis to provide a static ground before touching an ESD-sensitive assembly. Protect the ESD-sensitive assemblies by placing them in ESD pouches when they are out of the printer.

 **IMPORTANT:** Make sure that all of the shipping materials (for example shipping tape) are removed from the replacement part prior to installation.

 **NOTE:** If the replacement part is a roller or pad, avoid touching the spongy part of it. Skin oils on the roller or pad can cause paper pickup and/or print-quality problems. HP recommends using disposable gloves when handling rollers or pads or washing your hands before touching rollers or pads.

---

3. To install an assembly, reverse the removal steps.

 **NOTE:** When applicable, special installation instructions are provided for an assembly at the end of the removal procedure. Always completely read the removal instructions and follow all special installation instructions.

---



## Removal and replacement: HCI photo interrupter and sensor bracket

This document provides the procedures to remove the HCI photo interrupter and sensor bracket.



[View a video of removing and replacing the sensor and bracket.](#)

Mean time to repair:

Service level:



**IMPORTANT:** When applicable, special installation instructions are provided for an assembly at the end of the removal procedure. Always completely read the removal instructions and follow all special installation instructions.

### Before performing service

- Disconnect the power cable.



**WARNING!** To avoid damage to the printer, turn the printer off, wait 30 seconds, and then remove the power cable before attempting to service the printer.

Use the table below to identify the correct part number for your printer. To order the part, go to [www.hp.com/buy/parts](http://www.hp.com/buy/parts)

**Table 2-136** Part information

Part number	Part description
0604-001393	HCI photo interrupter
JC81-07468A	HCI sensor bracket

### Required tools

- #2 JIS screwdriver with a magnetic tip

### After performing service

#### Turn the printer power on

- Connect the power cable.
- Turn on the power switch next to the power cable, and then press the power button on the front of the printer.
- Verify that the service performed was successful.
- Verify that the most recent firmware is installed on the printer.
- Verify that all parts are correctly reinstalled and are properly working.


### Post service test

Print any pages necessary to verify that the repair resolved the issue and did not create any new issues.

### Remove the HCI tray

Follow these steps to remove the HCI tray.

1. Pull the tray fully out of the HCI, and then at the left side of the tray release the hook lever on the tray.

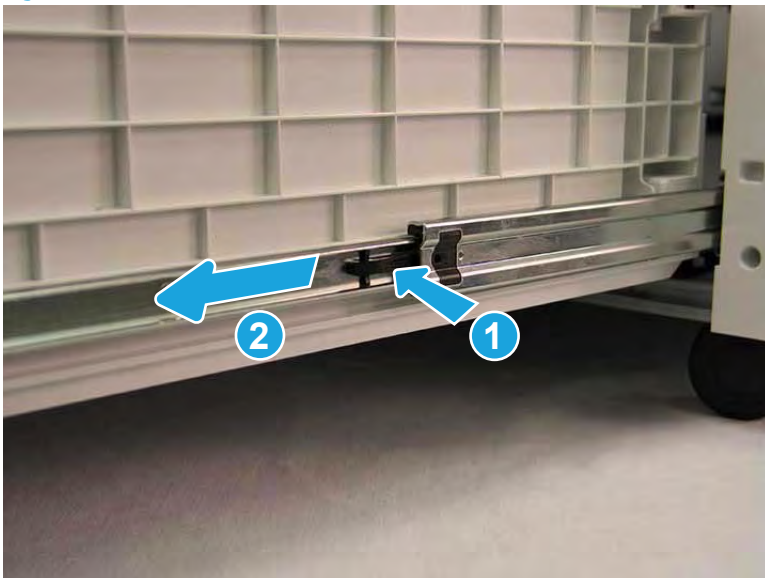
 **TIP:** Slightly pull out on the left side of the tray so that the hook lever remains unlatched.

**Figure 2-636** Release the tray left side hook lever



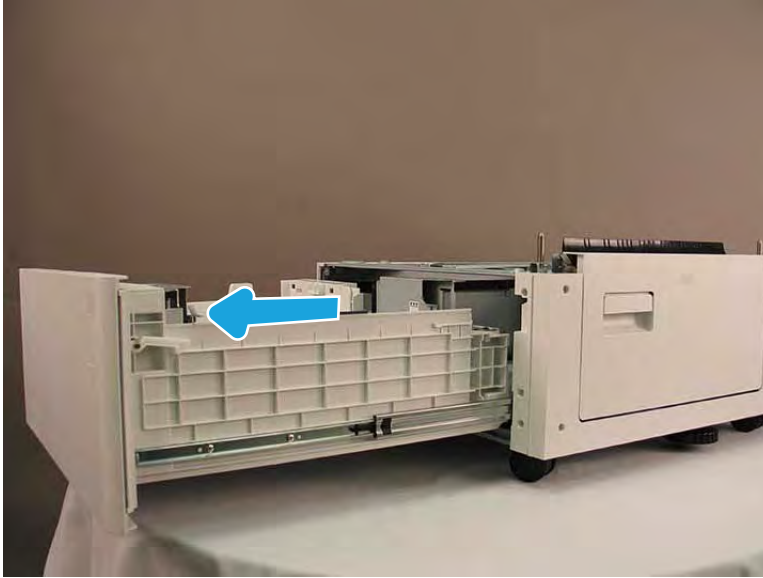
2. At the right side of the tray push in on the slide lock (callout 1) to release it, and then pull the tray away from the HCI (callout 2).

**Figure 2-637** Release the tray right-side slide lock



3. Continue to slide the tray away from the HCI to remove it.

Figure 2-638 Remove the tray



### Remove the HCI photo interrupter and sensor bracket

Follow these steps to remove the HCI photo interrupter and sensor bracket.

- ▲ Raise the paper shelf, disconnect one connector, remove one screw, and then remove the HCI photo interrupter and sensor bracket.

 **NOTE:** It might be easier to disconnect the connector after the screw is removed.

Figure 2-639 Remove the HCI photo interrupter and sensor bracket




### Unpack the replacement assembly

Follow these steps to unpack the replacement assembly.

1. Dispose of the defective part.



---


 **NOTE:** HP recommends responsible disposal of the defective part.


<http://www8.hp.com/us/en/hp-information/environment/product-recycling.html>

---

2. Unpack the replacement part from the packaging.


 **CAUTION:**  Some parts are sensitive to electrostatic discharge (ESD). Always perform service work at an ESD-protected workstation or mat. If an ESD workstation or mat is not available, touch the sheet-metal chassis to provide a static ground before touching an ESD-sensitive assembly. Protect the ESD-sensitive assemblies by placing them in ESD pouches when they are out of the printer.

 **IMPORTANT:** Make sure that all of the shipping materials (for example shipping tape) are removed from the replacement part prior to installation.

 **NOTE:** If the replacement part is a roller or pad, avoid touching the spongy part of it. Skin oils on the roller or pad can cause paper pickup and/or print-quality problems. HP recommends using disposable gloves when handling rollers or pads or washing your hands before touching rollers or pads.

---

3. To install an assembly, reverse the removal steps.

 **NOTE:** When applicable, special installation instructions are provided for an assembly at the end of the removal procedure. Always completely read the removal instructions and follow all special installation instructions.

---


---

# 3 Problem solving

Learn about problem solving.

# Control panel messages document (CPMD)

Learn about the printer control panel messages document (CPMD).

 **NOTE:** A complete CPMD is not included in this service manual.

[Click here to access the complete CPMD for this printer.](#)

## Error codes

Error codes and control-panel messages display on the printer control panel to indicate the current printer status or situations that might require action. Error codes are numerical, or alphanumeric, and have a set structure with six characters (example: 13.WX.YZ).

- The first two characters are numeric and represent the system component that is causing the error. For example, in error code 10 . 22 . 15, **10** = **Supplies** for HP LaserJets.
- The remaining four characters (W, X, Y, and Z values) further define the error.

HP LaserJet and HP PageWide Enterprise error codes are documented in the control panel message document (CPMD) for each printer.

The CPMD is a comprehensive list of error codes, diagnostic and troubleshooting steps to clear or resolve the error, and other helpful information such as service mode pins and part numbers.

The CPMD is continually updated and republished with the latest information for the following error codes.

**Table 3-1 ERROR CODES: The first two characters**

Error code	System Component	System Error Description
10.WX.YZ	Supplies (LaserJet)	Supply error or supply memory error.
11.WX.YZ	Real-time clock	Internal error with the clock on the formatter.
13.WX.YZ	Jam (LaserJet)	Paper jam or open door jam error.
15.WX.YZ	Jam (PageWide)	Paper jam or open door jam error.
17.WX.YZ	Supplies (PageWide)	Supply error or supply memory error.
20.WX.YZ	Printer memory	Insufficient memory or buffering error.
21.WX.YZ	Page	Page complexity causing a decompression error when trying to process job.
30.WX.YZ	Scanner	Flatbed scanner error occurring inside the unit.
31.WX.YZ	Document feeder	Document feeder, scanner, or jam error.
32.WX.YZ	Backup, restore, or reset	Backup, restore, or reset notification or error.
33.WX.YZ	Security	Backup, Disk, EFI BIOS, Firmware integrity (SureStart), or Trusted Platform Module (TPM) notification or error.
40.WX.YZ	Input/Output (I/O)	Partition manager, secure erase, or USB accessory error.

**Table 3-1 ERROR CODES: The first two characters (continued)**

Error code	System Component	System Error Description
41.WX.YZ	Fuser, Laser scanner, or Paper path	Miscellaneous error including general and misprint or mismatch errors typically involving (but not limited to) the fuser, the laser scanner, or the paper path.
42.WX.YZ	Firmware	Firmware failure involving the Event Log, Shell, System Manager, or other component.
44.WX.YZ	Firmware	Firmware failure involving a digital sending component.
45.WX.YZ	OXPd/Web Kit (PageWide)	Informational notifications involving the OXPd Web Kit (communications log).
46.WX.YZ	Engine (LaserJet)	Engine communication error.
47.WX.YZ	Firmware	Job parser or printer calibration error.
48.WX.YZ	Firmware	PJA job accounting, job management, or job pipeline error.
49.WX.YZ	Firmware	Firmware communication error.
50.WX.YZ	Fuser (LaserJet)	Fuser error.
51.WX.YZ	Laser scanner (LaserJet)	Laser scanner beam error.
52.WX.YZ	Laser scanner (LaserJet)	Laser scanner startup error.
54.WX.YZ	Sensor	Sensor error (not jam related).
55.WX.YZ	DC controller (LaserJet)	DC controller communication error.
56.WX.YZ	Paper handling (LaserJet)	Paper input/output or accessory error.
57.WX.YZ	Fan	Fan error.
58.WX.YZ	Sensor	Engine sensor failure.
59.WX.YZ	Motor (LaserJet)	Motor error.
60.WX.YZ	Tray motor error (LaserJet)	Tray lifting or pick up error.
61.WX.YZ	Engine (PageWide)	Print engine error with the 8-bit data package.
62.WX.YZ	System (LaserJet)	LaserJet internal system error.
	Print bar (PageWide)	PageWide print system error.
63.WX.YZ	Engine (LaserJet)	General engine error (electrical, communication, etc.).
65.WX.YZ	Connector	Output accessory connection error.
66.WX.YZ	Output accessory	Output accessory error.
67.WX.YZ	Input accessory	Input accessory connection error
69.WX.YZ	Duplexer	Duplexer error.
70.WX.YZ	DC controller (LaserJet)	DC controller firmware error.
80.WX.YZ	Managed device	Embedded Jetdirect error.

**Table 3-1 ERROR CODES: The first two characters (continued)**

Error code	System Component	System Error Description
81.WX.YZ	Near Field Communication (NFC)	Wireless, Bluetooth or internal EIO error.
82.WX.YZ	Memory (hard disk, EMMC, etc.)	Disk hardware error.
90.WX.YZ	Internal diagnostics	Internal test of systems (i.e. disk, CPB, display) or interconnection error.
98.WX.YZ	Hard disk	Hard disk partition error.
99.WX.YZ	Firmware installer	Remote Firmware Upgrade (RFU), firmware install (engine or accessory), or disk error.

## How to search for printer documentation

Find printer documentation using the internal HP portals.

The CPMD, error codes, and other support documentation for each printer is found on the internal HP portals [GCSN](#) and [WISE](#) (formerly SAW). GCSN is available to HP channel partners and WISE is available to call agents, service technicians, and other HP internal users. The level of detail available will depend on your access credentials.

### How to search WISE for printer documentation

These instructions are for HP internal use by call agents, service technicians, and other internal users. [View a video of how to find support content in WISE.](#)

To view a list of control panel message documents per printer in WISE, enter document ID **c05048451**, to locate CPMD list.

Go to WISE and enter this document ID **c05791539** for written instructions.

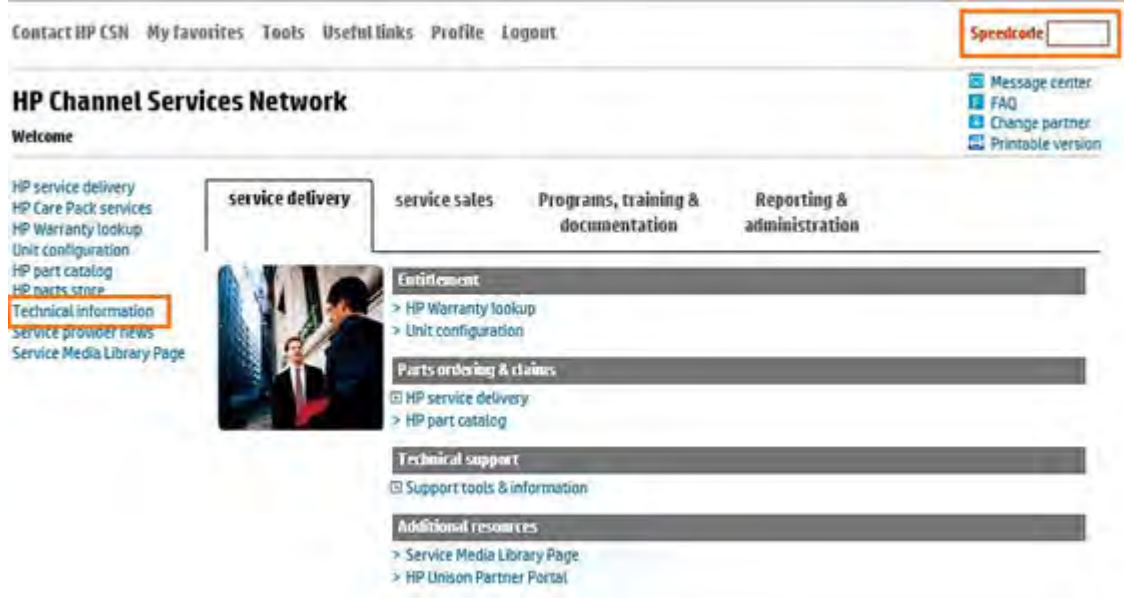
### How to search GCSN for printer documentation

These instructions are for internal use by HP Channel Partners. [View a video of how find support content in GCSN](#), or follow the steps below.

1. On the Home screen in GCSN, open **Technical information** using one of the following two methods:
  - Type **TINF** in the **Speedcode** field found in the upper right corner and press [Enter](#), or
  - On the Home page, click **Technical information** in the left pane.



Figure 3-1 GCSN home page



2. Under **Product Search**, select the **Type**, **Category**, **Family**, and **Series** that match your product model (leave the **Model** field as blank or the default).


 **NOTE:** Make sure to login to GCSN using your service-qualified credentials to access the most comprehensive content list available. To find out how to become service-qualified, contact your HP representative.

Figure 3-2 Sample product search criteria (GCSN)

**Product Search** **Add Favorites**

**Type**  
Printers and Multifunction

**Category**  
Multifunction and All-in-One

**Family**  
HP LaserJet MFP and All-in-One Products

**Series**  
HP Color LaserJet Enterprise MFP M682 series

**Model**  
Select a Model

- Click **Add Favorites** and then click **Add** to add the printer to your Favorites list and allow you to bypass the **Product Search** fields next time for that particular model (optional).

Figure 3-3 Add favorites (GCSN)

The screenshot shows a section titled 'Product Search' with a blue 'Add Favorites' button. Below the button are three dropdown menus: 'Type' set to 'Printers and Multifunction', 'Category' set to 'Multifunction and All-in-One', and 'Family' set to 'HP LaserJet MFP and All-in-One Products'.

- Clear all of the high-level check boxes.

Figure 3-4 Clear search criteria (GCSN)

The screenshot shows a list of document types with checkboxes. A grey bar at the top says 'Select the appropriate check boxes for the document types you wish to review.' The checkboxes are organized into three columns. The first column includes 'Support Communications' (highlighted with an orange box), 'Customer Advisory', 'Customer Bulletin', 'Customer Notice', 'Customer Work Instruction (CSR)', 'Product Change Notification', 'Security Bulletin', 'Service Action Advisory', 'Service Advisory', and 'Service Bulletin'. The second column includes 'Manuals and Guides' (highlighted with an orange box), 'Illustrated Parts Map', 'Install Guide', 'Maintenance/Service Guide', 'Parts Guide', 'QuickSpec', 'Reference Manual', 'Service Guide/Manual', 'Technical Reference Guide', and 'Training Material'. The third column includes 'Support Information' (highlighted with an orange box), 'Action Procedure Map', 'CPMMap', 'Support Information', 'Top Issue (Note: If you are selecting top issue it will return only top issue documents)', 'Software Support & Drivers Information', 'Product Bulletin/QuickSpec', and 'Buy Care Packs'.

- Select the check boxes for the document types for which you want to search.

 **NOTE:** Select only the high-level **Manuals and Guides** search option if you are not sure in which type of manual or guide the content might be listed.

Figure 3-5 Select search criteria (GCSN)

The screenshot shows the same list of document types as Figure 3-4. In this view, several checkboxes are selected and highlighted with orange boxes: 'Maintenance/Service Guide' in the second column, 'Service Guide/Manual' in the second column, 'User Guide' in the second column, 'CPMMap' in the third column, and 'Support Information' in the third column. The 'Support Communications' checkbox in the first column is also highlighted with an orange box.

- Select **Submit**.
- If needed, click **Back To selection Criteria** and narrow your search (the maximum allowed search result is 100 documents).



**NOTE:** Do not select the **Top Issue** option unless you only want to view top issues for that model. All other available content is filtered out.

**Table 3-2** Information type selections

Technical information type	Select this checkbox
Control panel message document (CPMD)	CPMD-Map
List of all CPMDs per product	Support Information
Installation Guide or Hardware Install Guide	Maintenance/Service Guide or Install Guide
Service cost document	Install Guide or Service Guide/Manual
Service guide or Service manual	Service Guide/Manual
Self-solve or troubleshooting document	Support Information
User manual or User guide	User Guide
Warranty and Legal Guide	Warranty Statement

# Troubleshooting process

Learn about the troubleshooting process.

## Determine the problem source

When the printer malfunctions or encounters an unexpected situation, the printer control panel alerts you to the situation. This section contains a pre-troubleshooting checklist to filter out many possible causes of the problem. A troubleshooting flowchart helps you diagnose the root cause of the problem. The remainder of this chapter provides steps for correcting problems.

- Use the troubleshooting flowchart to pinpoint the root cause of hardware malfunctions. The flowchart guides you to the section of this chapter that contains steps for correcting the malfunction.

Before beginning any troubleshooting procedure, check the following issues:

- Are supply items within their rated life?
- Are supply items Genuine HP supplies?
- Does the configuration page reveal any configuration errors?



**NOTE:** The customer or service provider is responsible for checking supplies and for using supplies that are in good condition.

---

## Power subsystem

Learn about the power subsystem.

## Power-on checks

The basic printer functions should start up when the printer is connected into an electrical outlet and the power switch is pushed to the *on* position. If the printer does not start, use the information in this section to isolate and solve the problem.

If the control-panel display remains blank, random patterns display, or asterisks remain on the control-panel display, perform power-on checks to find the cause of the problem.

## Power-on troubleshooting overview

If the control panel is blank 1 minute after turning on the printer, check the following items:

During normal operation, a cooling fan begins to spin briefly after the printer power is turned on. Place your hand over the vents at the rear of the printer, next to the formatter, or on the rear of the scanner. If the fan is operating, you will feel air passing out of the printer. You can lean close to the printer and hear the fan operating.

A fan begins to blow on the right door (fuser), and then the control panel goes through a series of set up functions. The main motor turns on (unless the left door or cartridge access door is open, a jam condition is sensed, or the paper-path sensors are damaged). You might be able to visually and audibly determine if the main motor is turned on.

If the fan and main motor are operating correctly, the next troubleshooting step is to isolate print engine, formatter, and control panel problems.

1. Make sure that the printer is connected directly into an active electrical outlet (not a power strip) that delivers the correct voltage.
2. Make sure that the power switch is in the *on* position, and then verify that the LED is on.
3. Make sure that the fan runs briefly, which indicates that the power supply is operational.
4. Depress the button on the back of the control panel to test the control panel functionality.
5. Make sure that the control-panel display wire harness is connected.
6. Remove any external solutions, and then try to turn the printer on again.

## Troubleshooting a blank display, black display, no display, or no power situation

Customers usually report that the control-panel display is not showing anything. It is very important to collect as much information as possible from the customer about the issue to help resolve it.

Following are some printer behaviors the customer might encounter:

- The control panel is completely blank (no LEDs or back light).
- The control panel is blank, but there might be LEDs illuminated.
- The control panel is blank (LEDs are on or flashing) and the back light is on (but no text visible).

Following are some possible causes of a blank control-panel display:

- No power to the printer.
- The control panel contrast setting is not correctly adjusted.
- The formatter connector(s) are not fully seated into the connector(s) on the DC controller, or the connectors are not fully seated on the formatter.
- A faulty component is installed on the formatter (for example a memory DIMM, fax PCA, network PCA, USB device, or other component).
- The formatter is defective.
- The control panel connector is not fully seated, or the control panel is defective.
- The DC controller is defective.

Following are some questions to ask the customer:

- Was the printer newly install or has the printer been properly functioning?
  - For a new install, investigate to see if there was any shipping damage to the printer.
  - Did the customer notice any damage to the shipping box or any visible damage to the printer?
- What happened just prior to the control panel going blank?
  - Was the printer serviced recently, a power outage occurred?
  - Has a lightning storm recently occurred?
  - Did the customer recently add a memory DIMM or install a third-party component?
- Make sure to get a complete description of the failure.
  - Is the control-panel display completely blank (might be faint text and no back light)?
  - Is the control-panel display back light on?
  - Has a print job been sent to the printer? The customer might report that their print jobs seemed to print but when they go to the printer the control-panel display is blank.

## Recommended actions

If the control-panel display is completely blank (no LEDs illuminated or no back light) check to see if the printer is getting power. Listen for fans or any printer initialization sounds when the power is turned on.



If there are no signs of power, then perform the following:

1. Make sure that the printer is plugged directly into an active electrical outlet (not a power strip or uninterruptible power supply) that delivers the correct voltage.

---

 **TIP:** Try using a different power cable if possible.

---

2. Turn the printer power on, and make sure that the fan(s) run briefly (this indicates that the power supply is operational).
3. Check if the yellow LED on formatter is flashing. If so, there is a communication issue between the formatter and the control panel.
4. Turn the printer power off.
5. Make sure that the control-panel display wire harness (and/or flat cable) is properly connected (and fully seated), and then turn the printer power on again.
6. Check control panel diagnostics by pressing the button on the back of the control panel to run different diagnostic tests.
7. Verify the status LEDs are illuminated, but the control-panel display is blank. If applicable: Check if the contrast setting is adjusted to very low. If so, try turning the contrast knob to see if the control-panel display becomes visible.
8. From a host computer, send a print job to the printer.


---

 **NOTE:** If the print job correctly prints, then the problem is most likely to a defective control panel.

---

9. Turn the printer power off, and then make sure that the memory DIMM is installed in the correct slot and is fully seated.

---


 **NOTE:** For some printers, there may be more than one memory DIMM installed. Some printers have third-party solutions/applications or fonts that use memory.

---

10. Remove all of the components/accessories installed on the formatter (for example, hard drive, solid-state drive, memory DIMM(s), fax PCA, network PCA, USB devices, or other devices).

- Make sure that the formatter is fully seated.

---

 **IMPORTANT:** This is important because the formatter or a component on the formatter might be defective or shorted, which causes the printer to lose power.


---

11. Reinstall the formatter. Make sure that it makes a good connection and is fully seated.

Make sure that all of the connectors on the formatter are correctly connected and fully seated.

12. Turn the printer power on, and then check the control-panel display.
13. If the printer control panel is properly working, replace each removed component (one at a time) to determine which one is causing the problem.

---

 **CAUTION:** Turn the printer power off, and then on again, after replacing a component on the formatter.

---

14. If the control-panel display is still blank after performing the above troubleshooting steps, and the control panel diagnostics do not function, replace the control panel. If the control panel diagnostics are functioning, then replace the formatter.

## Control panel checks

Learn about the control panel checks.

## Control panel diagnostic flowcharts

Learn about the control panel diagnostic flowcharts.

Use the flowcharts in this section to troubleshoot the following control panel problems.

- Touchscreen is blank, white, or dim (no image).
- Touchscreen is slow to respond or requires multiple presses to respond.
- Touchscreen has an unresponsive zone.
- No control panel sound.
- [Home](#) button is unresponsive.
- Hardware integration pocket (HIP) is not functioning (control panel functional).

### Touchscreen black, white, or dim (no image)

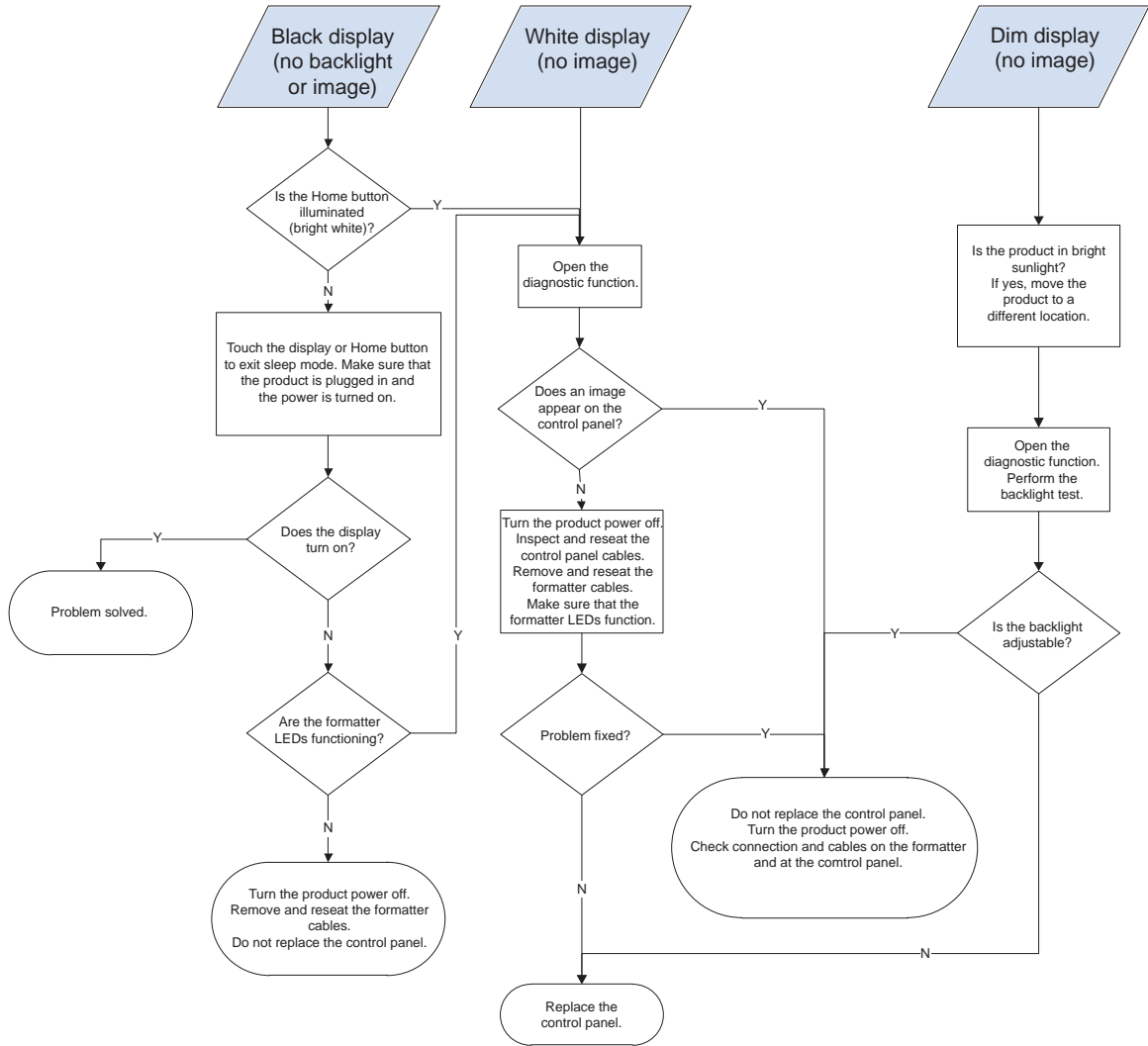
Learn about the touchscreen black, white, or dim (no image).



**NOTE:** To open the diagnostic function, press the button on the back of the control panel.

---

Figure 3-6 Touchscreen blank, white, or dim (no image)

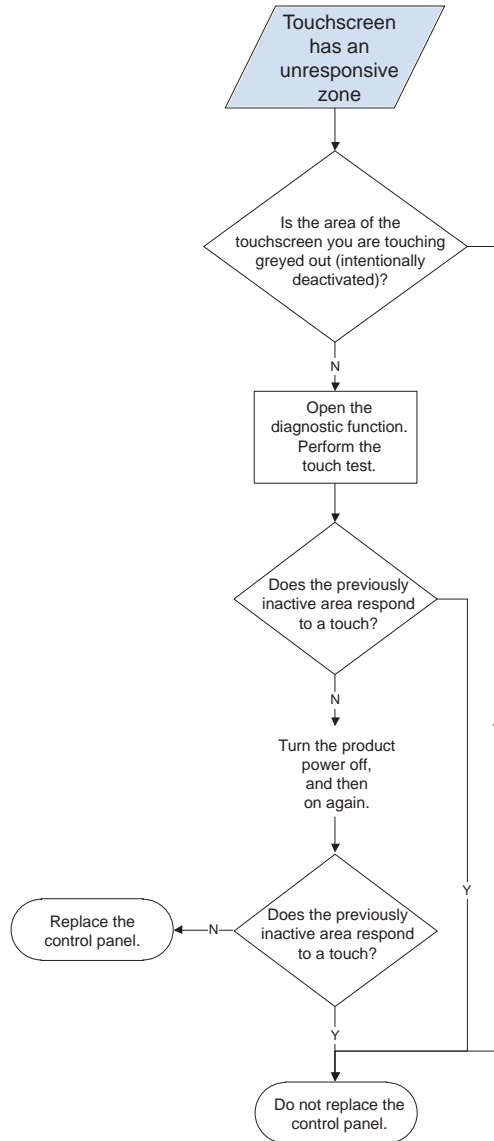


### Touchscreen has an unresponsive zone

Learn about how the touchscreen has an unresponsive zone.

**NOTE:** To open the diagnostic function, press the button on the back of the control panel.

Figure 3-7 Touchscreen has an unresponsive zone

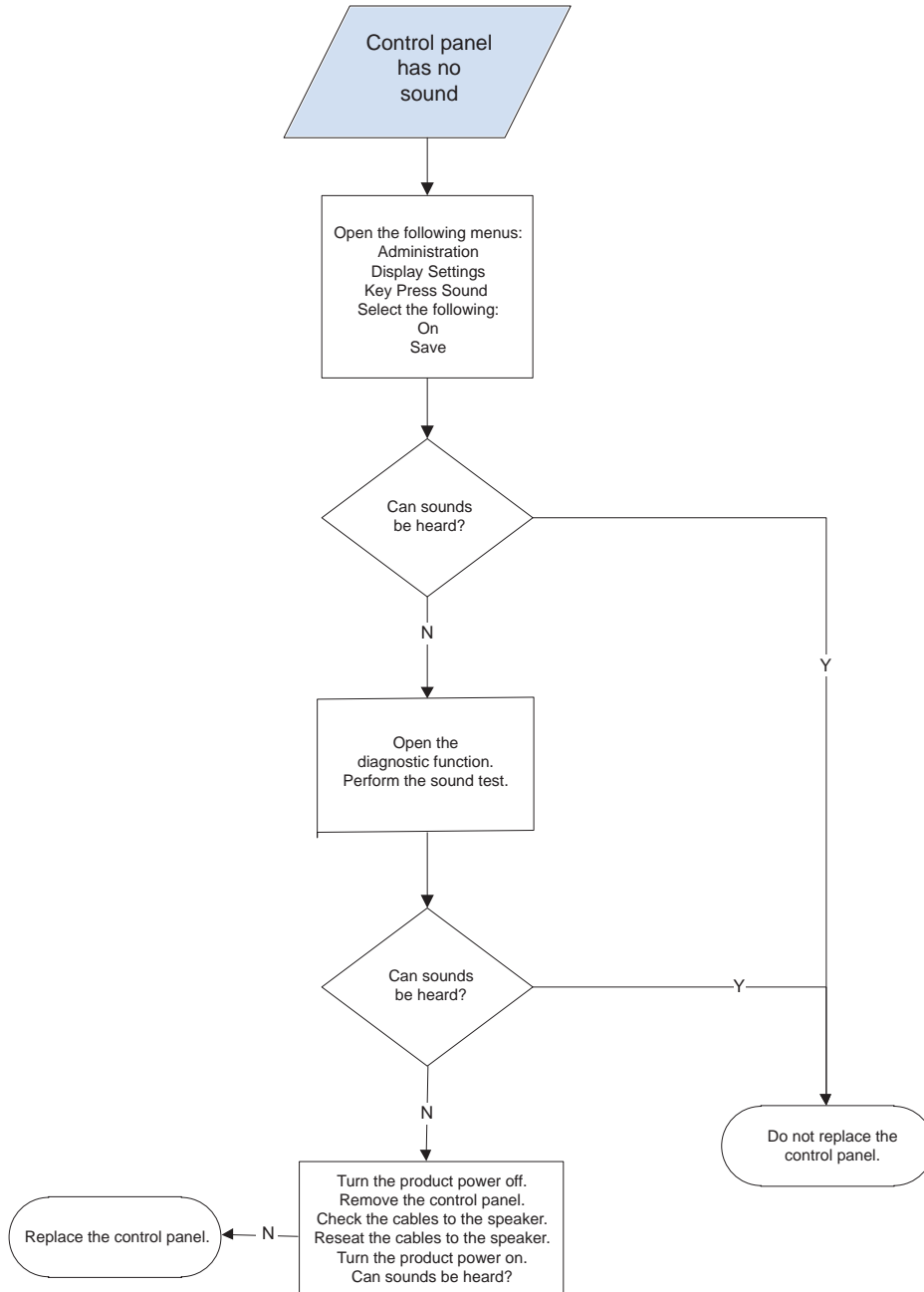


### No control panel sound

Learn what to do when there is no control panel sound.

 **NOTE:** To open the diagnostic function, press the button on the back of the control panel.

Figure 3-8 No control panel sound



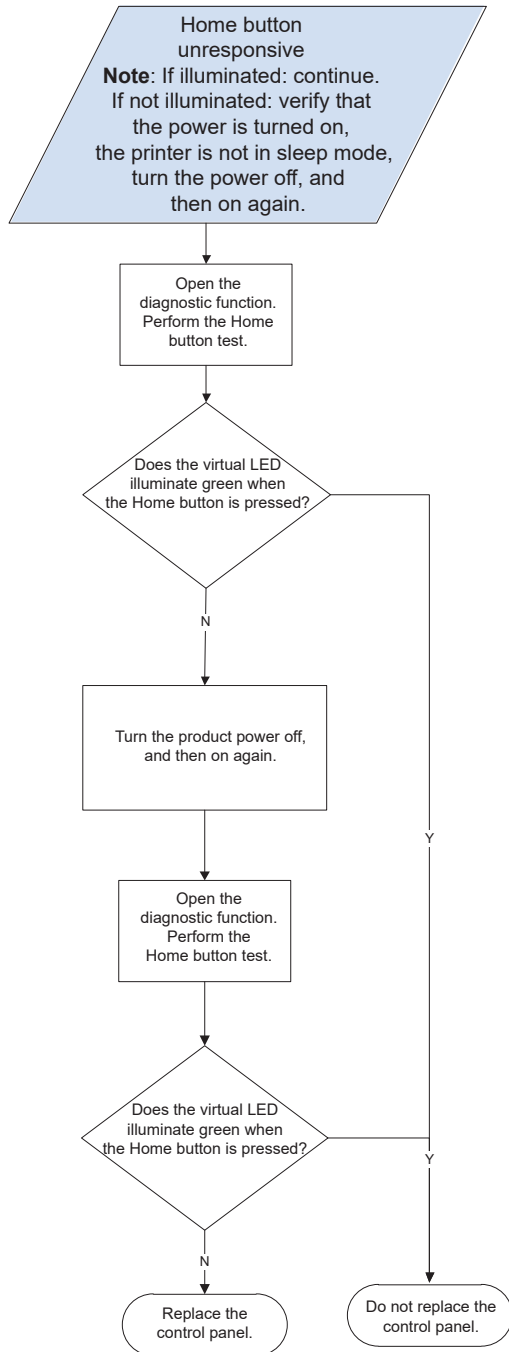
### Home button is unresponsive

Learn what to do when the home button is unresponsive.



**NOTE:** To open the diagnostic function, press the button on the back of the control panel.

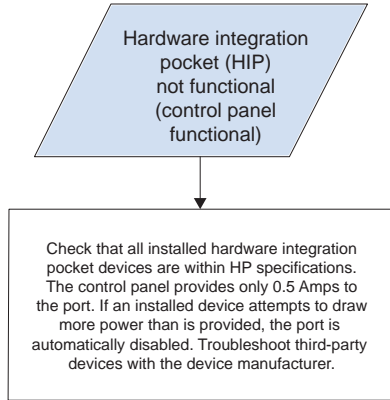
Figure 3-9 Home button is unresponsive



### Hardware integration pocket (HIP) is not functioning (control panel functional)

Learn about when the hardware integration pocket (HIP) is not functioning (control panel functional).

Figure 3-10 Hardware integration pocket (HIP) is not functioning (control panel functional)





## Individual component diagnostics

Learn about individual component diagnostics.

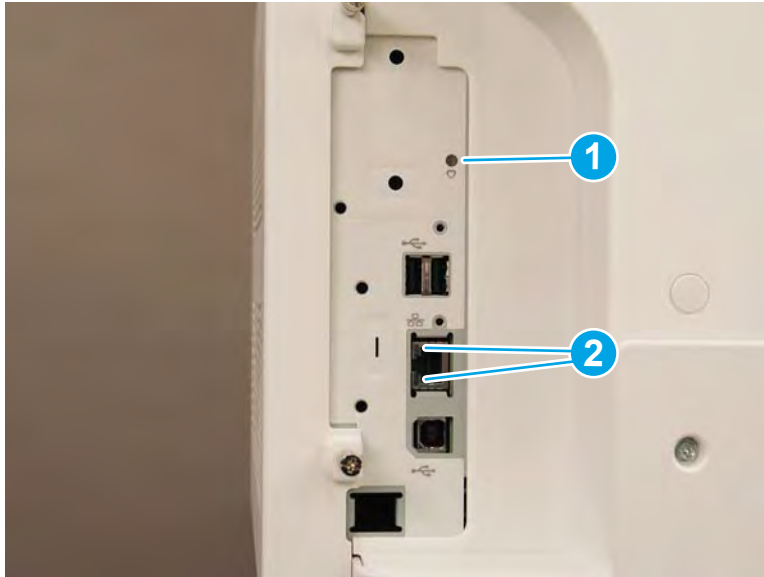
### Tools for troubleshooting: LED diagnostics

LED, engine, and individual diagnostics can identify and troubleshoot printer problems.

## Understand lights on the formatter

Three LEDs on the formatter indicate that the printer is functioning correctly.

Figure 3-11 LEDs



- 
- |   |                   |
|---|-------------------|
| 1 | Heartbeat LED     |
| 2 | HP Jetdirect LEDs |
- 

## HP Jetdirect LEDs

Learn about the HP Jetdirect LEDs.

The embedded HP Jetdirect print server has two LEDs. The yellow LED indicates network activity, and the green LED indicates the link status. A blinking yellow LED indicates network traffic. If the green LED is off, a link has failed.

For link failures, check all the network cable connections. In addition, try to manually configure the link settings on the embedded print server by using the printer control-panel menus.

1. From the Home screen on the printer control panel, select **Settings**.
2. Open the following menus:
  - **Networking**
  - **Ethernet**
  - **Link Speed**
3. Select the appropriate link speed, and then select **OK**.

### Tools for troubleshooting: Engine diagnostics

The printer contains extensive internal engine diagnostics that help in troubleshooting print quality, paper path, noise, assembly, and timing issues.

## Defeating interlocks

Different tests can be used to isolate different types of issues. For assembly or noise isolation, run the diagnostic test when the toner cartridge door or right door is open.

Defeating the door interlocks allows observation of the paper pick operation (and view the page enter registration).

**⚠ WARNING!** Be careful when performing printer diagnostics to avoid risk of injury. Only trained service personnel should open and run the diagnostics with a door open. Never touch any of the power supplies when the printer is turned on.

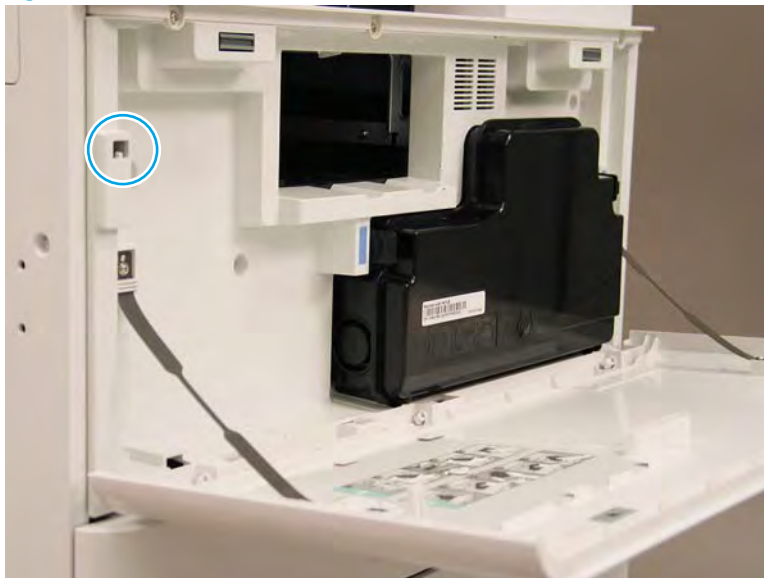
### Defeat the toner cartridge door interlock

Learn how to defeat the toner cartridge door interlock.

1. Open the toner cartridge door.
2. Insert a folded piece of paper into the slot.

**💡 TIP:** Fold a stiff piece of paper, for example a business card or index card, into two 10 mm (.375 in) strips, and insert the strips into the slot for the cartridge door logic switches.

**Figure 3-12** Defeat the toner cartridge door interlock




### Defeat the front door interlock

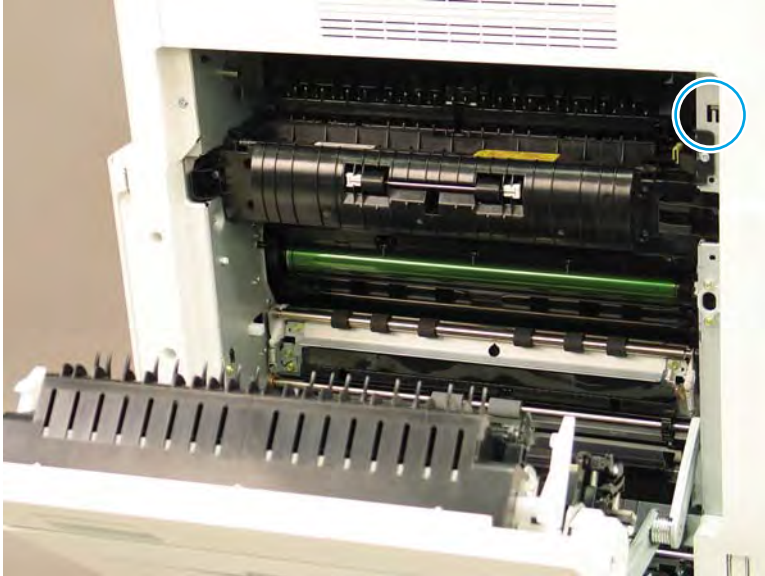
Learn how to defeat the front door interlock.

1. Open the front door.

2. Insert a folded piece of paper into the slot.

 **TIP:** Fold a stiff piece of paper, for example a business card or index card, into two 10 mm (.375 in) strips, and insert the strips into the slot for the front door logic switches.

**Figure 3-13** Defeat the front door interlock



## Tools for troubleshooting

Use the procedure below to test various printer mechanical and electromechanical assemblies.

### Individual component diagnostics (special-mode test)

Learn about the individual component diagnostics (special-mode test).

This test activates individual parts independently to isolate problems.

Each component test can be performed once or repeatedly.

Each component test can be performed once or repeatedly.



---

**NOTE:** The cartridge door interlocks must be defeated to run the component tests.

---

1. From the Home screen on the printer control panel, scroll to and touch the [Support Tools](#) button.
2. Select one of the following tests:
  - [Continuous Scan](#)
  - [Run Fax Test](#)
3. Select the component test options for the test.

# Tools for troubleshooting

Learn about tools for troubleshooting.



## Problem-solving checklist

Follow these steps when trying to solve a problem with the printer.

### Step 1: Check that the printer power is on

Learn how to check that the printer power is on.

1. Make sure that the printer is plugged in and turned on. The power button should be lit with a white light. If it is not, press the power button. If the power button does not light up, check the following conditions.
  - Make sure that the power cable is connected to the printer and the outlet.
  - Check the power source by connecting the power cable to a different outlet.
2. If the printer motors do not rotate, make sure that the toner cartridges are installed and that the doors are all closed. The control panel displays messages to indicate these problems.


### Step 2: Check the control panel for error messages

Learn how to check the control panel for error messages.

The control panel should indicate ready status. If an error message appears, resolve the error.

Print a supplies status page to ensure that the supplies are not at or over end of life.

---

 **NOTE:** HP long-life consumable and maintenance kit life specifications are estimations. Actual individual life or yield during normal use will vary depending on usage, environment, media, and other factors. Estimated life is not an implied warranty.

---

### Step 3: Test print functionality

Learn how to test print functionality.

1. From the control panel Home screen, touch the [Reports](#) button.
2. Open the [Reports](#) menu, touch the [Configuration/Status Pages](#) menu, select the [Configuration Page](#) item, and then touch the [Print](#) button to print the report.
3. If the report does not print, make sure that paper is loaded in the tray, and check the control panel to see if paper is jammed inside the printer.

---

 **NOTE:** Make sure that the paper in the tray meets specifications for this printer.

---

### Step 4: Test copy functionality

Learn how to test copy functionality.

1. Place the configuration page into the ADF and make a copy. If paper does not feed smoothly through the ADF, you might need to clean the ADF rollers and separation pad. Make sure that the paper meets specifications for this printer.
2. Place the configuration page onto the scanner glass and make a copy.
3. If the print quality on the copied pages is not acceptable, clean the scanner glass and the small glass strip.

## Step 5: Test the fax sending functionality

Learn how to test the fax sending functionality.

1. From the control panel Home screen, touch the [Support Tools](#) button.
2. Open the [Troubleshooting](#) menu, and then open the [Diagnostics Tools](#) menu. Touch the [Run Fax Test](#) button to test the fax functionality.
3. Touch the [Fax](#) on the printer control panel, and then touch the [Start Fax](#) button.

## Step 6: Test the fax receiving functionality

Learn how to test the fax receiving functionality.

1. From the control panel Home screen, touch the [Support Tools](#) button.
2. Touch the [Troubleshooting](#) menu, and then open the [Diagnostics Tests](#) menu. Touch the [Run Fax Test](#) button to test the fax functionality.
3. Use another fax machine to send a fax to the printer.
4. Review and reset the printer fax settings.

## Step 7: Try sending a print job from a computer

Learn how to try sending a print job from a computer.

1. Use a word-processing program to send a print job to the printer.
2. If the job does not print, make sure that you selected the correct printer driver.
3. Uninstall and then reinstall the printer software.

## Step 8: Test the Plug and Print USB Drive printing functionality

Learn how to test the plug and print USB drive printing functionality.

1. Load a .PDF document or .JPEG photo onto a USB flash drive, and insert it in the USB port near the control panel.
2. The [USB Flash Drive](#) menu opens. Try printing the document or photo.
3. If no documents are listed, try a different type of USB flash drive.

## Factors that affect printer performance

Several factors affect the time it takes to print a job:

- The software program that you are using and its settings
- The use of special paper (such as heavy paper or custom-size paper)
- Printer processing and download time
- The complexity and size of graphics
- The speed of the computer you are using
- The USB or network connection

- Whether the printer is printing in color or in monochrome
- The type of USB drive, if you are using one
- Environmental factors, such as low temperature or high humidity

## Print menu map

Learn how to print the menu map.

To more easily navigate individual settings, print a report of the complete [Reports](#) menu.

1. From the [Home](#) screen on the printer control panel, scroll to and touch the [Reports](#) button.
2. Open the [Configuration/Status Pages](#) menu.
3. Select the [Settings Menu Map](#) option.
4. Touch the [Print](#) button to print the report.

---

 **TIP:** Multiple report pages can be selected, and then printed together.

---


## Print current settings pages

Learn how to print current settings pages.

Printing the current settings page provides a map of the user configurable settings that might be helpful in the troubleshooting process.

1. From the [Home](#) screen on the printer control panel, scroll to and touch the [Reports](#) button.
2. Open the [Configuration/Status Pages](#) menu.
3. Select the [Current Settings Page](#) option.
4. Touch the [Print](#) button to print the report.

---

 **TIP:** Multiple report pages can be selected, and then printed together.

---

## Print event log

Printing the event log might be helpful in the troubleshooting process. For more information, see the Interpret control-panel messages and event log entries section in the printer troubleshooting manual.

### Print the event log from the Reports menu from a touchscreen control panel

Learn how to print the event log from the Reports menu from a touchscreen control panel.

1. From the [Home](#) screen on the printer control panel, scroll to and touch the [Support Tools](#) button.
2. Open the following menus:
  - [Troubleshooting](#)
  - [Event Log](#)
3. The event log displays on the screen. To print it, touch the [Print](#) button.

### Print the event log from the Service menu from a touchscreen control panel

Learn how to print the event log from the Service menu from a touchscreen control panel.

1. From the [Home](#) screen on the printer control panel, scroll to and touch the [Support Tools](#) button.
2. Open the [Service](#) menu.
3. Enter the following service access code for the printer:
  - Access code: 04082517
4. Touch the [Event Log](#) item.

### Clear the event log from a touchscreen control panel

Learn how to clear the event log from a touchscreen control panel.

1. From the [Home](#) screen on the printer control panel, scroll to and touch the [Support Tools](#) button.
2. Open the [Service](#) menu.
3. On the sign-in screen, select the [Service Access Code](#) option from the drop-down list.
4. Enter the following service access code for the printer:
  - Access code: 04082517
5. Select the trash icon to clear the event log.

## Pre-boot menu options

The **Pre-boot** menus are available prior to the printer initializing.

**CAUTION:** The **Format Disk** option (printers with a hard-disk drive only) performs a disk initialization for the entire disk. The operating system, firmware files, and third party files (among other files) will be completely lost. HP does not recommend this action.

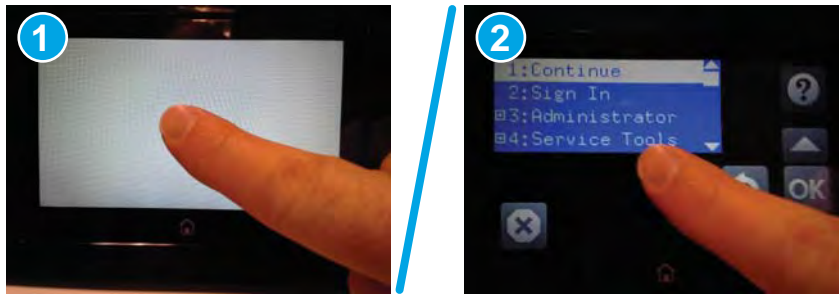
**TIP:** The Pre-boot menu can be remotely accessed by using a telnet network protocol to establish an administration connection to the printer. See [Remote Admin on page 800](#).

### Open the Pre-boot menu from a touchscreen control panel

Learn how to open the Pre-boot menu from a touchscreen control panel.

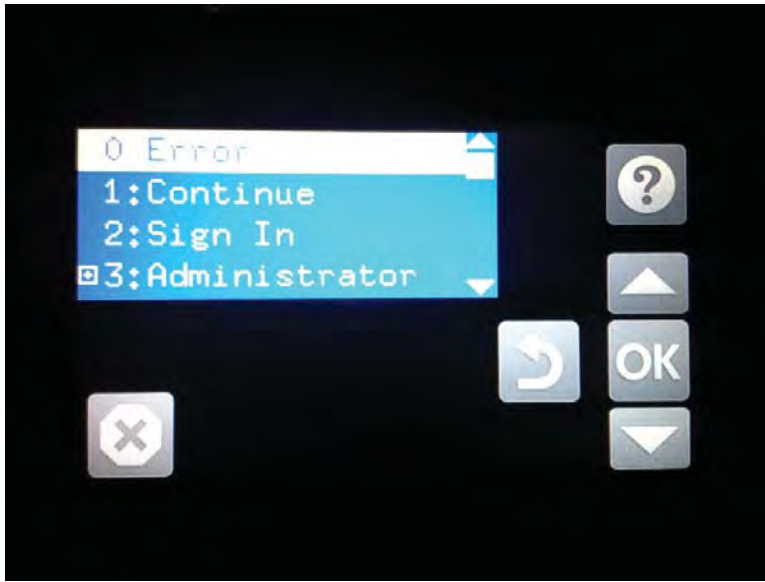
1. Touch the middle of the control-panel display when you see the **1/8** under the logo.

**Figure 3-14** Open the Pre-boot menu



2. On the **Pre-boot** menu screen, use the following buttons to navigate the tests.

**Figure 3-15** Pre-boot menu



Use this button to see more information about a selected item.



Use this button to scroll up through menu items.



Use this button to select a highlighted menu item.



Use this button to scroll down through menu items.



Use this button to go back to the previous menu.



Not used.



Use this button to exit a diagnostic test.

3. Use the arrow buttons on the touchscreen to navigate the [Pre-boot](#) menu.
4. Touch the [OK](#) button to select a menu item.

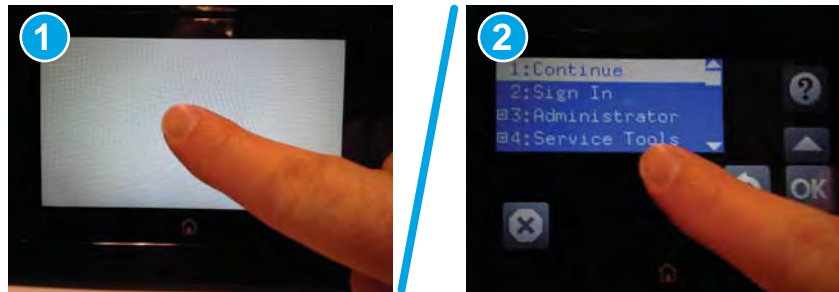
## Cold reset using the Pre-boot menu from a touchscreen control panel

Learn how to cold reset using the Pre-boot menu from a touchscreen control panel.

**CAUTION:** This procedure resets all printer configurations and settings to factory defaults (customer configurations and settings are lost).

1. Touch the middle of the control-panel display when you see the [1/8](#) under the logo.

**Figure 3-16** Open the Pre-boot menu



2. Use the ▼ button to highlight the [+3:Administrator](#) item, and then touch the [OK](#) button.
3. Use the ▼ button to highlight the [+8:Startup Options](#) item, and then touch the [OK](#) button.
4. Use the ▼ button to highlight the [2 Cold Reset](#) item, and then touch the [OK](#) button to select it.
5. Touch the Home button to return to the main [Pre-boot](#) menu and highlight the [1:Continue](#) item, and then touch the [OK](#) button.

**NOTE:** The printer will initialize.

**NOTE:** Some of the pre-boot options in the following tables are not supported by the current version of the printer firmware and are included for information only. Future versions of firmware will support these options.

**Table 3-3** Pre-boot menu options (1 of 7)

Menu option	First level	Second level	Third level	Description
<a href="#">Continue</a>				<p>Selecting the <a href="#">Continue</a> item exits the <a href="#">Pre-boot</a> menu and continues the normal boot process.</p> <p>If a selection is not made in the initial menu within 30 seconds, the printer returns to a normal boot (the same as selecting <a href="#">Continue</a>).</p> <p>If the user navigates to another menu, the timeout does not apply.</p>
<a href="#">Sign In</a>				Enter the administrator PIN or service PIN if one is required to open the <a href="#">Pre-boot</a> menu.
<a href="#">Administrator</a>				<p>This item navigates to the <a href="#">Administrator</a> submenus.</p> <p>If authentication is required (and the user is not already signed in) the <a href="#">Sign In</a> prompt displays. The user is required to sign in.</p>

**Table 3-3** Pre-boot menu options (1 of 7) (continued)

Menu option	First level	Second level	Third level	Description
	Download	Network USB USB Thumbdrive		This item initiates a Pre-boot firmware download process. A USB Thumbdrive option will work on all FutureSmart printers. USB or Network connections are not currently supported.
	Format Disk			This item reinitializes the disk and cleans all disk partitions.  <b>CAUTION:</b> Selecting the <a href="#">Format Disk</a> item removes <b>all</b> data. A delete confirmation prompt is <b>not</b> provided.  The system is <b>not</b> bootable after this action and a <b>99.09.67</b> error displays on the control panel. A firmware download must be performed to return the system to a bootable state.
	Partial Clean			This item reinitializes the disk (removing all data except the firmware repository where the master firmware bundle is downloaded and saved).  <b>CAUTION:</b> Selecting the <a href="#">Partial Clean</a> item removes <b>all</b> data except the firmware repository. A delete confirmation prompt is <b>not</b> provided.  <b>CAUTION:</b> This procedure resets all printer configurations and settings to factory defaults (customer configurations and settings are lost).  This allows a user to reformat the disk by removing the firmware image from the active directory without having to download new firmware code (printer remains bootable).
	Change Password			Select this item to set or change the administrator password.
	Clear Password			Select the <a href="#">Clear Password</a> item to remove a password from the <a href="#">Administrator</a> menu. Before the password is actually cleared, a message will be shown asking to confirm that the password should be cleared. Press the <a href="#">OK</a> button to confirm the action.  When the confirmation prompt displays, press the <a href="#">OK</a> button to clear the password.

**Table 3-4** Pre-boot menu options (2 of 7)

Menu option	First level	Second level	Third level	Description
Administrator  (continued)	Manage Disk	Clear disk		Select the <a href="#">Clear disk</a> item to enable using an external device for job storage. Job storage is normally enabled only for the Boot device. This will be grayed out unless the <b>99.09.68</b> error is displayed.



**Table 3-4** Pre-boot menu options (2 of 7) (continued)

Menu option	First level	Second level	Third level	Description
		Lock Disk		<p>Select the <a href="#">Lock Disk</a> item to lock (mate) a new secure disk to this printer.</p> <p>The secure disk already locked to this printer will remain accessible to this printer. Use this function to have more than one encrypted disk accessible by the printer when using them interchangeably.</p> <p>The data stored on the secure disk locked to this printer always remains accessible to this printer.</p>
		Leave Unlocked		<p>Select the <a href="#">Leave Unlocked</a> item to use a new secure disk in an unlocked mode for a single service event. The secure disk that is already locked to this printer will remain accessible to this printer and uses the old disk's encryption password with the new disk.</p> <p>The secure disk that is already locked to this printer remains accessible to this printer.</p>
		Clear Disk Pwd		<p>Select the <a href="#">Clear Disk Pwd</a> item to continue using the non-secure disk and clear the password associated with the yet-to-be installed secure disk.</p> <p><b>CAUTION:</b> Data on the missing secure disk will be permanently inaccessible.</p>
		Retain Password		<p>Select the <a href="#">Retain Password</a> item to use the non-secure disk for this session only, and then search for the missing secure disk in future sessions.</p>
		Boot Device	Secure Erase	<p>Select the <a href="#">Secure Erase</a> item to erase all of the data on the disk and unlock it if required.</p> <p>This might take a long time.</p> <p><b>NOTE:</b> The system will be unusable until the system files are reinstalled. The ATA secure-erase command is a one-pass overwrite, which erases the entire disk including firmware. The disk remains an encrypted disk.</p>
			Erase/Unlock	<p>Select the <a href="#">Erase/Unlock</a> item to cryptographically erase all data on the disk and unlock the disk to allow a user to gain access to it from any printer.</p> <p><b>NOTE:</b> The system will be unusable until the system files are reinstalled. It erases the encryption key. The encryption key is erased, so the disk becomes a non-encrypted disk.</p>
			Get Status	<p>This item provides disk status information if any is available.</p>

**Table 3-5** Pre-boot menu options (3 of 7)

Menu option	First level	Second level	Third level	Description
Administrator (continued)	Manage Disk (continued)	Internal Device		<p>Select the <a href="#">Internal Device</a> item to erase the internal device or get a status about the internal device.</p>

**Table 3-5** Pre-boot menu options (3 of 7) (continued)

Menu option	First level	Second level	Third level	Description
			Secure Erase	Select the <a href="#">Secure Erase</a> item to erase all of the data on the disk and unlock it if required.  This might take a long time.  <b>NOTE:</b> The system will be unusable until the system files are reinstalled. The ATA secure-erase command erases the entire disk, including firmware. The disk remains an encrypted disk.
			Erase/Unlock	Select the <a href="#">Erase/Unlock</a> item to cryptographically erase all of the data on disk and unlock the disk to allow the user to gain access to it from any printer.  <b>NOTE:</b> The system will be unusable until the system files are reinstalled. The HP High Performance Secure Hard Disk is erased.
			Get Status	This item provides disk status information if any is available.
		External Device		Select the <a href="#">External Device</a> item to erase the external device or get status about the external device.
			Secure Erase	Select the <a href="#">Secure Erase</a> item to erase all of the data on the disk and unlock it if required.  This might take a long time.  <b>NOTE:</b> The system will be unusable until the system files are reinstalled.  The ATA secure-erase command erases the entire disk, including firmware. The disk remains an encrypted disk.
			Erase/Unlock	Select the <a href="#">Erase/Unlock</a> item to cryptographically erase all of the data on disk and unlock the disk to allow a user to gain access to it from any printer.  <b>NOTE:</b> The system will be unusable until the system files are reinstalled. The encryption key is erased, so the disk becomes a non-encrypted disk.
			Get Status	This item provides disk status information if any is available.

**Table 3-6** Pre-boot menu options (4 of 7)

Menu option	First level	Second level	Third level	Description
Administrator	Configure LAN	IP Mode [DHCP]		The network can be configured to obtain the network settings from a DHCP server or as static.  Use this item for automatic IP address acquisition from the DHCP server.
(continued)	<b>NOTE:</b> This configuration is only active when the Pre-boot menu is open.	IP Mode [STATIC]		Use this item to manually assign the network addresses.
			IP Address	Use this item to manually enter the IP addresses.
			Subnet Mask	Use this item to manually enter the subnet mask.
			Default Gateway	Use this item to manually enter the default gateway.
			Save	Select the <a href="#">Save</a> item to save the manual settings.

**Table 3-7** Pre-boot menu options (5 of 7)

Menu option	First level	Second level	Third level	Description	
Administrator (continued)	Startup Options			Select the <a href="#">Startup Options</a> item to specify options that can be set for the next time the printer is turned on and initializes to the <b>Ready</b> state.	
			<a href="#">Show Revision</a>	<b>Not currently functional:</b> Select the <a href="#">Show Revision</a> item to allow the printer to initialize and show the firmware version when the printer reaches the <b>Ready</b> state.  Once the printer power is turned on the next time, the <a href="#">Show Revision</a> item is unchecked so that the firmware revision is not shown.	
			<a href="#">Cold Reset</a>	Select the <a href="#">Cold Reset</a> item to clear the IP address and all customer settings. (This item also returns all settings to factory defaults.)  <b>NOTE:</b> Items in the <a href="#">Service</a> menu are not reset.	
			<a href="#">Skip Disk Load</a>	Select the <a href="#">Skip Disk Load</a> item to disable installed third-party applications.	
			<a href="#">Skip Cal</a>	Select the <a href="#">Skip Cal</a> item to skip the printer calibration for the very next power-initialization cycle only.	
			<a href="#">Lock Service</a>	<b>CAUTION:</b> Select the <a href="#">Lock Service</a> item to lock the <a href="#">Service</a> menu access (both in the <a href="#">Pre-boot</a> menu and the <a href="#">Device Maintenance</a> menu).  Service personnel must have the administrator remove the <a href="#">Lock Service</a> setting before they can open the <a href="#">Service</a> menu.	
			<a href="#">Skip FSCK</a>	Select the <a href="#">Skip FSCK</a> item to disable Chkdisk/ScanVolume during startup.	
Administrator (continued)	Startup Options (continued)	First Power		<b>Not currently functional:</b> This item allows the printer to initialize as if it is the first time it has been turned on.  For example, the user is prompted to configure first-time settings like date/time, language, and other settings.  Select this item so that it is enabled for the next time the printer power is turned on.  When the printer power is turned on the next time, this item is unchecked so that the pre-configured settings are used during configuration, and the first-time setting prompt is not used.	
				<a href="#">Embedded Jetdirect Off</a>	Select the <a href="#">Embedded Jetdirect Off</a> item to disable the embedded HP Jetdirect.  By default this item is unchecked so that HP Jetdirect is always enabled.
				<a href="#">WiFi Accessory</a>	Select the <a href="#">WiFi Accessory</a> item to enable the wireless accessory.

**Table 3-8** Pre-boot menu options (6 of 7)

Menu option	First level	Second level	Third level	Description
Administrator (continued)	Diagnostics			Diagnostic items are useful to diagnose hardware components and their interface connections. Use these items to troubleshoot specific hardware components, and the interface between them and other components.
		Memory	Do Not Run	Use the <b>Do Not Run</b> item to exclude the <b>Memory</b> diagnostic when executing multiple diagnostics.
			Short	Use the <b>Short</b> item to select a brief memory test.  <b>NOTE:</b> This test requires about four minutes to execute.
			Long	Use the <b>Long</b> item to select an extended memory test.  <b>NOTE:</b> This test requires about twenty minutes to execute.
		Disk	Do Not Run	Use the <b>Do Not Run</b> item to exclude the <b>Disk</b> diagnostic when executing multiple diagnostics.
			Short	Use the <b>Short</b> item to select a brief firmware self-test.  <b>NOTE:</b> This test requires about two or three minutes to execute.
			Long	Use the <b>Long</b> item to select an extended firmware self-test.  <b>NOTE:</b> This test requires about sixty minutes to execute.
			Optimized	Use the <b>Optimized</b> item to select a test that checks the active sectors on the disk.  <b>NOTE:</b> This test requires about thirty minutes to execute.
			Raw	Use the <b>Raw</b> item to select a test that checks every sector on the disk.  <b>NOTE:</b> This test requires about fifty minutes to execute.
			Smart	Use the <b>Smart</b> item to select a very brief test that checks the drive self-monitoring analysis and reporting technology (SMART) status—the drive detects and reports reliability indicators to help anticipate disk failures (SMART status).
		CPB		Use the <b>CPB</b> item to verify the integrity of the copy processor board (CPB) and the formatter PCA connections.

**Table 3-8** Pre-boot menu options (6 of 7) (continued)

Menu option	First level	Second level	Third level	Description
		Interconnect		Use the <a href="#">Interconnect</a> item to verify the integrity of the interconnect PCA (ICB) and its connections.
		Run Selected		Select the <a href="#">Run Selected</a> item to execute a selected test.  <b>NOTE:</b> If more than one test is selected, they are executed in sequence.

**Table 3-9** Pre-boot menu options (7 of 7)

Menu option	First level	Second level	Third level	Description
Administrator  (continued)	Remote Admin	Start Telnet		The <a href="#">Remote Admin</a> item allows a service technician to access to the printer Pre-boot menu remotely, and to navigate the menu selections from a remote location.  <b>IMPORTANT:</b> A Remote Admin connection must be initiated by a person that is physically present at the printer.  This person will also need to provide a randomly generated PIN to the remote service technician.  <b>NOTE:</b> For more information about using the <a href="#">Remote Admin</a> function, see <a href="#">Remote Admin on page 800</a> .
		Stop Telnet		
		Refresh IP		
	System Triage	Copy Logs		If the device will not boot to the <b>Ready</b> state, or the diagnostic log feature found in the <a href="#">Troubleshooting</a> menu is not accessible, then use the <a href="#">System Triage</a> item to copy the diagnostic logs to a USB flash drive at the next printer start up.  The files can then be sent to HP to help diagnose the problem.
	Change Svc PWD			Use this item to change the <a href="#">Service</a> menu personal identification number (PIN).
	Reset Svc PWD			If the <a href="#">Service</a> menu personal identification number (PIN) has been changed. Use this item to reset it to the original PIN.
Service Tools	Reset Password			Use this item to reset the Pre-boot administrator password.
	Subsystems			For manufacturing use only. Do not change these values.
Developer Tools	Netexec			

## Remote Admin

The Remote Admin feature allows remote access the printer Pre-boot menu (BIOS environment). The printer functions as a telnet server which uses the telnet networking protocol to transmit text data. Any computer (with telnet installed and enabled) can function as the telnet client to remotely display and interact with the Pre-boot menu.



---

**IMPORTANT:** While the Remote Admin function allows remote access the Pre-boot menu, for security reasons the Remote Admin connection must be initiated by a person that is physically present at the printer.

---

This section describes the following Remote Admin items.

## Required software and network connection


Before using the Remote Admin feature, make sure that the telnet network protocol is installed, and enabled, on the remote telnet client computer.

 **NOTE:** This section describes enabling and configuring the telnet feature for computers using a Windows® operating system.

HP recommends that the telnet client computer be a Windows based system, however, there are other operating systems that support the telnet network protocol. For information about enabling and configuring the telnet network protocol for other operating systems, see the owner's manual for that operating system.

## Telnet client

All computers using the Windows operating system have the telnet client installed, however, the telnet client function might not be enabled by default.

 **NOTE:** The figures and menus in this section are for the Windows 7 Enterprise® operating system. Screens and menu selections might vary slightly for other operating systems.

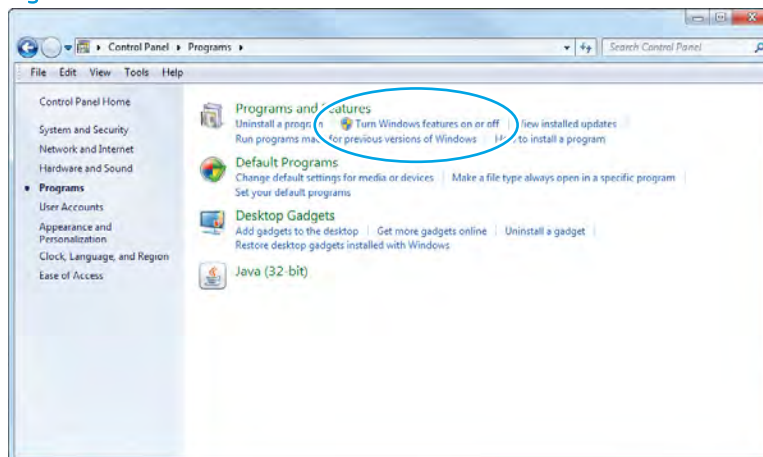
1. Use the **Start** menu to open the **Control Panel**, and then click the **Programs** item to select it.

Figure 3-17 Open the Control Panel




2. Click the **Turn Windows features on or off** item to select it.

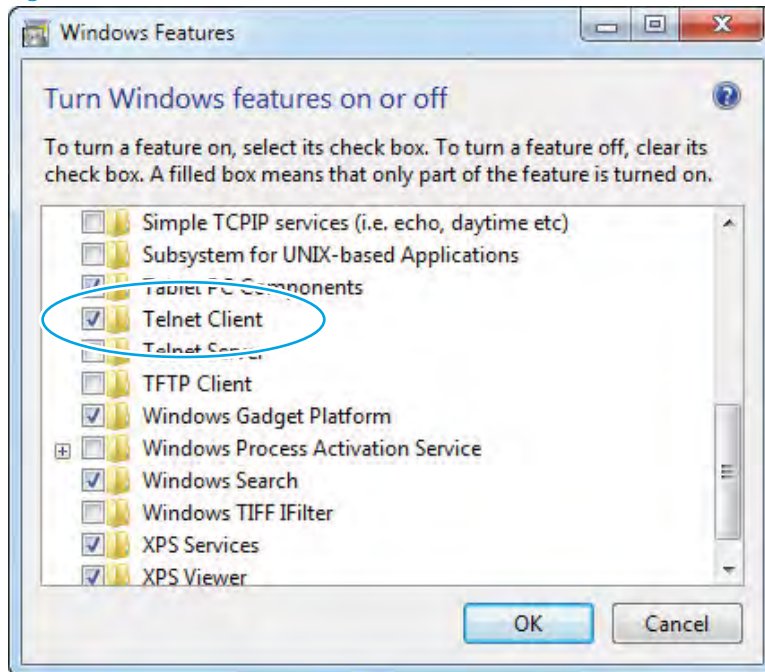
Figure 3-18 Turn Windows features on or off



3. In the **Windows Features** box, scroll down to **Telnet Client**. If the check box is not checked, click the box to select it, and then click the **OK** button.

 **TIP:** If the check box is already checked then the telnet client function is already enabled. Click the **Cancel** button.

**Figure 3-19** Enable the telnet client feature



### Network connection

The remote telnet client computer must have direct network access to the printer for the Remote Admin function to operate. This means that the telnet client computer must be on the same network as the printer. The Remote Admin function cannot be accessed through a network firewall or other remote access network security programs.

If a private network is not accessible, ask the network administrator to set up a virtual private network (VPN) connection to the network.




## Connect a remote connection

Learn how to connect a remote connection using telnet.

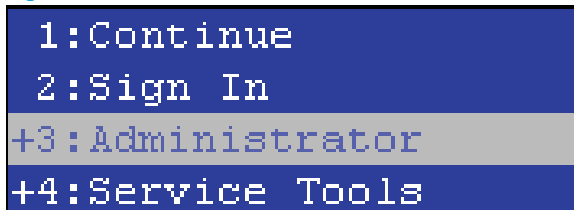
### Start the telnet server function at the printer

For security reasons the Remote Admin feature must be initiated by a person that is physically present at the printer. The following steps must be performed by a person that is physically present at the printer.

 **NOTE:** This person might need to sign in with an administrator or service password depending on how the printer is configured.

1. Turn the printer on.
2. The HP logo displays on the printer control panel. When a "1/8" with an underscore displays, touch the middle of the screen to open the [Pre-boot](#) menu.
3. Use the arrow buttons on the touchscreen to scroll down and highlight the **+3:Administrator** item, and then touch the [OK](#) button to select it.

**Figure 3-20** Select the +3:Administrator item



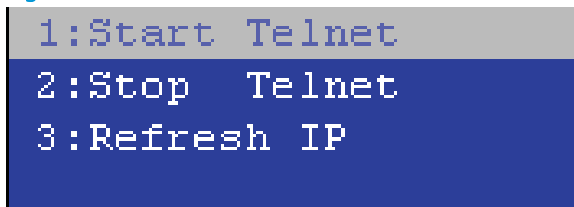
4. Use the arrow buttons on the touchscreen to scroll down and highlight the **+A:Remote Admin** item, and then touch the [OK](#) button to select it.

**Figure 3-21** Select the +A:Remote Admin item



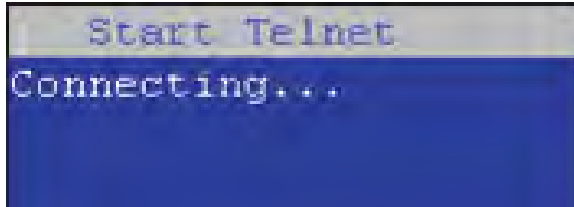
5. Use the arrow buttons on the touchscreen to scroll down and highlight the **1:Start Telnet** item, and then touch the [OK](#) button to select it.

**Figure 3-22** Select the 1:Start Telnet item



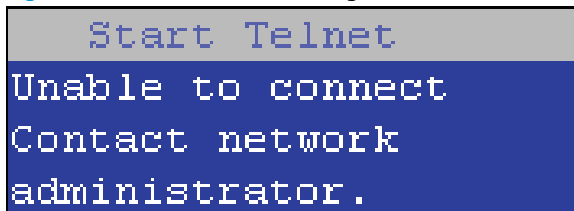
6. Do one of the following
  - If a connecting message displays briefly, go to step [7](#).

Figure 3-23 Telnet connecting message



- If an error message displays, use the steps below to identify the problem.

Figure 3-24 Telnet error message



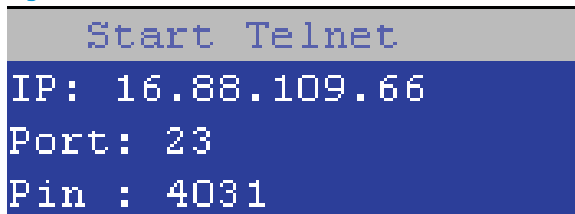
- a. The printer network cable is not correctly connected.
  - b. The BIOS LAN settings are incorrect.
    - The printer should be configured to use a static IP address, but is configured to use DHCP instead.
    - The printer is configured to use a static IP address, but the IP address is incorrect.
  - c. The printer is correctly configured to use DHCP, but the DHCP server is not turned on or is malfunctioning.
7. When the printer telnet server function is initialized, the following screen appears. Use the information on this screen to connect the remote telnet client computer to the printer.



**NOTE:** The printer is now ready to receive remote telnet client commands.

- **IP:** The static or dynamically allocated IP address for the printer.
- **Port:** The standard telnet port (23).
- **Pin:** A randomly generated 4-digit personal identification number (PIN).

Figure 3-25 Telnet server function initialized

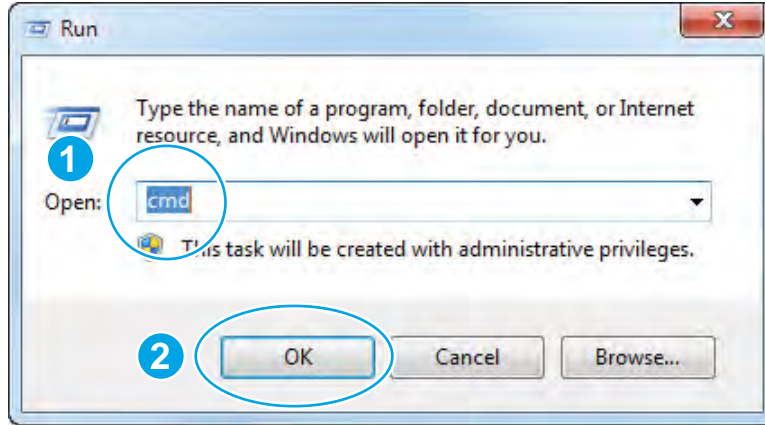


### Start the telnet client function at the remote computer

The following steps establish a Remote Admin connection from a remote computer to the printer.

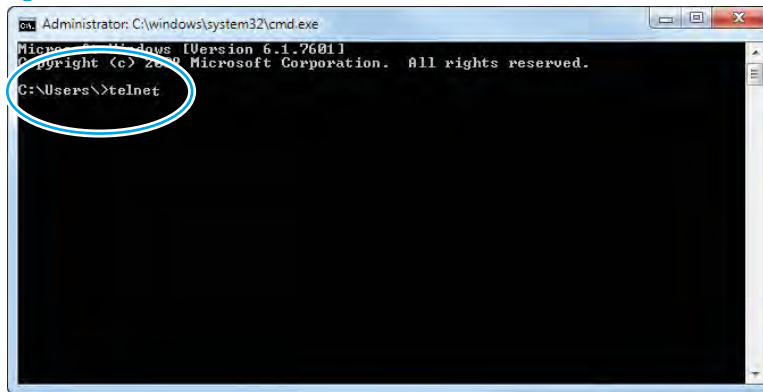
1. From the **Start** menu click **Run** to open a dialog box, type `cmd` in the **Open** field, and then click the **OK** button to open a Windows command window.

Figure 3-26 Open a command window



2. From any displayed directory, type `telnet` at the prompt, and then press the **Enter** key.

Figure 3-27 Start a telnet session

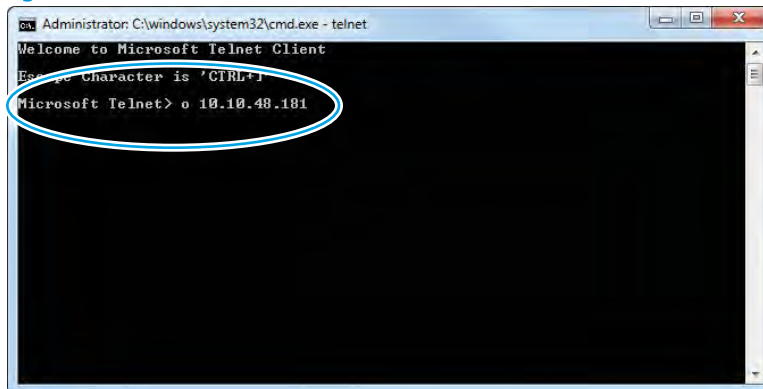


3. Type `<IP ADDRESS>` at the telnet prompt, and then press the **Enter** key.


**NOTE:** For `<IP ADDRESS>`, substitute the IP address that was displayed in step 7 in [Start the telnet server function at the printer on page 803](#).

**TIP:** If the telnet connection fails to establish a connection, the printer is probably behind a firewall or on a different network than the remote telnet client computer. See [Network connection on page 802](#).

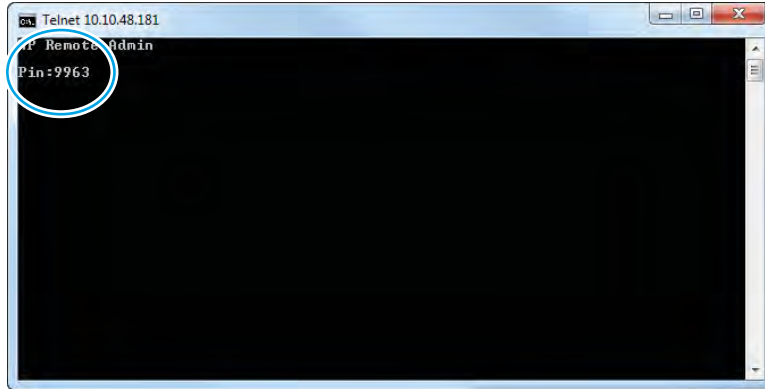
Figure 3-28 Establish a telnet connection




4. Type the PIN that was displayed in step 7 in [Start the telnet server function at the printer on page 803](#) at the prompt, and then press the **Enter** key.

 **IMPORTANT:** Make sure to type the PIN correctly. After five incorrect PIN entries, the printer terminates the Remote Admin connection. The Remote Admin feature must be re-initiated at the printer. See [Start the telnet server function at the printer on page 803](#).

**Figure 3-29** Enter the PIN

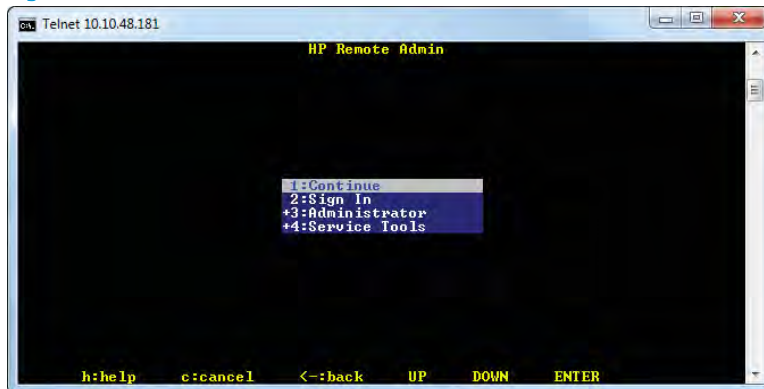


5. The following screen displays when the correct PIN is entered and the Remote Admin connection is successful. For information about the Pre-boot menu and options, see [Pre-boot menu options on page 791](#).

 **NOTE:** Because a Remote Admin connection is an unsecure telnet network protocol connection, the following Pre-boot menu items are disabled for the remote telnet client computer.

- The **+3:Administrator** menu **4:Change Password** item.
- The **+3:Administrator** menu **5:Clear Password** item.
- The **+3:Administrator** menu **6:Disk Manage** item.

**Figure 3-30** Remote Admin window




## Disconnect a remote connection

Learn how to disconnect a remote connection.

The Remote Admin connection can be terminated from the printer control panel or the remote telnet client computer.

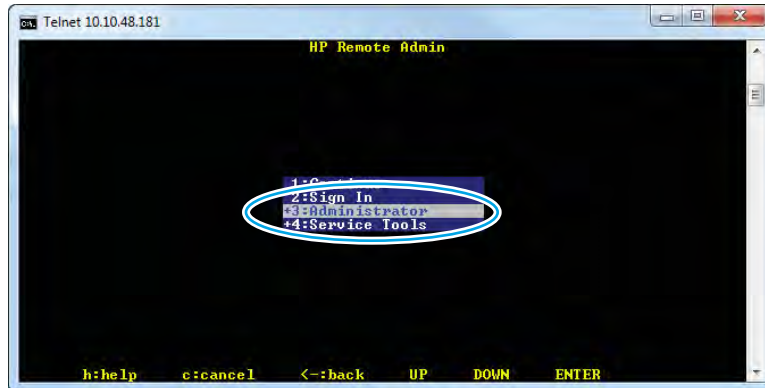
---

 **NOTE:** The following procedure describes terminating a Remote Admin connection from the remote telnet client computer.

---

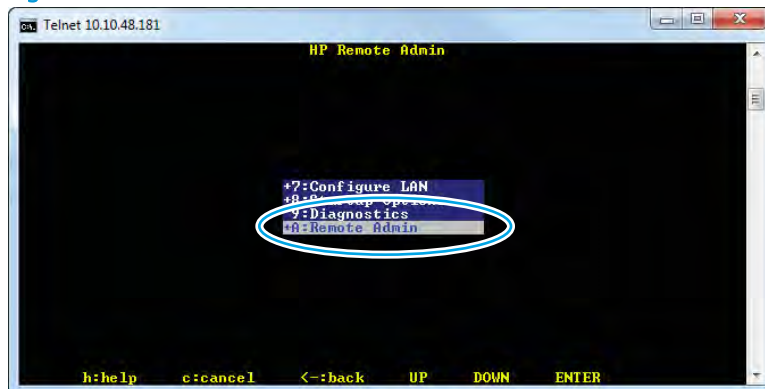
1. From the Pre-boot main menu, use the arrow buttons on the keyboard to scroll down to the **+3:Administrator** item, and then press the **Enter** key.

**Figure 3-31** Access the administrator menu




2. Use the arrow buttons on the keyboard to scroll down to the **+A:Remote Admin** item, and then press the **Enter** key.

**Figure 3-32** Access the remote admin menu



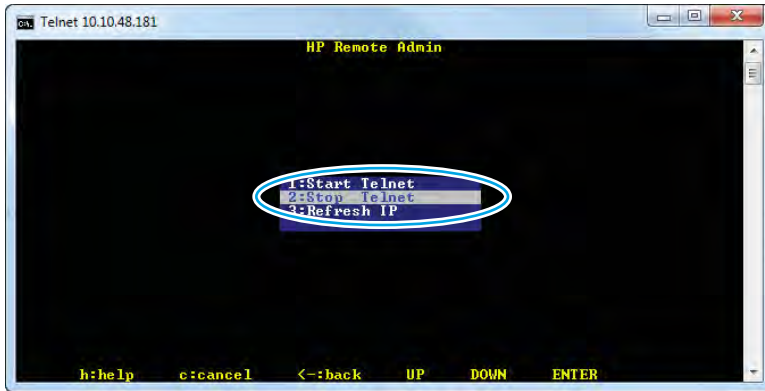
3. Use the arrow buttons on the keyboard to scroll down to the **2:Stop Telnet** item, and then press the **Enter** key. The Remote Admin connection between the printer and the remote telnet client computer terminates.

---

 **IMPORTANT:** The printer remains in the Pre-boot menu. Have the person that is physically present at the printer do the following:

- Touch the **Home** button to return to the main Pre-boot menu and highlight the **1:Continue** item, and then touch the **OK** button. The printer will continue to initialize.
-

Figure 3-33 Terminate the telnet connection



## Control panel menus

You can perform basic printer setup by using the [Settings](#) menu. Use the HP Embedded Web Server for more advanced printer setup. To open the HP Embedded Web Server, enter the printer IP address or host name in the address bar of a web browser.

## Reports menu

**To display:** At the printer control panel, select [Reports](#).

In the following table, asterisks (\*) indicate the factory default setting.

**Table 3-10** Reports menu

First level	Second level	Values	Description
Configuration/Status Pages	Settings Menu Map	Print	Shows a map of the entire control panel system and the selected values for each setting.
		View	
	Current Settings Page	Print	Shows a summary of the current settings for the printer. This might be helpful if you plan to make changes and need a record of the present configuration.
		View	
	Configuration Page	Print	Shows the printer settings and installed accessories.
		View	
	How to Connect Page	Print	Shows the network information typically needed to connect the printer to a network.
		View	
	Supplies Status Page	Print	Shows the approximate remaining life for the supplies; reports statistics on total number of pages and jobs processed, serial number, page counts, and maintenance information.  HP provides approximations of the remaining life for the supplies as a customer convenience. The actual remaining supply levels might be different from the approximations provided.
		View	
	Usage Page	Print	Shows a count of all paper sizes that have passed through the printer; lists whether they were simplex, duplex, monochrome, or color; and reports the page count.
		View	
	File Directory	Print	Shows the file name and folder name for files that are stored in the printer memory.
		View	
Web Services Status Page	Print	Shows the detected Web Services for the printer.	
	View		
Color Usage Job Log	Print	Shows color jobs completed by the printer.	
	View		

**Table 3-10 Reports menu (continued)**

First level	Second level	Values	Description
Fax Reports (MFP fax models only)	Fax Activity Log	Print	Contains a list of the faxes that have been sent from or received by this printer.
		View	
	Billing Codes Report	Print	Provides a list of billing codes that have been used for outgoing faxes. This report shows how many sent faxes were billed to each code.
		View	
	Blocked Fax List	Print	A list of phone numbers that are blocked from sending faxes to this printer.
		View	
Speed Dial List	Print	Shows the speed dials that have been set up for this printer.	
	View		
Fax Call Report	Print	A detailed report of the last fax operation, either sent or received.	
	View		
Other Pages	Demonstration Page	Print	Prints a demonstration page.
	RGB samples	Print	Prints color samples for different RGB values. Use the samples as a guide for matching printed colors.
	CMYK samples	Print	Prints color samples for different CMYK values. Use the samples as a guide for matching printed colors.
	PCL Font List	Print	Prints the available PCL fonts.
	PS Font List	Print	Prints the available PS fonts.

## Settings menu

**To display:** At the printer control panel, select the [Settings](#) menu.

In the following table, asterisks (\*) indicate the factory default setting.

**Table 3-11 Settings menu**

First level	Second level	Third level	Fourth level	Fifth level	Values	Description
General	Date/Time Settings	Date/Time Format	Date Format		DD/MMM/YYYY	Use the <a href="#">Date/Time Settings</a> menu to specify the date and time and to configure date/time settings.
					MMM/DD/YYYY	
					YYYY/MMM/DD	
			Time Format		12 hour (AM/PM)	
			24 hours			



Table 3-11 Settings menu (continued)

First level	Second level	Third level	Fourth level	Fifth level	Values	Description
		Date/Time	Date		Select the time zone from a list.	Select the time zone, date, and time that the printer uses.
			Time		Select the date from a pop-up calendar.	
			Time Zone		Select the time from a pop-up keypad.	
	Energy Settings	Sleep Schedule	A list of scheduled events displays.		+ (Add) Edit Delete	Use to configure the printer to automatically wake up or go to sleep at specific times on specific days. Using this feature saves energy.  <b>NOTE:</b> You must configure the date and time settings before you can use this feature.
			New event	Event Type		Select whether to add or edit a <a href="#">Wake</a> event or a <a href="#">Sleep</a> event, and then select the time and the days for the wake or sleep event.
				Time		Set the wake or sleep event time parameters.
				Event Days	Select days of the week from a list.	Set the wake or sleep event day parameters.
		Sleep Settings	Auto Off After Sleep Sleep After Inactivity HP Auto Off/Auto On Shut Down		Range: 1 to 110 minutes Default = 0 minutes	Set the number of minutes after which the printer enters Sleep or Auto Off mode. Touch the existing number to open the virtual keypad, and then increase or decrease the number of minutes.
			Wake/Auto On to These Events		All Events* Network port Power button only	

Table 3-11 Settings menu (continued)

First level	Second level	Third level	Fourth level	Fifth level	Values	Description
	Display Settings	Display Brightness	Automatic* Manual		The Manual setting uses a slider to manually control the display brightness.	Use to specify the intensity of the LCD control panel display.
		System Sound			On* Off	Use to specify whether you hear a sound when you touch the screen or press buttons on the control panel.
		Language Settings	Language		Select from a list of languages that the printer supports.	Use to select a different language for control panel messages and specify the default keyboard layout. When you select a new language, the keyboard layout automatically changes to match the factory default for the selected language.
			Keyboard Layout M681z/M682z only		Each language has a default keyboard layout. To change it, select from a list of layouts.	Select the default keyboard layout that matches the language you want to use.
		Information Screen			Show connection information* Hide connection information	Use this menu item to display or hide connection information on the Home screen.
		DisplayDate and Time M681/M682 only			Show Date and Time* Hide Date and Time	Select whether to display or hide the date and time on the control panel Home screen.
		Inactivity Timeout			Range: 10-300 seconds Default = 60 seconds	Specifies the amount of time that elapses between any activity on the control panel and when the printer resets to the default settings. When the timeout expires, the control panel display returns to the Home menu, and any user signed in to the printer is signed out.

Table 3-11 Settings menu (continued)

First level	Second level	Third level	Fourth level	Fifth level	Values	Description
		Clearable Warnings			On Job*	Use this feature to set the period that a clearable warning displays on the control panel. If the On setting is selected, clearable warnings appear until the Clearable Warnings button is pressed. If the Job setting is selected, clearable warnings stay on the display during the job that generated the warning and disappear from the display when the next job starts.
		Continuable Events			Auto-continue (10 seconds)* Touch OK to continue	Use this option to configure the printer behavior when the printer encounters certain errors. If the Auto-continue (10 seconds) option is selected, the job will continue after 10 seconds. If the Touch OK to continue option is selected, the job will stop and require the user to touch the OK button before continuing.

Table 3-11 Settings menu (continued)

First level	Second level	Third level	Fourth level	Fifth level	Values	Description
	Jam Recovery				Auto* Off On	<p>This printer provides a jam recovery feature that reprints jammed pages. Select one of the following options:</p> <p><b>Auto:</b> The printer attempts to reprint jammed pages when sufficient memory is available. This is the default setting.</p> <p><b>Off:</b> The printer does not attempt to reprint jammed pages. Because no memory is used to store the most recent pages, performance is optimal.</p> <p><b>NOTE:</b> When using this option, if the printer runs out of paper and the job is being printed on both sides, some pages can be lost.</p> <p><b>On:</b> The printer always reprints jammed pages. Additional memory is allocated to store the last few pages printed. This might cause a decrease in overall performance.</p>
	Auto Recovery				Enabled Disabled*	<p>The printer attempts to reprint jammed pages when sufficient memory is available. This is the default setting.</p>

Table 3-11 Settings menu (continued)

First level	Second level	Third level	Fourth level	Fifth level	Values	Description
	Hold Off Print Job				Enabled* Disabled	Enable this feature if you want to prevent print jobs from starting while a user is initiating a copy job from the control panel. Held print jobs start printing after the copy job is finished, provided that no other copy job is in the print queue.
	Restore Factory Settings				Restore Cancel	Use to restore all printer settings to their factory defaults.
Copy/Print	Copy Settings	Image Preview				Display a preview of the image before printing it.
	Enable Device USB				Enabled Disabled*	Enables the printer to open a file from a USB drive.
	Manage Stored Jobs	Job Sort Order			Job Name* Date	This option allows you list the jobs either alphabetically or chronologically.
		Retain Temporary Jobs After Reboot			Do not retain Personal jobs only All temporary jobs	Sets which temporary jobs will be retained in the event of a printer reboot.
		Temporary Job Storage Limit			1-300 Default = 32	Configure global settings for jobs that are stored in the printer memory.  The <a href="#">Temporary Job Storage Limit</a> feature specifies the number of temporary jobs that can be stored on the printer. The maximum allowed value is 300.

Table 3-11 Settings menu (continued)

First level	Second level	Third level	Fourth level	Fifth level	Values	Description
		Temporary Stored Job Retention			1-300 Default = 32	Configure global settings for jobs that are stored in the printer memory.  The <a href="#">Temporary Stored Job Retention</a> feature specifies the number of temporary jobs that can be stored on the printer. The maximum allowed value is 300.
		Standard Stored Job Retention			1-300 Default = 32	Configure global settings for jobs that are stored in the printer memory.  The <a href="#">Temporary Stored Job Retention</a> feature specifies the number of standard jobs that can be stored on the printer. The maximum allowed value is 300.
	Default Print Options	Number of Copies			Range: 1-32000 Default = 1	Sets the default number of copies for a copy job. This default applies when the <a href="#">Copy</a> function or the <a href="#">Quick Copy</a> function is initiated from the printer Home screen.
		Paper Selection			Select from a list of sizes that the printer supports.	Configures the default paper size used for print jobs.
		Default Custom Paper Size	X Dimension		Range: 3-8.5 inches Default = 8.5 inches	Configures the default paper size that is used when the user selects <b>Custom</b> as the paper size for a print job.
			Y Dimension		Range: 5-14 inches Default = 14 inches	
			Use Inches		Enabled* Disabled	

Table 3-11 Settings menu (continued)

First level	Second level	Third level	Fourth level	Fifth level	Values	Description
		Output Sides		1-sided* 2-sided		Use to indicate whether the original document is printed on one or both sides, and whether the copies should be printed on one or both sides. For example, select the 1-sided original, 2-sided output option when the original is printed on one side, but you want to make two-sided copies.
		Staple			None Top left Top right Top left or right	Sets the position of the staple on the page.
		Output Bin			Automatically select Standard bin Upper bin Middle bin	
		Resolution			FastRes1200 1200x1200dpi	Sets the resolution for sent documents. Higher resolution images have more dots per inch (dpi), so they show more detail. Lower resolution images have fewer dots per inch and show less detail, but the file size is smaller. Some file types, for example a file that will be processed with OCR, require a specific resolution. When these file types are selected, the Resolution setting might automatically change to a valid value.

Table 3-11 Settings menu (continued)

First level	Second level	Third level	Fourth level	Fifth level	Values	Description
	PCL and PostScript Settings	Courier Font			Regular* Dark	Select which version of the Courier font you want to use. The factory default setting is Regular, which uses an average stroke width. The Dark setting can be used if a heavier Courier font is needed.
		Wide A4			Enabled Disabled*	Changes the printable area of A4-size paper. If you enable this option, eighty 10-pitch characters can be printed on a single line of A4 paper.
		Print PS Errors			Enabled Disabled*	Use this feature to select whether a PostScript (PS) error page is printed when the printer encounters a PS error.
		Print PDF Errors			Enabled Disabled*	Selects whether a PDF error page is printed when the printer encounters a PDF error.
		Personality			Auto* PCL PS PDF	Configures the default print language or personality for the printer. Normally you should not change the printer language. If you change the setting to a specific printer language, the printer does not automatically switch from one language to another unless specific software commands are sent to it.



Table 3-11 Settings menu (continued)

First level	Second level	Third level	Fourth level	Fifth level	Values	Description
		PCL	Font Settings	Font Source	Internal Disk resident	Selects the font source for the user-soft default font. The list of available options varies depending on the installed printer options.
				Font Number	Range: 0-110 Default = 0	Specifies the font number for the user-soft default font using the source that is specified in the <a href="#">Font Source</a> menu. The printer assigns a number to each font and lists it on the PCL font list. The font number displays in the Font # column of the printout.
				Font Pitch	Range: 0.44-99.99 Default = 10	If the <a href="#">Font Source</a> option and the <a href="#">Font Number</a> setting indicate a contour font, then use this feature to select a default pitch (for a fixed-spaced font).
			PCL Settings	Form Length	Range: 5-128 Default = 60	Controls the PCL print-command options. PCL is a set of printer commands that HP developed to provide access to printer features.  Use the <a href="#">Form Length</a> feature to select the user-soft default vertical form length.
				Orientation	Portrait* Landscape	Select the orientation that is most often used for copy or scan originals. Select the <a href="#">Portrait</a> option if the short edge is at the top or select the <a href="#">Landscape</a> option if the long edge is at the top.

Table 3-11 Settings menu (continued)

First level	Second level	Third level	Fourth level	Fifth level	Values	Description
				Symbol Set	Select from a list of symbol sets.	Select any one of several available symbol sets from the control panel. A symbol set is a unique grouping of all the characters in a font. The factory default value for this option is PC-8. Either PC-8 or PC-850 are recommended for line-draw characters.
				Append CR to LF	No* Yes	Configure whether a carriage return (CR) is appended to each line feed (LF) encountered in backwards-compatible PCL jobs (pure text, no job control). Select Yes to append the carriage return. The default setting is No. Some environments, such as UNIX, indicate a new line by using only the line-feed control code. This option allows the user to append the required carriage return to each line feed.
				Suppress Blank Pages	No* Yes	This option is for users who are generating their own PCL, which could include extra form feeds that would cause blank pages to be printed. When the Yes option is selected, form feeds are ignored if the page is blank.

Table 3-11 Settings menu (continued)

First level	Second level	Third level	Fourth level	Fifth level	Values	Description
				Media Source Mapping	Standard* Classic	Use to select and maintain input trays by number when you are not using the printer driver, or when the software program has no option for tray selection. The following options are available:  <b>Standard:</b> Tray numbering is based on newer HP LaserJet models.  <b>Classic:</b> Tray numbering is based on HP LaserJet 4 and older models.
	Print Quality	Adjust Color	Tonal Range	Highlights Midtones Shadows		
			Cyan Magenta Yellow Black			
		Image Registration	Tray	Tray 1 Tray 2 Tray 3 Tray 4 Tray 5 Depends upon number of trays installed		Specify tray to be adjusted

Table 3-11 Settings menu (continued)

First level	Second level	Third level	Fourth level	Fifth level	Values	Description
			Front-side Horizontal Shift		-5.00 mm to 5.00 mm	Shift the margin alignment to center the image on the page from top to bottom and from left to right. You can also align the image on the front with the image printed on the back.
			Front-side Vertical Shift			The direction that is perpendicular to the way the paper passes through the printer is referred to as X. This is also known as the scan direction. X1 is the scan direction for a single-sided page or for the second side of a two-sided page. X2 is the scan direction for the first side of a two-sided page.
			Back-side Horizontal Shift			The direction that the paper feeds through the printer is referred to as Y. Y1 is the feed direction for a single-sided page or for the second side of a two-sided page. Y2 is the feed direction for the first side of a two-sided page.
			Back-side Vertical Shift			Use the <a href="#">Adjust Tray &lt;X&gt;</a> menu to adjust the registration settings for each tray. Before adjusting these values, print a registration test page. It provides alignment guides in the X and Y directions so you can determine which adjustments are necessary. You can adjust values for X1 Shift, X2 Shift, Y1 Shift, and Y2 Shift.

Table 3-11 Settings menu (continued)

First level	Second level	Third level	Fourth level	Fifth level	Values	Description
				Print Test Page		Use the <a href="#">Print Test Page</a> option to print a page to test the image registration. It provides alignment guides in the X and Y directions so you can determine which adjustments are necessary.
		Auto Sense Behavior	Tray 1		Sense every page Sense first page Sense transparency only	
			All Other Trays		Sense first page Sense transparency only	
		Adjust paper types			Select from a list of paper types Reset Paper Types	
		Optimize			Normal Paper Heavy paper Envelope control Tray 1 Background Background 1 Uniformity Control Tracking Control Registration Transfer Control Moisture Control Reset Optimize	
		Edge Control			Off Light Normal Maximum	

Table 3-11 Settings menu (continued)

First level	Second level	Third level	Fourth level	Fifth level	Values	Description
	Manage Trays	Use Requested Tray			Exclusively* First	<p>Controls how the printer handles jobs that have specified a specific input tray. Two options are available:</p> <p><b>Exclusively:</b> The printer never selects a different tray when the user has indicated that a specific tray should be used, even if that tray is empty.</p> <p><b>First:</b> The printer pulls from another tray if the specified tray is empty, even though the user specifically indicated a tray for the job.</p>
		Manually Feed Prompt			Always* Unless loaded	<p>Indicate whether a prompt should appear when the type or size for a job does not match the specified tray and the printer pulls from the multipurpose tray instead. Two options are available:</p> <p><b>Always:</b> A prompt always displays before using the multipurpose tray.</p> <p><b>Unless loaded:</b> A message displays only if the multipurpose tray is empty.</p>

Table 3-11 Settings menu (continued)

First level	Second level	Third level	Fourth level	Fifth level	Values	Description
		Size/Type Prompt			Display* Do not display	<p>Controls whether the tray configuration message displays whenever a tray is closed. Two options are available:</p> <p><b>Display:</b> Shows the tray configuration message when a tray is closed. The user is able to configure the tray settings directly from this message.</p> <p><b>Do not display:</b> Prevents the tray configuration message from automatically appearing.</p>
		Use Another Tray			Enabled* Disabled	<p>Use to turn on or off the control panel prompt to select another tray when the specified tray is empty. Two options are available:</p> <p><b>Enabled:</b> When this option is selected, the user is prompted either to add paper to the selected tray or to choose a different tray.</p> <p><b>Disabled:</b> When this option is selected, the user is not given the option of selecting a different tray. The printer prompts the user to add paper to the tray that was initially selected.</p>

Table 3-11 Settings menu (continued)

First level	Second level	Third level	Fourth level	Fifth level	Values	Description
		Alternative Letterhead Mode			Disabled* Enabled	Use to load letterhead or preprinted paper into the tray the same way for all print jobs, whether you are printing to one side of the sheet or to both sides of the sheet. When this option is selected, load the paper as you would for printing on both sides. See the user documentation that came with the printer for instructions about loading letterhead for printing on both sides. When this option is selected, the printer speed slows to the speed required for printing on both sides.
		Duplex Blank Pages			Auto* Yes	Controls how the printer handles two-sided jobs (duplexing). Two options are available:  <b>Auto:</b> Enables Smart Duplexing, which instructs the printer not to process blank pages.  <b>Yes:</b> Disables Smart Duplexing and forces the duplexer to flip the sheet of paper even if it is printed on only one side. This might be preferable for certain jobs that use paper types such as letterhead or prepunched paper.



Table 3-11 Settings menu (continued)

First level	Second level	Third level	Fourth level	Fifth level	Values	Description
		Override A4/Letter			Yes* No	Prints on letter-size paper when an A4 job is sent but no A4-size paper is loaded in the printer (or to print on A4 paper when a letter-size job is sent but no letter-size paper is loaded). This option will also override A3 with ledger-size paper and ledger with A3-size paper.
Scan/Digital Send	E-mail Settings  Network Folder Settings  SharePoint Settings  Scan to USB Drive Settings  <b>NOTE:</b> The same options are available for each of these features, except where noted.	E-mail Setup  <b>NOTE:</b> Email Settings only				Use to configure settings that apply to sending documents through email or saving documents to a folder on the network or on a USB multi-drive.  The <a href="#">E-mail Setup Wizard</a> feature configures the printer to send scanned images as email attachments. To open the printer HP Embedded Web Server and set up the email notification server, enter the printer IP address into a Web browser.

Table 3-11 Settings menu (continued)

First level	Second level	Third level	Fourth level	Fifth level	Values	Description
		Image Preview			<a href="#">Make optional*</a> <a href="#">Require preview</a> <a href="#">Disable preview</a>	<p>Defines the default job options for each function. If you do not specify the job options when creating the job, the default options are used. For complete setup, go to the HP Embedded Web Server by typing the IP address of the printer into a Web browser.</p> <p>Use the <a href="#">Image Preview</a> feature to scan a document and display a preview before completing the job. Select whether this feature is available on the printer.</p> <p><a href="#">Make optional</a>: The feature is optional, depending on the user who is signed in.</p> <p><a href="#">Require preview</a> Previews are required for all users.</p> <p><a href="#">Disable preview</a>: Previews are disabled for all users.</p>

Table 3-11 Settings menu (continued)

First level	Second level	Third level	Fourth level	Fifth level	Values	Description
		Default File Name				The printer is shipped with a factory default file name of [Untitled] for any scanned files that are sent or saved. Use this feature to specify a different default file name. If you are saving a file to a network folder or USB storage printer and a file with the default file name already exists, a number is appended to the file name, for example, [Untitled]001.

Table 3-11 Settings menu (continued)

First level	Second level	Third level	Fourth level	Fifth level	Values	Description
		Document File Type			Select from a list of file types.	<p>PDF provides the best overall image and text quality.</p> <p>JPEG is a good choice for most graphics. Most computers have a browser that can view .JPEG files. This file type produces one file per page.</p> <p>TIFF is a standard file format that many graphics programs support. This file type produces one file per page.</p> <p>MTIFF: stands for multi-page TIFF. This file type saves multiple scanned pages in a single file.</p> <p>XPS (XML Paper Specification) creates an XML file that preserves the original formatting of the document and supports color graphics and embedded fonts.</p> <p><b>NOTE:</b> OCR file types are not supported on this printer unless attached to DSS.</p>

Table 3-11 Settings menu (continued)

First level	Second level	Third level	Fourth level	Fifth level	Values	Description
		Optimize Text/ Picture			Manually Adjust* Text Printed picture Photograph	<p>Use to optimize the output for a particular type of content. You can optimize the output for text, printed pictures, or a mixture.</p> <p><b>Manually Adjust:</b> Use to manually optimize the setting for text or for pictures.</p> <p><b>Text:</b> Use to optimize the text portion of the copy when text and/or pictures are on the original.</p> <p><b>Printed picture:</b> Use for line drawings and preprinted images, such as magazine clippings or pages from books.</p> <p><b>Photograph:</b> Best suited for making copies of printed pictures.</p>
		Output Quality			High (large file) Medium* Low (small file)	<p>Use to select the quality for the output. Higher-quality images require a larger file size than lower-quality images. Larger files take more time to send, and some recipients might have trouble receiving larger files.</p>

Table 3-11 Settings menu (continued)

First level	Second level	Third level	Fourth level	Fifth level	Values	Description
		Original Sides			1-sided 2-sided	Use to describe the layout for each side of the original document. First select whether the original document is printed on one side or both sides. Then touch the <a href="#">Orientation</a> setting to indicate whether the original has portrait or landscape orientation. If it is printed on both sides, also select the 2-sided format that matches the original document.
			Orientation		Automatically detect Portrait* Landscape	For some features to work correctly, you must specify the way the content of the original document is placed on the page. Portrait orientation means the short edge of the page is along the top. Landscape orientation means the long edge of the page is along the top. In the <a href="#">Orientation</a> area, select whether the original document has a portrait or landscape orientation.

Table 3-11 Settings menu (continued)

First level	Second level	Third level	Fourth level	Fifth level	Values	Description
			2-Sided Format		Book-style Flip-style	<p><b>Book-style:</b> The back side of the original is printed right-side-up, and the back side of the copy is printed the same way. Use this option for originals and copies that are bound along the left edge.</p> <p><b>Flip-style:</b> The back side of the original is printed upside-down, and the back side of the copy is printed the same way. Use this option for originals and copies that are to be bound along the top edge.</p>
		Resolution			400 dpi 300 dpi 200 dpi 150 dpi* 75 dpi	<p>Sets the resolution for sent documents. Higher resolution images have more dots per inch (dpi), so they show more detail. Lower resolution images have fewer dots per inch and show less detail, but the file size is smaller. Some file types, for example a file that will be processed with OCR, require a specific resolution. When these file types are selected, the <b>Resolution</b> setting might automatically change to a valid value.</p>

Table 3-11 Settings menu (continued)

First level	Second level	Third level	Fourth level	Fifth level	Values	Description
		Content Orientation	Orientation		Auto Detect Portrait* Landscape	For some features to work correctly, you must specify the way the content of the original document is placed on the page. Portrait orientation means the short edge of the page is along the top. Landscape orientation means the long edge of the page is along the top. In the Orientation area, select whether the original document has a portrait or landscape orientation.
			2-Sided Format		Book-style* Flip-style	Use to configure the default style for 2-sided print jobs. If the <a href="#">Book-style</a> option is selected, the back side of the page is printed the right way up. This option is for print jobs that are bound along the left edge. If the <a href="#">Flip-style</a> option is selected, the back side of the page is printed upside-down. This option is for print jobs that are bound along the top edge.



Table 3-11 Settings menu (continued)

First level	Second level	Third level	Fourth level	Fifth level	Values	Description
		Color/Black			Automatically detect*	Use to enable or disable color scanning.
					Color	
					Black/Gray	Automatically detect:
					Black	Automatically scans documents in color if at least one page has color.
						Color: Scans documents in color.
						Black/Gray: Scans documents in grayscale.
						Black: Scans documents in black and white with a compressed file size.
		Original Size			Select from a list of supported sizes.	Use to describe the page size of the original document.
		Notification			Do not notify*	Configure to receive notification about the status of a sent document.
					Notify when job completes	
					Notify only if job fails	Do not notify: Turns off this feature.
					Print	Notify when job completes: Select to receive notification for this job only.
					E-mail	Notify only if job fails: Select to receive notification only if the job is not sent successfully.
						Print: Select to print the notification at this printer.
						E-mail: Select to receive the notification to an email account.

Table 3-11 Settings menu (continued)

First level	Second level	Third level	Fourth level	Fifth level	Values	Description
			Include Thumbnail			<b>NOTE:</b> When sending an analog fax, select <a href="#">Include Thumbnail</a> to receive a thumbnail image of the first page of the fax in your notification.
			Notification E-mail address			<b>E-mail:</b> Select to receive the notification in an email. Touch the text box following <a href="#">Email Address</a> , and then type the email address for the notification.
		Image Adjustment		Darkness		Use to improve the overall quality of the copy.  Adjust the <a href="#">Darkness</a> setting to increase or decrease the amount of white and black in the colors.
				Contrast		Adjust the <a href="#">Contrast</a> setting to increase or decrease the difference between the lightest and darkest color on the page.
				Background Cleanup		Adjust the <a href="#">Background Cleanup</a> setting if you are having trouble copying a faint image.
				Sharpness		Adjust the <a href="#">Sharpness</a> setting to clarify or soften the image. For example, increasing the sharpness could make text appear crisper, but decreasing it could make photographs appear smoother.

Table 3-11 Settings menu (continued)

First level	Second level	Third level	Fourth level	Fifth level	Values	Description
				Automatic Tone		The printer automatically adjusts the <a href="#">Darkness</a> , <a href="#">Contrast</a> , and <a href="#">Background Cleanup</a> settings to the most appropriate for the scanned document.
				Default		Select this to make the selected <a href="#">Image Adjustment</a> setting the default value.
		Job Build			<a href="#">Job Build off*</a> <a href="#">Job Build on</a>	Use to combine several original documents into one job. Also use to scan an original document that has more pages than the document feeder can accommodate at one time. The printer temporarily saves all the scanned images. After you have scanned all the pages for the job, touch <a href="#">Finish</a> to finish the job.
		Cropping Options			<a href="#">Do not crop*</a> <a href="#">Crop to content</a> <a href="#">Crop to paper</a>	Use this menu item to automatically crop the scan for digital sending. Use the <a href="#">Crop to content</a> option to scan the smallest possible area that has detectable content.
		Erase Edges			<a href="#">Use inches</a> <a href="#">Back side erase</a> <a href="#">Front side erase</a>	Use this menu item to remove blemishes, such as dark borders or staple marks, by cleaning the specified edges of the scanned image. In each of the text boxes enter the measurements, in millimeters or inches, for how much of the top edge, bottom edge, left edge, and right edge to clean.

Table 3-11 Settings menu (continued)

First level	Second level	Third level	Fourth level	Fifth level	Values	Description
		Multi-feed Detection			Disabled Enabled*	This setting stops the scanning process if it detects multiple-page feeds through the document feeder.
		Blank Page Suppression			Disabled* Enabled	Use to prevent blank pages in the original document from being included in the output document.
		Create Multiple Files			Disabled* Enabled	Enable this item to scan pages into separate files based on a specified page limit.  A page is one side of an original document.  JPEG and TIFF have a limit of one page per file.
	Digital Sending Software Setup	Allow Use of a DSS Server  Allow Transfer to New DSS server			Disabled Enabled*	Configure how the printer interacts with the HP Digital Sending Software (DSS) server. HP DSS handles digital sending tasks, such as faxing, emailing, and sending scanned documents to a network folder or USB storage device.  Use the <a href="#">Allow Use of a DSS Server</a> and <a href="#">Allow Transfer to New DSS server</a> options to configure the printer to use HP DSS.
Fax	Internal Fax Modem Setup					
	Fax Send Settings	Image Preview				

Table 3-11 Settings menu (continued)

First level	Second level	Third level	Fourth level	Fifth level	Values	Description
		Fax Dialing Settings	Fax Dial Volume		Off Low* High	These settings control how the fax modem dials the outgoing fax number when faxes are sent.
			Dialing Mode		Tone* Pulse	
			Redial Interval		1-5 Minutes Default = 5 minutes	
			Fax Send Speed		Fast* Medium Slow	
			Dialing Prefix			
			Detect Dial Tone			
			Redial on Error		Range: 0-9 Default = 2	
			Redial on No Answer		Range: 0-2 Default = 0	
			Redial on Busy		Range: 0-9 Default = 3	
		General Fax Send Settings	Fax Number Confirmation		Enabled Disabled*	If this feature is enabled, you must enter the fax number twice.
			PC Fax Send		Enabled* Disabled	Enables users who have the correct driver installed to send faxes through the printer from their computers.

Table 3-11 Settings menu (continued)

First level	Second level	Third level	Fourth level	Fifth level	Values	Description
			JBIG Compression		Enabled* Disabled	The JBIG compression reduces fax-transmission time, which can result in lower phone charges. However, using JBIG compression sometimes causes compatibility problems with older fax machines. If this occurs, turn off the JBIG compression.
			Error Correction Mode		Enabled* Disabled	When error-correction mode is enabled and an error occurs during fax transmission, the printer sends or receives the error portion again.
			Fax Header		Prepend* Overlay	Use to prepend or overlay the fax header page.
			Fax Number Speed Dial Matching		Enabled Disabled*	Use this item to match the fax number that you type to numbers that are saved as a speed dial.

Table 3-11 Settings menu (continued)

First level	Second level	Third level	Fourth level	Fifth level	Values	Description
		Billing Code Settings	Enable Billing Codes		Off* On	<p>When billing codes are enabled, a prompt displays that asks the user to enter the billing code for an outgoing fax. This prompt does not appear if the <a href="#">Allow users to edit billing codes</a> check box is not checked.</p> <p>You can also use the billing codes report in the <a href="#">Reports</a> menu to view the list of the billing codes that have been used for faxes that have been sent from the printer. The list is grouped by billing code and also shows fax details. This feature can be used for billing or usage tracking.</p>
			Default Billing Code			Specify a default billing code for faxing. If you specify a default billing code, this code displays in the <a href="#">Billing Code</a> field when the user sends an outgoing fax. If this field is blank, no default billing code is provided for the user.
			Minimum Length		Range: 1-16 Default = 1	Specify the required length of the billing code. Billing codes can be between 1 and 16 characters long.
			Allow users to edit billing codes		Off On*	
Fax Receive Settings	Fax Receive Setup	Fax Receive Setup	Ringer Volume		Off Low* High	Use to configure settings for receiving faxes.

Table 3-11 Settings menu (continued)

First level	Second level	Third level	Fourth level	Fifth level	Values	Description
			Rings To Answer		Range: 1-6 Default = 1	
			Fax Receive Speed		Fast* Medium Slow	
			Ring Interval		Range: 220-600 ms Default = 600 ms	
			Ring Frequency		Range: 1-200 Default = 68hz	
		Fax Printing Schedule			Always store faxes Always print faxes* Use Fax Printing Schedule	If you have concerns about the security of private faxes, use this feature to store faxes rather than having them automatically print. Open the <a href="#">Fax Printing Schedule</a> sub-menu, and then you can choose to always store faxes, always print them, or you can set up a schedule for each day of the week.
			Schedule	+ (Add) Edit Delete (trash can)	Print incoming faxes Store incoming faxes Time Event Days	If you are using a fax printing schedule, use this menu to configure when to print faxes.
			Touch this to set up a fax printing schedule if you selected the <a href="#">Use Fax Printing Schedule</a> option.			



Table 3-11 Settings menu (continued)

First level	Second level	Third level	Fourth level	Fifth level	Values	Description
		Blocked Fax Numbers	Fax Number to Block			<p>The blocked fax list can contain up to 30 numbers. When the printer receives a call from one of the blocked fax numbers, it deletes the incoming fax. It also logs the blocked fax in the activity log along with job-accounting information.</p> <p>Add blocked numbers: Enter a fax number into the <a href="#">Fax Number to Block</a> field, and then touch the arrow button to add a new number to the blocked fax list.</p> <p>To remove blocked numbers: Select a number and touch the <a href="#">Delete</a> button to delete it from the blocked fax list.</p> <p>To clear all blocked numbers: Touch the <a href="#">Delete All</a> button to clear all of the numbers from the blocked fax list.</p> <p>You also can use the <a href="#">Blocked Fax List</a> report in the <a href="#">Information</a> menu to view the list of the fax numbers that have been blocked on this printer.</p>

Table 3-11 Settings menu (continued)

First level	Second level	Third level	Fourth level	Fifth level	Values	Description
		Default Job Options	Notification		Do not notify* Notify when job completes Notify only if job fails	Configure to receive notification about the status of a sent document.  <b>Do not notify:</b> Turns off this feature.  <b>Notify when job completes:</b> Select to receive notification for this job only.  <b>Notify only if job fails:</b> Select to receive notification only if the job is not sent successfully.
					Print E-mail*	<b>E-mail:</b> Select to receive the notification in an email. Touch the text box following <b>Email Address</b> , and then enter the email address for the notification.
				Include Thumbnail		<b>NOTE:</b> When sending an analog fax, select <b>Include Thumbnail</b> to receive a thumbnail image of the first page of the fax in your notification.
				Notification E-mail address		Touch this text field, provide the email address to which you want notifications sent, and then touch the <b>OK</b> button.
			Stamp Received Faxes		Enabled Disabled*	Use this option to add the date, time, sender's phone number, and page number to each page of the faxes that this printer receives.

Table 3-11 Settings menu (continued)

First level	Second level	Third level	Fourth level	Fifth level	Values	Description
			Fit to Page		Enabled* Disabled	Use to shrink faxes that are larger than Letter-size or A4-size so that they can fit onto a Letter-size or A4-size page. If this feature set to Disabled, faxes larger than Letter or A4 will flow across multiple pages.
			Paper Tray		Automatic* Select from a list of the trays.	
			Output Bin		Automatically select Standard bin Upper bin Middle bin	
			Out Sides		1-sided* 2-sided	Use to describe the layout for each side of the original document. First select whether the original document is printed on one side or both sides.
	Fax Forwarding	Enable Fax Forwarding			Disabled* Enabled	Use to forward received faxes to another fax machine.
			Type of Fax Job to Forward		All faxes Sent faxes Received faxes	Use to select the type of fax jobs that you want forwarded.
			Fax Forwarding Number			Provide the forwarding phone number, and then touch the <b>OK</b> button.
	Clear Fax Activity Log					Clears all events from the fax activity log.

Table 3-11 Settings menu (continued)

First level	Second level	Third level	Fourth level	Fifth level	Values	Description
Manage Supplies	Low Warning Thresholds			Black Cartridge	1-100%	Set the estimated percentage at which the printer notifies you when a toner cartridge is very low.
				Cyan Cartridge	Default = 5%	
				Magenta Cartridge		
				Yellow Cartridge		
	Low Warning Threshold Message				On	Displays a message on the control panel when a cartridge is very low.
					Off	
	Very Low Behavior	Black Cartridge			Stop	
		Color Cartridges			Continue	
		Transfer Kit			Prompt to continue	
		Fuser Kit				
		Document Feeder Kit				
		Staples			Stop	
					Prompt to continue	
	Restrict Color Use				Enable	Use this feature to enable, restrict, or disable color printing or copying.
					Disable Color	

Table 3-11 Settings menu (continued)

First level	Second level	Third level	Fourth level	Fifth level	Values	Description
	Color/Black Mix				Auto Mostly Color Pages Mostly Black Pages	<p>Instructs the printer when to switch between color and monochrome printing modes for the best overall performance.</p> <p><b>Auto:</b> Uses the mode that is appropriate for the first page of the job. If necessary, the printer switches modes during the middle of a job and then stays in that mode until the job is finished.</p> <p><b>Mostly Color Pages:</b> The printer uses color mode for all jobs, even if the job contains no color pages.</p> <p><b>Mostly Black Pages:</b> The printer uses monochrome mode until it detects a color page. The printer switches back to monochrome mode when it detects a sequence of several monochrome pages.</p>

Table 3-11 Settings menu (continued)

First level	Second level	Third level	Fourth level	Fifth level	Values	Description
	Store Usage Data				On supplies Not on supplies	The <a href="#">Store Usage Data</a> provides a way to suppress the toner cartridges from storing most of the information gathered exclusively for the purpose of understanding the usage of the printer. Select the <a href="#">On supplies</a> setting to store the data on the toner cartridge memory chip. Select the <a href="#">Not on supplies</a> setting to suppress the information from being stored on the memory chip.
	Cartridge Protection				Off* Protect Cartridges	Select to permanently protect cartridges so that they can be used only in this product or fleet of products.
	Cartridge Policy				Off* Authorized HP	Set <a href="#">Authorized HP</a> to allow only genuine HP cartridges to be used in this product.
Manage Stapler/ Stacker	Operation Mode				Mailbox Stacker Function Separator	
	Job Offset				On Off	
Networking	Ethernet	Information	Print Security Report		Yes No*	<a href="#">Yes</a> : Prints a page that contains the current security settings on the HP Jetdirect print server.  <a href="#">No</a> : A security settings page is not printed.

Table 3-11 Settings menu (continued)

First level	Second level	Third level	Fourth level	Fifth level	Values	Description
		TCP/IP	Host Name		Use the arrow buttons to edit the host name.  NP1XXXXXX*	An alphanumeric string, up to 32 characters, used to identify the printer. This name is listed on the HP Jetdirect configuration page. The default host name is NP1XXXXXX, where XXXXXX is the last six digits of the LAN hardware (MAC) address.
			IPv4 Settings	Config Method	Bootp DHCP* Auto IP Manual	Specifies the method that TCP/IPv4 parameters will be configured on the HP Jetdirect print server.  <b>Bootp</b> (Bootstrap Protocol): Use for automatic configuration from a BootP server.  <b>DHCP</b> (Dynamic Host Configuration Protocol): Use for automatic configuration from a DHCPv4 server. If selected and a DHCP lease exists, the <b>DHCP Release</b> menu and the <b>DHCP Renew</b> menu are available to set DHCP lease options.  <b>Auto IP</b> : Use for automatic link-local IPv4 addressing. An address in the form 169.254.x.x is assigned automatically.  If you set this option to the <b>Manual</b> setting, use the <b>Manual Settings</b> menu to configure TCP/IPv4 parameters.

Table 3-11 Settings menu (continued)

First level	Second level	Third level	Fourth level	Fifth level	Values	Description
				Default IP	Auto IP* Legacy	Specify the IP address to default to when the print server is unable to obtain an IP address from the network during a forced TCP/IP reconfiguration (for example, when manually configured to use BootP or DHCP).  <b>NOTE:</b> This feature assigns a static IP address that might interfere with a managed network.  <b>Auto IP:</b> A link-local IP address 169.254.x.x is set.  <b>Legacy:</b> The address 192.0.0.192 is set, consistent with older HP Jetdirect printers.
				Primary DNS	Range: 0-255 Default = xxx.xxx.xx.xx	Specify the IP address (n.n.n.n) of a Primary Domain Name System (DNS) Server.
				Secondary DNS	Range: 0-255 Default = 0.0.0.0	Specify the IP address (n.n.n.n) of a Secondary DNS Server.
		IPv6 Settings	Enable	Off On*		Use this item to enable or disable IPv6 operation on the print server.  <b>Off:</b> IPv6 is disabled.  <b>On:</b> IPv6 is enabled.
			Address	Manual Settings Enable Address		Use this item to enable and manually configure a TCP/IPv6 address.



Table 3-11 Settings menu (continued)

First level	Second level	Third level	Fourth level	Fifth level	Values	Description
				DHCPv6 Policy	Router Specified Router Unavailable* Always	<p><b>Router Specified:</b> The stateful auto-configuration method to be used by the print server is determined by a router. The router specifies whether the print server obtains its address, its configuration information, or both from a DHCPv6 server.</p> <p><b>Router Unavailable:</b> If a router is not available, the print server should attempt to obtain its stateful configuration from a DHCPv6 server.</p> <p><b>Always:</b> Whether a router is available, the print server always attempts to obtain its stateful configuration from a DHCPv6 server.</p>
				Primary DNS	Range: 0-255 Default = <b>xxx.xxx.xx.xx</b>	Specify the IP address (n.n.n.n) of a Primary Domain Name System (DNS) Server.
				Secondary DNS	Range: 0-255 Default = <b>0.0.0.0</b>	Specify the IP address (n.n.n.n) of a Secondary DNS Server.

Table 3-11 Settings menu (continued)

First level	Second level	Third level	Fourth level	Fifth level	Values	Description
			Proxy Server		Select from a provided list.	<p>Specifies the proxy server to be used by embedded applications in the printer. A proxy server is typically used by network clients for Internet access. It caches Web pages, and provides a degree of Internet security for those clients.</p> <p>To specify a proxy server, enter its IPv4 address or fully-qualified domain name. The name can be up to 255 octets.</p> <p>For some networks, you might need to contact your Internet Service Provider (ISP) for the proxy server address.</p>
			Proxy Port		Default = <b>0080</b>	<p>Enter the port number used by the proxy server for client support. The port number identifies the port reserved for proxy activity on your network, and can be a value from 0 to 65535.</p>
			Idle Timeout		Default = <b>0270</b>	<p>The time period, in seconds, after which an idle TCP print data connection is closed (default is 270 seconds, 0 disables the timeout).</p>

### Copy menu (MFP only)

**To display:** At the printer control panel, select the [Copy](#) menu.

In the following table, asterisks (\*) indicate the factory default setting.

Table 3-12 Copy menu (MFP only)

First level	Second level	Third level	Values	Description	
Sides	Original Sides		1-sided*	Use to indicate whether the original document is printed on one or both sides.	
			2-sided		
	Output Sides		1-sided	Use to indicate whether the copies should be printed on one or both sides.	
			2-sided		
Color/Black			Automatically detect*	Select how the copy should be printed.	
			Color	<b>Automatically detect:</b> Prints color documents in color, and black and white documents in black and white. For mixed documents, the printer will determine whether to print in color or black and white.	
			Black/Gray		
				<b>Color:</b> Prints documents in color. <b>Black:</b> Prints documents in black and white or grayscale.	
Quick Sets and Defaults			Load		
			Save		
Options	Sides	Original Sides	1-sided		
			2-sided		
		Output Sides	1-sided		
			2-sided		
	Color/Black			Automatically detect*	Select how the copy should be printed.
				Color	<b>Automatically detect:</b> Prints color documents in color, and black and white documents in black and white. For mixed documents, the printer will determine whether to print in color or black and white.
				Black/Gray	
					<b>Color:</b> Prints documents in color. <b>Black:</b> Prints documents in black and white or grayscale.
Staple			None	<b>Sets the position of the staple on the page.</b>	
			Top left angled		
			Top right angled		

Table 3-12 Copy menu (MFP only) (continued)

First level	Second level	Third level	Values	Description
	Scan mode		Standard Document	Book Mode allows the user to scan pages from a book.
			Book Mode	
			2-sided ID	2-sided ID allows the user to scan both sides of an identification card onto one sheet.
	Reduce/Enlarge		Automatic*	Use to scale the size of the document up or down. Select one of the predefined percentages, or select the Scaling field and type a percentage between 25 and 400. The Auto option automatically scales the image to fit the paper size in the tray.
			Manual	
	Original Size		Select from a list of sizes that the printer supports.	Describes the page size of the original document.
	Paper Selection		Paper Size	For the best color and image quality, select the appropriate paper type from the control panel menu or from the print driver.
			Paper Type	
			Paper Tray	
Booklet		Booklet Format	(Checkbox)	Use to copy two or more pages onto one sheet of paper so you can fold the sheets in the center to form a booklet. The printer arranges the pages in the correct order. For example, if the original document has eight pages, the printer prints pages 1 and 8 on the same sheet.
	Content Orientation		Auto Detect	For some features to work correctly, you must specify the way the content of the original document is placed on the page. Portrait orientation means the short edge of the page is along the top. Landscape orientation means the long edge of the page is along the top. In the Orientation area, select whether the original document has a portrait or landscape orientation.
			Portrait*	
			Landscape	

Table 3-12 Copy menu (MFP only) (continued)

First level	Second level	Third level	Values	Description
	Pages per Sheet		One (1) Two (2) Four (4)	Copies multiple pages onto one sheet of paper.  <b>NOTE:</b> Before using this screen, use the <a href="#">Content Orientation</a> screen to describe the original document orientation.
	Image Adjustment	Sharpness		Adjust the <a href="#">Sharpness</a> setting to clarify or soften the image. For example, increasing the sharpness could make text appear crisper, but decreasing it could make photographs appear smoother.
		Darkness		Use to improve the overall quality of the copy.  Adjust the <a href="#">Darkness</a> setting to increase or decrease the amount of white and black in the colors.
		Contrast		Adjust the <a href="#">Contrast</a> setting to increase or decrease the difference between the lightest and darkest color on the page.
		Background Cleanup		Adjust the <a href="#">Background Cleanup</a> setting if you are having trouble copying a faint image.
	Optimize Text/Picture	Manually Adjust*	Optimize For: Text Mixed Printed picture Photograph	Optimizes the output for a particular type of content. You can optimize the output for text, printed pictures, or a mixture.  <b>Manually Adjust:</b> Use to manually optimize the setting for text or for pictures.  <b>Text:</b> Use to optimize the text portion of the copy where text and/or pictures are on the original.  <b>Printed picture:</b> Use for line drawings and preprinted images, such as magazine clippings or pages from books.  <b>Photograph:</b> Best suited for making copies of printed pictures.

Table 3-12 Copy menu (MFP only) (continued)

First level	Second level	Third level	Values	Description
	Erase Edges	Front Side	Use inches Apply same width to all edges Top edge Bottom edge Left edge Right edge	Use this menu item to remove blemishes, such as dark borders or staple marks, by cleaning the specified edges of the scanned image. In each of the text boxes enter the measurements, in millimeters or inches, for how much of the top edge, bottom edge, left edge, and right edge to clean.
		Back Side	Use inches Mirror front side Top edge Bottom edge Left edge Right edge	
	Collate		Collate on (Sets in page order)* Collate off (Pages grouped)	If you are making more than one copy, select the <a href="#">Collate on (Sets in page order)</a> option to assemble the pages in the correct order in each set of copies.  Select the <a href="#">Collate off (Pages grouped)</a> option to group the same pages together. For example, if you are making five copies of an original document that has two pages, all five first pages would be grouped together and all five second pages would be grouped together.
	Multi-feed Detection		Enabled* Disabled	This setting stops the scanning process if it detects multiple-page feeds through the document feeder.
	Output Bin		Automatically select Standard bin Upper bin Middle bin	

## Scan menu (MFP only)

**To display:** At the printer control panel, select the [Scan](#) menu.

In the following table, asterisks (\*) indicate the factory default setting.

**Table 3-13 Scan menu (MFP)**

First level	Second level	Third level	Fourth level	Values	Description
Scan to Email					
Scan to Network Folder	Folder Paths				
	File Name				
	Quick Sets and Defaults				
	Options	File Type and Resolution			
		Original sides		1-sided 2-sided	Use to describe the layout for each side of the original document. First select whether the original document is printed on one side or both sides. Then touch the <a href="#">Orientation</a> setting to indicate whether the original has portrait or landscape orientation. If it is printed on both sides, also select the 2-sided format that matches the original document.
		Color/Black		Automatically detect* Color Black/Gray Black	Use to enable or disable color scanning.  <a href="#">Automatically detect</a> : Automatically scans documents in color if at least one page has color.  <a href="#">Color</a> : Scans documents in color.  <a href="#">Black/Gray</a> : Scans documents in grayscale.  <a href="#">Black</a> : Scans documents in black and white with a compressed file size.
		Original Size		Select from a list of supported sizes.	Use to describe the page size of the original document.

Table 3-13 Scan menu (MFP) (continued)

First level	Second level	Third level	Fourth level	Values	Description
		Content Orientation	Orientation	Automatically Detect Portrait* Landscape	For some features to work correctly, you must specify the way the content of the original document is placed on the page. Portrait orientation means the short edge of the page is along the top. Landscape orientation means the long edge of the page is along the top. In the Orientation area, select whether the original document has a portrait or landscape orientation.
		Image Adjustment	Darkness		Use to improve the overall quality of the copy. Adjust the <a href="#">Darkness</a> setting to increase or decrease the amount of white and black in the colors.
			Contrast		Adjust the <a href="#">Contrast</a> setting to increase or decrease the difference between the lightest and darkest color on the page.
			Background Cleanup		Adjust the <a href="#">Background Cleanup</a> setting if you are having trouble copying a faint image.
			Sharpness		Adjust the <a href="#">Sharpness</a> setting to clarify or soften the image. For example, increasing the sharpness could make text appear crisper, but decreasing it could make photographs appear smoother.
			Automatic Tone		The printer automatically adjusts the <a href="#">Darkness</a> , <a href="#">Contrast</a> , and <a href="#">Background Cleanup</a> settings to the most appropriate for the scanned document.



Table 3-13 Scan menu (MFP) (continued)

First level	Second level	Third level	Fourth level	Values	Description
			Default		Select this to make the selected <a href="#">Image Adjustment</a> setting the default value.
		Optimize Text/Picture			
		Erase Edges		Use inches Back side erase Front side erase	Use this menu item to remove blemishes, such as dark borders or staple marks, by cleaning the specified edges of the scanned image. In each of the text boxes enter the measurements, in millimeters or inches, for how much of the top edge, bottom edge, left edge, and right edge to clean.
		Cropping Options		Do not crop Crop to content Crop to paper	Use this menu item to automatically crop the scan for digital sending. Use the <a href="#">Crop to content</a> option to scan the smallest possible area that has detectable content.
		Automatically Straighten			
		Blank Page Suppression		Disabled Enabled	Use to prevent blank pages in the original document from being included in the output document.
		Multi-feed Detection		Disabled Enabled*	This setting stops the scanning process if it detects multiple-page feeds through the document feeder.
		Create Multiple Files		Disabled Enabled	Enable this item to scan pages into separate files based on a specified page limit.  A page is one side of an original document.  JPEG and TIFF have a limit of one page per file.

Table 3-13 Scan menu (MFP) (continued)

First level	Second level	Third level	Fourth level	Values	Description
		Notification		Do not notify Notify when job completes Notify only if job fails Print E-mail	Configure to receive notification about the status of a sent document.  <b>Do not notify:</b> Turns off this feature.  <b>Notify when job completes:</b> Select to receive notification for this job only.  <b>Notify only if job fails:</b> Select to receive notification only if the job is not sent successfully.  <b>Print:</b> Select to print the notification at this printer.  <b>E-mail:</b> Select to receive the notification to an email account.
			Include Thumbnail		Select <b>Include Thumbnail</b> to receive a thumbnail image of the first page of the job in your notification.
			Notification Email		<b>E-mail:</b> Select to receive the notification in an email. Touch the text box following <b>Email Address</b> , and then type the email address for the notification.
Scan to USB Drive	Destination				
	Job Name				
	Options	File Type and Resolution			

Table 3-13 Scan menu (MFP) (continued)

First level	Second level	Third level	Fourth level	Values	Description
		Original sides		1-sided 2-sided	Use to describe the layout for each side of the original document. First select whether the original document is printed on one side or both sides. Then touch the <a href="#">Orientation</a> setting to indicate whether the original has portrait or landscape orientation. If it is printed on both sides, also select the 2-sided format that matches the original document.
		Color/Black		Automatically detect* Color Black/Gray Black	Use to enable or disable color scanning.  <a href="#">Automatically detect</a> : Automatically scans documents in color if at least one page has color.  <a href="#">Color</a> : Scans documents in color.  <a href="#">Black/Gray</a> : Scans documents in grayscale.  <a href="#">Black</a> : Scans documents in black and white with a compressed file size.
		Original Size		Select from a list of supported sizes.	Use to describe the page size of the original document.
		Content Orientation		Automatically detect Portrait* Landscape	For some features to work correctly, you must specify the way the content of the original document is placed on the page. Portrait orientation means the short edge of the page is along the top. Landscape orientation means the long edge of the page is along the top. In the <a href="#">Orientation</a> area, select whether the original document has a portrait or landscape orientation.

Table 3-13 Scan menu (MFP) (continued)

First level	Second level	Third level	Fourth level	Values	Description
		Image Adjustment	Darkness		Use to improve the overall quality of the copy. Adjust the <a href="#">Darkness</a> setting to increase or decrease the amount of white and black in the colors.
			Contrast		Adjust the <a href="#">Contrast</a> setting to increase or decrease the difference between the lightest and darkest color on the page.
			Background Cleanup		Adjust the <a href="#">Background Cleanup</a> setting if you are having trouble copying a faint image.
			Sharpness		Adjust the <a href="#">Sharpness</a> setting to clarify or soften the image. For example, increasing the sharpness could make text appear crisper, but decreasing it could make photographs appear smoother.
			Automatic Tone		The printer automatically adjusts the <a href="#">Darkness</a> , <a href="#">Contrast</a> , and <a href="#">Background Cleanup</a> settings to the most appropriate for the scanned document.
			Default		Select this to make the selected <a href="#">Image Adjustment</a> setting the default value.

Table 3-13 Scan menu (MFP) (continued)

First level	Second level	Third level	Fourth level	Values	Description
		Optimize Text/Picture		Manually Adjust* Text Printed picture Photograph	Use to optimize the output for a particular type of content. You can optimize the output for text, printed pictures, or a mixture.  <b>Manually Adjust:</b> Use to manually optimize the setting for text or for pictures.  <b>Text:</b> Use to optimize the text portion of the copy when text and/or pictures are on the original.  <b>Printed picture:</b> Use for line drawings and preprinted images, such as magazine clippings or pages from books.  <b>Photograph:</b> Best suited for making copies of printed pictures.
		Erase Edges		Use inches Back side erase Front side erase	Use this menu item to remove blemishes, such as dark borders or staple marks, by cleaning the specified edges of the scanned image. In each of the text boxes enter the measurements, in millimeters or inches, for how much of the top edge, bottom edge, left edge, and right edge to clean.
		Cropping Options		Do not crop Crop to content Crop to paper	Use this menu item to automatically crop the scan for digital sending. Use the <b>Crop to content</b> option to scan the smallest possible area that has detectable content.
		Automatically Straighten			
		Blank Page Suppression		Disabled Enabled	Use to prevent blank pages in the original document from being included in the output document.

Table 3-13 Scan menu (MFP) (continued)

First level	Second level	Third level	Fourth level	Values	Description
		Multi-feed Detection		Disabled Enabled*	This setting stops the scanning process if it detects multiple-page feeds through the document feeder.
		Create Multiple Files		Disabled Enabled	Enable this item to scan pages into separate files based on a specified page limit.  A page is one side of an original document.  JPEG and TIFF have a limit of one page per file.
		Notification		Do not notify Notify when job completes Notify only if job fails Print E-mail	Configure to receive notification about the status of a sent document.  <b>Do not notify:</b> Turns off this feature.  <b>Notify when job completes:</b> Select to receive notification for this job only.  <b>Notify only if job fails:</b> Select to receive notification only if the job is not sent successfully.  <b>Print:</b> Select to print the notification at this printer.  <b>E-mail:</b> Select to receive the notification to an email account.
			Include Thumbnail		Select <b>Include Thumbnail</b> to receive a thumbnail image of the first page of the job in your notification.
			Notification Email		<b>E-mail:</b> Select to receive the notification in an email. Touch the text box following <b>Email Address</b> , and then type the email address for the notification.
	Scan to Job Storage			Folder Job Name	

## Fax menu (fax models only)

**To display:** At the printer control panel, select the [Fax](#) menu.

In the following table, asterisks (\*) indicate the factory default setting.

**Table 3-14 Fax menu (fax models only)**

First level	Second level	Third level	Values	Description
Dialing Prefix				
Fax Recipients				
Quick Sets and Defaults				
Options	Original Sides		1-sided* 2-sided	Use to describe the layout for each side of the original document. First select whether the original document is printed on one side or both sides. Then touch the <a href="#">Orientation</a> setting to indicate whether the original has portrait or landscape orientation. If it is printed on both sides, also select the 2-sided format that matches the original document.
	Resolution		Standard (100 x 200dpi)* Fine (200 x 200dpi) Superfine (300 x 300dpi)	Select the resolution for outgoing faxes. If you increase the resolution, faxes might be clearer but they could transmit more slowly. Some file types, for example a file that will be processed with OCR, require a specific resolution. When these file types are selected, the <a href="#">Resolution</a> setting might be automatically changed to a valid value.
	Original Size		Select from a list of sizes that the printer supports.	Use to describe the page size of the original document.
	Content Orientation	Orientation	Portrait* Landscape	For some features to work correctly, you must specify the way the content of the original document is placed on the page.  <a href="#">Portrait</a> : This setting means the short edge of the page is along the top.  <a href="#">Landscape</a> : This setting means the long edge of the page is along the top.

Table 3-14 Fax menu (fax models only) (continued)

First level	Second level	Third level	Values	Description
	Image Adjustment	Darkness		Use to improve the overall quality of the copy.  Adjust the <a href="#">Darkness</a> setting to increase or decrease the amount of white and black in the colors.
		Contrast		Adjust the <a href="#">Contrast</a> setting to increase or decrease the difference between the lightest and darkest color on the page.
		Background Cleanup		Adjust the <a href="#">Background Cleanup</a> setting if you are having trouble copying a faint image.
		Sharpness		Adjust the <a href="#">Sharpness</a> setting to clarify or soften the image. For example, increasing the sharpness could make text appear crisper, but decreasing it could make photographs appear smoother.
		Automatic Tone		The printer automatically adjusts the <a href="#">Darkness</a> , <a href="#">Contrast</a> , and <a href="#">Background Cleanup</a> settings to the most appropriate for the scanned document.
		Default		Select this to make the selected <a href="#">Image Adjustment</a> setting the default value.



Table 3-14 Fax menu (fax models only) (continued)

First level	Second level	Third level	Values	Description
	Optimize Text/Picture	Manually Adjust*	Optimize For: Text Printed picture Photograph	<p>Optimizes the output for a particular type of content. You can optimize the output for text, printed pictures, or a mixture.</p> <p><b>Manually Adjust:</b> Use to manually optimize the setting for text or for pictures.</p> <p><b>Text:</b> Use to optimize the text portion of the copy where text and/or pictures are on the original.</p> <p><b>Printed picture:</b> Use for line drawings and preprinted images, such as magazine clippings or pages from books.</p> <p><b>Photograph:</b> Best suited for making copies of printed pictures.</p>
	Blank Page Suppression		Disabled* Enabled	Prevents blank pages in the original document from being included in the output document.
	Multi-feed Detection		Disabled Enabled*	Use this feature to prevent multiple pages being fed through the document feeder during document scans.
	Notification		Do not notify* Notify when job completes Notify only if job fails  Print E-mail	<p>Use to receive notification about the status of a sent document.</p> <p><b>Do not notify:</b> Turns off this feature.</p> <p><b>Notify when job completes:</b> Select to receive notification for this job only.</p> <p><b>Notify only if job fails:</b> Select to receive notification only if the job is not sent successfully.</p> <p><b>Print:</b> Select to print the notification at this printer.</p> <p><b>E-mail:</b> Select to receive the notification in an email. Touch the text box following <b>Email Address</b>, and then enter the email address for the notification.</p>

**Table 3-14 Fax menu (fax models only) (continued)**

First level	Second level	Third level	Values	Description
		Include Thumbnail		When sending an analog fax, select <b>Include Thumbnail</b> to receive a thumbnail image of the first page of the fax in your notification.
		Notification E-mail address		Provide the email address that will receive notifications.
		2-Sided Format	<b>Book-style*</b> <b>Flip-style</b>	Use to configure the default style for 2-sided print jobs. If the <b>Book-style</b> option is selected, the back side of the page is printed the right way up. This option is for print jobs that are bound along the left edge. If the <b>Flip-style</b> option is selected, the back side of the page is printed upside-down. This option is for print jobs that are bound along the top edge.

## Print menu

**To display:** At the printer control panel, select the **Print** menu.

In the following table, asterisks (\*) indicate the factory default setting.

**Table 3-15 Print Options menu**

First level	Second level	Values	Description
Print from Job Storage	Stored Job to Print	Untitled Stored Faxes	Print a job stored on the printer.
Print from USB Drive	Stored Job to Print	Choose file to print on USB drive.	Print a job stored on a USB drive.
Fax Polling	Fax Polling Number		

## Supplies menu

**To display:** At the printer control panel, select the **Supplies** menu.

In the following table, asterisks (\*) indicate the factory default setting.

**Table 3-16 Supplies menu**

First level	Values	Description
Supplies Summary		

**Table 3-16 Supplies menu (continued)**

First level	Values	Description
Black Cartridge	Status	
Cyan Cartridge	Order HP Part	
Magenta Cartridge	Pages Printed	
Yellow Cartridge	Approximate Pages Remaining	
Toner Collection Unit	Status	
Transfer Kit	Order HP Part	
Fuser Kit		
Document Feeder Kit		
Stapler 1		

## Trays menu

**To display:** At the printer control panel, select the [Trays](#) menu.

In the following table, asterisks (\*) indicate the factory default setting.

**Table 3-17 Trays menu**

First level	Second level	Values	Description
Tray 1	Size	Select paper size from a list of supported sizes.	Choose the paper size for the tray
Tray 2-x	Type	Select paper type from a list of supported types.	Choose the paper type for the tray.

## Troubleshooting menu

**To display:** At the product control panel, select the [Support Tools](#) menu, and then select the [Troubleshooting](#) menu.

In the following table, asterisks (\*) indicate the factory default setting.

Table 3-18 Troubleshooting

First level	Second level	Third level	Fourth level	Values	Description
Configuration/Status Pages	• Settings Menu Map				Select the configuration/Status reports to review, and then touch the <a href="#">Print</a> or <a href="#">View</a> button.
	• Current Settings Page				
	• Configuration Page				
	• How to Connect Page				
	• Supplies Status Page				
	• sage Page				
	• File Directory Page				
	• Web Services Status Page				
	• Color Usage Job Log				
Reports					
Other Pages	• Demonstration Page				
	• RGB Samples				
	• CMYK Samples				
	• PCL Font List				
	• PS Font List				
Event Log				<a href="#">Print</a>	Prints the 50 most recent events in the Event Log. For each event, the printed log shows the error number, page count, error code, and description or personality.
Paper Path Page				<a href="#">View</a> <a href="#">Print</a>	Shows how many pages were printed from each tray.
Fax (Fax is optional)	<a href="#">Fax T.30 Trace</a>	<a href="#">Print T.30 Report</a>		<a href="#">Print</a>	Use to print or configure the fax T.30 trace report. T.30 is the standard that specifies handshaking, protocols, and error correction between fax machines.

Table 3-18 Troubleshooting (continued)

First level	Second level	Third level	Fourth level	Values	Description
		When to Print Report		Never automatically print* Print after every fax Print only after fax send jobs Print after any fax error Print only after fax send errors Print only after fax receive errors	Configure the T.30 report to print after certain events. You can choose to print the report after every fax job, every fax job sent, every fax job received, every send error, or every receive error.
	Fax V.34			Normal* Off	Use to disable V.34 modulations if several fax failures have occurred or if phone line conditions require it.
	Fax Speaker Mode			Normal* Diagnostic	Used by a technician to evaluate and diagnose fax issues by listening to the sounds of fax modulations
	Fax Log Entries			On Off*	The standard fax log includes basic information such as the time and whether the fax was successful. The detailed fax log shows the intermediate results of the redial process not shown in the standard fax log.
Print Quality Pages	Print Fuser Test Page			Print	Use to print pages that help you resolve problems with print quality.
Diagnostic Tests					
	Continuous Scan			2-sided	
	Run Fax Test			Start	Use this menu to perform a test on specific components within the product to determine whether the components are functioning correctly.

Table 3-18 Troubleshooting (continued)

First level	Second level	Third level	Fourth level	Values	Description
Retrieve Diagnostic Data				Insert a US drive into the USB port. The exported data might contain personally identifiable information.	Create files that contain information about the product that can help identify the cause of problems.
Generate Debug Data				Start	

## Maintenance menu

Learn about the Maintenance menu.

## Backup/Restore menu

**To display:** At the product control panel, select [Support Tools](#) and then [Maintenance](#), and then select the [Backup/Restore](#) menu.

In the following table, asterisks (\*) indicate the factory default setting.

**Table 3-19 Backup/Restore menu**

First level	Second level	Third level	Values	Description
Backup Data	Enable Scheduled Backups	Backup Time	Enter a time	
		Days Between Backups	Enter the number of days	
	Backup Now			
	Export Last Backup			
Restore Data			Insert a USB drive that contains the backup file.	

## Calibration/Cleaning menu

**To display:** At the product control panel, select the [Maintenance](#) menu, and then select the [Calibrate/Cleaning](#) menu.

In the following table, asterisks (\*) indicate the factory default setting.

**Table 3-20 Calibrate/Cleaning menu**

First level	Second level	Values	Description
Calibration/Cleaning Page		Print	Use to process the cleaning page that was created by using the <a href="#">Create Cleaning Page</a> menu. The process takes up to 1.5 minutes.

**Table 3-20** Calibrate/Cleaning menu (continued)

First level	Second level	Values	Description
Calibration		Start	<p>The product automatically calibrates itself at various times. However, you can calibrate the product immediately if you see problems with print quality. Use this feature to perform a full calibration, which can take up to three minutes. Use this calibration if the color layers seem to be shifted on the page.</p> <p>Before calibrating the product, make sure that the <b>Ready</b> indicator displays on the control-panel display. If a job is in progress, the calibration occurs when that job is complete.</p>
Delay Calibration at Wake/Power On		<p>No Delay</p> <p>Delay 15 minutes</p>	<p>Controls the timing of power-on calibration when the product wakes up or is turned on.</p> <p><b>Wake:</b> Select if you are not using the feature and want to print jobs immediately when the product wakes up or is turned on, before calibration begins.</p> <p><b>No:</b> The product will calibrate immediately when it wakes up or is turned on. The product will not print any jobs until it finishes calibrating.</p> <p><b>Yes:</b> Enables the product that is asleep to accept print jobs before it calibrates. It might start calibrating before it has printed all the jobs it has received. This option allows quicker printing when coming out of sleep mode or when you turn the product on, but print quality might be reduced.</p> <p><b>NOTE:</b> For the best results, allow the product to calibrate before printing. Print jobs performed before calibration might not be of the highest quality.</p>

### USB Firmware Upgrade menu

**To display:** At the product control panel, select the **Maintenance** menu, and then select the **USB Firmware Upgrade** menu.

Insert a USB storage device with a firmware upgrade bundle into the USB port, and follow the on-screen instructions.



# Clear paper jams

Learn about clearing paper jams.

## Paper jam locations

Learn about paper jam locations.



1	Tray 1
2	Tray 2
3	Tray 3

### 13.A1 tray 1 paper jam

Learn about A1 tray 1 paper jams.

Use the following procedure to check for paper in all possible jam locations related to the Tray 1. When a jam occurs, the control panel might display a message and an animation that assists in clearing the jam.

- 13.A1.XX Jam in tray 1

1. Gently remove the jammed paper.



2. Open and then close the front door to resume printing.

## 13.A2, 13.A3 tray 2, tray 3 paper jam

Learn about A2, 13.A3 tray 2, tray 3 paper jams.

Use the following procedure to check for paper in all possible jam locations related to Tray 2 or Tray 3. When a jam occurs, the control panel might display a message and an animation that assists in clearing the jam.

- 13.A2.XX Jam in tray 2
- 13.A3.XX Jam in tray 3

---

**CAUTION:** The fuser can be hot while the printer is in use. Wait for the fuser to cool before handling it.

**NOTE:** The procedure to clear a paper jam in Tray 3 is the same as for Tray 2. Only Tray 2 is shown here.

---

1. Open the right door.



2. Gently remove any jammed paper.



3. Close the right door.



4. Open the tray.



5. Gently remove any jammed paper.



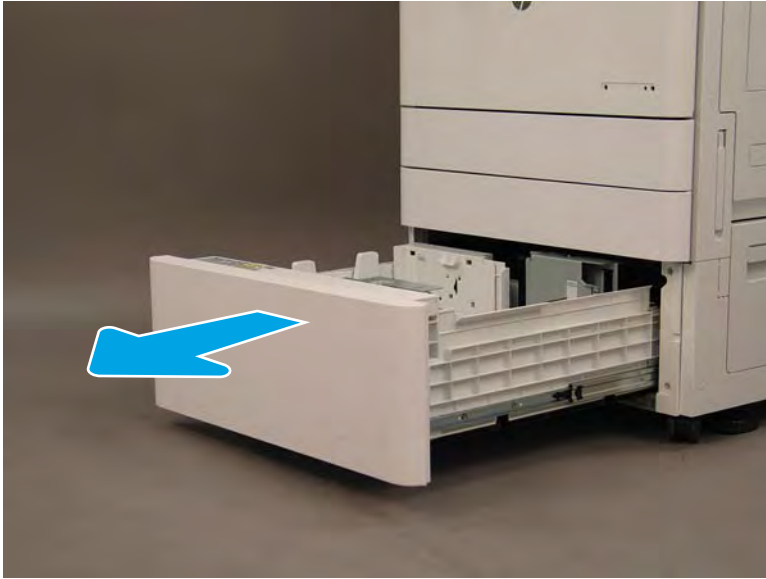
6. Close the tray. Printing automatically resumes.



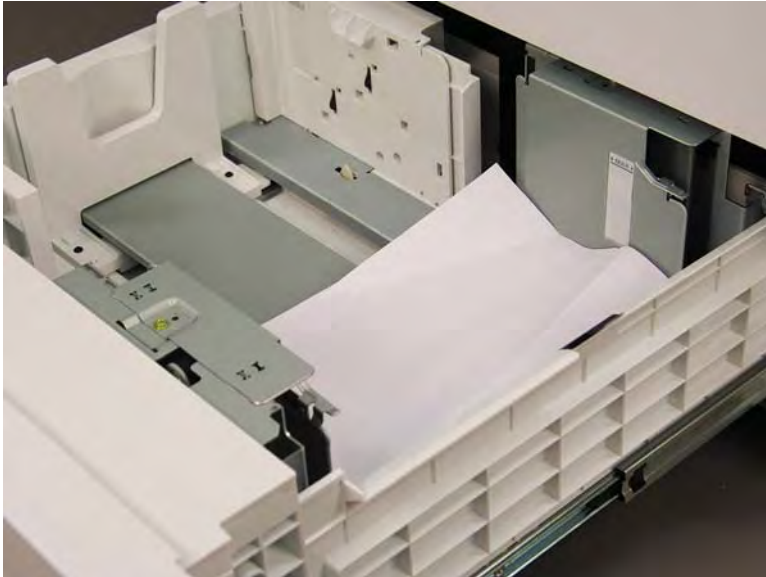
## Clear paper jams in the Bottom HCI

Learn about clearing paper jams in the bottom HCI.

1. Open the HCI.



2. Remove any jammed paper.



3. Close the HCI.

## Service mode (tech mode)

Learn about service mode (tech mode).

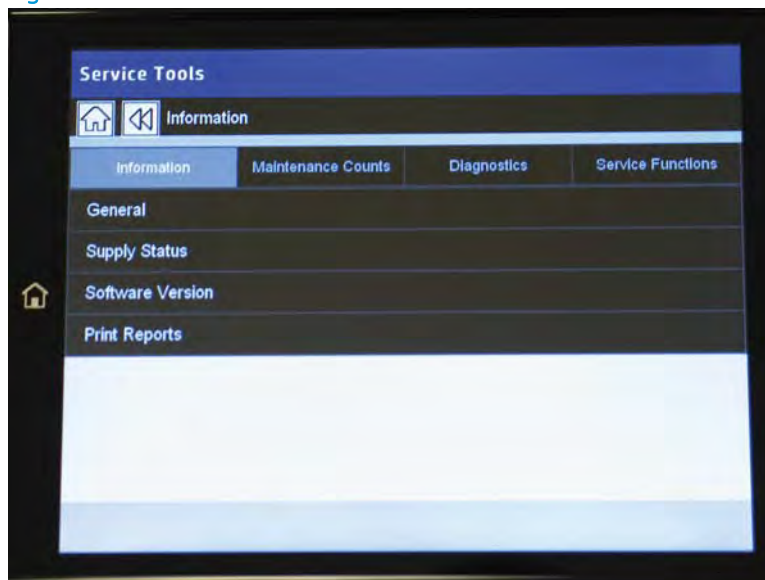
In service (tech) mode, the technician can check the printer and perform various tests to isolate the cause of a malfunction. While in service mode, the printer still performs all normal operations.

### Entering service mode

Learn about entering service mode.

1. From the control panel, select **Support tools** and then **Service**.
2. Enter the Service PIN ID.
  - 04077817
3. Select **Service tools**.

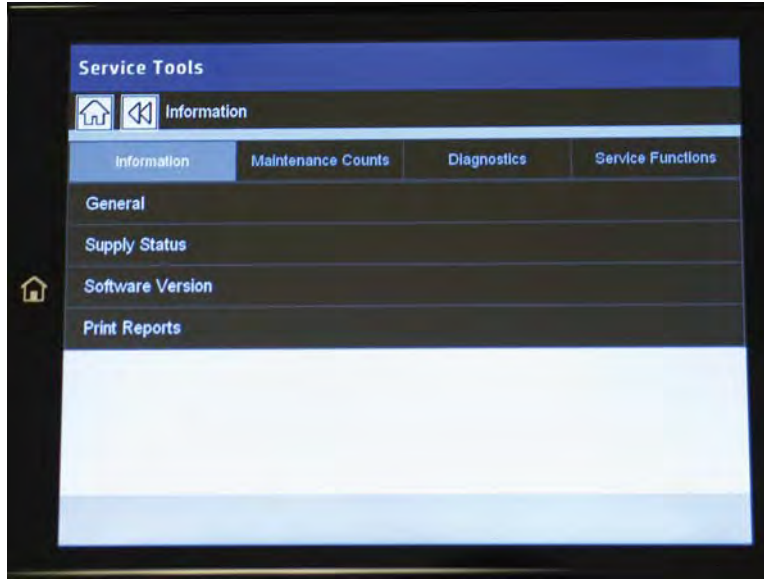
Figure 3-34 Service tools view



### Service mode menu tree

Learn about the service mode menu tree.

Figure 3-35 Information

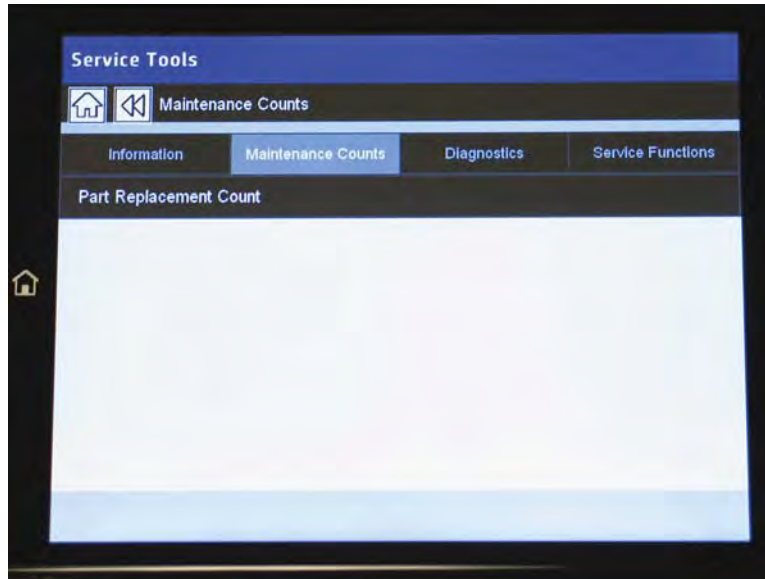


Level 1	Level 2	Level 3	Level 4	
Information	General	Engine Board Serial Number		
	Supply Status	Customer Replacement Unit	Toner CMYK	
		Field Replacement Unit	Imaging Unit (Drum) CMYK	
			Development Unit	
			Toner Collection Unit	
			Image Transfer Belt (ITB)	
			ITB Cleaner	
			Fuser	
			Tray x rollers	
	ADF Pickup Roller			
	ADF Separation Roller			
	Software Version	System Firmware Version		
		Main Firmware Version		
		Engine Firmware Version		
		Boot ROM Version		
		File System Version		
		ADF Firmware Version		
		Finisher Version		
		Scanner Version		
	Scan Control Version			
	Tray 2-5 Version			



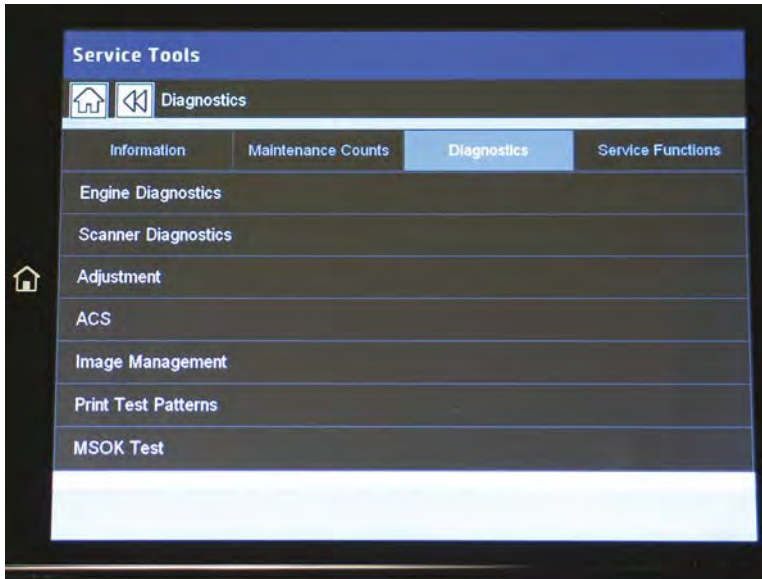
Level 1	Level 2	Level 3	Level 4
		Fuser Version	
		Transfer Version	
		Toner Version	
		Print CMS Version	
		Copy CMS Version	
		Scan CMS Version	
	Print Reports	Supplies Information	
		Usage Counter	
		Error Information	
		Fax Protocol Dump (Line 1)	
		Fax Protocol Dump (Line 2)	
		Fax Diagnostics (Line 1)	
		Fax Diagnostics (Line 2)	
		Auto Color Registration	
		Job Duty	
		Auto Toning History	
		Full Auto Color Registration	
		ID Calibration History	
		Maintenance	
		Toner Event	
	Export Reports	RTF Format	
		XML Format	
		PDF Format	

Figure 3-36 Maintenance counts



Level 1	Level 2	Level 3	Level 4
Maintenance counts	Part Replacement Count	Toner Cartridge CMYK	
		Imaging Unit (Drum) CMYK	
		Development Unit (Developer CMYK	
		Image Transfer Belt (ITB)	
		ITB Cleaner	
		Transfer Roller/T2 Roller	
		Fuser	
		Tray x rollers	
		Filter	
		ADF Pickup Roller	
		ADF Seperation Roller	

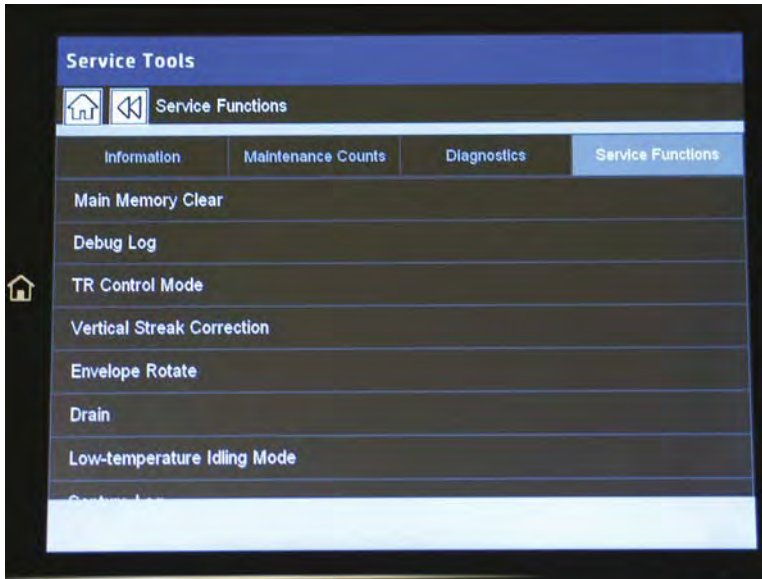
Figure 3-37 Diagnostics



Level 1	Level 2	Level 3	Level 4
Diagnostics	Engine Diagnostics	General Engine Board Serial Number	
	Engine Diagnostics	Engine NVM Initialization	
		Engine NVM Read/Write	
		Engine Test Routines	
	Fax Diagnostics	Fax NVM Read/Write	
		Fax Test Routines	
	Scanner Diagnostics	Shading Test	Shade and Print Report
			Print Last Shade Report
			Shade and Print Report (ADF)
P			Print Last Shade Report (ADF)
		Scanner/ADF NVM Read/Write	ADF Pickup Roller Count
			ADF Separation Roller Count
			Simplex Registration Value (Registration 1)
			Duplex Registration Value (Registration 2)
			Width Guide Max Value
			Width Guide Min Value
			USM 0 Ref Value
			USM 1 Ref Value
		Scanner/ADF Test Routines	Chose from a list of tests.
	Adjustment	Print Adjustment	Image Position

Level 1	Level 2	Level 3	Level 4
			Print Margin Test
		Copy Adjustment	Image Position
		Scan Area Adjustment	Automatic Adjustment
			Manual Adjustment
		ADF Adjustment	Automatic Adjustment
			Manual Adjustment
	ACS	ACS Page Adjustment	[1–5]: 5*
	Image Management	ACR Reference Adjustment	Full
		Cancel ACR Reference Adjustment	
		Auto Color Registration	
		Full Auto Color Registration	
		Customer Color	
		Auto Tone Adjustment Activation	
		Auto Tone Adjustment	
		Setting Standard Tone	
		Cancel Setting Standard Tone	
		Auto Color Balance	
		Cancel Auto Color Balance	
		Manual Tone Adjustment	
	Print Test Patterns	EP Calibration Pattern 1 Contone	
		EP Calibration Pattern 2 Halftone	
		Tone Curve Int Calibration YM Pattern	
		Tone Curve Int Calibration CK Pattern	
		Tone Curve Ext Measurement Page	
		Black Mechanical Banding Page	
		Cyan Mechanical Banding Page	
		Magenta Mechanical Banding Page	
		Color Registration Check for Motion	
	MSOK Test	EEPROM Test	

Figure 3-38 Service functions



Level 1	Level 2	Level 3	Level 4
Service Functions	Main Memory Clear		
	Debug Log	Info	
		Job Status	
	TR Control Mode	TR Control Mode	Paper Group/Paper Side/Paper Direction/T2 PWM
	Vertical Streak Correction		
	Drain	Off	
		On	
	Low Temperature Idling Mode		
	Capture Log		
	IP Setting	IP address (manual entry)	
		Subnet Mask (manual entry)	
		Default Gateway (manual entry)	
	Footer		
	FW Upgrade		
	File Dump Mode	Enable Dump	Generate RGBa
			Generate Raw File
			Generate CMYK
			No Print Mode
			Debugging Mode
			Max Output file No 10
			Enable

Level 1	Level 2	Level 3	Level 4
		Retrieve Dump Image	Safely Remove USB
			Retrieve Dump Image
		Delete Dump Image	Delete Dump Image
		Disable Dump	Disable
	Copy Original Thickness	Thin (42-60 g/m2)	
		Normal*	
		Thick (163-220 g/m2)	
	Scan Original Thickness	Thin (42-60 g/m2)	
		Normal*	
		Thick (163-220 g/m2)	
	Altitude Adjustment	Normal (~1,000 m/3,280 ft)*	
		High 1 (~2,000 m/6562 ft)	
		High 2 (~3000 m/9842 ft)	
		High 3 (~4000 m/13123 ft)	
		High 4 (~5000 m/16404 ft)	
	Humidity	Normal*	
		High 1	
		High 2	
		High 3	
	Vapor Mode		
	Booklet Sub Tray		
	Event Logging		

## Information

Learn more service mode information.

### General

Learn general information about the menus.

#### Information > General

This menu displays the following information:

- Printer serial number
- Ethernet IP address
- Ethernet Mac address
- Optional Ethernet IP address
- Optional Ethernet Mac address
- Total printed impressions
- Installed date and time

## Supply status

Learn about supply status.

#### Information > Supply Status > Customer Replacement Unit

- This menu displays the printer's customer replacement unit status. Users can select one item in the list to check the information of the selected unit.

##### Field replacement unit (FRU)

#### Information > Supply Status > Field Replacement Unit

- This menu displays the printer's field replacement unit status. Users can select one item in the list to check the information of the selected unit.

In this menu, there are five columns: Item, Threshold, Status, Count, and Maximum Life.

- Status: This column shows the current status of the selected item.
  - OK: The current count is smaller than the default warning value.
  - Check: The current count is bigger than the default warning value.
  - OFF: The current count exceeds the maximum life.
- Count: This column shows the current count of the selected item.
- Maximum Life: This column shows the maximum capacity of the selected item.

The technician can edit the default warning value within the given threshold.

Selecting some items will enable the reset button to reset the current count to zero after replacing the unit.

## Software version

Learn about the software version.

### Information > Software Version

- This menu displays the version of the software installed on the printer.

## Print reports

Learn how to print reports.

### Information > Print Reports

This menu displays reports that can be printed from the system. The following reports are available to print:

- Supplies Information
- Auto Toning History

### Information > Print Reports > Auto Toning History



**NOTE:** TRC means Tone Reproduction Curve.

---

This report shows a history of execution of the TRC control. The TRC control preserves color consistency against changes in supplies resulting from long-time use and environmental change. The purpose of the history report is to check if the TRC control is working normally.

- If the TRC control performs normally, **Pass** count must be a non-zero value and **Fail** count must be zero.
- If **Fail** count is not zero, check the image density sensor.



## Maintenance counts

Learn about Maintenance counts.

### Part replacement count

Learn about part replacement count.

This section provides detailed information about the service mode Maintenance Counts tab

#### Maintenance Counts > Part Replacement Count

- This menu displays fault counts. The technician can select one fault group and press **OK** to see detailed fault descriptions. The detailed fault description window displays engine diagnostic codes, descriptions of the fault, and the number of occurrences.

The following table shows the fault groups defined for the system:

**Table 3-21** Fault Count

Item	Item	Item
A1 Motor	H2 Output (Bins) System	S3 Scan System
A2 Fan	M1 Input (Trays) System	S5 UI System
A3 Sensor	M2 Media Path System	S6 Network System
C1 Toner Cartridge Unit	M3 Output (Bins) System	S7 HDD System
C3 Imaging Unit	M4 ADF System	U1 Fusing Unit
C7 Fusing Unit	S1 Video System	U2 Laser Scanner Assembly Unit
H1 Input (Trays) System	S2 Engine System	

#### Maintenance Counts > Part Replacement Count

- This menu displays the replacement counts for the system parts. Users can select one group and press **OK** to see the exact name of the part and the occurrence of the replacement.

The following table shows replaceable parts groups of the system:

**Table 3-22** Part Replacement Count

Unit	Item	Sensing Method
Toner Cartridge	Toner (Black)	Auto Sensing
Imaging Unit	Imaging Unit (Black)	Auto Sensing
Fuser	Fuser	Auto Sensing
ITB	ITB	Count Clear
ITB Cleaner	ITB Cleaner	Count Clear
Transfer Roller	Transfer Roller	Count Clear
Roller	Tray 2 Roller	Count Clear
Roller	Tray 3 Roller	Count Clear
Roller	Tray 4 Roller	Count Clear

**Table 3-22** Part Replacement Count (continued)

<b>Unit</b>	<b>Item</b>	<b>Sensing Method</b>
Roller	Tray 5 Roller	Count Clear
ADF Roller	ADF Pick Roller	Count Clear
ADF Roller	ADF Separation Roller	Count Clear
Filter	Ozone filter	

## Diagnostics

Learn about diagnostics.

### Engine diagnostics

Learn about the engine diagnostics.

#### Diagnostics > Engine Diagnostics > Engine NVM Initialization

- This menu initializes all engine NVM values to the default.

#### Diagnostics > Engine Diagnostics > Engine NVM Read/Write

**Table 3-23** Engine Diagnostics (Engine NVM Read/Write)

Purpose	To change a configuration value for the engine firmware
Operation procedure	<p>When the main <b>NVM Read/Write</b> window displays, users can navigate through the list of codes with descriptions and saved values.</p> <p>Users can also input a code through the text box to find a configuration value directly.</p> <p>After selecting one value, press the <b>Edit</b> button to open an interface for user input.</p>

**Table 3-24** Engine NVM Read/Write codes

Code	Display	Meaning	Default	Max/Min
109-0200	Standby Center	Temperature offset	10	10
109-0201	Standby Side	Temperature offset	10	10
109-0205	Warmup Center	Temperature offset	10	10
109-0206	Warmup Side	Temperature offset	10	10
109-0255	Thin Center	Temperature offset		
109-0256	Thin Side	Temperature offset	10	10
109-0265	Plain Center	Temperature offset	10	10
109-0266	Plain Side	Temperature offset	10	10
109-0275	Heavy Center	Temperature offset	10	
109-0276	Heavy Side	Temperature offset	10	10
109-0280	Extra Heavy Center	Temperature offset	10	10
109-0281	Extra Heavy Side	Temperature offset	10	10
109-0290	Cardstock Center	Temperature offset	10	10
109-0291	Cardstock Side	Temperature offset	10	10
109-0300	Envelopes Center	Temperature offset	10	10
109-0301	Envelopes Side	Temperature offset	10	10
109-0305	Labels Center	Temperature offset	10	10

**Table 3-24 Engine NVM Read/Write codes (continued)**

Code	Display	Meaning	Default	Max/Min
109-0306	Labels Side	Temperature offset	10	10
109-0310	Thick Center	Temperature offset	10	10
109-0311	Thick Side	Temperature offset	10	10
109-0315	Recycled Center	Temperature offset	10	10
109-0316	Recycled Side	Temperature offset	10	10
109-0320	Special Center	Temperature offset	10	10
109-0321	Special Side	Temperature offset	10	10
109-0325	1200 dpi_thin Center	Temperature offset	10	10
109-0326	1200 dpi_thin Side	Temperature offset	10	10
109-0330	1200 dpi_plain Center	Temperature offset	10	10
109-0331	1200 dpi_plain Side	Temperature offset	10	10
109-0335	1200 dpi_thick Center	Temperature offset	10	10
109-0336	1200 dpi_thick Side	Temperature offset	10	10
112-0120	Manual Color Registration X-Offset Yellow	T Distant from hsync to lsync (multi-hsync) for yellow	100	200/0
112-0130	Manual Color Registration X-Offset Magenta	Distant from hsync to lsync (multi-hsync) for Magenta	100	200/0
112-0140	Manual Color Registration X-Offset Cyan	Distant from hsync to lsync (multi-hsync) for cyan	100	200/0
112-0150	Manual Color Registration X-Offset Black	Distant from hsync to lsync (multi-hsync) for black	100	200/0
112-0160	Manual Color Registration Y-Offset Yellow	Distant from psync to image area for Yellow	100	200/0
112-0170	Manual Color Registration Y-Offset Magenta	Distant from psync to image area for Magenta	100	200/0
112-0180	Manual Color Registration Y-Offset Cyan	Distant from psync to image area for Cyan	100	200/0
112-0190	Manual Color Registration Y-Offset Black	Distant from psync to image area for Black	100	200/0
112-0240	Manual Color Registration Left Width Yellow	Image area left width for yellow	500	1000/0
112-0250	Manual Color Registration Right Width Yellow	Image area right width for yellow	500	1000/0
112-0260	Manual Color Registration Left Width Magenta	Image area left width for magenta	500	1000/0
112-0270	Manual Color Registration Right Width Magenta	Image area right width for magenta	500	1000/0
112-0280	Manual Color Registration Left Width Cyan	Image area left width for cyan	500	1000/0

**Table 3-24 Engine NVM Read/Write codes (continued)**

Code	Display	Meaning	Default	Max/Min
112-0290	Manual Color Registration Right Width Cyan	Image area right width for cyan	500	1000/0
112-0300	Manual Color Registration Left Width Black	Image area left width for black	500	1000/0
112-0310	Manual Color Registration Right Width Black	Image area right width for black	500	1000/0
112-0320	Color Registration Laser Scanner Assembly Skew Yellow	Laser Scanner Assembly skew for yellow	100	200/0
112-0330	Color Registration Laser Scanner Assembly Skew Magenta	Laser Scanner Assembly skew for magenta	100	200/0
112-0340	Color Registration Laser Scanner Assembly Skew Cyan	Laser Scanner Assembly skew for cyan	100	200/0

## Engine test routines

- Diagnostics > Engine Diagnostics > Engine Test Routines

**Table 3-25 Engine Diagnostics (Engine Test Routines)**

Purpose	To perform test routines for the engine
Operation procedure	<p>When the main Engine Test Routines window displays, users can navigate through the list of routines and descriptions that display. Users can directly input an EDC code through the text box to search for a routine. A maximum of three routines can be selected at the same time.</p> <p>After selecting one or more routines, press the <b>OK</b> button to open the test window. The selected routines will display and users can start/start the selected test routine.</p>
Verification	N/A
Specification	N/A
Reference	See the following table.

**Table 3-26 Engine Test Routines codes**

Code	Display	Meaning
100-000 0	Main BLDC Motor	Main BLDC Motor is On/Off
100-000 1	Main BLDC Motor Slow	Main BLDC Motor Slow On/Off
100-004 1	Yellow Drum Motor	
100-004 2	Magenta Drum Motor	

**Table 3-26 Engine Test Routines codes (continued)**

Code	Display	Meaning
100-004 3	Cyan Drum Motor	
100-004 4	Black Drum Motor	
100-004 6	Yellow Drum Motor Ready	
100-004 7	Magenta Drum Motor Ready	
100-004 8	Cyan Drum Motor Ready	
100-004 9	Black Drum Motor Ready	Detects if black drum motor is running at normal speed
100-008 0	ITB Engage Motor	
100-009 0	ITB Engage Sensor	
100-001 0	Main BLDC Motor Ready	Detects if Main BLDC Motor is running at normal speed
100-012 0	Exit Motor Forward Fast	Exit Motor Forward Fast On/Off
100-013 0	Exit Motor Forward Slow	Exit Motor Forward Slow On/Off
100-013 1	Exit Motor Backward	
100-013 2	Exit Motor Backward Slow	
100-014 0	Duplex Motor Forward	Duplex motor forward on/off
100-014 1	Duplex Motor Forward Slow	Duplex motor forward slow on/off
100-016 0	Duplex Fan 1 Run	Start/stop duplex fan 1 run
100-018 0	Duplex Fan 1 Run Ready	Detects if duplex fan 1 is running at normal speed
100-020 0	Tray 2 Elevating Motor	Tray 2 elevate motor on/off
100-021 0	Tray 3 Elevating Motor	Tray 3 elevate motor on/off (optional)
100-022 0	Tray 4 Elevating Motor	Tray 4 elevate motor on/off (optional)
100-023 0	Tray 5 Elevating Motor	Tray 5 elevate motor on/off (optional)

**Table 3-26 Engine Test Routines codes (continued)**

Code	Display	Meaning
100-024 0	Waste Toner Motor	
100-024 1	Waste Toner LED	Waste Toner LED on/off
100-025 0	Waste Toner Full Sensor	Detects if the Waste Toner is full
100-026 0	SMPS Fan Run	Start/stop SMPS fan run
100-027 0	SMPS Fan Run Ready	Detects if SMPS fan is running at normal speed
100-034 0	Feed Motor	
100-034 1	Feed Motor Slow	
100-037 0	Tray 2 Pickup Motor	Tray 2 motor is on/off
100-037 1	Tray 2 Pickup Motor Slow	Tray 2 motor slow on/off
100-038 0	Tray 3 Pickup Motor	Tray 3 motor is on/off
100-038 1	Tray 3 Pickup Motor Slow	Tray 3 motor slow on/off
100-039 0	Tray 4 Pickup Motor	Tray 4 motor is on/off
100-039 1	Tray 4 Pickup Motor Slow	Tray 4 motor slow on/off
100-039 2	Tray 4 Pickup Motor Slowest	Tray 4 motor slowest on/off
100-040 0	Tray 5 Pickup Motor	Tray 5 motor is on/off
100-040 1	Tray 5 Pickup Motor Slow	Tray 5 motor slow on/off
100-041 1	Registration Motor Slow	Registration motor slow on/off
100-041 2	Registration Motor Slowest	Registration motor slowest on/off
100-043 0	Exit 2 Motor Forward	Exit 2 motor is on/off
100-043 1	Exit 2 Motor Forward Slow	Exit 2 motor slow on/off
100-044 0	Exit 2 Motor Backward	Exit 2 Motor is On/Off

**Table 3-26 Engine Test Routines codes (continued)**

Code	Display	Meaning
100-044 1	Exit 2 Motor Backward Slow	Exit 2 Motor Slow Backward On/Off
100-045 0	ITB Motor	
100-046 0	Ready ITB	
100-047 0	DCF Feed Motor	DCF Feed Motor is On/Off
101-005 0	Registration Clutch	Engages drive to registration roller
101-012 1	Tray 2 Feed Motor Slow	Tray 2 Feed Motor Slow On/Off
101-013 0	T2 Feed Motor	T2 Feed Motor On/Off
101-013 1	Tray 3 Feed Motor Slow	Tray 3 Feed Motor Slow On/Off
101-014 1	Tray 4 Feed Motor Slow	Tray 4 Feed Motor Slow On/Off
101-015 1	Tray 5 Feed Motor Slow	Tray 5 Feed Motor Slow On/Off
101-019 0	Out bin Full Sensor	Detects when paper is at Out bin Full Sensor
101-019 1	Out-bin 2 Full Sensor	Detects when paper is at Out-bin 2 Full Sensor
101-027 0	Tray 1 Clutch	Tray 1 Clutch On/Off
101-027 1	Tray 1 Solenoid	Tray 1 Solenoid On/Off
101-028 0	Return Gate Solenoid	Return Gate Solenoid On/Off
102-000 0	Tray 2 Home Position	Detects when Tray 2 is closed
102-001 0	Tray 2 Paper Empty Sensor	Detects when paper is in Tray 2
102-004 1	Tray 2 Paper Size Read	Detects size of paper in Tray 2
102-005 0	Tray 2 Stack Height Sensor	Detects if paper in Tray 2 is elevated to the sensor
102-007 0	Tray 3 Home Position	Detects when Tray 3 is closed
102-008 0	Tray 3 Paper Empty Sensor	Detects when paper is in Tray 3



**Table 3-26 Engine Test Routines codes (continued)**

Code	Display	Meaning
102-011 1	Tray 3 Paper Size Read	Detects size of paper in Tray 3
102-012 0	Tray 3 Stack Height Sensor	Detects if paper in Tray 3 is elevated to the sensor
102-014 0	Tray 4 Home Position	Detects when Tray 4 is closed
102-015 0	Tray 4 Paper Empty Sensor	Detects when paper is in Tray 4
102-018 1	Tray 4 Paper Size Read	Detects size of paper in Tray 4
102-019 0	Tray 4 Stack Height Sensor	Detects if paper in Tray 4 is elevated to the sensor
102-021 0	Tray 5 Home Position	Detect when Tray 5 is closed
102-022 0	Tray 5 Paper Empty Sensor	Detects when paper is in Tray 5
102-025 1	Tray 5 Size Read	Detects paper size in Tray 5
102-026 0	Tray 5 Stack Height Sensor	Detects if paper in Tray 5 is elevated to the sensor
102-028 0	Tray 1 Paper Empty Sensor	Detects when paper is in Tray 1
102-028 1	Tray 1 Paper Size Read	Detects paper size in Tray 1
102-029 0	Feed 1 Sensor	Detects when paper is at the Feed 1 sensor
102-030 0	Tray 3 Feed Sensor (or Door Open)	Detects when paper is at Tray 3 Feed sensor (Optional)
102-032 0	Tray 4 Feed Sensor (or Door Open)	Detects when paper is at Tray 4 Feed sensor (Optional)
102-034 0	Tray 5 Feed Sensor (or Door Open)	Detects when paper is at Tray 5 Feed sensor (Optional)
102-035 2	DCF Feed Cover Open	
102-036 0	Registration Sensor	Detects when paper is at the registration sensor
102-036 1	Fuser Out Sensor	Detects when paper is at the fuser out sensor.
102-037 1	Exit 2 Sensor	Detects when paper is at exit 2 sensor.
102-038 0	Duplex Jam 1 Sensor	Detects when paper is at duplex jam 1 sensor.

**Table 3-26 Engine Test Routines codes (continued)**

<b>Code</b>	<b>Display</b>	<b>Meaning</b>
102-043 5	Front Cover Sensor	Detects status of front cover
102-043 6	Side Cover Sensor	Detects status of side cover
104-000 0	Waste Install Sensor	Detects if waste is installed
106-020 0	HVPS Installed	Detect HVPS unit
107-016 2	Yellow Eraser On	Yellow eraser lamp on/off
107-016 3	Magenta Eraser On	Magenta eraser lamp on/off
107-016 4	Cyan Eraser On	Cyan eraser lamp on/off
107-016 5	Black Eraser On	Black eraser lamp on/off
107-016 9	Black Eraser Detect	Detect black eraser status
109-002 0	Fuser Fan Run Ready	
109-003 0	Fuser Motor Forward	Fuser motor forward on/off
109-003 1	Fuser Motor Backward	Fuser Motor Backward On/Off
109-003 4	Fuser Motor Ready	Detects if Fuser Motor runs at each speed
109-004 0	Fuser Fan Run	
109-014 0	Fuser Gap Home Sensor	Detects if the fuser press is located Home position
109-020 0	Detect Fuser Relay	Detect fuser relay status
109-021 0	Detect Zero Cross Period	Detect zero cross period
109-030 0	Fuser Installed	Detect fuser unit
110-000 0	LSU Motor 1 Run Ready	Detects if LSU motor 1 runs at normal speed
110-006 0	LSU Motor 1 Run	LSU motor 1 on/off
110-014 0	110-0140 LSU HSync1	

**Table 3-26 Engine Test Routines codes (continued)**

Code	Display	Meaning
110-017 0	LSU HSync 4	DetectsLSU HSync 4 (black)
110-020 0	LSU Installed	
110-032 0	LSU Shutter Open	
111-000 0	Toner Dispense Motor Yellow	
111-001 0	Toner Dispense Motor Magenta	
111-002 0	Toner Dispense Motor Cyan	
111-003 0	Toner Dispense Motor Black	Toner dispense (supply) motor on/off
111-004 0	Toner Sensor Yellow	
111-005 0	Toner Sensor Magenta	
111-006 0	Toner Sensor Cyan	
111-007 0	Toner Sensor Black	TC sensor in developer tank
111-011 0	Toner Control Voltage Yellow	Yellow toner voltage on/off
111-012 0	Toner Control Voltage Magenta	Magenta toner voltage on/off
111-013 0	Toner Control Voltage Cyan	Cyan toner voltage on/off
111-014 0	Toner Control Voltage Black	Black toner voltage on/off

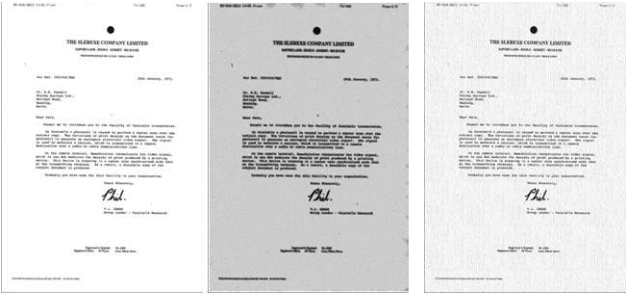
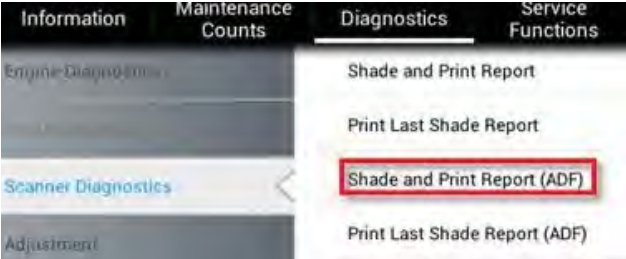
## Scanner diagnostics

Learn about the scanner diagnostics.

### Shading test

- Diagnostics > Scanner Diagnostics > Shading Test

**Table 3-27 Scanner Diagnostics (Shading Test)**

<p>Purpose</p>	<ul style="list-style-type: none"> <li>- To check the quality of scanned images, especially if there might be defects in optical devices such as the lens, mirror, or lamp.</li> <li>- Check the quality problem as shown below:</li> </ul> <div style="display: flex; justify-content: space-around; align-items: center;">  </div> <div style="display: flex; justify-content: space-around; text-align: center;"> <span>Normal Image</span> <span>Defected Image</span> <span>Defected Image</span> </div>
<p>Operation Procedure</p>	<p><b>For the Image Scanner Unit</b></p> <p>Press <b>Shade and Print report</b> to see if the current shading value is correct. Mono, red, green, and blue gray shading values will be shown on the printed report. When the previous shading value is needed, press “Print Last Shade Report”.</p> <p><b>For the Flow ADF unit</b></p> <ol style="list-style-type: none"> <li>1. Load the shading sheet on the ADF tray.</li> <li>2. Enter SCV mode. Select the following menu items: Diagnostics &gt; Scanner Diagnostics &gt; Shading Test &gt; Shade and Print Report (ADF)</li> </ol>  <p>Press <b>Print Last Shade Report (ADF)</b> for the previous shading value report.</p> <ol style="list-style-type: none"> <li>3. Check if the printed results are correct.</li> </ol> <p><b>NOTE:</b></p> <ul style="list-style-type: none"> <li>- When executing ADF shading, use only the shading sheet (JC63-05055A).</li> <li>- A Shading Test for the ADF unit must be completed after replacing the ADF unit or main board.</li> </ul>
<p>Verification</p>	<p>Look at the bottom of the report page for a "RESULTS : OK" message.</p>

**Scanner/Flow ADF NVM Read/Write**

- Diagnostics > Scanner Diagnostics > Scanner/Flow ADF NVM Read/Write

**Table 3-28 Scanner Diagnostics (Scanner/Flow ADF NVM Read/Write)**

Purpose	To read and/or write values in the scanner and ADF memory.
Operation Procedure	<p>When the main <b>NVM Read/Write</b> window displays, users can navigate through the list of codes with descriptions and saved values. Users can also directly input a code through the text box to search for an NVM.</p> <p>After selecting a code, the <b>Edit</b> button will be enabled only if the code is writable.</p> <p>If the selected code is writable and the <b>Edit</b> button is enabled, press the button to configure the desired value for the code.</p>
Verification	N/A
Specification	N/A
Reference	See the following table.

**Table 3-29 Scanner/Flow ADF NVM Read/Write codes**

Code	NVM description	Default	Flow ADF	ADF
05-0000	Pick Up Count	0	0	0
05-0001	Separation Roller Count	0	0	0
05-0030	Simplex Registration Value (Registration 1)	0	X	0
05-0040	Duplex Registration Value (Registration 2)	0		0
05-0050	Width Guide Max Value	Depends on ADF	0	0
05-0060	Width Guide Min Value	Depends on ADF	0	0

**Scanner/Flow ADF test routines**

- Diagnostics > Scanner Diagnostics > Scanner/Flow ADF Test Routines

**Table 3-30 Scanner Diagnostics (Scanner/Flow ADF Test Routines)**

Purpose	To perform test routines for the scanner and Flow ADF.
Operation Procedure	<p>When the main <b>Scanner/ADF Test Routines</b> window displays, users can navigation through the list of routines and descriptions that display. Users can input a code through the text box to search for a routine.</p> <p>After selecting a routine, press <b>OK</b> to open the test window that lists the selected routine. Users can start/stop the selected test routine.</p>
Verification	N/A
Specification	N/A
Reference	See the following table.

**Table 3-31** Scanner/Flow ADF Test Routines codes

Code	Name	Value	Flow ADF	ADF
06-0000	Scanner Original Size Detecting Sensor 1	High/Low	0	0
06-0001	Scanner Original Size Detecting Sensor 2	High/Low	0	0
06-0010	Scanner Cover Open/Close Sensor 1	High/Low	0	0
06-0011	Scanner Cover Open/Close Sensor 2	High/Low	0	0
06-0020	Scanner Platen Motor Forward	Start/Stop	0	0
06-0030	Scanner Platen Motor Backward	Start/Stop	0	0
06-0040	Scanner Platen Home Position Sensor	High/Low	0	0
05-0000	Document Length .1 Sensor	High/Low	0	0
05-0001	Document Length .2 Sensor	High/Low	0	0
05-0020	Document Cover Open Sensor	High/Low	0	0
05-0040	Document Detect Sensor	High/Low	0	0
05-0050	Document Feed Sensor	High/Low	0	0
05-0060	Document Simplex Registration Sensor	High/Low	0	0
05-0061	Document Duplex Registration Sensor		X	
05-0070	Document Scan Read Sensor 1	High/Low	0	0
05-0071	Document Scan Read Sensor 2	High/Low	0	X
05-0080	Document Exit Sensor	High/Low		0
05-0110	Document Motor Forward	Start/Stop		0
05-0111	Document Motor Backward	Start/Stop		0
05-0123	Document width 1 MSO Sensor	High/Low		
05-0124	Document width 2 MSO Sensor	High/Low		
05-0125	Document width 3 MSO Sensor	High/Low		

**Table 3-31 Scanner/Flow ADF Test Routines codes (continued)**

Code	Name	Value	Flow ADF	ADF
05-0130	Document Pickup Motor Forward	Start/Stop		
05-0131	Document Pickup Motor Backward	Start/Stop		
05-0140	Document Pickup Roller Detect Sensor	High/Low	0	0
05-0151	Document Stacker Lift Lower Sensor	High/Low		0
05-0152	Document Stacker Lift Home Position Sensor			
05-0153	Document Scan-In Release Sensor			
05-0154	Document Separation Up Down Sensor			
05-0160	Document Registration 1 Motor Forward	Start/Stop	0	X
05-0162	Document Registration 1 Motor Backward	Start/Stop	0	X
05-0170	Document Registration 2 Motor Forward	Start/Stop		
05-0171	Document Registration 2 Motor Backward	Start/Stop		
05-0180	Document Stacker Lift Motor Forward	Start/Stop		
05-0181	Document Stacker Lift Motor Backward	Start/Stop		
05-0182	Document Exit Motor Forward			
05-0183	Document Exit Motor Backward			
05-0184	Document Pickup Release Motor Forward			
05-0185	Document Pickup Release Motor Backward			
05-0186	Document Scan In Release Motor Forward			
05-0187	Document Scan In Release Motor Backward			
05-0190	Document Width Guide ADC Sensor	10Bit (0~1023)	0	0
05-0191	Document USM ADC Sensor			

**Table 3-31** Scanner/Flow ADF Test Routines codes (continued)

Code	Name	Value	Flow ADF	ADF
05-0192	Document USM Calibration Test			
05-0210	Document Jig Test Low Speed Simplex	Start/Stop	0	0
05-0230	Document Jig Test High Speed Simplex	Start/Stop	0	0

## Adjustment

Learn about the print adjustment.

### Print adjustment

- Diagnostics > Adjustment > Print Adjustment > Image Position

**Table 3-32** Print Adjustment (Image Position)

Purpose	Manually adjust the position of the printed image on the paper in the print engine.
Operational Procedure	<ol style="list-style-type: none"> <li>1. Select a tray to adjust.</li> <li>2. Change the adjustment value using the + or - buttons, then press the <b>OK</b> button to save the changes. <ul style="list-style-type: none"> <li>○ Simplex Leading Edge</li> <li>○ Simplex Side Edge</li> <li>○ Duplex Leading Edge</li> <li>○ Duplex Side Edge</li> </ul> <p><b>NOTE:</b></p> <ul style="list-style-type: none"> <li>○ Adjustment must be done for each tray (Tray 1, 2, 3, 4, and MP).</li> <li>○ Do not choose <b>ALL</b> for the tray selection.</li> <li>○ Adjust for the tray with each new tray selection.</li> </ul> </li> <li>3. Print out the test pattern and check if the image is adjusted. If not, repeat Step 2.</li> </ol>

- Diagnostics > Adjustment > Print Adjustment > Print Margin Test

This menu is used to print out the test pattern manually.

### Copy adjustment

- Diagnostics > Adjustment > Copy Adjustment > Image Position



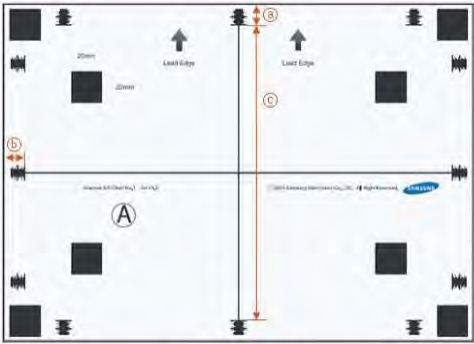
**Table 3-33 Copy Adjustment (Image Position)**

Purpose	Manually adjust the position of the copied image on the paper in the copy engine.
Operation Procedure	<p><b>NOTE:</b> Before copy adjustment:</p> <ul style="list-style-type: none"> <li>– Make sure that the initial values of margin adjustment are the same as the values of the print adjustment.</li> <li>– Perform an adjustment for each tray. Do not choose <b>All</b> for tray selection, as this can confuse the adjustment.</li> </ul> <p><b>NOTE:</b></p> <ul style="list-style-type: none"> <li>– Complete adjustment for each tray (Tray 1, 2, 3, 4, and MP).</li> <li>– Do not choose <b>All</b> for tray selection.</li> <li>– Adjust for the tray with each new tray selection.</li> </ul> <ol style="list-style-type: none"> <li>1. Locate the Scanner A/S Chart at the scanner glass.</li> <li>2. Change the adjustment value using the + or - button, and then press <b>OK</b> to save the changes. <ul style="list-style-type: none"> <li>○ Simplex Leading Edge</li> <li>○ Simplex Side Edge</li> <li>○ Duplex Leading Edge</li> <li>○ Duplex Side Edge</li> </ul> </li> <li>3. Print out the test pattern and check if the image has moved. If not, repeat Step 2.</li> </ol>

**Scan area adjustment**

- Diagnostics > Adjustment > Scan Area Adjustment > Automatic Adjustment

**Table 3-34 Scan Area Adjustment (Automatic Adjustment)**

Purpose	To correct the image position and magnification of scanned images automatically.
Operation Procedure	<ol style="list-style-type: none"> <li>1. Locate the Scanner A/S chart at the scanner glass.</li> </ol>  <p style="text-align: center;"><b>A4 Scanner A/S Chart</b></p>

**Table 3-34 Scan Area Adjustment (Automatic Adjustment)**

Purpose	To correct the image position and magnification of scanned images automatically.
	<p>Note that the <b>Lead Edge</b> arrows point to the left side of the scanner glass and are placed face down. The Scanner A/S Chart comes in two sizes, A4 and Letter.</p> <ol style="list-style-type: none"> <li>2. Press <b>OK</b>. A scan begins and the system will automatically calculate the proper value based on the scanning result of the chart.</li> <li>3. The new value saves to the system.</li> <li>4. Scan the Scanner A/S Chart and send it to a PC. The chart must be scanned from the scanner glass.</li> <li>5. To check the image position, compare the position of the scale marks (a, b) from the chart to the scanned image.</li> <li>6. To check the magnification, compare the length of line <b>c</b> from the chart to the scanned image.</li> </ol> <p><b>NOTE:</b> Specifications:</p> <ul style="list-style-type: none"> <li>○ a, b: 10, ± 1.5 mm</li> <li>○ c: 190, ± 1.5 mm</li> </ul>

- Diagnostics > Adjustment > Scan Area Adjustment > Manual Adjustment

**Table 3-35 Scan Area Adjustment (Manual Adjustment)**

Purpose	To correct the position and magnification of scanned images manually.
Operation Procedure	<ol style="list-style-type: none"> <li>1. Choose one item from the table. There are three items to choose from: <ul style="list-style-type: none"> <li>○ Image Position — Leading Edge (Unit: mm, Scale: 0.1, Min/Max: -6/+6)</li> <li>○ Image Position — Side Edge (Unit: mm, Scale: 0.1, Min/Max: -6/+6)</li> <li>○ Magnification — Vertical Direction (Unit: %, Min/Max: 98.5/101.5)</li> </ul> </li> <li>2. Select one item and press the <b>Edit</b> button.</li> <li>3. Change the adjustment value using the arrow button.</li> <li>4. Image position (a, b): If the current value is smaller than the specification, press <b>+</b>, otherwise press <b>-</b>.</li> <li>5. Magnification (c): If the current value is smaller than the specification, press <b>-</b>, otherwise, press <b>+</b>.</li> <li>6. Press the <b>OK</b> button to apply the new value to the system.</li> <li>7. Scan the Scanner A/S Chart and send it to a PC. The chart must be scanned from the scanner glass.</li> <li>8. To check the image position, compare the position of the scale marks (a, b) from the chart to the scanned image.</li> <li>9. To check the magnification, compare the length of line <b>c</b> from the chart to the scanned image.</li> </ol> <p><b>NOTE:</b> Specifications:</p> <ul style="list-style-type: none"> <li>○ a, b: 10, ± 1.5 mm</li> <li>○ c: 190, ± 1.5 mm</li> </ul>

## ADF adjustment

- Diagnostics > Adjustment > ADF Adjustment > Automatic Adjustment

**Table 3-36 ADF Adjustment (Automatic Adjustment)**

<b>Purpose</b>	<b>To correct the image position and magnification of images scanned with the Flow ADF/ADF automatically.</b>
<b>Operation Procedure</b>	<ol style="list-style-type: none"> <li>1. Locate the Scanner A/S chart on the ADF tray.           <div data-bbox="730 453 1209 793" style="text-align: center;"> <p><b>A4 Scanner A/S Chart</b></p> </div> </li> <li>2. Press <b>OK</b>. A scan begins and the system will automatically calculate the proper value based on the scanning result of the chart.</li> <li>3. The new value saves to the system.</li> <li>4. Scan the Scanner A/S Chart and send it to a PC. The chart must be scanned from the Flow ADF/ADF.</li> <li>5. To check the image position, compare the position of the scale marks (a, b) from the chart to the scanned image.</li> <li>6. To check the magnification, compare the length of line <b>c</b> from the chart to the scanned image.           <p><b>NOTE:</b> Specifications:</p> <ul style="list-style-type: none"> <li>○ a, b: 10, ± 1.5 mm</li> <li>○ c: 190, ± 1.5 mm</li> </ul> <p><b>NOTE:</b> After executing the ADF adjustment, perform a shading test. Refer to Scanner Diagnostics.</p> </li> </ol>

- Diagnostics > Adjustment > ADF Adjustment > Manual Adjustment

**Table 3-37 ADF Adjustment (Manual Adjustment)**

<b>Purpose</b>	<b>To correct the position and magnification of scanned images manually.</b>
<b>Operation procedure</b>	<ol style="list-style-type: none"> <li>1. Choose one item from the table. There are three items to choose from:</li> </ol>

**Table 3-37 ADF Adjustment (Manual Adjustment)**

Purpose	To correct the position and magnification of scanned images manually.
	<ul style="list-style-type: none"> <li>○ Image Position — Leading Edge (Unit: mm, Scale: 0.1, Min/Max: -6/+6)</li> <li>○ Image Position — Side Edge (Unit: mm, Scale: 0.1, Min/Max: -6/+6)</li> <li>○ Magnification — Vertical Direction (Unit: %, Min/Max: 98.5/101.5)</li> </ul> <ol style="list-style-type: none"> <li>2. Select one item and press the <b>Edit</b> button.</li> <li>3. Change the adjustment value using the arrow button.</li> <li>4. Image position (a, b): If the current value is smaller than the specification, press <b>+</b>, otherwise press <b>-</b>.</li> <li>5. Magnification (c): If the current value is smaller than the specification, press <b>-</b>, otherwise, press <b>+</b>.</li> <li>6. Press the <b>OK</b> button to apply the new value to the system.</li> <li>7. Scan the Scanner A/S Chart and send it to a PC. The chart must be scanned from the Flow ADF/ADF.</li> <li>8. To check the image position, compare the position of the scale marks (a, b) from the chart to the scanned image.</li> <li>9. To check the magnification, compare the length of line <b>c</b> from the chart to the scanned image.</li> </ol> <p><b>NOTE:</b> Specifications:</p> <ul style="list-style-type: none"> <li>○ a, b: 10, ± 1.5 mm</li> <li>○ c: 190, ± 1.5 mm</li> </ul> <p><b>NOTE:</b> After executing the ADF adjustment, perform a shading test. Refer to Scanner Diagnostics.</p>

## Image management

Learn about image management.

### Auto tone adjustment activation

- Diagnostics > Image Management > Auto Tone Adjustment Activation > Normal

**Table 3-38 Auto Tone Adjustment Activation (Normal)**

Purpose	To correct image quality when density of the image is poor. Normal TRC Control is recommended after changing a unit, such as a toner cartridge, imaging unit, and PTB, or after restarting the printer.
Operation Procedure	<ol style="list-style-type: none"> <li>1. Select <b>On</b> or <b>Off</b> for Normal TRC Control execution. <ul style="list-style-type: none"> <li>○ Off: Normal TRC Control will not execute.</li> <li>○ On: Normal TRC Control will execute during the determined conditions,</li> </ul> </li> <li>2. Change the execution condition(s) of Normal TRC Control. <ul style="list-style-type: none"> <li>○ Page Count: The system executes Normal TRC Control based on the count of printed pages since the last execution.</li> <li>○ Time Left Alone: The system executes Normal TRC Control when the system returns from a power save</li> </ul> </li> </ol>

**Table 3-38** Auto Tone Adjustment Activation (Normal) (continued)

Purpose	To correct image quality when density of the image is poor. Normal TRC Control is recommended after changing a unit, such as a toner cartridge, imaging unit, and PTB, or after restarting the printer.
	mode and the rest time exceeds the configured value.
Verification	Print out a test job and make sure the image quality has recovered.

- [Diagnostics > Image Management > Auto Tone Adjustment Activation > Full](#)

**Table 3-39** Auto Tone Adjustment Activation (Full)

Purpose	To correct image quality when any OPC drum is replaced, the life of the OPC drum is changed, the density of the image is poor, or the temperature and/or humidity in the room changes suddenly.
Operation Procedure	<ol style="list-style-type: none"> <li>1. Select <b>On</b> or <b>Off</b> for Full TRC Control execution. <ul style="list-style-type: none"> <li>○ Off: Full TRC Control will not execute.</li> <li>○ On: Full TRC Control will execute during the determined conditions,</li> </ul> </li> <li>2. Change the execution condition(s) of Full TRC Control. <ul style="list-style-type: none"> <li>○ Page Count: The system executes Full TRC Control based on the count of printed pages since the last execution.</li> <li>○ Time Left Alone: The system executes Full TRC Control when the system returns from a power save mode and the rest time exceeds the configured value.</li> </ul> </li> </ol>
Verification	Print out a test job and make sure the image quality has recovered.

## Print test patterns

Learn about the print test patterns.

### [Diagnostics > Print Test Patterns >Skew Pattern](#)

- The skew pattern stored in the machine will be printed out as the selected size.

## Service functions

Learn about service functions.

### Main memory clear

Learn about the main memory clear.

#### Service Functions > Main Memory Clear

- This function resets the main memory of the system to the factory default setting. This function can be used to reset the system to the initial value when the product is functioning abnormally. User configured values return to the default values.

To clear the main memory, select the country/region where the system is located, and restart the printer.

### Debug log

Learn about the debug log.

#### Service Functions > Debug Log

- This function sets the system log message level. Users can select three options:
  - Off: This option disables the logging option.
  - Job Status: This option only enables the logging of user created jobs.
  - Details: This option enables all the logging options of the running tasks of the system. This option might affect the performance of certain system operations. Use this option when the system performs abnormally and engineers need to investigate the problem.

### Capture log

Learn about the capture log.

#### Service Functions > Capture Log

- This function copies all the saved logs in the system to a USB flash drive as a .zip file. The size of the system log could reach up to 1 GB. If the system log size becomes very large, it will take a longer time to copy to the USB flash drive.
  1. Connect the USB flash drive to the printer.
  2. Tap the **Service Mode** app.
  3. Go to **Service Functions > Debug Log** and change the debug log level to **INFO**.
  4. Go to **Service Functions > Capture Log**.
  5. Select **All** or **Period**. If selecting **Period**, enter the start and end date.
  6. Press the **Capture Log** button.
  7. Once the log is completed, a completion message will display. Restore the debug log level to **JOB STATUS**.

 **NOTE:** If the system log size becomes very large, it will take longer to copy to the USB flash drive.


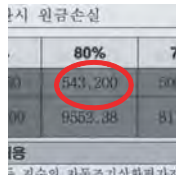


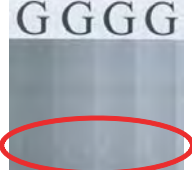
8. Check that the Log File has been saved to the USB flash drive.

## Transfer assembly control mode

Learn about the transfer assembly control mode.

### Service Functions > Transfer Assembly Control Mode

- **Table 3-40** Transfer Assembly Control Mode

Purpose	To correct transfer related problems. This function can be used to change the transfer value to optimize image quality to a certain type of paper.
Operation Procedure	<p>– T2 Control Mode</p> <ul style="list-style-type: none"> <li>○ Choose the paper group, paper side, and paper direction.</li> <li>○ Adjust PWM value based on the problem type.               <ul style="list-style-type: none"> <li>● Blur: Increase PWM value</li> <li>● Poor Transfer: Increase PWM value</li> <li>● Re-transfer: Decrease PWM value</li> <li>● White Spot: Decrease PWM value</li> <li>● OPC Cyclic Ghost: Decrease PWM value</li> </ul> </li> </ul> <div style="display: flex; justify-content: space-around; align-items: center;"> <div style="text-align: center;">  <p><b>Blur</b></p> </div> <div style="text-align: center;">  <p><b>Poor Transfer</b></p> </div> <div style="text-align: center;">  <p><b>Retransfer</b></p> </div> </div> <div style="display: flex; justify-content: space-around; align-items: center; margin-top: 10px;"> <div style="text-align: center;">  <p><b>White Spot</b></p> </div> <div style="text-align: center;">  <p><b>OPC Cyclic Ghost</b></p> </div> </div>
Verification	Print a test job and make sure the transfer problem has been resolved.
Specification	N/A
Reference	N/A

## Envelope rotate

Learn about the envelope rotate function.


## Service Functions > Envelope Rotate

- This menu enables rotation when printing on an envelope. The machine usually guides loaded envelopes with SEF direction. If this function is enabled, the user can load an envelope with LEF direction and the machine will rotate the image for printing on the envelope.

This function provides the following setting options:

- Off (default): Load envelope SEF direction
- 90 degrees: Load envelope LEF direction.
- 180 degrees: Load envelope SEF direction with flap on bottom side.



 **NOTE:** If the paper source is **Auto**, the device will feed from the Tray 1 because the LEF envelope can only be loaded in the Tray 1 according to paper specification.

If the length of envelope is over the maximum size of the custom width, the device will not rotate the image and determine that the direction of the envelope is SEF. For example, the A4 model supports custom sizes like W 98–216 ~ L148–356. This model does not support C5 Env (162x229) DL Env (110x220), No 9 Env (98x225), No 10 Env (105x241) rotation.



# Print quality troubleshooting guide

Learn about print quality troubleshooting.

# Image quality problems and solutions

Learn about print-quality troubleshooting.

Print quality defects can be caused by printer components, consumables, media, internal software, external software applications, and environmental conditions.

To successfully troubleshoot print quality problems, eliminate as many variables as possible.

First, generate prints using printable pages using laser paper. Use paper from an unopened ream that has been acclimated to room temperature. Make sure that genuine HP toner is installed in the printer.

Figure 3-39 A/S chart (A3)

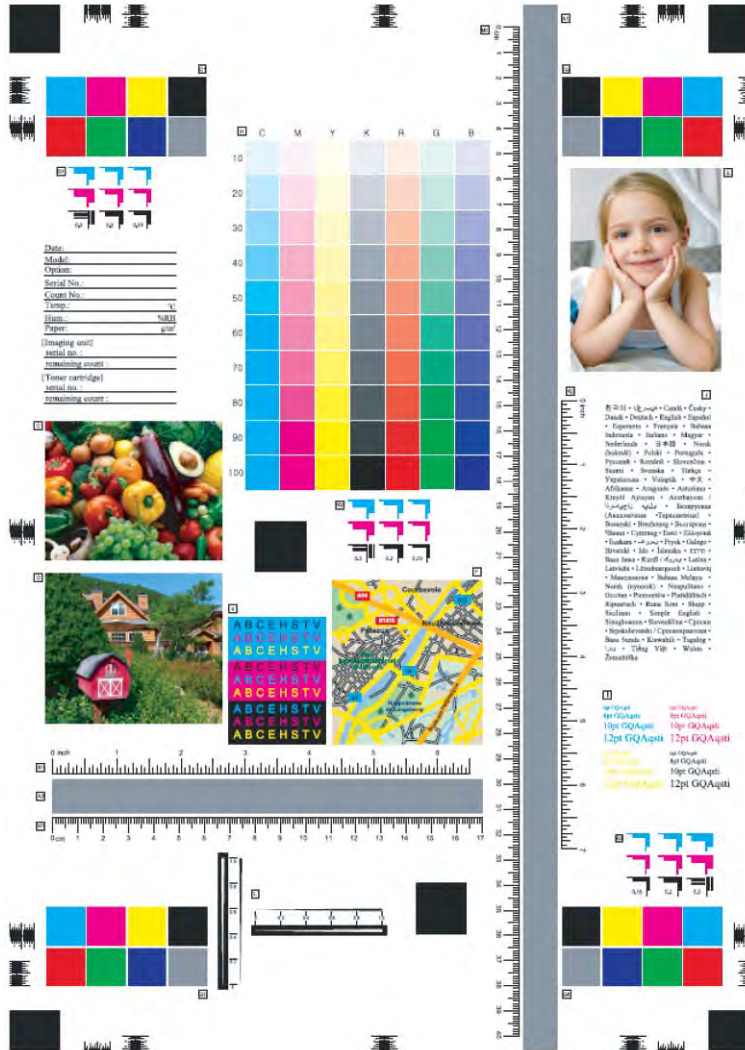


Figure 3-40 A/S chart

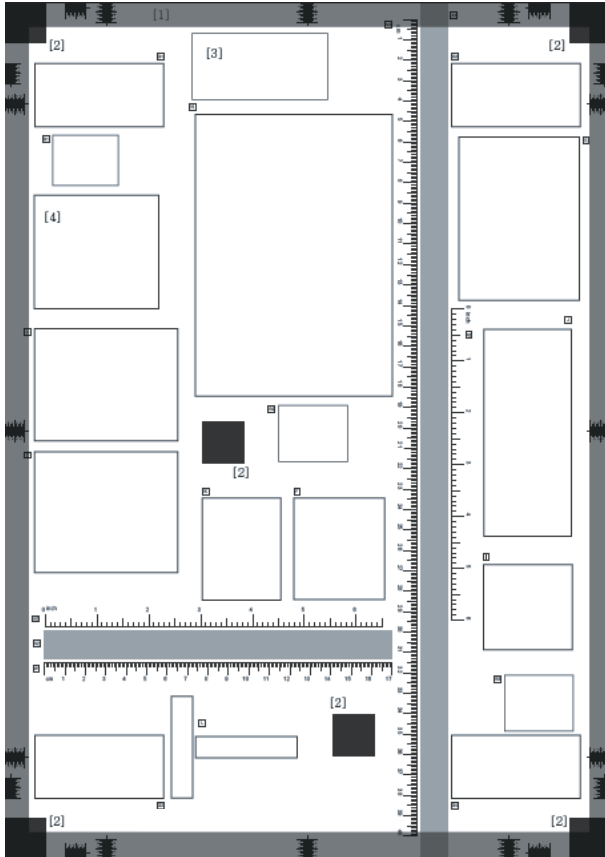


Table 3-41 A/S chart

Item	Description	Use
[1]	Grid pattern	For adjusting margin and magnification
[2]	Black patches	For adjusting skew error
[3]	Barcode	For checking the reproduction of the barcode
[4]	Note area	For recording the date, conditions, and so on.
[A]	Halftone band	For checking banding and jitter (K 50%)
[B, L]	Resolution patterns	For checking resolution
[C, D, E]	Images	For checking color reproduction
[F]	Map image	For checking fine line reproduction
[G]	Color patches	For checking color reproduction and uniformity
[H]	Gradation pattern	For checking tone reproduction of seven colors (C, M, Y, K, R, G, B/10~100%)
[I]	Color/Mono text	For checking the reproduction of color, mono text
[J]	Multilingual feature	For checking the reproduction of small text

Table 3-41 A/S chart (continued)

Item	Description	Use
[K]	White gap pattern	For checking color to color, color to mono white gap
[M]	Rulers	For checking the magnification error (unit: cm)
[N]	Rulers	For checking the magnification error (unit: inch)

### How to analyze image defects

See the following flowchart.

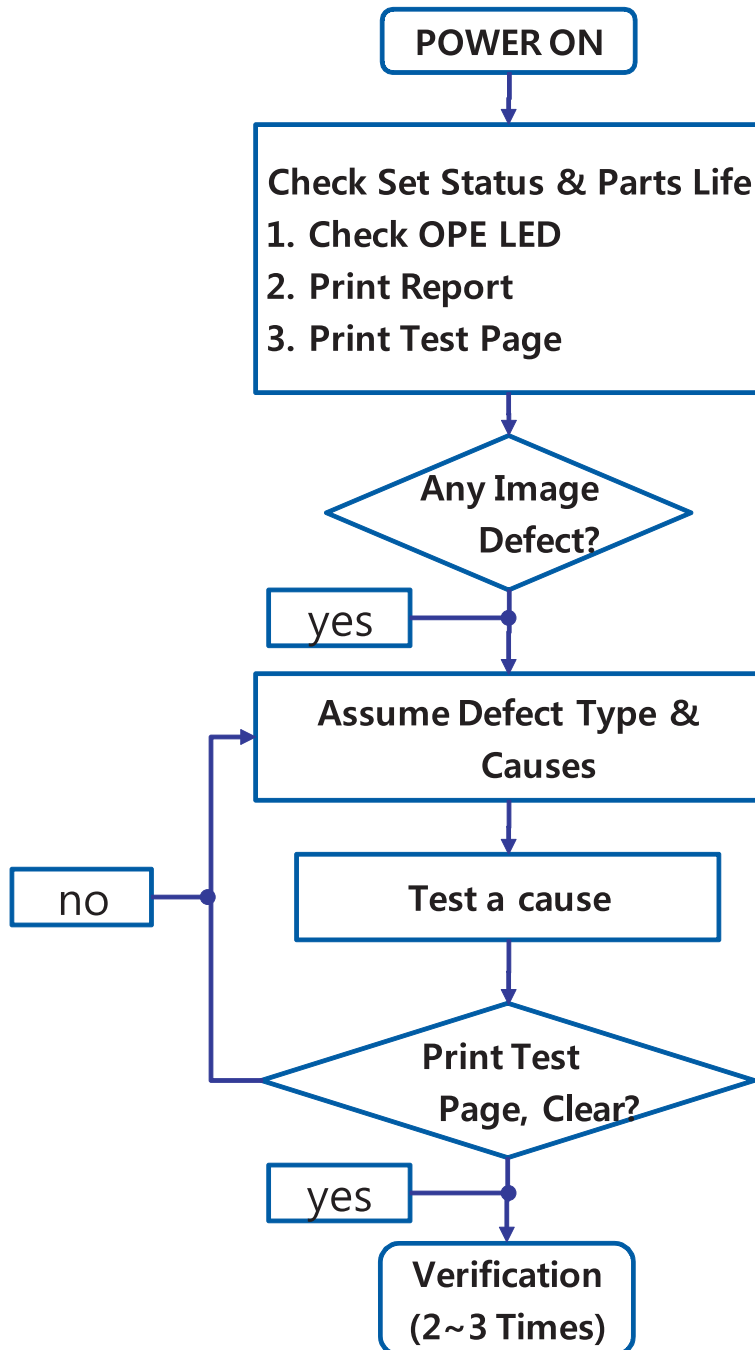
---

 **TIP:** Depending on the remaining life of the part, the cause of the defect can vary. Check the remaining life of the part.

Check for defects even if the defect is not repeated.

---

Figure 3-41 Defect analysis flowchart





### Vertical black lines

Learn about vertical black lines.



Figure 3-42 Typical faulty images



Table 3-42 Troubleshooting procedure

Step	Check item	Action
1	Charge roller (CR) is contaminated. 	Check if the CR is contaminated.  Replace the Drum unit if there are additional problems.

**Table 3-42** Troubleshooting procedure (continued)

Step	Check item	Action
2	<p>ITB is contaminated.</p> <ul style="list-style-type: none"> <li>The ITB cleaning is poor.</li> <li>The ITB clean-blade is partially broken.</li> </ul>	<p>Check if the ITB is contaminated.</p>  <p>Replace the ITB Cleaner if there are additional problems.</p>
3	<p>Scanner unit is contaminated.</p> <ul style="list-style-type: none"> <li>Scan glass contamination</li> <li>Mirror contamination</li> <li>CCD sensor contamination</li> </ul> 	<p>Wipe the surface of the contaminated parts with a soft cloth.</p> <p><b>CAUTION:</b> The scanner unit contains fragile parts. Use caution while cleaning.</p>

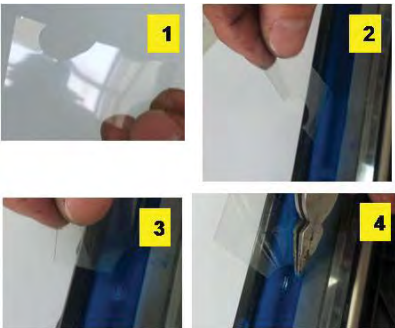

## Vertical light or white lines

Learn about vertical light or white lines.

**Figure 3-43** Typical faulty images



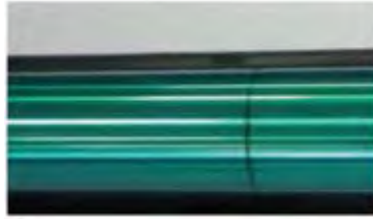
**Table 3-43** Troubleshooting procedure

Step	Check item	Action
1	<p>A foreign substance is between the magnetic roller and the blade.</p> <p>No toner on magnetic roller.</p>	<p>Remove the foreign substance.</p>  <p>Make the hook (transparency sheet is recommended).</p> <p>Put the hook into the gap between magnetic roller and blade.</p> <p>Pull out foreign substances.</p>
2	<p>The developer in the developer unit is empty or the developer unit life has expired.</p>	<ul style="list-style-type: none"> <li>• Check the life remaining of the developer unit on the supply information report. <ul style="list-style-type: none"> <li>– If its life has expired, replace the developer unit.</li> </ul> </li> <li>• Check if the developer layer on magnetic roller is uniform. <ul style="list-style-type: none"> <li>– If the developer layer is short, replace the developer unit.</li> </ul> </li> </ul>
3	<p>The laser beam path is blocked.</p> <p>(Foreign substance is on the laser scanner assembly window.)</p>	<p>Clean the laser scanner assembly window.</p>  <p><b>Normal</b></p>



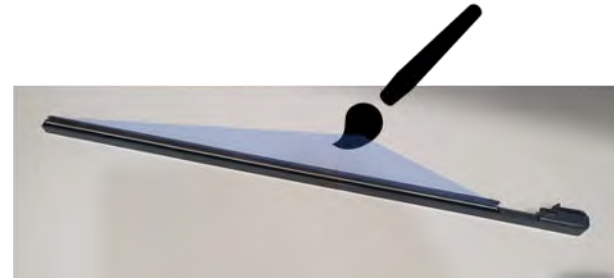
**Table 3-43** Troubleshooting procedure (continued)

Step	Check item	Action
4	The OPC is scratched or contaminated in a vertical direction.	Replace the drum unit.



5	ITB cleaner or T2 transfer unit is contaminated with paper dust build up.	Clean the paper dust stick on a regular basis.
---	---------------------------------------------------------------------------	------------------------------------------------

- ITB cleaner contamination




**NOTE:** The paper dust stick (Callout 1 ) may vary depending on the product.

**NOTE:** Clean the paper dust stick on a regular basis in order to prevent horizontal light band. Frequent cleaning can help maintain product quality.

HP recommends to clean this item when replacing TCU at a minimum.

**Table 3-43** Troubleshooting procedure (continued)

Step	Check item	Action
	<ul style="list-style-type: none"> <li>T2 contamination (Callout 1) &amp; Image defect</li> </ul>	
		


### Horizontal periodic black lines, dots

Learn about horizontal periodic black lines and dots.

**Figure 3-44** Typical faulty images



**Table 3-44** Troubleshooting procedure

Step	Check item	Action
1	Horizontal periodic band or dot (CR 37.7 mm). <ul style="list-style-type: none"> <li>The surface of the Charge Roller (CR) is contaminated.</li> <li>CR is scratched.</li> </ul>	Clean the contaminated surface on the charge roller with a soft cloth and alcohol.  If the surface is scratched, replace the drum unit.
		

**Table 3-44** Troubleshooting procedure (continued)

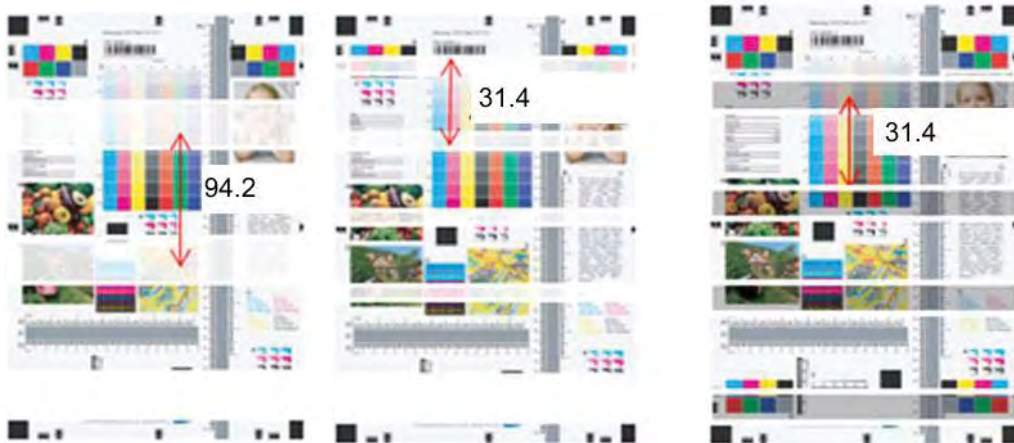
Step	Check item	Action
2	Horizontal periodic band (CR, 37.7 mm). CR in poor condition.	Replace the drum unit.
3	OPC is damaged.	Replace the drum unit.



### Horizontal periodic light/dark band, dots

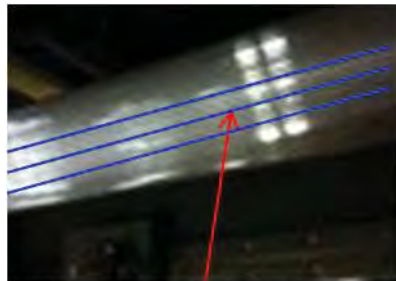
Learn about horizontal periodic light/dark band and dots.

**Figure 3-45** Typical faulty images



**Table 3-45** Troubleshooting procedure

Step	Check item	Action
1	Horizontal periodic bands (OPC, 94.2 mm) <ul style="list-style-type: none"> <li>• OPC was exposed for too long.</li> <li>• Damage was caused by a high voltage in a short amount of time.</li> </ul>	This problem is likely to resolve itself over time. If the problem persists, replace the drum unit.
2	Horizontal periodic bands (magnetic roller, 31.4 mm)  The magnetic roller is in poor condition.  V-groove of the surface of magnetic roller is not uniform.	Replace developer unit.



**V-groove in Roller-Magnetic**

## Foggy image

Learn about foggy images.

**Figure 3-46** Typical faulty images



**Table 3-46** Troubleshooting procedure

Step	Cause	Action
1	Voltage of OPC motor is abnormally low.	Replace the drum unit.
2	HVPS operates abnormally.  HVPS is damaged or broken.	Replace the HVPS board.

**Table 3-46** Troubleshooting procedure (continued)

Step	Cause	Action
3	Toner is over supplied by abnormal TC sensor.	Replace the toner cartridge.
4	Voltage of OPC motor is abnormally low.	Check the transfer assembly connection in the HVPS.
	Transfer assembly voltage is abnormally high.	Check if the transfer assembly roller spring in the ITB is connected correctly.  Replace HVPS.

## Light image

Learn about light image.

**Figure 3-47** Typical faulty images



**Table 3-47** Troubleshooting procedure

Step	Cause	Action
1	Toner cartridge is not installed correctly.	Check if the toner is installed completely  Make sure that the latching mechanism is correctly engaged.
2	Toner not distributed in the toner cartridge.	Hold the toner cartridge horizontally and shake it side to side several times to evenly distribute the toner.
3	Output voltage of HVPS is abnormally low. <ul style="list-style-type: none"> <li>Color density decreases.</li> </ul>	Check if the toner level is sufficient. If not, replace the toner cartridge.  Check if the toner supply shutter is opened.
4	Output voltage of HVPS is abnormally low. <ul style="list-style-type: none"> <li>Color density decreases.</li> </ul>	Replace HVPS.
5	TC down and toner spills.	Replace the developer unit.
6	Toner spills by eraser.	Check if the eraser is contaminated.  Replace the drum unit or developer unit.



## Blurred image

Learn about blurred images.

Figure 3-48 Typical faulty images



Table 3-48 Troubleshooting procedure

Step	Cause	Action
1	High humidity and/or the quality of the paper.	Use new, high quality paper.
2	T2 transfer voltage is low.	Turn up the T2 transfer voltage.
3	Connection between HVPS and THV is incorrect.	Check if the connection between T2 high voltage terminal and HVPS THV terminal is correct.  Check if the connection between the HVPS and ITB is correct.
		 
4	HVPS operates abnormally.	Replace the HVPS.

## Incorrect color registration

Learn about the incorrect color registration defect.

Figure 3-49 Typical faulty images



Text of lines appear jagged, unclear, or blurred. This defect is usually caused by a faulty laser/scanner diode.


 **NOTE:** Feed direction (callout 1).

Table 3-49 Troubleshooting procedure

Step	Cause	Action
1	CPR sensor is contaminated.	Execute CPR manually.
2	Environment has changed.	To recognize the environment change, execute CPR after a certain amount of time.
3	Belt surface is contaminated.	Remove the ITB. If the surface of the belt is contaminated, clean it with soft cloth.

## Uneven pitch and jitter image

Learn about uneven pitch and jitter image.

Figure 3-50 Typical faulty images



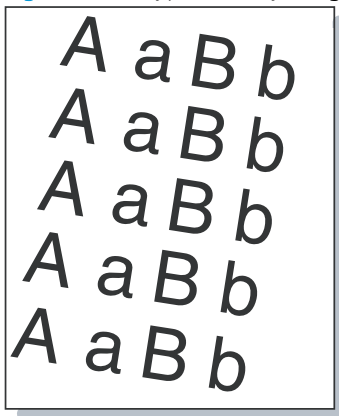
**Table 3-50 Troubleshooting procedure**

Step	Cause	Action
1	Under 3 mm periodic jitters or horizontal bands have occurred.	Remove foreign substance from the drive gears. Grease the drive gears. <ul style="list-style-type: none"> <li>• Developer unit gears</li> <li>• Drum unit gears</li> <li>• Main drive unit gears.</li> </ul> If the problem persists, replace the abnormal units. <ul style="list-style-type: none"> <li>• Developer unit</li> <li>• Drum unit</li> <li>• Main drive unit</li> </ul>
2	Under 1 mm periodic jitter or horizontal bands have occurred.	Check if the laser scanner assembly is assembled correctly. If not, replace the screws. Replace the laser scanner assembly.

## Skewed image

Learn about skewed images.

**Figure 3-51** Typical faulty images

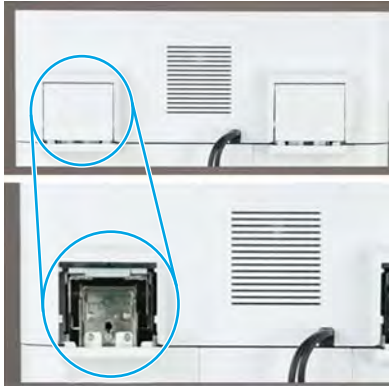


**Table 3-51 Troubleshooting procedure**

Step	Check item	Action
1	Is the tray properly installed?	Reinstall the tray correctly.
2	Is too much paper loaded in the tray?	Remove some paper.
3	Are the paper guides properly set?	Adjust the paper guides.
4	Is the surface of the pickup/reverse/feed roller dirty?	Clean or replace the contaminated roller.



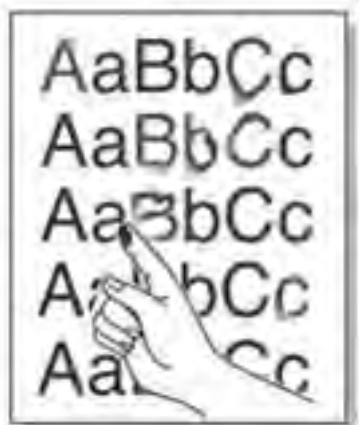
**Table 3-51** Troubleshooting procedure (continued)

Step	Check item	Action
5	Is the Flow ADF installed and adjusted properly?	Reinstall the Flow ADF unit.  Adjust the Flow ADF skew.
		
6	Is the intermediate transfer belt installed properly?	Reinstall the ITB unit.

## Poor fusing performance

Learn about poor fusing performance.

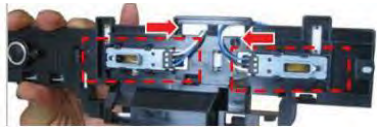
**Figure 3-52** Typical faulty images



**Table 3-52** Troubleshooting procedure

Step	Cause	Action
1	Check the paper type.  Depending on what type of paper is used, print speed varies. <ul style="list-style-type: none"> <li>• Plain (71~90g/), Thick (91~105g/): Full Speed</li> <li>• Heavy weight (106~175g/): Half Speed</li> <li>• Envelope (75~90 g/), Label (120~150 g/): Half Speed</li> </ul>	Check that the paper type displayed on the control panel is the same type of paper being used for the print job.

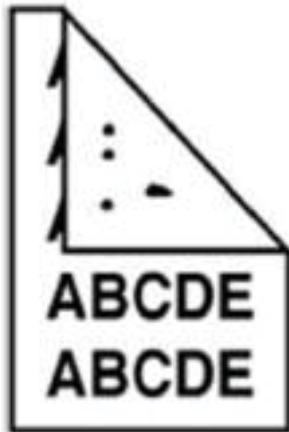
**Table 3-52** Troubleshooting procedure (continued)

Step	Cause	Action
2	The fuser unit is worn out.	Replace the fuser unit.
3	Check the surface of the fuser belt and pressure roller for scratches.	Replace the fuser unit.
4	Check the temperature control system for problems. <ul style="list-style-type: none"> <li>• Thermistor is broken or operates abnormally</li> <li>• Halogen lamp is broken or operates abnormally</li> </ul>	Check the non-contact thermistor sensor  Check the halogen lamp. If parts are broken, replace the broken parts or the fuser unit.
5	Check if the pressure control system operates properly.	Check the pressure control system. If the problem persists, replace the fuser unit.
6	Paper is wrapped on the heating roller.	Remove the wrapped paper and print a test page. If the problem persists, replace the fuser unit.

### Stain on the paper back side

Learn about the stain on the paper back side.

**Figure 3-53** Typical faulty images



**Table 3-53** Troubleshooting procedure

Step	Cause	Action
1	Is the transfer roller dirty or worn out?	Clean or replace the transfer roller assembly.
2.1	Is there any stain caused by poor cleaning on the ITB?	Clean the ITB. If the problem persists, replace the ITB unit.

**Table 3-53** Troubleshooting procedure (continued)

Step	Cause	Action
2.2	Is the ITB cleaning blade in proper contact with the ITB?	Take off the ITB and check that the ITB cleaning blade pressure spring and the pressure hook are installed correctly.
3.1	Are the fuser belt and pressure roller dirty?	Clean the fuser belt and pressure roller.
3.2	Check the pressure roller surface for damage or scratches.	Replace the fuser unit.

## Duplex blur, white spot blur on color print-out

Learn about the duplex blur, white spot blur on color print-out defect.

**Figure 3-54** Typical faulty images



Duplex Blur



Duplex W/Spot

### Troubleshooting procedure

1. Enter **SVC Mode** → **Service Functions** → **TR Control Mode**.
2. Select **T2 Control Mode**.
3. Select the paper setting based on the site. (Paper Group, Paper Side, Paper Direction).
4. Increase value for T2 PWM and check if the blur problem is resolved.
5. When the problem persists after changing the **T2 Control Mode** values, change the **T1 Control Mode** values.
6. Decrease the value for each color and see whether the symptom disappears.  
In this case, [-4] was applied and solved the blur.
7. As there can be variation for each device, change T1, T2 and observe the results.

## Adjusting the Adjusting the laser scanner assembly skew error

Learn about adjusting the laser scanner assembly skew error.

1. Check the skew error.
  1. Execute the CPR.

Machine Setup ► General Settings ► Image Management ► Auto Color Registration

2. Print the CPR report.

SVC (Tech) Mode ► Information ► Print Reports ► Auto Color Registration

3. Check [Y] [M] [C] Skew Data in CPR report.

2. Adjust the skew error.

1. Open the front cover. Remove the toner collection unit.
2. There are three skew holes for YMC color. Insert the Phillips screw driver and adjust CW, CCW referred to adjustment amount.

Figure 3-55 YMC skew holes

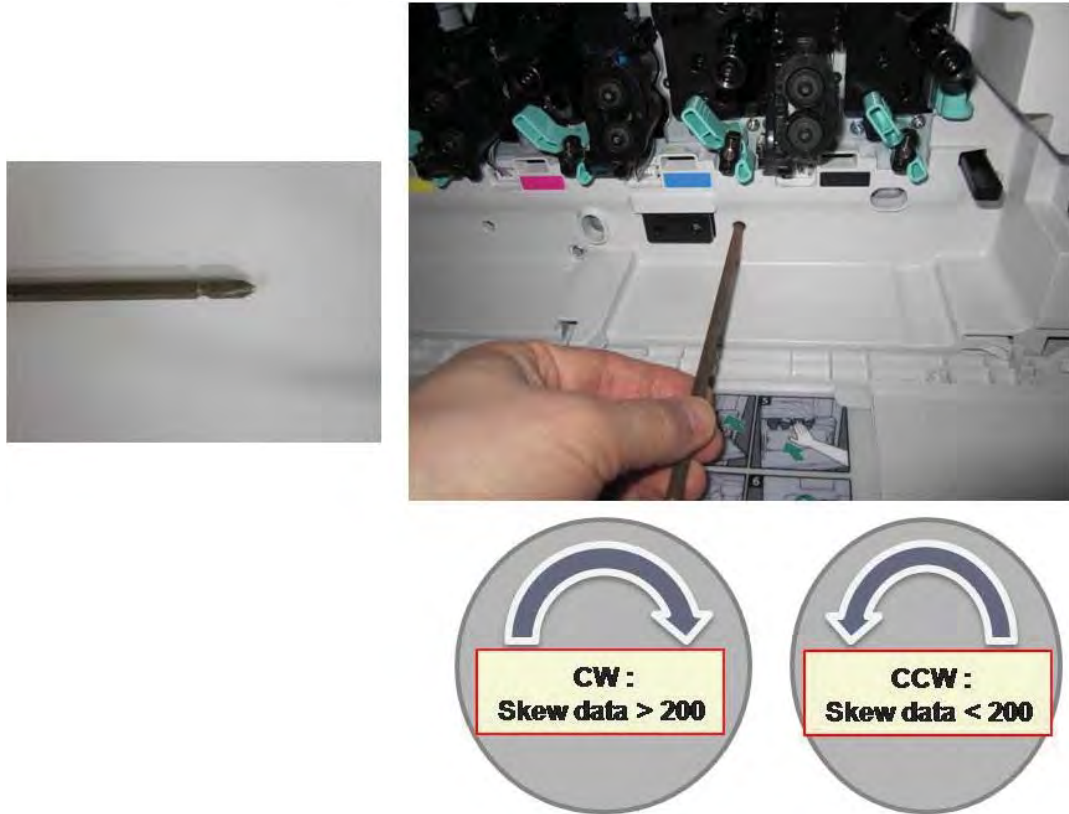


3. The standard skew value is 200. If the skew data in the CPR report is 200, skew adjustment is unnecessary.
4. Adjustment method:


 **NOTE:** One click is equal to 1/7 dot.

- Skew Data < 200: Rotate the driver in a counterclockwise direction. Example: Skew Data is 192: 200 — 192 = 8. Click CCW rotation.
- Skew Data = 200: No adjustment needed.
- Skew Data > 200: Rotate the driver in a clockwise direction. Example: Skew Data is 213: 213 – 200 = 13. Click CW rotation.

Figure 3-56 Skew adjustment



3. Check the skew error again.
  1. Execute the CPR after the skew adjustment.
  2. Print the CPR report.
  3. Check the [Y] [M] [C] skew error.
  4. If the value for YMC is  $200 \pm 7$ , complete the skew adjustment

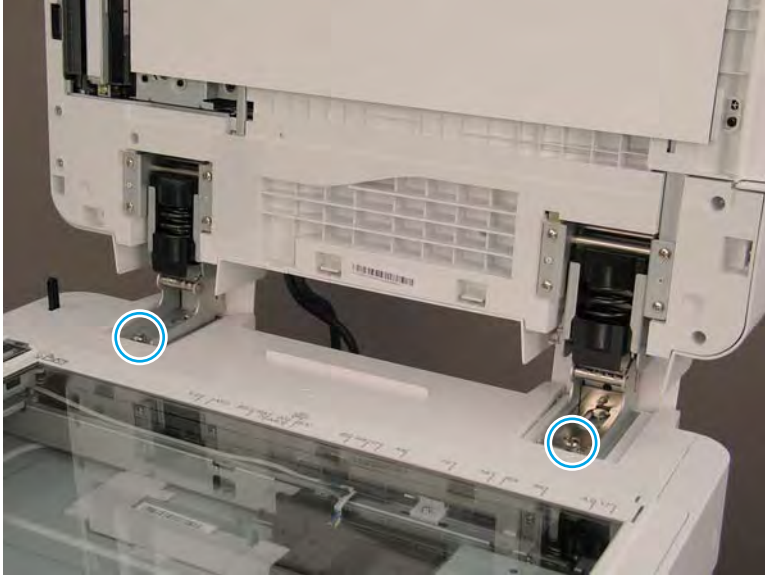
 **NOTE:** If the value does not meet the target, repeat steps 1–3.

## Adjusting the flow ADF/ADF skew

Learn about adjusting the ADF/ADF skew.

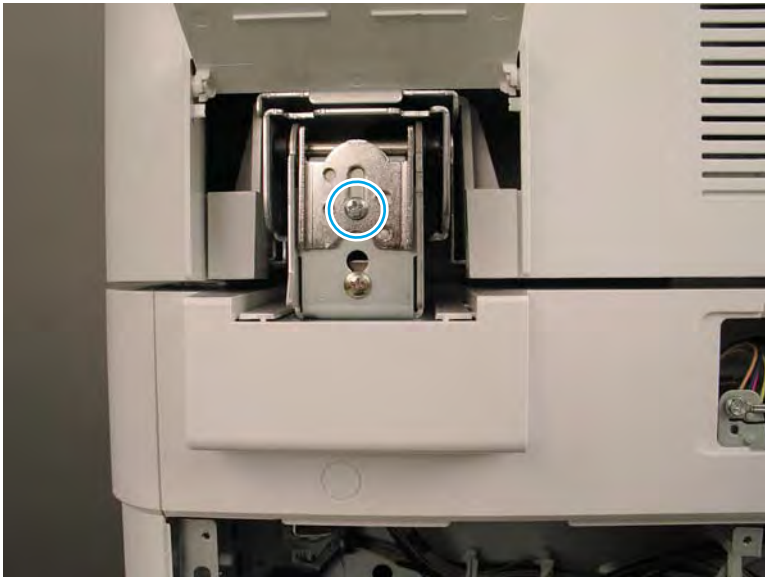
1. Open the ADF. Loosen the two screws securing both hinges.

Figure 3-57 Open ADF and loosen screws



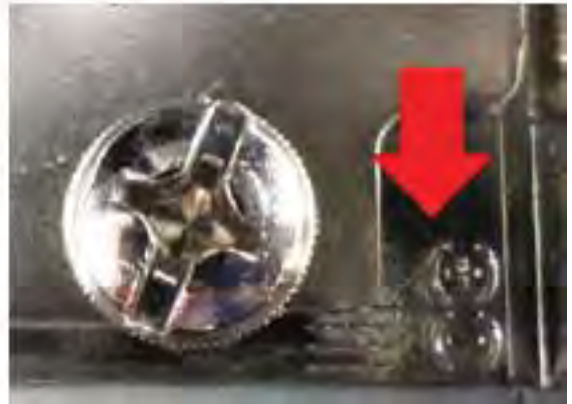
2. Adjust the position of the ADF hinge according to the skew status.

Figure 3-58 Adjust ADF hinge



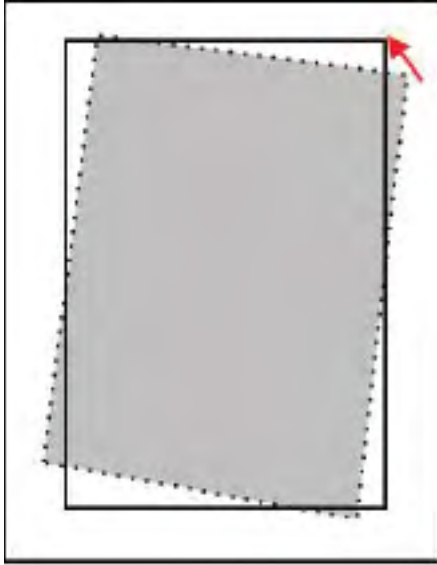
- a. If the skew image is similar to the following example, adjust the hinge unit in the direction of the arrow. (1 scale = >1.0 mm skew adjustment)

Figure 3-59 Adjust hinge



- b. If the skew image is like the following example, adjust the hinge unit in the direction of the arrow. (1 scale = >1.0 mm skew adjustment)

Figure 3-60 Adjust hinge



3. Detach the ADF sponge after adjusting the skew. Place the ADF sponge on the scanner glass. Close the ADF unit to attach the sponge.

## Adjust Scan skew error

Learn about adjusting the scan skew.

1. Disassemble holder-right which hold glass assy and then separate screw cap and screw from Platen



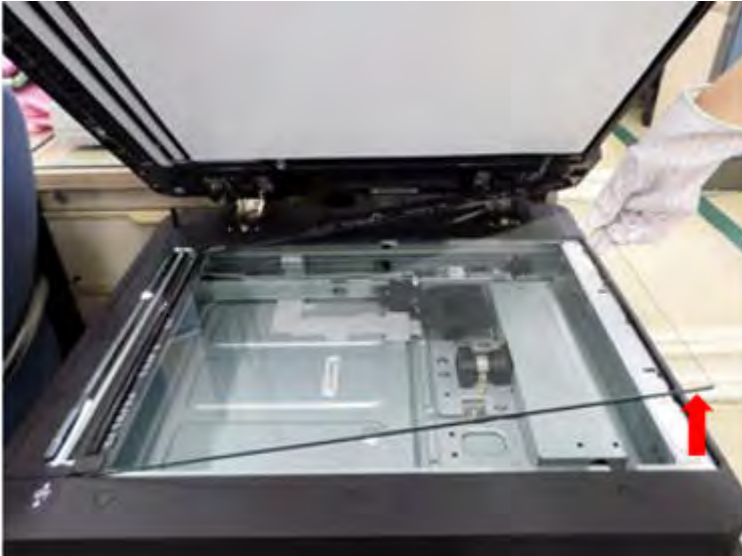
Figure 3-61 Disassemble holder-right



2. Disassemble glass from Platen as lifting right side of glass and then pull to right way.

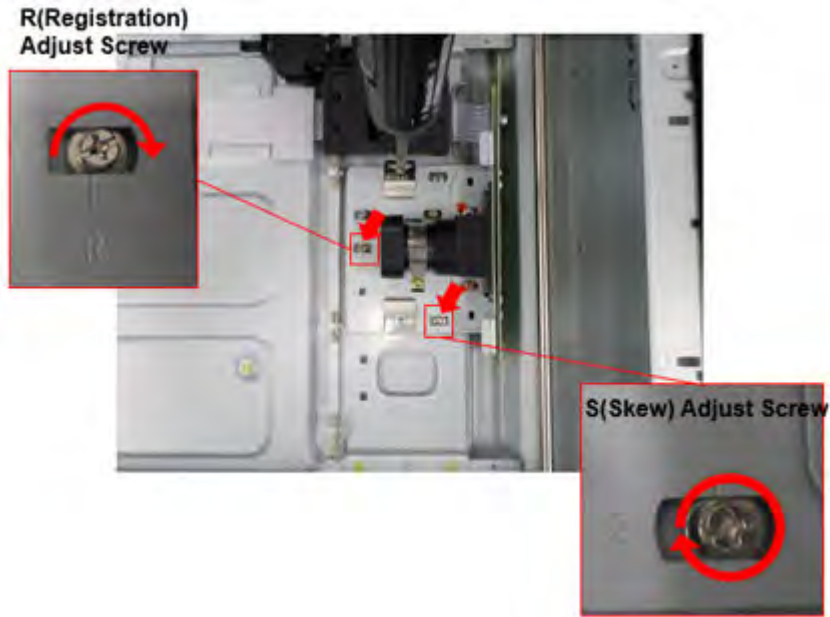
**CAUTION:** Should wear clean gloves when deal glass to prevent contamination

Figure 3-62 Disassemble glass



3. Mark on R,S screw with pen to recognize how much rotate screw.
  - a. Adjust R,S screw according to below guide.
  - b. Example : Top skew error occur as clockwise 1.5mm on A3 size document.
    - Firstly rotate S screw clockwise as a rotation.
    - Then rotate R screw clockwise as half rotation. (Should adjust R screw after S screw adjustment at half ratio of S screw adjustment)

Figure 3-63 Recognize how much rotate screw.



---

💡 **TIP:** Assemble

Progress 1,2,3 step in reverse order; assemble glass & holder-right.

---

---

## 4 Electrical-mechanical diagrams

Learn about the electrical-mechanical diagrams.

### PCAs, Boards, and Laser Scanning Unit (LSU)

Learn about the electrical-mechanical relationships diagram for the PCAs, Boards, and Laser Scanning Unit (LSU).

Figure 4-1 Formatter

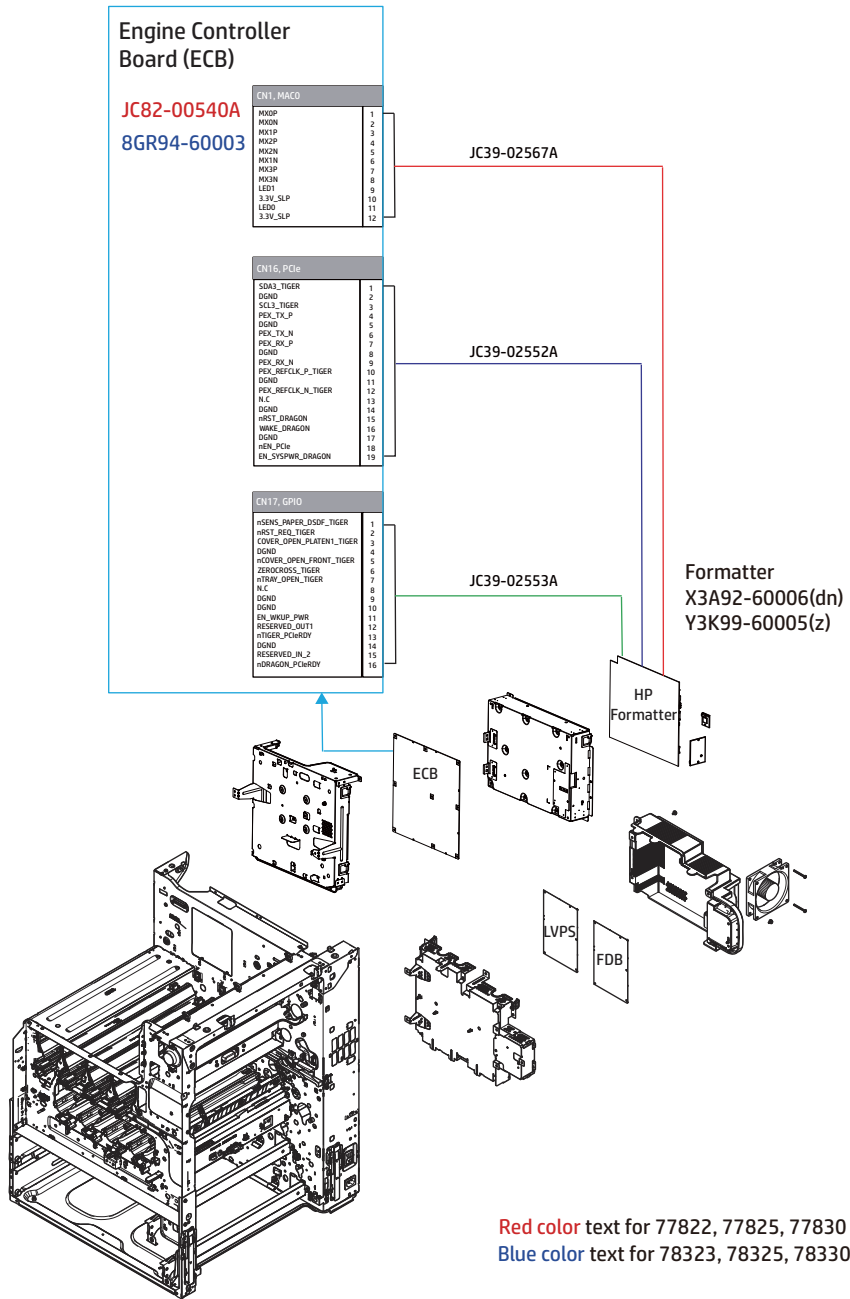


Figure 4-2 Low Voltage Power Supply (LVPS) and Fuser Drive Board (FDB)

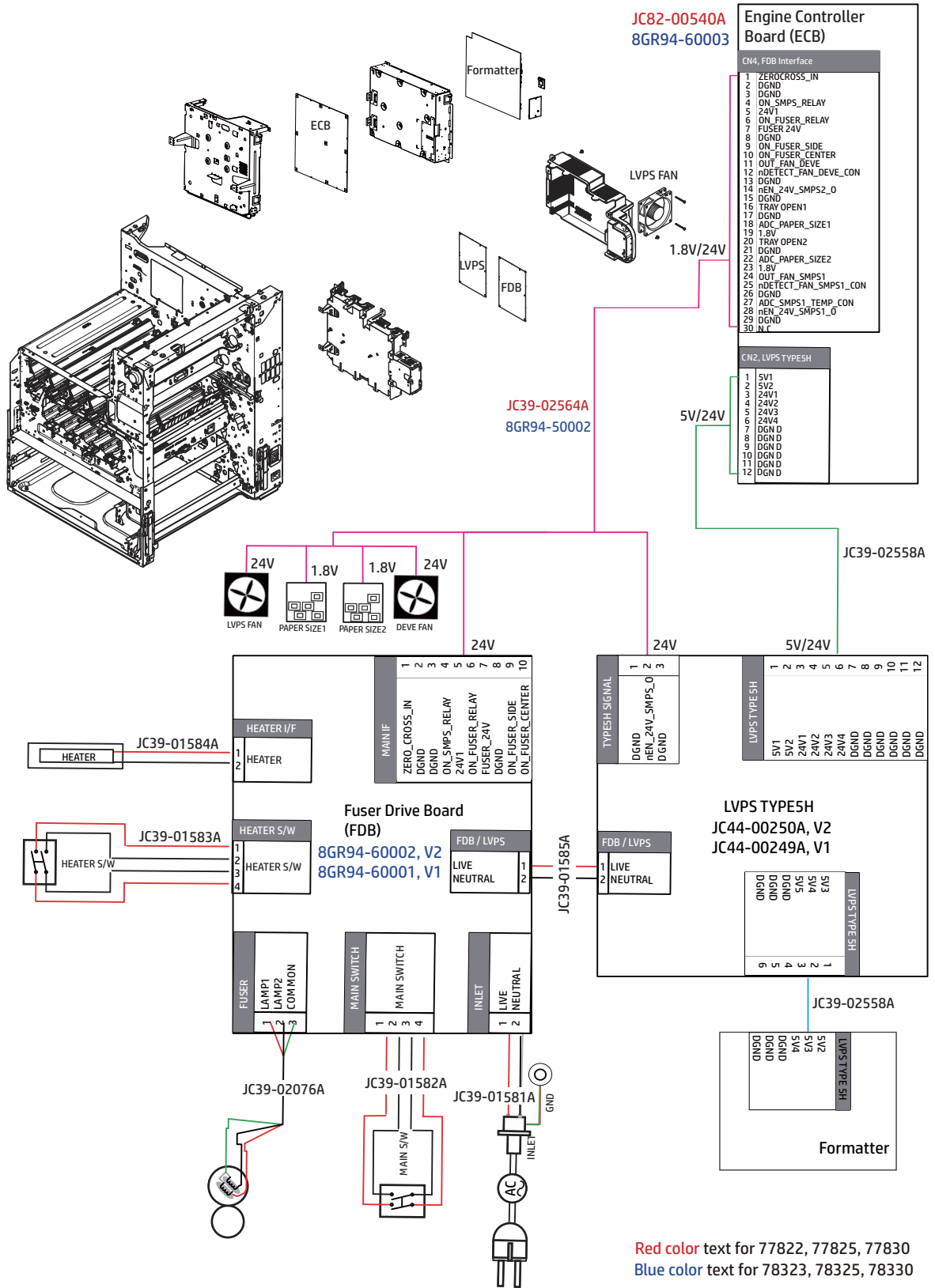


Figure 4-3 High Voltage Power Supply (HVPS) and Laser Scanning Unit (LSU)

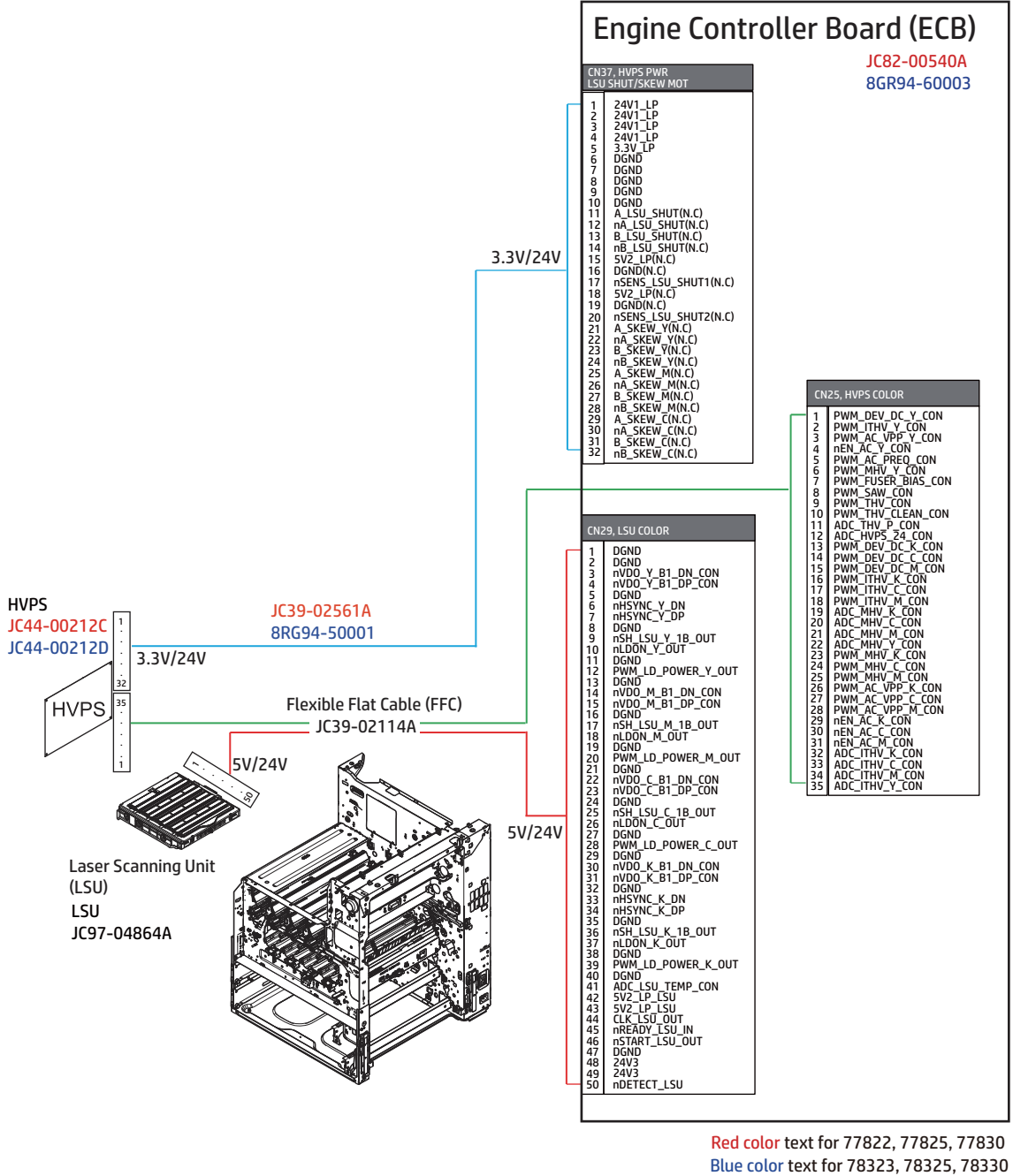
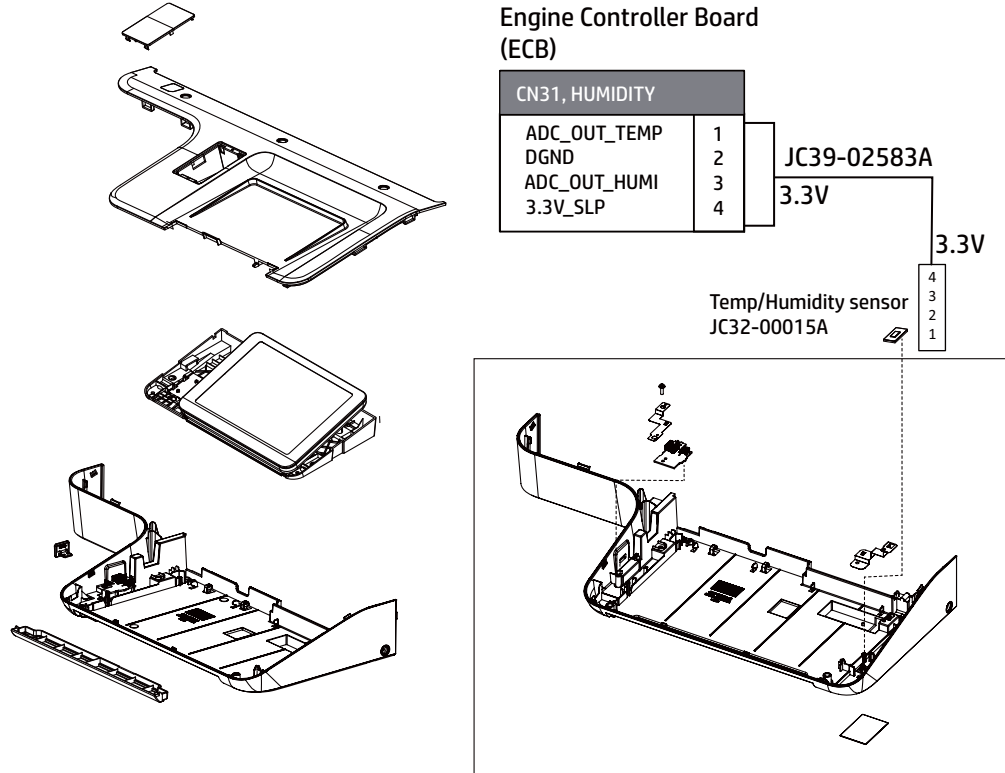


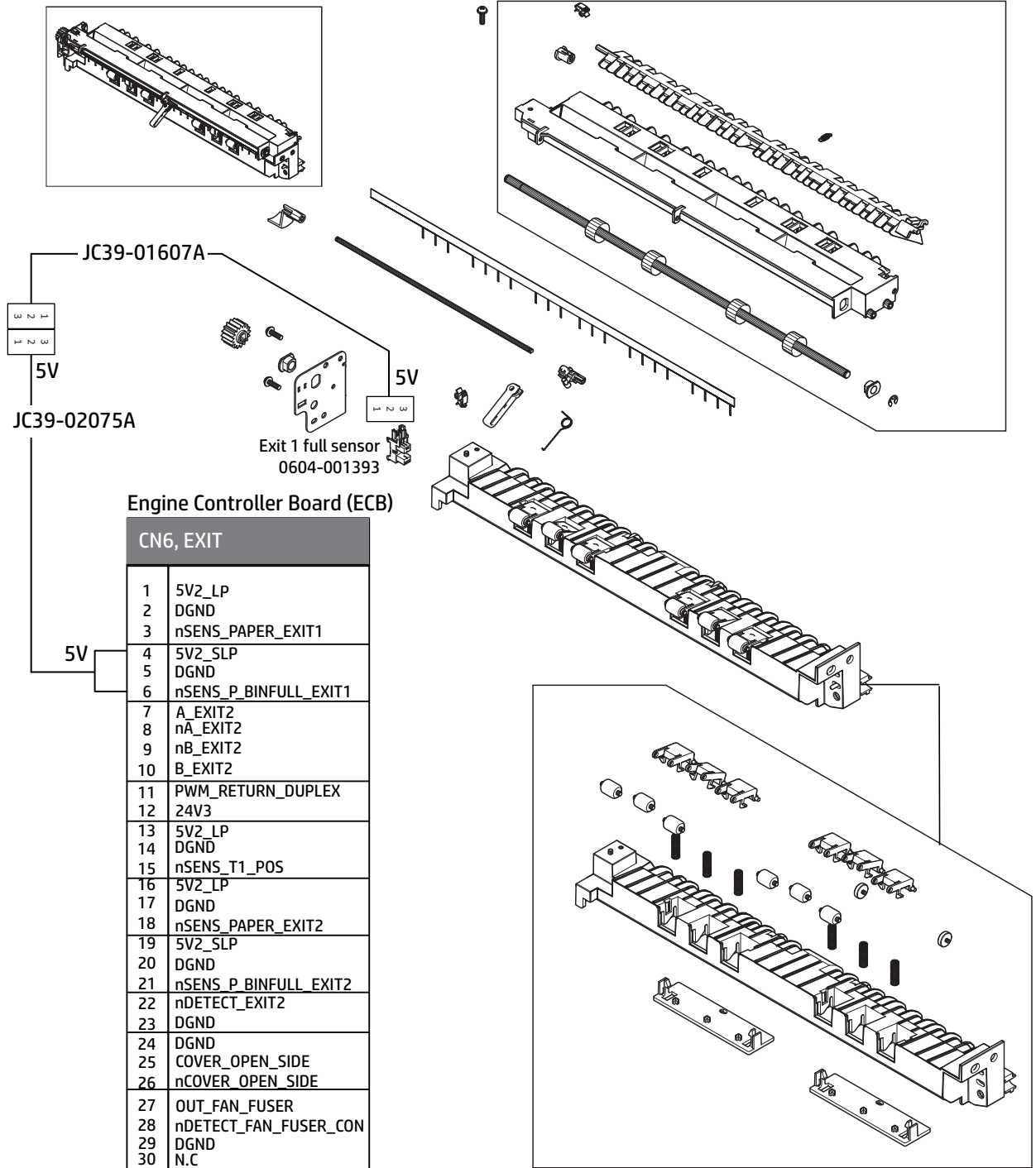
Figure 4-4 Temp/Humidity sensor



## Exit section

Learn about the electrical-mechanical relationships diagram for the exit section.

Figure 4-5 Exit section



## Drive section

Learn about the electrical-mechanical relationships diagram for the drive section.



Figure 4-6 Main drive assembly

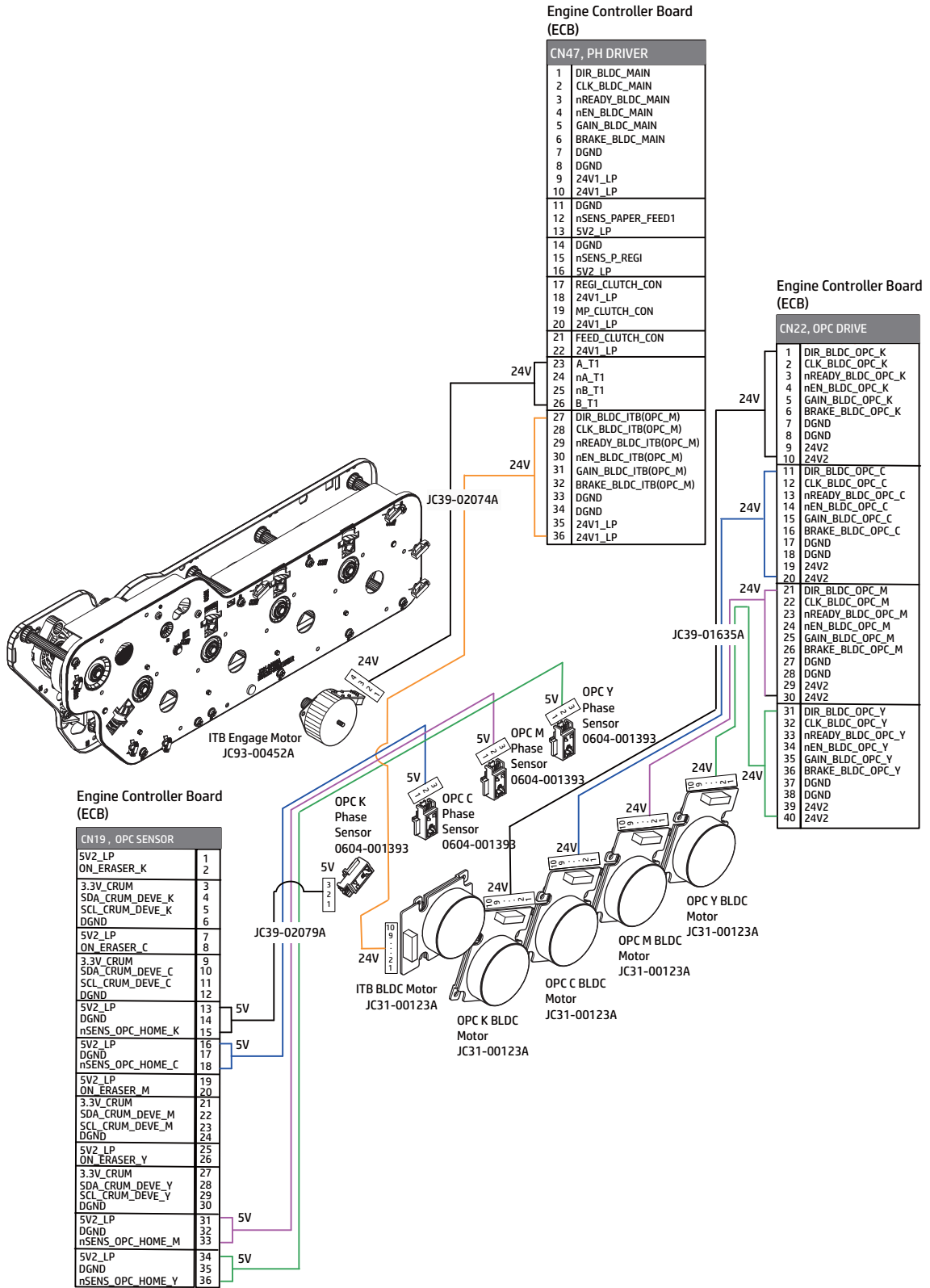


Figure 4-7 Registration & Tray 1 (MP) drive assembly

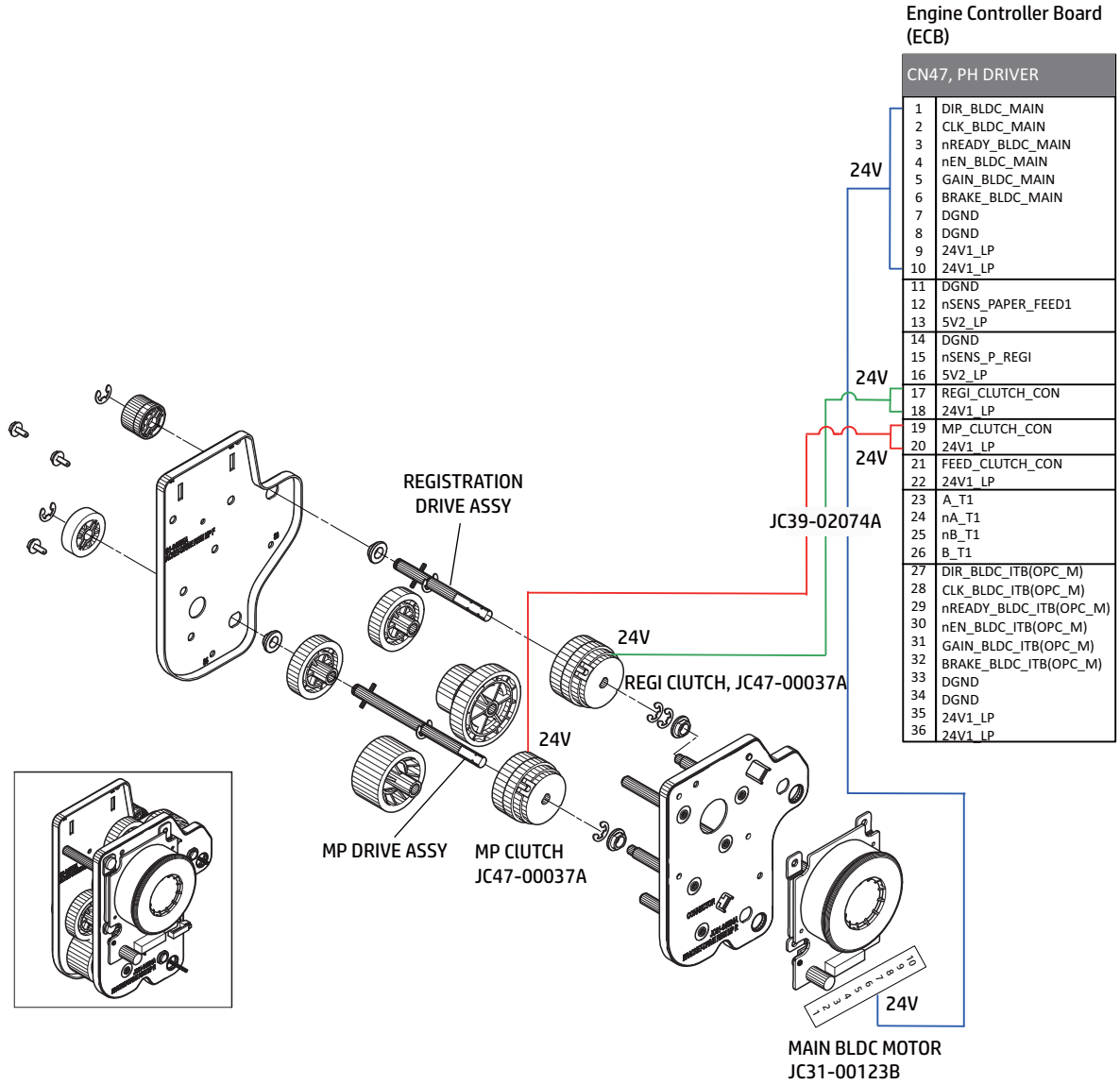


Figure 4-8 Fuser and Exit drive assembly

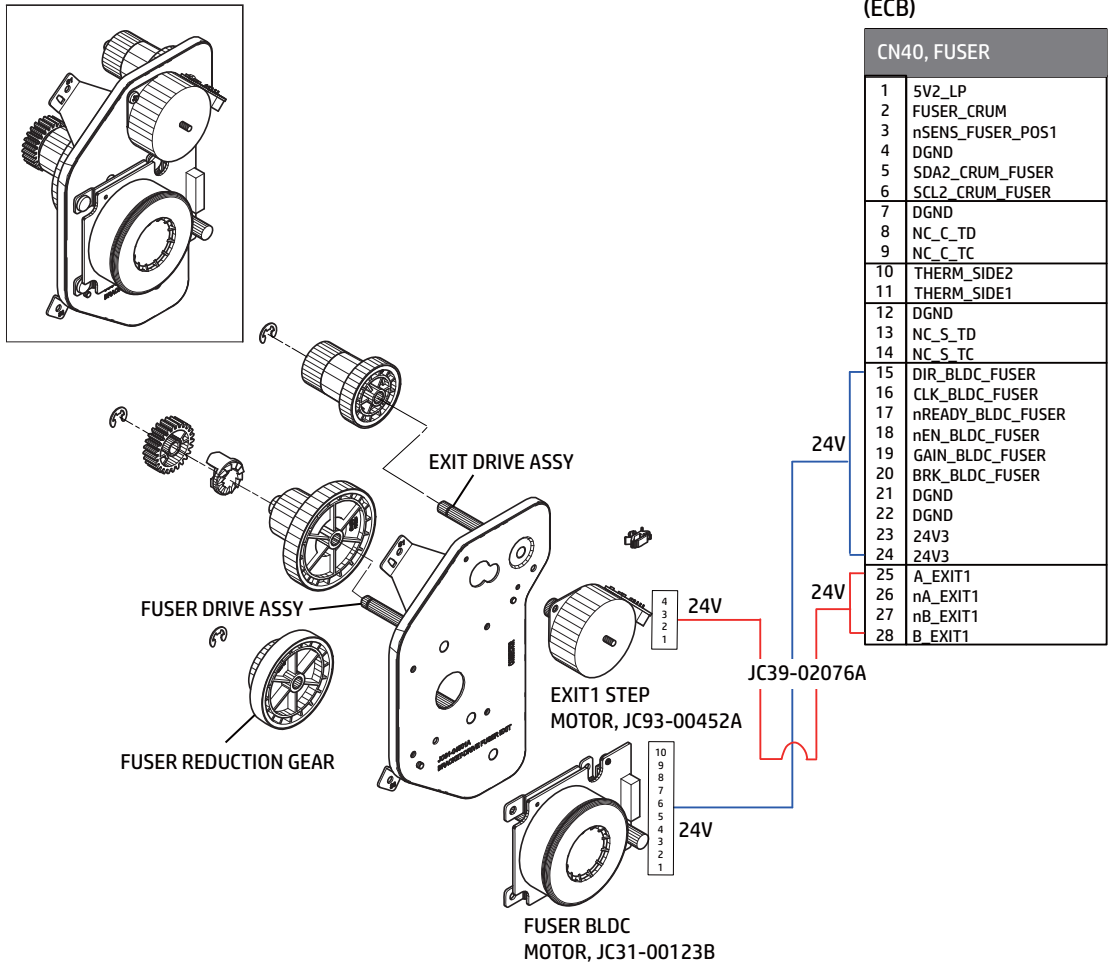


Figure 4-9 Paper feed drive assembly

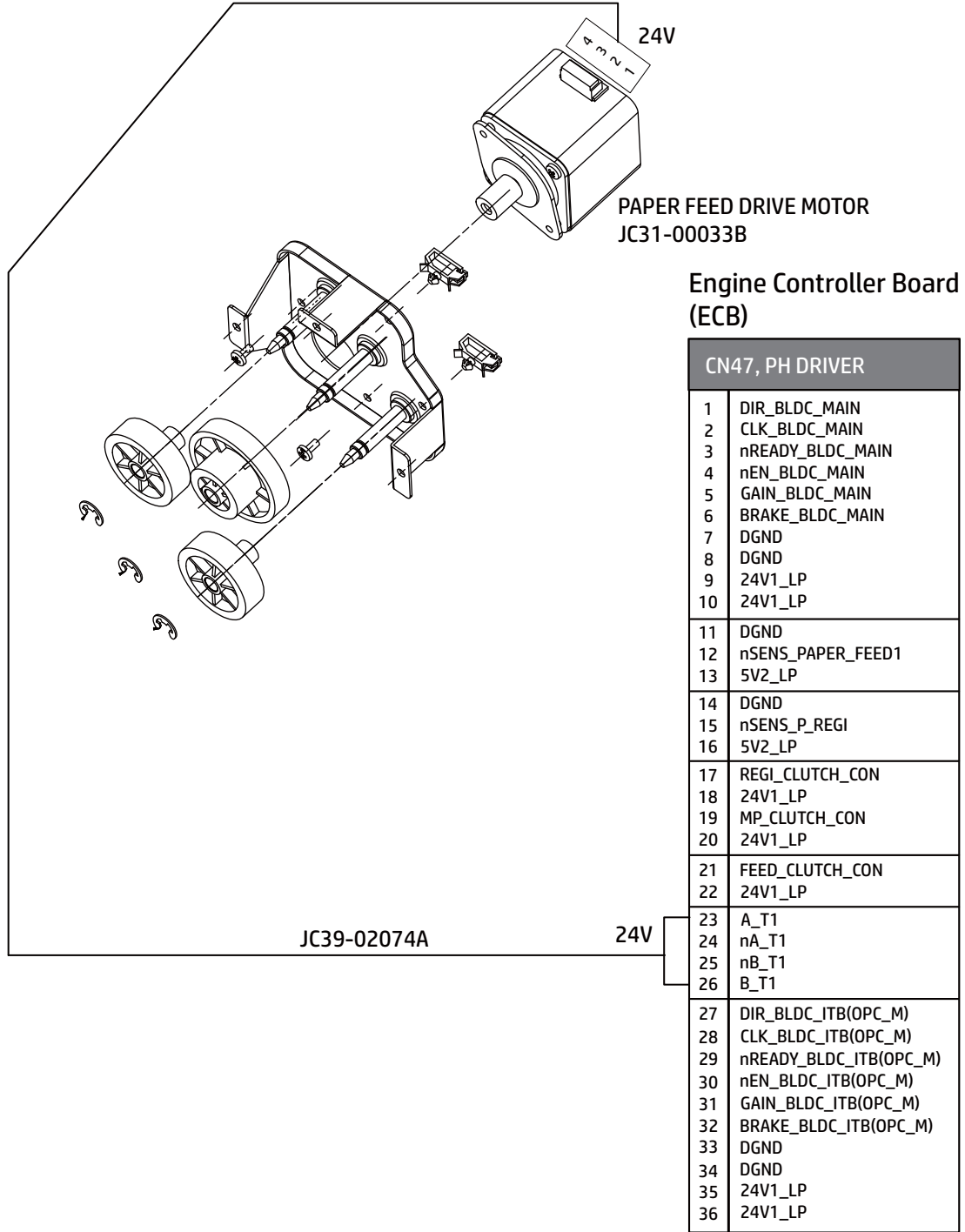


Figure 4-10 Toner supply drive assembly

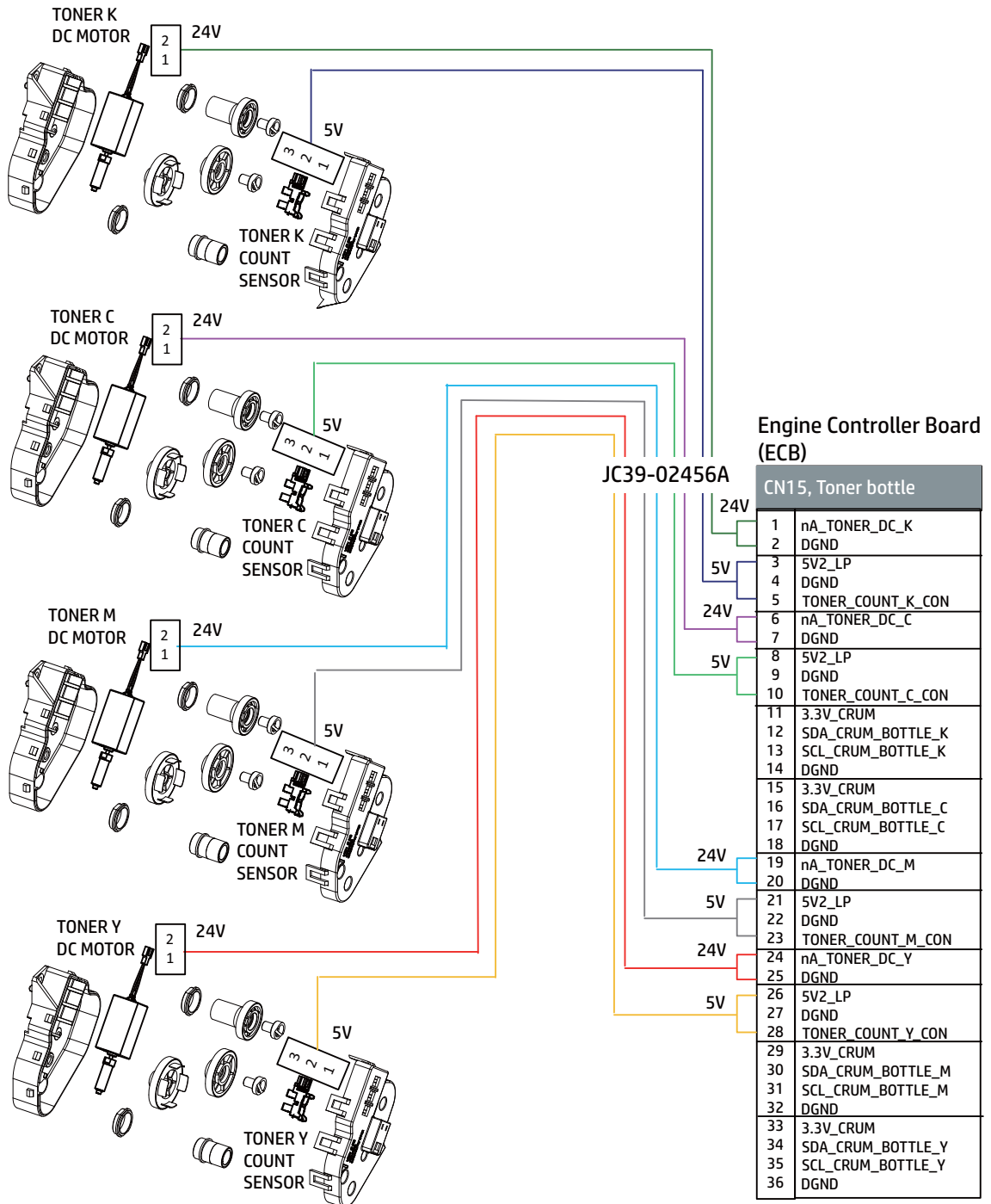
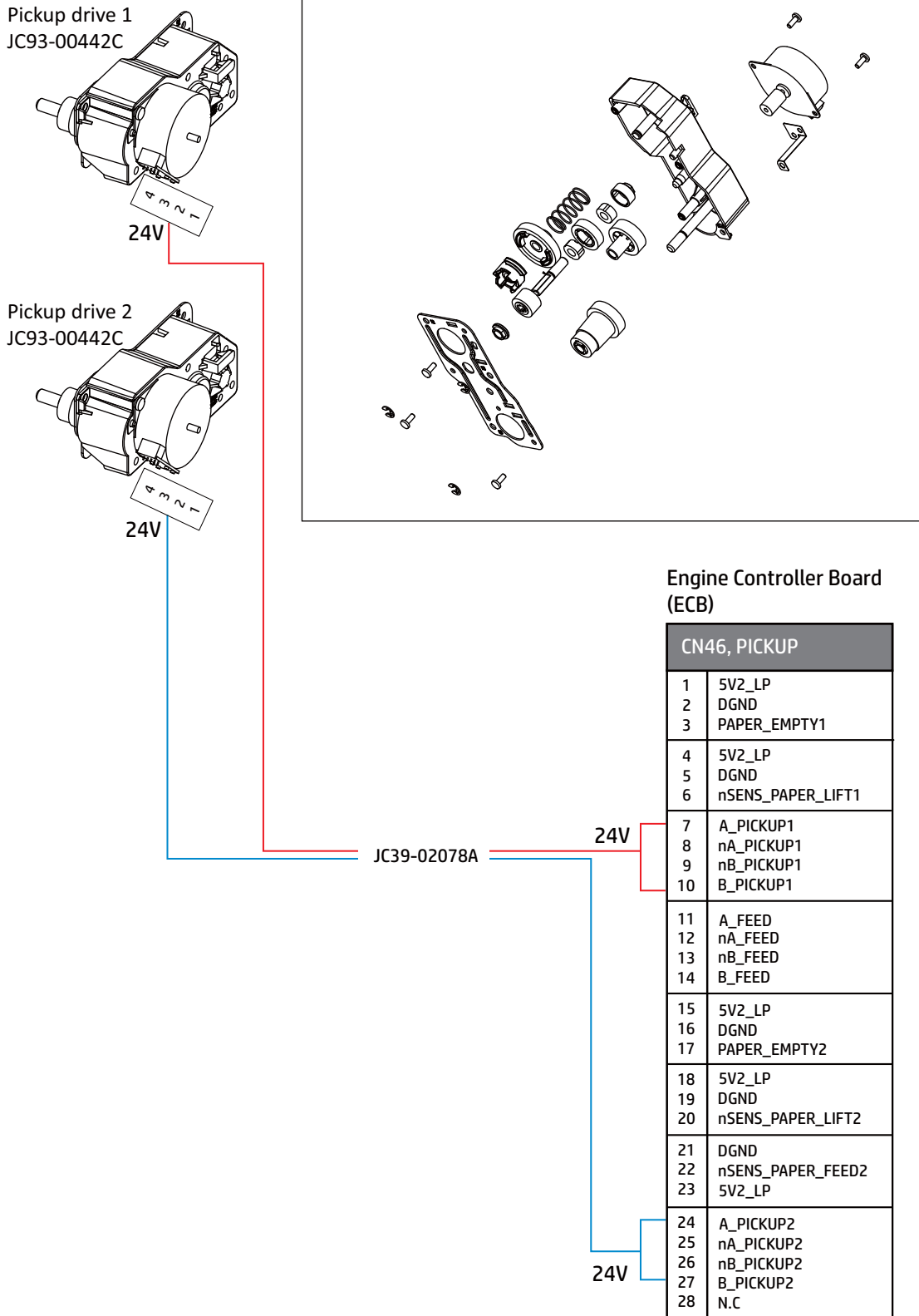


Figure 4-11 Paper pickup drive assembly



# Paper handling section

Learn about the electrical-mechanical relationships diagram for the paper handling section.

Figure 4-12 First & Second pickup assembly

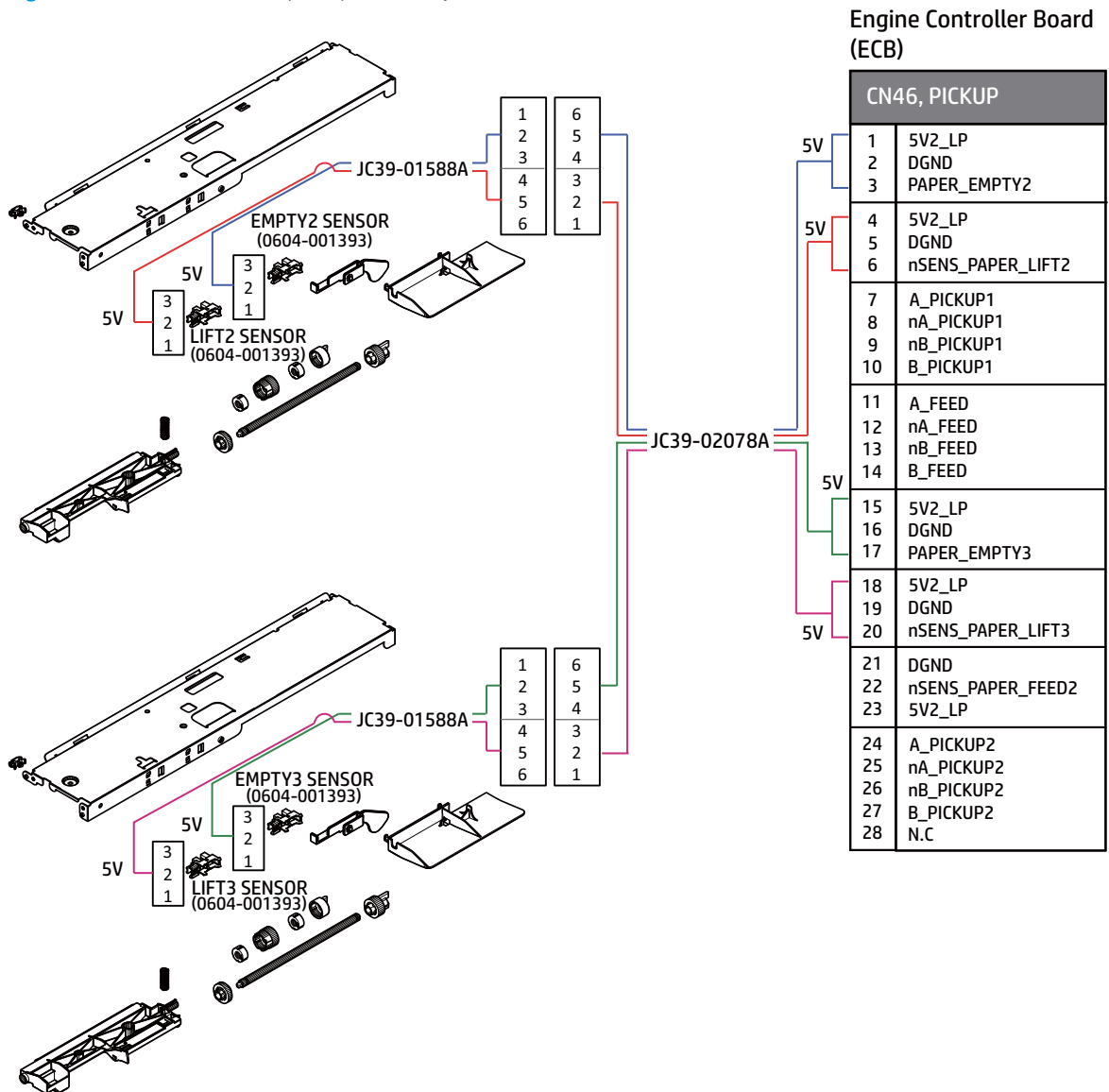
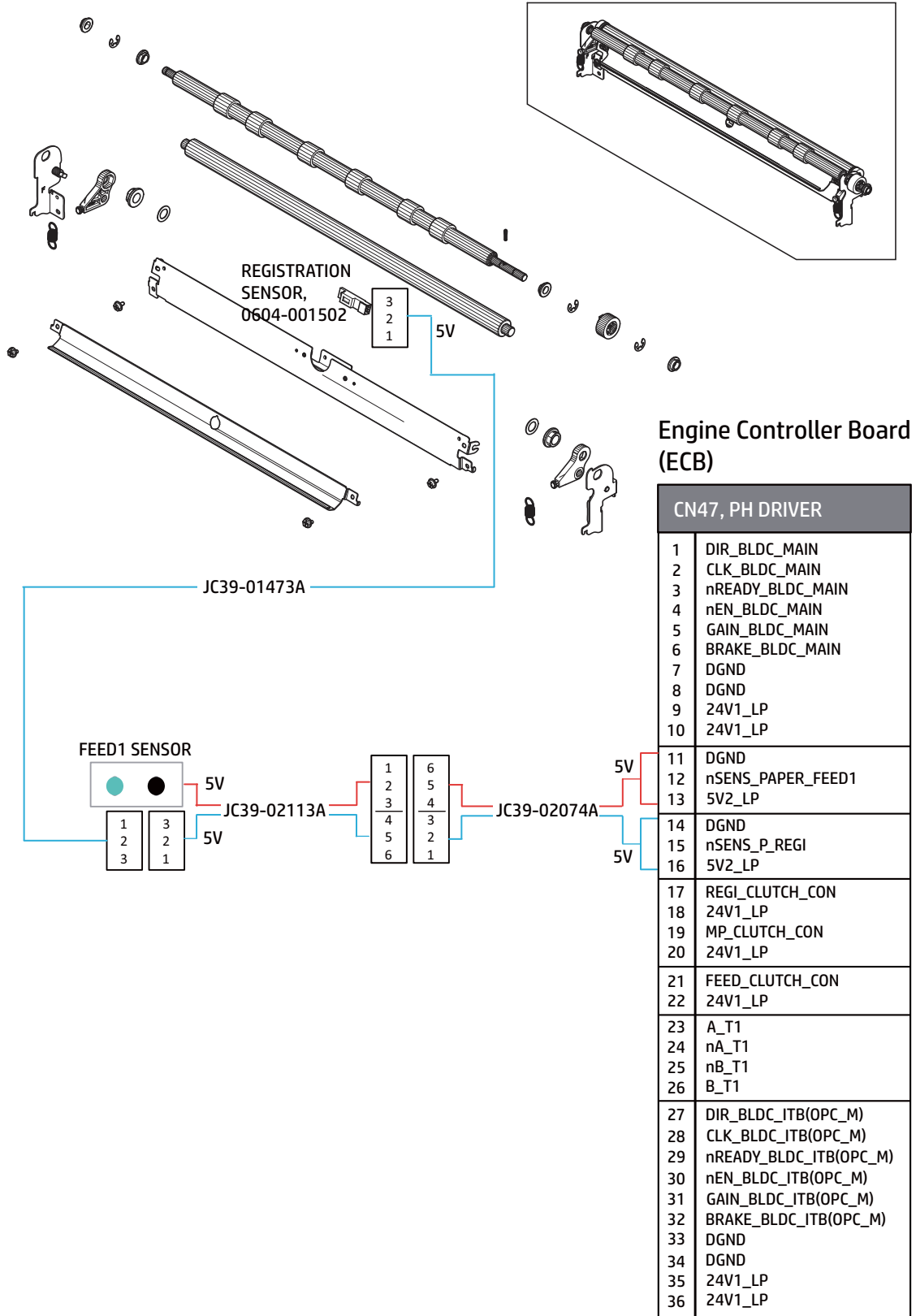


Figure 4-13 Registration assembly





# Frame section

Learn about the electrical-mechanical relationships diagram for the frame section.

Figure 4-14 Front frame

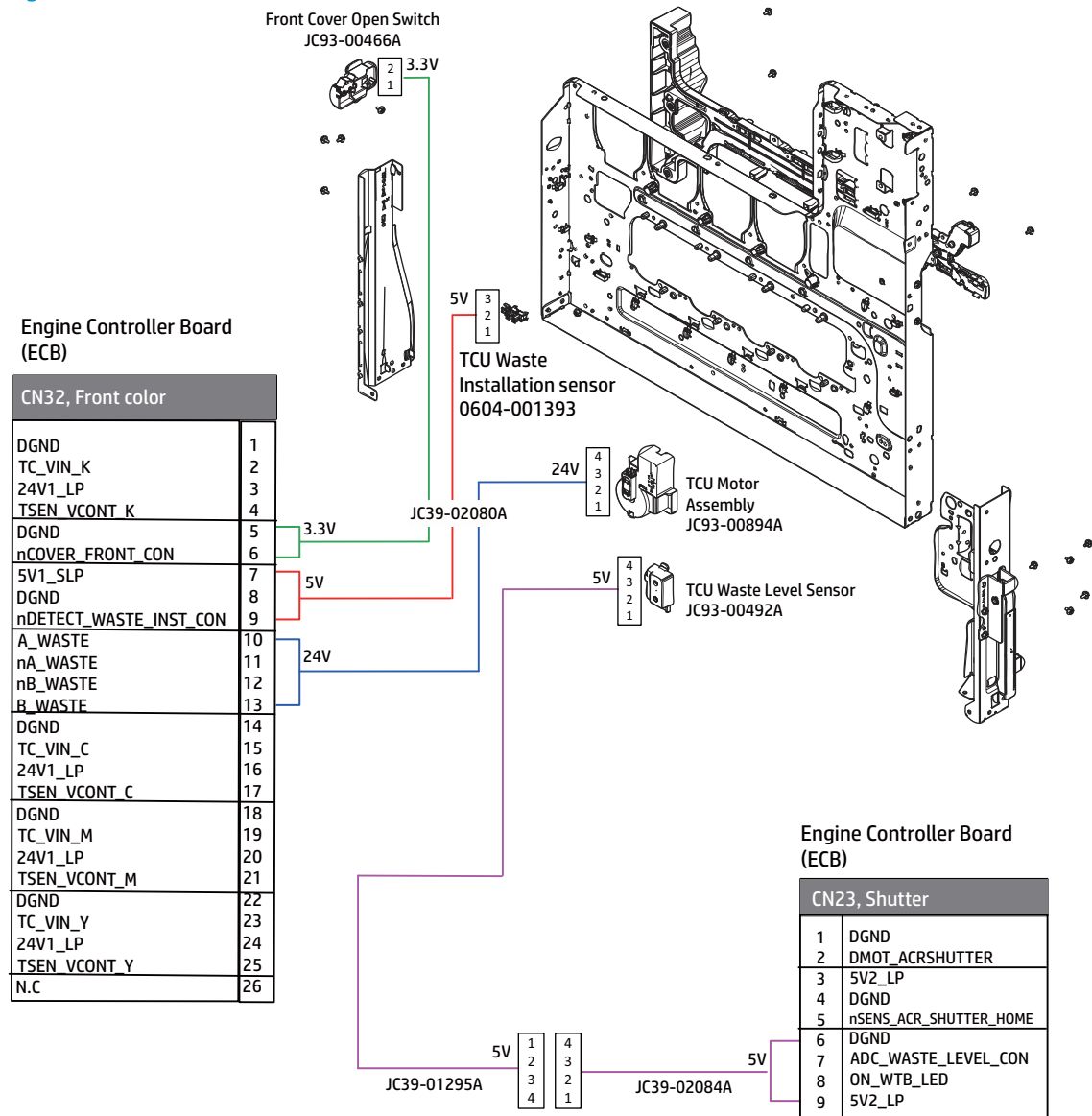


Figure 4-15 Rear frame

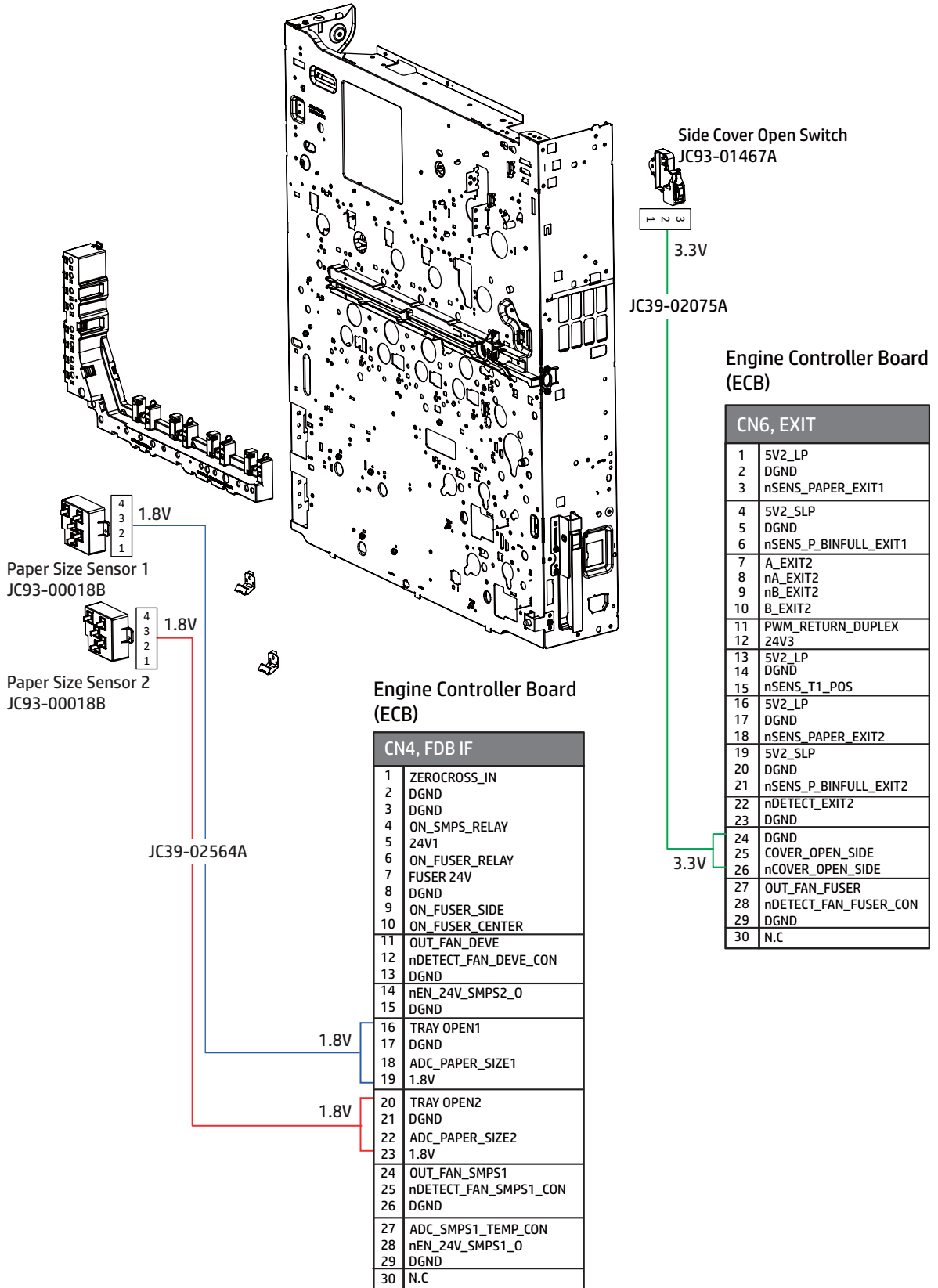
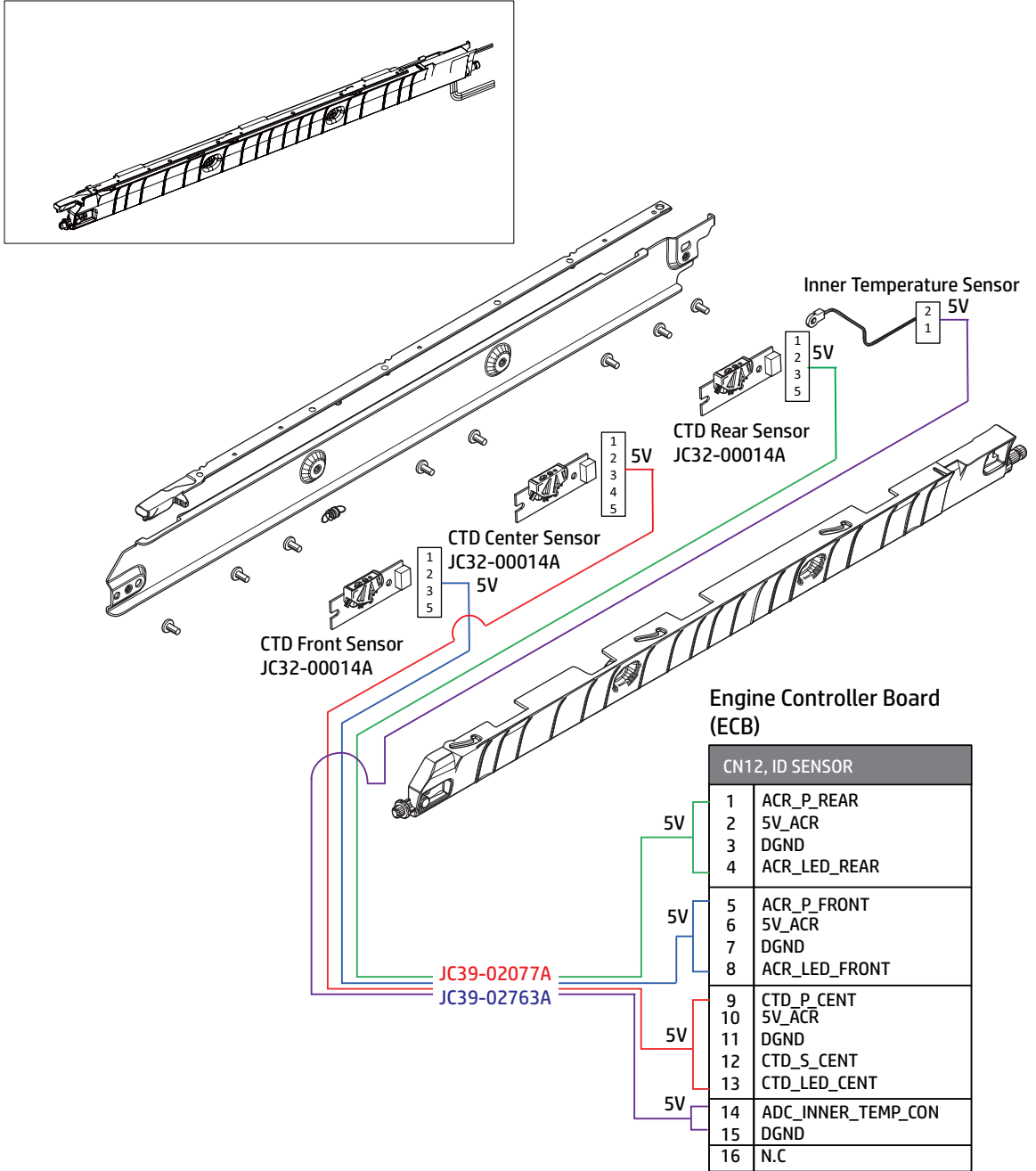
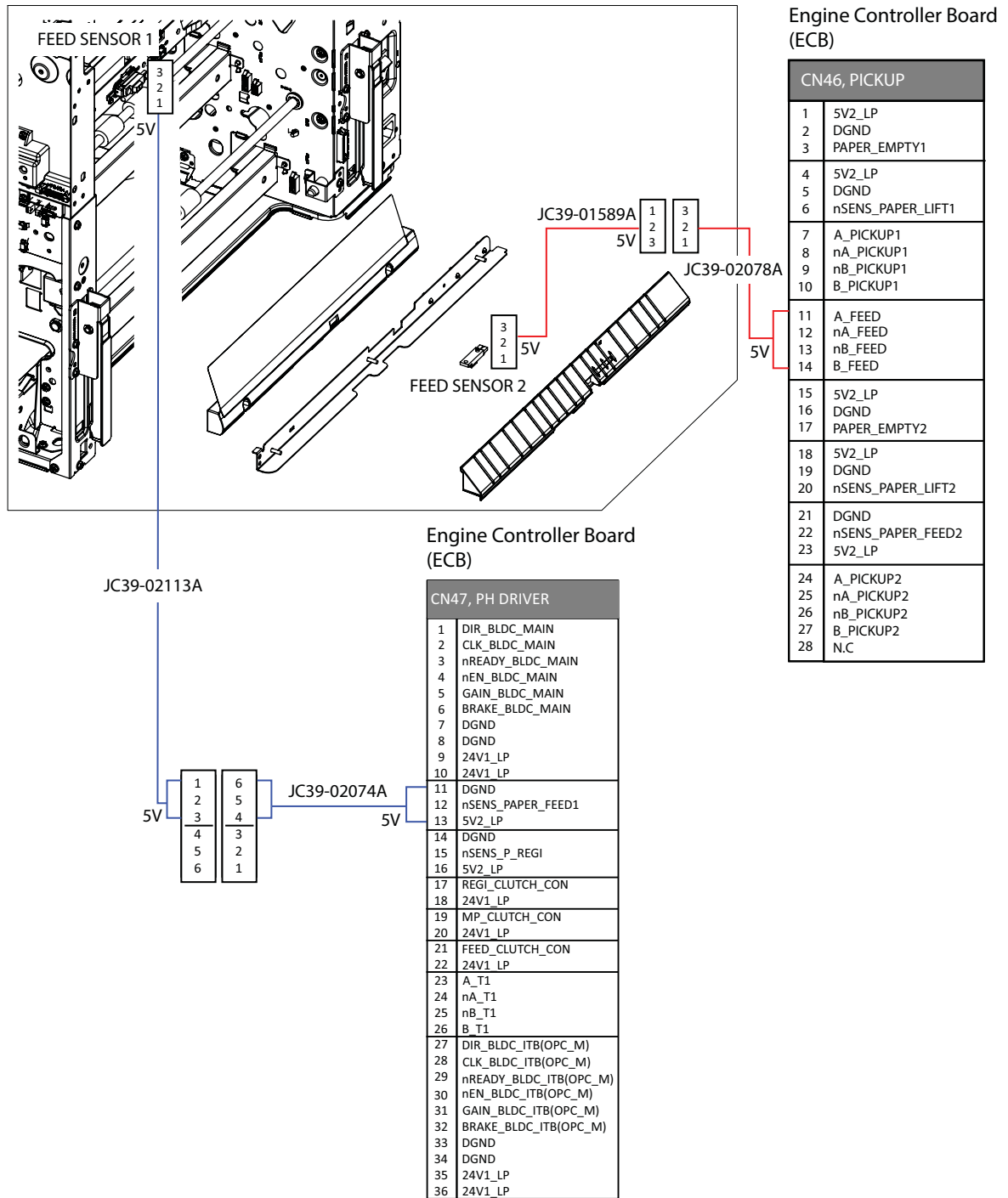


Figure 4-16 Automatic color registration (ACR) assembly



Red color text for E77422, E77428  
 Blue color text for E78223, E78228

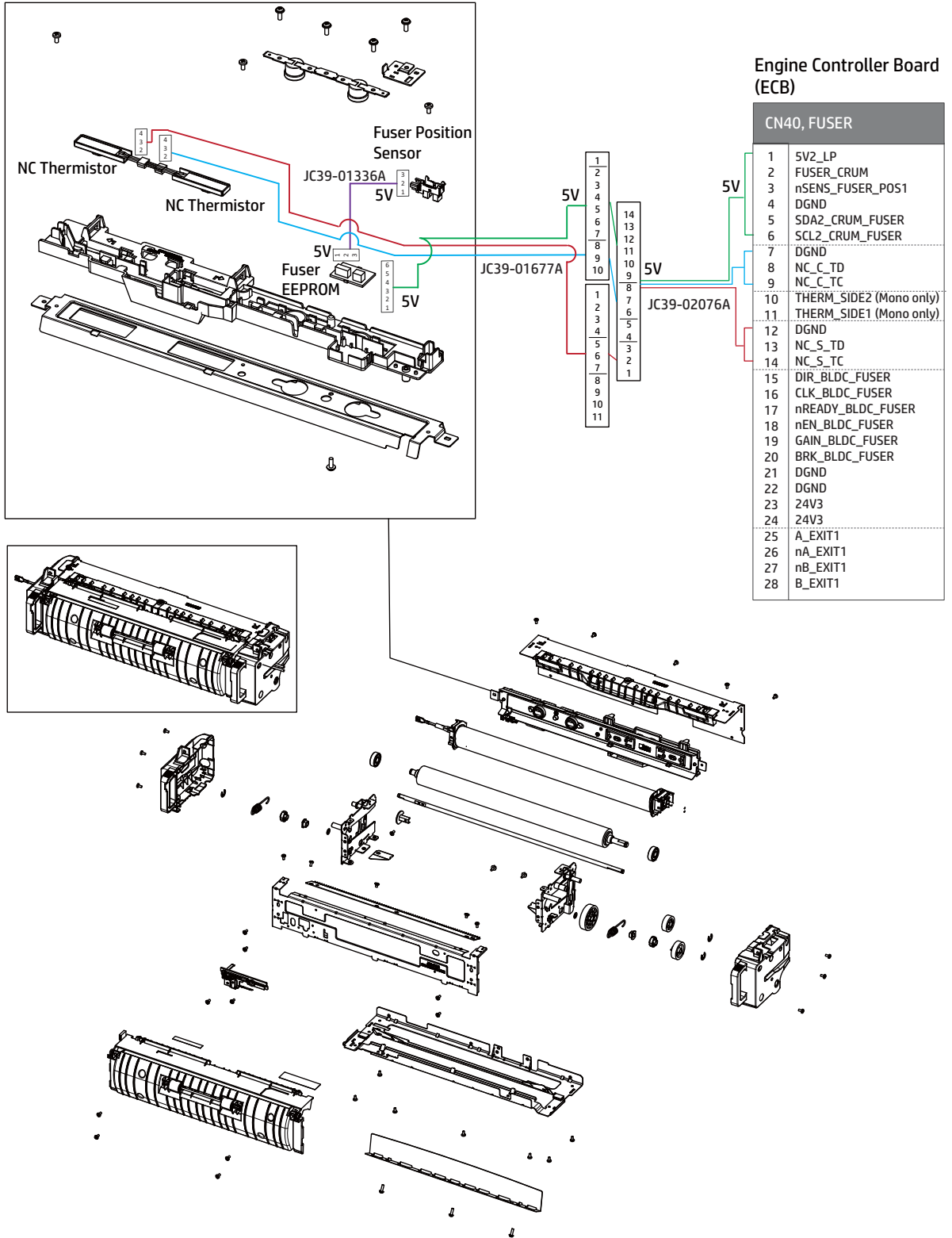
Figure 4-17 Feed sensor  
< MAIN FRAME >



## Fuser section

Learn about the electrical-mechanical relationships diagram for the fuser section.

Figure 4-18 Fuser assembly



## Right door section

Learn about the electrical-mechanical relationships diagram for the right door section.

Figure 4-19 Right door assembly

Engine Controller Board (ECB)

CN36, SIDE	
5V2_SLP	1
DGND	2
nSENS_P_MP_EMPTY	3
MP_SOL_CON	4
24V3	5
A_DUP	6
nA_DUP	7
nB_DUP	8
B_DUP	9
5V2_LP	10
DGND	11
nSENS_P_FUSER_OUT	12
OUT_FAN_DUPLEX2	13
nDETECT_FAN_DUPLEX2_CON	14
DGND	15
(N.C)	16
(N.C)	17
(N.C)	18
5V2_LP	19
DGND	20
nSENS_CURL2	21
5V2_LP	22
DGND	23
nSENS_JAM_DUPLEX	24
OUT_FAN_DUPLEX1	25
nDETECT_FAN_DUPLEX1_CON	26
DGND	27
1.8V	28
ADC_MP_SIZE	29
DGND	30

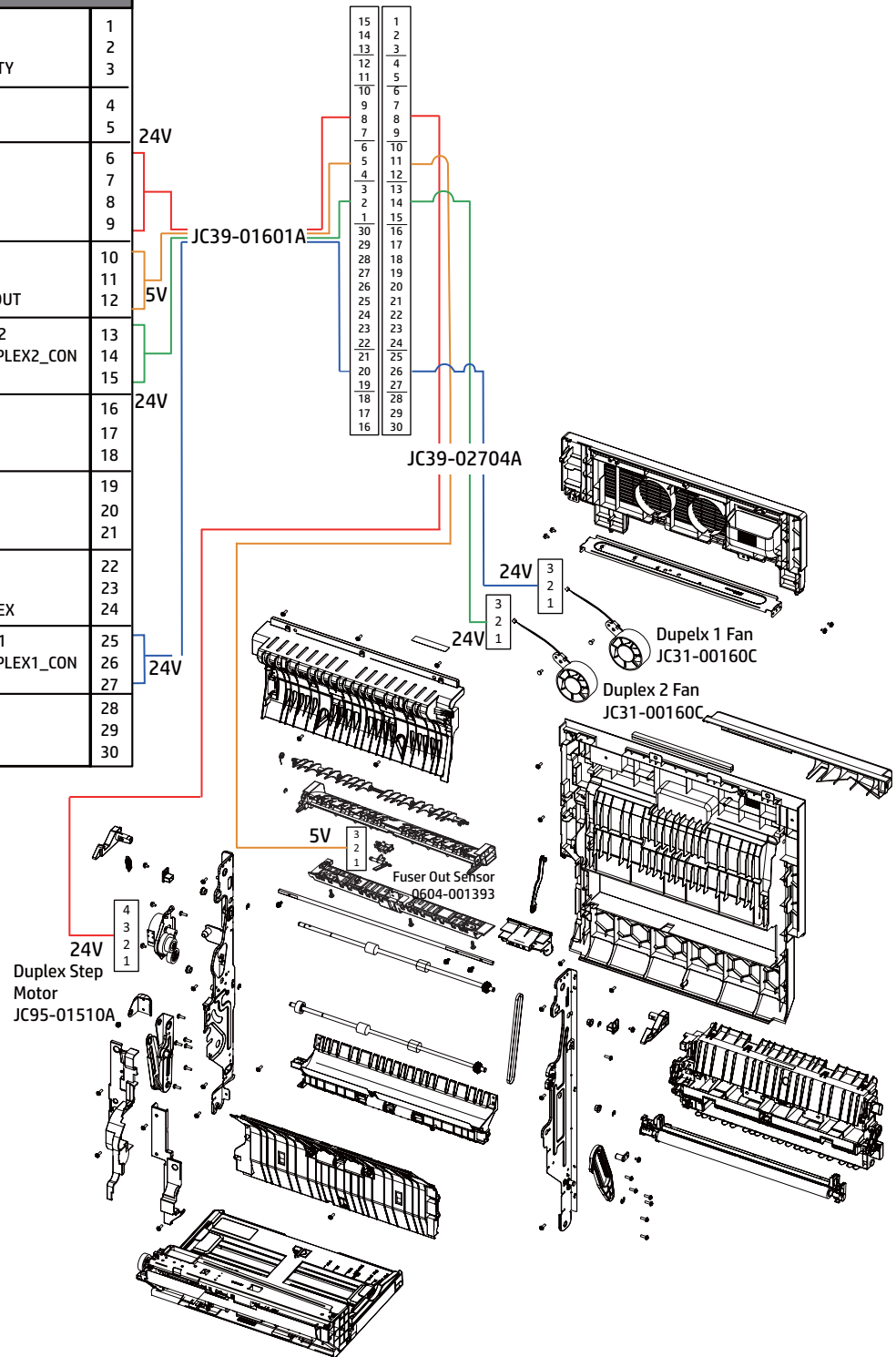


Figure 4-20 Tray 1 assembly

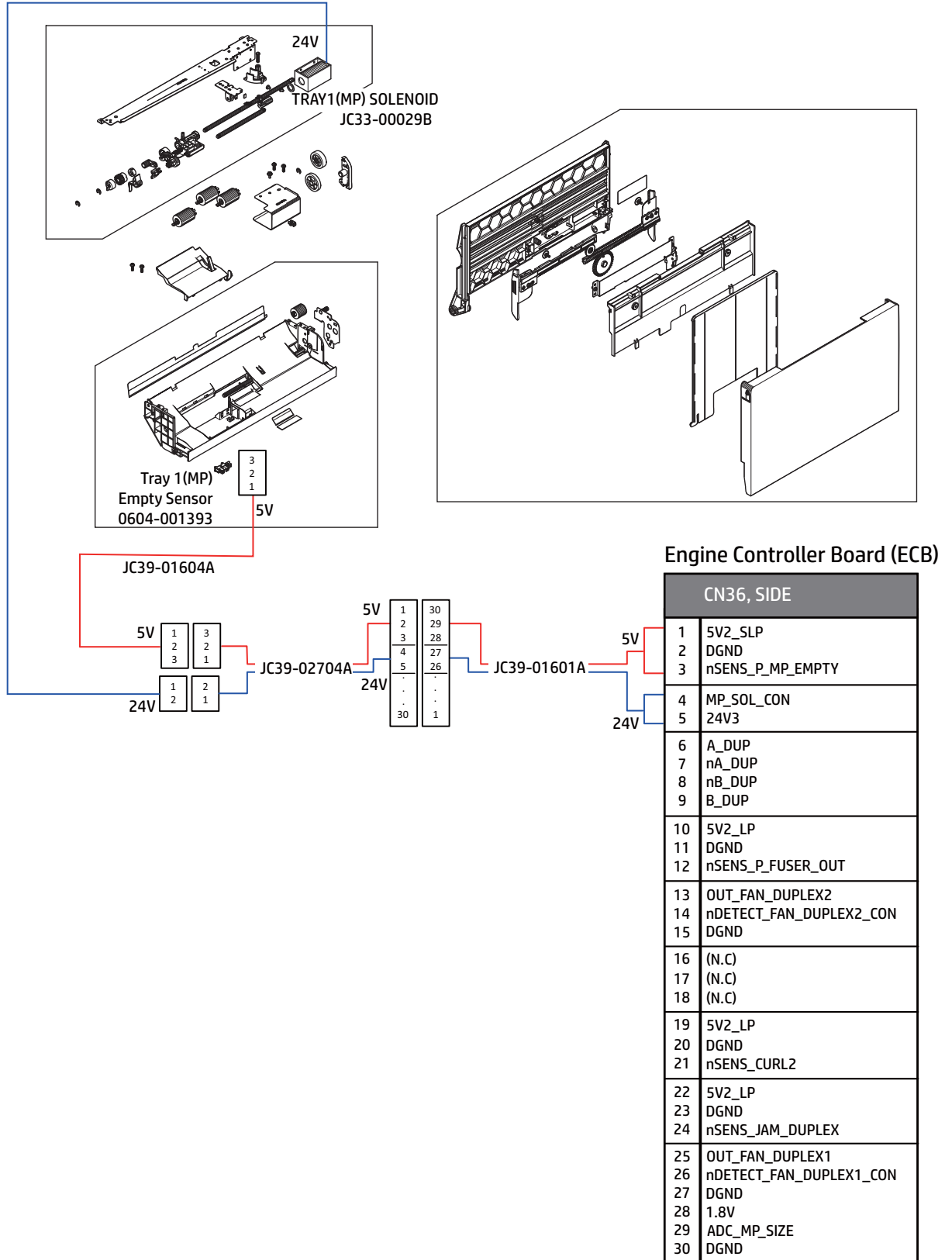


Figure 4-21 Right door duplex

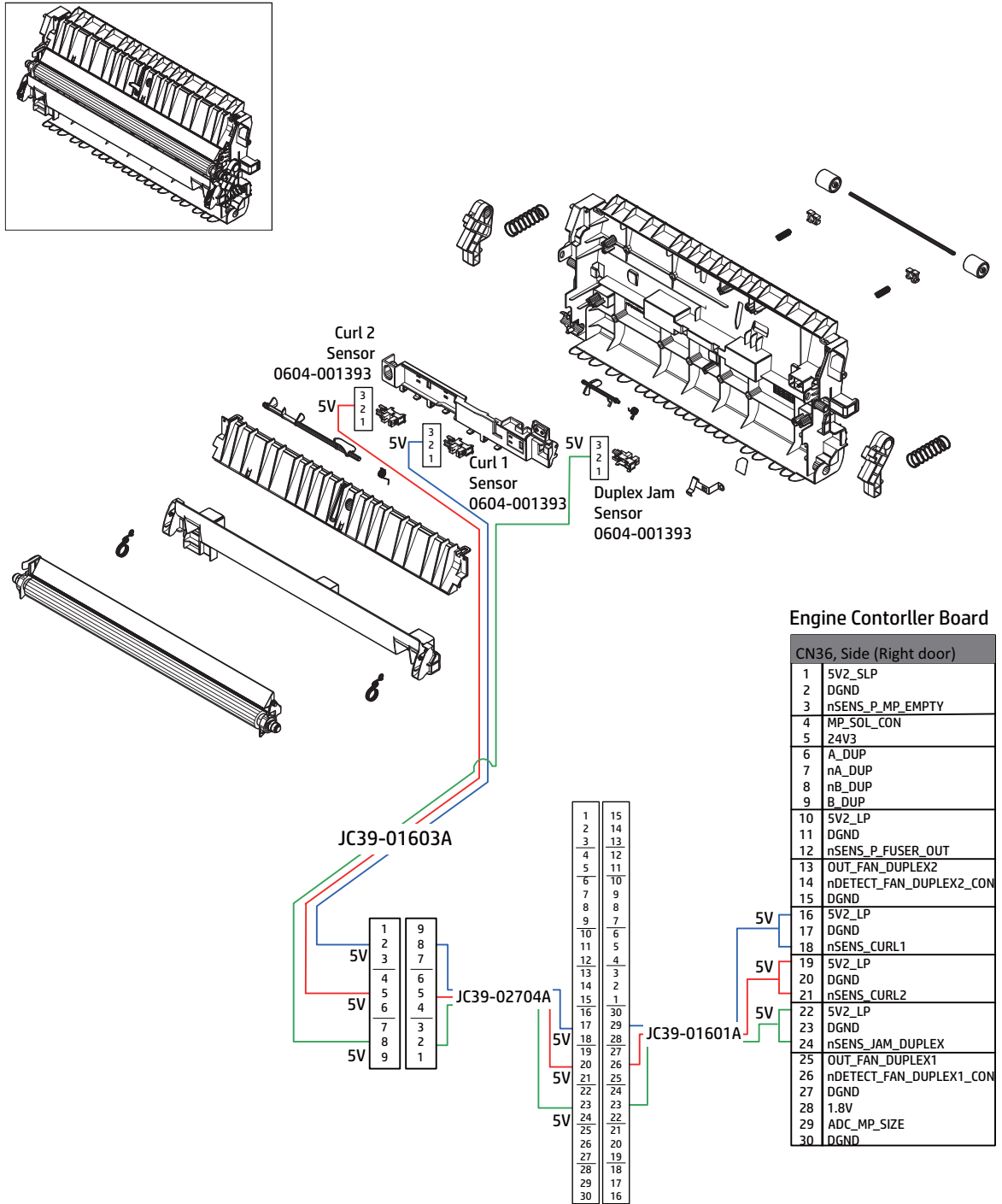
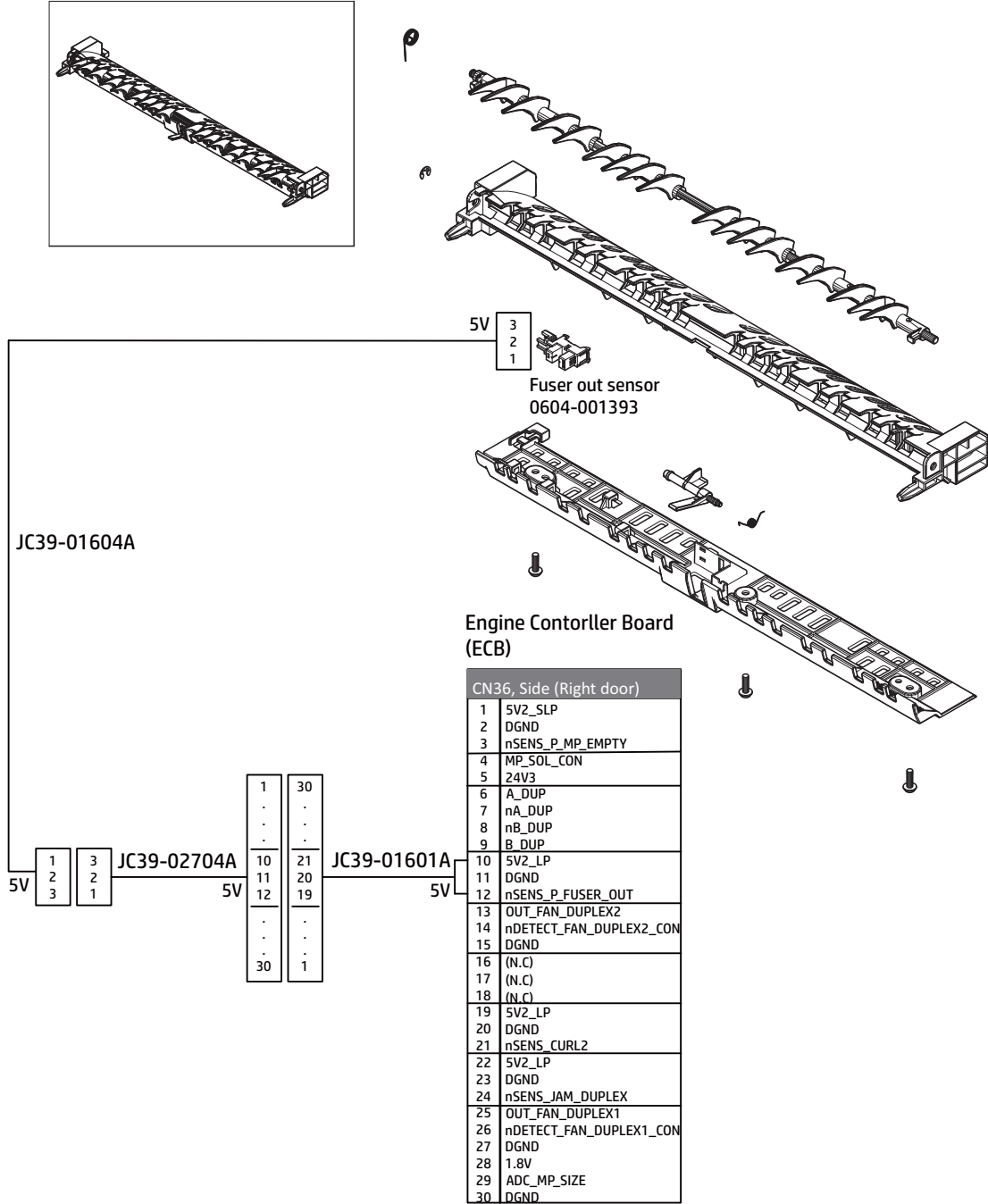




Figure 4-22 Right door output



## Scanner section

Learn about the electrical-mechanical relationships diagram for the scanner section.

Figure 4-23 Scanner assembly (1 of 2)

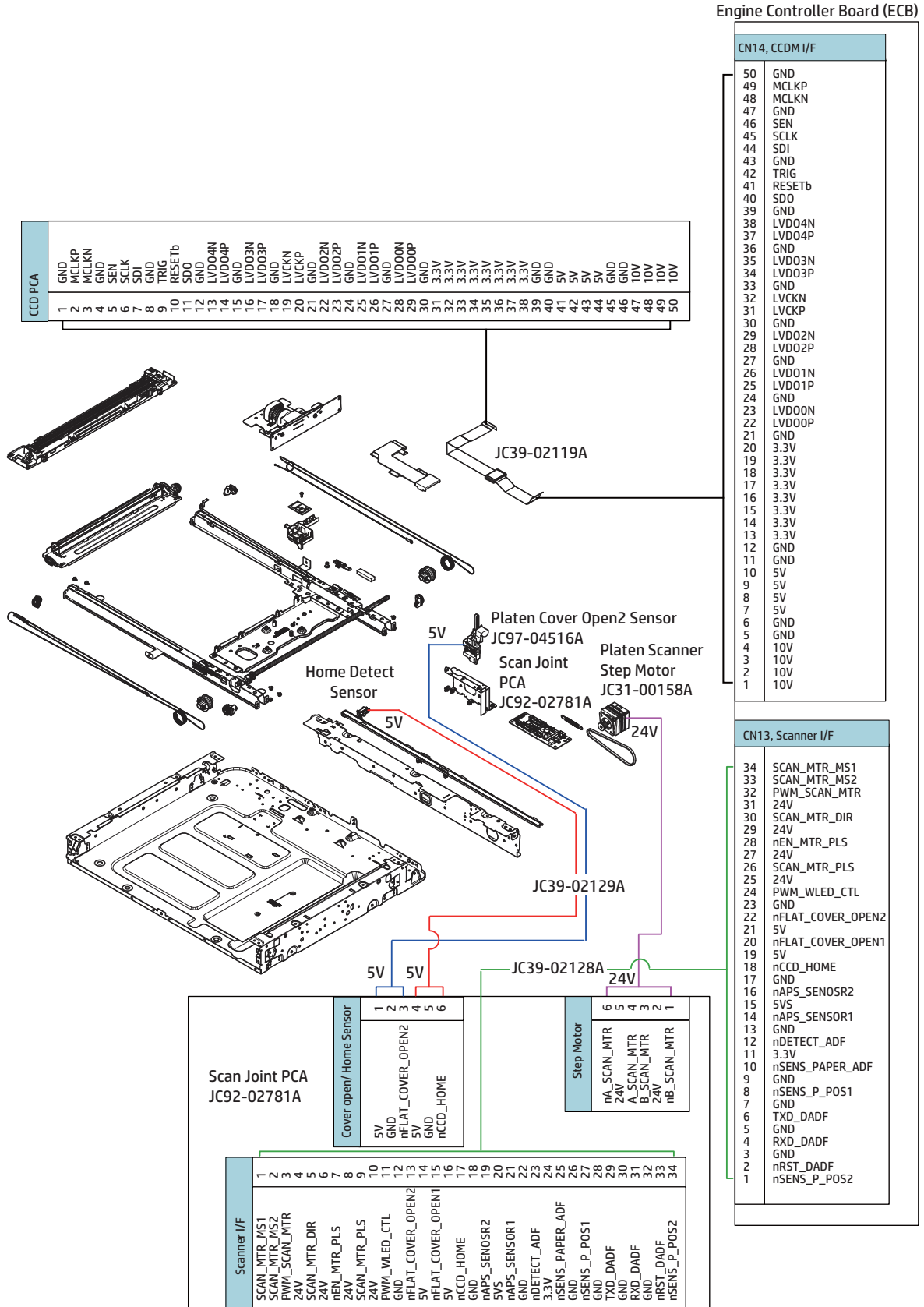
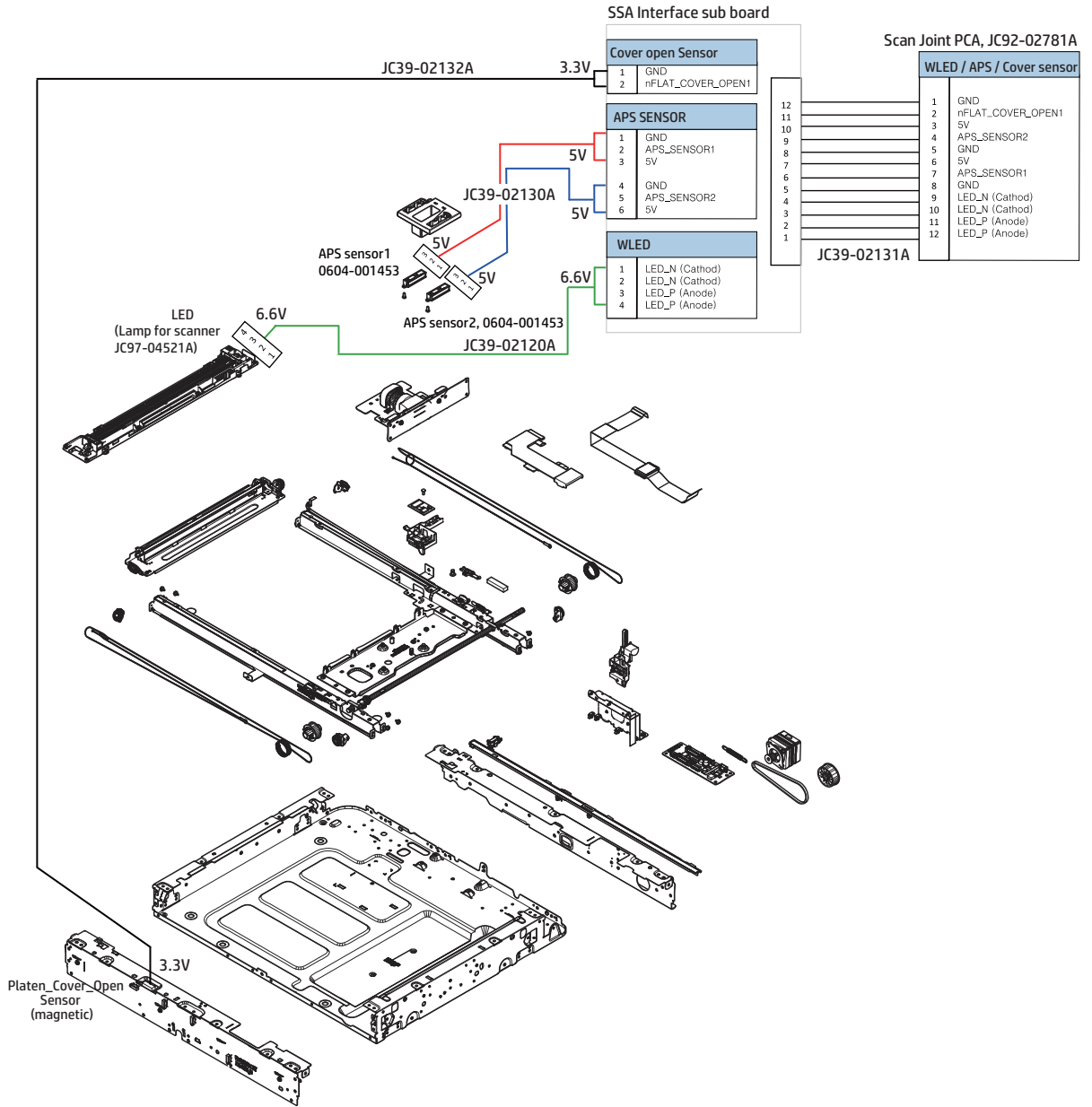


Figure 4-24 Scanner assembly (2 of 2)



## Document feeder section

Learn about the electrical-mechanical relationships diagram for the document feeder section.

Figure 4-25 Document feeder (1 of 2)

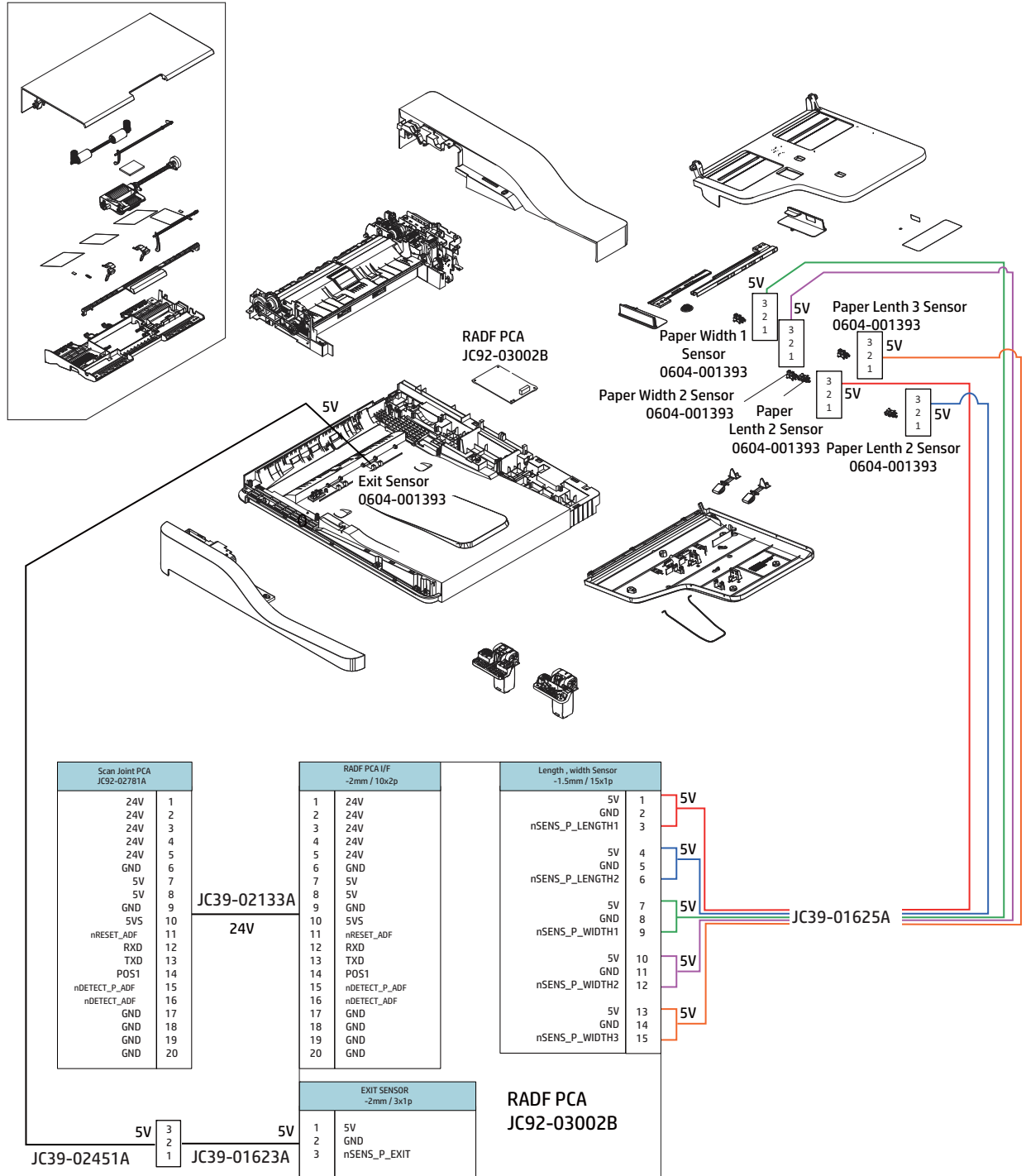
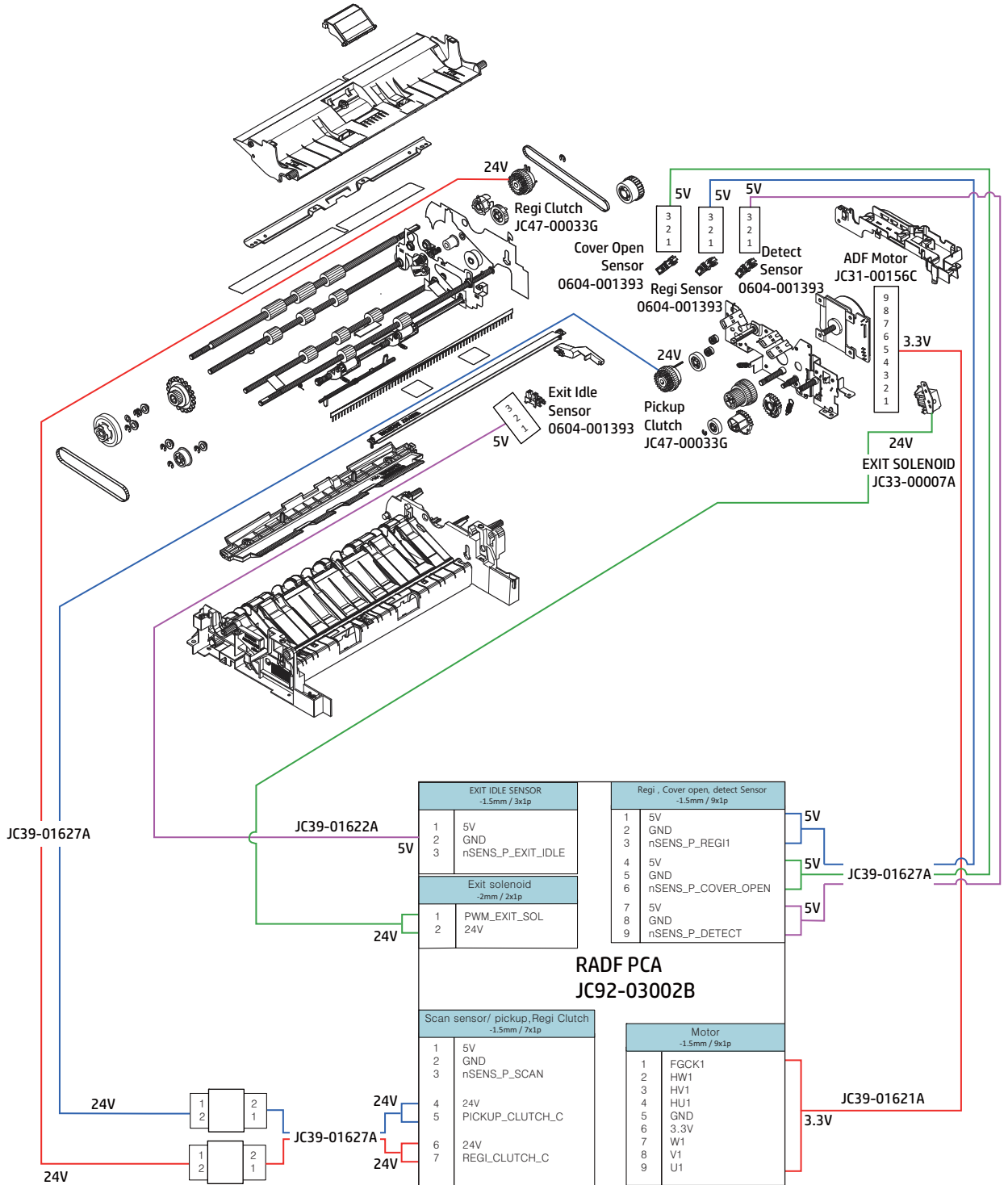


Figure 4-26 Document feeder (2 of 2)



## Image formation section

Learn about the electrical-mechanical relationships diagram for the image formation section.

Figure 4-27 Image transfer belt (ITB) assembly

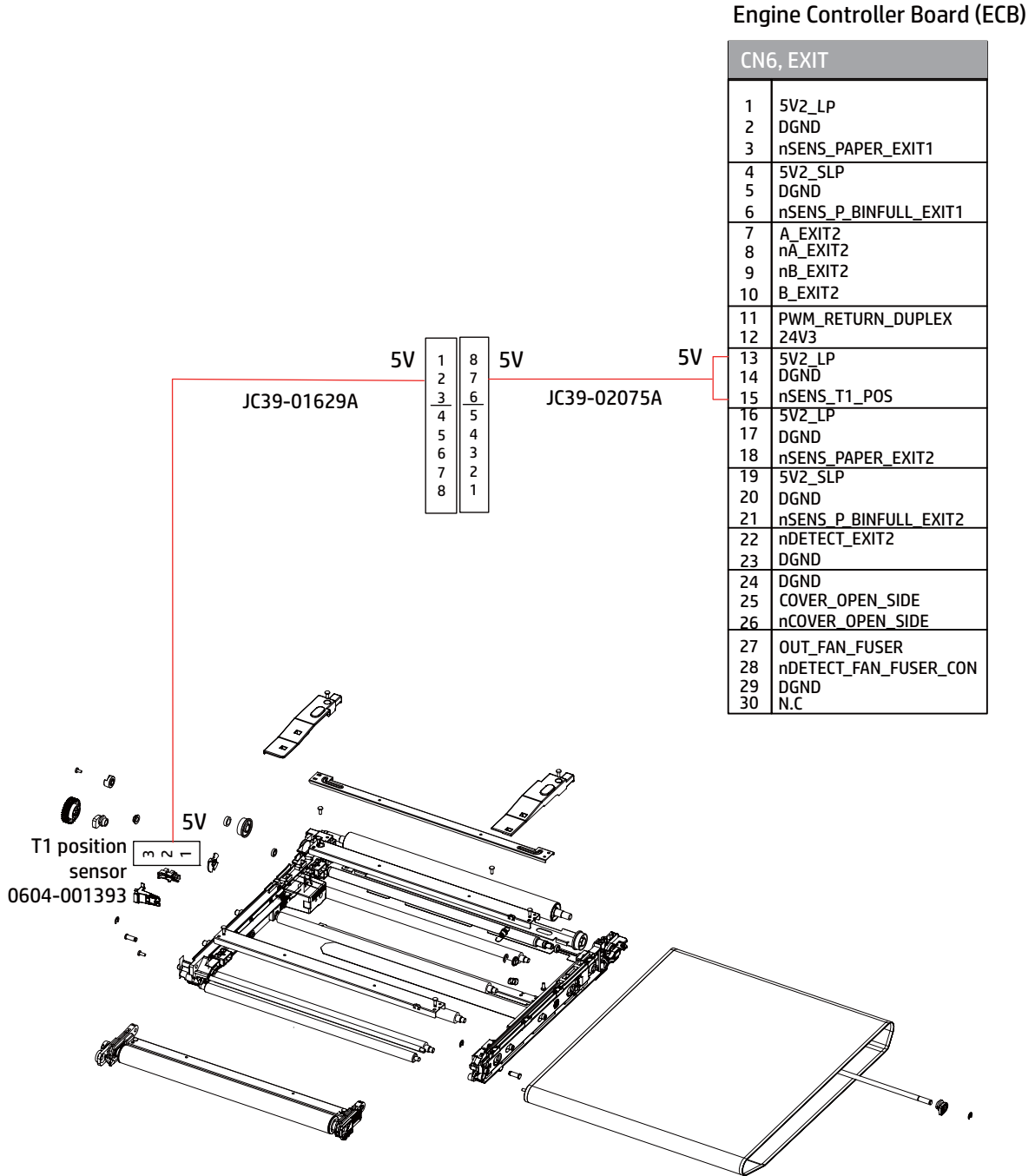


Figure 4-28 Toner cartridges

Engine Controller Board  
(ECB)

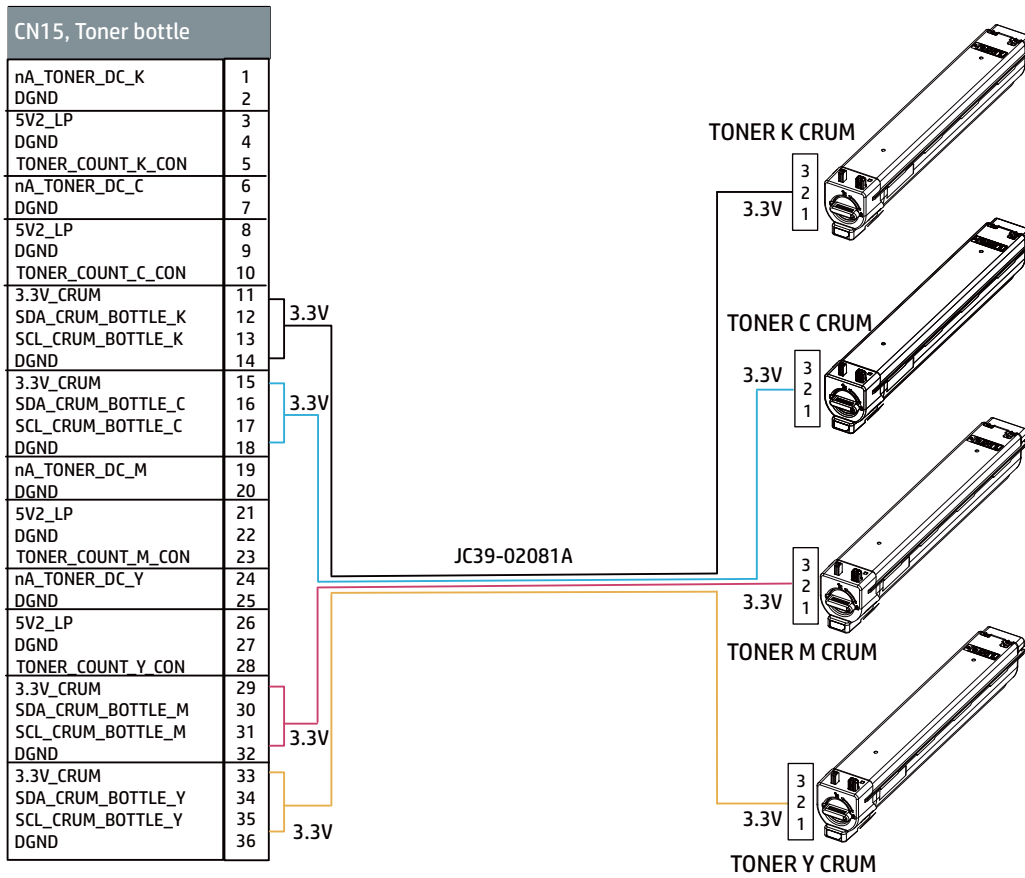
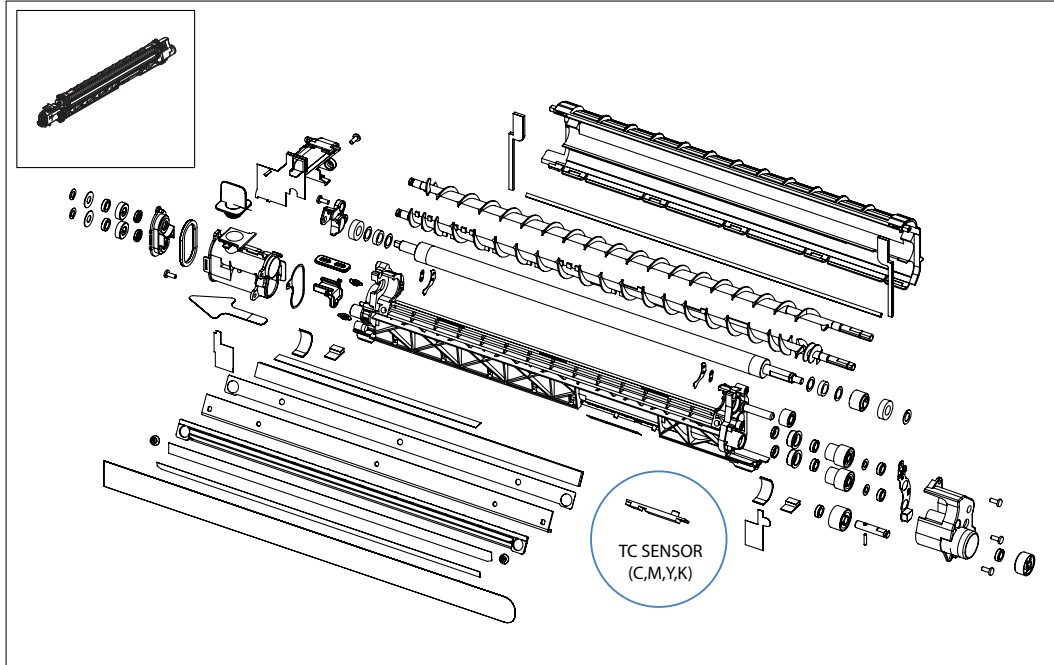


Figure 4-29 TC sensor



Engine Controller Board (ECB)

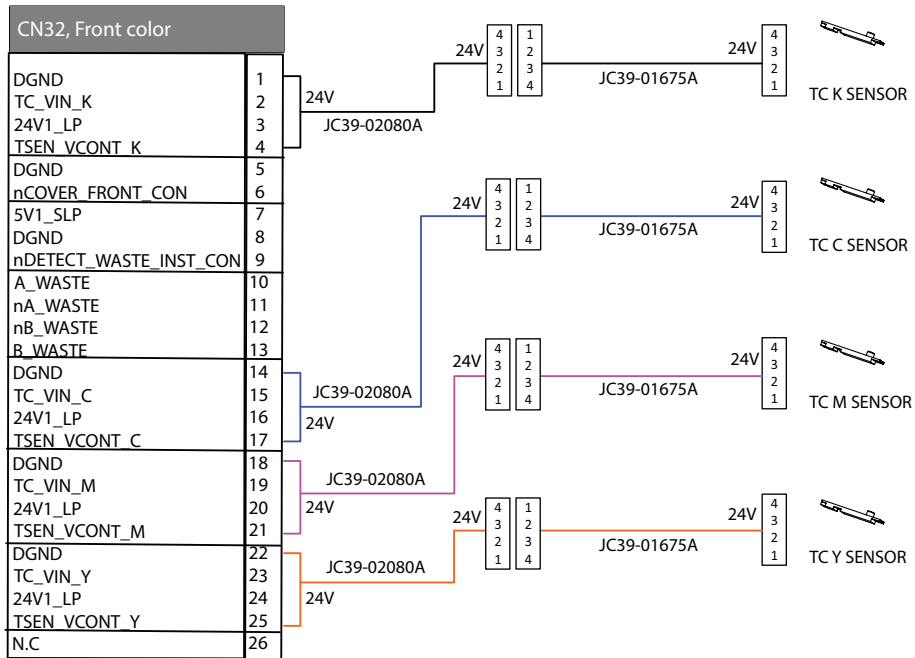
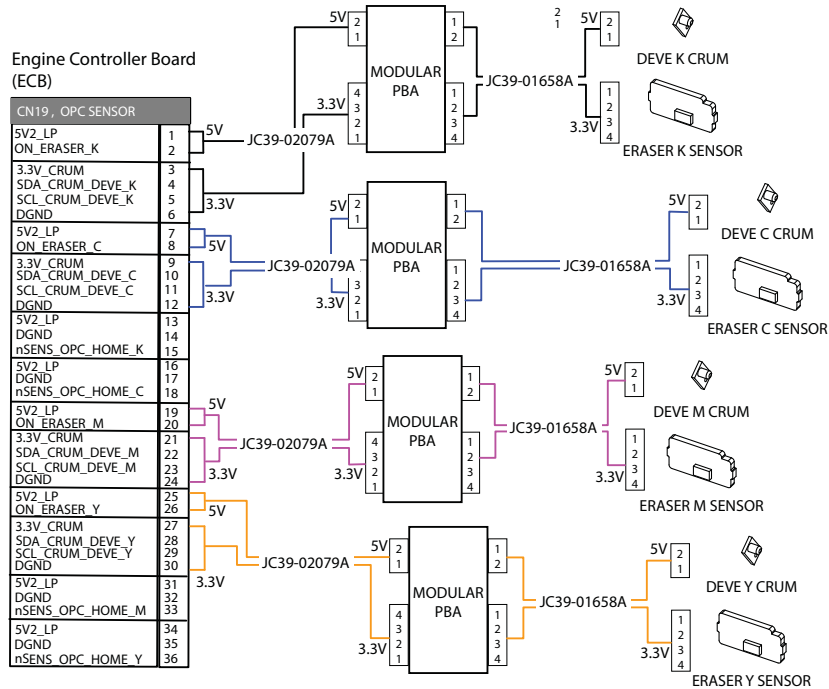
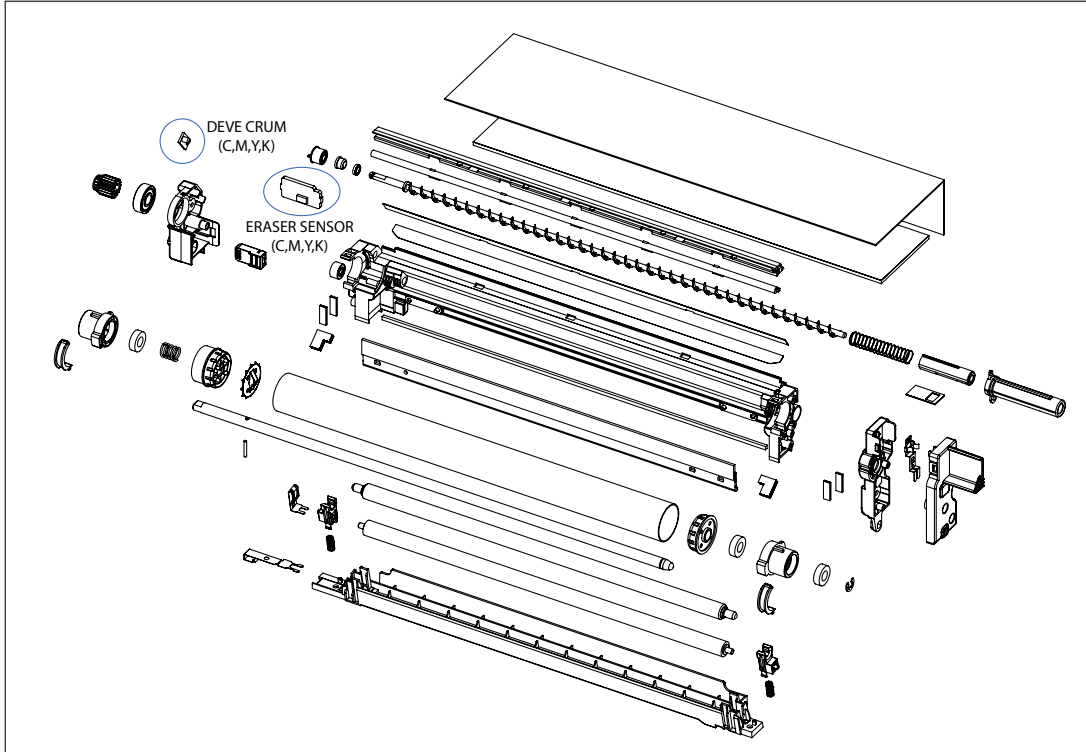




Figure 4-30 Toner crum & eraser sensor



## Optional dual-cassette feeder (DCF)

Learn about the electrical-mechanical relationships diagram for the optional dual-cassette feeder (DCF).

Figure 4-31 Pickup motor 1/2, feed motor, paper size sensor 1/2 and cover open sensor (DCF)

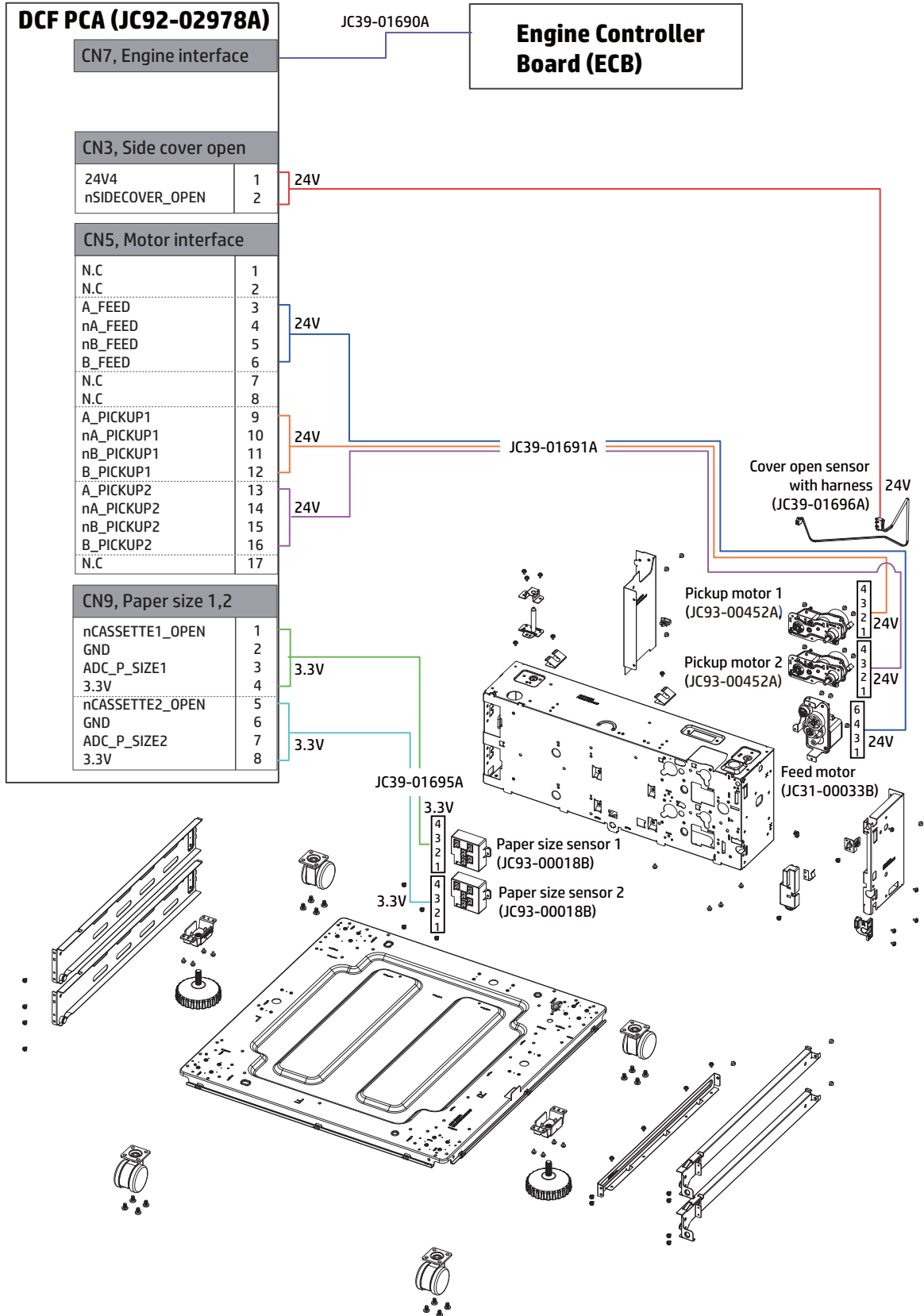


Figure 4-32 Feed sensor 1, empty sensor 1, and lift sensor 1 for Tray 4 (DCF)

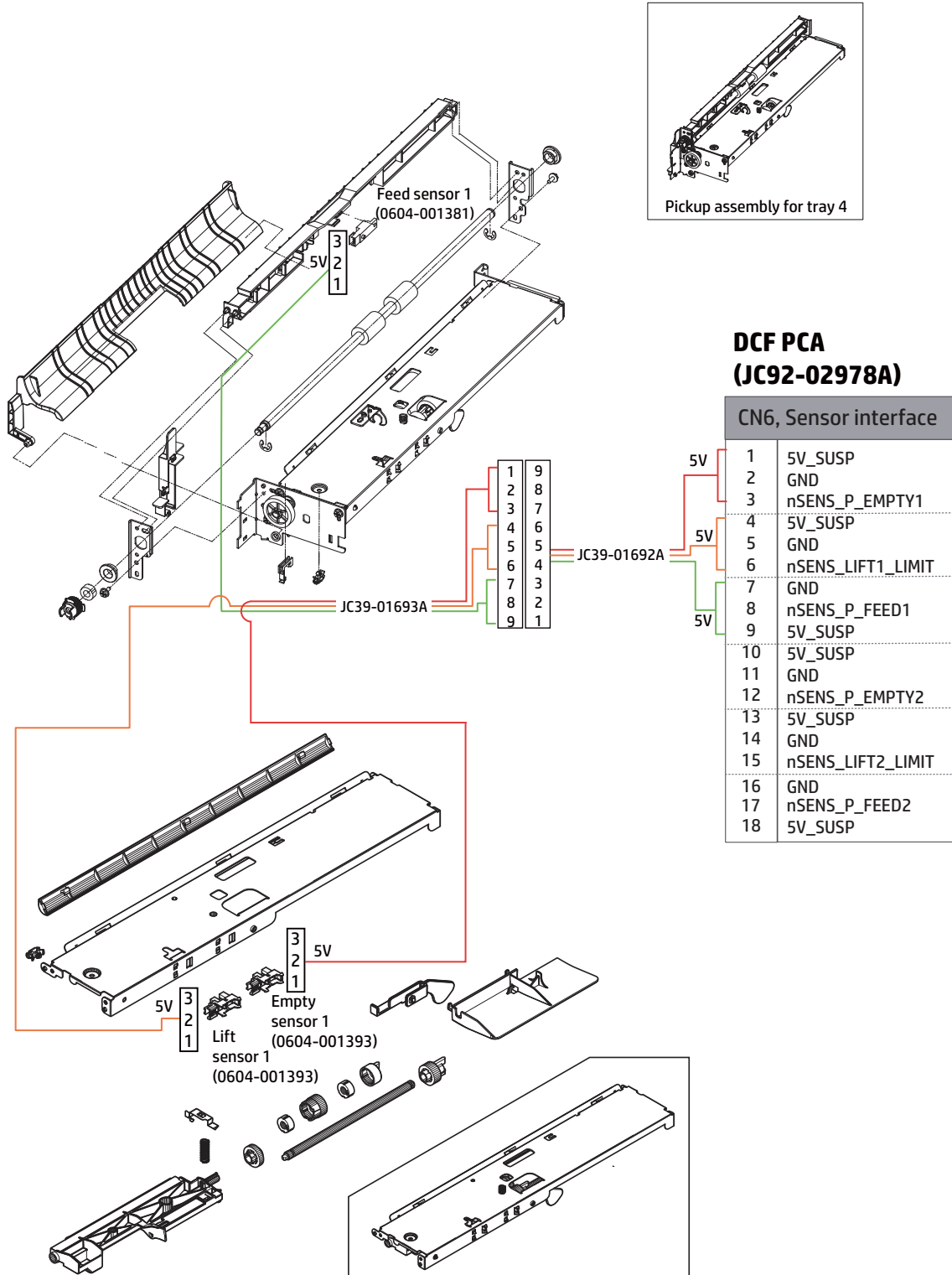
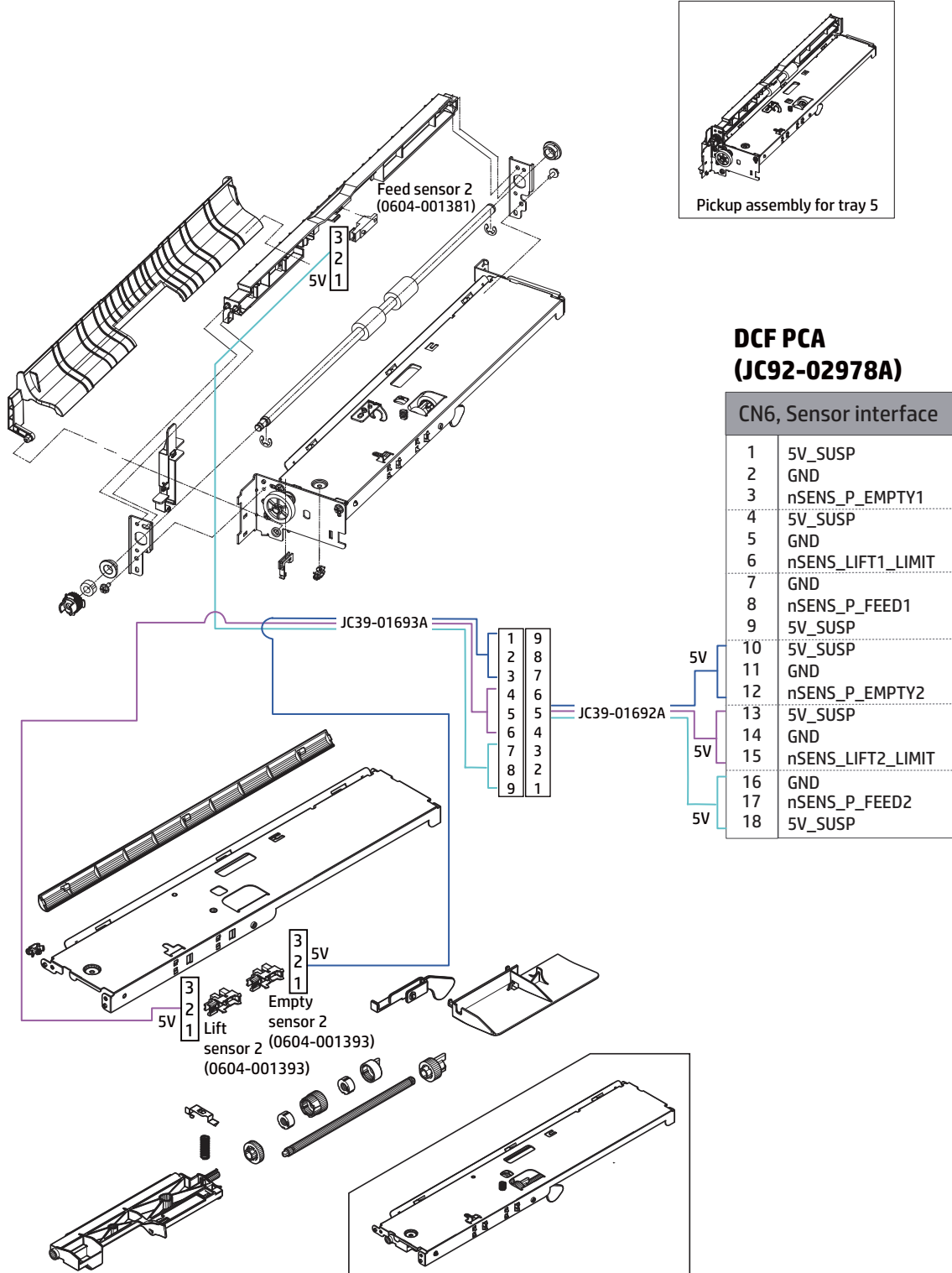


Figure 4-33 Feed sensor 2, empty sensor 2, and lift sensor 2 for Tray 5 (DCF)



## Optional high-capacity input (HCI)

Learn about the electrical-mechanical relationships diagram for the optional high-capacity input (HCI).

Figure 4-34 Pickup, feed and lift motors, cover and cassette sensors (HCI)

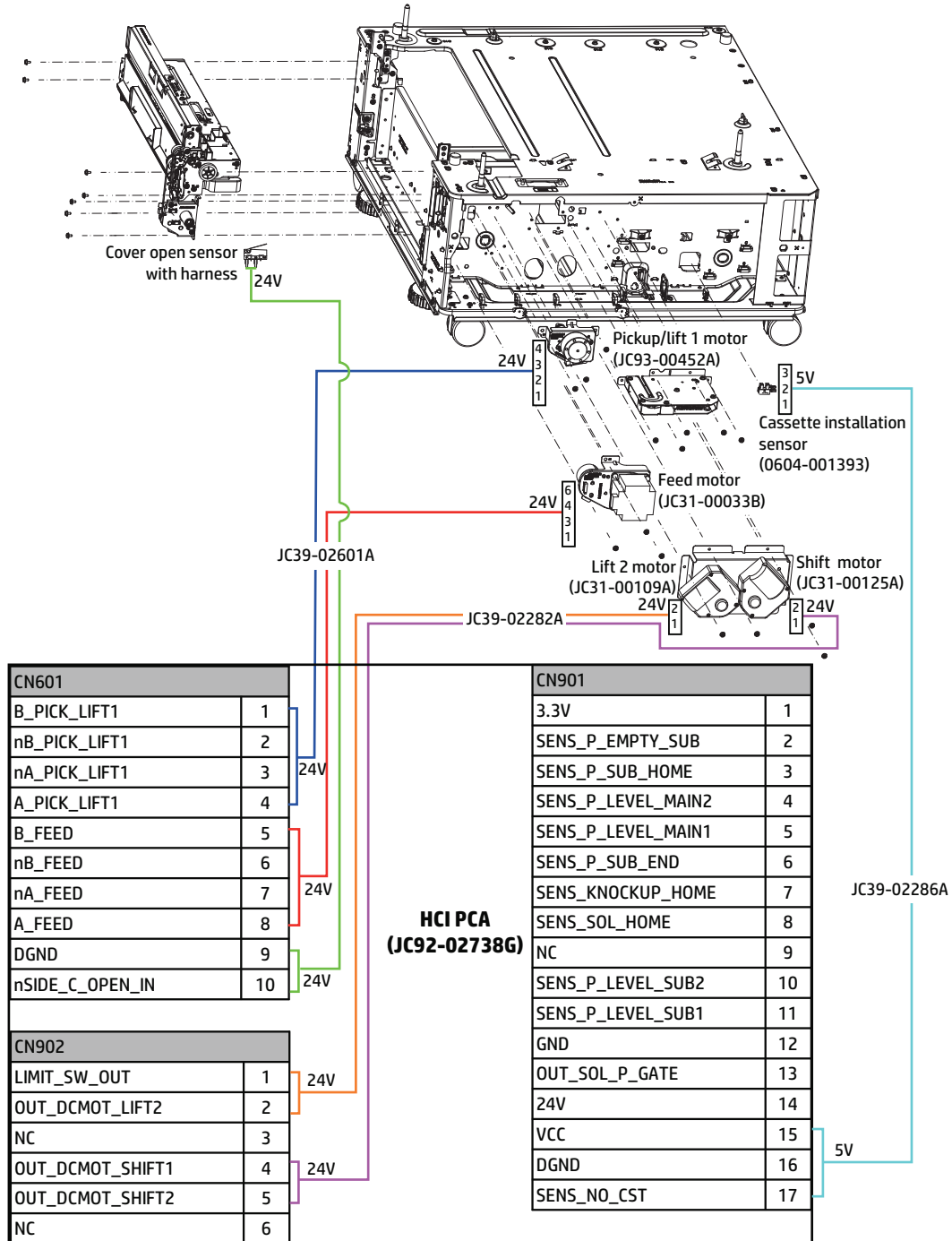


Figure 4-35 PCA, sub PCA and ECB (HCI)

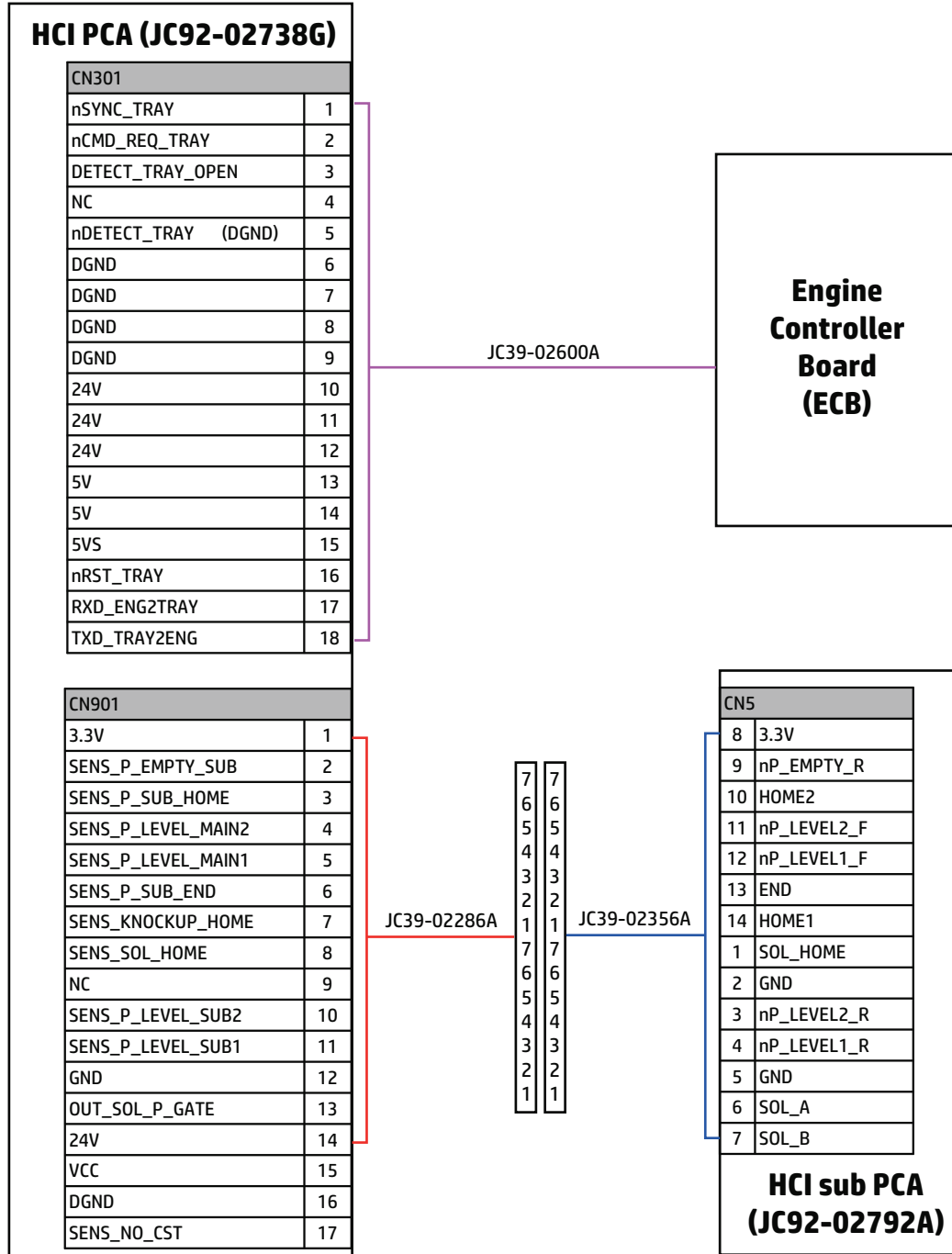


Figure 4-36 Feed, limit, empty and main sensors (HCI)

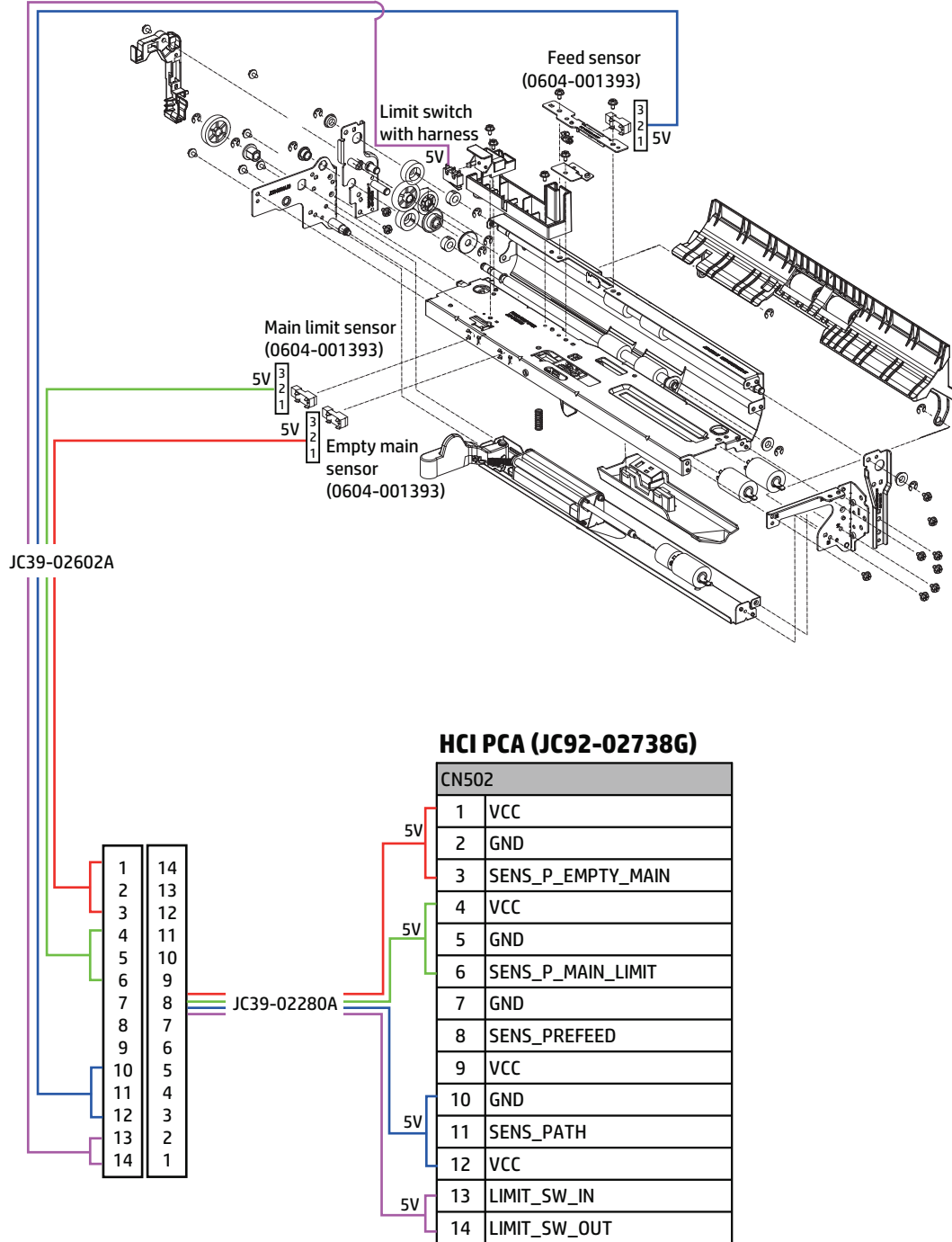


Figure 4-37 Level and home sensors (HCI)

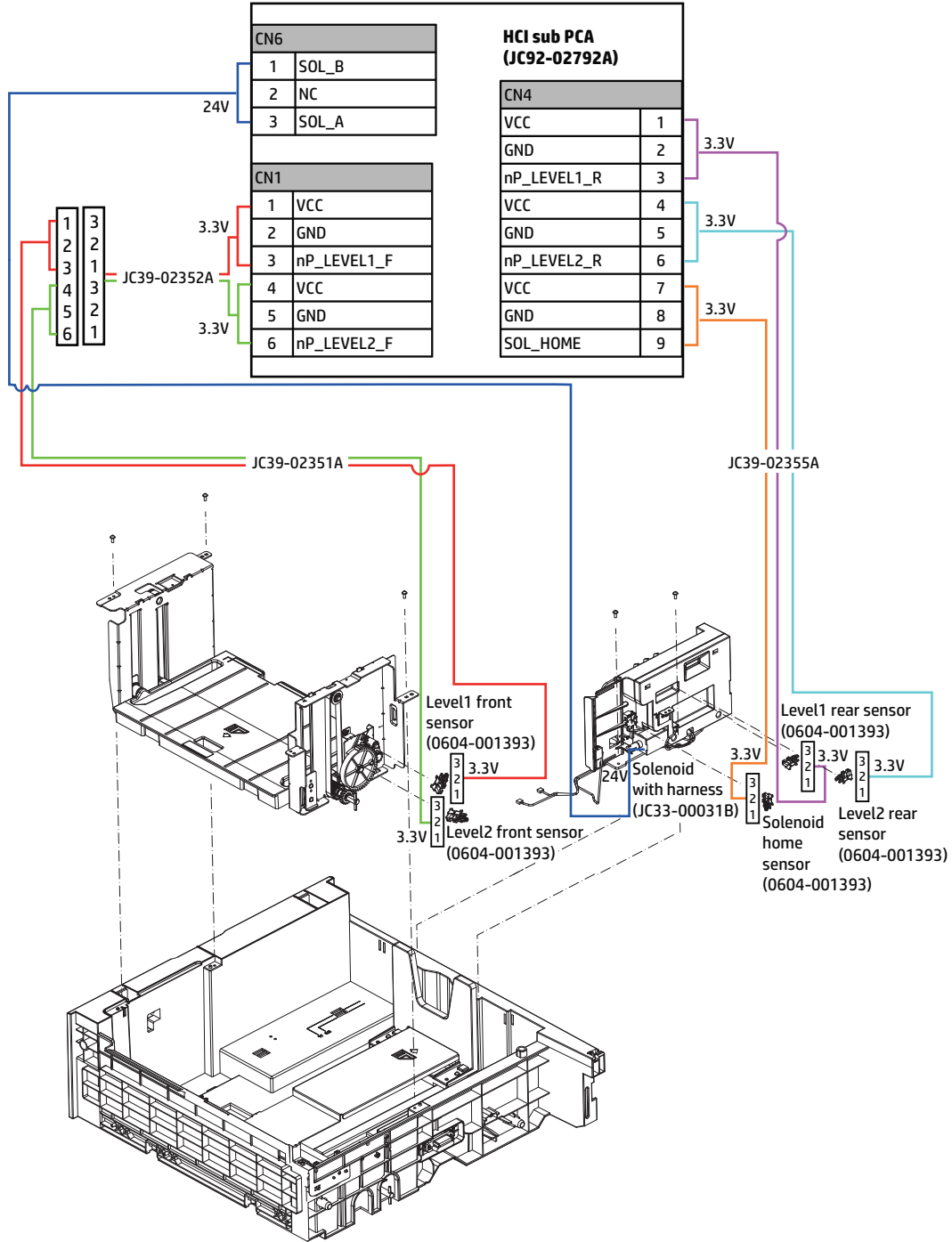
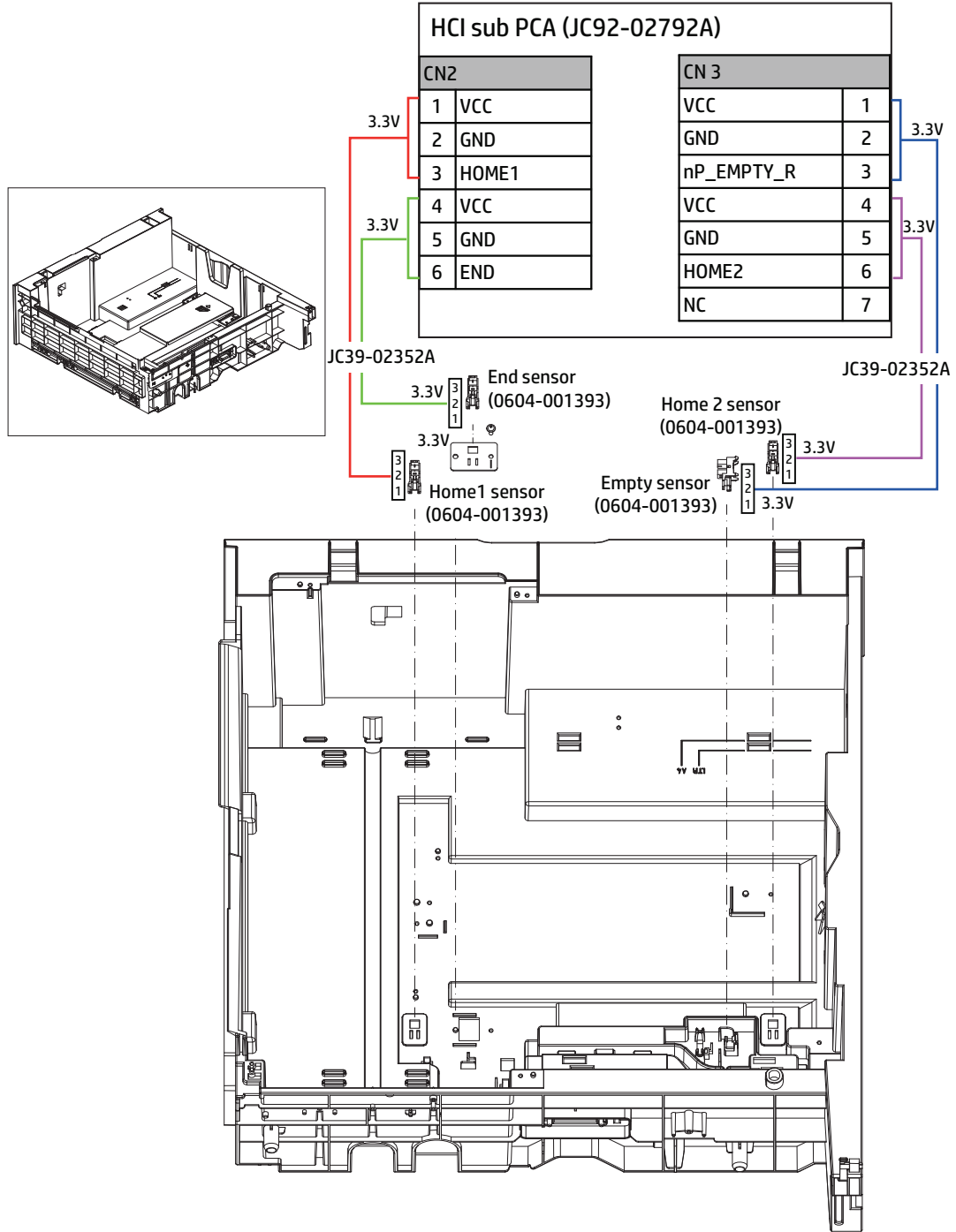




Figure 4-38 Empty and end sensors (HCI)





---

## 5 Stapler/stacker and booklet maker (SSBM)

Learn about the stapler/stacker and booklet maker.

# Product specification and description

Learn about product specifications and descriptions.

## Stapler/stacker finisher and booklet finisher view

Learn about the front view and rear view of the stapler/stacker finisher and booklet finisher.

Figure 5-1 Stapler/stacker finisher - front view

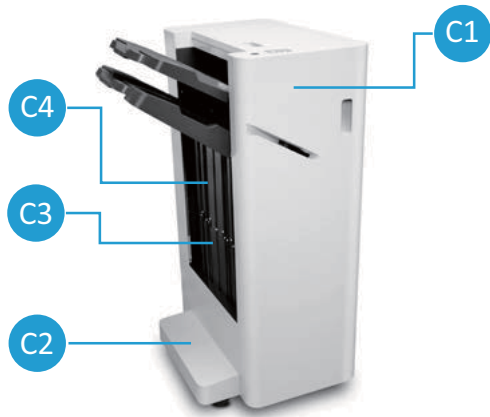


Figure 5-2 Booklet finisher - front view



Table 5-1 Stapler/stacker finisher and booklet finisher - front view

Item	Part name	Part number	Orderable <sup>(*)</sup>
C1	Front door	JC90-01444B	
C2	Caster cover	JC63-04985B	(*)
C3	Left lower cover (Stapler/stacker)	JC63-05001B	(*)
C3'	Left lower cover (Booklet)	JC90-01417B	(*)
C4	Left upper cover	JC90-01475B	(*)
C5	Booklet output tray	JC61-07253B, JC63-04978B	(*)

(\*) This part is in ordering system.

**Figure 5-3** Stapler/stacker finisher and booklet finisher - rear view



**Table 5-2** Stapler/stacker finisher and booklet finisher - rear view

Item	Part name	Part number	Orderable <sup>(*)</sup>
C6	Top Output tray	JC63-04996B	
		JC63-05003B	(*)
C7	Main output tray	JC63-05002B	
C8	Rear cover	JC63-04988B	(*)

<sup>(\*)</sup> This part is in ordering system.

**Figure 5-4** Stapler/stacker finisher and booklet finisher - top view



**Table 5-3** Stapler/stacker finisher and booklet finisher - top view

Item	Part name	Part number	Orderable <sup>(*)</sup>
C9	Top cover	JC90-01446B	
C10	Top door	JC90-01445B	(*)

<sup>(\*)</sup> This part is in ordering system.

Figure 5-5 Booklet finisher – front-right view

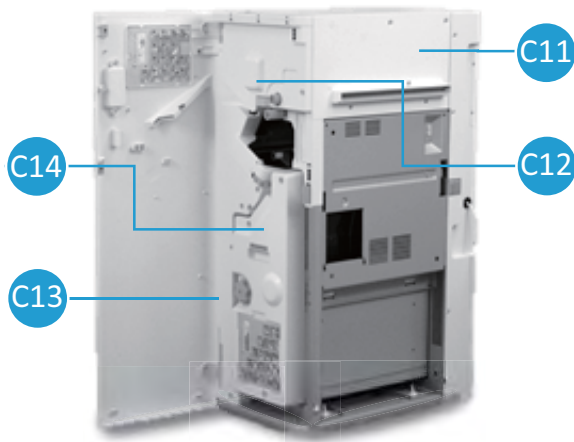


Table 5-4 booklet finisher - front-right view

Item	Part name	Part number	Orderable <sup>(*)</sup>
C11	Right upper cover	JC90-01448B	(*)
C12	Front cover	JC63-04986B	
C13	Front lower cover	JC63-04987B	
C14	Booklet front cover	JC90-01478B	

(\*) This part is in ordering system.

## Specification

Learn about the specifications of the stapler/stacker finisher and booklet finisher.

### Finisher

Table 5-5 Finisher specifications

Item		Stapler/stacker Finisher	Booklet Finisher
Speed	PPM	18.3~70,(90ppm)	18.3~70,(90ppm)
Stack Capacity (A4/ Letter 80gsm)	Main	3,000 sheets	2,000 sheets
	Top	250 sheets	250 sheets
Paper Size	Main	98mm - 320mm x 139.7mm - 457.2mm (3.86in - 12.59in x 5.5in - 18in)	Statement SEF ~ 320 x 457
	Top	98mm - 320mm x 148.0mm - 430.0mm (3.86in - 12.59in x 5.83in - 16.93in)	98 x 148 ~ 13" x 19.2" (330x1200)
Paper Weight	Main	52 ~ 350 gsm	52 ~ 350 gsm
	Top	52 ~ 300 gsm	52 ~ 300 gsm

**Table 5-5 Finisher specifications (continued)**

Item		Stapler/stacker Finisher	Booklet Finisher
Offset (Non Staple) ※Exception SRA3 and larger size.		15mm(minimum)	15mm(minimum)
Staple	Clinching position	<ul style="list-style-type: none"> <li>• Front/Rear Corner(45°,Flat)</li> <li>• Dual</li> </ul>	<ul style="list-style-type: none"> <li>• Front/Rear Corner(45°,Flat)</li> <li>• Dual</li> </ul>
	Paper weight	52~256 gsm	52~256 gsm
	Capacity	65 sheets (90gsm)	65 sheets (90gsm)
	Cartridge Capacity	5,000 clinching/cartridge	5,000 clinching/cartridge
	Offline	Yes	Yes
Hole Punch	Paper weight	52 ~ 300 gsm	52 ~ 300 gsm
	available unit (Auto change)	NA2/3, EU2/4, Swedish	NA2/3, EU2/4, Swedish

## Booklet

**Table 5-6 Booklet maker Specification**

Item		Description
Set Speed	PPM	18.3~70(90ppm)
Paper size		B5 SEF ~ 12" x 18"
Paper weight		60 ~ 120 gsm
Staple + Fold Capacity(80gsm)		25 sheets
Fold Capacity(80gsm)		5 sheets
Tray Capacity		5 sets / 25 sheets
Staple Cartridge Capacity		5,000 clinching/cartridge
C - Folding		3 sheets Letter SEF, A4 SEF

## Physical

**Table 5-7 Physical**

Module	Option (Reference)	Size W X D X H [mm]	Module Weight [Kg]	Packed Weight [Kg]
Stapler/stacker Finisher		751.7 x 610 x 1016.4	40	62
Booklet Finisher		751.7 x 610 x 1016.4	62	84.5
	Hole Punch	80 x 485 x 235	2.8	4.1

## Paper size

Table 5-8 Paper size specification

Name	Paper size		Orientation	Output			Staple position			Punch				Booklet Maker	C-Folding		
	mm	Inches		direction	Main tray		Top tray	Corner		DUAL	NA 2/3		EU 2/4H			Swedish 4H	
					52-350g	Offset	52-300g	45°	Flat		2H	3H	2H				4H
A5	210 X148	8.3X5.8	LEF	X	X	X		F/R	X	X		X	X				
Statement	216 X140	8.5X5.5	LEF	X	X	X		F/R	X	X		X	X				
Letter	279 X216	11X8.5	LEF	X	X	X		F/R	X	X	X	X	X	X			
A4	297 X210	8.3X11.7	LEF	X	X	X		F/R	X	X	X	X	X	X			
B5(JIS)	257 X182	10.1×7.2	LEF	X	X	X		F/R	X	X	X	X	X	X			
B5(ISO)	250 X176	9.8×6.9	LEF	X	X	X		F/R	X	X	X	X	X	X			
Executive	267 X184	10.5X7.3	LEF	X	X	X		F/R	X	X	X	X	X	X			
No 9 Env	98X225	3.9X8.9	SEF			X											
Monarch Env	98.4×190.5	3.9×7.5	SEF			X											
PostCard 4x6	101.6×152.4	4.0×6.0	SEF			X											
A6	105 X148	4.1X5.8	SEF			X											
No 10 Env	105×241	4.1×9.5	SEF			X											
DL Env	110×220	4.3×8.7	SEF			X											



Table 5-8 Paper size specification (continued)

Name	Paper size		Orientation	Output			Staple position			Punch				Booklet Maker	C-Folding		
	mm	Inches		direction	Main tray		Top tray	Corner		DUAL	NA 2/3		EU 2/4H			Swedish 4H	
					52-350g	Offset	52-300g	45°	Flat		2H	3H	2H				4H
C6 Env	114 × 162	4.5 × 6.4	SEF			X											
B6	128 × 182	5.0 × 7.2	SEF			X											
Statement	140 × 216	5.5 × 8.5	SEF	X		X						X	X				
A5	148 × 210	5.8 × 8.3	SEF	X		X						X	X				
C5 Env	162 × 229	6.4 × 9.0	SEF			X											
B5(ISO)	176 × 250	6.9 × 9.8	SEF	X	X	X		F/R		X	X	X					
B5(JIS)	182 × 257	7.2 × 10.1	SEF	X	X	X		F/R		X	X	X	X				
Executive	184 × 267	7.3 × 10.5	SEF	X	X	X		F/R		X	X	X	X	X			
16k	195 × 270	7.7 × 10.6	SEF	X	X	X		F/R	X	X	X	X	X	X			
A4	210 × 297	8.3 × 11.7	SEF	X	X	X		F/R	X	X	X	X	X	X	X		
Legal	216 × 356	8.5 × 14	SEF	X	X	X		F/R	X	X	X	X	X	X			
Letter	216 × 279	8.5 × 11	SEF	X	X	X		F/R	X	X	X	X	X	X	X		
Folio	216 × 330	8.5 × 13	SEF	X	X	X		F/R	X	X	X	X	X	X			

Table 5-8 Paper size specification (continued)

Name	Paper size		Orientation	Output			Staple position			Punch					Booklet Maker	C-Folding	
	mm	Inches		direction	Main tray		Top tray	Corner		DUAL	NA 2/3		EU 2/4H				Swedish 4H
					52-350g	Offset	52-300g	45°	Flat		2H	3H	2H	4H			
Oficio	215.9×342.9	8.5×13.5	SEF	X	X	X		F/R	X	X		X		X	X		
C4 Env	229×324	9.1X12.8	SEF			X											
Tabloid	254X374	10X14.7	SEF	X	X	X		F/R		X	X	X	X		X	X	
B4	257X364	10X14.3	SEF	X	X	X		F/R		X	X	X	X	X	X	X	
8K	270X390	10.6X15.4	SEF	X	X	X		F/R		X	X	X	X	X	X	X	
Ledger	279X432	11X17	SEF	X	X	X		F/R		X	X	X	X	X	X	X	
A3	297X420	11.7X16.5	SEF	X	X	X		F/R		X	X	X	X	X	X	X	
Tabloid Extra	304.8×457.2	12×18	SEF	X		X									X		
SRA3	320×450	12.6×17.7	SEF	X		X											
13"×19.2"	330×487	13x19.2	SEF			X											
Custom	W9 8-320 L13 9.7-457.2	W3.86-12.59 L5.5-18	-	X	NA	O		NA	NA	NA	NA	NA	NA	NA	NA	NA	

\* F/R means Front side and Rear side can be supported.

## Media performance

**Table 5-9 Media performance**

Paper Type	Function						
	Main Tray	Top Tray	Staple	HP	BM		
					Cover	Content	C-Fold
Plain (71-90 g/m <sup>2</sup> )	X	X	X	X	X	X	X
Thick (91-105 g/m <sup>2</sup> )	X	X	X	X	X		
Heavy weight (106-175 g/m <sup>2</sup> )	X	X	X	X	X		
Extra Heavy weight 1 (176-216 g/m <sup>2</sup> )	X	X	X	X	X		
Extra Heavy weight 2 (217-256 g/m <sup>2</sup> )	X	X	X	X	X		
Extra Heavy weight 3 (257-300 g/m <sup>2</sup> )	X	X		X	X		
Extra Heavy weight 4 (301-325 g/m <sup>2</sup> )	X						
Thin (60-70 g/m <sup>2</sup> )	X	X	X	X	X	X	X
Cotton (75-90 g/m <sup>2</sup> )	X	X					
Colored (75-90 g/m <sup>2</sup> )	X	X	X	X	X	X	X
Pre-Printed (75-90 g/m <sup>2</sup> )	X	X	X	X	X	X	X
Recycled (60-90 g/m <sup>2</sup> )	X	X	X	X	X	X	X
Bond	X	X	X	X	X	X	
Archive (75-105 g/m <sup>2</sup> )	X	X	X	X	X	X	
Letter Head	X	X	X	X	X	X	
Pre-Punched	X	X	X				
Thin Cardstock (105-163 g/m <sup>2</sup> )	X	X	X	X			
Thick Cardstock (170-216 g/m <sup>2</sup> )	X	X	X				
Heavy Cardstock (217-256 g/m <sup>2</sup> )	X	X	X				
Extra Heavy Cardstock 1(257-300 g/m <sup>2</sup> )	X	X					
Extra Heavy Cardstock 2(301-325 g/m <sup>2</sup> )	X						
Thin Glossy (106-169 g/m <sup>2</sup> )	X	X	X	X	X		
Thick Glossy (170-216 g/m <sup>2</sup> )	X	X	X		X		
Heavy Glossy (217-256 g/m <sup>2</sup> )	X	X	X		X		
Envelope (75-90 g/m <sup>2</sup> )		X					
Thick Envelope (217-256 g/m <sup>2</sup> )		X					
Transparency (138~146 gsm)	X	X		X			

**Table 5-9** Media performance (continued)

Paper Type	Function						
	Main Tray	Top Tray	Staple	HP	BM		
					Cover	Content	C-Fold
Labels (120~150 gsm)		X					
Tab	X	X		X			

# Stapler/stacker finisher and booklet finisher system

Learn about the Stapler/stacker finisher and booklet finisher system.

## Overview

Learn about the overview of the Stapler/stacker finisher and booklet finisher.

## Work flow

Stapler/stacker finisher and booklet finisher work flow

Figure 5-6 Work flow overview

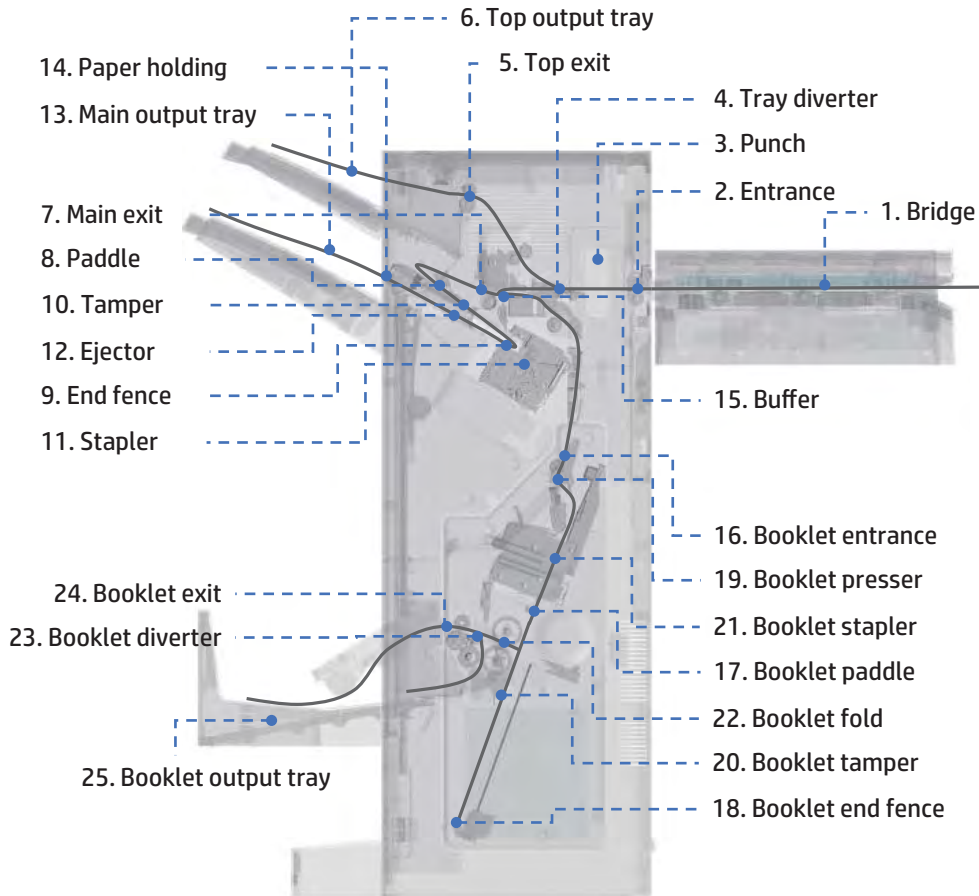


Table 5-10 work flow overview

Item	Unit	Description
1	Bridge unit	Moves paper from the printer to the finisher.
2	Entrance unit	Allows paper to move into the finisher.
3	Punch unit(optional)	Holes in a specific location on paper sheet.
4	Tray diverter unit	Changes the paper direction whether it is main output tray or top output tray.
5	Top exit unit	Moves paper from the diverter to the top output tray.
6	Top output tray unit	Stacks paper that completed its printing job.

**Table 5-10 work flow overview (continued)**

Item	Unit	Description
7	Main exit unit	Moves paper from the diverter unit to the ejector unit with forward direction or to the buffer unit with backward direction.
8	Paddle unit	Pushes to the end fence to be aligned towards top and bottom of the paper.
9	End fence unit	Sets the standard position of the paper to be aligned towards top and bottom of the paper.
10	Tamper unit	Aligns the paper on the right and left side of the paper.
11	Stapler unit	Staples a bundle of an aligned documents.
12	Ejector unit	Transfers a stapled paper loaded at the end fence unit to the output tray.
13	Main output tray unit	Stacks paper that completed its printing job.
14	Paper holding unit	Keeps paper static and controls the output tray movement.
15	Buffer unit	Maintains paper inside the unit for a while or moves it to the booklet maker.
16	Booklet entrance unit	Receives the paper into the booklet maker.
17	Booklet paddle unit	Pushes to the booklet end fence.
18	Booklet end fence unit	Supports paper that enters from the booklet paddle unit, then moves paper to the designated position for folding and stapling.
19	Booklet presser unit	Presses paper that enters to the booklet tamper unit to prevent paper shuffled.
20	Booklet tamper unit	Aligns the paper on the right and left side of the paper to make booklet.
21	Booklet stapler unit	Staples a bundle of aligned documents to make a booklet.
22	Booklet fold unit	Fold a bundle of aligned documents as a booklet.
23	Booklet diverter unit	Changes the paper direction to the booklet exit unit or the location to make c-fold.
24	Booklet exit unit	Moves paper to the booklet output tray.
25	Booklet output tray unit	Stacks the bundle of booklet.

Figure 5-7 Sensor – Stapler/stacker finisher and booklet finisher\_1

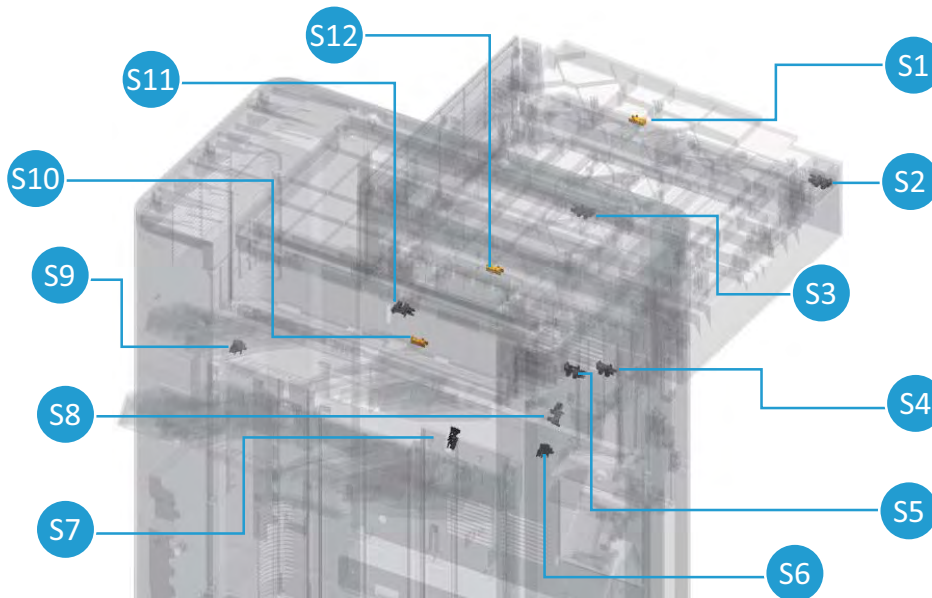


Table 5-11 Sensor – Stapler/stacker finisher and booklet finisher\_1

No	Name	Part number	Orderable <sup>(*)</sup>	Diagnostics	Type	Description
S1	Bridge entrance sensor	JC32-00020A	(*)	113-2070	Paper sensor	Checks whether paper comes into the bridge entrance unit.
S2	Bridge door sensor	0604-001393	(*)	113-2180	Photo interrupter	Checks whether the bridge door is opened.
S3	Bridge exit sensor	0604-001393	(*)	113-2071	Photo interrupter	Checks whether paper comes into the bridge exit unit.
S4	Tray diverter home sensor	0604-001415	(*)	113-2020	Photo interrupter	Checks whether the tray diverter locates at the home position.
S5	Main exit cam home sensor	0604-001393	(*)	113-2000	Photo interrupter	Check whether the main exit CAM locates at the home position.
S6	Front tamper home sensor	0604-001393	(*)	113-2120	Photo interrupter	Checks whether the front tamper locates at the home position.
S7	End fence home sensor	0604-001393	(*)	113-2050	Photo interrupter	Checks whether the end fence locates at the home position.
S8	Paddle home sensor	0604-001393	(*)	113-2060	Photo interrupter	Checks whether the paddle locates at the home position.
S9	Rear tamper home sensor	0604-001393	(*)	113-2130	Photo interrupter	Checks whether the rear tamper locates at the home position.
S10	Main exit sensor	JC32-00020A	(*)	113-2090	Paper sensor	Checks whether paper comes into the main exit unit.
S11	Top exit sensor	0604-001393	(*)	113-2091	Photo interrupter	Checks whether paper comes into the top exit unit.
S12	Entrance sensor	JC32-00020A	(*)	113-2080	Paper sensor	Checks whether paper comes into the entrance unit.

(\*) This part is in ordering system.

Figure 5-8 Sensor – Stapler/stacker finisher and booklet finisher\_2

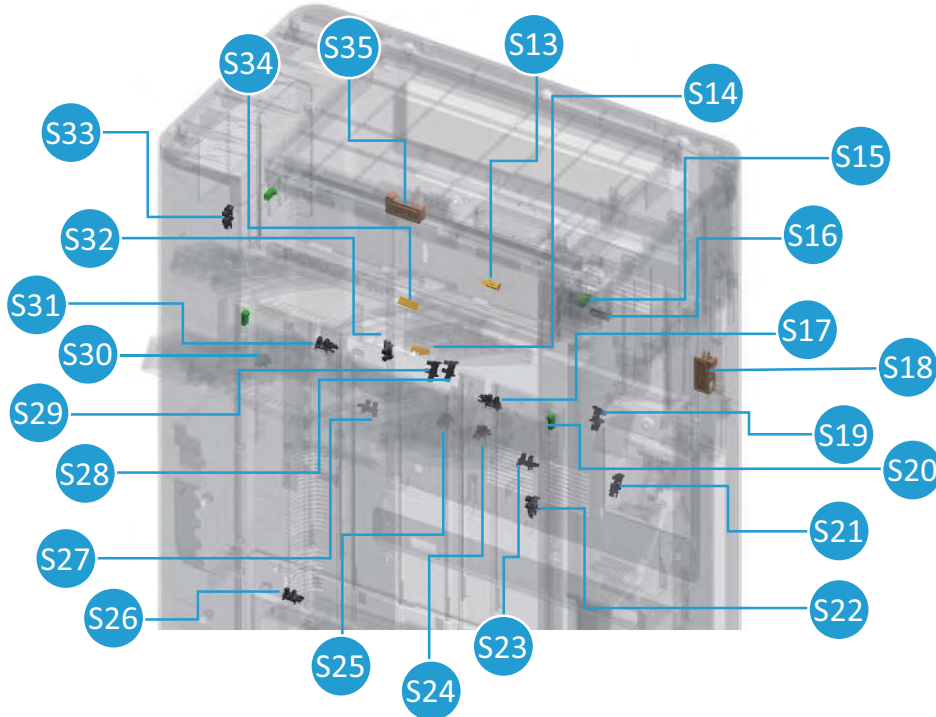


Table 5-12 Sensor – Stapler/stacker finisher and booklet finisher\_2

No	Name	Part number	Orderable <sup>(*)</sup>	Diagnostics	Type	Description
S13	Buffer sensor	JC32-00020A	(*)	113-2100	Paper sensor	Checks whether paper exits out of the buffer unit
S14	Ejector sensor	JC32-00020A	(*)	113-2170	Paper sensor	Checks whether paper is on the ejector or not.
S15	Top output tray paper full sensor	JC82-01039A	(*)	113-2145	LED IR, Photo TR	Checks whether the top output tray is full or not.
S16	Buffer home sensor	0604-001393	(*)	113-2210	Photo interrupter	Checks whether the buffer roller and the idle roller whether attached or detached.
S17	Front Paper holding sensor	0604-001393	(*)	113-2141	Photo interrupter	Checks whether the location of the paper holding actuator for controlling the position of the main output tray.
S18	Front door switch	JC39-02309A		113-2182	Switch	Check whether the front door is open.
S19	Manual staple sensor	0604-001415	(*)	113-2160	Photo interrupter	Check whether the paper comes into the manual staple position.
S20	Main output tray top of stack sensor	JC82-01039A	(*)	113-2140	LED IR, Photo TR	Check whether the main output tray reaches the top of stack.
S21	Stapler front sensor	0604-001393	(*)	113-2113	Photo interrupter	Makes the stapler positioned in accordance with the manual stapling position.
S22	Paper holding home sensor	0604-001393	(*)	113-2010	Photo interrupter	Checks whether the paper holding actuator locates at the home position.



**Table 5-12 Sensor – Stapler/stacker finisher and booklet finisher\_2 (continued)**

No	Name	Part number	Orderable <sup>(*)</sup>	Diagnostics	Type	Description
S23	Ejector2 motor sensor	0604-001415	(*)	113-2041	Photo interrupter	Checks whether the ejector2 motor is operational.
S24	Stapler mid front sensor	0604-001393	(*)	113-2112	Photo interrupter	Make the stapler positioned at the exact stapling position.
S25	Stapler mid rear sensor	0604-001393	(*)	113-2111	Photo interrupter	Make the stapler positioned at the exact stapling position.
S26	Main output tray lower limit sensor	0604-001415	(*)	113-2144	Photo interrupter	Checks whether the lower limit of the output tray (=output tray is full).
S27	Ejector1 motor sensor	0604-001415	(*)	113-2032	Photo interrupter	Checks whether the ejector1 motor is operational.
S28	Ejector1 end sensor	0604-001415	(*)	113-2030	Photo interrupter	Checks whether the ejector1 locates at the end position.
S29	Ejector1 home sensor	0604-001415	(*)	113-2031	Photo interrupter	Checks whether the ejector1 locates at the home position.
S30	Stapler rear sensor	0604-001393	(*)	113-2110	Photo interrupter	Checks whether the stapler locates at the home(rear) position.
S31	Rear paper holding sensor	0604-001393	(*)	113-2142	Photo interrupter	Checks whether the location of the paper holding actuator for controlling the position of the main output tray.
S32	Ejector2 home sensor	0604-001415	(*)	113-2040	Photo interrupter	Checks whether the ejector2 locates at the home position.
S33	Main output tray motor sensor	0604-001393	(*)	113-2143	Photo interrupter	Checks whether the Main output tray motor is operational.
S34	Main output tray top of stack switch	JC39-02316A		113-2190	Switch	Checks whether the main output tray reaches at the top of stack.
S35	Top door switch	JC39-02310A		113-2181	Switch	Checks whether the top door is open.

(\*) This part is in ordering system.

Figure 5-9 Sensor – Booklet finisher

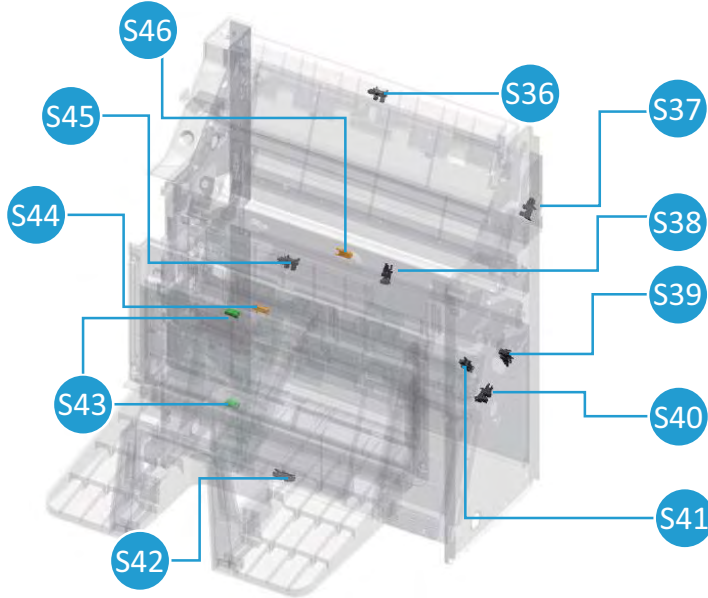
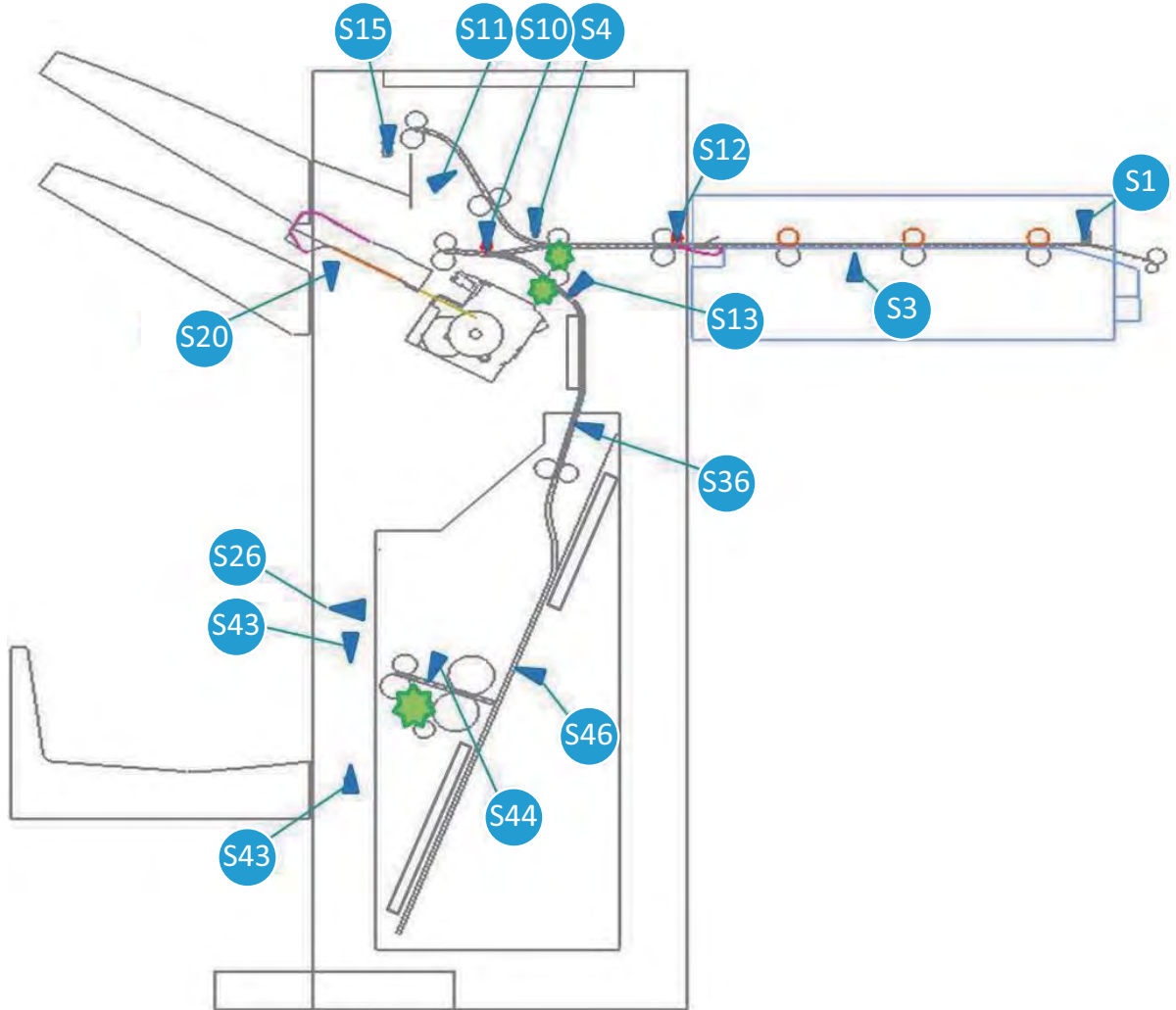


Table 5-13 Sensor – Booklet finisher

No	Name	Part number	Orderable <sup>(*)</sup>	Diagnostics	Type	Description
S36	Booklet entrance sensor	0604-001415	(*)	113-3100	Photo interrupter	Checks whether paper comes into the bridge entrance unit.
S37	Booklet presser home sensor	0604-001393	(*)	113-3130	Photo interrupter	Checks whether the booklet presser locates at the home position.
S38	Booklet tamper home sensor	0604-001393	(*)	113-3080	Photo interrupter	Checks whether the booklet tamper locates at the home position.
S39	Booklet c-fold blade home sensor	0604-001393	(*)	113-3050	Photo interrupter	Checks whether the booklet c-fold blade locates at the home position.
S40	Booklet diverter home sensor	0604-001415	(*)	113-3060	Photo interrupter	Checks whether the booklet diverter locates at the home position.
S41	Booklet paddle home sensor	0604-001393	(*)	113-3090	Photo interrupter	Checks whether the booklet paddle locates at the home position.
S42	Booklet end fence home sensor	0604-001393	(*)	113-3000	Photo interrupter	Checks whether the booklet end fence locates at the home position.
S43	Booklet output tray sensor	JC82-01039A	(*)	113-2150	LED IR, Photo TR	Checks whether paper goes out on the booklet output tray.
S44	Booklet exit sensor	JC32-00020A	(*)	113-3120	Paper sensor	Checks whether paper comes into the booklet exit unit.
S45	Booklet blade home sensor	0604-001393	(*)	113-3040	Photo interrupter	Checks whether the booklet blade locates at the home position.
S46	Booklet tamper sensor	JC32-00020A	(*)	113-3110	Paper sensor	Checks whether paper comes into the booklet tamper unit.

<sup>(\*)</sup> This part is in ordering system.

Figure 5-10 Sensor – Paper path



## Motor and solenoid

Figure 5-11 Motor, solenoid – Stapler/stacker finisher and booklet finisher

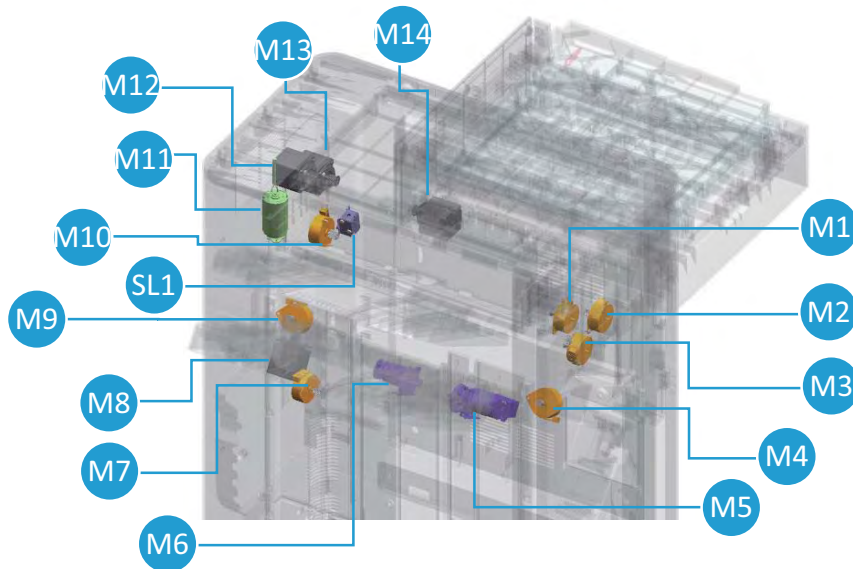


Table 5-14 Motor, solenoid – Stapler/stacker finisher and booklet finisher

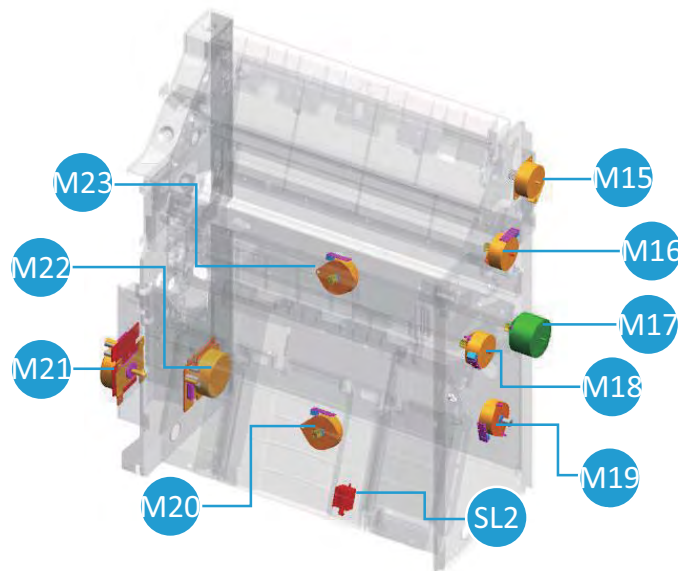
No	Name	Part number	Orderable <sup>(*)</sup>	Diagnostics	Type	Description
M1	Paddle motor	JC93-01001A	(*)	113-3580	Step motor	Rotates the paddle and moves the paddle pusher up and downward at the same time.
M2	Main exit cam motor	JC93-01155A	(*)	113-2500	Step motor	Rotates the main exit cam to detach the exit roller from the exit idle roller.
M3	End fence motor	JC93-01001A	(*)	113-2590	Step motor	Moves front and rear end fence depending on paper size(width) so that paper is well arranged at the end fence.
M4	Front tamper motor	JC93-01001A	(*)	113-2630	Step motor	Moves the front tamper unit.
M5	Ejector2 motor	JC93-01168A		113-2540	DC motor	Moves the ejector2 and grabs paper.
M6	Ejector1 motor	JC93-01168A		113-2530	DC motor	Moves the ejector1 forward and backward
M7	Paper holding motor	JC93-01156A	(*)	113-2510	Step motor	Moves paper holding actuator up when paper goes out to the output tray
M8	Stapler position motor	JC31-00163A	(*)	113-2620	Hybrid Step motor	Moves the stapler.
M9	Rear tamper motor	JC93-01001A	(*)	113-2640	Step motor	Moves the rear tamper unit.
SL1	Buffer Solenoid	JC33-00038A	(*)	113-2670	Solenoid	Holds paper not to fall out to the booklet maker during buffering task.
M10	Buffer motor	JC93-01152A	(*)	113-2660	Step motor	Moves paper to the buffer space or the booklet maker.

**Table 5-14** Motor, solenoid – Stapler/stacker finisher and booklet finisher (continued)

No	Name	Part number	Orderable <sup>(*)</sup>	Diagnostics	Type	Description
M11	Main output tray motor	JC31-00178B	(*)	113-2610	DC motor	Moves the main output tray up and down.
M12	Entrance motor	JC31-00163B	(*)	113-2570	Hybrid Step motor	Operates the entrance roller, middle roller, and top middle roller when driving in the forward and moves the diverter cam when driving in the backward.
M13	Exit motor	JC31-00163B	(*)	113-2580	Hybrid Step motor	Rotates the main exit roller and the top exit roller.
M14	Bridge motor	JC31-00163B	(*)	113-2560	Hybrid Step motor	Rotates the bridge entrance roller, the bridge middle roller and the bridge exit roller.

(\*) This part is in ordering system.

**Figure 5-12** Motor, solenoid – Booklet finisher




**Table 5-15** Motor, solenoid – Booklet finisher

No	Name	Part number	Orderable <sup>(*)</sup>	Diagnostics	Type	Description
M15	Booklet entrance motor	JC93-01152A	(*)	113-3500	Step motor	Rotates the booklet entrance roller.
M16	Booklet presser motor	JC93-01155A	(*)	113-3570	Step motor	Operates the booklet presser.
M17	Booklet C-fold blade motor	JC93-01154A	(*)	113-3590	Step motor	Drives the booklet c-fold blade and the moving guide.
M18	Booklet diverter motor	JC93-01153A	(*)	113-3560	Step motor	Drives the booklet diverter
M19	Booklet paddle motor	JC93-01001A	(*)	113-3580	Step motor	Rotates the booklet paddle.

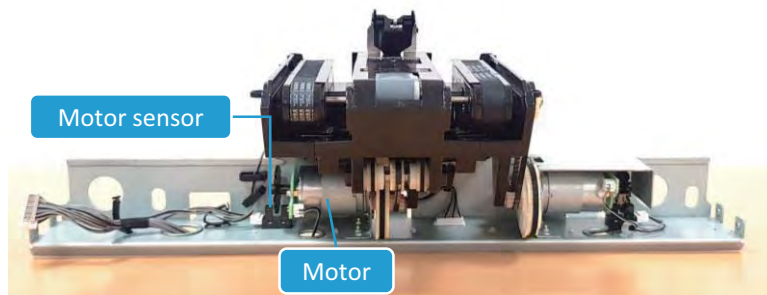
**Table 5-15** Motor, solenoid – Booklet finisher (continued)

No	Name	Part number	Orderable <sup>(*)</sup>	Diagnostics	Type	Description
M20	Booklet end fence motor	JC93-01155A	(*)	113-3530	Step motor	Moves the booklet end fence up and down.
M21	Booklet Fold motor	JC31-00144A	(*)	113-3510	BLDC motor	Rotates the booklet fold roller, the booklet c-fold roller, and the booklet exit roller.
M22	Booklet blade motor	JC31-00144A	(*)	113-3550	BLDC motor	Drives the booklet blade.
M23	Booklet tamper motor	JC93-01155A	(*)	113-3540	Step motor	Moves the booklet tamper unit.
SL2	Booklet end fence solenoid	JC33-00038A	(*)	113-3520	Solenoid	Operates the gripper of the booklet end fence to grip paper that comes in the booklet end fence.

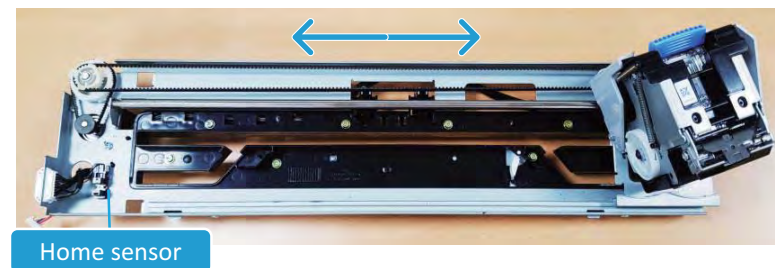
(\*) This part is in ordering system.

 **NOTE:** The motor sensor which is mounted near the driving motor detects whether the motor is operating or not. If a motor doesn't work properly, an event code only for the motor will occur. On the other hand, the home position sensor is installed for the purpose of checking the reference position or location when the specific unit is operating.

**Figure 5-13** Motor sensor in the ejector unit



**Figure 5-14** Home sensor in the stapler unit



## Roller

Figure 5-15 Roller - Stapler/stacker finisher and booklet finisher

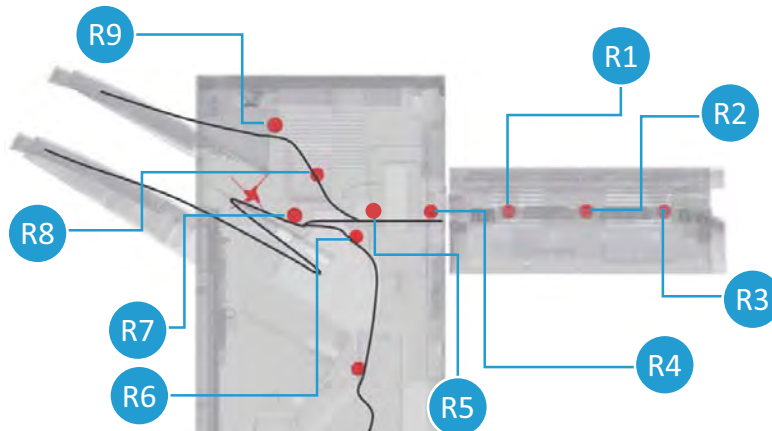


Table 5-16 Roller - Stapler/stacker finisher

No	Name	Part number	Orderable <sup>(*)</sup>	Drive motor	Description
R1	Bridge exit roller	JC66-04732A	(*)	Bridge motor	Moves paper from the machine to the bridge unit.
R2	Bridge middle roller	JC66-04732A	(*)	Bridge motor	Moves paper from the machine to the bridge unit.
R3	Bridge entrance roller	JC66-04733A	(*)	Bridge motor	Moves paper from the machine to the bridge unit
R4	Entrance roller	JC66-04722A	(*)	Entrance motor	Moves paper from the entrance unit to the exit unit
R5	Middle roller	JC66-04724A	(*)	Entrance motor	Moves paper from the entrance unit to the exit unit
R6	Buffer roller	JC66-05161A		Buffer motor	Moves paper to the booklet maker, and makes the gap between the buffer roller and the idle roller so that paper stays for the buffering.
R7	Main exit roller	JC66-04726A	(*)	Exit motor Main exit cam motor	Moves paper to the ejector unit or the buffer unit and makes the gap between the main exit roller and the idle roller so that paper stays for the buffering.
R8	Top middle roller	JC66-04725A	(*)	Entrance motor	Moves paper to the top output tray.
R9	Top exit roller	JC66-04727A	(*)	Exit motor	Moves paper to the top output tray.

(\*) This part is in ordering system.

Figure 5-16 Roller – Booklet finisher

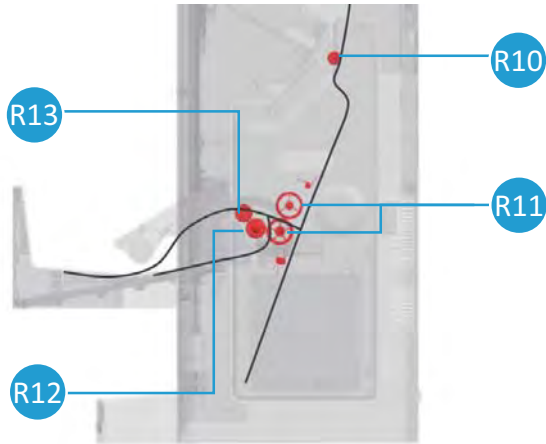


Table 5-17 Roller – Booklet finisher

No	Name	Part number	Orderable <sup>(*)</sup>	Drive motor	Description
R10	Booklet entrance roller	JC66-04717A		Booklet entrance motor	Moves paper from the machine to the bridge unit.
R11	Booklet fold roller	JC66-04748A		Booklet fold motor	Presses a stack of paper to fold completely.
R12	Booklet c-fold roller	JC66-04744A	(*)	Booklet fold motor	In case of c-fold, presses a stack of paper to fold completely.
R13	Booklet exit roller	JC66-04721A	(*)	Booklet fold motor	Moves paper to the booklet output tray unit

<sup>(\*)</sup> This part is in ordering system.



Figure 5-17 PCA

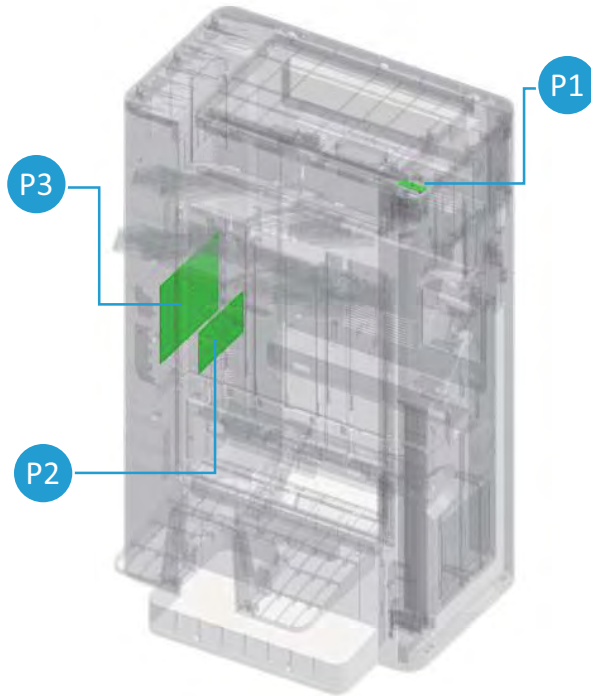


Table 5-18 PCA

No	Name	Part number	Orderable <sup>(*)</sup>	Description
P1	Manual staple PCA	JC92-02789B		This PCA shows the manual stapling condition and accepts the button input for manual staple.
P2	Booklet maker PCA	JC92-02789B	(*)	This PCA controls the booklet maker module and consists of the micro-controller and driver ICs.
P3	Finisher main PCA	JC92-02968A	(*)	This PCA controls the finisher modules and consists of the micro-controller and driver ICs.
Not shown	Hole punch PCA	-		This PCA controls the hole punch module and consists of the micro-controller and driver ICs.

(\*) This part is in ordering system.

## Bridge unit

The Bridge Unit is the asset to transfer paper from the printer to the finisher. The bridge entrance sensor (S1) detects paper entering the bridge unit from the printer. In the same way, the bridge exit sensor (S3) checks that the paper leaves from the bridge unit to the finisher. The bridge motor (M14) drive the bridge entrance roller, bridge middle roller, and bridge exit roller. It makes paper moves through the bridge unit. The jam removal door locating at the front side of the unit helps user to remove the jammed paper.

Figure 5-18 Bridge unit overview

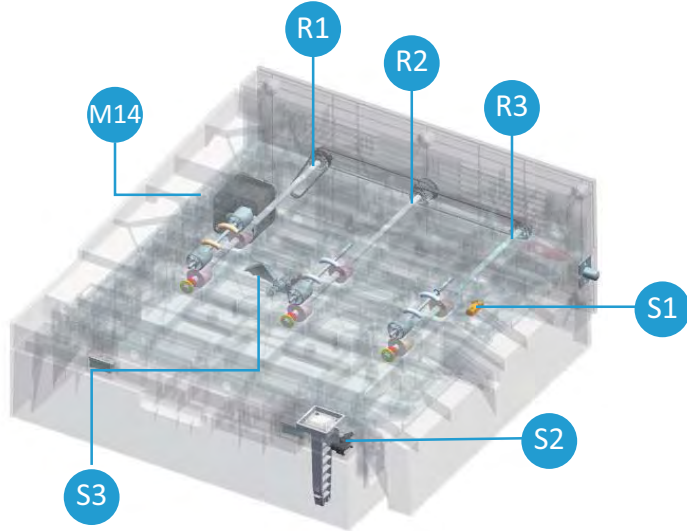


Figure 5-19 Bridge unit detail view

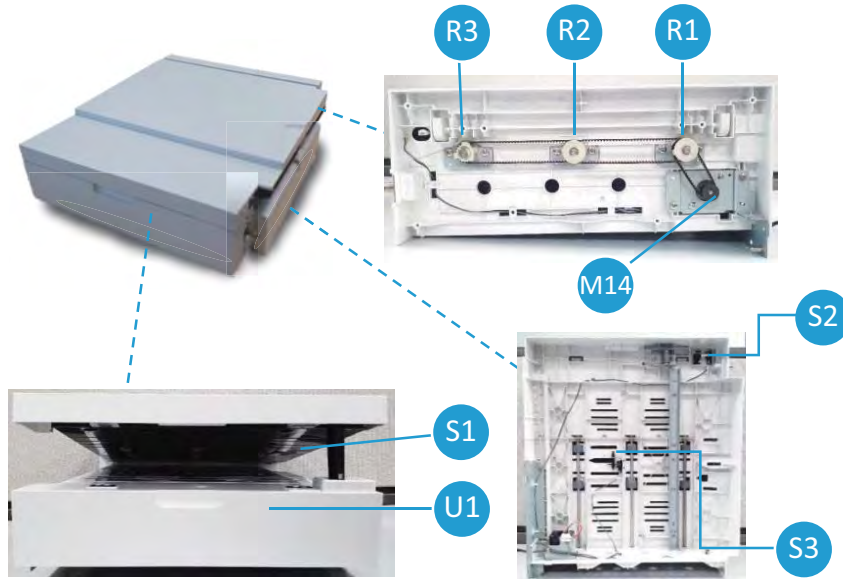


Table 5-19 Bridge unit parts information

No	Part Name	Part number	Orderable <sup>(*)</sup>	Diagnostics	Description
U1	Bridge unit	JC90-01772B	(*)		Moves paper from the printer to the finisher.
S2	Bridge door sensor	0604-001393	(*)	113-2180	Detects if the bridge door is open.
S1	Bridge entrance sensor	JC32-00020A	(*)	113-2070	Checks whether paper comes into the bridge entrance unit.
S3	Bridge exit sensor	0604-001393	(*)	113-2071	Checks whether paper move out of the bridge unit.
M14	Bridge motor	JC31-00163B	(*)	113-2560	Rotates the bridge entrance roller, the bridge middle roller and the bridge exit roller.
R3	Bridge entrance roller	JC66-04733A	(*)		Moves paper from the machine to the bridge unit.

**Table 5-19** Bridge unit parts information (continued)

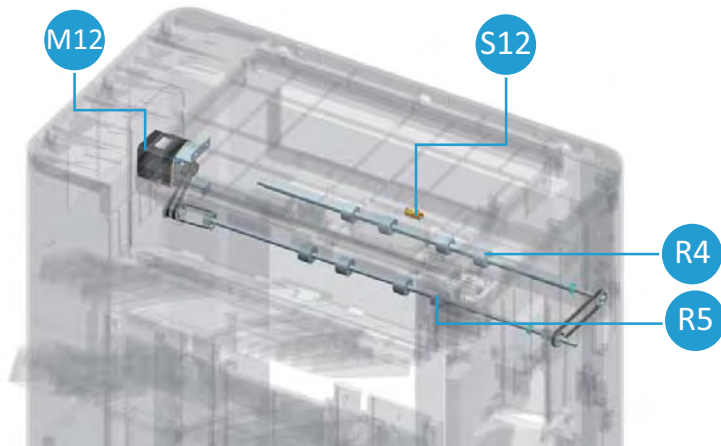
No	Part Name	Part number	Orderable <sup>(*)</sup>	Diagnostics	Description
R2	Bridge middle roller	JC66-04732A	(*)		Moves paper from the machine to the bridge unit.
R1	Bridge exit roller	JC66-04732A	(*)		Moves paper from the bridge unit to the finisher entrance unit.

(\*) This part is in ordering system.

## Entrance unit

Entrance unit moves paper from the bridge unit to the inside of the finisher. The Entrance sensor (S12) installed at the right side of the unit senses that the paper is entering the unit. The Entrance motor (M12) rotates forward to drive the entrance roller and the middle roller to move paper to the exit unit.

**Figure 5-20** Entrance unit overview



**Figure 5-21** Entrance unit detail view - front

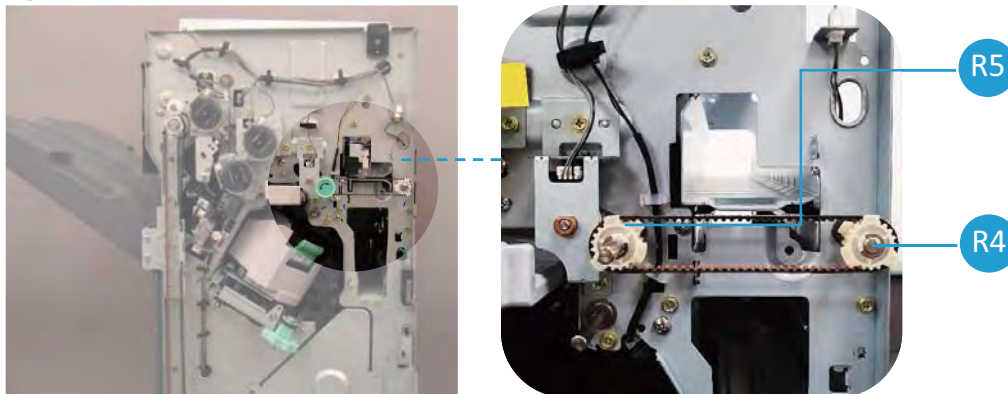


Figure 5-22 Entrance unit detail view - rear

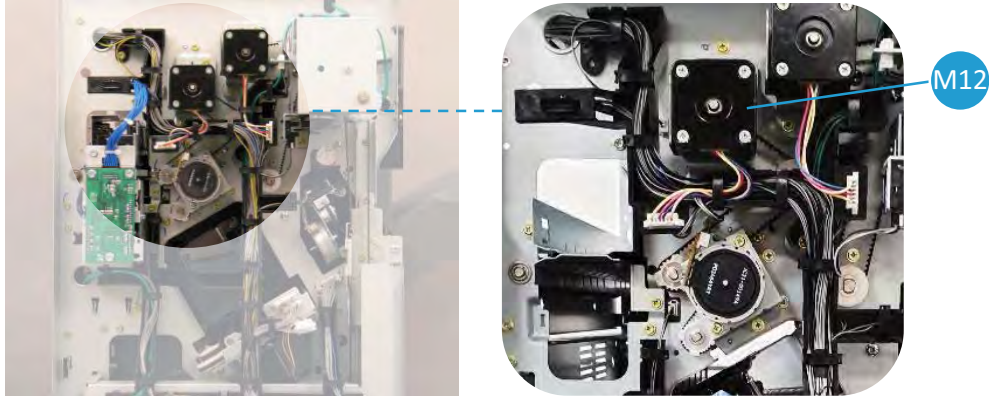


Figure 5-23 Entrance unit detail view - right



Table 5-20 Entrance unit parts information

No	Part Name	Part number	Orderable <sup>(*)</sup>	Diagnostics	Description
S12	Entrance sensor	JC32-00020A	(*)	113-2080	Detects whether paper enters at the entrance unit.
M12	Entrance motor	JC31-00163B	(*)	113-2570	Operates the entrance roller and middle roller when driving forward.
R4	Entrance roller	JC66-04722A	(*)		Moves paper from the entrance unit to the exit unit.
R5	Middle roller	JC66-04724A	(*)		Moves paper from the entrance unit to the exit unit.

(\*) This part is in ordering system.

## Punch unit (optional)

Learn about the punch unit of the Stapler/stacker finisher and booklet finisher.

The punch unit is a device that punches holes in a specific location on a sheet of paper. The punch unit is positioned right after the entrance unit.

- HP LaserJet Hole Punch 2/3 Accessory —Y1G10A
- HP LaserJet Hole Punch 2/4 Accessory — Y1G11A
- HP LaserJet Hole Punch Swedish Accessory — Y1G12A

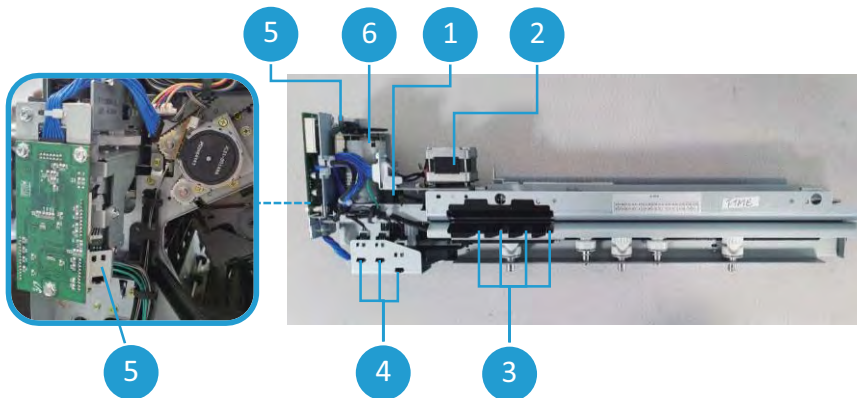
 **NOTE:** Puncher types are various depending on the country.

In case of 2/3 hole punch, the 5 hole-punches are mounted in the punch unit. As the punch motor rotates forward, the inner gear moves to the right and the 3 hole-punches are moved downward to make the holes on the paper. When making 2 holes, the motor rotates in the backward direction and the inner gear rotates to the left to drill two holes. The travel distance and position of the hole-punches are detected and controlled by the 3 punch position sensors.

**Figure 5-24** Punch unit overview



**Figure 5-25** Punch unit detail view



**Table 5-21** Punch unit parts information

Item	Part name	Part number	Orderable <sup>(*)</sup>	Diagnostics	Description
U1	Punch unit				
	2-3 hole	Y1G10A	(*)		
	2-4 hole	Y1G11A	(*)		
	Swedish hole	Y1G12A	(*)		
1	Punch scan home sensor			113-4000	Detects the home position of the punch unit

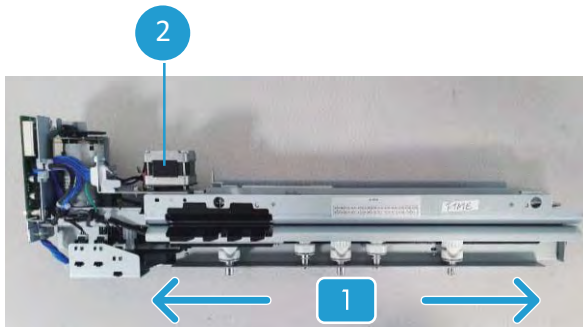
**Table 5-21** Punch unit parts information (continued)

Item	Part name	Part number	Orderable <sup>(*)</sup>	Diagnostics	Description
3	Punch scan edge sensor			113-4010 113-4011 113-4012 113-4013	Check the paper width to make hole on the right position of paper.
2	Punch scan motor			113-4500	Transmits the force to move the punch unit in the horizontal direction.
4	Punch position sensor			113-4020 113-4030 113-4031	Detects the travel distance and position of the hole-punches.
5	Punch motor sensor			113-4040	Checks whether the punch motor is operational
6	Punch motor			113-4510	Transmits the force to make holes on the paper

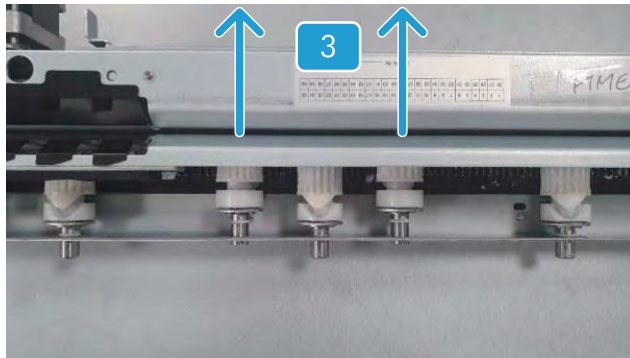
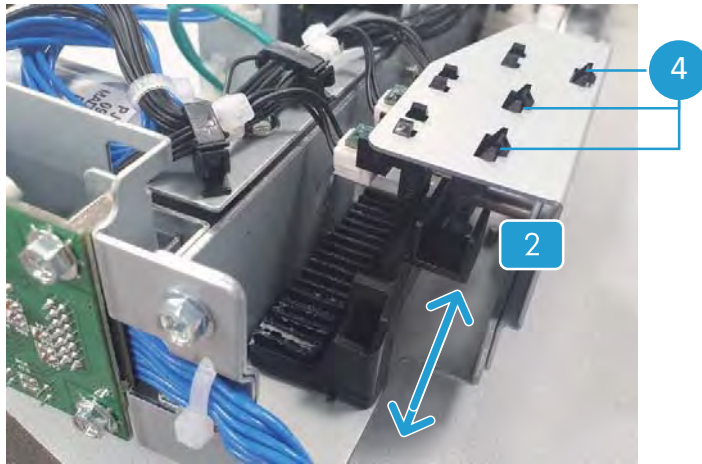
<sup>(\*)</sup> This part is in system.

### Punch unit operation

1. A paper enters into the punch unit, and it is aligned to drill holes.
2. The motor rotates forward or backward, then the punch rail in the punch unit moves in order to move the punch hole makers (callout 1).



3. The punch position sensors determine the punch rail location (callout 2). It drives the punch hole makers up and down to make holes (callout 3).



4. In some paper size, paper might be jammed in a place where punch hole maker is located. Therefore, the punch unit moves left and right (callout 4).



## Tray diverter unit

Learn about the Tray diverter unit of the Stapler/stacker finisher and booklet finisher.

The tray diverter unit is responsible for determining the paper feed direction so that paper can be ejected to the main output tray or top output tray.

The entrance motor (M12) rotates this unit. When the entrance motor rotates backward, the phase of the diverter cam (callout1) changes so that the paper path direction changes. The tray diverter home sensor (S4) checks whether the tray diverter is located at the home position or not. (callout2).

Figure 5-26 Tray diverter unit overview

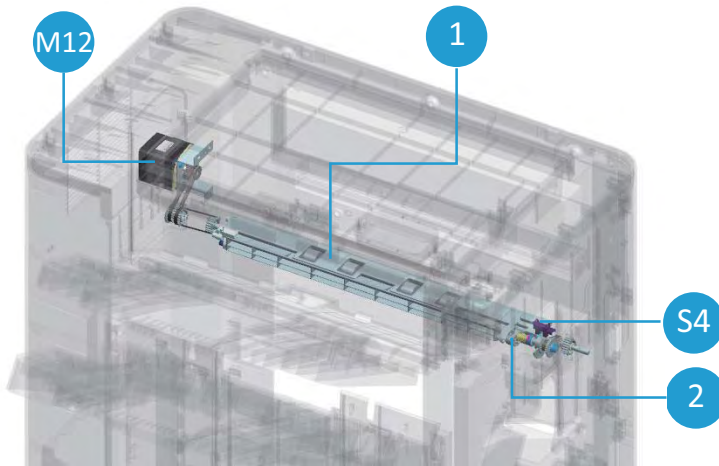


Figure 5-27 Tray diverter unit detail view – front-top

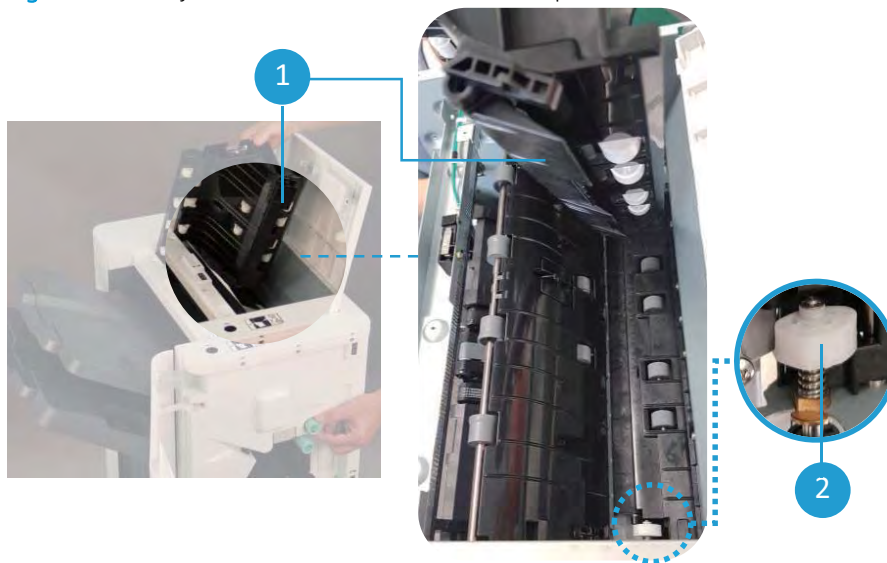
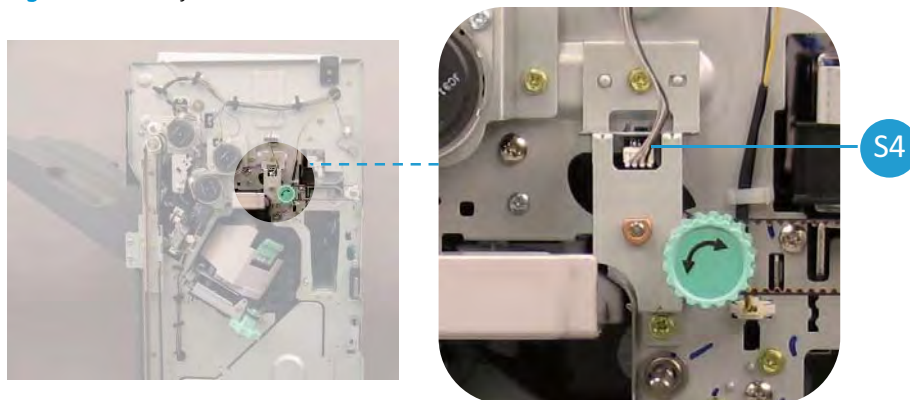


Figure 5-28 Tray diverter unit detail view – rear





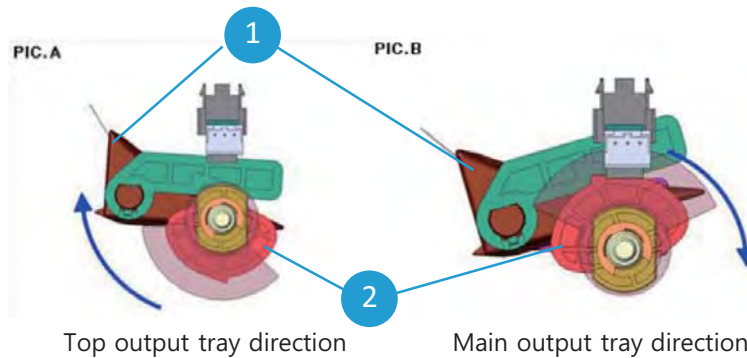
**Table 5-22** Tray diverter unit parts information

Item	Part name	Part number	Orderable <sup>(*)</sup>	Diagnostics	Description
1	Tray diverter	JC61-07205A			Selects the paper path of either the main output tray or the top output tray
2	Tray diverter cam	JC66-04560A		113-2520	Changes the paper path
S4	Tray diverter home sensor	0604-001415	(*)	113-2020	Checks whether home position of the tray diverter
M12	Entrance motor	JC31-00163B	(*)		Operates the tray diverter cam when driving in the backward direction.

(\*) This part is in ordering system.

### Tray diverter unit operation

1. When printing or copying documents, the entrance motor operates backward so that the diverter cam (Callout 2) can be rotate.
2. The direction of the tray diverter(callout1) is changed to the main output tray or the top output tray by the tray diverter cam(callout2).



### Top exit unit

Learn about the Top exit unit of the Stapler/stacker finisher and booklet finisher.

The top exit unit sends paper from the tray diverter unit to the top output tray unit.

The top exit sensor(S11) detects paper entry into the top exit unit. The entrance motor(M12) drives the top middle roller, and the exit motor(M13) transmit the force to rotate the top exit roller so that paper moves to the top output tray unit.

Figure 5-29 Top exit unit overview

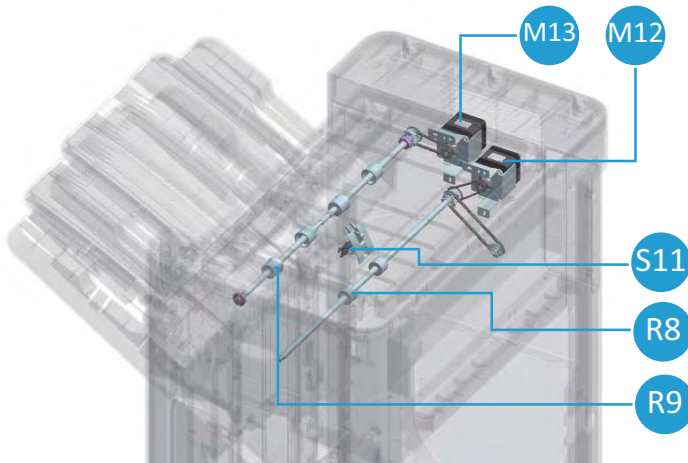


Figure 5-30 Top exit unit detail view – front-top

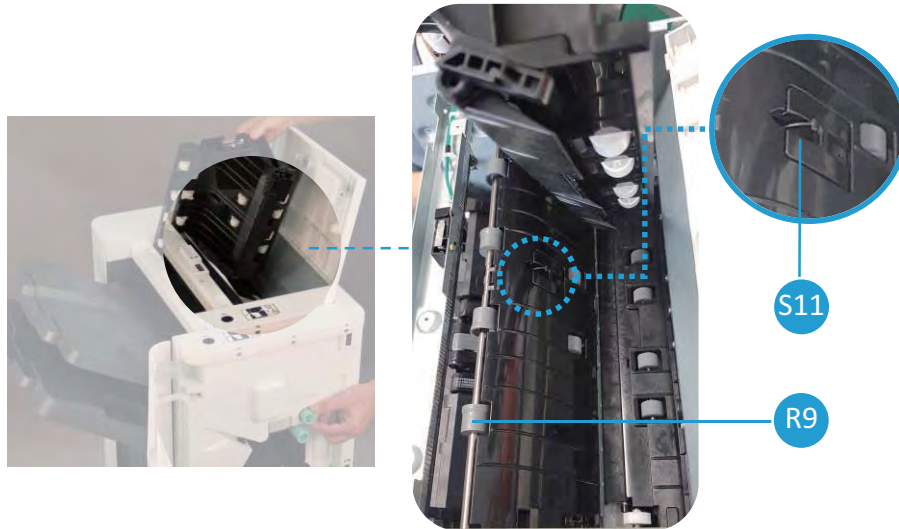


Table 5-23 Top exit unit parts information

Item	Part name	Part number	Orderable <sup>(*)</sup>	Diagnostics	Description
S11	Top exit sensor	0604-001393	(*)	113-2091	Checks whether paper has entered at the top exit unit
M12	Entrance motor	JC31-00163B	(*)	113-2570	Rotates the top middle roller when driving in the forward direction.
M13	Exit motor	JC31-00163B	(*)	113-2580	Rotates the top exit roller
R8	Top middle roller	JC66-04725A	(*)		Moves paper to the top output tray
R9	Top exit roller	JC66-04727A	(*)		Moves paper to the top output tray

(\*) This part is in ordering system.

## Top output tray unit

Learn about the Top output tray unit of the Stapler/stacker finisher and booklet finisher.

The top output tray unit loads discharged paper from the finisher.

It has the paper pull sensor(S15) to detect whether the tray is full with paper.

Figure 5-31 Top output tray unit overview

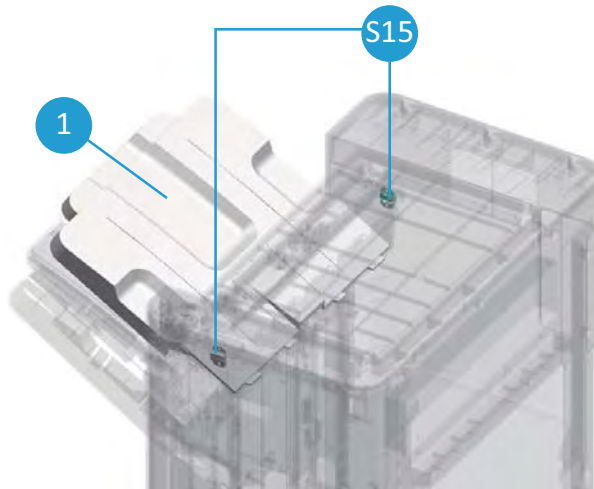


Figure 5-32 Top output tray unit detail view – front-left

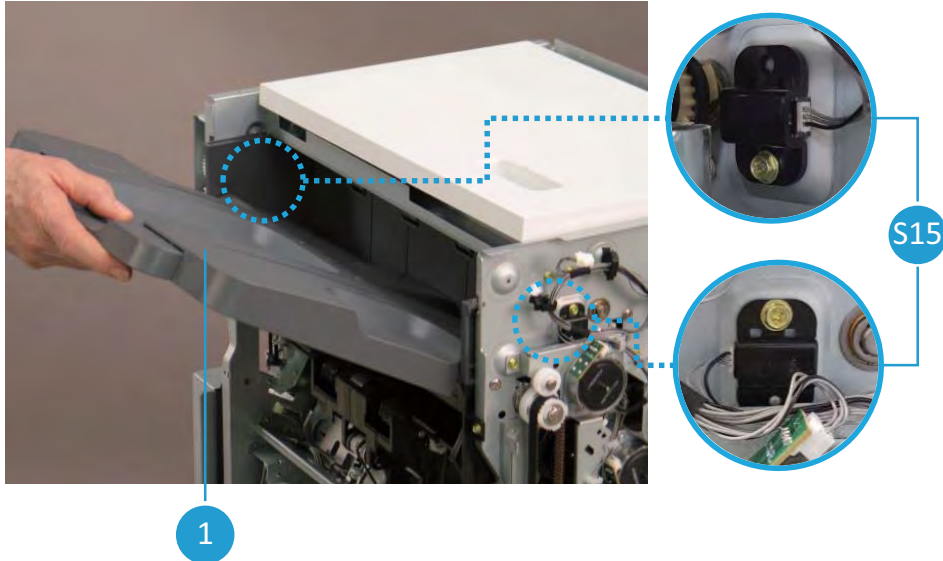


Table 5-24 Top output tray unit parts information

Item	Part name	Part number	Orderable <sup>(*)</sup>	Diagnostics	Description
1	Top output tray	JC63-04996B			Loads ejected paper
		JC63-05003B	(*)		
S15	Top output tray paper full sensor (receiver, led)	JC82-01039A	(*)	113-2145	Detects whether paper is fully staked on the output tray.

(\*) This part is in ordering system.

## Main exit unit

Learn about the Main exit unit of the Stapler/stacker finisher and booklet finisher.

The main exit unit delivers paper from the tray diverter unit to the ejector unit or buffer unit.

The main exit sensor (S10) detects whether paper comes in from main exit unit. The exit motor (M13) drives the main exit roller to send the paper to the ejector unit or buffer unit.

Figure 5-33 Main exit unit overview

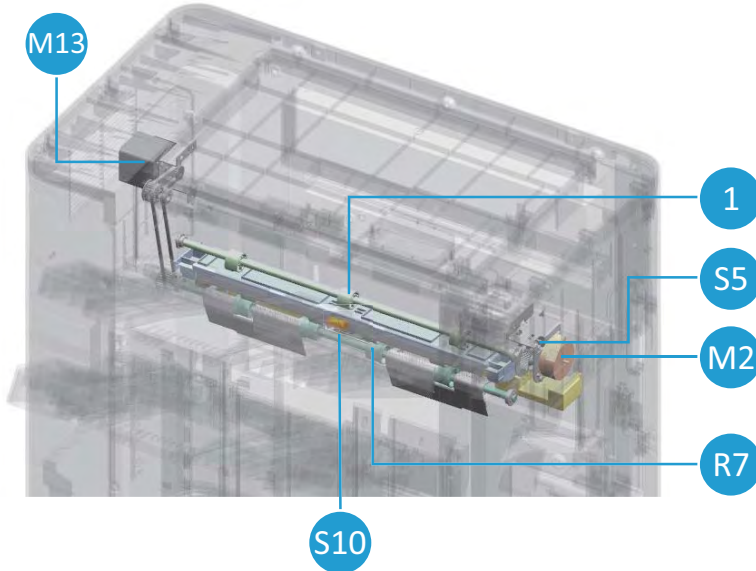


Figure 5-34 Main exit unit detail view – (front-rear)

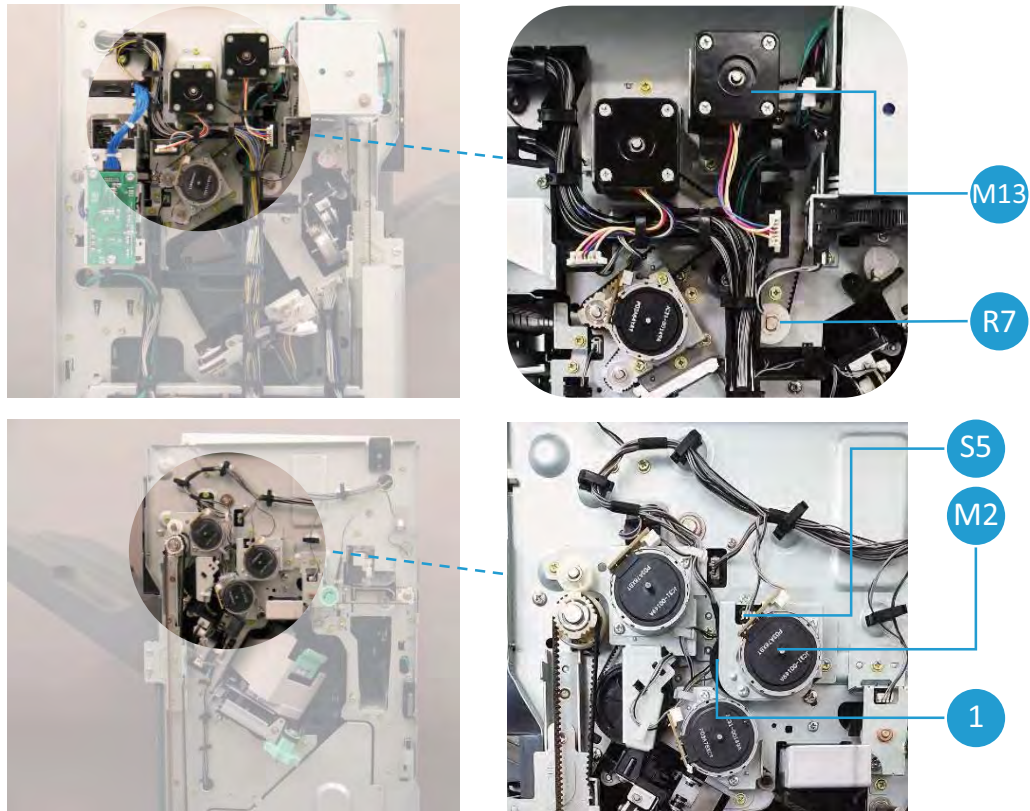


Table 5-25 Main exit unit parts information

Item	Part name	Part number	Orderable <sup>(*)</sup>	Diagnostics	Description
S10	Main exit sensor	JC32-00020A	(*)	113-2090	Detects whether paper entered at the main exit unit

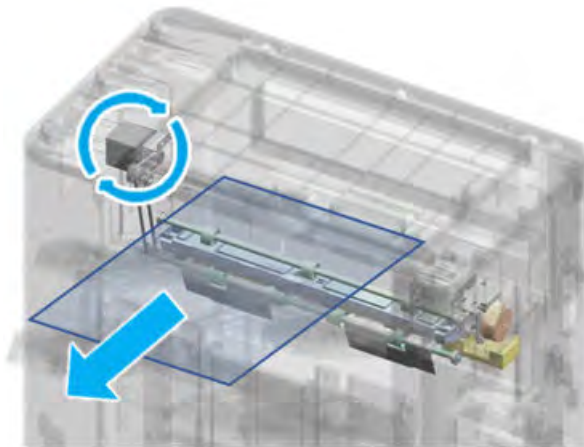
Table 5-25 Main exit unit parts information (continued)

Item	Part name	Part number	Orderable <sup>(*)</sup>	Diagnostics	Description
M13	Exit motor	JC31-00163B	(*)	113-2580	Rotates the main exit roller
R7	Main exit roller	JC66-04726A	(*)		Moves paper to the ejector unit or the buffer unit
1	Main exit cam				Adjusts the gap between the main exit roller and the idle roller for the buffering. (*Please refer to 'buffer unit')
S5	Main exit cam home sensor	0604-001393	(*)	113-2000	Detects the home position of the main exit cam
M2	Main exit cam motor	JC93-01155A	(*)	113-2500	Rotates the main exit cam.

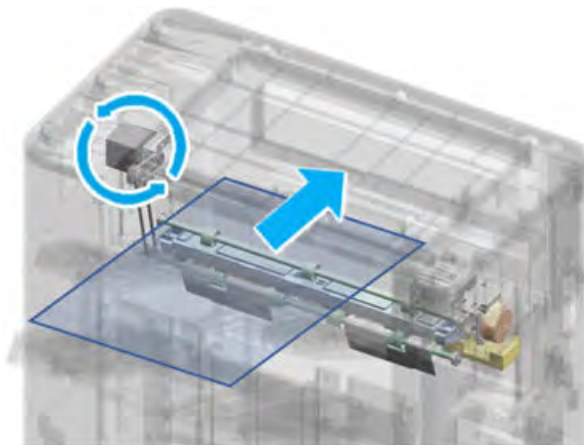
(\*) This part is in ordering system.

### Main exit unit operation

1. The exit motor(M13) drives forward so that paper will moves towards the ejector unit.



2. On the other hand, if the exit motor rotates backwards paper moves towards the buffer unit.



## Paddle unit

Learn about the Paddle unit of the Stapler/stacker finisher and booklet finisher.

The paddle unit rotates the rubber paddles mounted on the shaft to move paper to the end fence unit, allowing paper to be arranged well for the next job. The paddle presser is mounted behind the rubber paddles and presses the end of paper to help paper be stacked well at the end fence unit. The Paddle home sensor (S8) checks the home position to drive the paddles. And the paddle motor(M1) drives the paddle and paddle presser.

Figure 5-35 Paddle unit overview

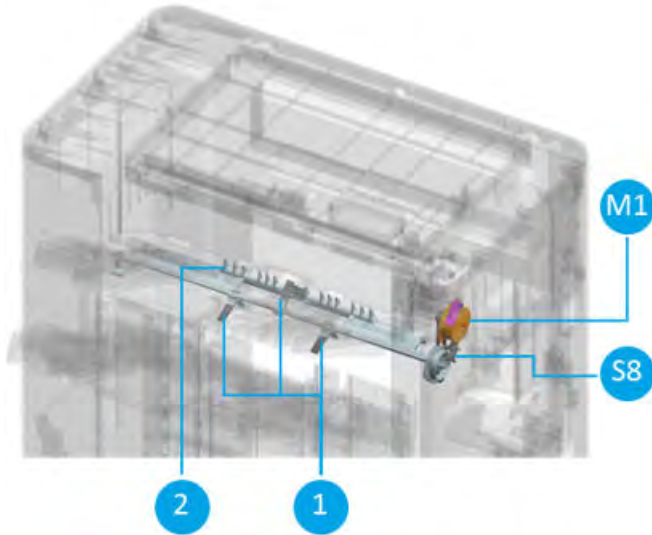


Figure 5-36 Paddle unit detail view - front

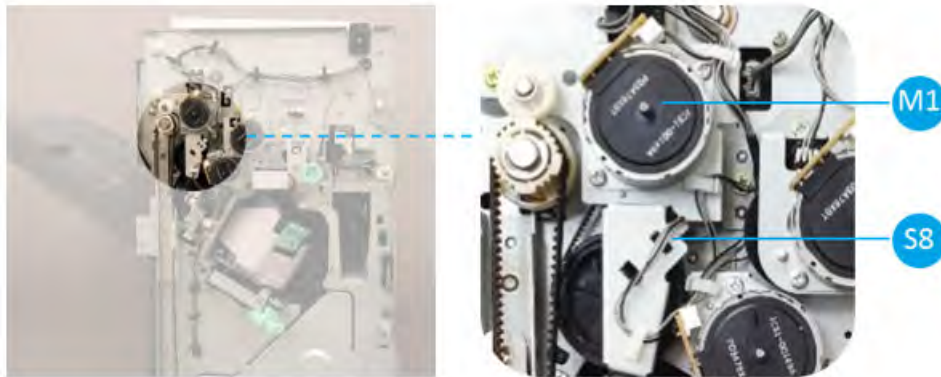
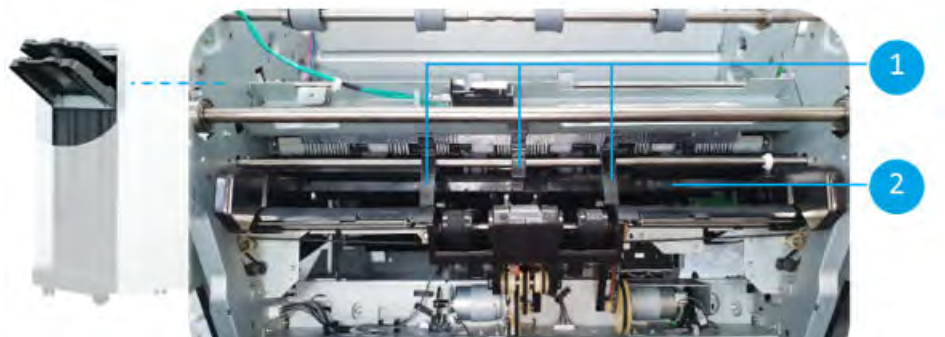


Figure 5-37 Paddle unit detail view - left



**Table 5-26 Paddle unit parts information**

Item	Part name	Part number	Orderable <sup>(*)</sup>	Diagnostics	Description
1	Paddle	JC90-01480A			Moves paper into the end fence unit
2	Paddle presser	JC61-07206A			Presses the end of bent paper helps paper to be loaded well at the end fence unit
S8	Paddle home sensor	0604-001393	(*)	113-2060	Detect the home position of the paddle
M1	Paddle motor	JC93-01001A	(*)	113-2600	Rotates the paddle, and moves the paddle presser up and downward at the same time

(\*) This part is in ordering system.

### Paddle unit operation

1. A paper falls downward by exit unit.
2. The paddles rotate to make a paper moves into the end fence unit. (callout 1)



3. The paddle presser presses the end of a paper so as not to be scattered. (callout 2).

### End fence unit

Learn about the End fence unit of the Stapler/stacker finisher and booklet finisher.

The paddle unit moves paper to the end fence unit. The end fence unit sets the standard position of the paper to be aligned towards top and bottom of the paper.

End fence motor(M3) operates the two end fences and adjust width of them in order to stack paper correctly. The end fence home sensor(S7) detects the home position of the end fence.

Figure 5-38 End fence unit overview

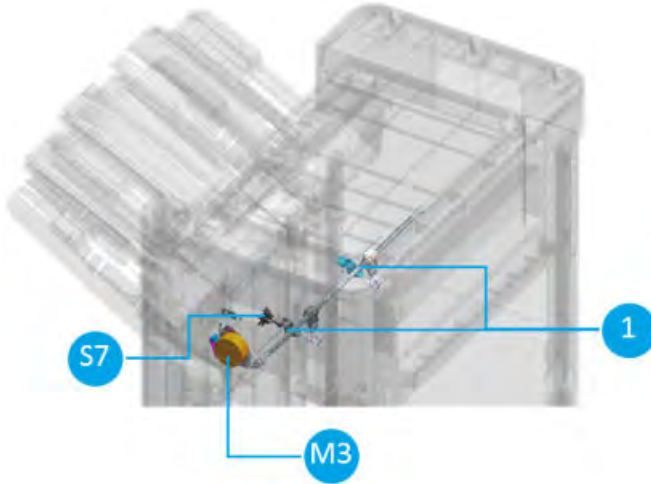


Figure 5-39 End fence unit detail view – front

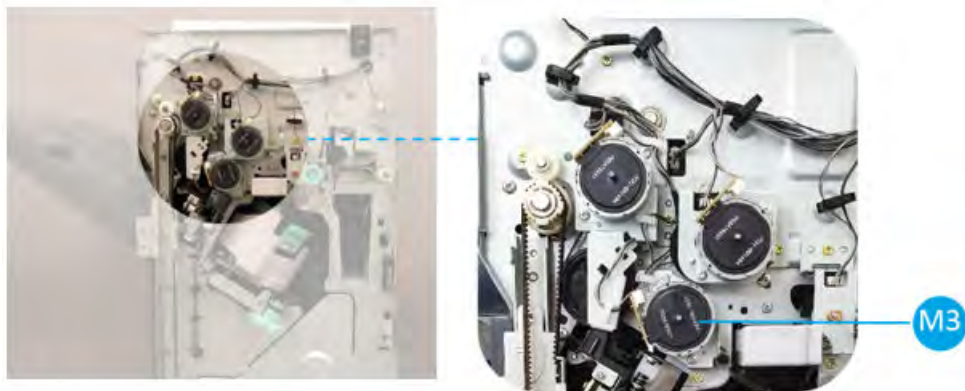


Figure 5-40 End fence unit detail view - left

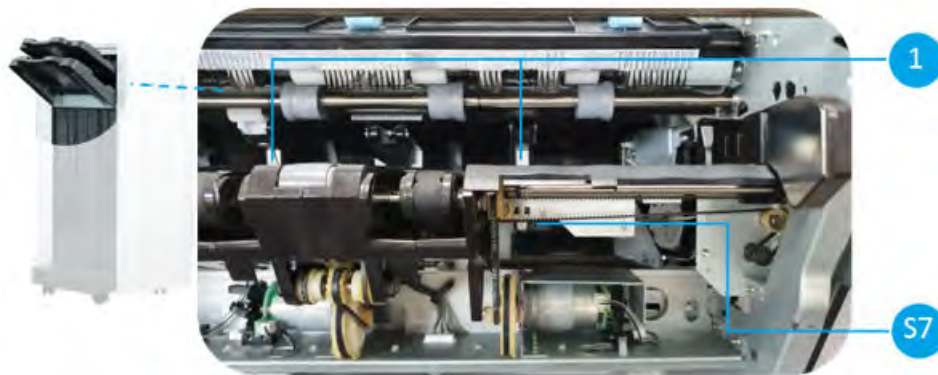


Table 5-27 End fence unit parts information

Item	Part name	Part number	Orderable <sup>(*)</sup>	Diagnostics	Description
1	End fence				Aligns top and bottom side of paper.
S7	End fence home sensor	0604-001393	(*)	113-2050	Detects the home position of the end fence



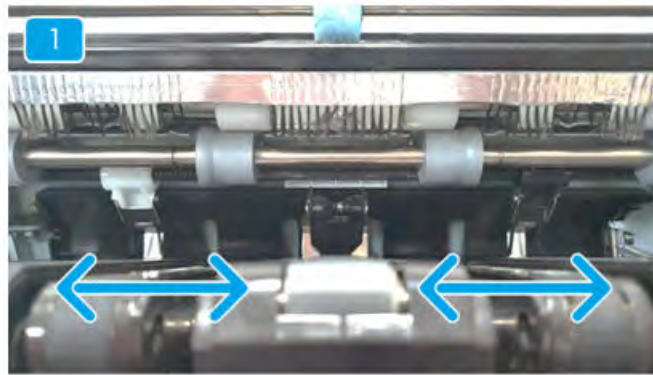
**Table 5-27 End fence unit parts information (continued)**

Item	Part name	Part number	Orderable <sup>(*)</sup>	Diagnostics	Description
M3	End fence motor	JC93-01001A	(*)	113-2590	Moves front and rear end fence depending on paper size(width) so that paper arranged well at the end fence

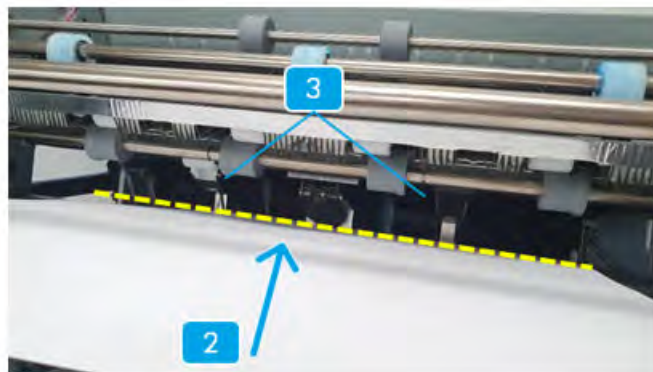
(\*) This part is in ordering system.

### End fence unit operation

1. The end fence motor(M3) moves the front and rear end fences in the arrow direction (callout 1) depending on paper width.



2. Paper goes into the end fence unit by the paddle unit. (callout 2)



3. At the same time the end fence unit aligns paper to the direction of yellow line. (callout 3)

### Tamper unit

Learn about the Tamper unit of the Stapler/stacker finisher and booklet finisher.

The tamper unit functions to align the left and right sides of a bundle of paper. When a certain amount of paper is collected after printing, the tamper unit hits the left and right ends of the paper to align the paper correctly.

Each tamper has a motor on the back side that delivers driving force to move. The tamper home sensors are mounted on the back side of the unit to check the home position of the tamper unit.

Figure 5-41 Tamper unit overview

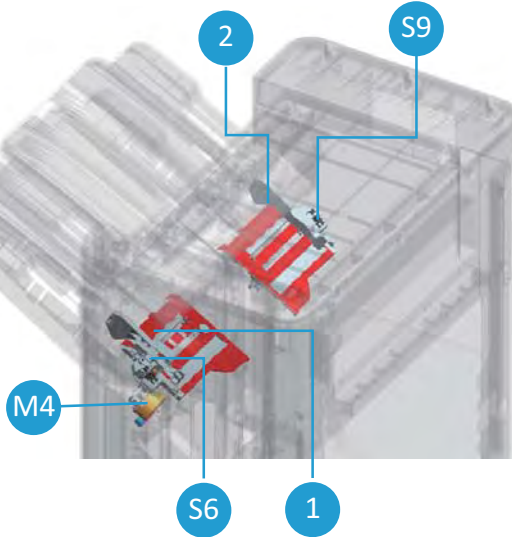


Figure 5-42 Tamper unit detail view - left

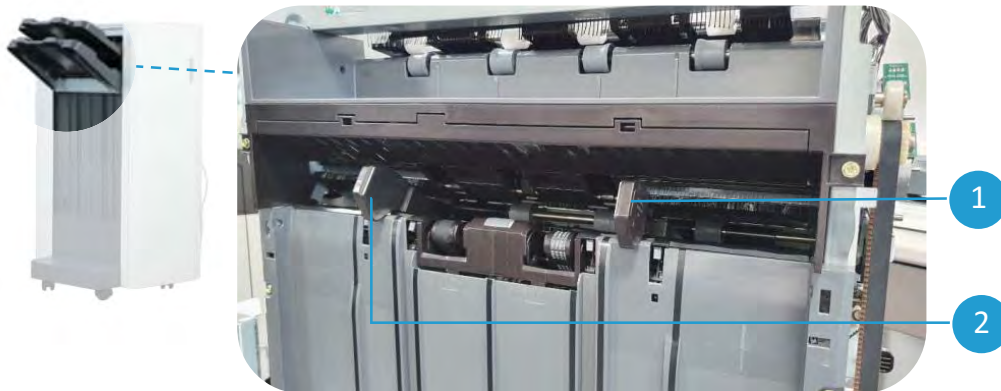
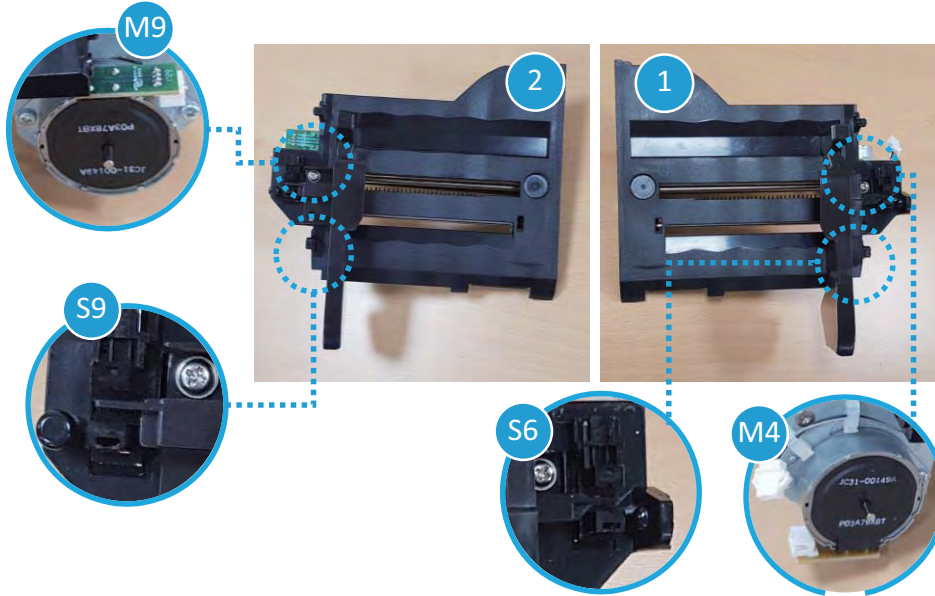


Figure 5-43 Tamper unit detail view - left-right



**Table 5-28** tamper unit parts information

Item	Part name	Part number	Orderable <sup>(*)</sup>	Diagnostics	Description
1	Front tamper	JC82-00901A	(*)		Aligns left and right side of paper.
S6	Front tamper home sensor	0604-001393	(*)	113-2120	Detects the home position of the tamper unit.
M4	Front tamper motor	JC93-01001A	(*)	113-2630	Moves the front tamper unit.
2	Rear tamper	JC82-00898A	(*)		Aligns left and right side of paper.
S9	Rear tamper home sensor	0604-001393	(*)	113-2130	Detects the home position of the tamper unit.
M9	Rear tamper motor	JC93-01001A	(*)	113-2640	Moves the front tamper unit.

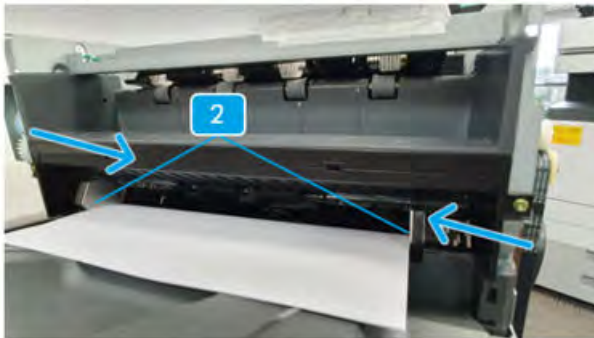
(\*) This part is in ordering system.

### Tamper unit operation

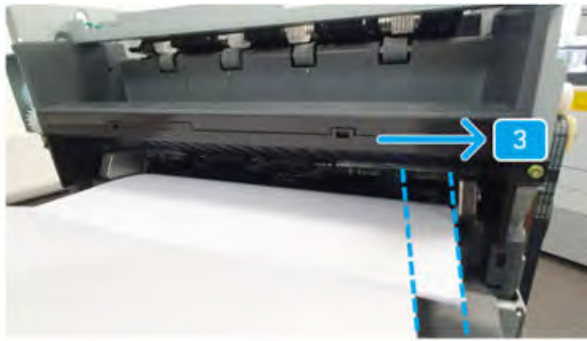
1. A stack of paper is arranged at the end fence unit.



2. The left and right tampers arrange them.



3. In case of offset printing, the tamper unit arranges the next bundle to be shifted. (callout 3)



## Stapler unit

Learn about the Stapler unit of the Stapler/stacker finisher and booklet finisher.

Stapler unit is a device installed inside the finisher that staples a bundle of aligned documents. Documents are collected as a bundle by the tamper unit and the end fence unit for stapling, then stapler assembly staples the bundle. There are 6 options to make a bundle.

**Figure 5-44** Stapling options



The stapler unit moves using the stapler motor (M8) installed inside. The one home sensor (rear sensor, S30) and two position sensors (mid-front, S24 and mid-rear sensor, S25) are mounted so that the stapler can be positioned in the exact stapling position whether it is stapled on the left, the right, or at the center of the document. Stapling is done by the motor inside the stapler assembly.

In addition, manual staple feature is available on the front-upper side of the finisher. The manual staple sensor (S19) detects whether a stack of paper comes into the manual staple location or not. The front sensor (stapler front sensor, S21) makes the stapler moves at the manual staple location.

Figure 5-45 Stapler unit overview

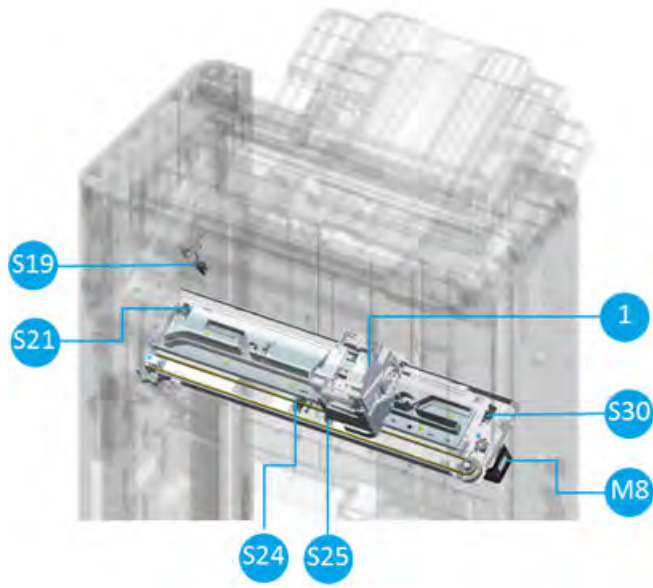


Figure 5-46 Stapler unit detail view - front

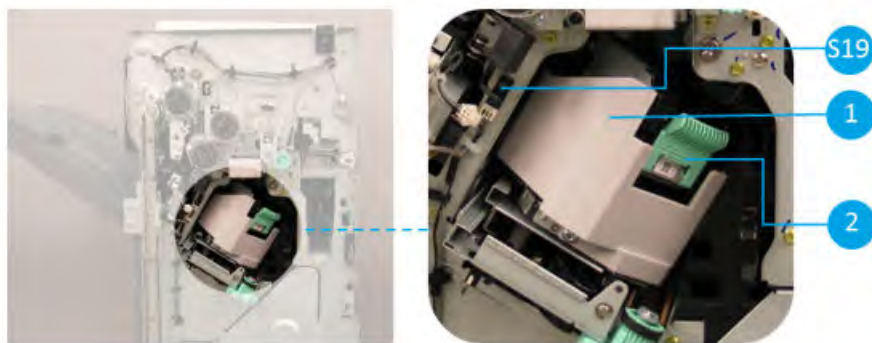


Figure 5-47 Stapler unit detail view

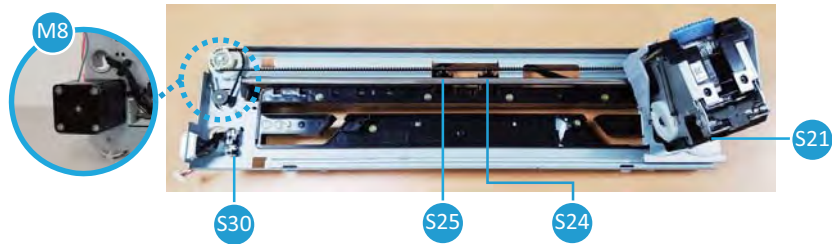


Table 5-29 Stapler unit parts information

Item	Part name	Part number	Orderable <sup>(*)</sup>	Diagnostics	Description
1	Stapler unit	JC82-00894A	(*)		Staples a bundle of paper
2	Staple cartridge	JC81-09882B	(*)	113-2115 113-2116	Staple cartridge
S21	Stapler front sensor	0604-001393	(*)	113-2113	Detect the stapler at the manual stapling position
S24	Stapler mid-front sensor	0604-001393	(*)	113-2112	Detect the stapler location

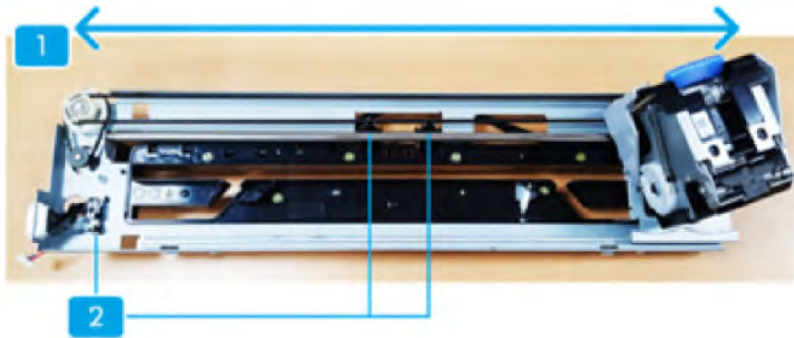
Table 5-29 Stapler unit parts information (continued)

Item	Part name	Part number	Orderable <sup>(*)</sup>	Diagnostics	Description
S25	Stapler mid-rear sensor	0604-001393	(*)	113-2111	Detect the stapler location
S30	Stapler rear sensor	0604-001393	(*)	113-2110	Detect the home position of the stapler
S19	Manual staple sensor	0604-001415	(*)	113-2160	Detect paper when manual stapling
M8	Stapler position motor	JC31-00163A	(*)	113-2620	Moves the stapler

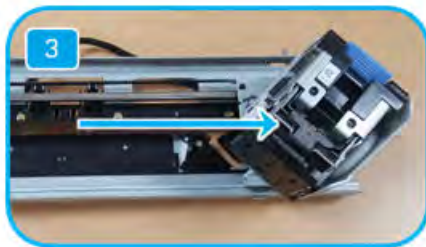
(\*) This part is in ordering system.

### Stapler unit operation

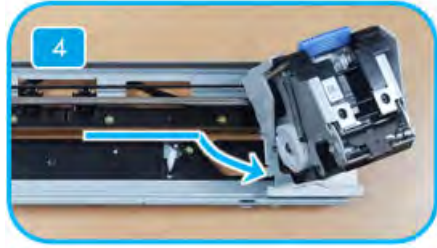
1. The stapler position motor drives the stapler assembly to direction 1.



2. The stapler assembly moves through the rail using three stapler position sensors (callout 2) and staples a stack of paper.
3. In case of staple cartridge replacement, the stapler moves to direction 3.



4. For manual stapling, the stapler moves in direction 4.



## Ejector unit

Learn about the ejector unit of the Stapler/stacker finisher and booklet finisher.

The ejector unit ejects a bundle of paper out to the main output tray. The ejector unit consists of ejector1 and ejector2.

The ejector1 moves a stapled paper loaded at the end fence unit to the ejector2 unit. During this process, the ejector1 motor transmits the driving force to the ejector1 unit. And ejector1 motor sensor checks the ejector1 motor operation. And the ejector1 home sensor detects the home position of the ejector1. The ejector1 end sensor detects the end position of the ejector1.

When the paper arrives at the ejector2 unit, the ejector2 grabs a stack of paper and ejects it onto the main output tray. The ejector2 motor is responsible for this process, and the ejector2 motor sensor helps it to be controlled correctly. In addition, the ejector2 home sensor checks the location of the ejector2.

**Figure 5-48** Ejector unit overview

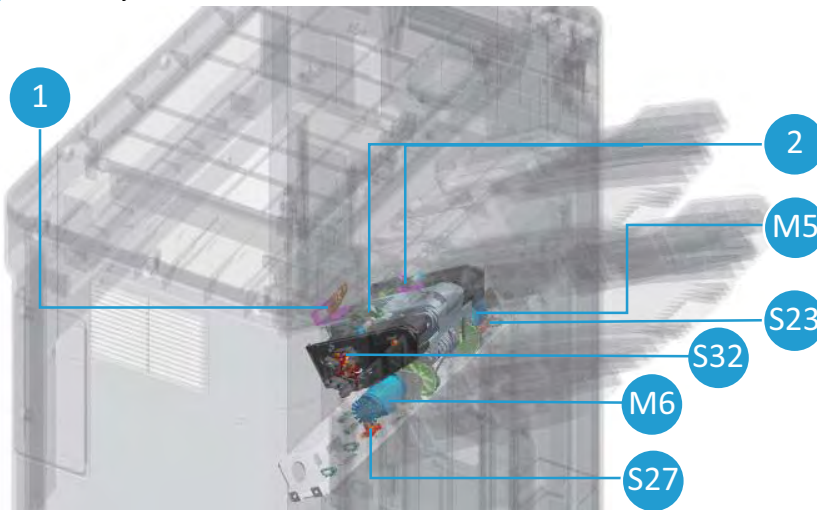


Figure 5-49 Ejector unit detail view - left

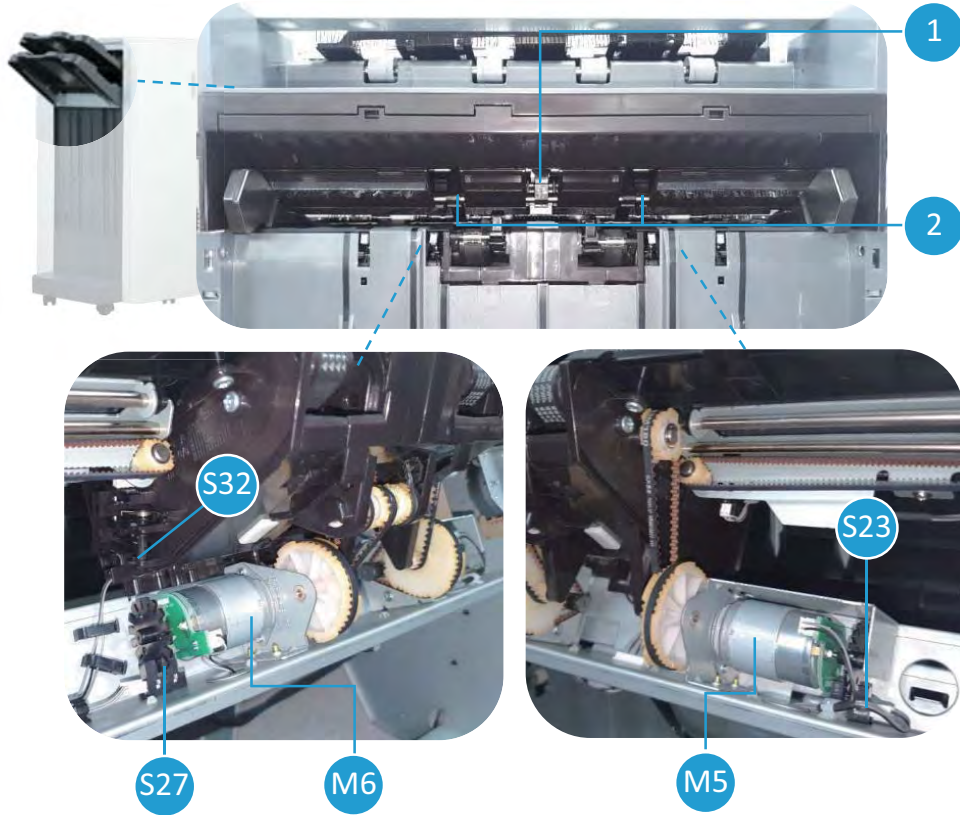


Table 5-30 Ejector unit parts information

Item	Part name	Part number	Orderable <sup>(*)</sup>	Diagnostics	Description
	Ejector unit	JC90-01409A	(*)		
S14	Ejector sensor	JC32-00020A	(*)	113-2170	Detects whether paper is on the ejector or not.
1	Ejector1				Moves the stack of paper from the end fence to the ejector2
S29	Ejector1 home sensor	0604-001415	(*)	113-2031	Detects the home position of the ejector1
S28	Ejector1 end sensor	0604-001415	(*)	113-2030	Detects the end position of the ejector1
S27	Ejector1 motor sensor	0604-001415	(*)	113-2032	Detects whether the Ejector1 motor rotates
M6	Ejector1 motor	JC93-01168A		113-2530	Moves the ejector1 forward and backward
2	Ejector2				Moves paper from the ejector1 to the main output tray
S32	Ejector2 home sensor	0604-001415	(*)	113-2040	Detects the home position of the ejector2
S23	Ejector2 motor sensor	0604-001415	(*)	113-2041	Detects the ejector2 motor rotation



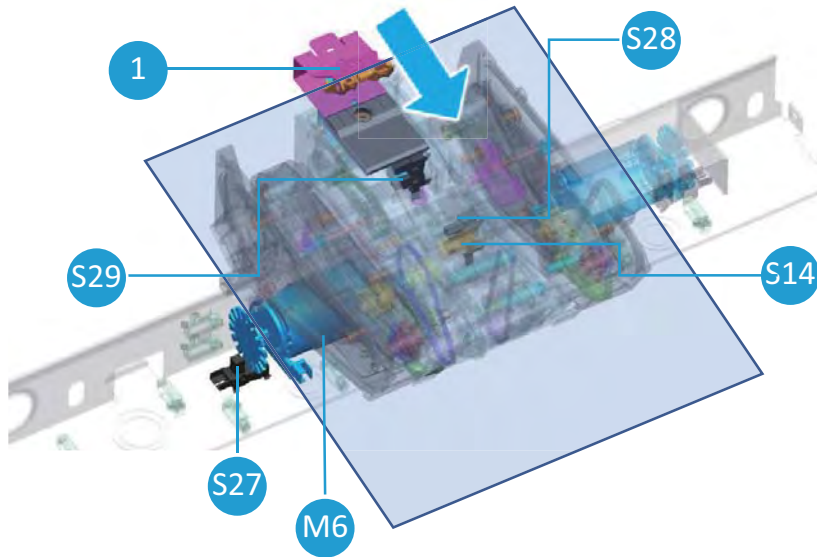
Table 5-30 Ejector unit parts information (continued)

Item	Part name	Part number	Orderable <sup>(*)</sup>	Diagnostics	Description
M5	Ejector2 motor	JC93-01168A		113-2540	Moves the ejector2 and grabs paper

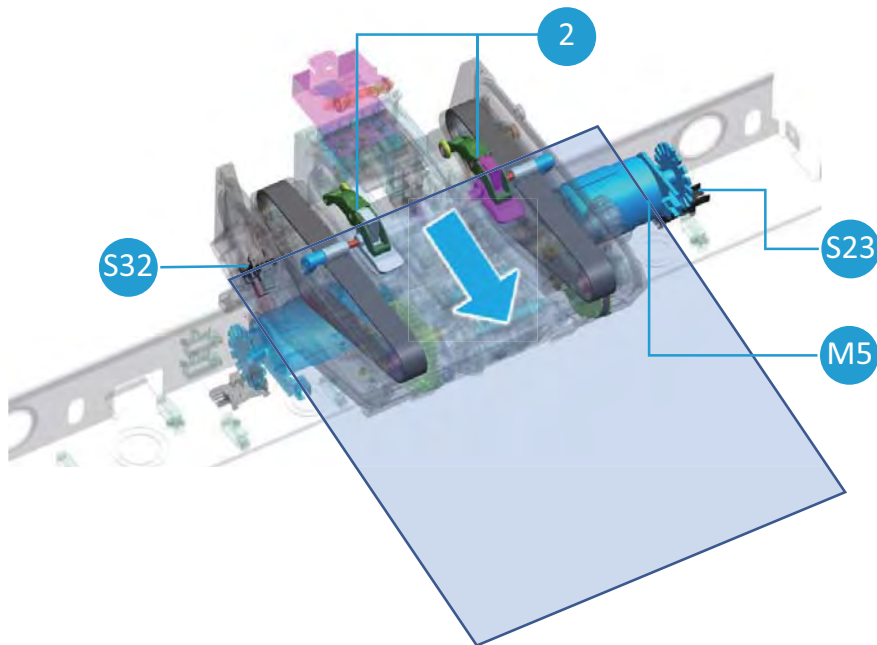
(\*) This part is in ordering system.

### Ejector unit operation

1. The ejector1(callout1) pushes aligned paper at the end fence unit to ejector2 unit(callout2).



2. The ejector2(callout2) picks up paper, then moves forward to the main output tray direction.



## Main output tray unit

Learn about the Main output tray unit of the Stapler/stacker finisher and booklet finisher.

Printouts are stacked on the main output tray (C7). The main output tray moves up and down along the rails inside the finisher, and the main output tray motor (M11) controls those movements according to the signals of the front & rear paper holding sensor. Main output tray motor sensor (S33) checks whether the main output tray motor rotates properly.

When main output tray hits the lower limit sensor of the main output tray (S26), the machine detects that paper tray is full. The main output tray top of stack sensor(S20) detects that the main output tray is on the top.

Figure 5-50 Main output tray unit overview

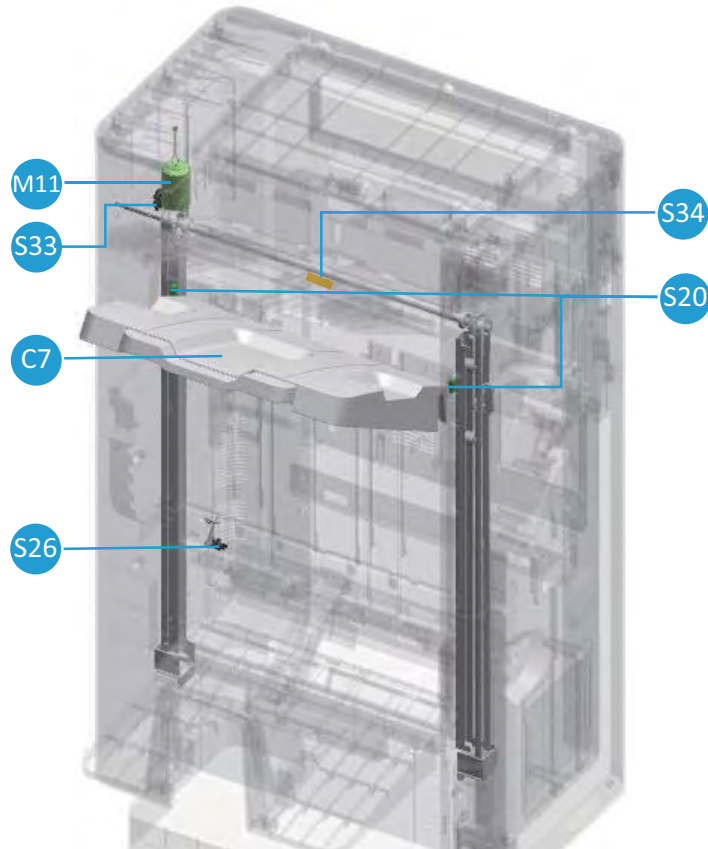


Figure 5-51 Main output tray unit detail view - left

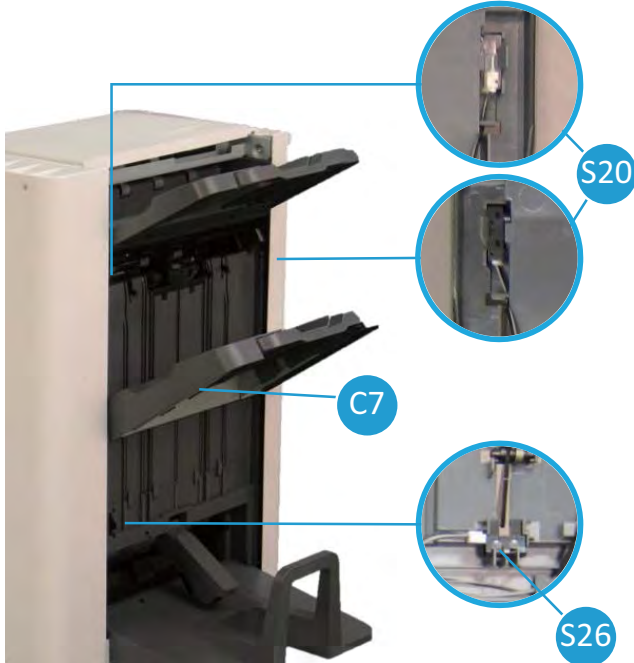


Figure 5-52 Main output tray unit detail view - rear

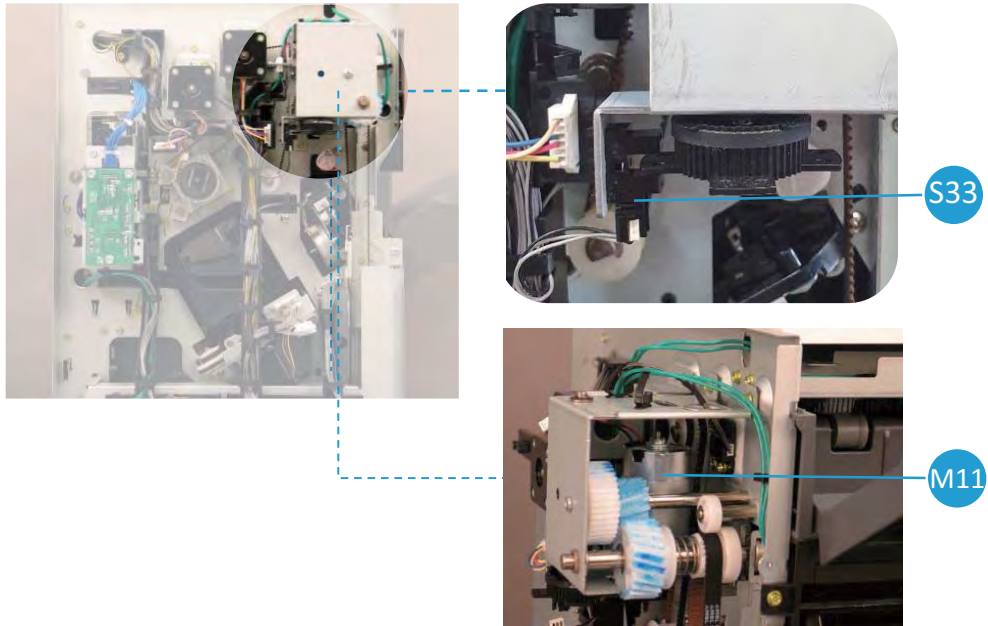


Table 5-31 Main output tray unit parts information

Item	Part name	Part number	Orderable <sup>(*)</sup>	Diagnostics	Description
C7	Main output tray	JC63-05002B			Stacking plate for ejected paper
S20	Main output tray top of stack sensor (receiver, led)	JC82-01039A	(*)	113-2140	Checks the upper limit of main output tray
S6	Main output tray lower limit sensor	0604-001415	(*)	113-2144	Detects the lowest position of the output tray

**Table 5-31** Main output tray unit parts information (continued)

Item	Part name	Part number	Orderable <sup>(*)</sup>	Diagnostics	Description
S33	Main output tray motor sensor	0604-001393	(*)	113-2143	Detects whether the main output tray motor rotates
M11	Main output tray motor	JC31-00178B	(*)	113-2610	Moves the main output tray up and down
		JC90-01415B	(*)		
S34	Main output tray top of stack switch	JC39-02316A		113-2190	Checks the upper limit of main output tray so that detects abnormal movement of output tray

<sup>(\*)</sup> This part is in ordering system.

## Paper holding unit

Learn about the Paper holding unit of the Stapler/stacker finisher and booklet finisher.

The paper holding unit holds printouts on the main output tray. It has a sensor that detects the height of stacked paper so that the output tray moves up and down to stack paper in a stable manner.

The paper holding motor(M7) lifts the paper holding actuator when printouts come out to the main output tray. The paper holding home sensor(S22) detects the location of paper holding actuator at the home position. The front & rear paper holding sensor (S17, S31) checks the volume of printouts on the main output tray and makes the main output tray move downward

**Figure 5-53** Paper holding unit overview

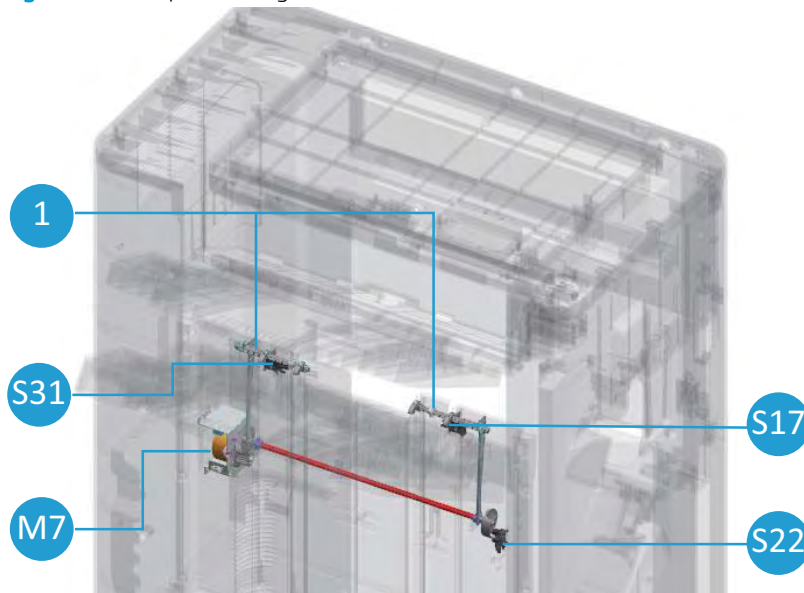


Figure 5-54 Paper holding unit detail view - left

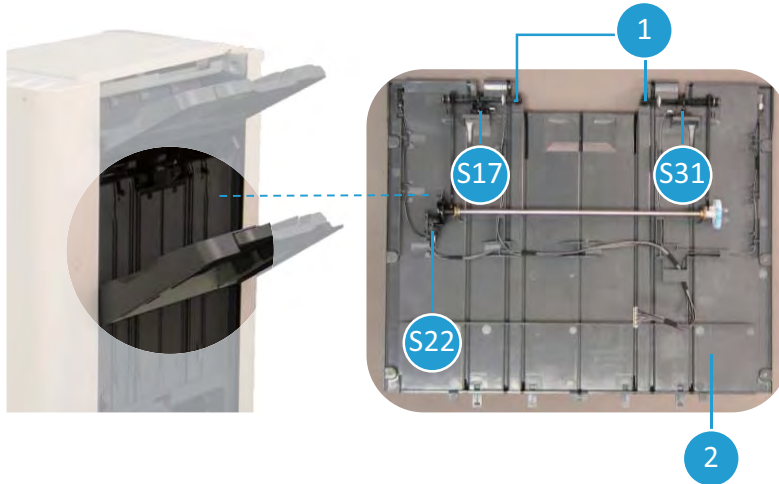


Figure 5-55 Paper holding unit detail view - left

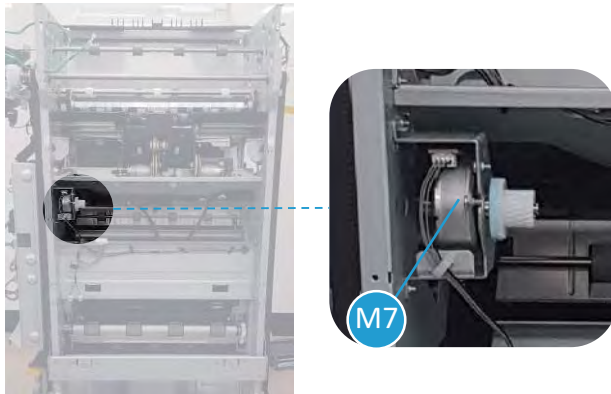


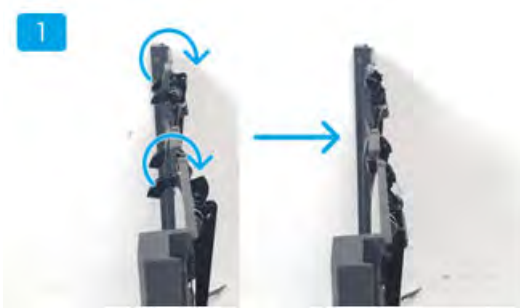
Table 5-32 paper holding unit parts information

Item	Part name	Part number	Orderable <sup>(*)</sup>	Diagnostics	Description
1	Paper holding actuator				Control the height of the main output tray and hold printouts so as not to be scattered
S17	Front paper holding sensor	0604-001393	(*)	113-2141	Detects stacked paper position
S31	Rear paper holding sensor	0604-001393	(*)	113-2142	Detects stacked paper position
S22	Paper holding home sensor	0604-001393	(*)	113-2010	Detects the home position of paper holding actuator
M7	Paper holding motor	JC90-01414A	(*)	113-2510	Lift paper holding actuator up when printouts delivered to the main output tray
2	Left upper cover	JC90-01475B			

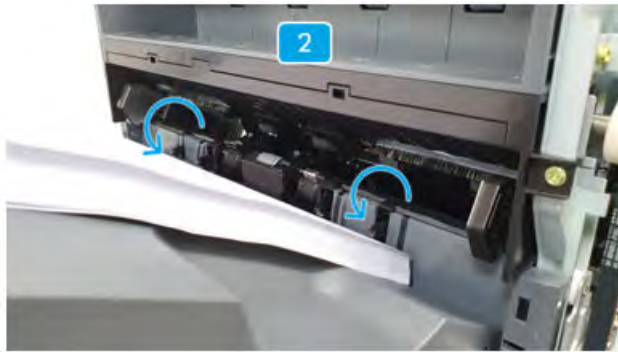
(\*) This part is in ordering system.

## paper holding unit operation

1. When printouts are delivered to the main output tray, a paper holding motor moves paper holding actuator upward to create a paper path to prevent jam (callout1).



2. When printouts are stacked on top of the main output tray, the paper holding actuator goes down to hold them (callout2).



3. As paper stacks up on the main output tray, the paper holding actuator is lifted by papers. The front & rear paper holding sensors make the main output tray moves downward to store more printouts. (callout3)



4. As printouts are stacked on the main output tray, the tray goes down. When it reaches at the end of its moving range (callout 4), the main output tray touches the lower limit sensor. The sensor detects that the main output tray is full of printouts.




## Buffer unit

Learn about the diverter unit of the Stapler/stacker finisher and booklet finisher.

The buffer unit keeps paper inside the unit or moves them to the booklet maker.

The buffer diverter creates a paper path so that paper can move to the buffer unit, and the buffer sensor detects whether paper moved out from the buffer unit. The buffer motor controls buffer roller, and buffer home sensors check the location of buffer rollers. The buffer solenoid holds papers so that they do not fall into the booklet maker while buffering.

---

 **NOTE:** buffering: It is to maintain print speed when users print multiple copies continuously.

The 1st page of a print job stays in the buffer unit for a moment while the previous job is being ejected. After the previous print job was ejected, the 1st and 2nd page of the job move to the ejector unit together.

---

Figure 5-56 Buffer unit overview

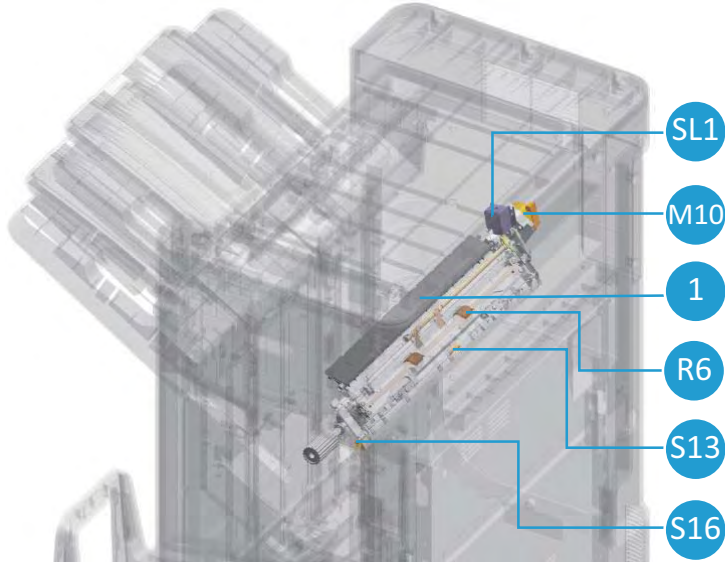


Figure 5-57 Buffer unit detail view - front

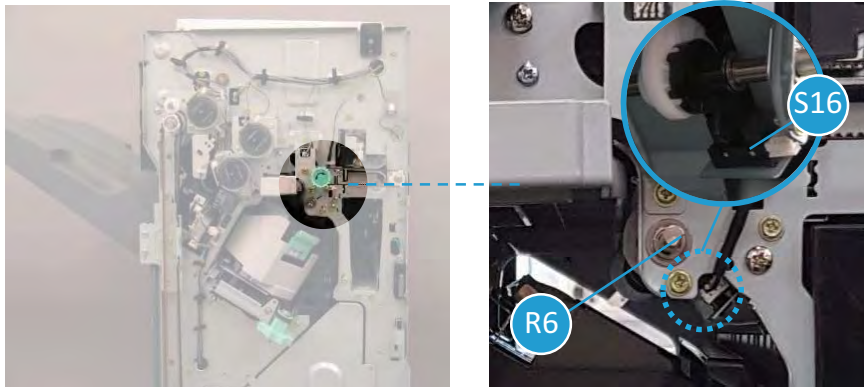


Figure 5-58 Buffer unit detail view - rear

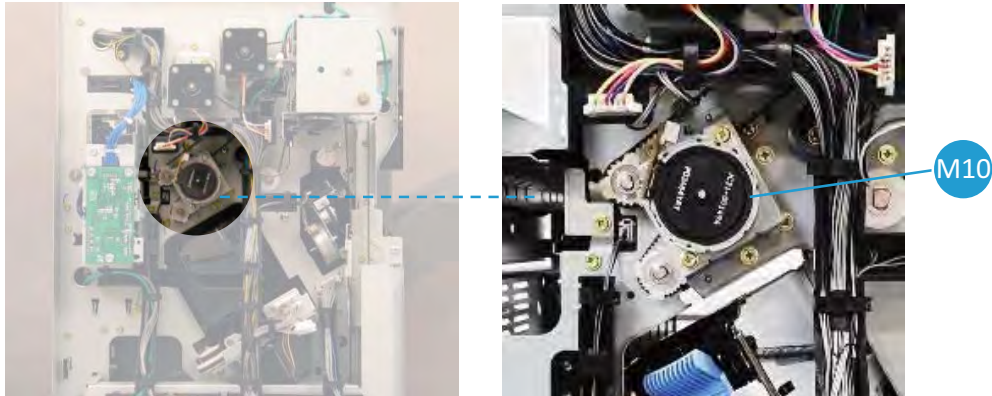




Figure 5-59 Buffer unit detail view - top

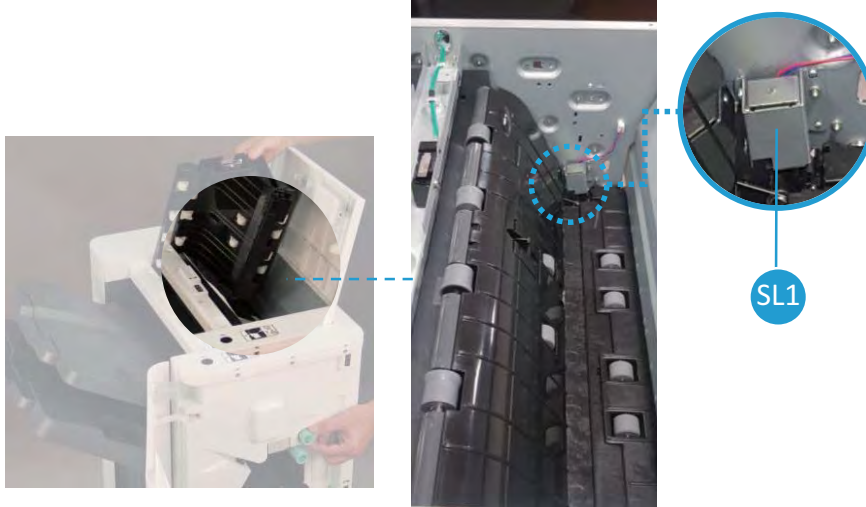


Table 5-33 Buffer unit parts information

Item	Part name	Part number	Orderable <sup>(*)</sup>	Diagnostics	Description
1	Buffer diverter	JC61-07204A			Makes the way to the buffer space
S13	Buffer sensor	JC32-00020A	(*)	113-2100	Detects whether paper has moved out from the buffer unit
S16	Buffer home sensor	0604-001393	(*)	113-2210	Detects the home position of the buffer roller.
M10	Buffer motor	JC93-01152A	(*)	113-2660	Moves paper to the buffer space or the booklet maker
SL1	Buffer solenoid	JC33-00038A	(*)	113-2670	Holds paper to prevent them from falling out to the booklet maker during buffering
R6	Buffer roller	JC66-05161A			Moves paper to the booklet maker or makes the gap so that paper stays in this space.

(\*) This part is in ordering system.

### Buffer unit operation

1. When the buffer motor rotates backward to move the cam, the buffer roller(R6) can have gap and then paper can stay inside the buffer unit
1. When the exit motor rotates backward to drive the main exit roller(R7), paper moves to the buffer unit through the buffer diverter(callout1).



2. The main exit cam motor moves the main exit cam so that the main exit roller(R7) is separated with the idle roller to have a gap, and then paper can stay in this place for a while.



3. When the next sheet comes to the main exit unit, the main exit motor turns the main exit cam so that the main exit roller is attached to the idle roller.



4. The exit motor rotates forward and operates the main exit roller. It makes 2 paper moves to the ejector together.



2. In case of booklet job, the buffer unit moves paper to the booklet maker.
  1. The buffer motor rotates, the buffer roller(R6) is attached to the idle roller.
  2. When paper arrives at the main exit unit, the exit motor rotates backward and moves the main exit roller(R7) so that paper moves to the buffer unit through the buffer diverter.



3. The buffer motor rotates the buffer roller to move paper to the booklet maker.



## Booklet entrance unit

Learn about the Booklet entrance unit of the booklet finisher.

The booklet entrance unit receives paper into the booklet maker. The entrance sensor(S36) detects whether the paper enters the entrance unit. The entrance motor(M15) drives the booklet entrance roller(R10) to move the paper.

Figure 5-60 Booklet entrance unit overview

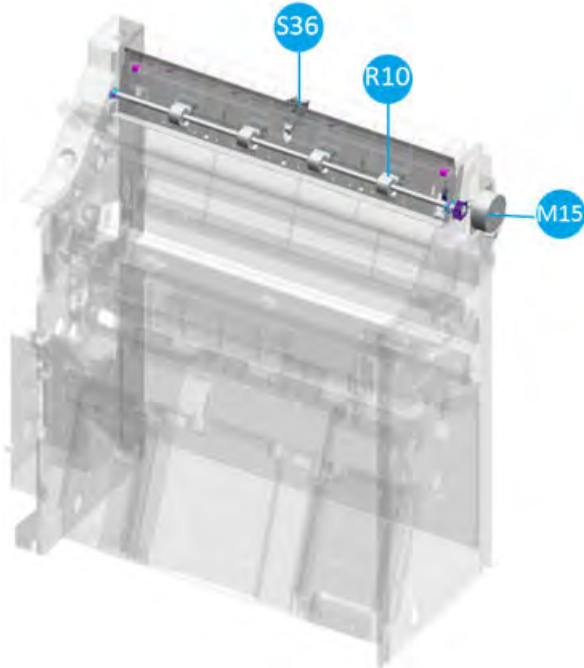


Figure 5-61 Booklet entrance unit detail view



Table 5-34 Entrance unit parts information

Item	Part name	Part number	Orderable <sup>(*)</sup>	Diagnostics	Description
S36	Booklet entrance sensor	0604-001415	(*)	113-3100	Detects whether paper has come into the booklet entrance unit
M15	Booklet entrance motor	JC93-01152A	(*)	113-3500	Drives the booklet entrance roller
R10	Booklet entrance roller	JC66-04717A			Moves paper into the booklet maker

(\*) This part is in ordering system.

## Booklet paddle unit

Learn about the Booklet paddle unit of the booklet finisher.

The booklet paddle unit pushes paper to the booklet end fence by rotating the rubber paddles. The booklet paddle motor (M19) rotates two booklet paddles, and the booklet paddle home sensor(S41) connected to the lower booklet paddle checks the home position of the booklet paddle.

Figure 5-62 Booklet paddle unit overview

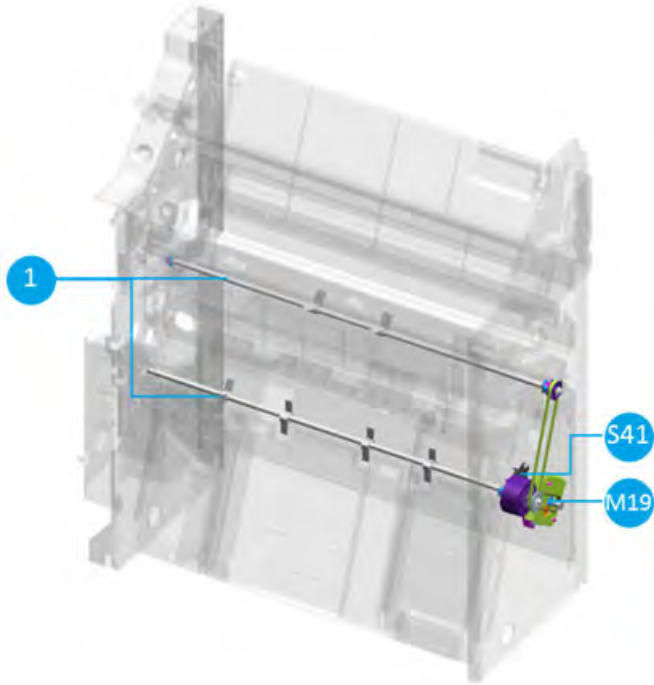


Figure 5-63 Booklet paddle unit detail view

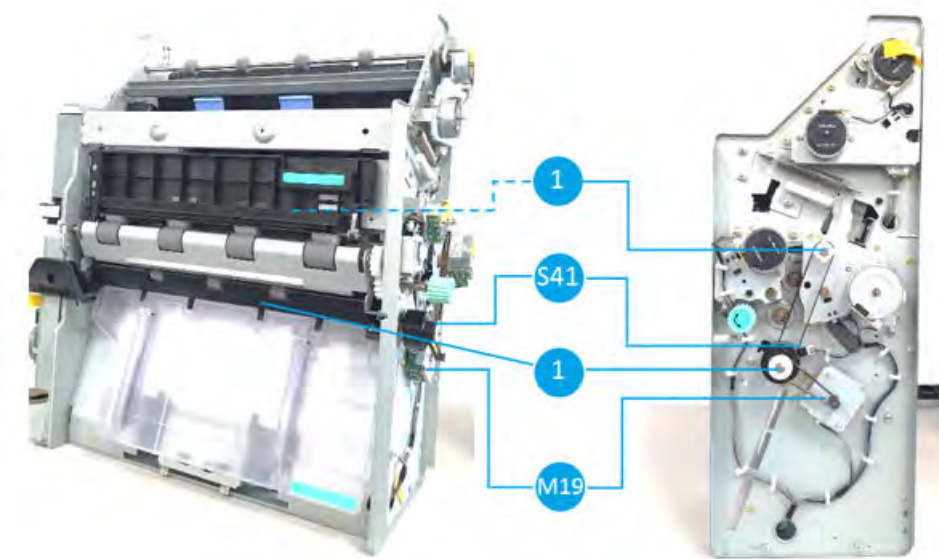


Table 5-35 booklet paddle unit parts information

Item	Part name	Part number	Orderable <sup>(*)</sup>	Diagnostics	Description
1	Upper booklet paddle	JC66-04718A			Moves paper to the booklet end fence unit
1	Lower booklet paddle	JC90-01429A			Moves paper to the booklet end fence unit
		JC61-07225A	(*)		
		JC66-04719A	(*)		

**Table 5-35** booklet paddle unit parts information (continued)

Item	Part name	Part number	Orderable <sup>(*)</sup>	Diagnostics	Description
S41	Booklet paddle home sensor	0604-001393	(*)	113-2590	Check the home position of the booklet paddle
M19	Booklet paddle motor	JC93-01001A	(*)	113-3580	Drives two booklet paddles

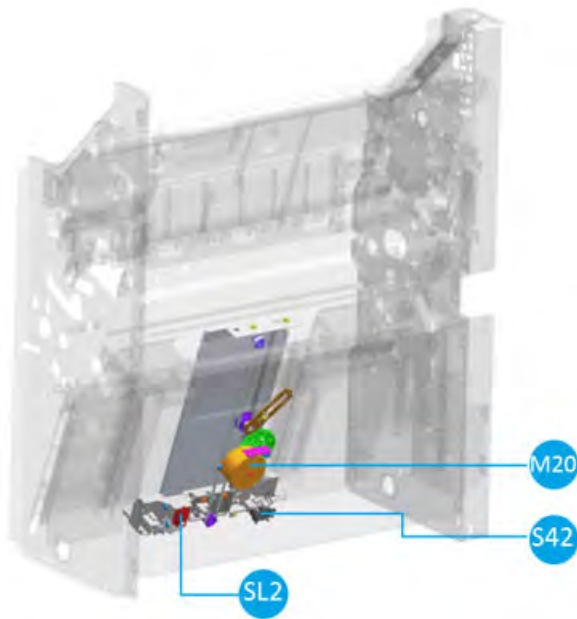
<sup>(\*)</sup> This part is in ordering system.

## Booklet end fence unit

Learn about the Booklet end fence unit of the booklet finisher.

The booklet end fence unit supports paper that enters from the booklet paddle unit, then moves paper to the designated position for folding and stapling. The Booklet end fence motor (M20) moves the booklet end fence up and down. The booklet end fence home sensor (S42) checks the home position of the booklet end fence. The booklet end fence solenoid (SL2) drives the clamp to hold paper that comes into the booklet end fence.

**Figure 5-64** Booklet end fence unit overview



**Figure 5-65** Booklet end fence unit detail view - left

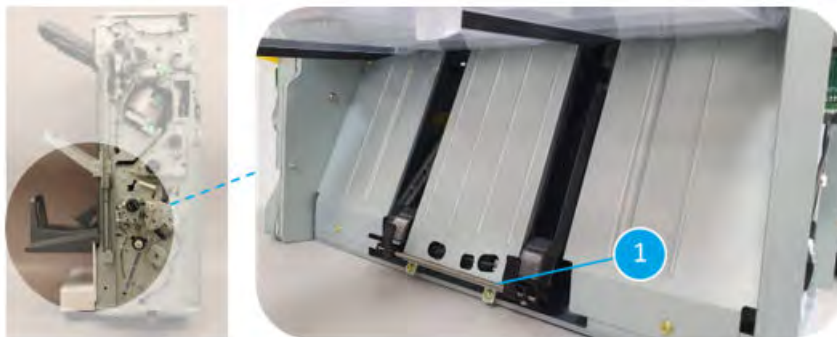


Figure 5-66 Booklet end fence unit detail view - right

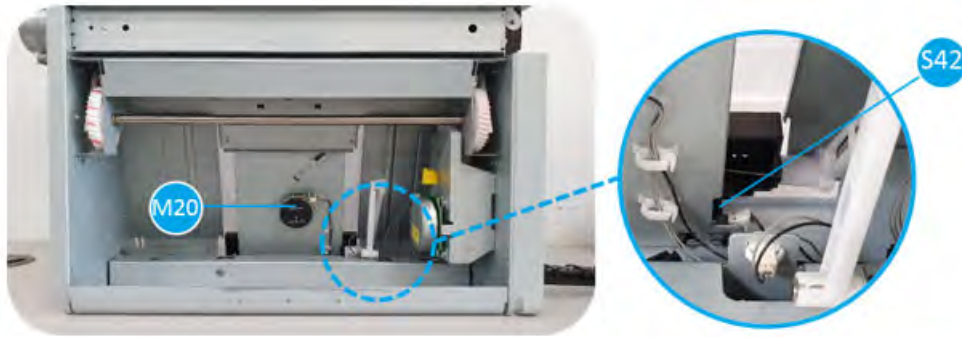


Table 5-36 booklet end fence unit parts information

Item	Part name	Part number	Orderable <sup>(*)</sup>	Diagnostics	Description
1	Booklet end fence	JC90-01432A			Supports paper, then moves it to the designated location to fold or staple
S42	Booklet end fence home sensor	0604-001393	(*)	113-3000	Checks the home position of the booklet end fence
M18	Booklet end fence motor	JC93-01155A	(*)	113-3530	Moves the booklet end fence up and down
Sl2	Booklet end fence solenoid	JC33-00038A	(*)	113-3520	drives the clamp to hold paper that comes into the booklet end fence

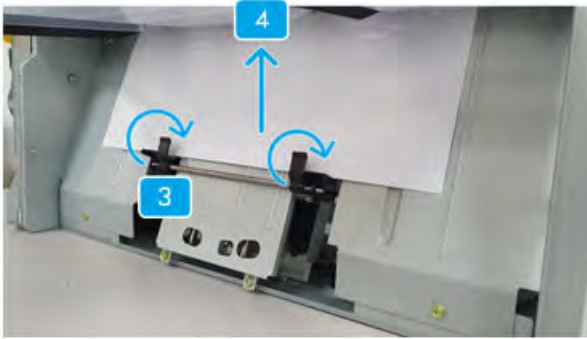
(\*) This part is in ordering system.

### Booklet end fence unit operation

1. The booklet end fence is located at the home position (callout1). When the booklet maker starts its job, the end fence goes to the direction 2.



2. The booklet end fence unit supports paper comes from the booklet paddle unit and holds paper so as not to be scattered(callout3). Then it moves to the certain location to fold or staple it (callout 4).



### Booklet presser unit

Learn about the Booklet presser unit of the booklet finisher.

The booklet presser unit sort print pages that enter to the booklet maker in order. The Booklet presser motor (M16) moves the booklet presser, and the booklet presser home sensor (S37) checks whether the booklet presser is at the home position.

Figure 5-67 Booklet presser unit overview

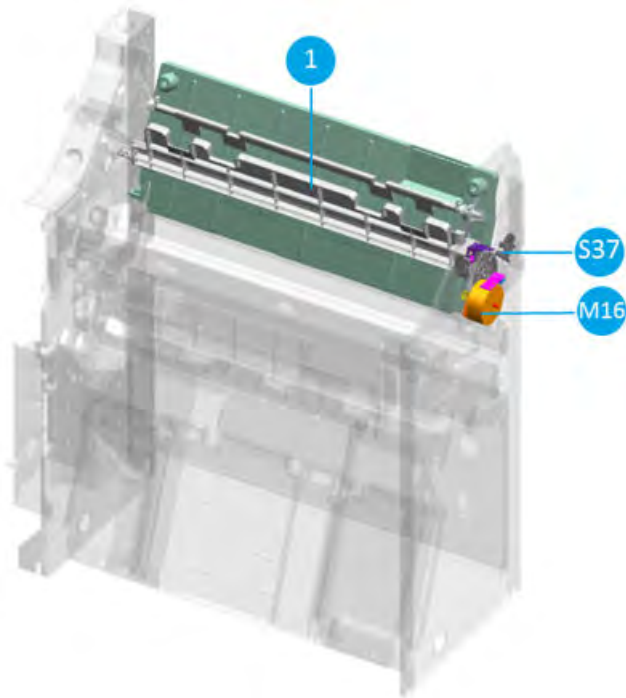




Figure 5-68 Booklet presser unit detail view

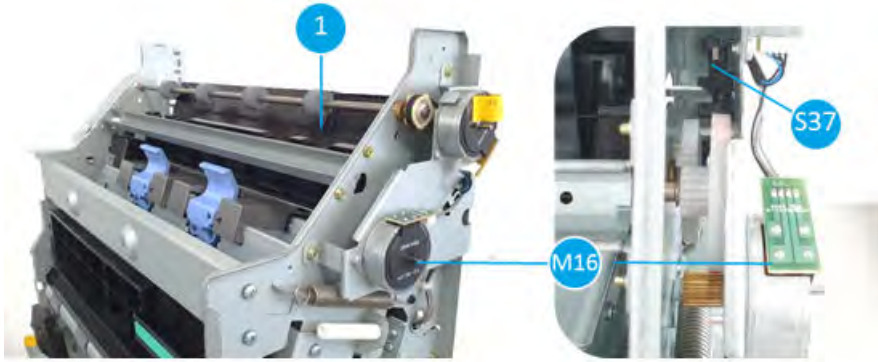


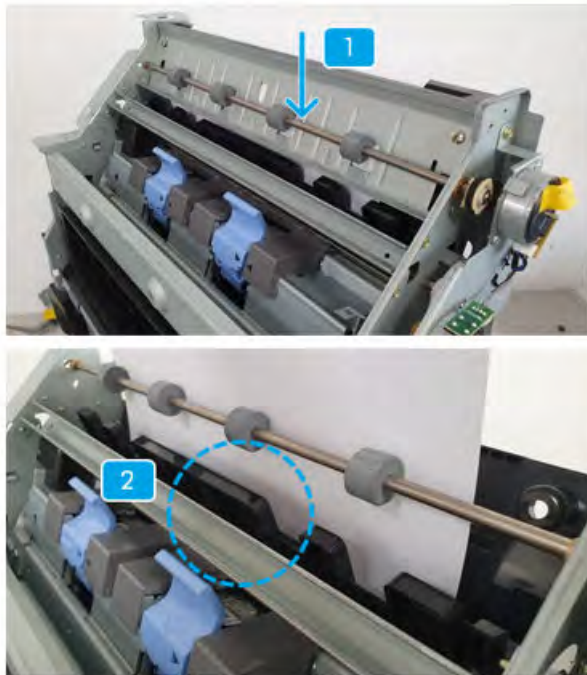
Table 5-37 Booklet presser unit parts information

Item	Part name	Part number	Orderable <sup>(*)</sup>	Diagnostics	Description
1	Booklet presser	JC61-07237A			Accumulates paper from the entrance unit not to be shuffled
S37	Booklet presser home sensor	0604-001393	(*)	113-3130	Checks the home position of the booklet presser
M16	Booklet presser motor	JC93-01155A	(*)	113-3570	Drives the booklet presser

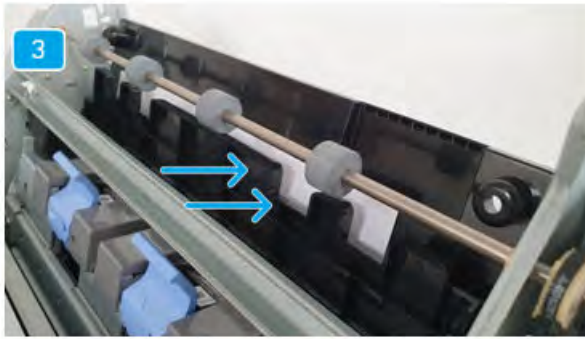
(\*) This part is in ordering system.

### Booklet presser unit operation

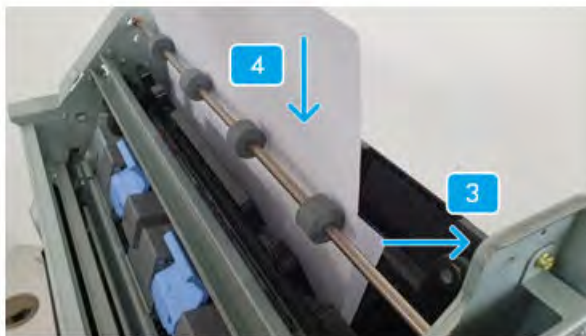
1. Paper comes into the booklet presser unit (callout1). At this time the presser is located on the left side of the finisher (callout 2).



2. After paper exits the entrance roller, the booklet presser hits the end of paper. (callout 3).



3. When a next sheet arrives at the unit, it will fall on the left side of the previous sheet pushed by the booklet presser (callout 4).



## Booklet tamper unit

Learn about the Booklet tamper unit of the booklet finisher.

The booklet tamper unit aligns the left and right side of documents for stapling or folding.

The booklet tamper motor(M23) adjusts the booklet tampers' width according to paper size. The booklet tamper home sensor(S38) checks the home position of the booklet tamper.

Figure 5-69 Booklet tamper unit overview

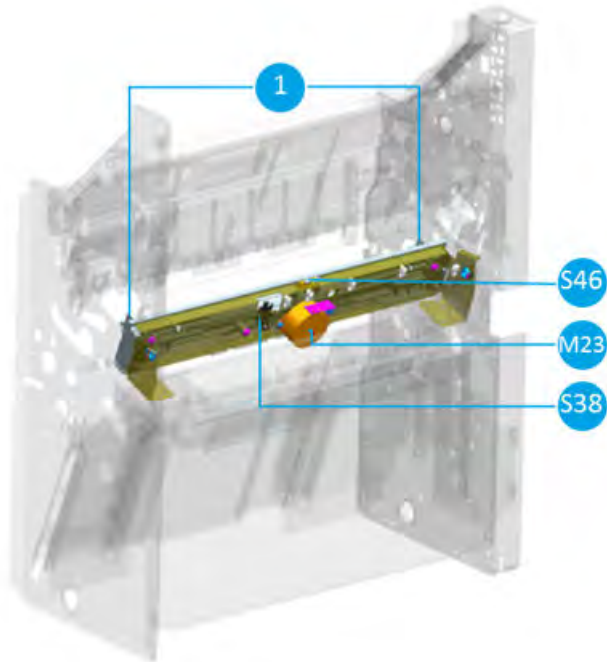


Figure 5-70 Booklet tamper unit detail view

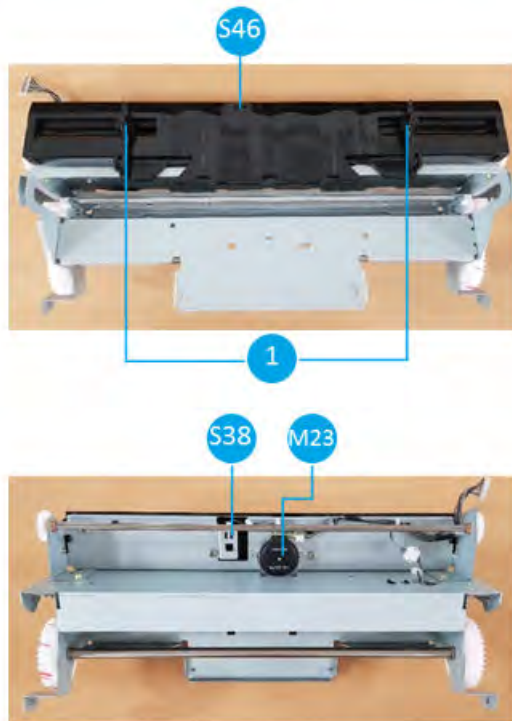


Table 5-38 Booklet tamper unit parts information

Item	Part name	Part number	Orderable <sup>(*)</sup>	Diagnostics	Description
1	Booklet tamper	JC90-01431A			Aligns documents for stapling or folding.

**Table 5-38** Booklet tamper unit parts information (continued)

Item	Part name	Part number	Orderable <sup>(*)</sup>	Diagnostics	Description
S38	Booklet tamper home sensor	0604-001393	(*)	113-3080	Checks the home position of the booklet tamper
M23	Booklet tamper motor	JC93-01155A	(*)	113-3540	Drives the booklet tamper
S46	Booklet tamper sensor	JC32-00020A	(*)	113-3110	

<sup>(\*)</sup> This part is in ordering system.

### Booklet tamper unit operation

- ▲ When a certain amount of paper is collected, the booklet tamper unit hits the left and right sides of the paper to align the paper correctly.



### Booklet stapler unit

Learn about the Booklet stapler unit of the booklet finisher.

Booklet stapler unit is a device installed inside the booklet maker that staples a bundle of aligned documents as a booklet.

There is only 1 option to make a bundle. If the user selects the option, this unit staples at the two location in the middle of stacks.

**Figure 5-71** Booklet staple option

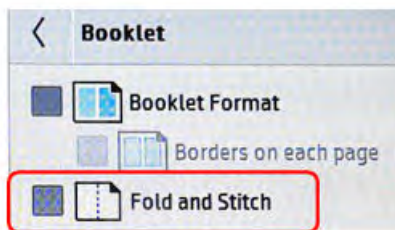


Figure 5-72 Booklet stapler unit overview

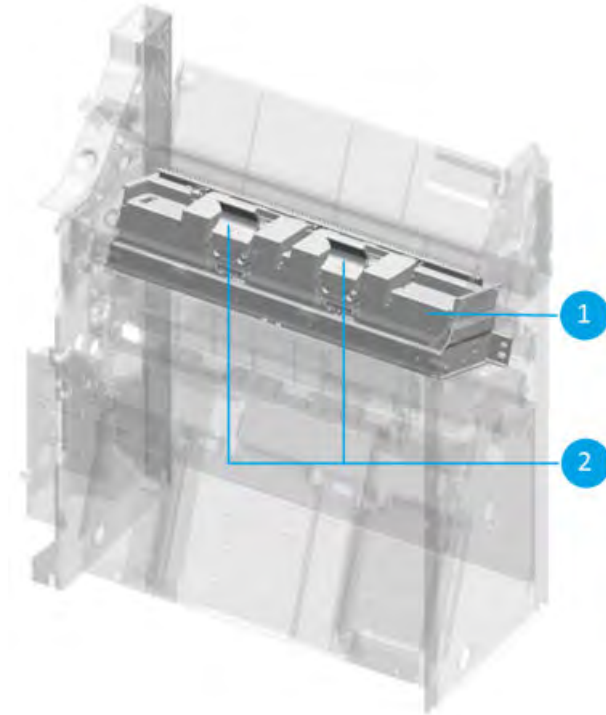


Figure 5-73 Booklet stapler unit detail view

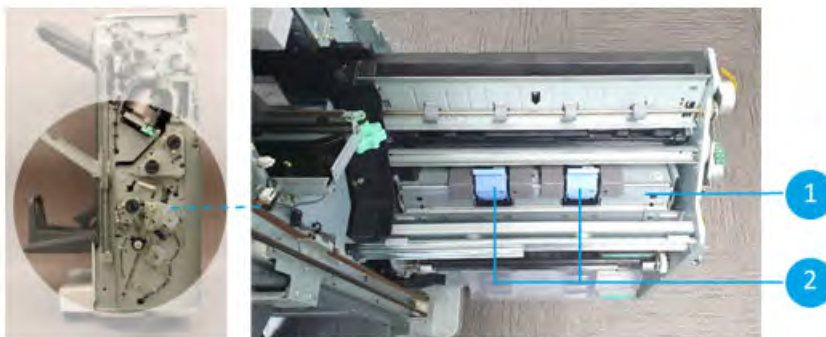


Table 5-39 Booklet stapler unit parts information

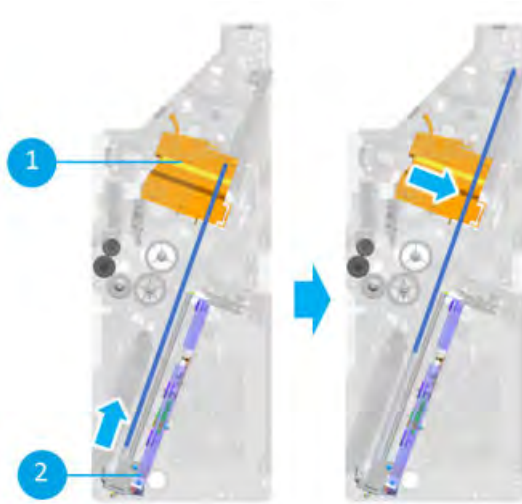
Item	Part name	Part number	Orderable <sup>(*)</sup>	Diagnostics	Description
1	Booklet stapler	JC81-08274B			
2	Booklet stapler cartridge	JC81-09881B	(*)	113-3020 113-3030	

(\*) This part is in ordering system.

### Booklet stapler unit operation

1. When a stack of sheets is collected in booklet end fence unit, the booklet end fence (callout 2) changes its location to be stapled.

2. The booklet stapler(callout1) staples at the middle of stacks.

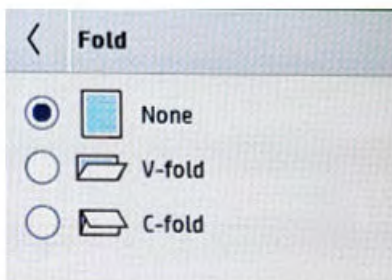


## Booklet fold unit

Learn about the Booklet fold unit of the booklet finisher.

The booklet fold unit is a device installed inside the booklet maker that folds a bundle of aligned documents as a booklet. This unit consists of 2 types of blades: blade and c-fold blade. So, it creates two types of output.

Figure 5-74 Fold options



The booklet blade motor (M22) drives the booklet blades and lightly folds the stack of paper. The folded paper passes through the booklet fold rollers to be fully folded. The booklet blade home sensor (S45) checks the home position of the booklet blade, and the booklet fold motor (M21) drives the rollers that enable folding.

In case of c-fold, the booklet c-fold blade motor(M17) drives the booklet c-fold blade and lightly folds the stack of paper once more. The folded paper passes through the booklet c-fold roller to be fully folded. The booklet c-fold blade home sensor(S39) checks the home position of the c-fold blade.

Figure 5-75 Booklet fold unit overview – right-rear

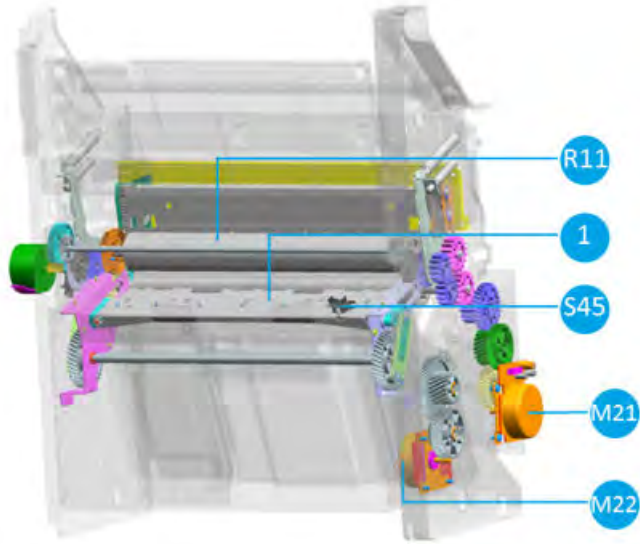


Figure 5-76 Booklet fold unit overview – left-front

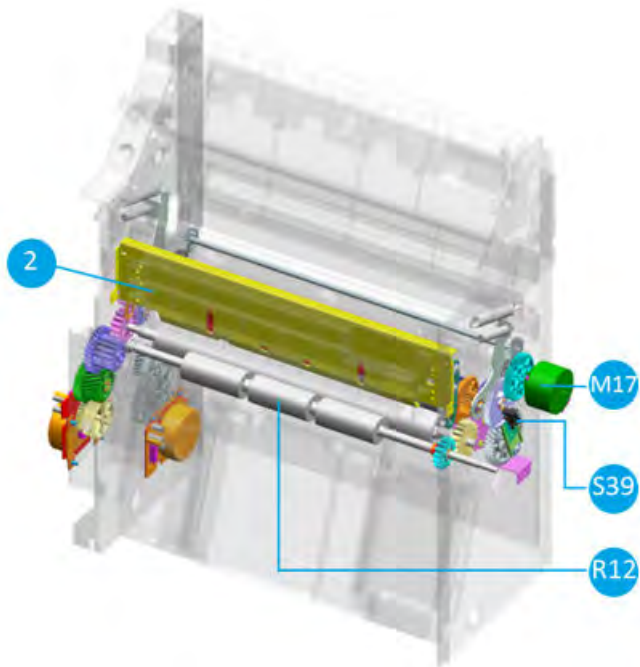


Figure 5-77 Booklet fold unit detail view - right

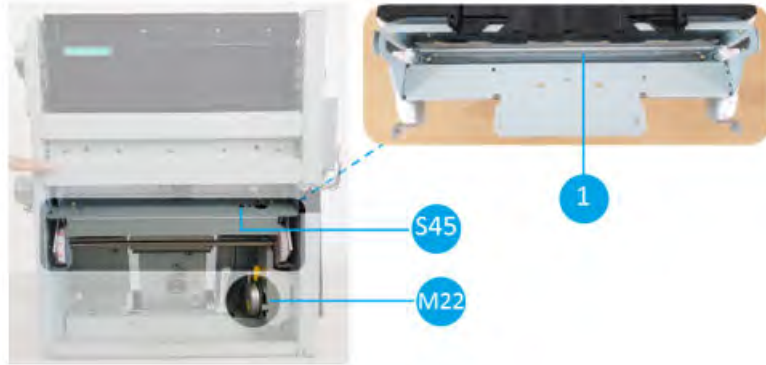


Figure 5-78 Booklet fold unit detail view – left

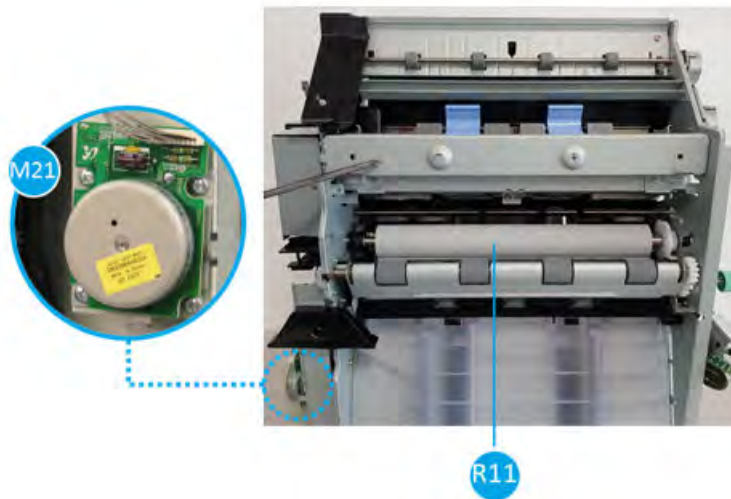
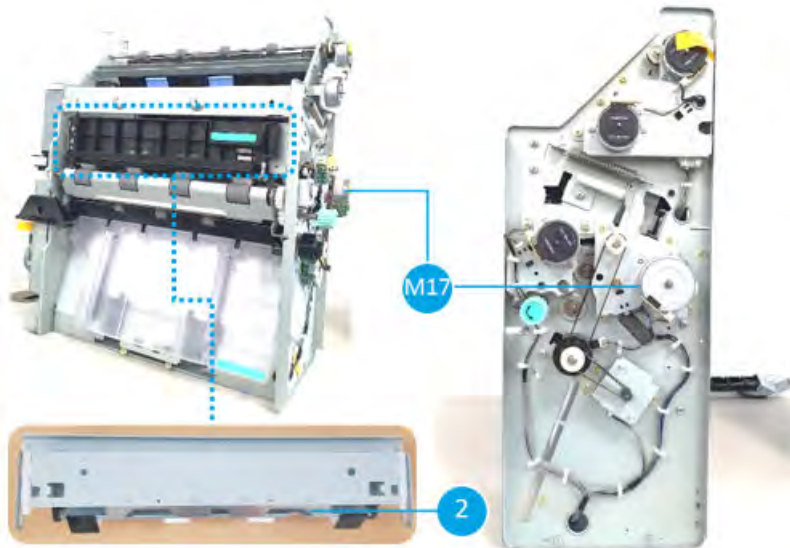


Figure 5-79 Booklet fold unit detail view – left-front





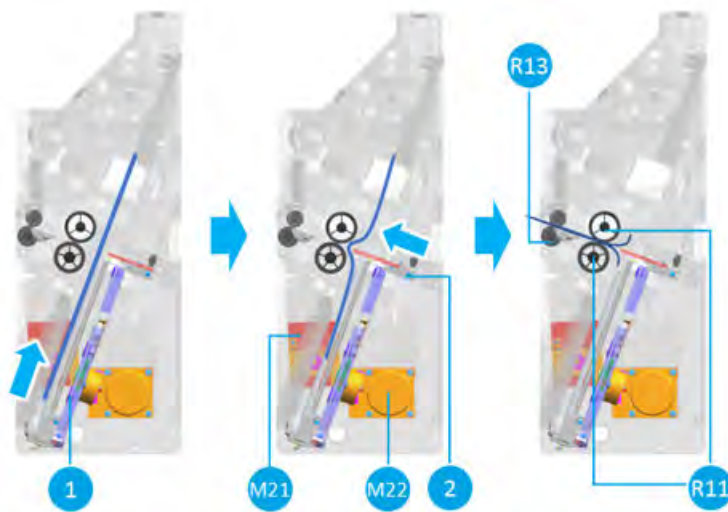
**Table 5-40 Booklet fold unit parts information**

Item	Part name	Part number	Orderable <sup>(*)</sup>	Diagnostics	Description
1	Booklet blade	JC93-01163A			Pushes a stack of paper to fold.
S45	Booklet blade home sensor	0604-001393	(*)	113-3040	Checks the home position of the booklet blade.
M22	Booklet blade motor	JC31-00144A	(*)	113-3550	Drives the booklet blade
M21	Booklet fold motor	JC31-00144A	(*)	113-3510	Drives the booklet roller and c-fold blade
R11	Booklet fold roller	JC66-04748A			Presses a stack of paper to be fully folded
2	Booklet c-fold blade	JC61-07366A			Pushes a stack of paper to fold for the c-fold task
S39	Booklet c-fold blade home sensor	0604-001393	(*)	113-3050	Checks the home position of the booklet c-fold blade
M17	Booklet c-fold blade motor	JC93-01154A	(*)	113-3590	Drives the booklet c-fold blade
R12	Booklet c-fold roller	JC66-04744A	(*)		In case of c-fold, presses a stack of paper to fold completely.

<sup>(\*)</sup> This part is in ordering system.

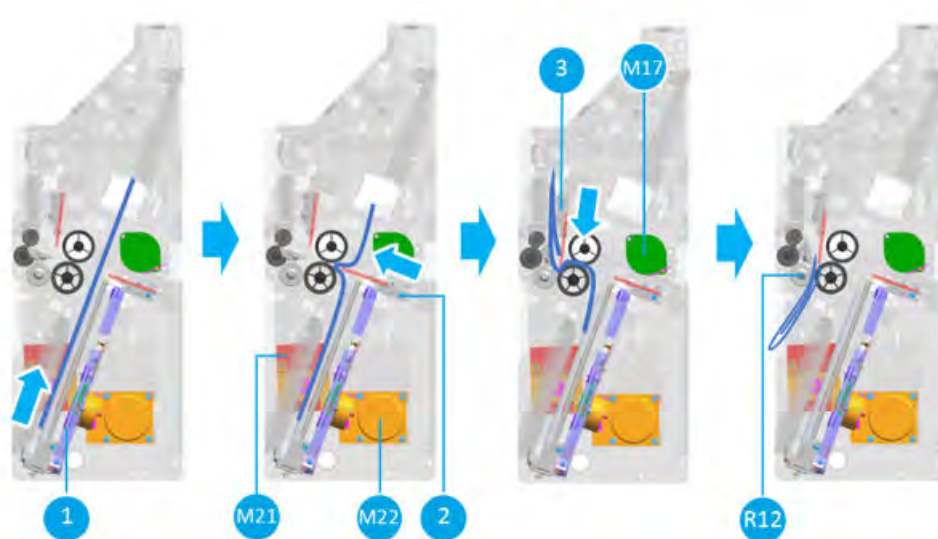
### Booklet fold unit operation

1. In case of v-fold.



1. After a stack of paper is collected at a booklet end fence unit, the booklet end fence(callout1) moves to a designated location.
2. The booklet blade motor(M22) drives the booklet blade(callout2) to push the center of paper.
3. Paper enters between the booklet fold rollers(R11) by the booklet blade and it is completely folded between the rollers.
4. The folded paper stack is discharged to the booklet output tray via the booklet exit roller(R13).

## 2. In case of c-fold



1. After a stack of paper is collected at a booklet end fence unit, the booklet end fence(callout1) is moved to a designated location.
2. The booklet blade motor(M22) drives the booklet blade(callout2) to push one-third of paper.
3. The paper enters between the booklet fold rollers(R11) by the booklet blade and it is completely folded between the rollers.
4. The folded sheets move to a location where they will be c-folded by a booklet diverter.
5. The booklet c-fold blade motor(M17) drives the booklet c-fold blade(callout3), pokes two-thirds of paper.
6. Paper enters between the booklet c-fold roller(R12) and the booklet fold roller by the booklet c-fold blade and it is completely folded between the rollers.

### Booklet diverter unit

Learn about the Booklet diverter unit of the booklet finisher.

The booklet diverter unit determines a paper path to allow the stack of folded paper to exit to the booklet output tray during the v-fold. In case of c-fold, it makes another paper path so folded sheets can move to a location that can be c-folded. The booklet diverter motor(M18) drives the booklet diverter, and the booklet diverter home sensor(S40) checks whether the booklet diverter is at the home position.

Figure 5-80 Booklet diverter unit overview

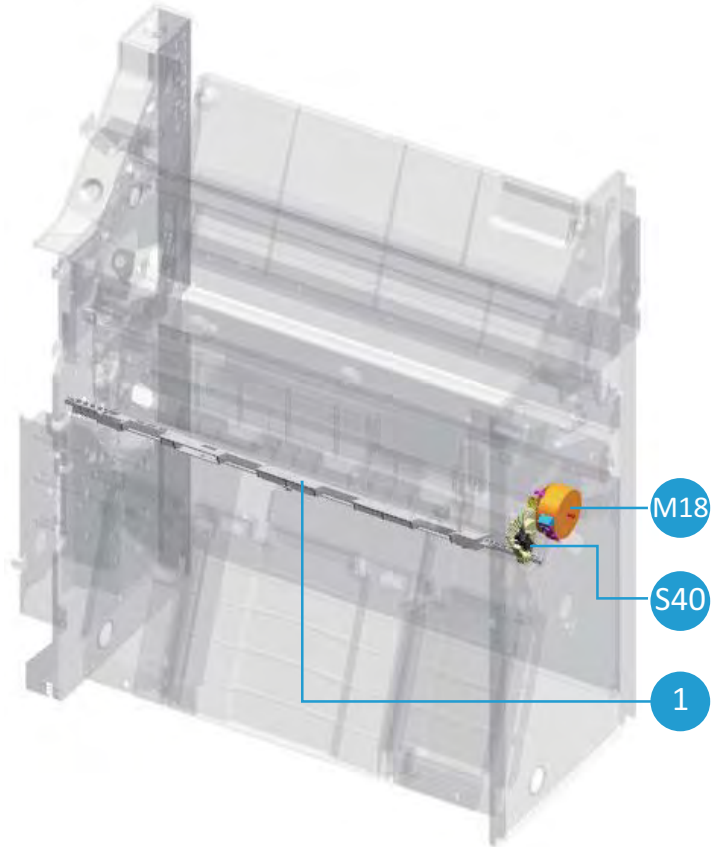
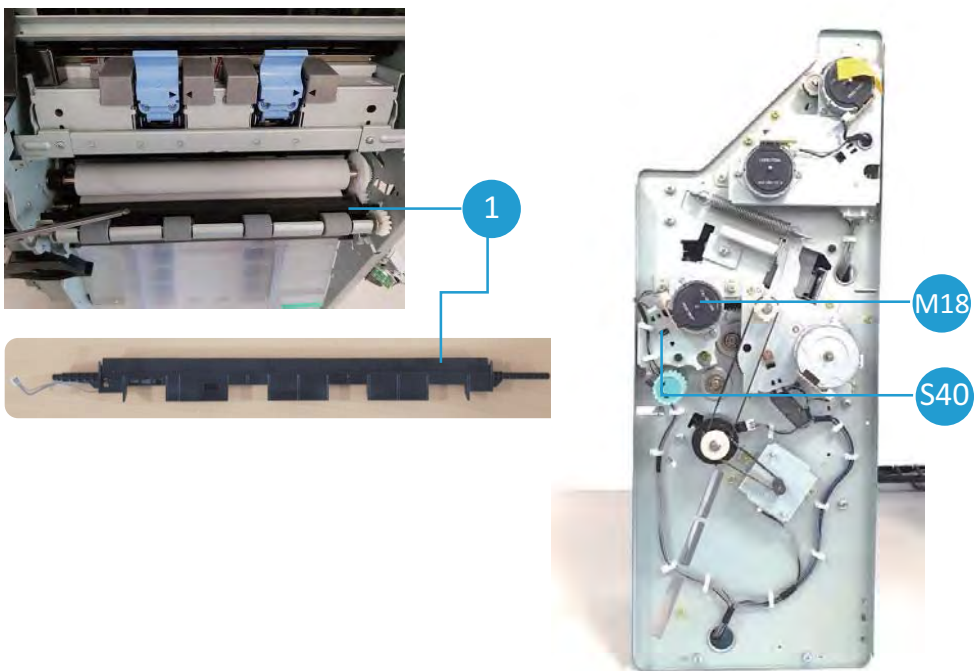


Figure 5-81 Booklet diverter unit detail view – left-front



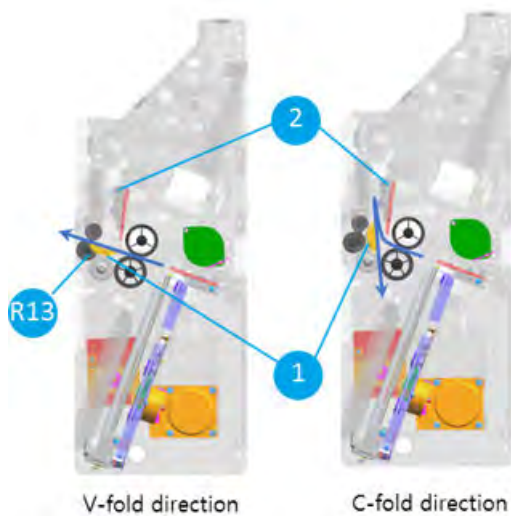
**Table 5-41 Booklet diverter unit parts information**

Item	Part name	Part number	Orderable <sup>(*)</sup>	Diagnostics	Description
1	Booklet diverter	JC90-01398A			Determines the paper path for either the booklet exit unit or the location for c-fold
S40	Booklet diverter home sensor	0604-001415	(*)	113-3060	Checks the home position of the booklet diverter
M18	Booklet diverter motor	JC93-01153A	(*)	113-3560	Drives the booklet diverter

<sup>(\*)</sup> This part is in ordering system.

### Booklet diverter unit operation

1. In case of v-fold, the booklet diverter(callout1) determines the paper path so that the folded sheets exit to the booklet exit unit and into the booklet output tray.
2. On the other hand, in c-fold, it makes another paper path to fold it by c-fold blade(callout2).



### Booklet exit unit

Learn about the Booklet exit unit of the booklet finisher.

The booklet exit unit ejects a stack of v-fold paper to the booklet output tray unit. The booklet exit sensor(S44) detects paper entry into the booklet exit unit, and the booklet fold motor(M19) drives the booklet exit roller(R4) to discharge paper.

Figure 5-82 Booklet exit unit overview – front-right

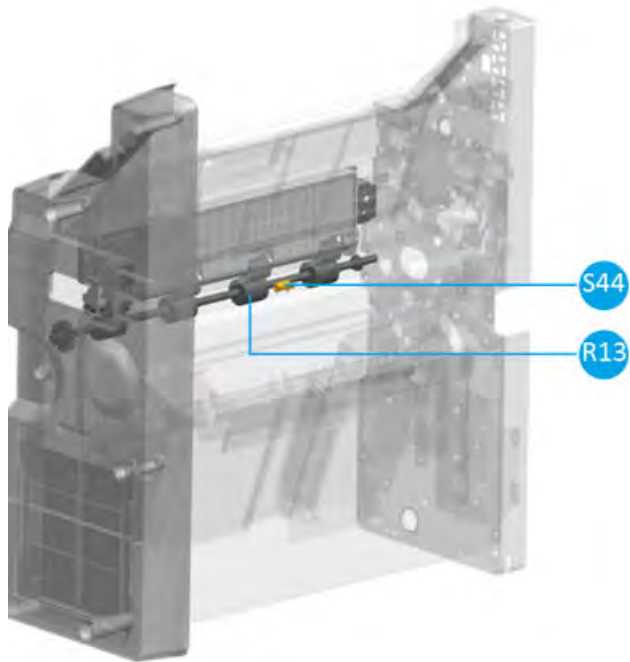


Figure 5-83 Booklet exit unit detail view

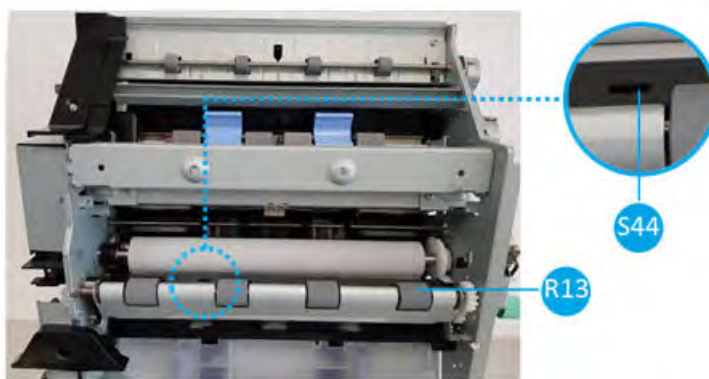


Table 5-42 Booklet exit unit parts information

Item	Part name	Part number	Orderable <sup>(*)</sup>	Diagnostics	Description
S44	Booklet exit sensor	JC32-00020A	(*)	113-3120	Check whether paper has come into the booklet unit
M21	Booklet fold motor	JC31-00144A	(*)	113-3510	Drives the booklet exit roller
R13	Booklet exit roller	JC66-04721A	(*)		Moves paper to the booklet output tray unit

(\*) This part is in ordering system.

## Booklet output tray unit

Learn about the Booklet output tray unit of the booklet finisher.

The booklet output tray unit is the place where the ejected paper is stacked. The booklet output tray sensor(S43) detects whether paper is on the booklet output tray or not.

Figure 5-84 Booklet output tray unit overview

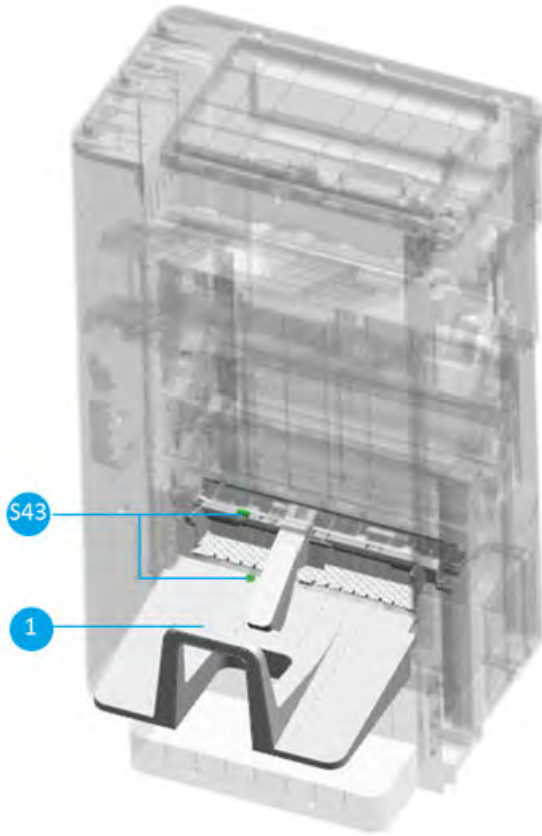


Figure 5-85 Booklet output tray unit detail view

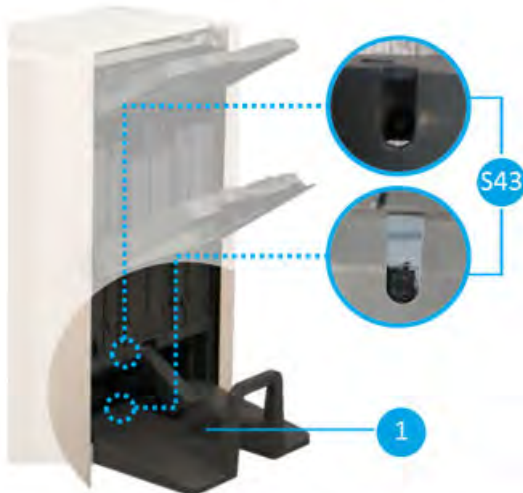


Table 5-43 Booklet output tray unit parts information

Item	Part name	Part number	Orderable <sup>(*)</sup>	Diagnostics	Description
1	Booklet output tray	JC61-07253B	(*)		Stores paper stacks from the booklet exit unit
		JC63-04978B	(*)		

Table 5-43 Booklet output tray unit parts information (continued)

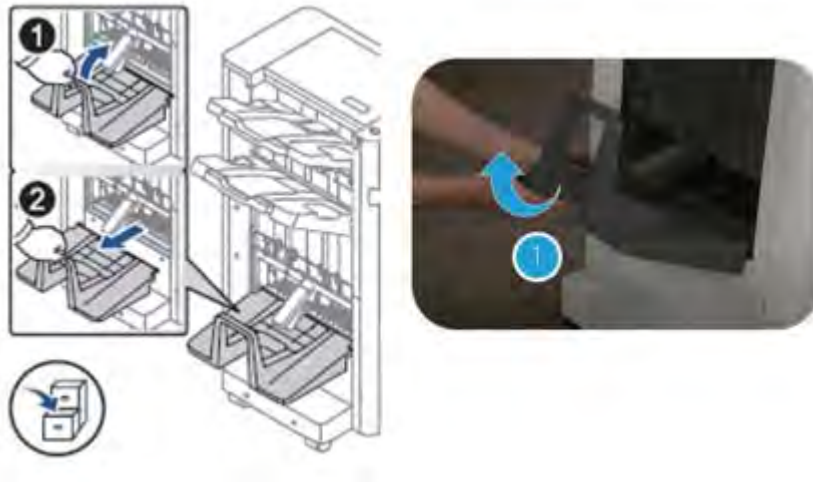
Item	Part name	Part number	Orderable <sup>(*)</sup>	Diagnostics	Description
S43	Booklet output tray sensor	JC82-01039A	(*)	113-2150	Detects whether paper is on the booklet output tray.pa

(\*) This part is in ordering system.

### How to print large number of booklets

Y1G07A Booklet finisher is support available to print a large number of booklets.

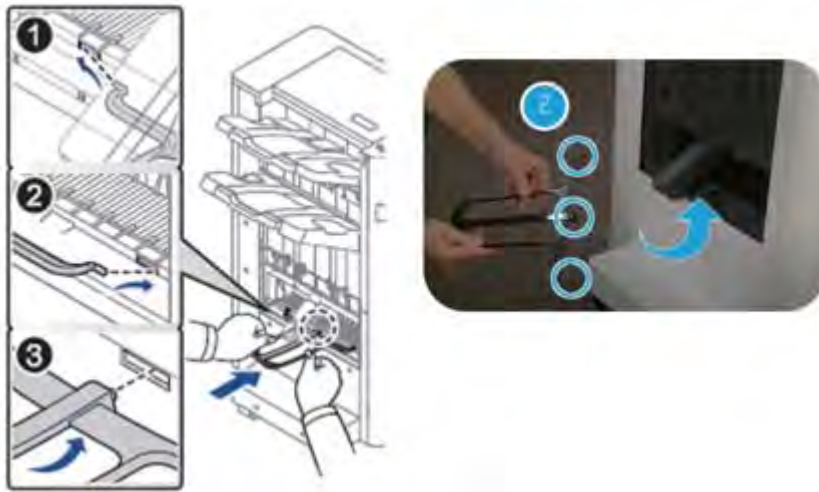
1. Remove the booklet output tray (Callout 1).



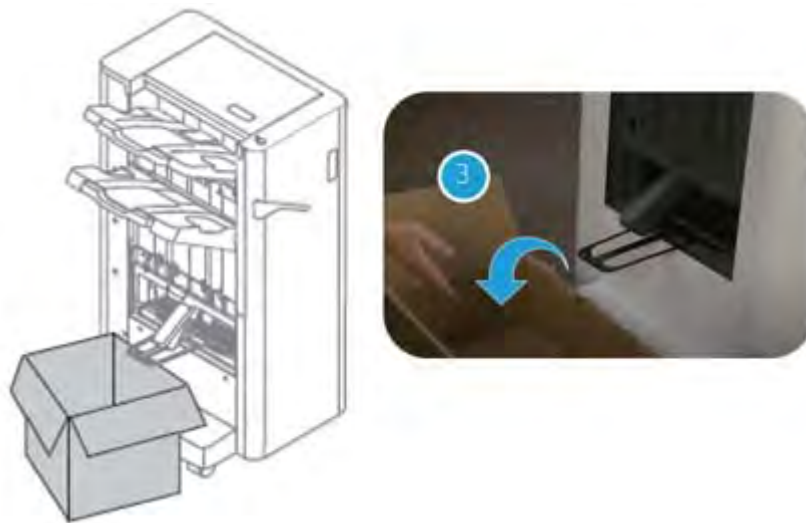
2. Install the booklet sub tray at the booklet output (Callout 2).

 **NOTE:**

- The booklet sub tray is included in the Booklet finisher product box. If a user misses the part, order and use the new part.
- Booklet sub tray part number : JC61-07088A



- 3. Install a box to store printouts(Callout 3).



### PCA connection information

Learn about the PCA connection information.



Figure 5-86 Stapler / Stacker finisher system - PCA connection information

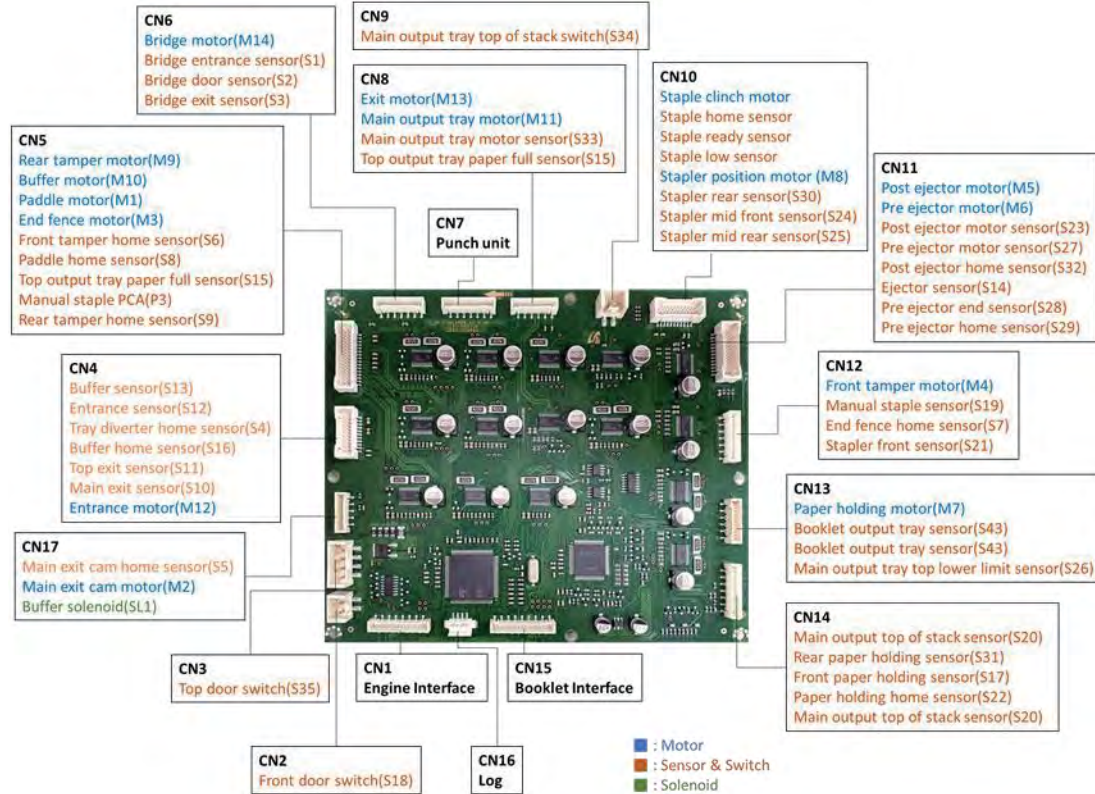


Table 5-44 Stapler/Stacker finisher system - PCA connectors, parts, and diagnostics information

Connector	Motor	Diagnostics	Sensor, Switch	Diagnostics	Solenoid, PCA	Diagnostics
CN1					MainPCA interface	
CN2			Front door switch(S35)	113-2181		
CN3			Top door switch(S18)	113-2182		
CN4	Entrance motor(M12)	113-2570	Buffer sensor(S13)	113-2100		
			Entrance sensor(S12)	113-2080		
			Tray diverter home sensor(S4)	113-2020		
			Buffer home sensor(S16)	113-2210		
			Top exit sensor(S11)	113-2091		
			Main exit sensor(S10)	113-2090		
CN5	Rear tamper motor(M9)	113-2640	Front tamper home sensor(S6)	113-2120	Manual staple PCA(P3)	
	Buffer motor(M10)	113-2660	Paddle home sensor(S8)	113-2060		
	Paddle motor(M1)	113-2600	Top output tray paper full sensor(S15)	113-2145		

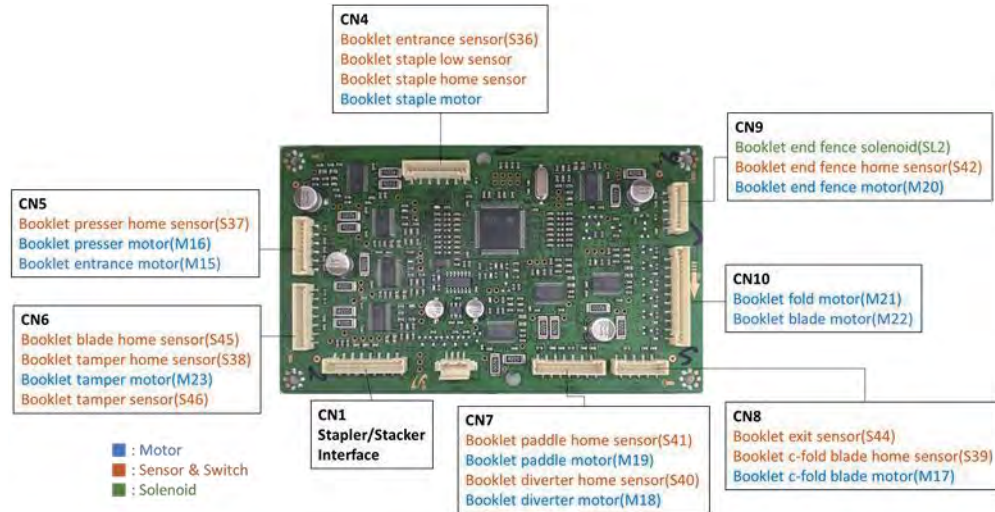
**Table 5-44 Stapler/Stacker finisher system - PCA connectors, parts, and diagnostics information (continued)**

Connector	Motor	Diagnostics	Sensor, Switch	Diagnostics	Solenoid, PCA	Diagnostics
	End fence motor(M3)	113-2590	Rear tamper home sensor(S9)	113-2130		
CN6	Bridge motor(M14)	113-2560	Bridge entrance sensor(S1)	113-2070		
			Bridge door sensor(S2)	113-2180		
			Bridge exit sensor(S3)	113-2143		
CN7					Punch unit	
CN8	Exit motor(M13)	113-2580	Main output tray motor sensor(S33)	113-2143		
	Main output tray motor(M11)	113-2610	Top output tray paper full sensor(S15)	113-2145		
CN9			Main output tray top of stack switch(S34)	113-2190		
CN10	Staple clinch motor		Staple home sensor			
	Stapler position motor (M8)	113-2620	Staple ready sensor			
			Staple low sensor			
			Stapler rear sensor(S30)	113-2110		
			Stapler mid front sensor(S24)	113-2112		
			Stapler mid rear sensor(S25)	113-2111		
CN11	Ejector2 motor(M5)	113-2540	Ejector2 motor sensor(S23)	113-2041		
	Ejector1 motor(M6)	113-2530	Ejector1 motor sensor(S27)	113-2032		
			Ejector2 home sensor(S32)	113-2040		
			Ejector sensor(S14)	113-2170		
			Ejector1 end sensor(S28)	113-2030		
			Ejector1 home sensor(S29)	113-2031		
CN12	Front tamper motor(M4)	113-2630	Manual staple sensor(S19)	113-2160		
			End fence home sensor(S7)	113-2050		
			Stapler front sensor(S21)	113-2113		
CN13	Paper holding motor(M7)	113-2510	Booklet output tray sensor(S43)	113-2150		

**Table 5-44** Stapler/Stacker finisher system - PCA connectors, parts, and diagnostics information (continued)

Connector	Motor	Diagnostics	Sensor, Switch	Diagnostics	Solenoid, PCA	Diagnostics
CN14			Main output top of stack sensor(S20)	113-2140		
			Rear paper holding sensor(S31)	113-2142		
			Front paper holding sensor(S17)	113-2141		
			Paper holding home sensor(S22)	113-2010		
			Main output top of stack sensor(S20)	113-2140		
CN15					Booklet interface	
CN16					Log	
CN17	Main exit cam motor(M2)	113-2500	Main exit cam home sensor(S5)	113-2000		
				Buffer solenoid(SL1)	113-2670	

**Figure 5-87** Booklet finisher system - PCA connection information



**Table 5-45** Booklet finisher system - PCA connectors, parts, and diagnostics information

Connector	Motor	Diagnostics	Sensor	Diagnostics	Switch, Solenoid, PCA	Diagnostics
CN1						Stapler/Stacker interface
CN4	Booklet staple motor		Booklet entrance sensor(S36)	113-3100		
			Booklet staple low sensor			


**Table 5-45** Booklet finisher system - PCA connectors, parts, and diagnostics information (continued)

Connector	Motor	Diagnostics	Sensor	Diagnostics	Switch, Solenoid, PCA	Diagnostics
			Booklet staple home sensor			
CN5	Booklet presser motor(M16)	113-2580	Booklet presser home sensor(S37)	113-3130		
			Booklet entrance motor(S13)	113-2100		
CN6	Booklet tamper motor(M23)	113-3540	Booklet blade home sensor(S45)	113-3040		
			Booklet tamper home sensor(S38)	113-3080		
			Booklet tamper sensor(S46)	113-3110		
CN7	Booklet paddle motor(M19)	113-3580	Booklet paddle home sensor(S41)	113-3090		
	Booklet diverter motor(M18)	113-3560	Booklet diverter home sensor(S40)	113-3060		
CN8	Booklet c-fold blade motor(M17)	113-3590	Booklet exit sensor(S44)	113-3120		
			Booklet c-fold blade home sensor(S39)	113-3050		
CN9	Booklet end fence motor(M20)	113-3530	Booklet end fence home sensor(S42)	113-3000	Booklet end fence solenoid(SL2)	
CN10	Booklet fold motor(M21)	113-3510				113-3520
	Booklet blade motor(M22)	113-3550				

## Service approach

Learn about the service approach of the inner finisher.

---

 **CAUTION:** When working on the product, do not pick up the unit by the output tray, which will detach under the weight of the product.

---

## Precautions when replacing parts

Learn about precautions when replacing parts.

## Precautions when replacing parts

Learn about precautions when replacing parts.

## Precautions when assembling and disassembling

- Use only HP approved replacement parts. Make sure that the part number, product name, voltage, and current or temperature ratings are correct. Failure to do so might result in damage to the machine, circuit overload, fire, or electric shock.
- Do not make unauthorized changes or additions to the printer. Unauthorized changes might cause the printer to malfunction and create electric shock or fire hazards.
- Use caution when dismantling the unit. Take note of the location of each screw or other part. This printer contains different kinds of screws. Using the wrong screw might lead to system failure, short circuit or electric shock.
- Do not disassemble the laser scanner assembly. Once the laser scanner assembly is disassembled, dust might enter the mirror chamber and will seriously degrade print quality. There are no serviceable parts inside the laser scanner assembly.
- Regularly check the condition of the power cable, plug and socket. Bad contacts might lead to overheating and fire. Damaged cables might lead to electric shock or unit malfunction.

## Precautions when handling PCAs

Static electricity might damage a PCA. Use approved, anti-static precautions when handling or storing a PCA. Service personnel should use grounded ESD straps and/or mats when handling PCAs.

- Precautions when moving and storing a PCA
  - Keep PCA in a conductive case, anti-static bag, or wrapped in aluminum foil.
  - Do not store a PCA where it is exposed to direct sunlight.
- Precautions when replacing a PCA
  - Disconnect power cables before disconnecting other cables.
  - Do not touch any soldered connections, connector terminals, or other electronic parts when handling insulated parts.
- Precautions when checking a PCA
  - Touch a grounded area of the printer chassis to discharge static electric charge before touching a PCA.
  - Do not touch a PCA with bare hands or metal objects. Doing so might create a short circuit or cause electric shock. Use caution when handling a PCA with moving parts such as sensors, motors, or lamps, as they might become very hot.

- Use caution when fitting and removing screws. Watch for hidden screens. Make sure that the correct screw is used and make sure that when toothed washers are removed, they are refitted in their original positions.
- Place the product on an ESD workstation or mat, or use an ESD strap (if one is available). If an ESD workstation, mat, or strap is not available, ground yourself by touching the sheet-metal chassis *before* touching an ESD-sensitive part.

### Releasing plastic latches

Many of the parts are held in place with plastic latches. The latches might easily break. Be careful when releasing them . To remove such parts, press the hook end of the latch away from the part to which it is latched.

### Precautions when handling PCA

Static electric might damage a PCA. Use approved, anti-static precautions when handling or storing a PCA. Service personnel should use grounded ESD straps and/or mats when handling PCAs.

- Precautions when moving and storing a PCA
  - Keep PCA in a conductive case, anti-static bag, or wrapped in aluminum foil.
  - Do not store a PCA where it is exposed to direct sunlight.
- Precautions when replacing a PCA
  - Disconnect power cables before disconnecting other cables.
  - Do not touch any soldered connections, connector terminals, or other electronic parts when handling insulated parts.
- Precautions when checking a PCA
  - Touch a grounded area of the printer chassis to discharge static electric charge before touching a PCA.
  - Do not touch a PCA with bare hands or metal objects. Doing so might create a short circuit or cause electric shock. Use caution when handling a PCA with moving parts such as sensors, motors, or lamps, as they might become very hot.
  - Use caution when fitting and removing screws. Watch for hidden screens. Make sure that the correct screw is used and make sure that when toothed washers are removed, they are refitted in their original positions.
  - Place the product on an ESD workstation or mat, or use an ESD strap (if one is available). If an ESD workstation, mat, or strap is not available, ground yourself by touching the sheet-metal chassis *before* touching an ESD-sensitive part.

### Releasing plastic latches

Learn about releasing plastic latches.

Many of the parts are held in place with plastic latches. The latches can break easily; release them carefully. To remove such parts, press the hook end of the latch away from the part to which it is latched.



## Before performing service

Learn what to do before performing service.

- Remove all paper from the product.
- Turn off the power using the power button.
- Unplug the power cable and interface cable or cables.
- Place the product on an ESD workstation or mat, or use an ESD strap (if one is available). If an ESD workstation, mat, or strap is not available, ground yourself by touching the sheet-metal chassis *before* touching an ESD-sensitive part.
- Remove the toner cartridges.
- Remove the Tray 2 cassette.

## ESD precautions

Learn the importance of electrostatic discharge.



### CAUTION:



Some parts are sensitive to electrostatic discharge (ESD). Look for the ESD reminder when removing printer parts. Always perform service work at an ESD-protected workstation or mat. If an ESD workstation or mat is not available, touch the sheet-metal chassis to provide a static ground *before* touching an ESD-sensitive assembly.

Protect the ESD-sensitive assemblies by placing them in ESD pouches when they are out of the printer.

## After performing service

Learn what to do after performing service.

- Verify that the service performed was successful.
- Verify that the most recent firmware is installed on the printer.
- Verify that all parts are correctly reinstalled and are properly working.
- Print any pages necessary to verify that the repair resolved the issue and did not create any new issues.
- Verify that the printer is in better condition than when you arrived, cosmetically and electrically.



## Post-service test

Perform the following tests to verify that the repair or replacement was successful:

### Print-quality test

Learn about the print-quality test.

1. Verify that you have completed the necessary reassembly steps.
2. Make sure that the tray contains clean, unmarked paper.
3. Attach the power cord and interface cable or interface cables, and then turn on the product.
4. Print a configuration page.
5. Print a print quality page, and then verify that there are no lines, streaks, banding, or other print quality defects.
6. Send a print job from the host computer, and then verify that the output meets expectations.

## Order parts by authorized service providers

Find information about ordering parts and supplies for the printer.

### Ordering

Order parts by authorized service providers.

**Table 5-46 Ordering**

Item or provider	Description
Order supplies and paper	<a href="http://www.hp.com/go/suresupply">www.hp.com/go/suresupply</a>
Order parts from authorized service providers	<a href="http://www.hp.com/buy/parts">www.hp.com/buy/parts</a> or <a href="http://partsurfer.hp.com">partsurfer.hp.com</a>
Order through service or support providers	Contact an HP-authorized service or support provider.
Order using the HP Embedded Web Server (EWS)	To access, in a supported web browser on your computer, enter the printer IP address or host name in the address/URL field. The EWS contains a link to the HP SureSupply web site, which provides options for purchasing Original HP supplies.

### Orderable parts

Not all of the parts shown in the exploded assembly diagrams are orderable parts.


Refer to the tables following the diagrams or the alphabetical/numerical parts lists to determine if a part is orderable.

# Parts, diagrams, removal and replacement (stapler/ stacker and booklet finishers)

Learn about parts, diagrams, removal and replacement (stapler/ stacker and booklet finishers)

---




**NOTE:**  Some parts are sensitive to electrostatic discharge (ESD). Always perform service work at an ESD-protected workstation or mat. If an ESD workstation or mat is not available, touch the sheet-metal chassis to provide a static ground before touching an ESD-sensitive assembly. Protect the ESD-sensitive assemblies by placing them in ESD pouches when they are out of the printer.

---

## Parts, diagrams (stapler/stacker)

Learn about parts, diagrams (stapler/stacker)



**NOTE:**  Some parts are sensitive to electrostatic discharge (ESD). Always perform service work at an ESD-protected workstation or mat. If an ESD workstation or mat is not available, touch the sheet-metal chassis to provide a static ground before touching an ESD-sensitive assembly. Protect the ESD-sensitive assemblies by placing them in ESD pouches when they are out of the printer.

Cover & hanress

## Cover & harness

Parts diagram and parts list for the cover and harness.

Figure 5-88 cover

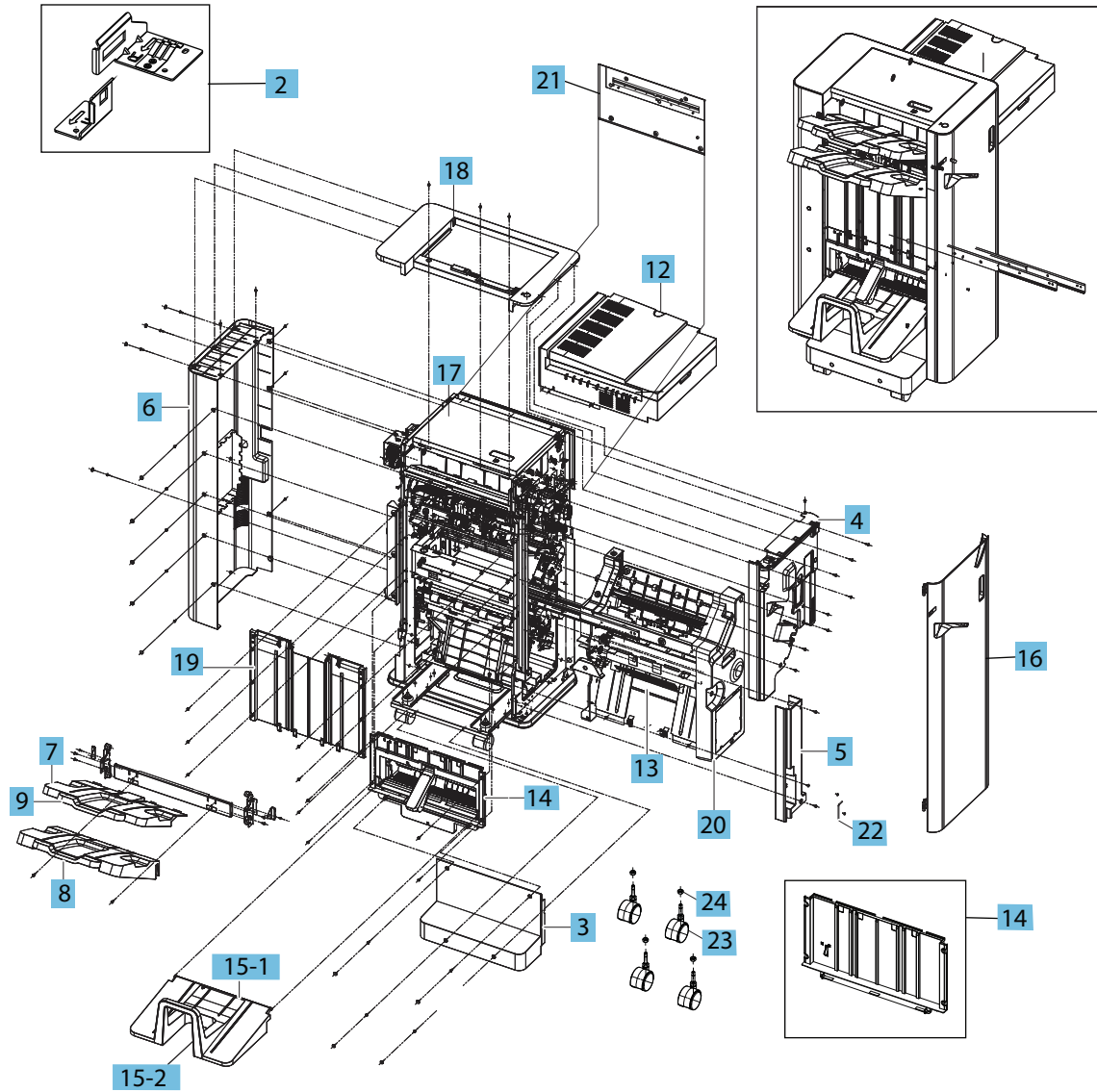


Table 5-47 cover

Ref	Description	Part number	Qty	Orderable
2	Finisher mount bracket	JC90-01442A	1	(*)
3	Caster cover	JC63-04985B	1	(*)
4	Front cover	JC63-04986B	1	(*)
5	Front lower cover	JC63-04987B	1	(*)
6	Rear cover	JC63-04988B	1	(*)
7	Top output tray upper	JC63-04996B	1	(*)
8	Main output tray	JC63-05002B	1	(*)
9	Top output tray lower	JC63-05003B	1	(*)
12	Bridge unit	JC90-01772B	1	(*)
13	Booklet maker	JC82-00905A	1	(*)
14	Left lower cover (Stacker-stapler)	JC90-01771B	1	(*)
14	Left lower cover (Booklet)	JC90-01417B	1	(*)
15-1	Booklet output tray	JC61-07253B	1	(*)
15-2	Booklet output tray cover	JC63-04978B	1	(*)
16	Front door	JC90-01444B	1	(*)
17	Top door	JC90-01445B	1	(*)
18	Top cover	JC90-01446B	1	(*)
19	Left upper cover	JC90-01475B	1	(*)
20	Booklet front cover	JC90-01478B	1	(*)
21	Right upper cover	JC90-01448B	1	(*)
22	Hinge	JC66-04767A	1	(*)
23	Caster	JC61-07452A	4	(*)
24	Caster fix nut	JC61-07444A	4	(*)

Table 5-48 harness

Ref	Description	Part number	Qty	Orderable
Not shown	Harness, finisher to copier PWR	JC39-02308A	1	(*)
Not shown	Harness, 3K finisher to copier PWR	JC39-02308A	1	(*)
Not shown	Harness, 3K finisher rear upper	JC39-02312A	1	(*)
Not shown	Harness, 3K finisher front upper	JC39-02313A	1	(*)
Not shown	Harness, 3K finisher punch relay	JC39-02314A	1	(*)
Not shown	Harness, 3K finisher staple relay	JC39-02315A	1	(*)
Not shown	Harness, 3K finisher eject relay	JC39-02317A	1	(*)
Not shown	Harness, 3K finisher front lower	JC39-02318A	1	(*)
Not shown	Harness, 3K finisher stack relay	JC39-02319A	1	(*)
Not shown	Harness, 3k finisher exit path	JC39-02322A	1	(*)
Not shown	Harness, 3K Finisher Bridge Sub	JC39-02327A	1	(*)
Not shown	Harness, 3K Finisher Bridge Pa	JC39-02328A	1	(*)
Not shown	Stack full harness	JC39-02331A	1	(*)

(\*) This part is in ordering system.

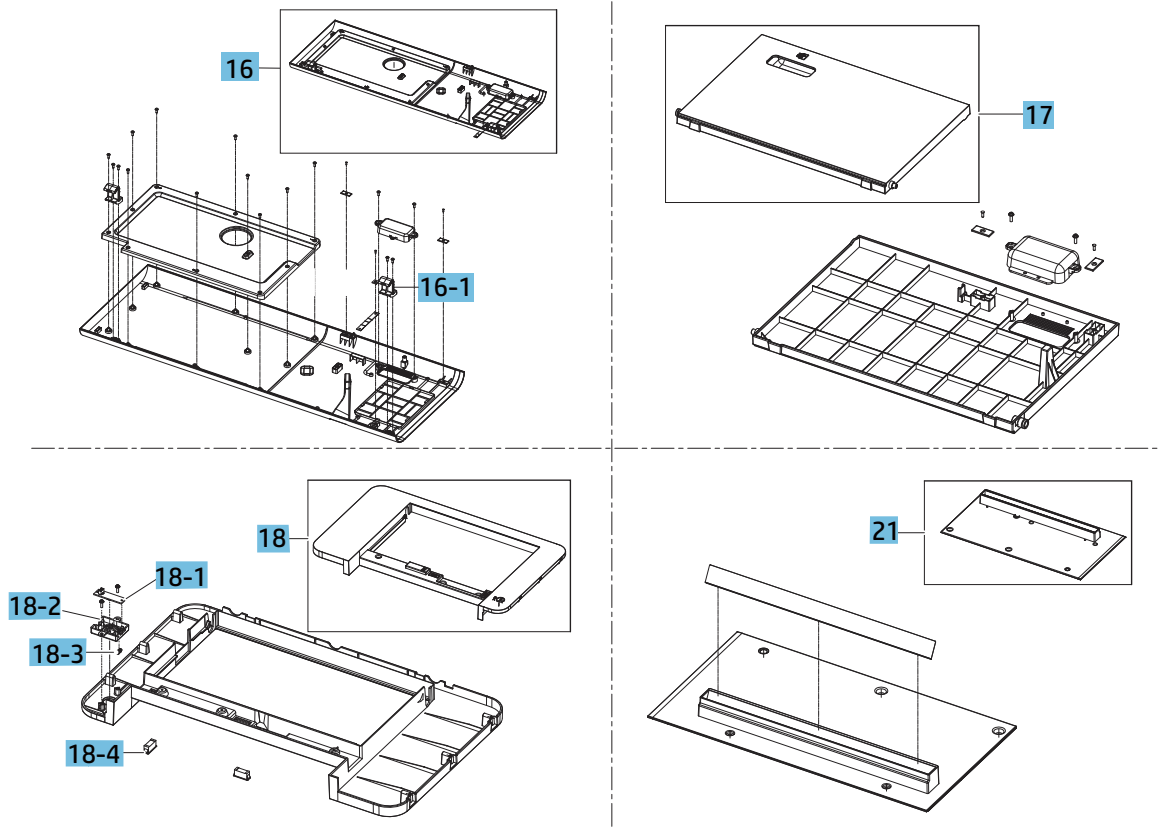




## Front door, Top door, Top cover, Right upper cover

Parts diagram and parts list for the front door, top door, top cover, right upper cover.

Figure 5-89 Front door, Top door, Top cover, Right upper cover



**Table 5-49** Front door, Top door, Top cover, Right upper cover

Ref	Description	Part number	Qty	Orderable
16	Front door	JC90-01444B	1	(*)
16-1	Cover link	JC63-05004A	1	(*)
17	Top door	JC90-01445B	1	(*)
18	Top cover	JC90-01446B	1	(*)
18-1	Manual staple PCA	JC92-02789B	1	(*)
18-2	Magnet	JC81-08263A	1	(*)
18-3	Manual staple button LED	JC64-00996A	1	(*)
18-4	Manual staple button	JC64-00995A	1	(*)
21	Right upper cover	JC90-01448B	1	(*)

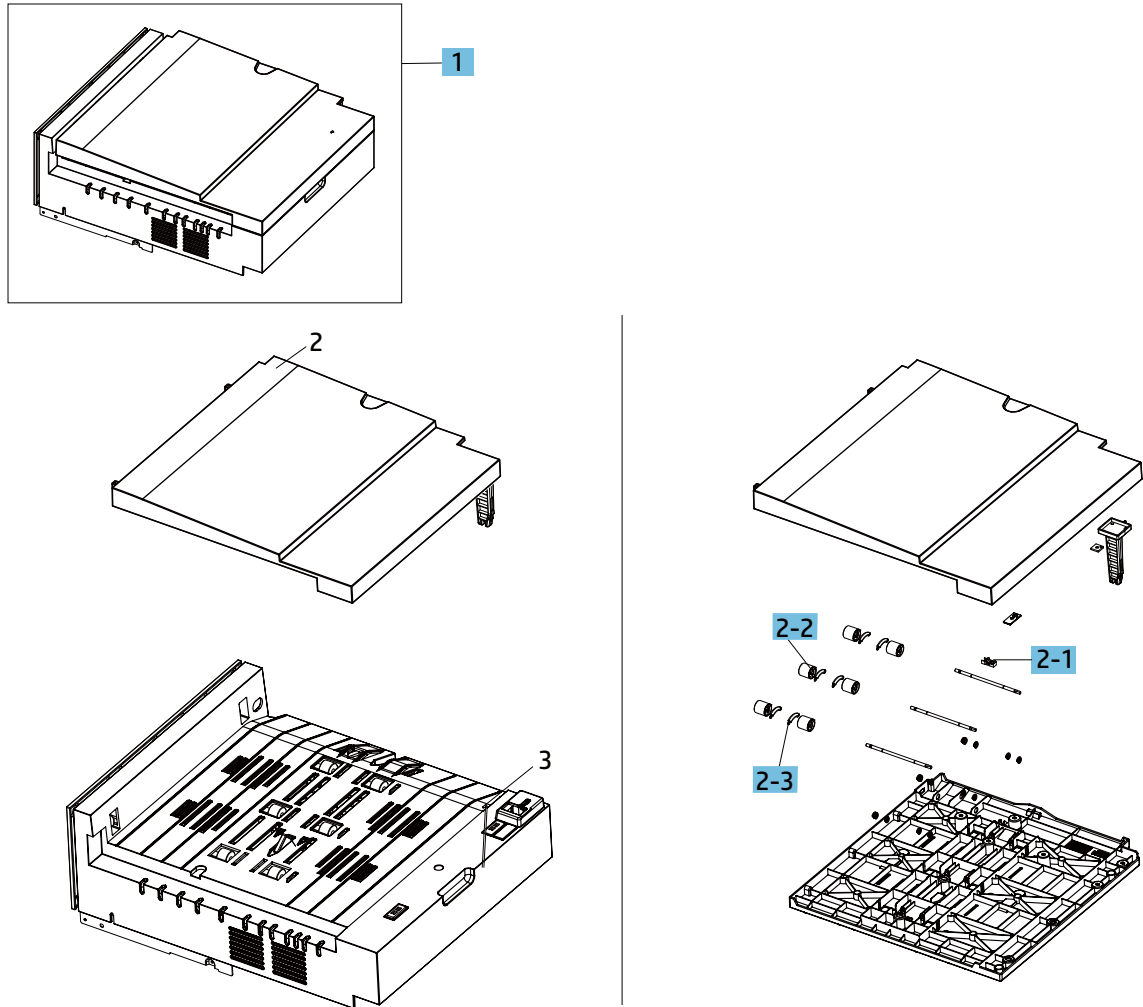
(\*) This part is in ordering system.

## Bridge unit

### Upper bridge

Parts diagram and parts list for the bridge unit, upper bridge.

Figure 5-90 Bridge unit, Upper bridge



**Table 5-50** Bridge unit, Upper bridge

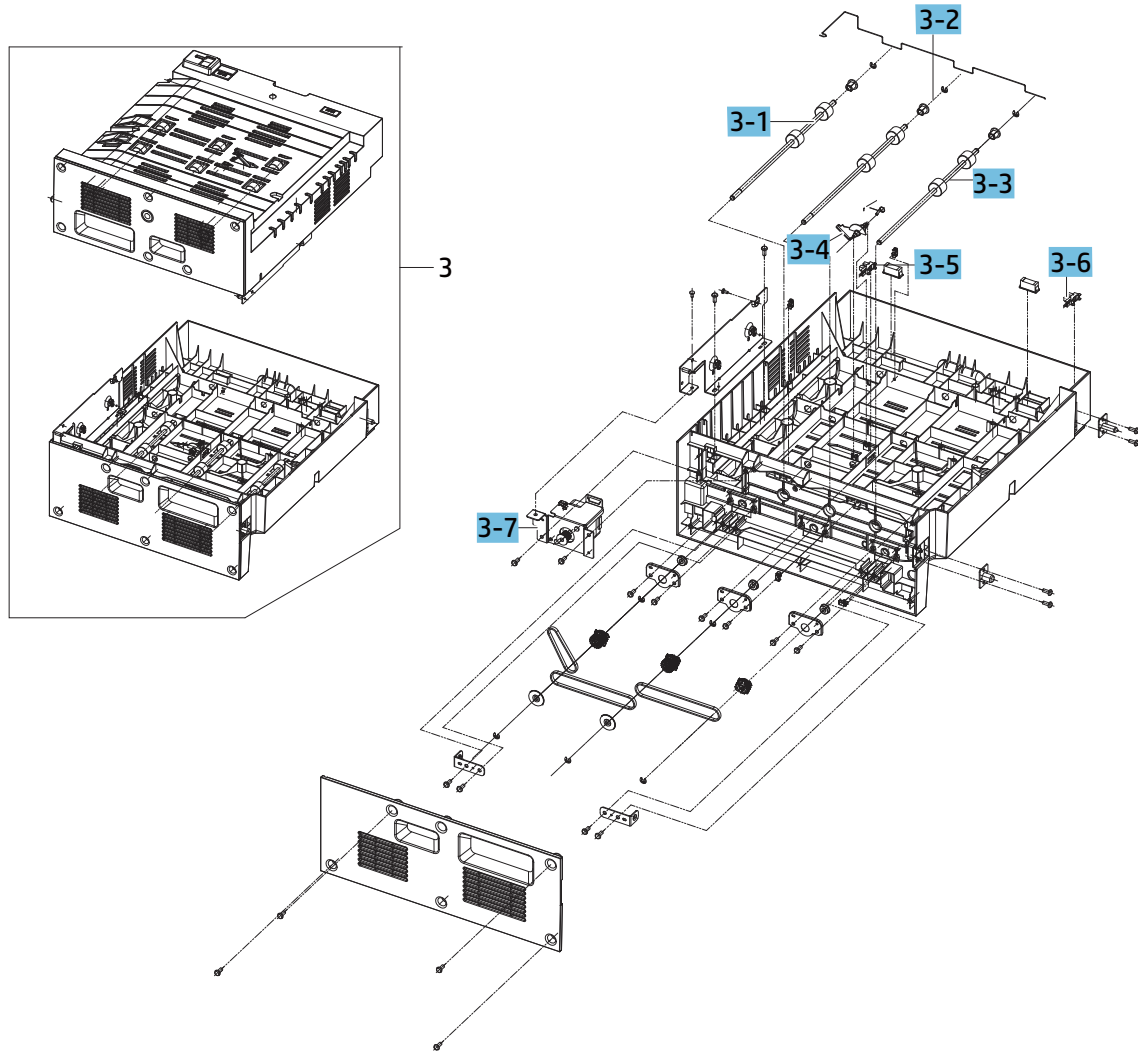
Ref	Description	Part number	Qty	Orderable
1	Bridge unit	JC90-01772B	1	(*)
2	Upper bridge unit	JC90-01406B	1	
2-1	Bridge entrance sensor	JC32-00020A	1	(*)
2-2	Spring	JC61-07431A	4	(*)
2-3	Spring	JC61-07430A	2	(*)
3	Lower bridge unit	JC90-01401B	1	

(\*) This part is in ordering system.

## Lower bridge

Parts diagram and parts list for the bridge unit, lower bridge.

Figure 5-91 Bridge unit, Lower bridge



**Table 5-51** Bridge unit, Lower bridge

Ref	Description	Part number	Qty	Orderable
3	Lower bridge unit	JC90-01401B	1	
3-1	Bridge entrance roller	JC66-04733A	1	
3-2	Bridge middle roller	JC66-04732A	1	(*)
3-3	Bridge exit roller	JC66-04732A	4	(*)
3-4	Bridge exit actuator	JC66-04569A	2	(*)
3-5	Bridge exit sensor	0604-001393	1	
3-6	Bridge door sensor	0604-001393	1	(*)
3-7	Bridge motor	JC31-00163B	1	(*)

(\*) This part is in ordering system.

## Entrance unit

### Entrance unit

Parts diagram and parts list for the entrance unit.

Figure 5-92 Entrance unit

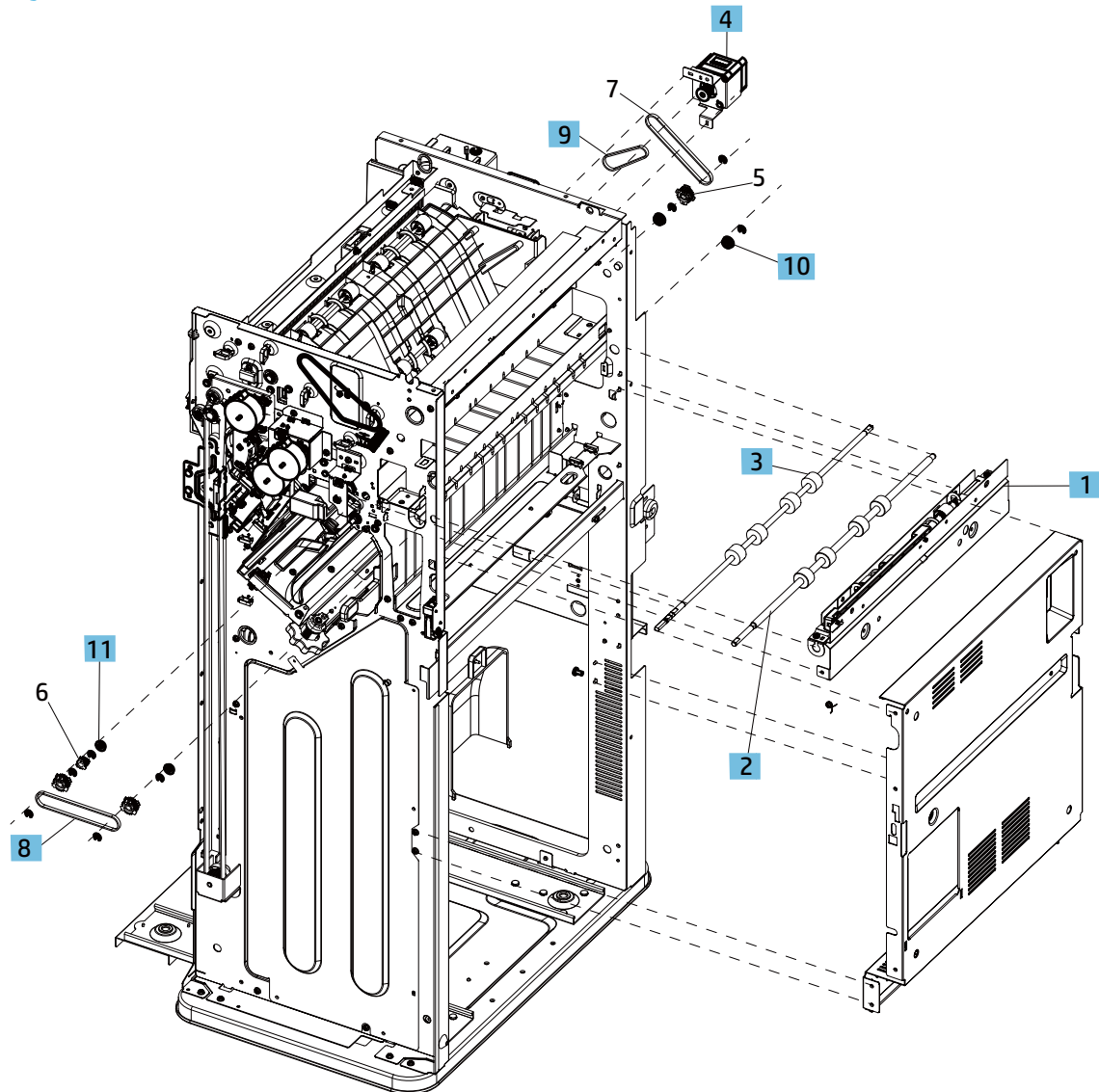




Table 5-52 Entrance unit

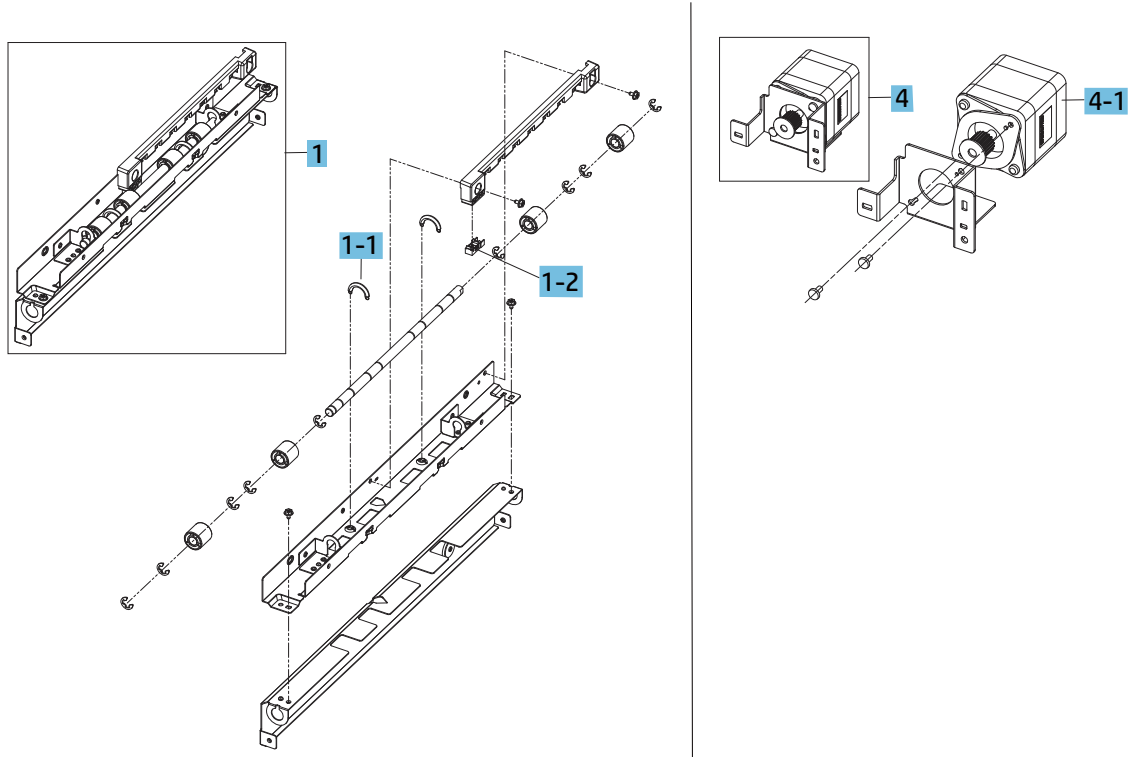
Ref	Description	Part number	Qty	Orderable
1	Entrance unit	JC90-01449A	1	(*)
2	Entrance roller	JC66-04722A	1	(*)
3	Middle roller	JC66-04724A	1	(*)
4	Entrance motor assembly	JC90-01459A	1	(*)
5	Gear	JC66-04656A	3	
6	Gear	JC66-04546A	1	
7	Belt	6602-003646	1	
8	Belt	6602-003647	1	(*)
9	Belt	6602-003645	1	(*)
10	Bushing	6601-001478	2	(*)
11	Bushing	6601-002584	2	(*)

(\*) This part is in ordering system.

## Entrance unit, Entrance motor

Parts diagram and parts list for the entrance unit, entrance motor.

Figure 5-93 Entrance unit, Entrance motor



**Table 5-53 Entrance unit, Entrance motor**

Ref	Description	Part number	Qty	Orderable
1	Entrance unit	JC90-01449A	1	(*)
1-1	Spring	JC61-07408A	2	(*)
1-2	Entrance sensor	JC32-00020A	1	(*)
4	Entrance motor assembly	JC90-01459A	1	(*)
4-1	Entrance motor	JC31-00163B	1	(*)

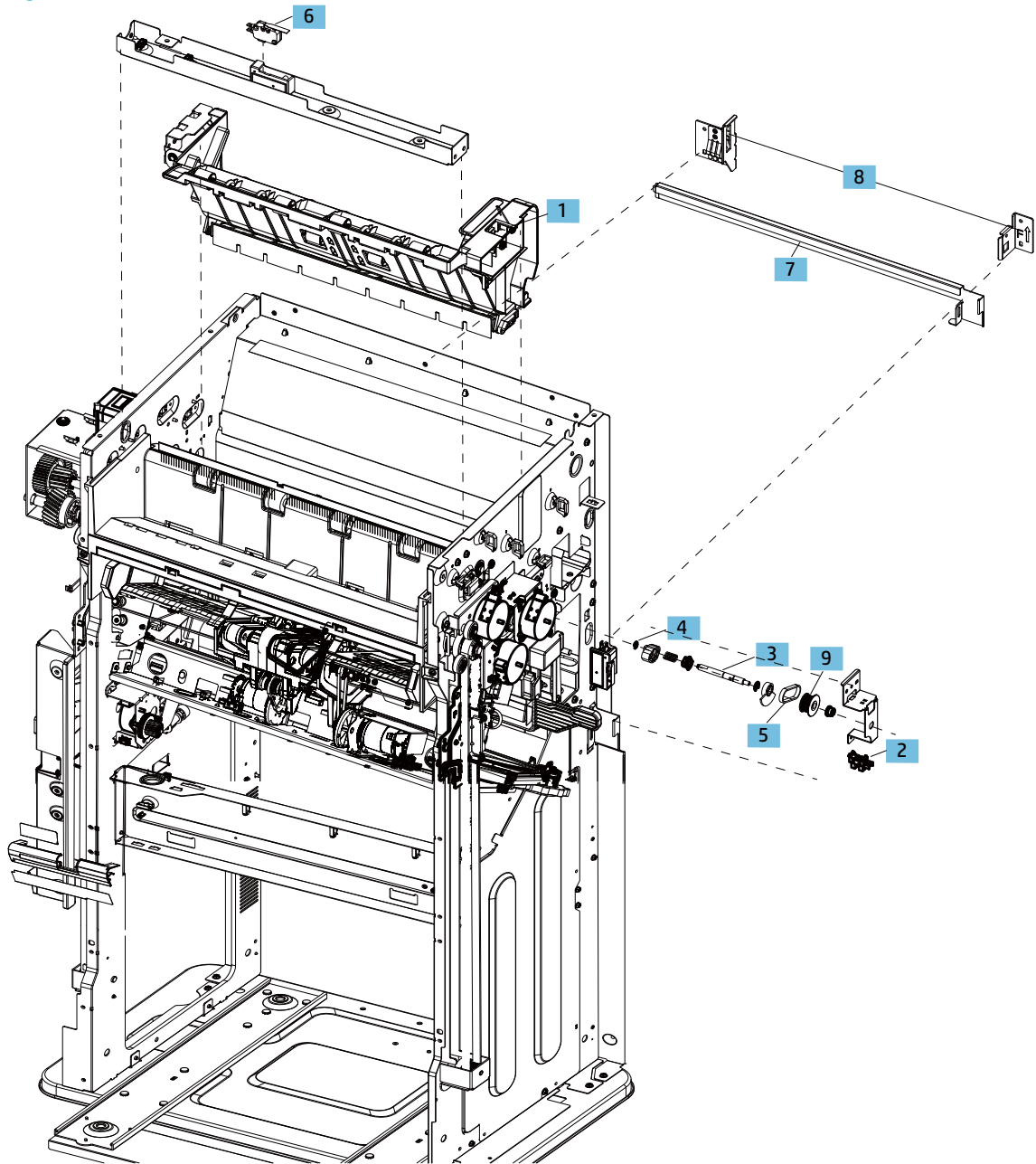
(\*) This part is in ordering system.

## Tray diverter unit

### Tray diverter unit

Parts diagram and parts list for the tray diverter unit.

Figure 5-94 Tray diverter unit



**Table 5-54** Tray diverter unit

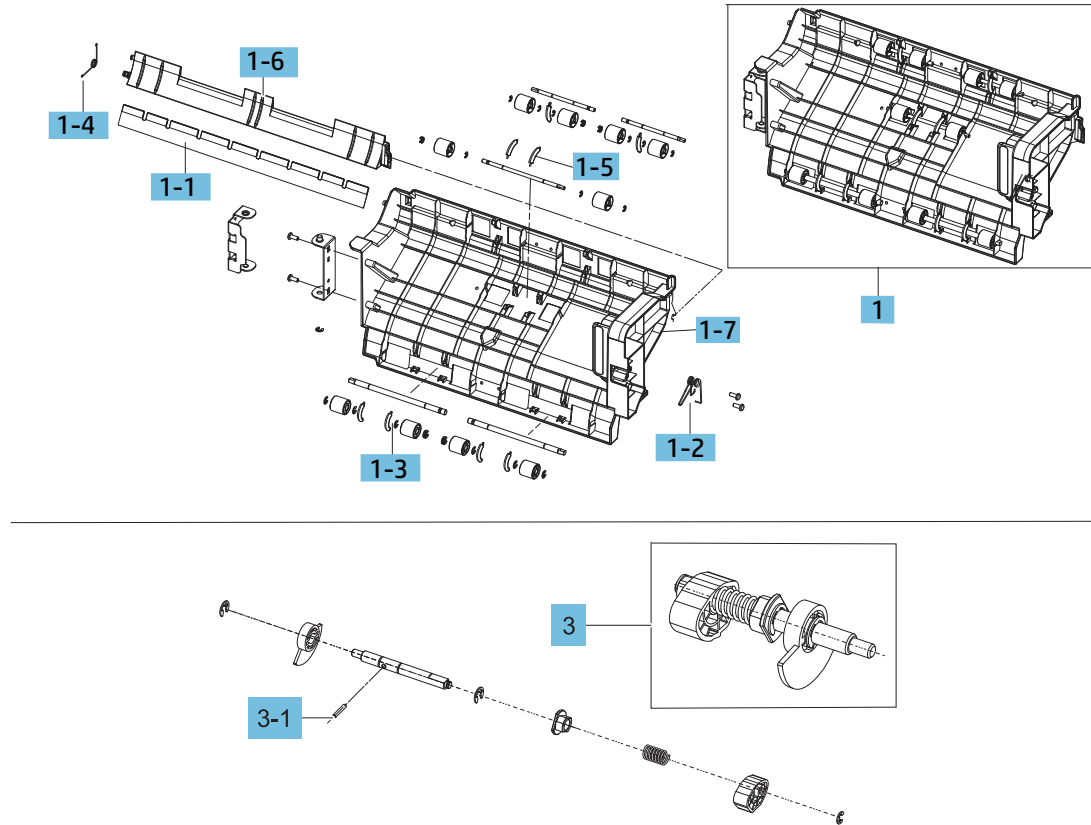
Ref	Description	Part number	Qty	Orderable
1	Top jam cover assembly	JC90-01455A	1	(*)
2	Tray diverter home sensor	0604-001415	1	(*)
3	Tray diverter cam	JC90-01458A	1	(*)
4	Bushing	JC61-00423A	1	(*)
5	Belt	6602-003639	1	(*)
6	Top door switch	JC39-02310A	1	(*)
7	Frame mount	JC61-06663A	1	(*)
8	Frame mount side bracket	JC90-01442A	1	(*)
9	Clutch	JC90-01474A	1	(*)

(\*) This part is in ordering system.

## Tray jam cover, Tray diverter CAM

Parts diagram and parts list for the tray jam cover, tray diverter CAM.

Figure 5-95 Tray jam cover, Tray diverter CAM



**Table 5-55** Tray jam cover, Tray diverter CAM

Ref	Description	Part number	Qty	Orderable
1	Top jam cover assembly	JC90-01455A	1	(*)
1-1	Seal	JC62-01328A	1	(*)
1-2	Spring	JC61-07417A	1	(*)
1-3	Spring	JC61-07415A	1	(*)
1-4	Spring	JC61-07410A	1	(*)
1-5	Spring	JC61-07409A	1	(*)
1-6	Tray diverter	JC61-07205A	1	(*)
1-7	Tray jam cover	JC61-07196A	1	(*)
3	Tray diverter cam	JC90-01458A	1	(*)
3-1	Pin	JC70-40360A	1	(*)

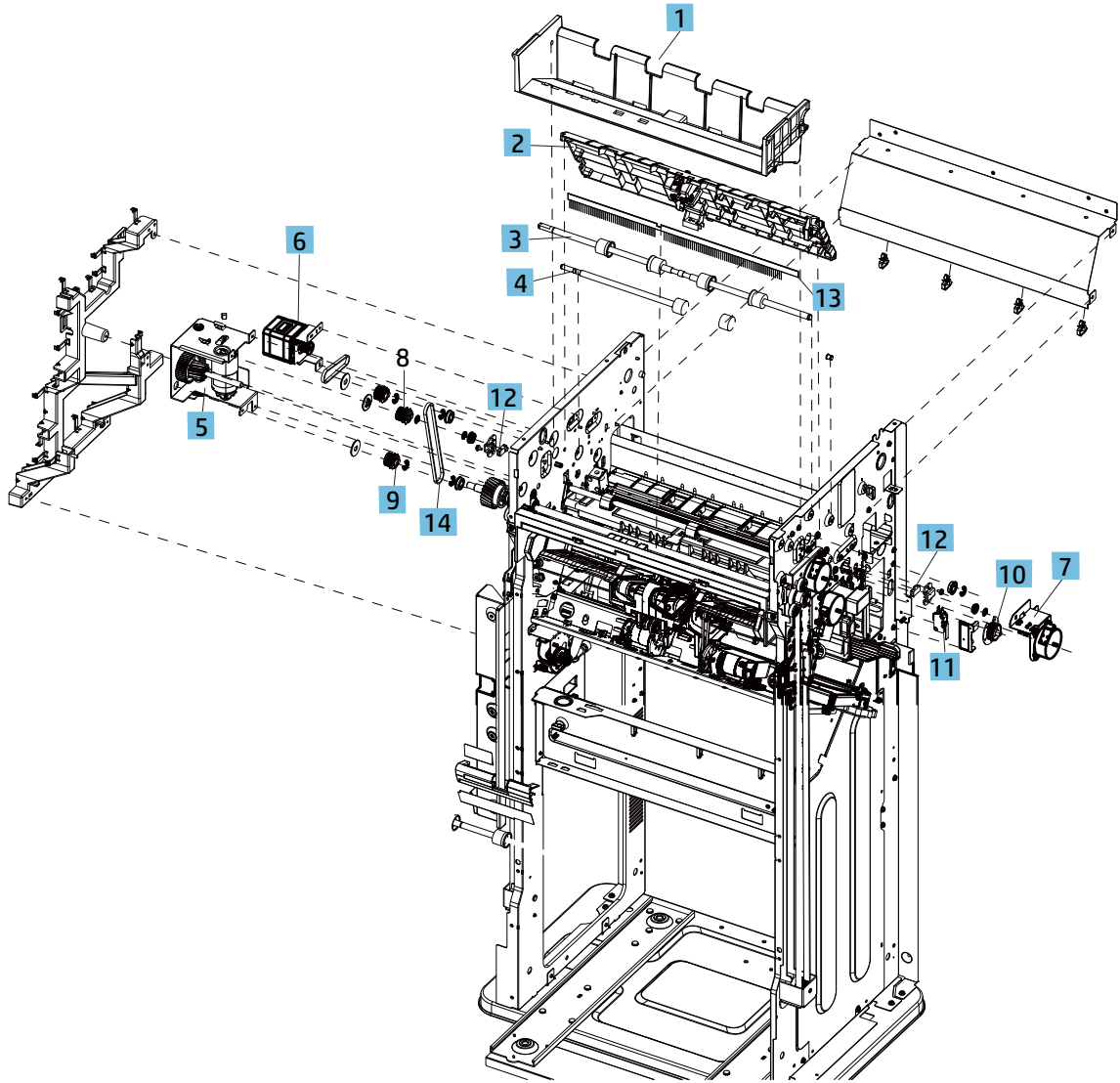
(\*) This part is in ordering system.

## Top output tray unit, Top exit unit, Main exit unit

### Top output tray unit, Top exit unit, Main exit unit

Parts diagram and parts list for the top output tray unit, top exit unit, main exit unit.

Figure 5-96 Top output tray unit, Top exit unit, Main exit unit





**Table 5-56** Top output tray unit, Top exit unit, Main exit unit

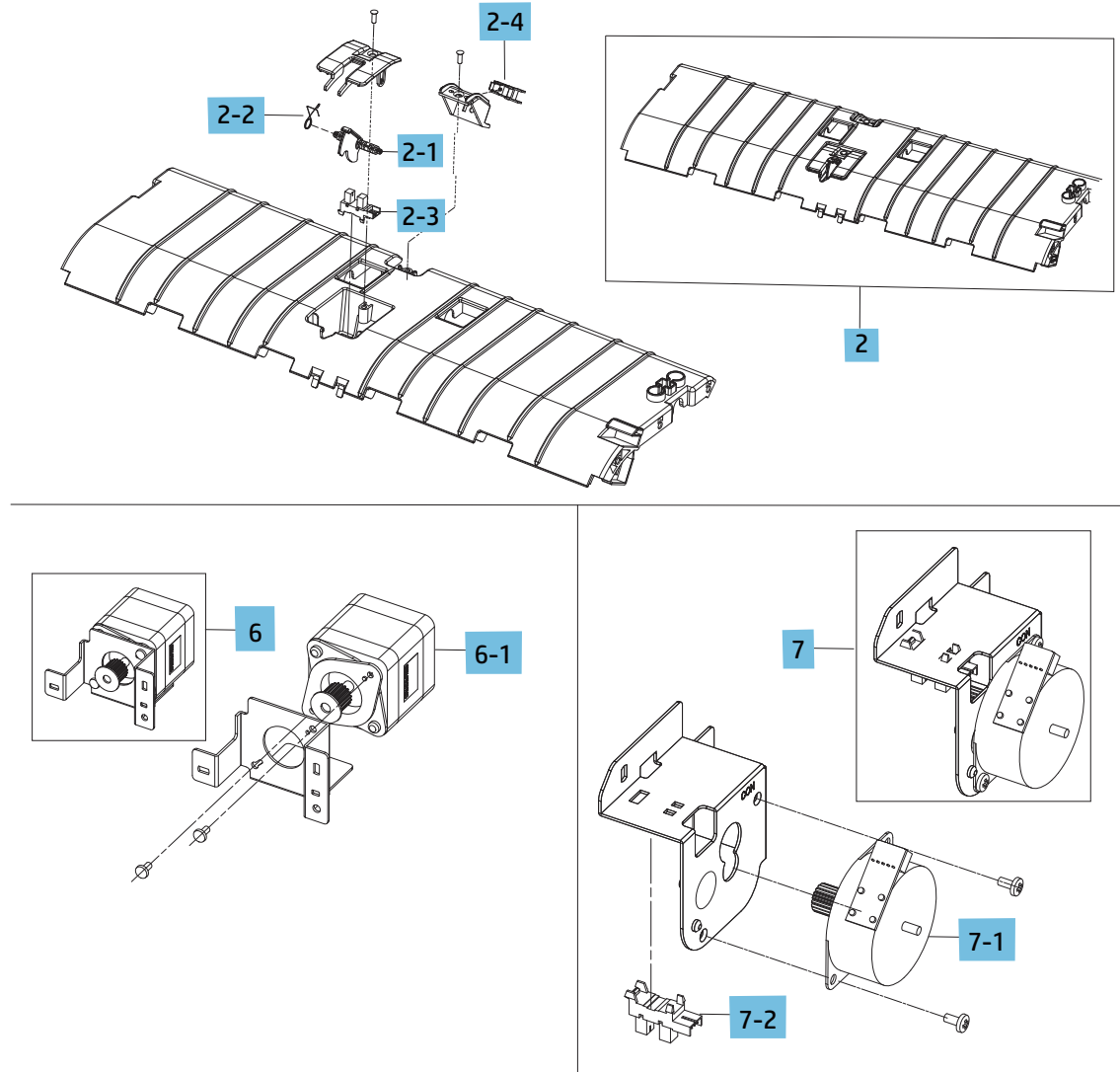
Ref	Description	Part number	Qty	Orderable
1	Top output tray	JC63-04995B	1	(*)
2	Top lower feed assembly	JC90-01454A	1	(*)
3	Top exit roller	JC66-04727A	1	(*)
4	Top middle roller	JC66-04725A	1	(*)
5	Main output tray motor assembly	JC90-01415B	1	(*)
6	Exit motor assembly	JC90-01459A	1	(*)
7	Main exit CAM motor assembly	JC90-01453A	1	(*)
8	Gear	JC66-04657A	2	
9	Clutch	JC90-01404A	1	(*)
10	Gear	JC66-04602A	1	(*)
11	Front door switch	JC39-02310A	1	(*)
12	Top output tray paper full sensor	JC82-01039A	1	(*)
13	Top-brush exit	JC67-00818A	1	(*)
14	Belt	6602-003649	1	(*)

(\*) This part is in ordering system.

## Top lower cover, Exit motor, Main exit CAM motor

Parts diagram and parts list for the top lower cover, exit motor, main exit CAM motor.

Figure 5-97 Top lower cover, Exit motor, Main exit CAM motor



**Table 5-57** Top lower cover, Exit motor, Main exit CAM motor

Ref	Description	Part number	Qty	Orderable
2	Top lower feed assembly	JC90-01454A	1	(*)
2-1	Top exit actuator	JC66-04525A	1	(*)
2-2	Spring	JC61-07411A	1	(*)
2-3	Top exit sensor	0604-001393	1	(*)
2-4	Main exit sensor	JC32-00020A	1	(*)
6	Exit motor assembly	JC90-01459A	1	(*)
6-1	Exit motor	JC31-00163B	1	(*)
7	Main exit CAM motor assembly	JC90-01453A	1	(*)
7-1	Main exit CAM motor	JC93-01155A	1	(*)
7-2	Main exit CAM home sensor	0604-001393	1	(*)

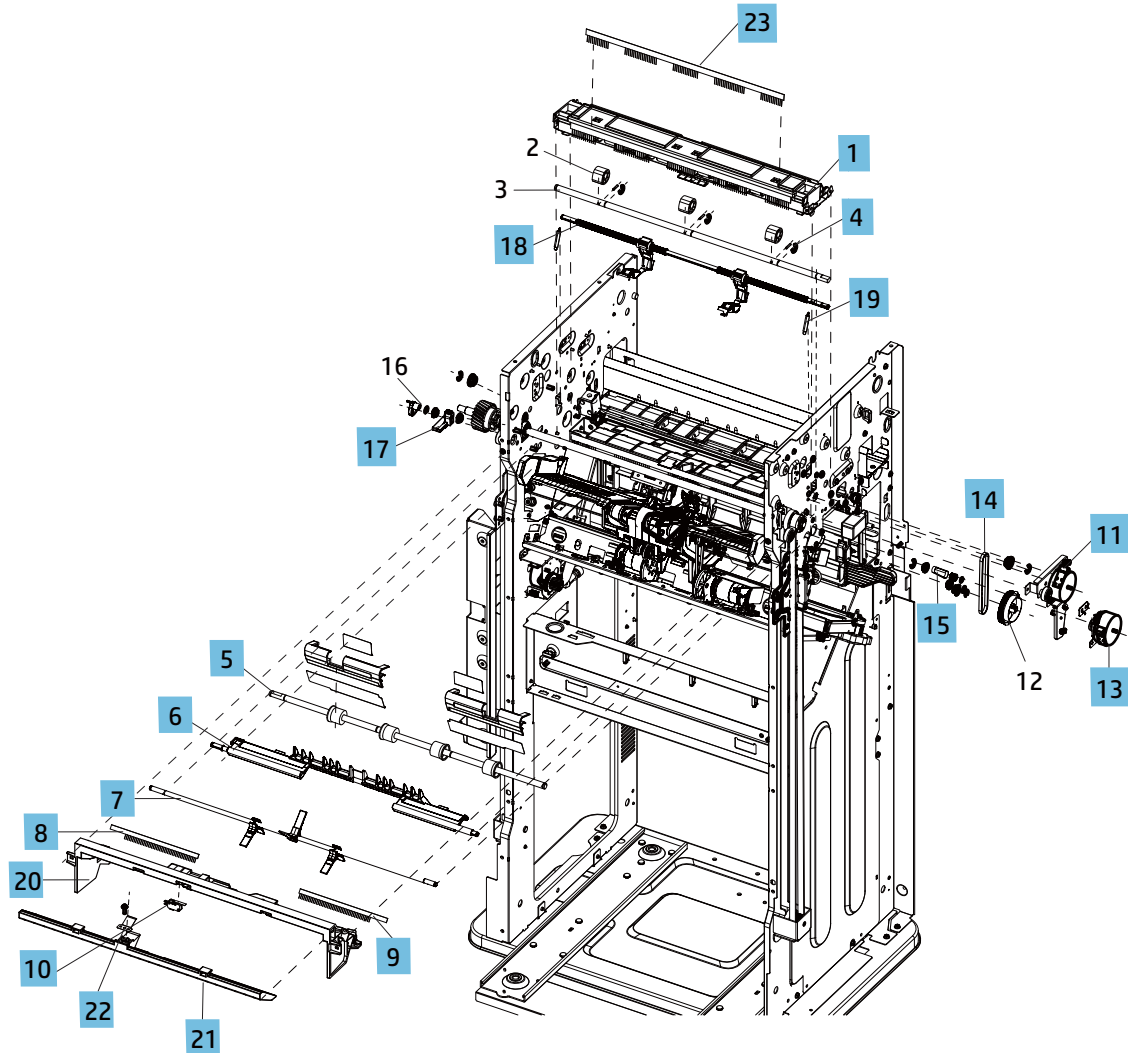
(\*) This part is in ordering system.

## Main exit unit, Paddle unit, End fence unit

### Main exit unit, Paddle unit, End fence unit

Parts diagram and parts list for the main exit unit, paddle unit, end fence unit.

Figure 5-98 Main exit unit, Paddle unit, End fence unit



**Table 5-58 Main exit unit, Paddle unit, End fence unit**

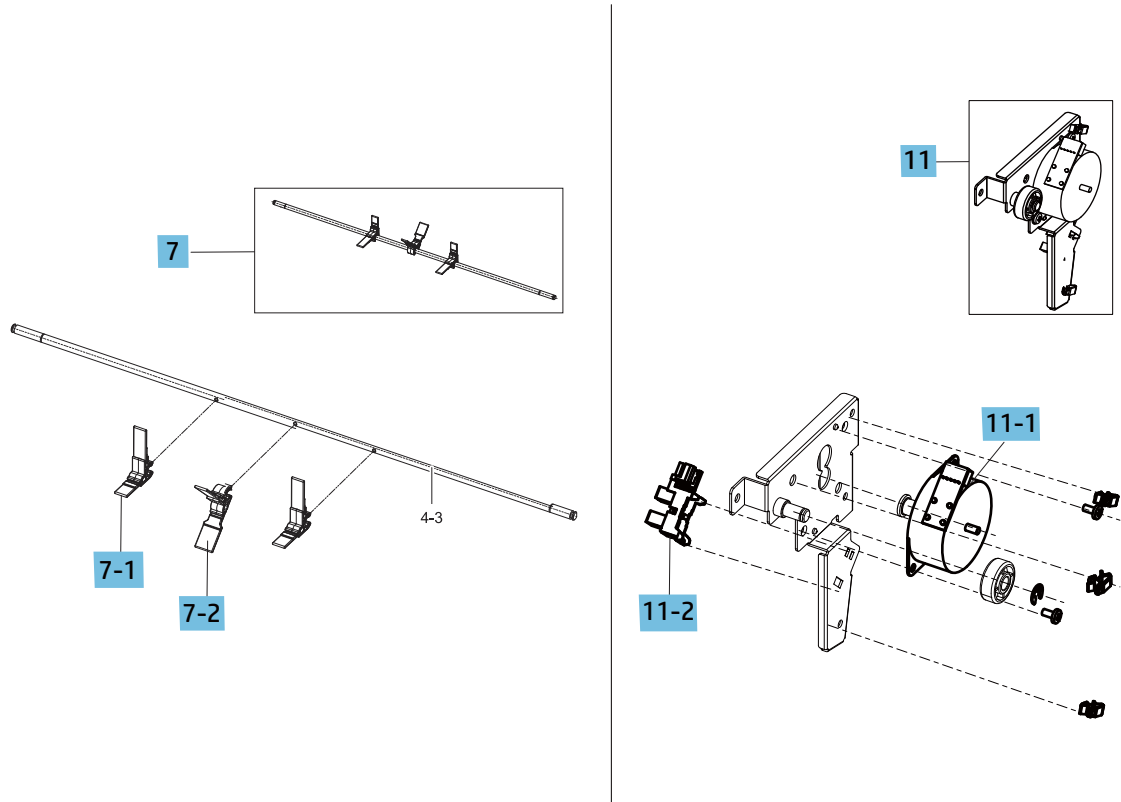
Ref	Description	Part number	Qty	Orderable
1	Main exit CAM guide	JC90-01451A	1	(*)
2	Main exit CAM	JC66-04561A	3	
3	Main exit CAM shaft	JC66-04715A	1	
4	Pin	JC70-40360A	3	(*)
5	Main exit roller	JC66-04726A	1	(*)
6	Paddle pesser	JC61-07206A	1	(*)
7	Paddle	JC90-01480A	1	(*)
7-1	Paddle wing	JC90-01463A	2	(*)
7-2	Paddle mid	JC90-01462A	1	(*)
8	Brush	JC67-00819A	1	(*)
9	Brush	JC67-00820A	1	(*)
10	Main output tray top of stack switch	JC39-02316A	1	(*)
11	Paddle motor assembly	JC90-01461A	1	(*)
11-1	Paddle motor	JC93-01001A	1	(*)
11-2	Paddle home sensor	0604-001393	1	(*)
12	Paddle home gear	JC66-04558A	1	
13	End fence motor	JC90-01467A	1	(*)
14	Belt	6602-003270	1	(*)
15	Belt	6602-003640	1	(*)
16	CAM	JC66-04562A	1	
17	CAM guide	JC66-04526A	1	(*)
18	End fence	JC90-01466A	1	(*)
19	Spring	JC61-07414A	2	(*)
20	Main output tray top of stack switch guide	JC61-07189A	1	(*)
21	Main output tray top of stack switch lower guide	JC61-07192A	1	(*)
22	Ground	JC63-04984A	1	(*)
23	Brush	JC67-00817A	1	(*)

(\*) This part is in ordering system.

## Paddle, Paddle motor

Parts diagram and parts list for the paddle, paddle motor.

Figure 5-99 Paddle, Paddle motor



**Table 5-59 Paddle, Paddle motor**

Ref	Description	Part number	Qty	Orderable
7	Paddle	JC90-01480A	1	(*)
7-1	Paddle wing	JC90-01463A	2	(*)
7-2	Paddle mid	JC90-01462A	1	(*)
11	Paddle motor assembly	JC90-01461A	1	(*)
11-1	Paddle motor	JC93-01001A	1	(*)
11-2	Paddle home sensor	0604-001393	1	(*)

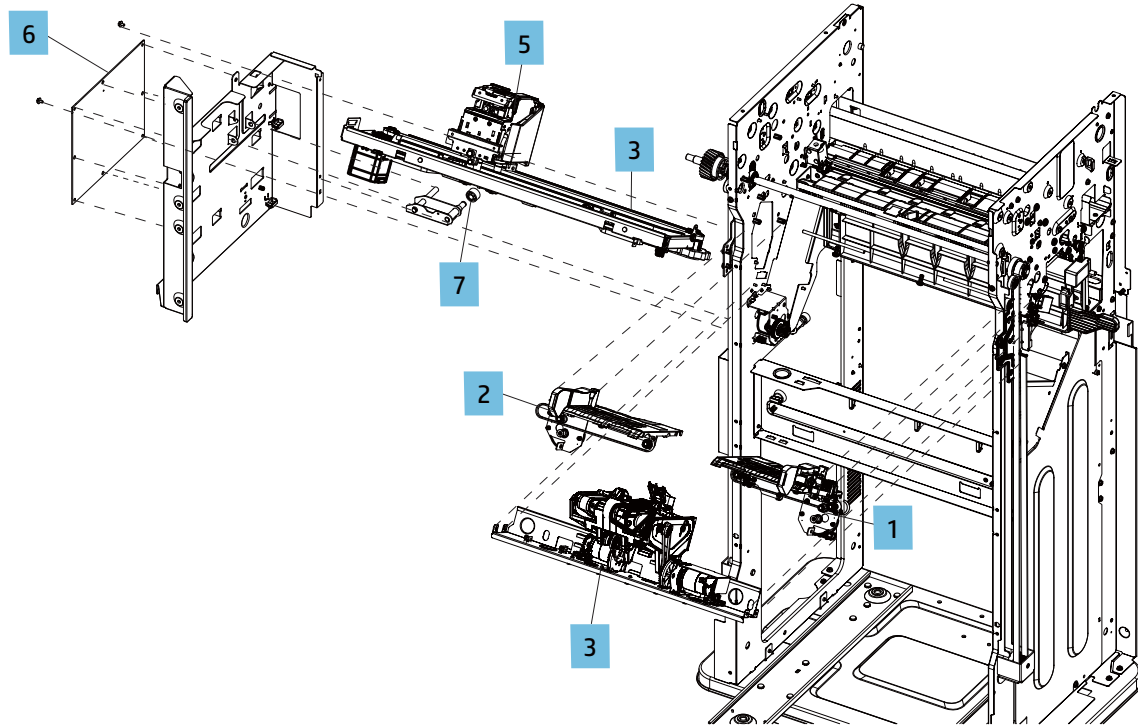
(\*) This part is in ordering system.

## Tamper unit, Ejector unit, Stapler unit, Main PCA

### Tamper unit, Ejector unit, Stapler unit, Main PCA

Parts diagram and parts list for the tamper unit, ejector unit, stapler unit, main PCA.

Figure 5-100 Tamper unit, Ejector unit, Stapler unit, Main PCA





**Table 5-60** Tamper unit, Ejector unit, Stapler unit, Main PCA

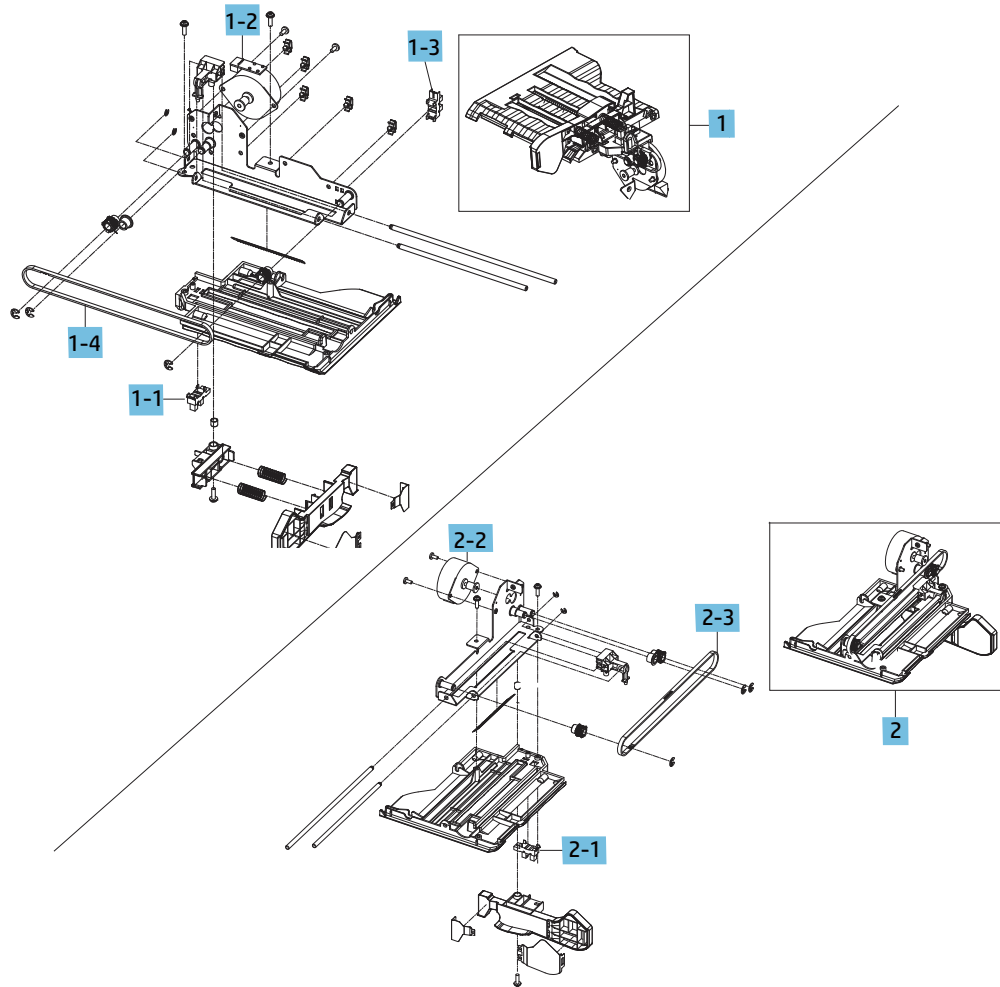
Ref	Description	Part number	Qty	Orderable
1	Front tamper unit	JC82-00901A	1	(*)
2	Rear tamper unit	JC82-00898A	1	(*)
3	Ejector unit	JC90-01409A	1	(*)
4	Stapler unit	JC82-00894A	1	(*)
5	Stapler cartridge	JC81-09882B	1	(*)
6	Finisher main PCA	JC92-02968A	1	(*)
7	Roller	JC66-04523A	1	(*)

(\*) This part is in ordering system.

## Tamper unit

Parts diagram and parts list for the tamper unit.

Figure 5-101 Tamper unit



**Table 5-61 Tamper unit**

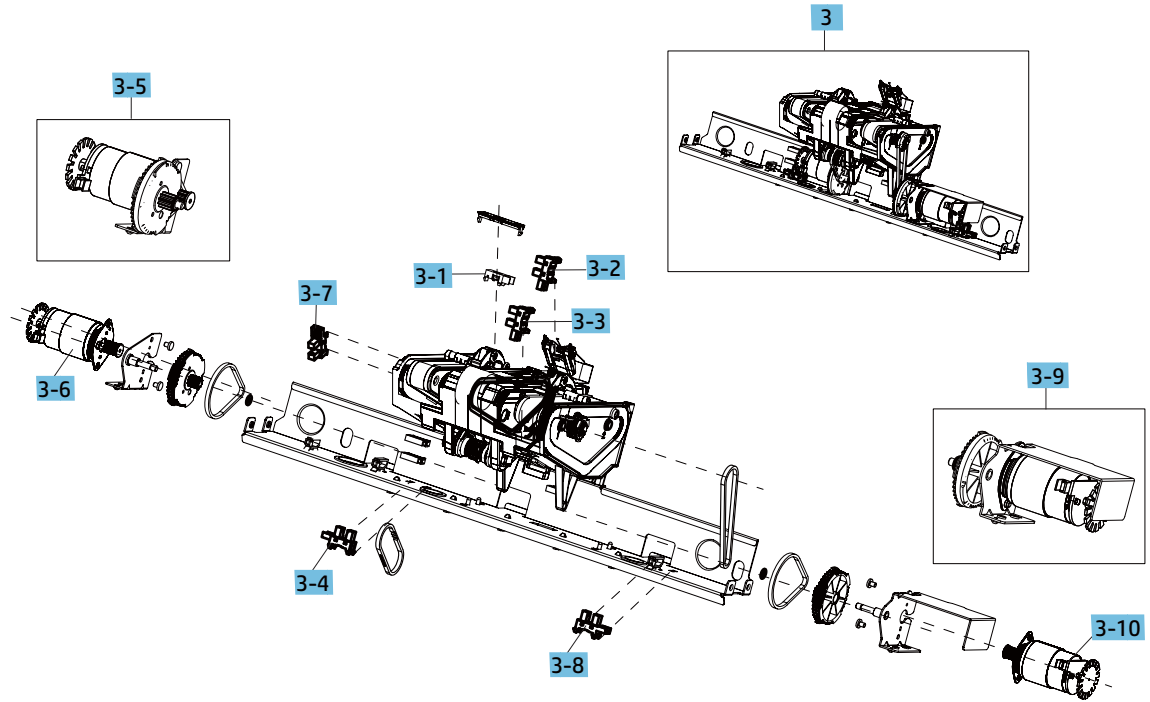
Ref	Description	Part number	Qty	Orderable
1	Front tamper unit	JC82-00901A	1	(*)
1-1	Front tamper home sensor	0604-001393	1	(*)
1-2	Front tamper motor	JC93-01001A	1	(*)
1-3	End fence home sensor	0604-001393	1	(*)
1-4	Belt	6602-003644	1	(*)
2	Rear tamper unit	JC82-00898A	1	(*)
2-1	Rear tamper home sensor	0604-001393	1	(*)
2-2	Rear tamper motor	JC93-01001A	1	(*)
2-3	Belt	6602-003644	1	(*)

(\*) This part is in ordering system.

## Ejector unit

Parts diagram and parts list for the ejector unit.

Figure 5-102 Ejector unit



**Table 5-62 Ejector unit**

Ref	Description	Part number	Qty	Orderable
3	Ejector unit	JC90-01409A	1	(*)
3-1	Ejector sensor	JC32-00020A	1	(*)
3-2	Ejector1 home sensor	0604-001415	1	(*)
3-3	Ejector1 end sensor	0604-001415	1	(*)
3-4	Ejector1 motor sensor	0604-001415	1	(*)
3-5	Ejector1 motor assembly	JC90-01411A	1	(*)
3-6	Ejector1 motor	JC93-01168A	1	(*)
3-7	Ejector2 home sensor	0604-001415	1	(*)
3-8	Ejector2 motor sensor	0604-001415	1	(*)
3-9	Ejector2 motor assembly	JC90-01410A	1	(*)
3-10	Ejector2 motor	JC93-01168A	1	(*)

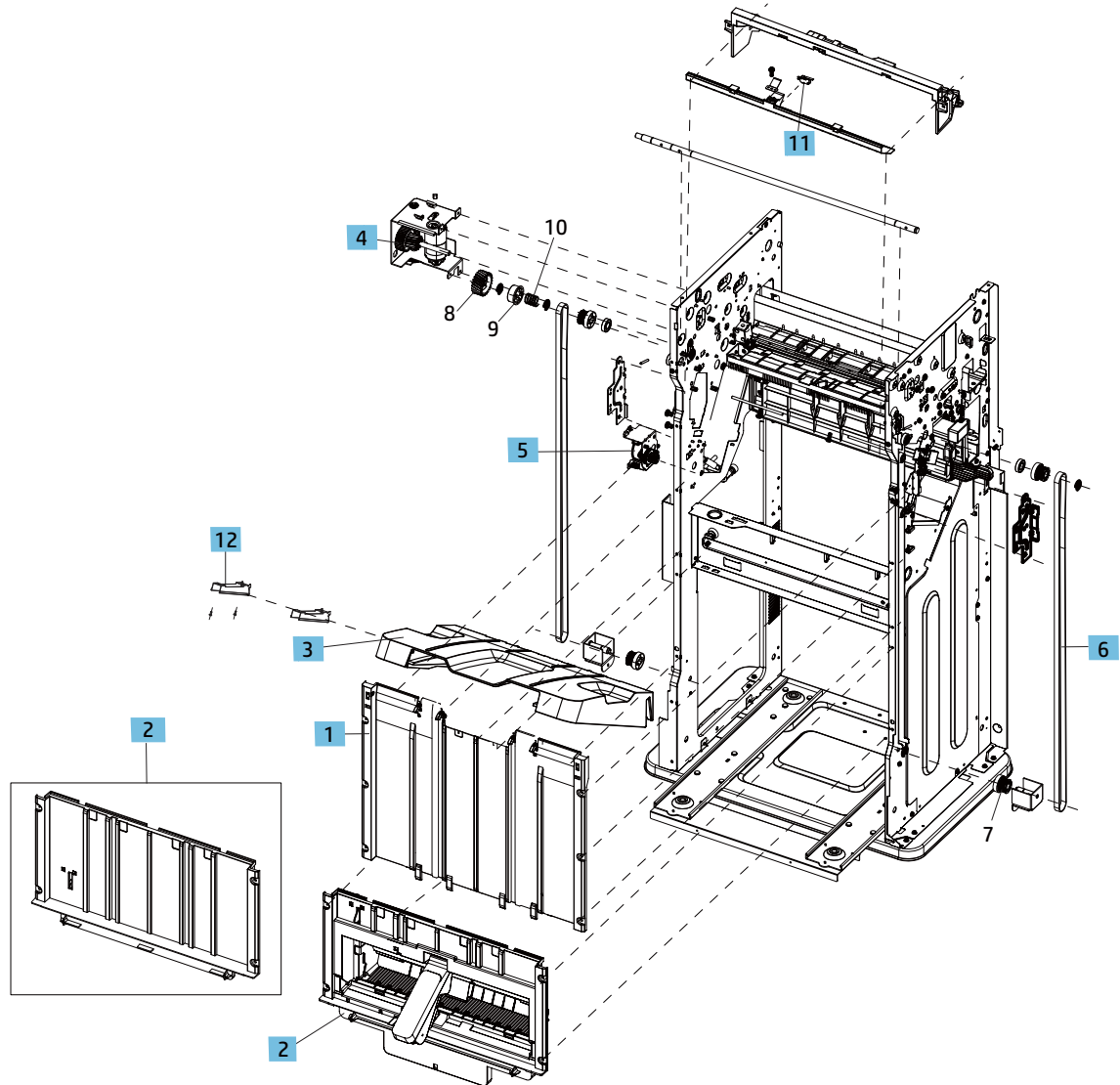
(\*) This part is in ordering system.

## Paper holding unit, Main output tray unit

### Paper holding unit, Main output tray unit

Parts diagram and parts list for the paper holding unit, main output tray unit.

Figure 5-103 Paper holding unit, Main output tray unit



**Table 5-63** Paper holding unit, Main output tray unit

Ref	Description	Part number	Qty	Orderable
1	Left upper cover	JC90-01475B	1	(*)
2	Left lower cover(Booklet finisher)	JC90-01417B	1	(*)
2	Left lower cover(Stapler-stacker finisher)	JC90-01771B	1	(*)
3	Main output tray	JC63-05002B	1	(*)
4	Main output tray motor aseembly	JC90-01415B	1	(*)
5	Paper holding motor	JC90-01414A	1	(*)
6	Belt	6602-003652	2	(*)
7	Gear	JC66-04663A	4	
8	Gear	JC66-04605A	1	
9	Gear	JC61-07305A	1	
10	Spring	JC61-07429A	1	
11	Main output tray top of stack switch	JC39-02316A	1	(*)
12	Main output tray support	JC61-06668A	2	(*)

(\*) This part is in ordering system.

## Left upper cover

Parts diagram and parts list for the left upper cover.

Figure 5-104 Left upper cover

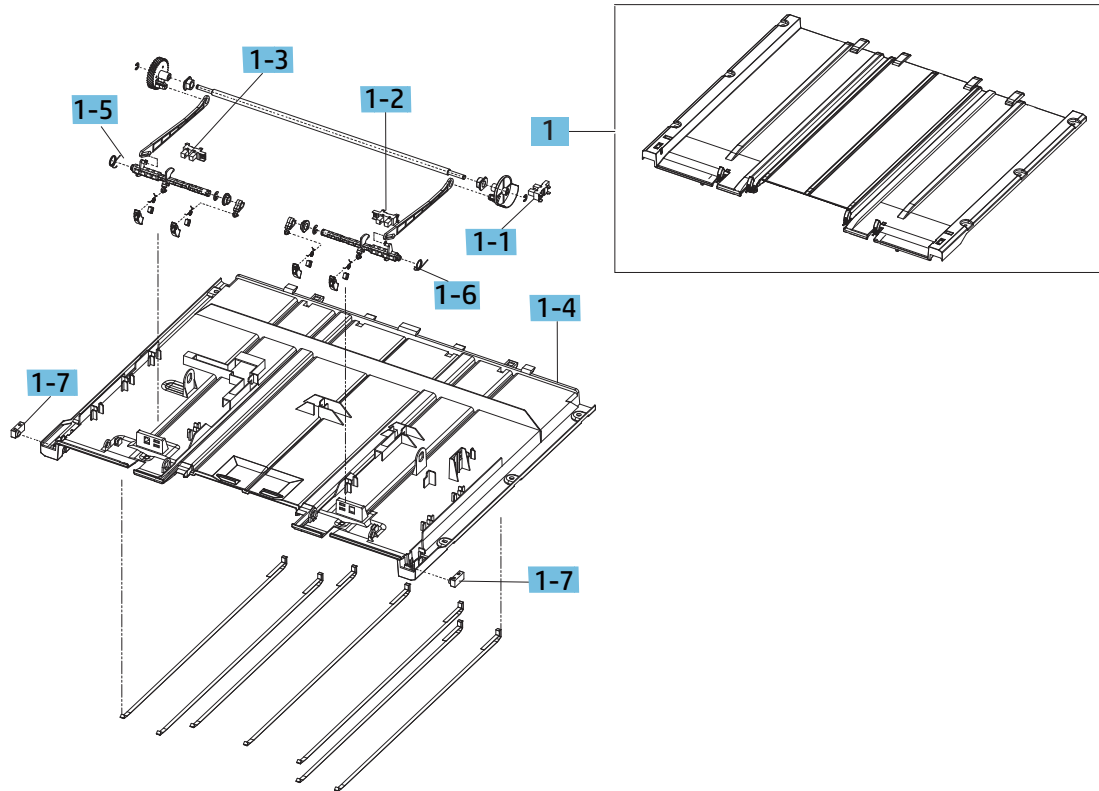




Table 5-64 Left upper cover

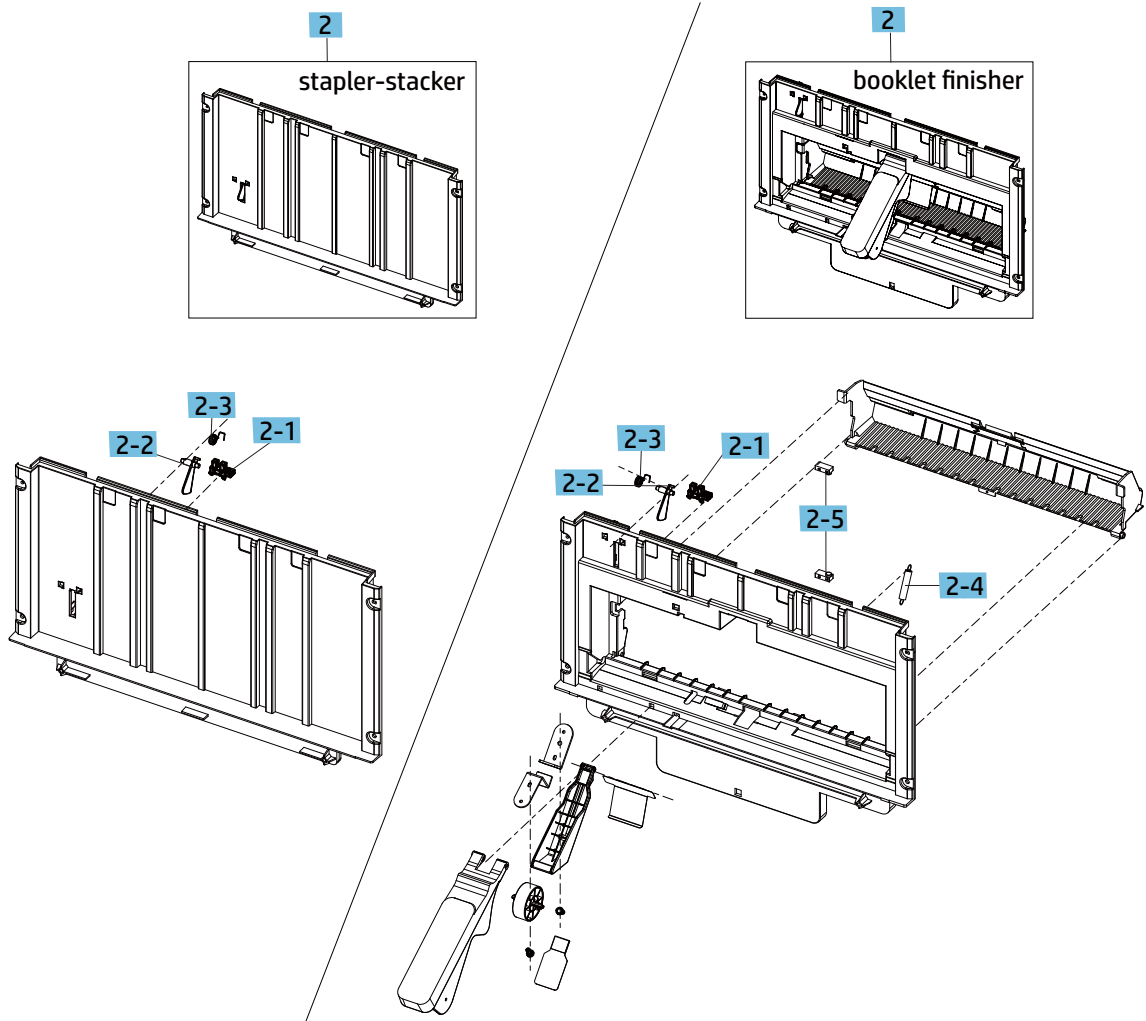
Ref	Description	Part number	Qty	Orderable
1	Left upper cover	JC90-01475B	1	(*)
1-1	Paper holding home sensor	0604-001393	1	(*)
1-2	Front paper holding sensor	0604-001393	1	(*)
1-3	Rear paper holding sensor	0604-001393	1	(*)
1-4	Left upper cover	JC63-04999B	1	(*)
1-5	Spring	JC61-07428A	1	(*)
1-6	Spring	JC61-07427A	1	(*)
1-7	Main output tray top of stack sensor	JC82-01039A	1	(*)

(\*) This part is in ordering system.

## Left lower cover

Parts diagram and parts list for the left lower cover.

Figure 5-105 Left lower cover



**Table 5-65** Left lower cover

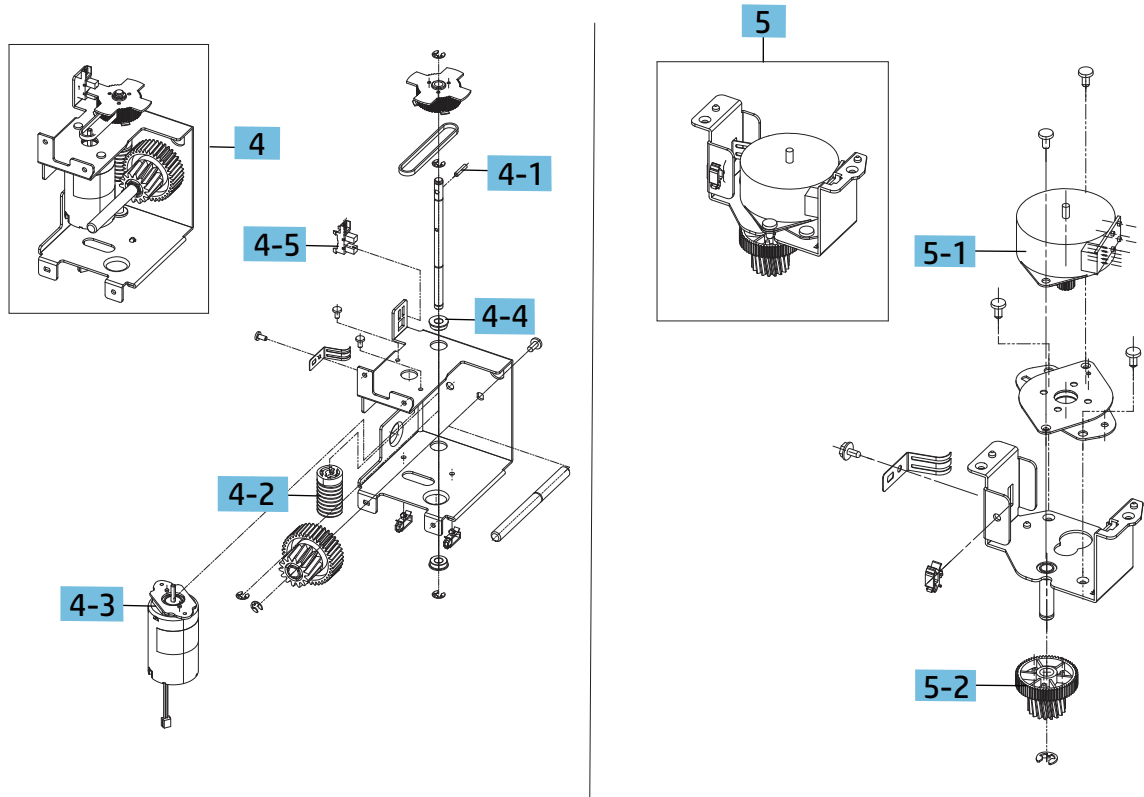
Ref	Description	Part number	Qty	Orderable
2	Left lower cover (Booklet finisher)	JC90-01417B	1	(*)
2	Left lower cover (Stapler-stacker finisher)	JC90-01771B	1	(*)
2-1	Main output tray lower limit switch	0604-001415	1	(*)
2-2	Main output tray lower limit actuator	JC81-07930A	1	(*)
2-3	Spring	JC81-09396A	1	(*)
2-4	Spring (Booklet finisher)	JC61-07407A	1	(*)
2-5	Booklet output tray sensor (Booklet finisher)	JC82-01039A	1	(*)

(\*) This part is in ordering system.

## Main output tray motor, Paper holding motor

Parts diagram and parts list for the main output tray motor, paper holding motor.

Figure 5-106 Main output tray motor, paper holding motor



**Table 5-66** Main output tray motor, paper holding motor

Ref	Description	Part number	Qty	Orderable
4	Main output tray motor assembly	JC90-01415B	1	(*)
4-1	Pin	JC70-40542A	1	(*)
4-2	Gear	JC81-07637A	1	(*)
4-3	Main output tray motor	JC31-00178B	1	(*)
4-4	Bearing	6601-001478	1	(*)
4-5	Main output tray motor sensor	0604-001415	1	(*)
5	Paper holding motor assembly	JC90-01414A	1	(*)
5-1	Paper holding motor	JC93-01156A	1	(*)
5-2	Gear	JC66-04604A	1	(*)

(\*) This part is in ordering system.

## Cover & harness

### Buffer unit

Parts diagram and parts list for the buffer unit.

Figure 5-107 Buffer unit

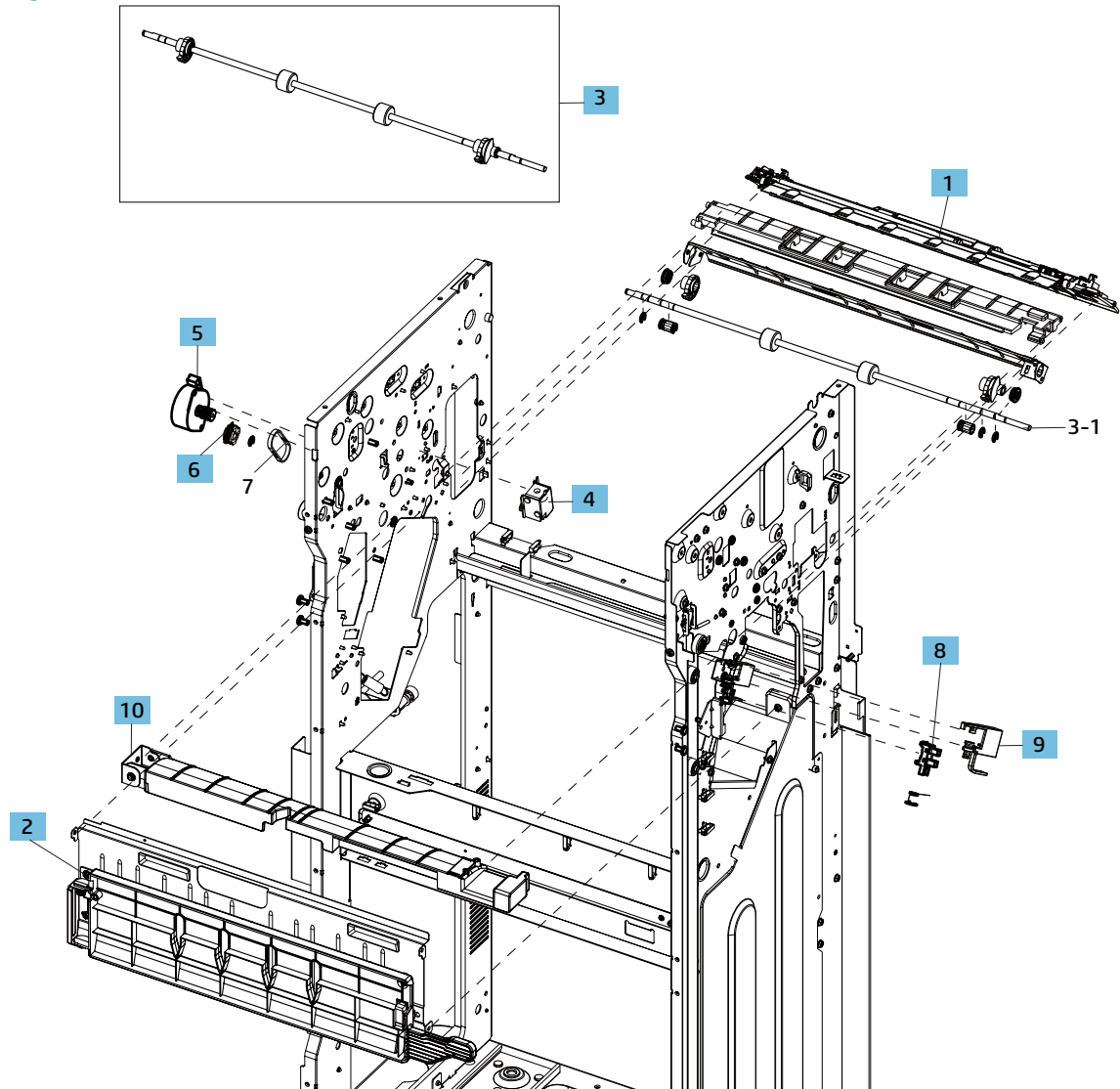


Table 5-67 Buffer unit

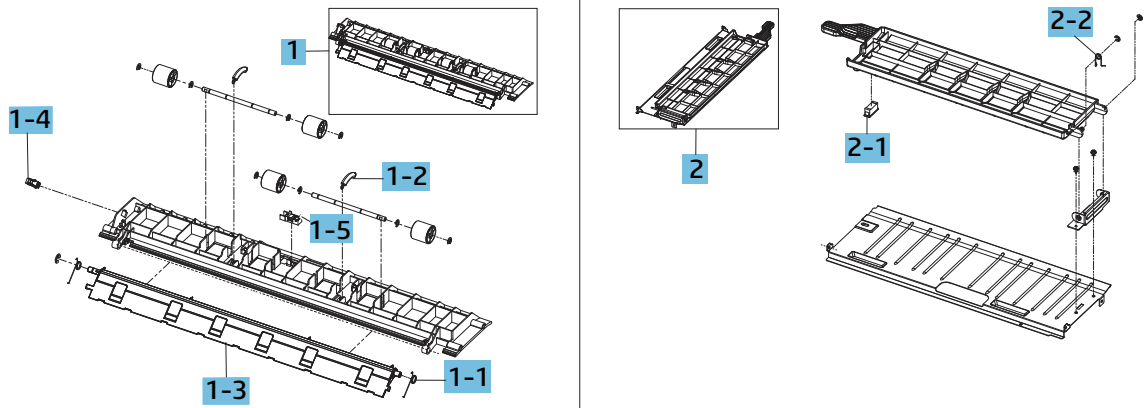
Ref	Description	Part number	Qty	Orderable
1	Buffer diverter assembly	JC90-01674A	1	(*)
2	Front jam cover assembly	JC90-01457A	1	(*)
3	Budder roller assembly	JC90-01672A	1	(*)
3-1	Buffer roller	JC66-05161A	1	
4	Buffer solenoid	JC90-01675A	1	(*)
5	Buffer motor	JC93-01152A	1	(*)
6	Gear	JC66-04582A	1	(*)
7	Belt	6602-003641	1	
8	Manual staple sensor	0604-001415	1	(*)
9	Manual staple actuator	JC66-04528A	1	(*)
10	Buffer jam cover	JC90-01450A	1	(*)

(\*) This part is in ordering system.

## Buffer diverter, Front jam cover

Parts diagram and parts list for the buffer diverter, front jam cover.

Figure 5-108 Buffer diverter, Front jam cover





**Table 5-68** Buffer diverter, Front jam cover


Ref	Description	Part number	Qty	Orderable
1	Buffer diverter assembly	JC90-01674A	1	(*)
1-1	Spring	JC61-07413A	2	(*)
1-2	Spring	JC61-07409A	2	(*)
1-3	Buffer diverter	JC61-07204A	1	(*)
1-4	Buffer home sensor	0604-001393	1	(*)
1-5	Buffer sensor	JC32-00020A	1	(*)
2	Front jam cover assembly	JC90-01457A	1	(*)
2-1	Magnet	JC81-08263A	1	(*)
2-2	Spring	JC61-07418A	1	(*)

(\*) This part is in ordering system.

## Parts, diagrams (Booklet finisher)

Learn about parts, diagrams (booklet finisher)



**NOTE:**  Some parts are sensitive to electrostatic discharge (ESD). Always perform service work at an ESD-protected workstation or mat. If an ESD workstation or mat is not available, touch the sheet-metal chassis to provide a static ground before touching an ESD-sensitive assembly. Protect the ESD-sensitive assemblies by placing them in ESD pouches when they are out of the printer.

### Booklet maker

Parts diagram and parts list for the booklet maker.

Figure 5-109 Booklet maker

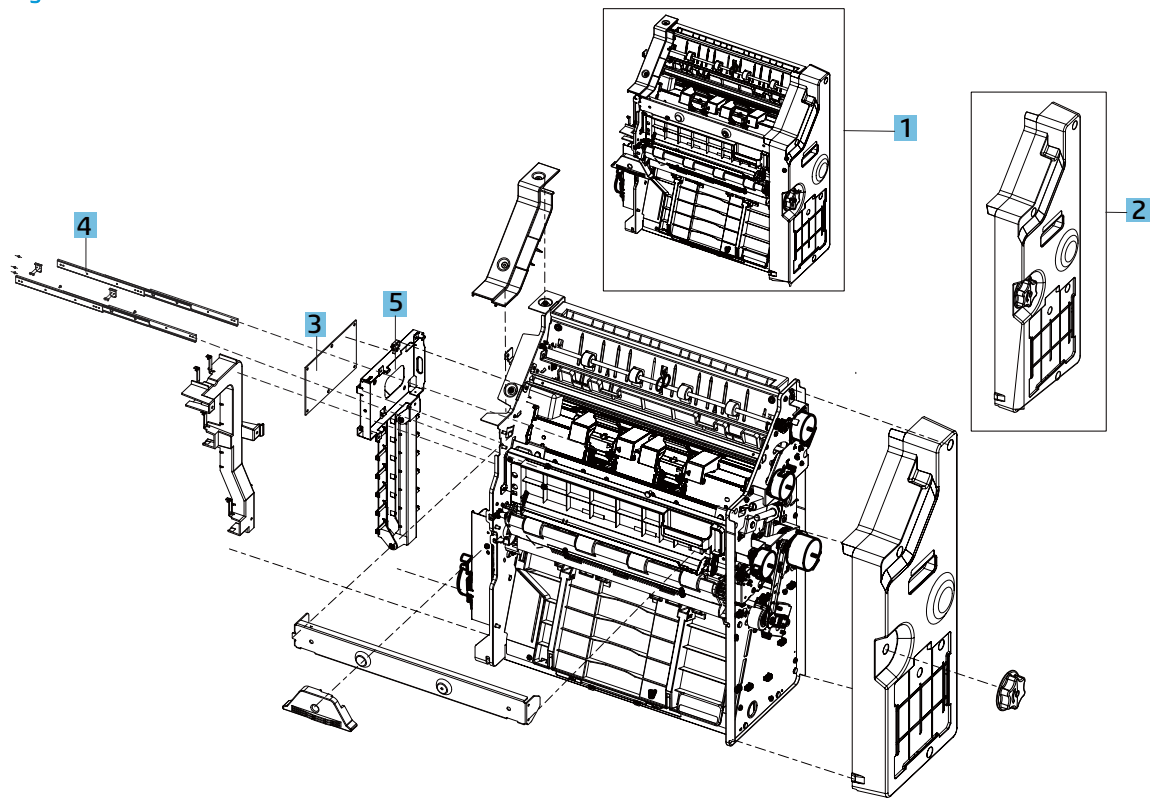


Table 5-69 Booklet maker

Ref	Description	Part number	Qty	Orderable
1	Booklet maker	JC82-00905A	1	(*)
2	Booklet front cover	JC90-01478B	1	(*)
3	Booklet maker PCA	JC92-02790B	1	(*)
4	Rail	6102-003369	2	(*)
5	Harness guide	JC90-01477A	1	(*)

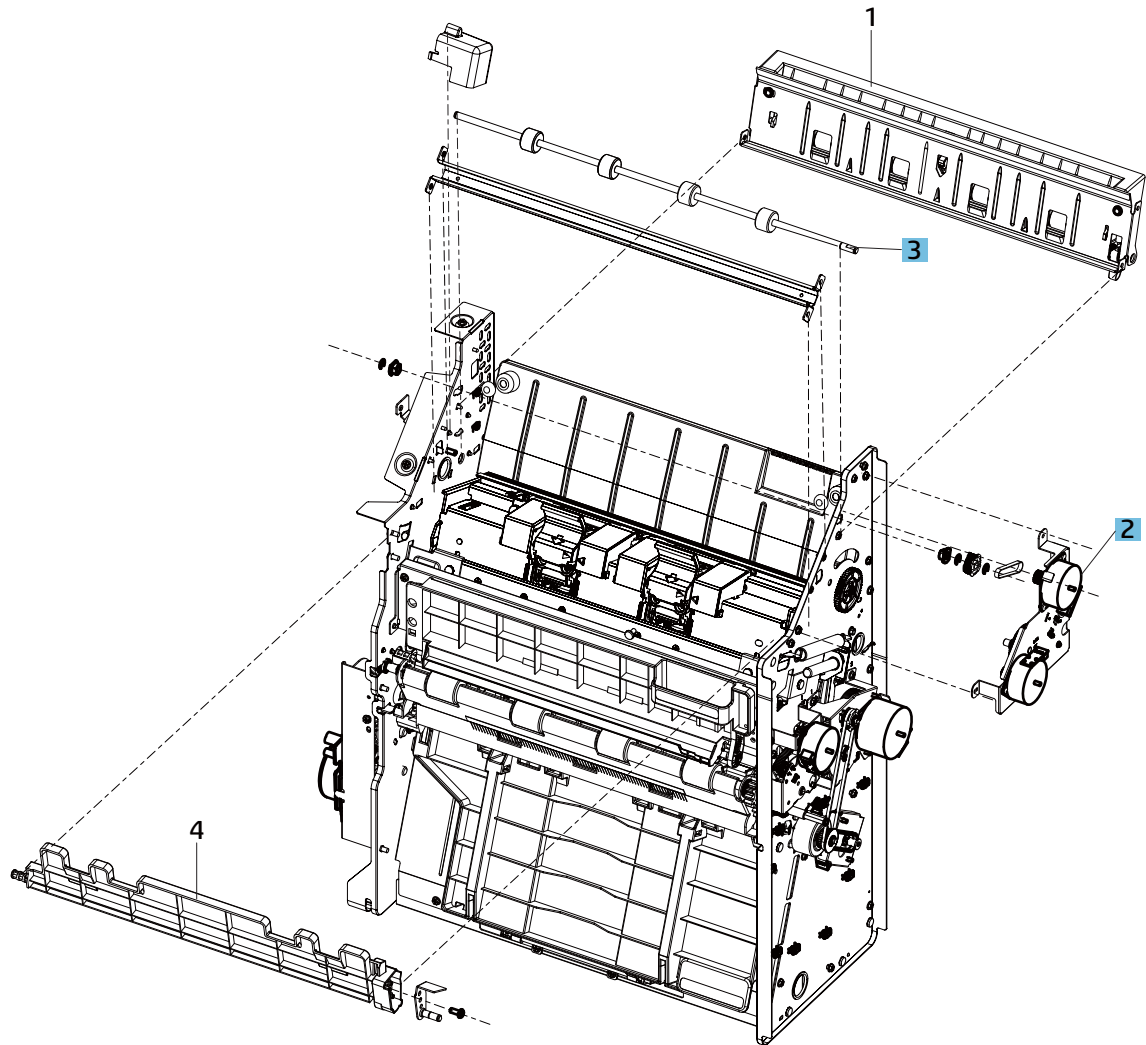
(\*) This part is in ordering system.

## Booklet entrance unit, Booklet presser unit

### Booklet entrance unit, Booklet presser unit

Parts diagram and parts list for the booklet entrance unit, booklet presser unit.

Figure 5-110 Booklet entrance unit, Booklet presser unit



**Table 5-70** Booklet entrance unit, Booklet presser unit

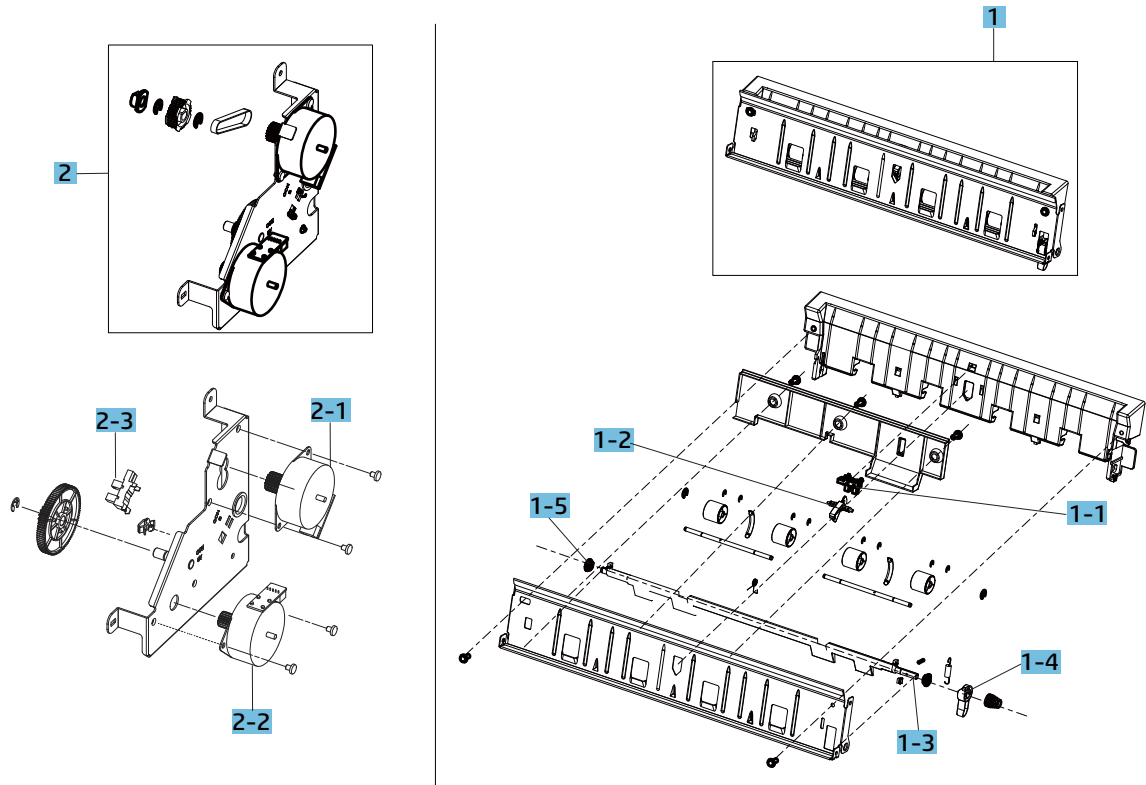
Ref	Description	Part number	Qty	Orderable
1	Booklet entrance unit	JC90-01424A	1	
2	Booklet entrance-presser motor assembly	JC90-01425A	1	(*)
3	Booklet entrance roller	JC66-04717A	1	(*)
4	Booklet presser unit	JC61-07237A	1	

(\*) This part is in ordering system.

## Booklet entrance, Booklet entrance-presser motor

Parts diagram and parts list for the booklet entrance, booklet entrance-presser motor.

Figure 5-111 Booklet entrance, Booklet entrance-presser motor



**Table 5-71** Booklet entrance, Booklet entrance-presser motor

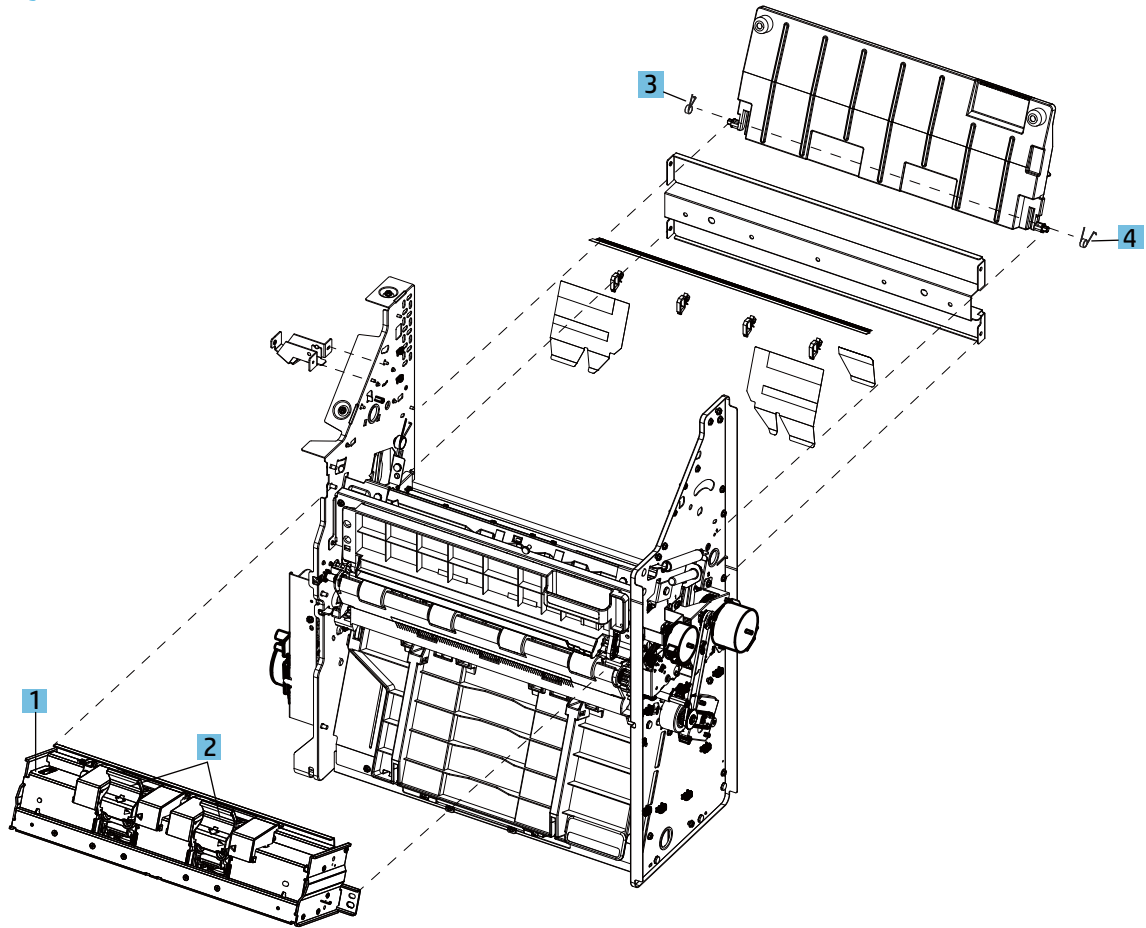
Ref	Description	Part number	Qty	Orderable
1	Booklet entrance unit	JC90-01424A	1	
1-1	Booklet entrance sensor	0604-001415	1	(*)
1-2	Booklet entrance actuator	JC66-04520A	1	(*)
1-3	Booklet presser guide	JC61-07331A	1	
1-4	Booklet presser guide actuator	JC66-04644A	1	(*)
1-5	Bushing	JC61-02372A	2	(*)
2	Booklet entrance-presser motor assembly	JC90-01425A	1	(*)
2-1	Booklet entrance motor	JC93-01152A	1	(*)
2-2	Booklet presser motor	JC93-01155A	1	(*)
2-3	Booklet presser home sensor	0604-001393	1	(*)

(\*) This part is in ordering system.

## Booklet stapler unit

Parts diagram and parts list for the booklet stapler unit.

Figure 5-112 Booklet stapler unit





**Table 5-72 Booklet stapler unit**

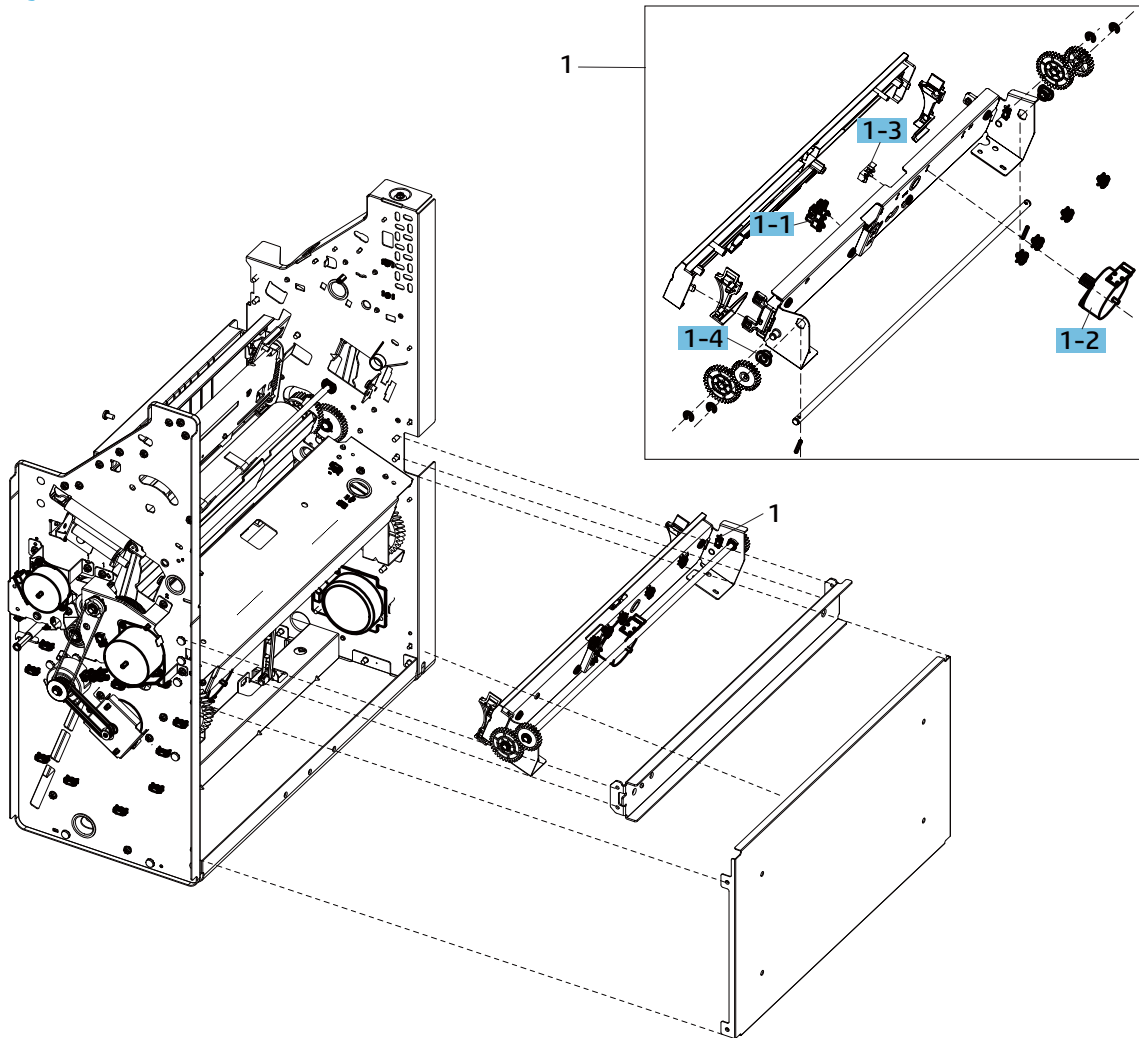
Ref	Description	Part number	Qty	Orderable
1	Booklet stapler unit	JC81-08274B	1	(*)
2	Booklet stapler cartridge	JC81-09881B	2	(*)
3	Spring	JC61-07398A	1	(*)
4	Spring	JC61-07397A	2	(*)

(\*) This part is in ordering system.

## Booklet tamper unit

Parts diagram and parts list for the booklet tamper unit.

Figure 5-113 Booklet tamper unit



**Table 5-73 Booklet tamper unit**

Ref	Description	Part number	Qty	Orderable
1	Booklet tamper unit	JC90-01431A	1	
1-1	Booklet tamper home sensor	0604-001393	1	(*)
1-2	Booklet tamper motor	JC93-01155A	1	(*)
1-3	Booklet tamper sensor	JC32-00020A	1	(*)
1-4	Bushing	JC61-00423A	2	(*)

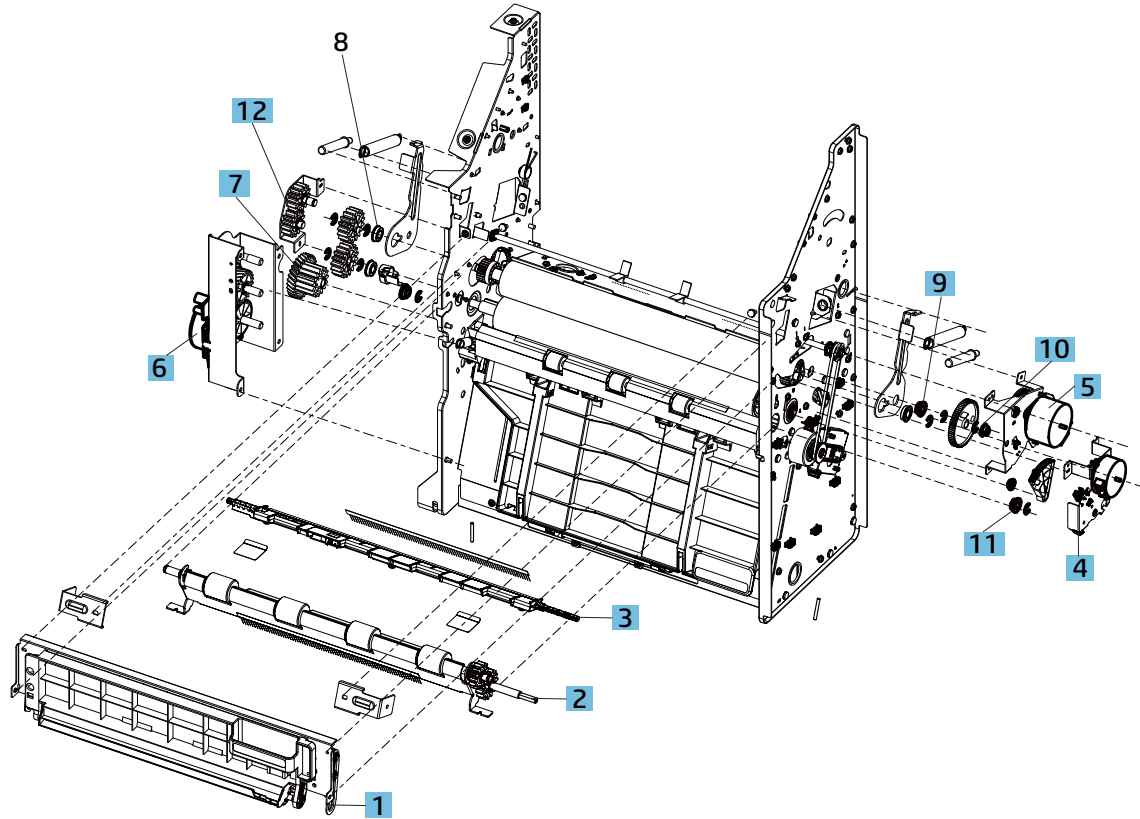
(\*) This part is in ordering system.

## Booklet fold unit, Booklet diverter unit, Booklet exit unit

### Booklet fold unit, Booklet diverter unit, Booklet exit unit

Parts diagram and parts list for the booklet fold unit, booklet diverter unit, booklet exit unit.

Figure 5-114 Booklet fold unit, Booklet diverter unit, Booklet exit unit



**Table 5-74** Booklet fold unit, Booklet diverter unit, Booklet exit unit

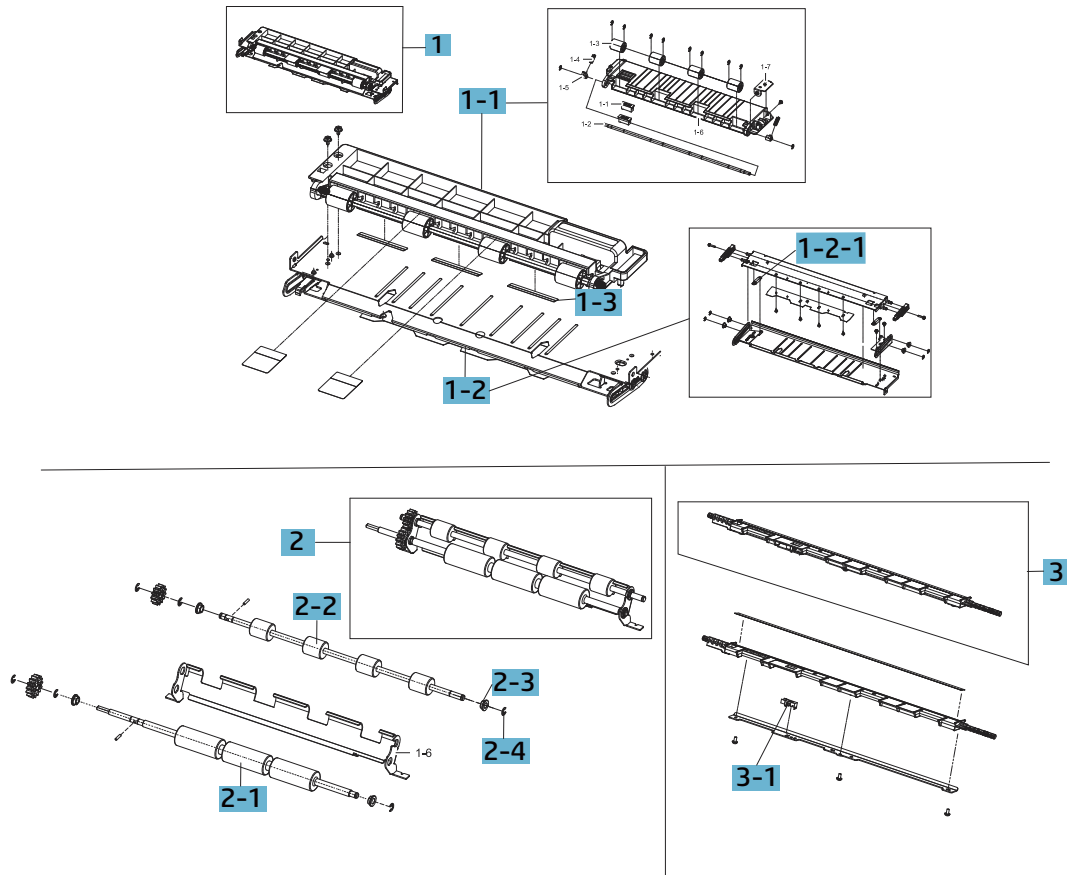
Ref	Description	Part number	Qty	Orderable
1	Booklet c-fold blade assembly	JC90-01438A	1	(*)
2	Booklet exit unit	JC90-01400A	1	(*)
3	Booklet diverter	JC90-01398A	1	(*)
4	Booklet diverter motor assembly	JC90-01397A	1	(*)
5	Booklet c-fold blade motor assembly	JC90-01396A	1	(*)
6	Booklet fold motor assembly	JC90-01436A	1	(*)
7	Gear	JC66-04573A	1	(*)
8	Bushing	6601-003037	3	
9	Bushing	JC61-00426A	1	(*)
10	Bushing	JC61-00423A	2	(*)
11	Bushing	JC61-02372A	1	(*)
12	Gear	JC90-01479A	1	(*)

(\*) This part is in ordering system.

## Booklet c-fold blade, Booklet exit, Booklet diverter

Parts diagram and parts list for the booklet c-fold blade, booklet exit, booklet diverter.

Figure 5-115 Booklet c-fold blade, Booklet exit, Booklet diverter



**Table 5-75** Booklet c-fold blade, Booklet exit, Booklet diverter

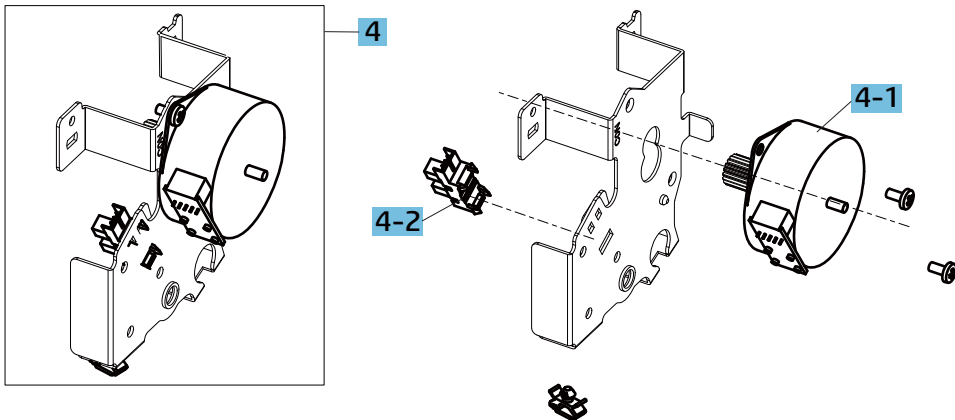
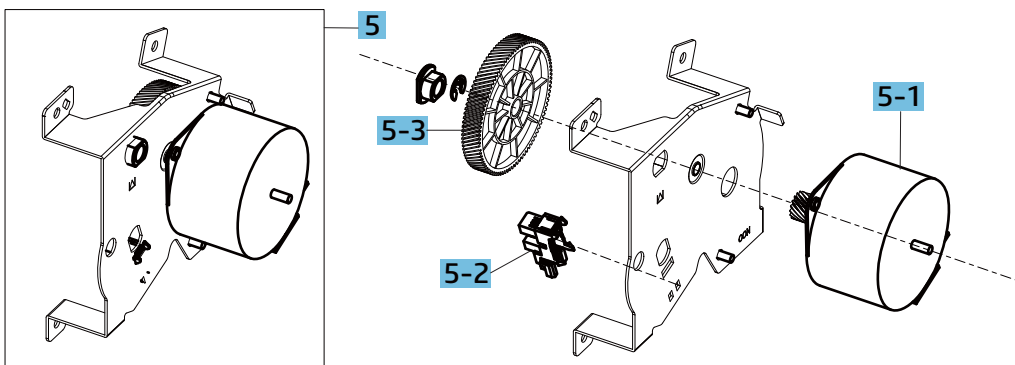
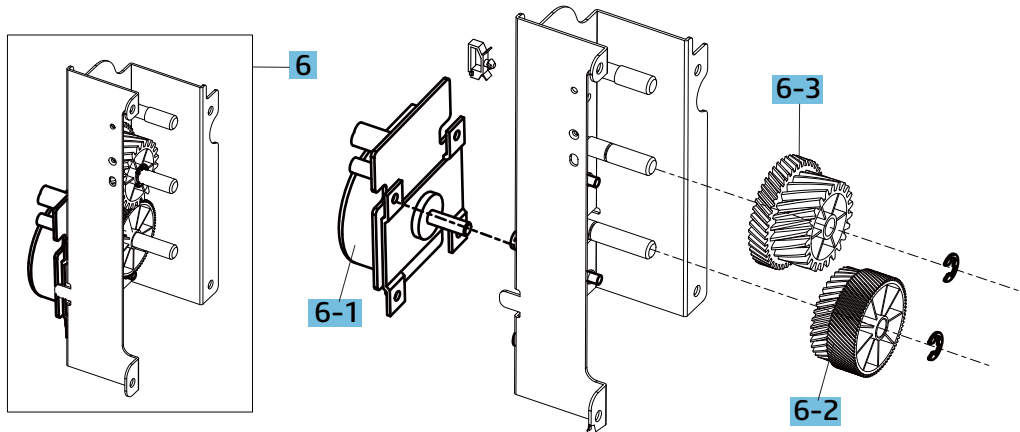
Ref	Description	Part number	Qty	Orderable
1	Booklet c-fold blade assembly	JC90-01438A	1	(*)
1-1	Booklet sub exit roller assembly	JC90-01395A	1	(*)
1-2	Booklet c-fold blade	JC90-01394A	1	(*)
1-2-1	Spring	JC61-07391A	2	(*)
1-3	Jam guide sheet	JC63-05044A	3	(*)
2	Booklet exit unit	JC90-01400A	1	(*)
2-1	Booklet c-fold roller	JC66-04744A	1	
2-2	Booklet exit roller	JC66-04721A	1	(*)
2-3	Bushing	JC61-00426A	4	(*)
2-4	E-ring	6044-000129	2	(*)
3	Booklet diverter	JC90-01398A	1	(*)
3-1	Booklet exit sensor	JC32-00020A	1	(*)

(\*) This part is in ordering system.

Booklet diverter motor, Booklet c-fold motor, Booklet fold motor

Parts diagram and parts list for the booklet diverter motor, booklet c-fold motor, booklet fold motor.

Figure 5-116 Booklet diverter motor, Booklet c-fold motor, Booklet fold motor





**Table 5-76** Booklet diverter motor, Booklet c-fold motor, Booklet fold motor

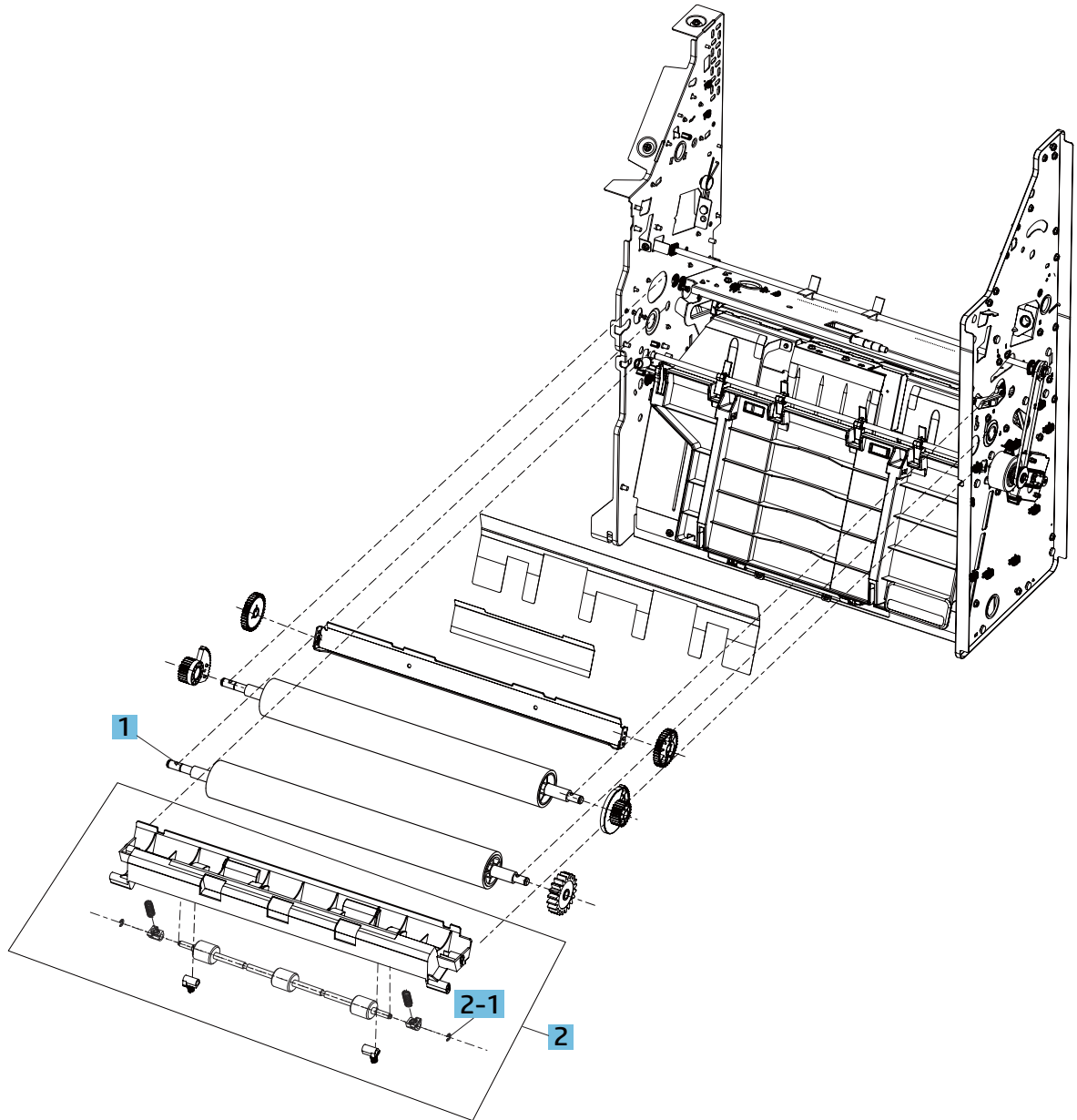
Ref	Description	Part number	Qty	Orderable
4	Booklet diverter motor assembly	JC90-01397A	1	(*)
4-1	Booklet diverter motor	JC93-01153A	1	(*)
4-2	Booklet diverter home sensor	0604-001415	1	(*)
5	Booklet c-fold blade motor assembly	JC90-01396A	1	(*)
5-1	Booklet c-fold blade motor	JC93-01154A	1	(*)
5-2	Booklet c-fold blade home sensor	0604-001393	1	(*)
5-3	Gear	JC66-04579A	1	(*)
6	Booklet fold motor assembly	JC90-01436A	1	(*)
6-1	Booklet fold motor	JC31-00144A	1	(*)
6-2	Gear	JC66-04592A	1	(*)
6-3	Gear	JC66-04593A	1	(*)

(\*) This part is in ordering system.

## Booklet fold roller

Parts diagram and parts list for the booklet fold roller.

Figure 5-117 Booklet fold roller



**Table 5-77 Booklet fold roller**

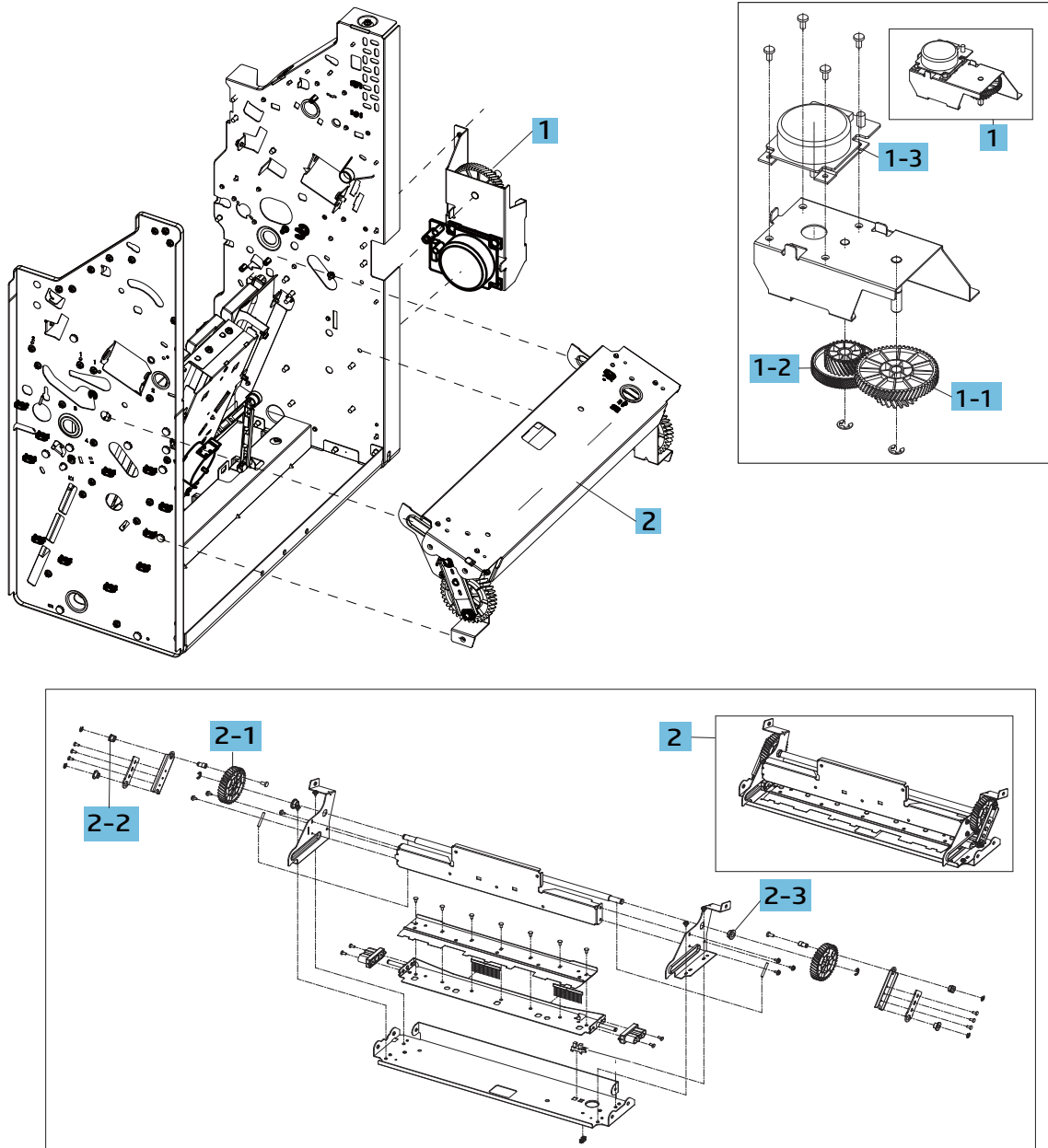
Ref	Description	Part number	Qty	Orderable
1	Booklet fold roller	JC66-04748A	2	(*)
2	Booklet fold exit	JC90-01399A	1	(*)
2-1	C-ring	6044-000159	1	(*)

(\*) This part is in ordering system.

## Booklet blade motor, Booklet blade

Parts diagram and parts list for the booklet blade motor, booklet blade.

Figure 5-118 Booklet blade motor, Booklet blade



**Table 5-78** Booklet blade motor, Booklet blade

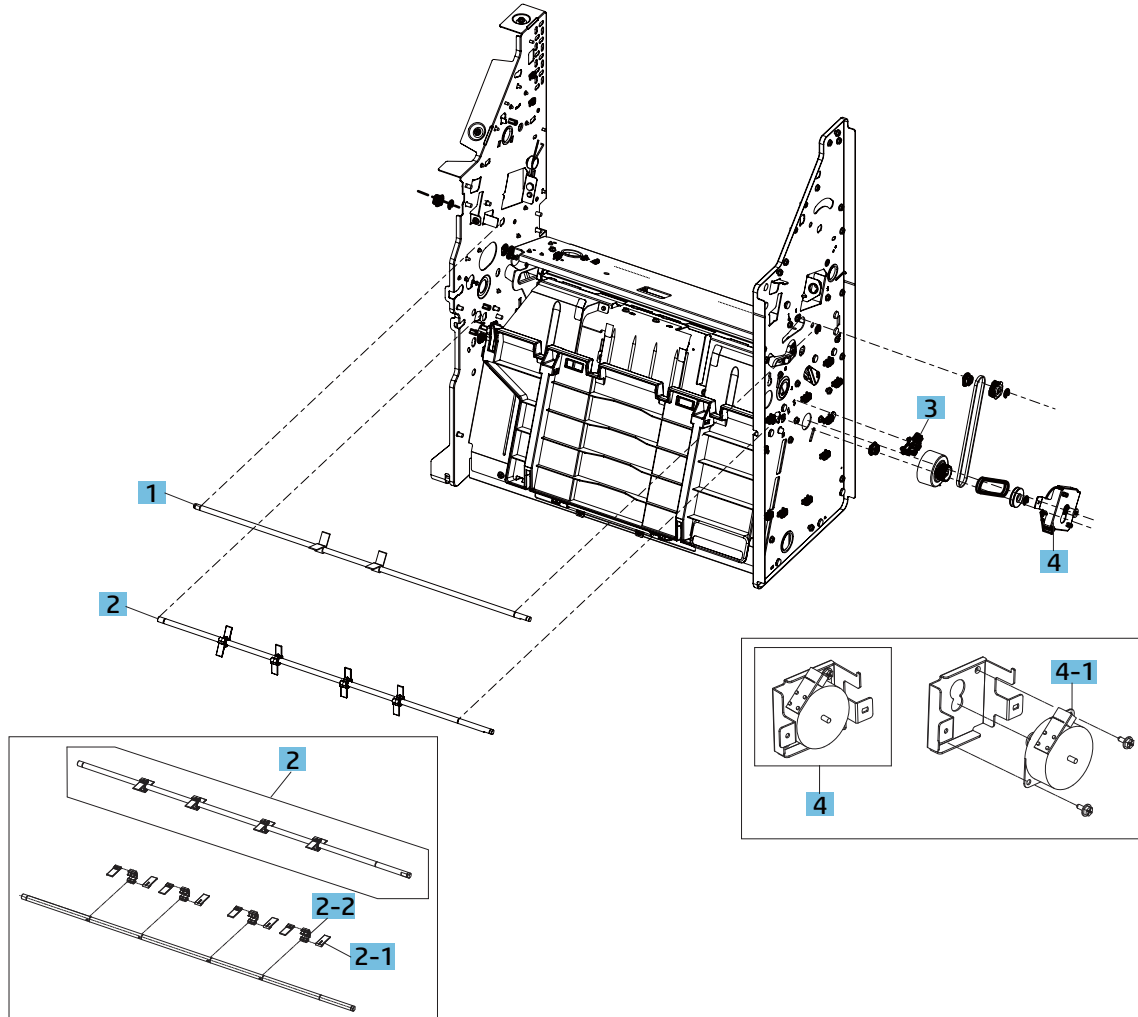
Ref	Description	Part number	Qty	Orderable
1	Booklet blade motor assembly	JC90-01435A	1	(*)
1-1	Gear	JC66-04595A	1	(*)
1-2	Gear	JC66-04594A	1	(*)
1-3	Booklet blade motor	JC31-00144A	1	(*)
2	Booklet blade assembly	JC90-01437A	1	(*)
2-1	Gear	JC66-04591A	1	(*)
2-2	Bushing	JC61-00423A	1	(*)
2-3	Bushing	JC61-00426A	2	(*)

(\*) This part is in ordering system.

## Booklet paddle unit

Parts diagram and parts list for the booklet paddle unit.

Figure 5-119 Booklet paddle unit



**Table 5-79 Booklet paddle unit**

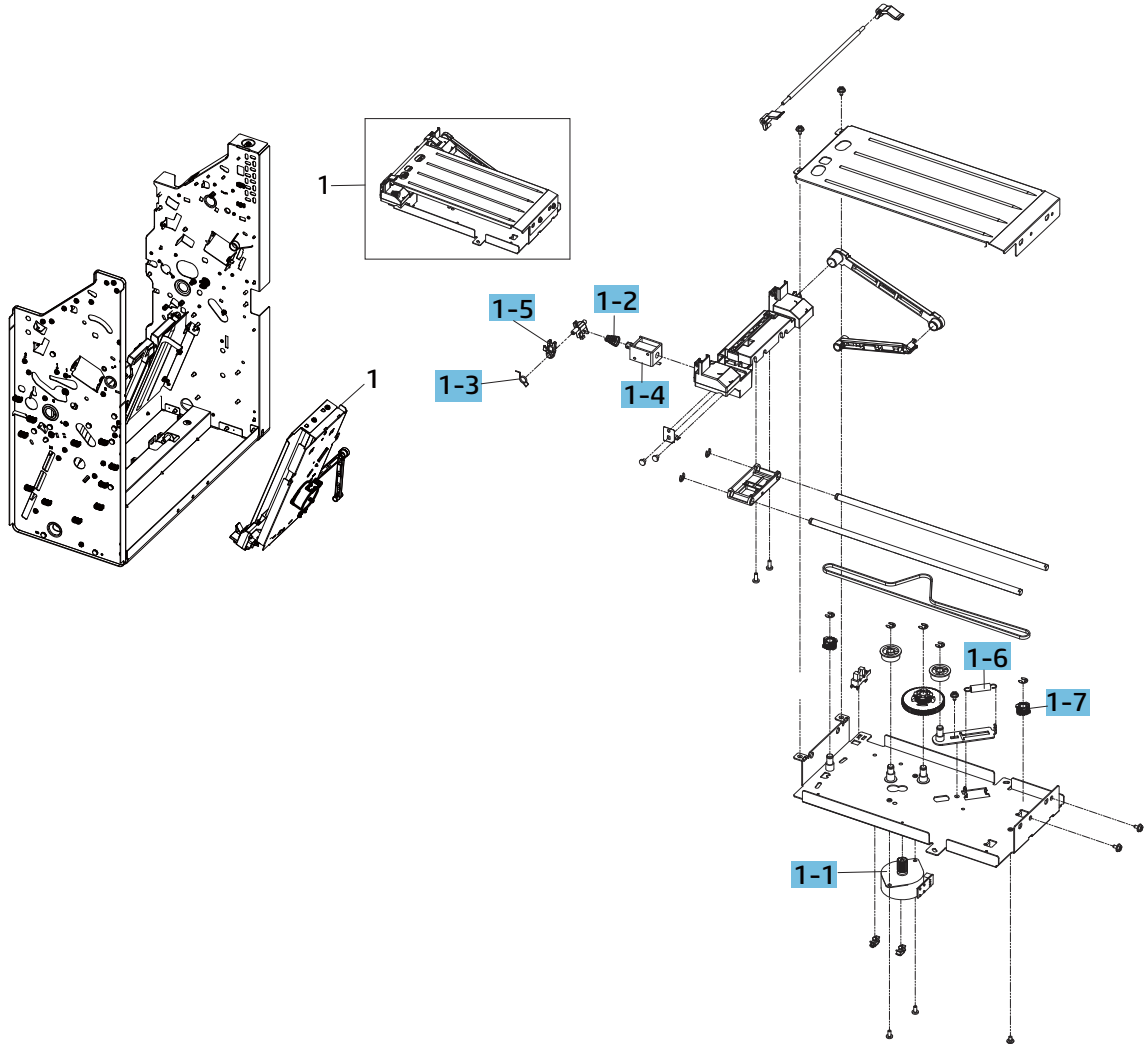
Ref	Description	Part number	Qty	Orderable
1	Upper booklet paddle	JC66-04718A	1	(*)
2	Lower booklet paddle	JC90-01429A	1	(*)
2-1	Lower booklet paddle wing	JC61-07225A	1	(*)
2-2	Lower booklet paddle mid	JC66-04719A	1	(*)
3	Booklet paddle home sensor	0604-001393	1	(*)
4	Booklet paddle motor assembly	JC90-01430A	1	(*)
4-1	Booklet paddle motor	JC93-01001A	1	(*)

(\*) This part is in ordering system.

## Booklet end fence unit

Parts diagram and parts list for the booklet end fence unit.

Figure 5-120 Booklet end fence unit





**Table 5-80 Booklet end fence unit**

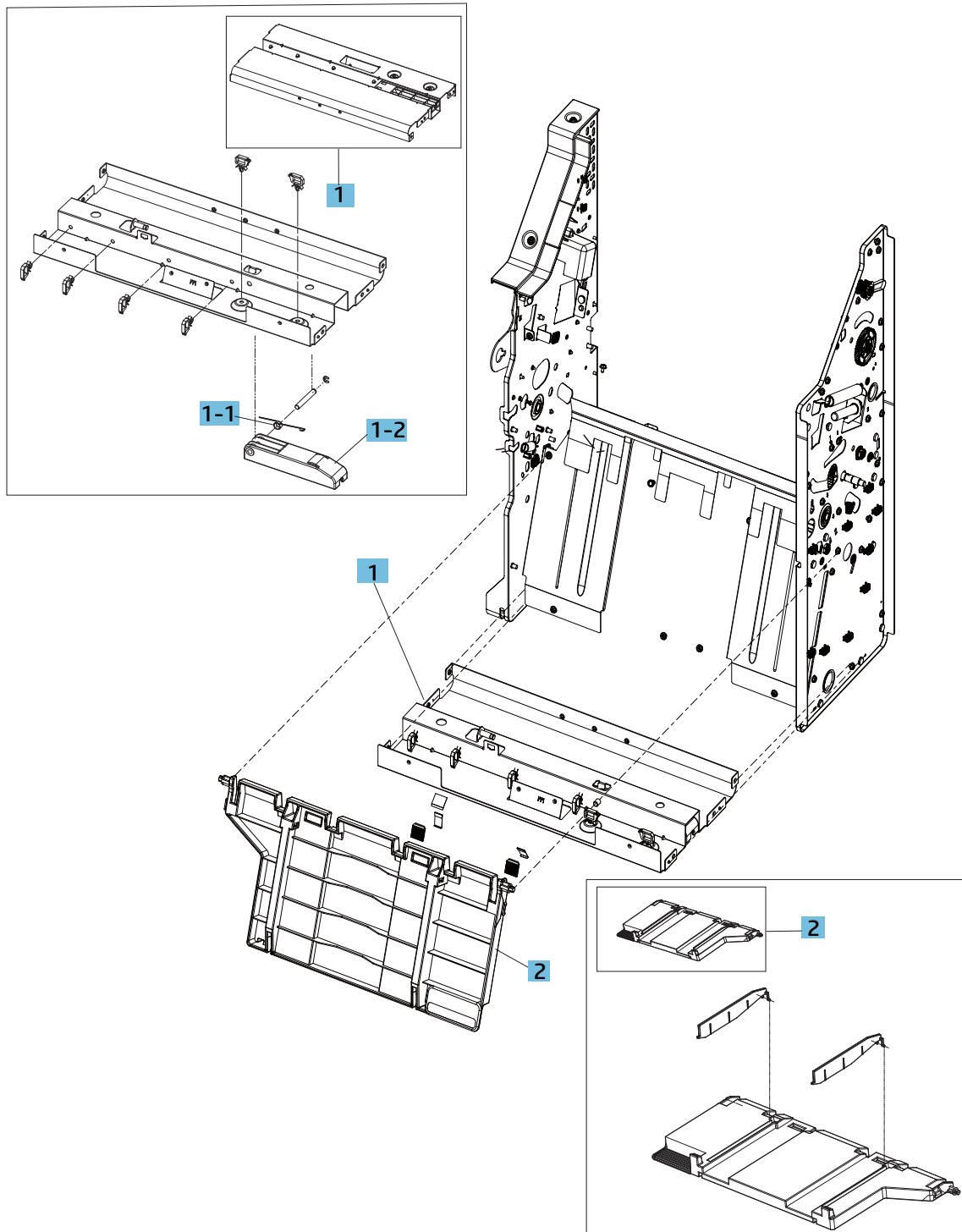
Ref	Description	Part number	Qty	Orderable
1	Booklet end fence unit	JC90-01432A	1	
1-1	Booklet end fence motor	JC93-01155A	1	(*)
1-2	Spring	JC61-07403A	1	(*)
1-3	Spring	JC61-07401A	1	(*)
1-4	Solenoid	JC33-00038A	1	(*)
1-5	Booklet end fence home sensor	0604-001393	1	(*)
1-6	Spring	JC61-07400A	1	(*)
1-7	Gear	JC66-04583A	1	(*)

(\*) This part is in ordering system.

## Booklet maker base

Parts diagram and parts list for the booklet maker base.

Figure 5-121 Booklet maker base



**Table 5-81 Booklet maker base**

Ref	Description	Part number	Qty	Orderable
1	Booklet maker base	JC90-01476A	1	(*)
1-1	Spring	JC61-07392A	1	(*)
1-2	Booklet maker base support	JC61-07279A	1	(*)
2	Booklet output jam cover	JC90-01433A	1	(*)

(\*) This part is in ordering system.


## Bridge unit

## Removal and replacement: Bridge entrance sensor (S1)

Learn how to remove and replace the bridge entrance sensor.

### Introduction

This document provides the procedures to remove and replace the bridge entrance sensor on the finisher.

 **IMPORTANT:** When applicable, special installation instructions are provided for an assembly at the end of the removal procedure. Always completely read the removal instructions and follow all special installation instructions.

### Before performing service

- Turn the printer power off. A shutting-down message appears on the control-panel display.
- ⚠ **WARNING!** To avoid damage to the printer, turn the power off and wait until the printer shuts down before removing the power cable.
- Disconnect the printer power cable after the printer has completely shut down (the control-panel display is blank).
- Release the finisher from the printer by pulling out on the release latch inside the finisher door.
- Disconnect the cable from the bridge unit to the finisher.
- Disconnect the cable from the finisher to the printer.

Use the table below to identify the correct part number for your printer. To order the part, go to <https://parts.hp.com>.

**Table 5-82 Part information**

Part number	Part description
JC32-00020A	Bridge entrance sensor

### Required tools

- #2 JIS screwdriver with a magnetic tip

### After performing service

- Connect the cable from the finisher to the printer.
- Connect the cable from the bridge unit to the finisher.
- Attach the finisher to the printer, and then push in on the release latch inside the finisher door.
- Connect the printer power cable.
- Turn the printer power on.

### Post service test

Process a job through the finisher and verify that the finisher works correctly.

## Remove the bridge from the machine

Follow these steps to remove the bridge from the machine.

1. Open the front door (callout 1)

Figure 5-122 Open the front door



2. Pull the locker out (callout 1)

Figure 5-123 Pull the locker out



3. Separate the finisher from the printer and disconnect the two connectors (callout 1)

Figure 5-124 Separate the finisher from the printer and disconnect the two connectors



4. Pull out the bridge unit(Callout 1) from the printer

Figure 5-125 Pull out the bridge unit

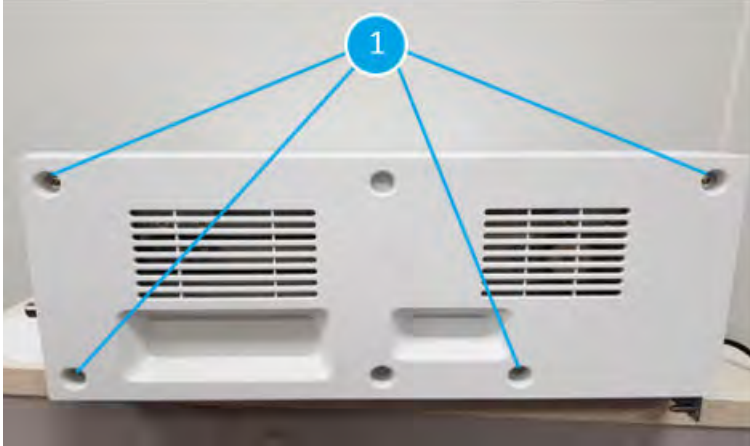


#### Remove the bridge rear cover

Follow these steps to remove the bridge rear cover.

- ▲ Remove four screws(callout 1) and the bridge rear cover.

Figure 5-126 Remove the bridge rear cover

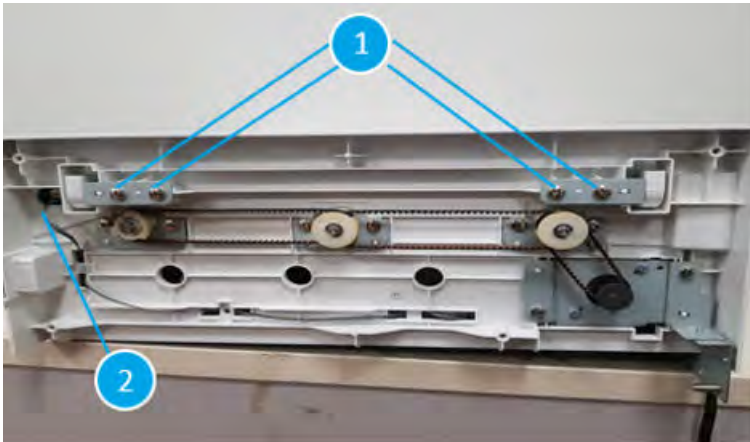


### Remove the bridge door

Follow these steps to remove the bridge door.

1. Remove four screws (callout 1) and remove the metal holders each side then disconnect one connector (callout 2)

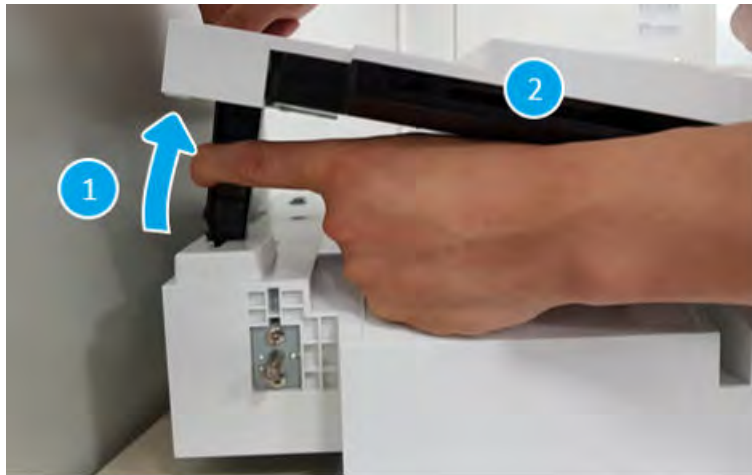
Figure 5-127 Remove the screws and a connector





2. Lift the bridge door up(callout 1) and then remove the bridge door(callout 2)

Figure 5-128 Remove the bridge door

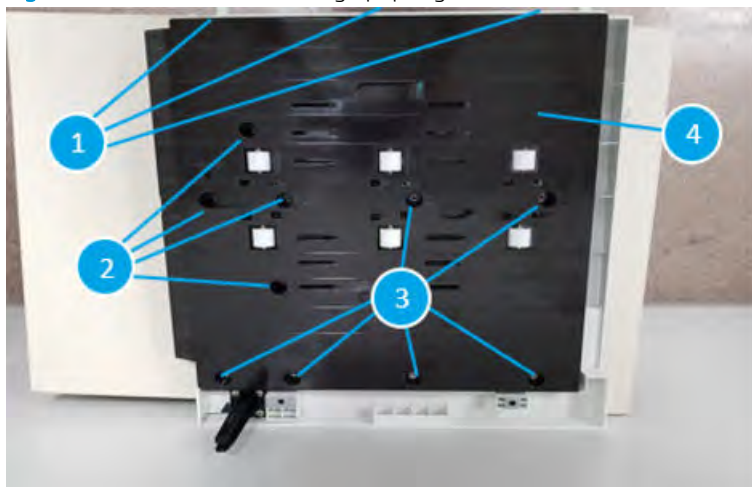


### Remove the bridge paper guide

Follow these steps to remove the bridge paper guide.

- ▲ Remove thirteen screws(callout 1~3) and remove the bridge paper guide(callout 4) from the bridge door

Figure 5-129 Remove the bridge paper guide

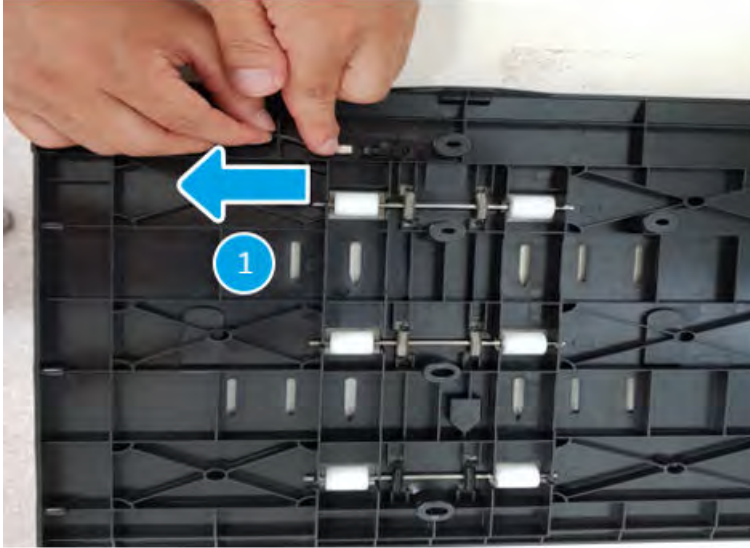


### Remove the bridge entrance sensor (S1)

Follow these steps to remove the bridge entrance sensor (S1).

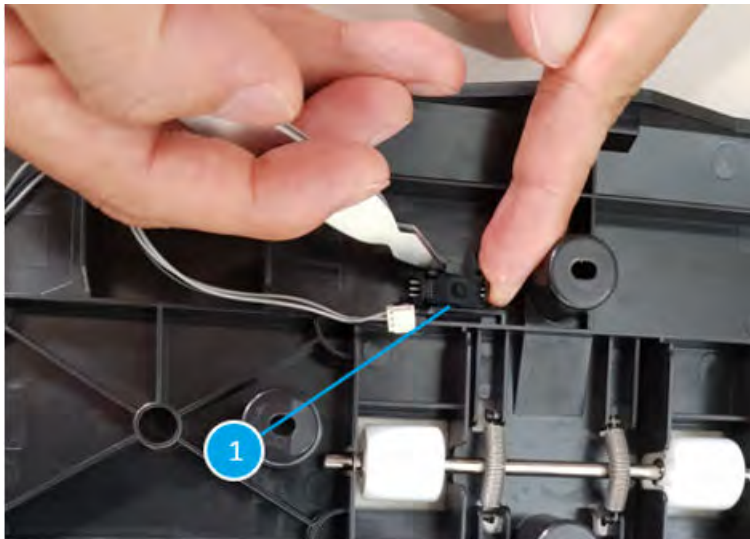
1. Unplug one connector (callout 1)

Figure 5-130 Unplug one connector



2. Use a tweezer to remove the bridge entrance sensor (S1, callout 1)

Figure 5-131 Remove the bridge entrance sensor



### Unpack the replacement assembly

Follow these steps to unpack the replacement assembly.

1. Dispose of the defective part.



---

 **NOTE:** HP recommends responsible disposal of the defective part.


<http://www8.hp.com/us/en/hp-information/environment/product-recycling.html>

---

2. Unpack the replacement part from the packaging.


 **CAUTION:**  Some parts are sensitive to electrostatic discharge (ESD). Always perform service work at an ESD-protected workstation or mat. If an ESD workstation or mat is not available, touch the sheet-metal chassis to provide a static ground before touching an ESD-sensitive assembly. Protect the ESD-sensitive assemblies by placing them in ESD pouches when they are out of the printer.

 **IMPORTANT:** Make sure that all of the shipping materials (for example shipping tape) are removed from the replacement part prior to installation.

 **NOTE:** If the replacement part is a roller or pad, avoid touching the spongy part of it. Skin oils on the roller or pad can cause paper pickup and/or print-quality problems. HP recommends using disposable gloves when handling rollers or pads or washing your hands before touching rollers or pads.

---

3. To install an assembly, reverse the removal steps.

 **NOTE:** When applicable, special installation instructions are provided for an assembly at the end of the removal procedure. Always completely read the removal instructions and follow all special installation instructions.


---

## Removal and replacement: Bridge motor (M14)

Learn how to remove and replace the bridge motor.

### Introduction

This document provides the procedures to remove and replace the bridge motor on the finisher.

 **IMPORTANT:** When applicable, special installation instructions are provided for an assembly at the end of the removal procedure. Always completely read the removal instructions and follow all special installation instructions.

### Before performing service

- Turn the printer power off. A shutting-down message appears on the control-panel display.
- ⚠ **WARNING!** To avoid damage to the printer, turn the power off and wait until the printer shuts down before removing the power cable.
- Disconnect the printer power cable after the printer has completely shut down (the control-panel display is blank).
- Release the finisher from the printer by pulling out on the release latch inside the finisher door.
- Disconnect the cable from the bridge unit to the finisher.
- Disconnect the cable from the finisher to the printer.

Use the table below to identify the correct part number for your printer. To order the part, go to <https://parts.hp.com>.

**Table 5-83 Part information**

Part number	Part description
JC31-00163B	Bridge motor

### Required tools

- #2 JIS screwdriver with a magnetic tip

### After performing service

- Connect the cable from the finisher to the printer.
- Connect the cable from the bridge unit to the finisher.
- Attach the finisher to the printer, and then push in on the release latch inside the finisher door.
- Connect the printer power cable.
- Turn the printer power on.

### Post service test

Process a job through the finisher and verify that the finisher works correctly.

## Remove the bridge from the machine

Follow these steps to remove the bridge from the machine.

1. Open the front door (callout 1)

Figure 5-132 Open the front door



2. Pull the locker out (callout 1)

Figure 5-133 Pull the locker out



3. Separate the finisher from the printer and disconnect the two connectors (callout 1)

Figure 5-134 Separate the finisher from the printer and disconnect the two connectors



4. Pull out the bridge unit(Callout 1) from the printer

Figure 5-135 Pull out the bridge unit

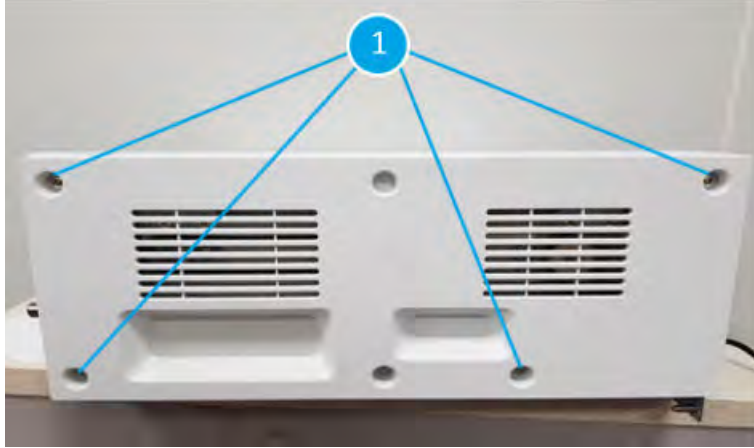


#### Remove the bridge rear cover

Follow these steps to remove the bridge rear cover.

- ▲ Remove four screws(callout 1) and the bridge rear cover.

Figure 5-136 Remove the bridge rear cover

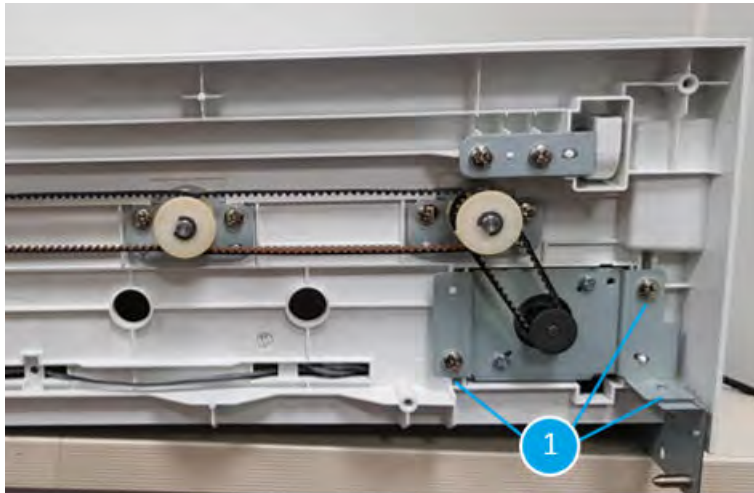


### Remove the bridge motor (M14)


Follow these steps to remove the bridge motor (M14).

1. Remove three screws (callout 1)

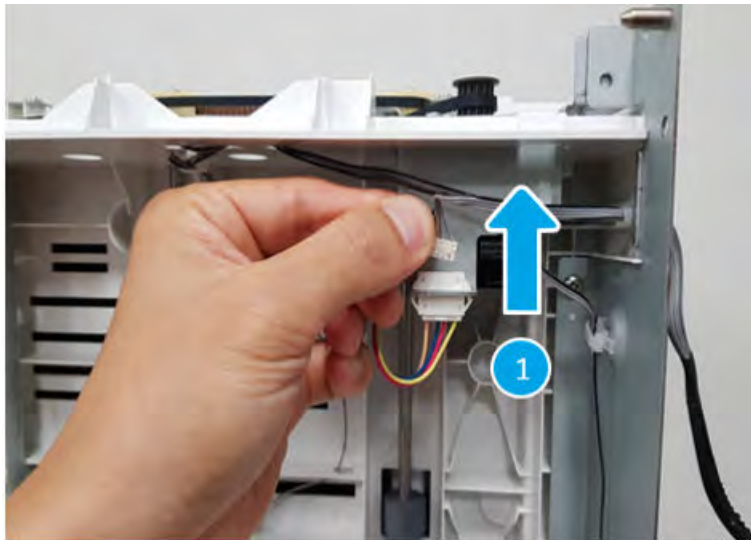
Figure 5-137 Remove three screws



2. Disconnect one connector(callout 1)

 **NOTE:** It located on the bottom of the bridge

**Figure 5-138** Disconnect one connector



3. Remove the belt (callout 1)

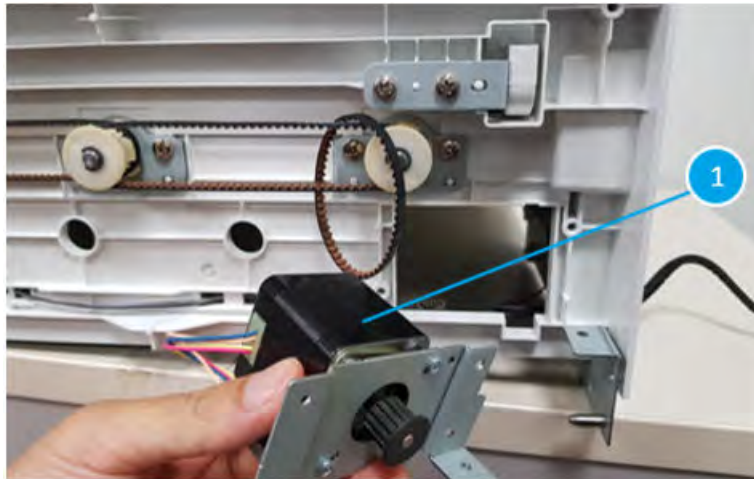
**Figure 5-139** Remove the belt





4. Remove the Bridge motor (M14, callout1)

Figure 5-140 Remove the Bridge motor



### Unpack the replacement assembly

Follow these steps to unpack the replacement assembly.

1. Dispose of the defective part.

---



 **NOTE:** HP recommends responsible disposal of the defective part.


<http://www8.hp.com/us/en/hp-information/environment/product-recycling.html>


---

2. Unpack the replacement part from the packaging.

---

 **CAUTION:**  Some parts are sensitive to electrostatic discharge (ESD). Always perform service work at an ESD-protected workstation or mat. If an ESD workstation or mat is not available, touch the sheet-metal chassis to provide a static ground before touching an ESD-sensitive assembly. Protect the ESD-sensitive assemblies by placing them in ESD pouches when they are out of the printer.


 **IMPORTANT:** Make sure that all of the shipping materials (for example shipping tape) are removed from the replacement part prior to installation.

 **NOTE:** If the replacement part is a roller or pad, avoid touching the spongy part of it. Skin oils on the roller or pad can cause paper pickup and/or print-quality problems. HP recommends using disposable gloves when handling rollers or pads or washing your hands before touching rollers or pads.

---

3. To install an assembly, reverse the removal steps.

---

 **NOTE:** When applicable, special installation instructions are provided for an assembly at the end of the removal procedure. Always completely read the removal instructions and follow all special installation instructions.


---

## Removal and replacement: Bridge exit sensor (S3)


Learn how to remove and replace the bridge exit sensor.

### Introduction

This document provides the procedures to remove and replace the bridge exit sensor on the finisher.

 **IMPORTANT:** When applicable, special installation instructions are provided for an assembly at the end of the removal procedure. Always completely read the removal instructions and follow all special installation instructions.

### Before performing service

- Turn the printer power off. A shutting-down message appears on the control-panel display.
-  **WARNING!** To avoid damage to the printer, turn the power off and wait until the printer shuts down before removing the power cable.
- Disconnect the printer power cable after the printer has completely shut down (the control-panel display is blank).
- Release the finisher from the printer by pulling out on the release latch inside the finisher door.
- Disconnect the cable from the bridge unit to the finisher.
- Disconnect the cable from the finisher to the printer.

Use the table below to identify the correct part number for your printer. To order the part, go to <https://parts.hp.com>.

**Table 5-84 Part information**

Part number	Part description
0604-001393	Bridge exit sensor

### Required tools

- #2 JIS screwdriver with a magnetic tip

### After performing service

- Connect the cable from the finisher to the printer.
- Connect the cable from the bridge unit to the finisher.
- Attach the finisher to the printer, and then push in on the release latch inside the finisher door.
- Connect the printer power cable.
- Turn the printer power on.

### Post service test

Process a job through the finisher and verify that the finisher works correctly.

## Remove the bridge from the machine

Follow these steps to remove the bridge from the machine.

1. Open the front door (callout 1)

Figure 5-141 Open the front door



2. Pull the locker out (callout 1)

Figure 5-142 Pull the locker out



3. Separate the finisher from the printer and disconnect the two connectors (callout 1)

**Figure 5-143** Separate the finisher from the printer and disconnect the two connectors



4. Pull out the bridge unit(Callout 1) from the printer

**Figure 5-144** Pull out the bridge unit




### Remove the bridge exit sensor (S3)

Follow these steps to remove the bridge exit sensor (S3).

1. Unplug one connector

---

 **NOTE:** Bridge exit sensor(callout 1) located on the bottom of the bridge

---

Figure 5-145 Unplug one connector

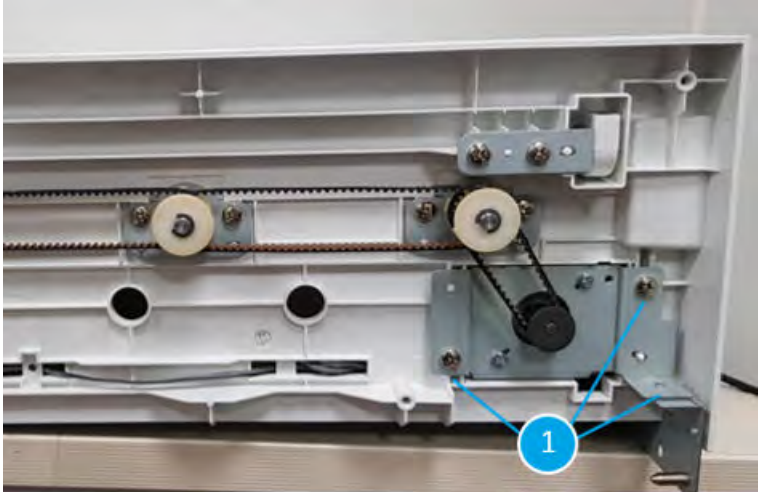
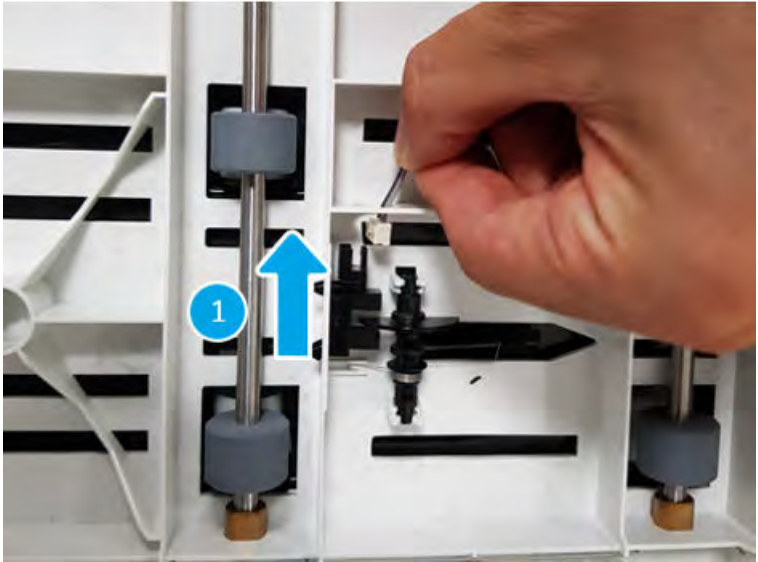


Figure 5-146 Unplug one connector



2. Use a tweezer to remove the bridge exit sensor(S3, callout1)

**Figure 5-147** Remove the bridge exit sensor



### Unpack the replacement assembly

Follow these steps to unpack the replacement assembly.

1. Dispose of the defective part.




**NOTE:** HP recommends responsible disposal of the defective part.

<http://www8.hp.com/us/en/hp-information/environment/product-recycling.html>

2. Unpack the replacement part from the packaging.



**CAUTION:**  Some parts are sensitive to electrostatic discharge (ESD). Always perform service work at an ESD-protected workstation or mat. If an ESD workstation or mat is not available, touch the sheet-metal chassis to provide a static ground before touching an ESD-sensitive assembly. Protect the ESD-sensitive assemblies by placing them in ESD pouches when they are out of the printer.



**IMPORTANT:** Make sure that all of the shipping materials (for example shipping tape) are removed from the replacement part prior to installation.



**NOTE:** If the replacement part is a roller or pad, avoid touching the spongy part of it. Skin oils on the roller or pad can cause paper pickup and/or print-quality problems. HP recommends using disposable gloves when handling rollers or pads or washing your hands before touching rollers or pads.

3. To install an assembly, reverse the removal steps.



**NOTE:** When applicable, special installation instructions are provided for an assembly at the end of the removal procedure. Always completely read the removal instructions and follow all special installation instructions.

## Removal and replacement: Bridge door sensor (S2)

Learn how to remove and replace the bridge door sensor.

### Introduction

This document provides the procedures to remove and replace the bridge door sensor on the finisher.



**IMPORTANT:** When applicable, special installation instructions are provided for an assembly at the end of the removal procedure. Always completely read the removal instructions and follow all special installation instructions.

### Before performing service

- Turn the printer power off. A shutting-down message appears on the control-panel display.
- ⚠ **WARNING!** To avoid damage to the printer, turn the power off and wait until the printer shuts down before removing the power cable.
- Disconnect the printer power cable after the printer has completely shut down (the control-panel display is blank).
- Release the finisher from the printer by pulling out on the release latch inside the finisher door.
- Disconnect the cable from the bridge unit to the finisher.
- Disconnect the cable from the finisher to the printer.

Use the table below to identify the correct part number for your printer. To order the part, go to <https://parts.hp.com>.

**Table 5-85 Part information**

Part number	Part description
0604-001393	Bridge door sensor

### Required tools

- #2 JIS screwdriver with a magnetic tip

### After performing service

- Connect the cable from the finisher to the printer.
- Connect the cable from the bridge unit to the finisher.
- Attach the finisher to the printer, and then push in on the release latch inside the finisher door.
- Connect the printer power cable.
- Turn the printer power on.

### Post service test

Process a job through the finisher and verify that the finisher works correctly.

## Remove the bridge from the machine

Follow these steps to remove the bridge from the machine.

1. Open the front door (callout 1)

Figure 5-148 Open the front door



2. Pull the locker out (callout 1)

Figure 5-149 Pull the locker out





3. Separate the finisher from the printer and disconnect the two connectors (callout 1)

Figure 5-150 Separate the finisher from the printer and disconnect the two connectors



4. Pull out the bridge unit(Callout 1) from the printer

Figure 5-151 Pull out the bridge unit



### Remove the bridge door sensor (S2)

Follow these steps to remove the bridge door sensor (S2).

1. Bridge door sensor(callout 1) located on the bottom of the bridge

Figure 5-152 Location of the bridge door sensor



2. Open the bridge door to remove the bridge door sensor (S2)

Figure 5-153 Open the bridge door



3. Use a tweezer to remove the bridge door sensor(S2, callout 1)

**Figure 5-154** Remove the bridge door sensor



### Unpack the replacement assembly

Follow these steps to unpack the replacement assembly.

1. Dispose of the defective part.

---



 **NOTE:** HP recommends responsible disposal of the defective part.


<http://www8.hp.com/us/en/hp-information/environment/product-recycling.html>


---

2. Unpack the replacement part from the packaging.

---

 **CAUTION:**  Some parts are sensitive to electrostatic discharge (ESD). Always perform service work at an ESD-protected workstation or mat. If an ESD workstation or mat is not available, touch the sheet-metal chassis to provide a static ground before touching an ESD-sensitive assembly. Protect the ESD-sensitive assemblies by placing them in ESD pouches when they are out of the printer.


 **IMPORTANT:** Make sure that all of the shipping materials (for example shipping tape) are removed from the replacement part prior to installation.

 **NOTE:** If the replacement part is a roller or pad, avoid touching the spongy part of it. Skin oils on the roller or pad can cause paper pickup and/or print-quality problems. HP recommends using disposable gloves when handling rollers or pads or washing your hands before touching rollers or pads.

---

3. To install an assembly, reverse the removal steps.

---

 **NOTE:** When applicable, special installation instructions are provided for an assembly at the end of the removal procedure. Always completely read the removal instructions and follow all special installation instructions.

---


## Covers

## Removal and replacement: Right upper cover

Learn how to remove and replace the right upper cover.

### Introduction

This document provides the procedures to remove and replace the right upper cover on the finisher.

 **IMPORTANT:** When applicable, special installation instructions are provided for an assembly at the end of the removal procedure. Always completely read the removal instructions and follow all special installation instructions.

### Before performing service

- Turn the printer power off. A shutting-down message appears on the control-panel display.
- ⚠ **WARNING!** To avoid damage to the printer, turn the power off and wait until the printer shuts down before removing the power cable.
- Disconnect the printer power cable after the printer has completely shut down (the control-panel display is blank).
- Release the finisher from the printer by pulling out on the release latch inside the finisher door.
- Disconnect the cable from the bridge unit to the finisher.
- Disconnect the cable from the finisher to the printer.

Use the table below to identify the correct part number for your printer. To order the part, go to <https://parts.hp.com>.

**Table 5-86 Part information**

Part number	Part description
JC90-01448B	Right upper cover

### Required tools

- #2 JIS screwdriver with a magnetic tip

### After performing service

- Connect the cable from the finisher to the printer.
- Connect the cable from the bridge unit to the finisher.
- Attach the finisher to the printer, and then push in on the release latch inside the finisher door.
- Connect the printer power cable.
- Turn the printer power on.

### Post service test

Process a job through the finisher and verify that the finisher works correctly.

## Remove the right upper cover (finisher)

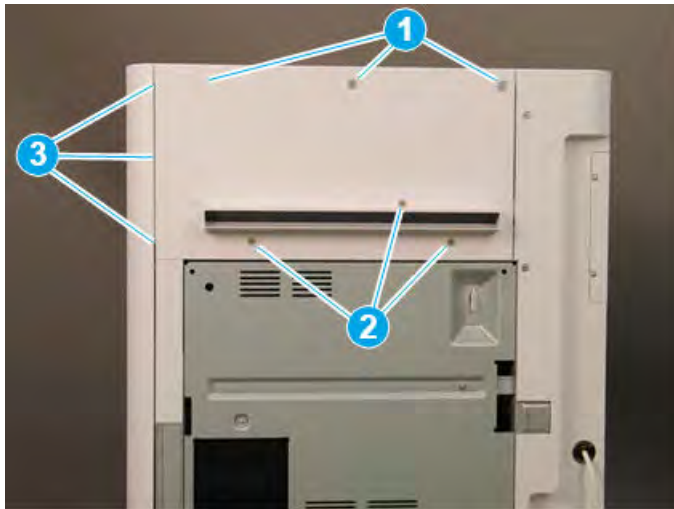
Follow these steps to remove the right upper cover (finisher).

- ▲ Remove one screw cap and three machine screws on the upper edge of the cover (callout 1). Remove three sheet metal screws (callout 2) on the lower portion of the cover. Rotate the right edge of the cover away from the finisher, and then slide the cover right to release three tabs (callout 3).

💡 **TIP:** The lower screws are shorter in length than the upper screws.

**TIP:** Reverse the removal steps to install the assembly.

**Figure 5-155** Remove the right upper cover



## Unpack the replacement assembly


Follow these steps to unpack the replacement assembly.

1. Dispose of the defective part.

📄 **NOTE:** HP recommends responsible disposal of the defective part.

<http://www8.hp.com/us/en/hp-information/environment/product-recycling.html>

2. Unpack the replacement part from the packaging.

⚠️ **CAUTION:**  Some parts are sensitive to electrostatic discharge (ESD). Always perform service work at an ESD-protected workstation or mat. If an ESD workstation or mat is not available, touch the sheet-metal chassis to provide a static ground before touching an ESD-sensitive assembly. Protect the ESD-sensitive assemblies by placing them in ESD pouches when they are out of the printer.

📄 **IMPORTANT:** Make sure that all of the shipping materials (for example shipping tape) are removed from the replacement part prior to installation.

📄 **NOTE:** If the replacement part is a roller or pad, avoid touching the spongy part of it. Skin oils on the roller or pad can cause paper pickup and/or print-quality problems. HP recommends using disposable gloves when handling rollers or pads or washing your hands before touching rollers or pads.

3. To install an assembly, reverse the removal steps.



---

**NOTE:** When applicable, special installation instructions are provided for an assembly at the end of the removal procedure. Always completely read the removal instructions and follow all special installation instructions.


---

## Removal and replacement: Top cover


Learn how to remove and replace the top cover.

### Introduction

This document provides the procedures to remove and replace the top cover of the finisher.

 **IMPORTANT:** When applicable, special installation instructions are provided for an assembly at the end of the removal procedure. Always completely read the removal instructions and follow all special installation instructions.

### Before performing service

- Turn the printer power off. A shutting-down message appears on the control-panel display.
-  **WARNING!** To avoid damage to the printer, turn the power off and wait until the printer shuts down before removing the power cable.
- Disconnect the printer power cable after the printer has completely shut down (the control-panel display is blank).
- Release the finisher from the printer by pulling out on the release latch inside the finisher door.
- Disconnect the cable from the bridge unit to the finisher.
- Disconnect the cable from the finisher to the printer.

Use the table below to identify the correct part number for your printer. To order the part, go to <https://parts.hp.com>.

**Table 5-87 Part information**

Part number	Part description
JC90-01446B	Top cover

### Required tools

- #2 JIS screwdriver with a magnetic tip

### After performing service

- Connect the cable from the finisher to the printer.
- Connect the cable from the bridge unit to the finisher.
- Attach the finisher to the printer, and then push in on the release latch inside the finisher door.
- Connect the printer power cable.
- Turn the printer power on.

### Post service test

Process a job through the finisher and verify that the finisher works correctly.



### Remove the right upper cover (finisher)

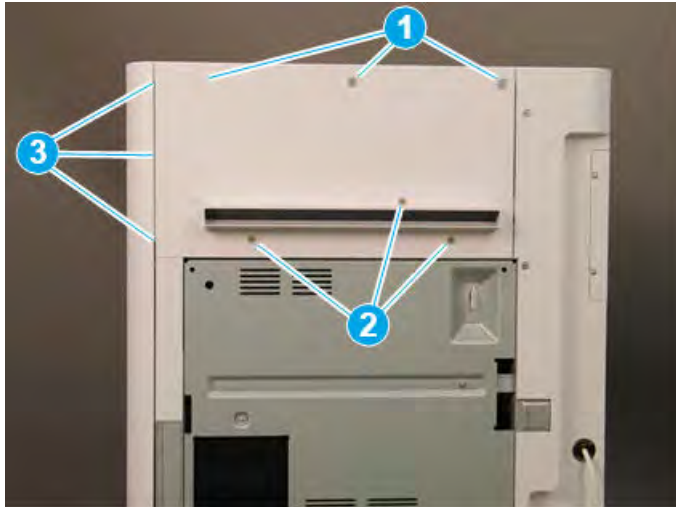
Follow these steps to remove the right upper cover (finisher).

- ▲ Remove one screw cap and three machine screws on the upper edge of the cover (callout 1). Remove three sheet metal screws (callout 2) on the lower portion of the cover. Rotate the right edge of the cover away from the finisher, and then slide the cover right to release three tabs (callout 3).

💡 **TIP:** The lower screws are shorter in length than the upper screws.

**TIP:** Reverse the removal steps to install the assembly.

Figure 5-156 Remove the right upper cover

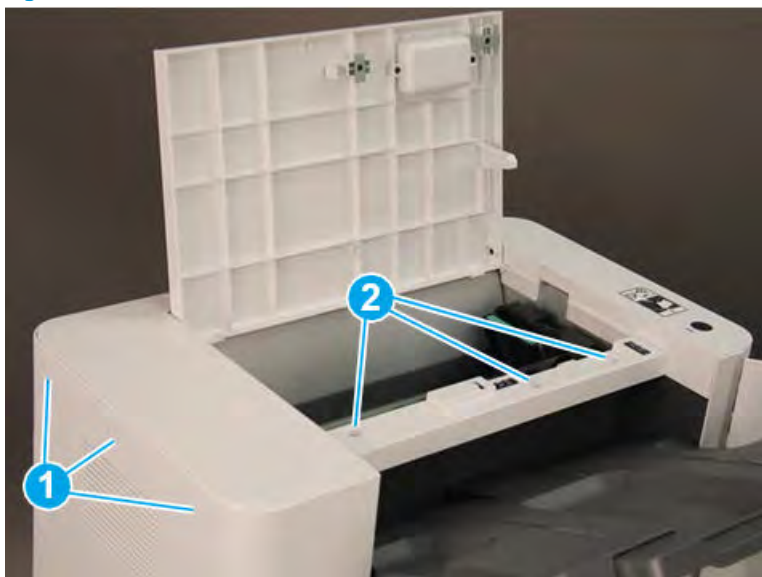


### Remove the top cover (finisher)

Follow these steps to remove the top cover (finisher).

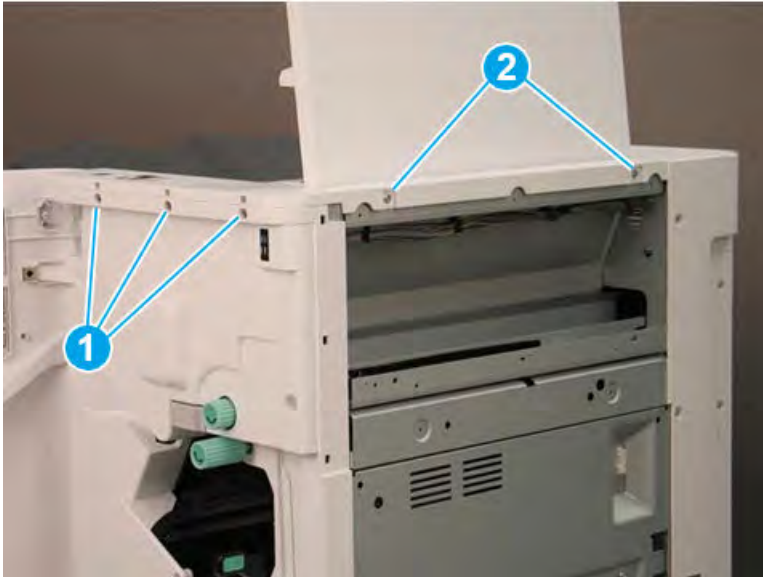
1. Remove three screw caps and three self-tapping screws at the top of the rear cover (callout 1), and then remove three machine screws (callout 2) on top of the cover.

Figure 5-157 Remove six screws




2. Remove three self-tapping screws at the top of the front cover (callout 1), and then remove two machine screws (callout 2) at the top of the right side.

**Figure 5-158** Remove five screws



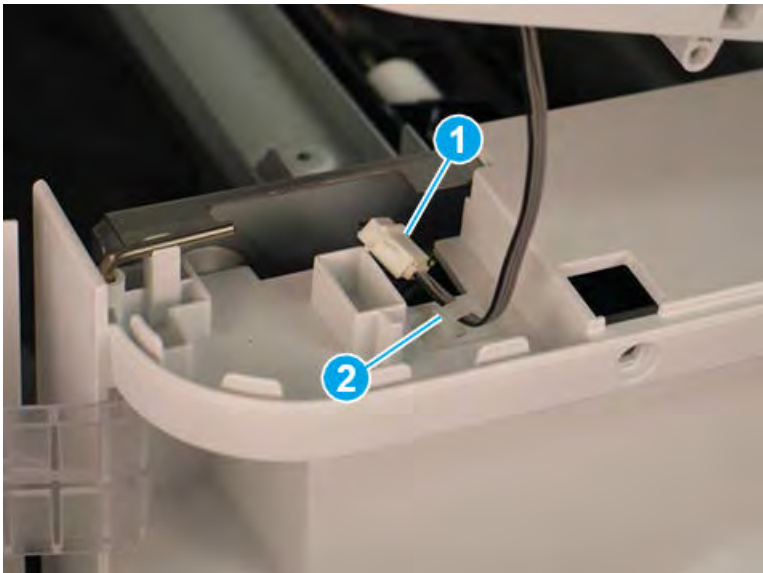
3. Lift the cover up slightly. Disconnect one in-line connector (callout 1), and then release one retainer (callout 2).

---

 **TIP:** Reverse the removal steps to install the assembly.

---

**Figure 5-159** Disconnect one connector and release retainer



### Unpack the replacement assembly

Follow these steps to unpack the replacement assembly.

1. Dispose of the defective part.



---

 **NOTE:** HP recommends responsible disposal of the defective part.


<http://www8.hp.com/us/en/hp-information/environment/product-recycling.html>

---

2. Unpack the replacement part from the packaging.


 **CAUTION:**  Some parts are sensitive to electrostatic discharge (ESD). Always perform service work at an ESD-protected workstation or mat. If an ESD workstation or mat is not available, touch the sheet-metal chassis to provide a static ground before touching an ESD-sensitive assembly. Protect the ESD-sensitive assemblies by placing them in ESD pouches when they are out of the printer.

 **IMPORTANT:** Make sure that all of the shipping materials (for example shipping tape) are removed from the replacement part prior to installation.

 **NOTE:** If the replacement part is a roller or pad, avoid touching the spongy part of it. Skin oils on the roller or pad can cause paper pickup and/or print-quality problems. HP recommends using disposable gloves when handling rollers or pads or washing your hands before touching rollers or pads.

---

3. To install an assembly, reverse the removal steps.

 **NOTE:** When applicable, special installation instructions are provided for an assembly at the end of the removal procedure. Always completely read the removal instructions and follow all special installation instructions.

---

## Removal and replacement: Front door

Learn how to remove and replace the front door.

### Introduction

This document provides the procedures to remove and replace the front door for the finisher.



**IMPORTANT:** When applicable, special installation instructions are provided for an assembly at the end of the removal procedure. Always completely read the removal instructions and follow all special installation instructions.

### Before performing service

- Turn the printer power off. A shutting-down message appears on the control-panel display.
- ⚠ **WARNING!** To avoid damage to the printer, turn the power off and wait until the printer shuts down before removing the power cable.
- Disconnect the printer power cable after the printer has completely shut down (the control-panel display is blank).
- Release the finisher from the printer by pulling out on the release latch inside the finisher door.
- Disconnect the cable from the bridge unit to the finisher.
- Disconnect the cable from the finisher to the printer.

Use the table below to identify the correct part number for your printer. To order the part, go to <https://parts.hp.com>.

**Table 5-88 Part information**

Part number	Part description
JC90-01444B	Front door

### Required tools

- #2 JIS screwdriver with a magnetic tip
- Small, flat-blade screwdriver

### After performing service

- Connect the cable from the finisher to the printer.
- Connect the cable from the bridge unit to the finisher.
- Attach the finisher to the printer, and then push in on the release latch inside the finisher door.
- Connect the printer power cable.
- Turn the printer power on.

### Post service test

Process a job through the finisher and verify that the finisher works correctly.

### Remove the right upper cover (finisher)

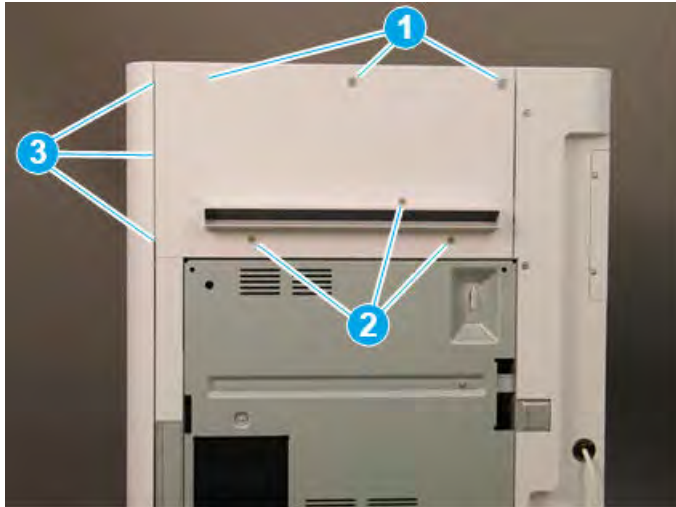
Follow these steps to remove the right upper cover (finisher).

- ▲ Remove one screw cap and three machine screws on the upper edge of the cover (callout 1). Remove three sheet metal screws (callout 2) on the lower portion of the cover. Rotate the right edge of the cover away from the finisher, and then slide the cover right to release three tabs (callout 3).

💡 **TIP:** The lower screws are shorter in length than the upper screws.

**TIP:** Reverse the removal steps to install the assembly.

Figure 5-160 Remove the right upper cover

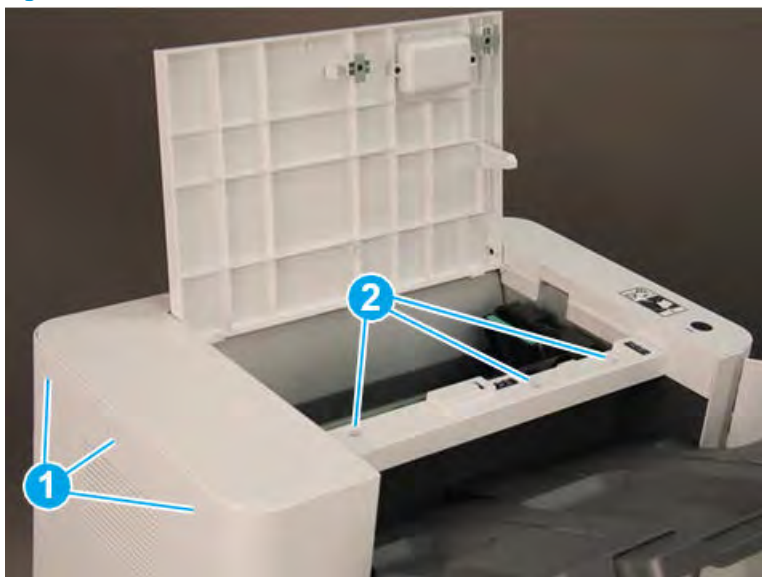


### Remove the top cover (finisher)

Follow these steps to remove the top cover (finisher).

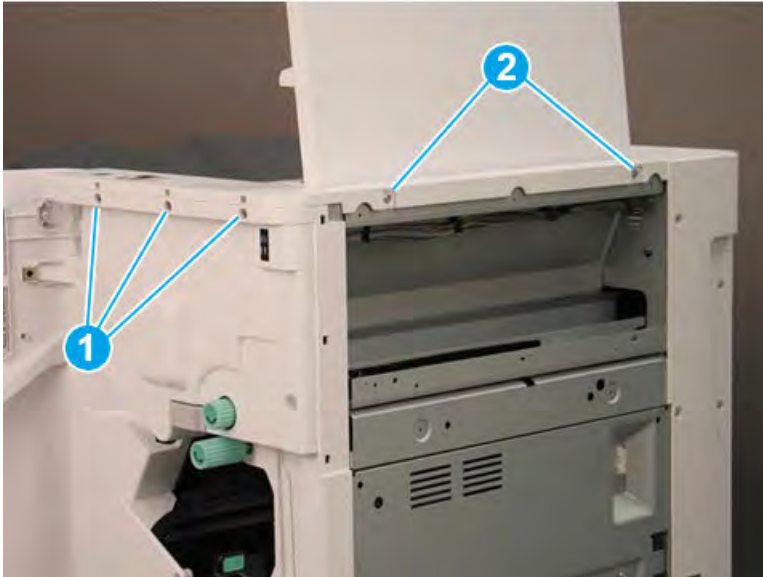
1. Remove three screw caps and three self-tapping screws at the top of the rear cover (callout 1), and then remove three machine screws (callout 2) on top of the cover.

Figure 5-161 Remove six screws




2. Remove three self-tapping screws at the top of the front cover (callout 1), and then remove two machine screws (callout 2) at the top of the right side.

**Figure 5-162** Remove five screws



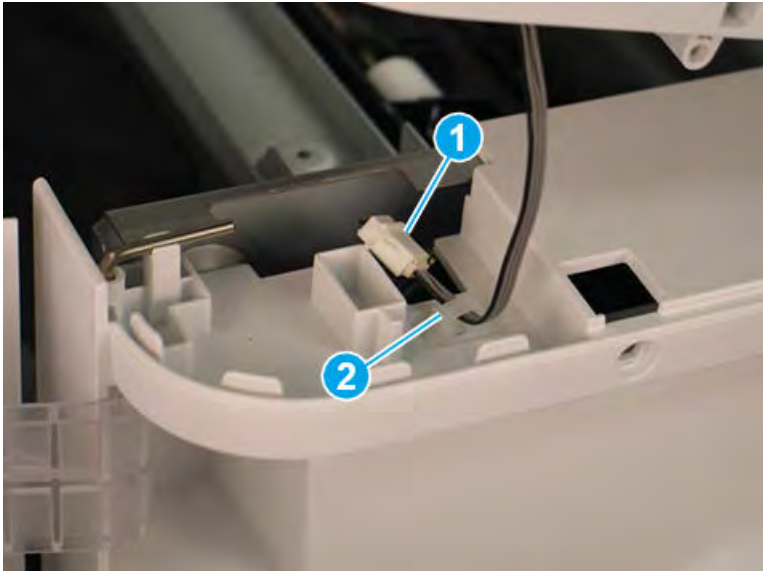
3. Lift the cover up slightly. Disconnect one in-line connector (callout 1), and then release one retainer (callout 2).

---

 **TIP:** Reverse the removal steps to install the assembly.

---

**Figure 5-163** Disconnect one connector and release retainer

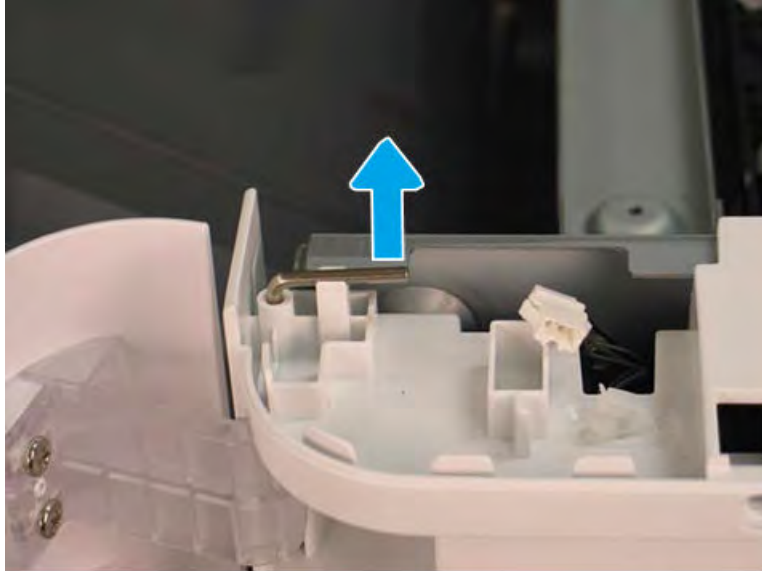


### Remove the front door (finisher)

Follow these steps to remove the front door (finisher).

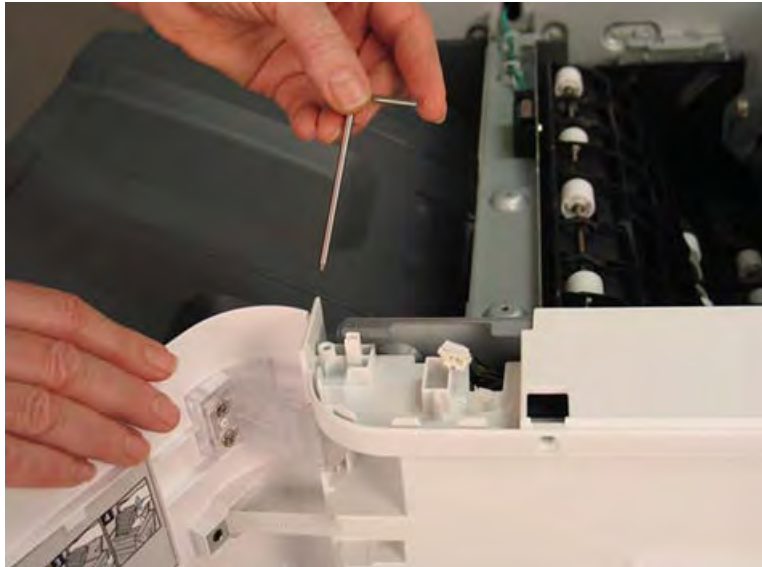
1. Lift the top hinge pin up to release it from the retainer.

Figure 5-164 Lift the top hinge pin



2. Pull the top hinge pin up to remove it.

Figure 5-165 Remove the top hinge pin



3. Use a small, flat-blade screwdriver to release the lower hinge pin from the retainer, and then rotate it away from the finisher.

**Figure 5-166** Release the lower hinge pin



4. Support the door with one hand, and then pull the lower hinge pin straight up to remove it.


**Figure 5-167** Remove the lower hinge pin





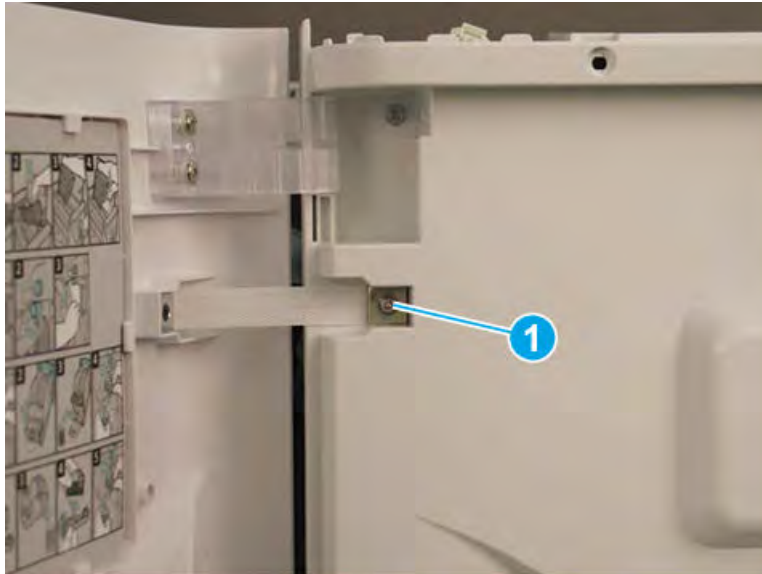
5. Support the door with one hand, and then remove one screw (callout 1) to release the strap. Remove the front door.

---

 **TIP:** Reverse the removal steps to install the assembly.

---

**Figure 5-168** Remove the front door



### Unpack the replacement assembly

Follow these steps to unpack the replacement assembly.

1. Dispose of the defective part.

---



 **NOTE:** HP recommends responsible disposal of the defective part.


<http://www8.hp.com/us/en/hp-information/environment/product-recycling.html>


---

2. Unpack the replacement part from the packaging.

---

 **CAUTION:**  Some parts are sensitive to electrostatic discharge (ESD). Always perform service work at an ESD-protected workstation or mat. If an ESD workstation or mat is not available, touch the sheet-metal chassis to provide a static ground before touching an ESD-sensitive assembly. Protect the ESD-sensitive assemblies by placing them in ESD pouches when they are out of the printer.


 **IMPORTANT:** Make sure that all of the shipping materials (for example shipping tape) are removed from the replacement part prior to installation.

 **NOTE:** If the replacement part is a roller or pad, avoid touching the spongy part of it. Skin oils on the roller or pad can cause paper pickup and/or print-quality problems. HP recommends using disposable gloves when handling rollers or pads or washing your hands before touching rollers or pads.

---

3. To install an assembly, reverse the removal steps.

---

 **NOTE:** When applicable, special installation instructions are provided for an assembly at the end of the removal procedure. Always completely read the removal instructions and follow all special installation instructions.


---

## Removal and replacement: Rear cover

Learn how to remove and replace the rear cover.

### Introduction

This document provides the procedures to remove and replace the rear cover for the finisher.

 **IMPORTANT:** When applicable, special installation instructions are provided for an assembly at the end of the removal procedure. Always completely read the removal instructions and follow all special installation instructions.

### Before performing service

- Turn the printer power off. A shutting-down message appears on the control-panel display.
- ⚠ **WARNING!** To avoid damage to the printer, turn the power off and wait until the printer shuts down before removing the power cable.
- Disconnect the printer power cable after the printer has completely shut down (the control-panel display is blank).
- Release the finisher from the printer by pulling out on the release latch inside the finisher door.
- Disconnect the cable from the bridge unit to the finisher.
- Disconnect the cable from the finisher to the printer.

Use the table below to identify the correct part number for your printer. To order the part, go to <https://parts.hp.com>.

**Table 5-89 Part information**

Part number	Part description
JC63-04988B	Rear cover

### Required tools

- #2 JIS screwdriver with a magnetic tip

### After performing service

- Connect the cable from the finisher to the printer.
- Connect the cable from the bridge unit to the finisher.
- Attach the finisher to the printer, and then push in on the release latch inside the finisher door.
- Connect the printer power cable.
- Turn the printer power on.

### Post service test

Process a job through the finisher and verify that the finisher works correctly.

### Remove the right upper cover (finisher)

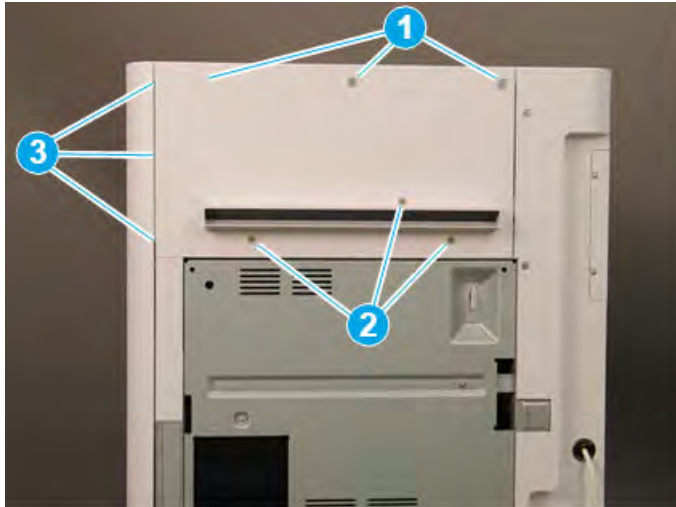
Follow these steps to remove the right upper cover (finisher).

- ▲ Remove one screw cap and three machine screws on the upper edge of the cover (callout 1). Remove three sheet metal screws (callout 2) on the lower portion of the cover. Rotate the right edge of the cover away from the finisher, and then slide the cover right to release three tabs (callout 3).

💡 **TIP:** The lower screws are shorter in length than the upper screws.

**TIP:** Reverse the removal steps to install the assembly.

Figure 5-169 Remove the right upper cover

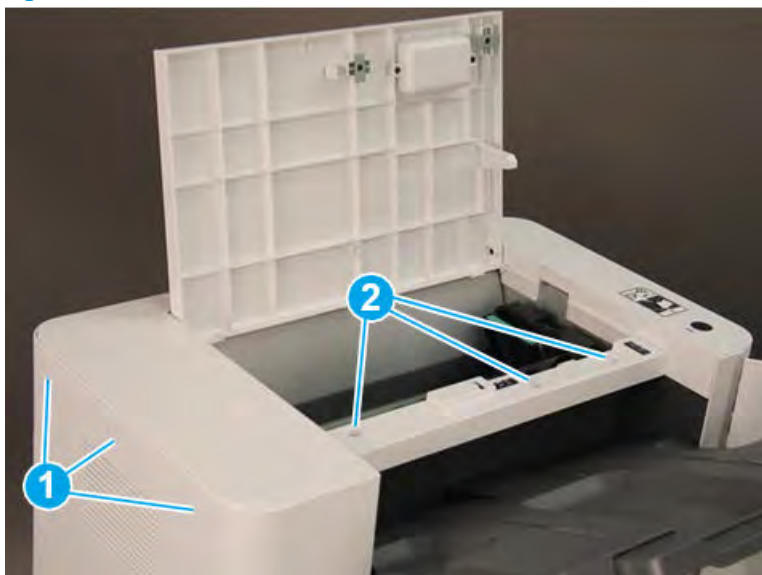


### Remove the top cover (finisher)

Follow these steps to remove the top cover (finisher).

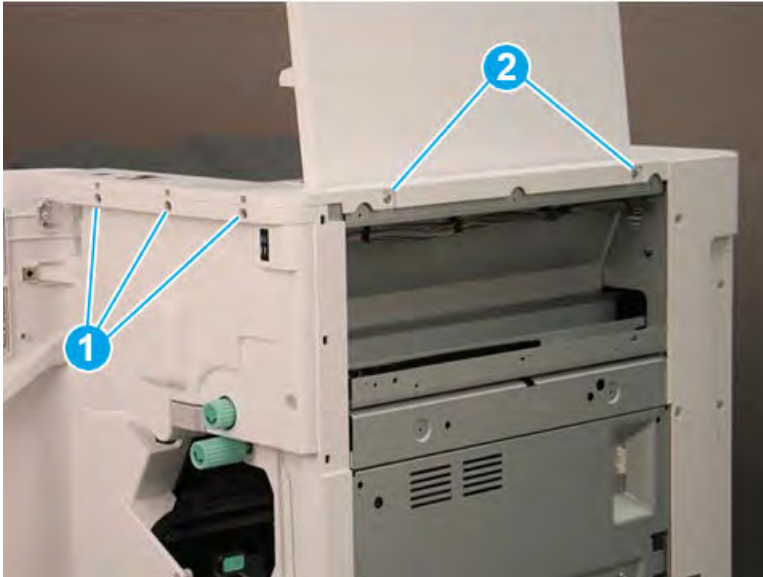
1. Remove three screw caps and three self-tapping screws at the top of the rear cover (callout 1), and then remove three machine screws (callout 2) on top of the cover.

Figure 5-170 Remove six screws




2. Remove three self-tapping screws at the top of the front cover (callout 1), and then remove two machine screws (callout 2) at the top of the right side.

Figure 5-171 Remove five screws



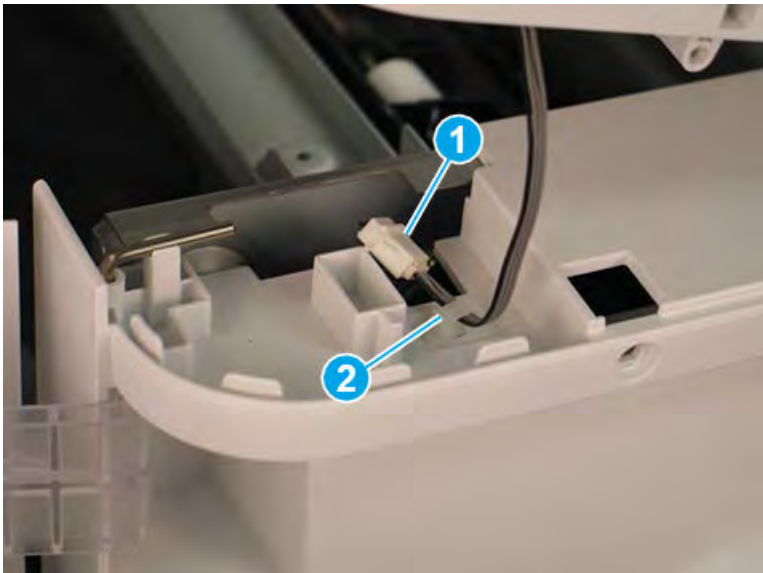
3. Lift the cover up slightly. Disconnect one in-line connector (callout 1), and then release one retainer (callout 2).

---

 **TIP:** Reverse the removal steps to install the assembly.

---

Figure 5-172 Disconnect one connector and release retainer

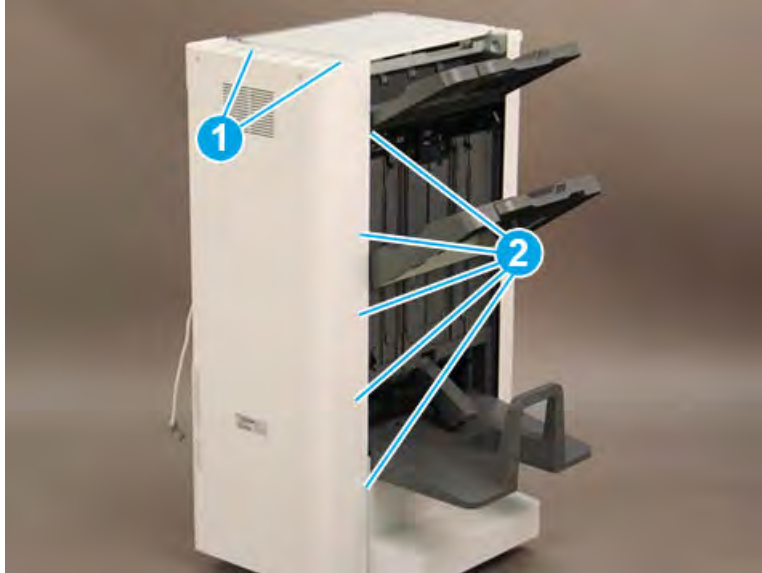


### Remove the rear cover (finisher)

Follow these steps to remove the rear cover (finisher).

1. Remove two self-tapping screws (callout 1) on the top of the rear cover, and then remove five screw caps and five machine screws (callout 2) on the left side of the cover.

Figure 5-173 Remove seven screws



2. Remove one screw cap and four machine screws (callout 1) Remove the rear cover.

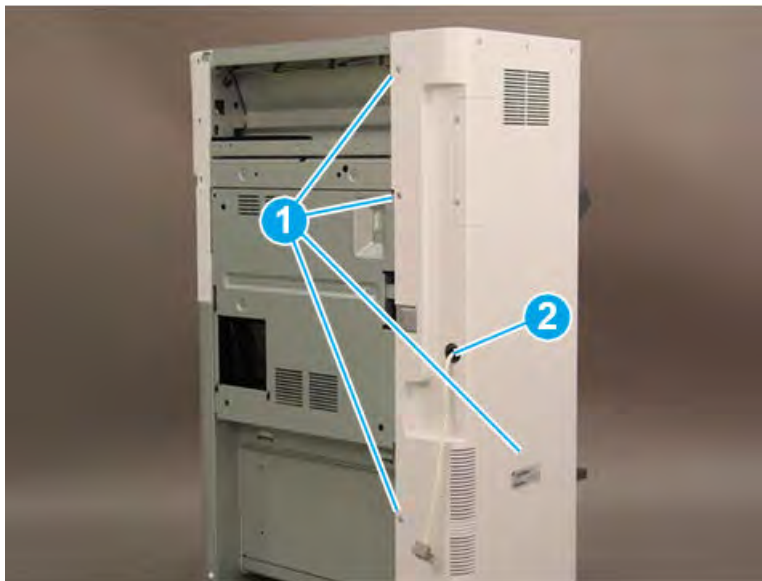
---

 **NOTE:** Make sure to thread the power cable (callout 2) through the opening in the cover.

 **TIP:** Reverse the removal steps to install the assembly

---

Figure 5-174 Remove the rear cover



### Unpack the replacement assembly

Follow these steps to unpack the replacement assembly.

1. Dispose of the defective part.



---


 **NOTE:** HP recommends responsible disposal of the defective part.


<http://www8.hp.com/us/en/hp-information/environment/product-recycling.html>

---

2. Unpack the replacement part from the packaging.


 **CAUTION:**  Some parts are sensitive to electrostatic discharge (ESD). Always perform service work at an ESD-protected workstation or mat. If an ESD workstation or mat is not available, touch the sheet-metal chassis to provide a static ground before touching an ESD-sensitive assembly. Protect the ESD-sensitive assemblies by placing them in ESD pouches when they are out of the printer.

 **IMPORTANT:** Make sure that all of the shipping materials (for example shipping tape) are removed from the replacement part prior to installation.

 **NOTE:** If the replacement part is a roller or pad, avoid touching the spongy part of it. Skin oils on the roller or pad can cause paper pickup and/or print-quality problems. HP recommends using disposable gloves when handling rollers or pads or washing your hands before touching rollers or pads.

---

3. To install an assembly, reverse the removal steps.

 **NOTE:** When applicable, special installation instructions are provided for an assembly at the end of the removal procedure. Always completely read the removal instructions and follow all special installation instructions.

---

## Removal and replacement: Front cover

Learn how to remove and replace the front cover.

### Introduction

This document provides the procedures to remove and replace the front cover for the finisher.



**IMPORTANT:** When applicable, special installation instructions are provided for an assembly at the end of the removal procedure. Always completely read the removal instructions and follow all special installation instructions.

### Before performing service

- Turn the printer power off. A shutting-down message appears on the control-panel display.
- ⚠ **WARNING!** To avoid damage to the printer, turn the power off and wait until the printer shuts down before removing the power cable.
- Disconnect the printer power cable after the printer has completely shut down (the control-panel display is blank).
- Release the finisher from the printer by pulling out on the release latch inside the finisher door.
- Disconnect the cable from the bridge unit to the finisher.
- Disconnect the cable from the finisher to the printer.

Use the table below to identify the correct part number for your printer. To order the part, go to <https://parts.hp.com>.

**Table 5-90 Part information**

Part number	Part description
JC63-04986B	Front cover

### Required tools

- #2 JIS screwdriver with a magnetic tip
- Small, flat-blade screwdriver

### After performing service

- Connect the cable from the finisher to the printer.
- Connect the cable from the bridge unit to the finisher.
- Attach the finisher to the printer, and then push in on the release latch inside the finisher door.
- Connect the printer power cable.
- Turn the printer power on.

### Post service test

Process a job through the finisher and verify that the finisher works correctly.

### Remove the right upper cover (finisher)

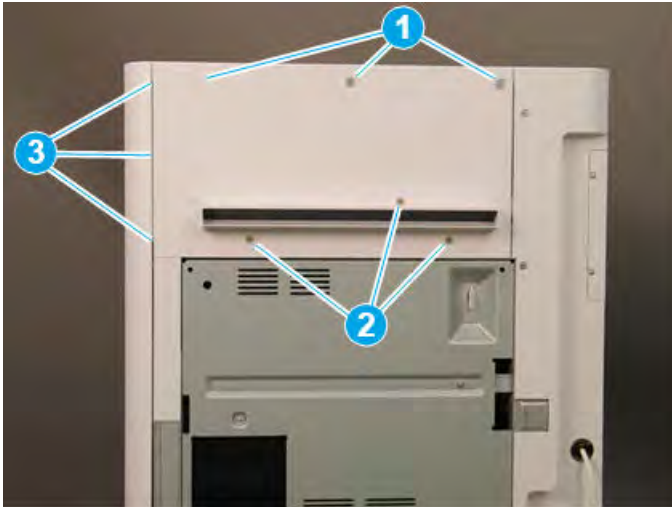
Follow these steps to remove the right upper cover (finisher).

- ▲ Remove one screw cap and three machine screws on the upper edge of the cover (callout 1). Remove three sheet metal screws (callout 2) on the lower portion of the cover. Rotate the right edge of the cover away from the finisher, and then slide the cover right to release three tabs (callout 3).

💡 **TIP:** The lower screws are shorter in length than the upper screws.

**TIP:** Reverse the removal steps to install the assembly.

**Figure 5-175** Remove the right upper cover

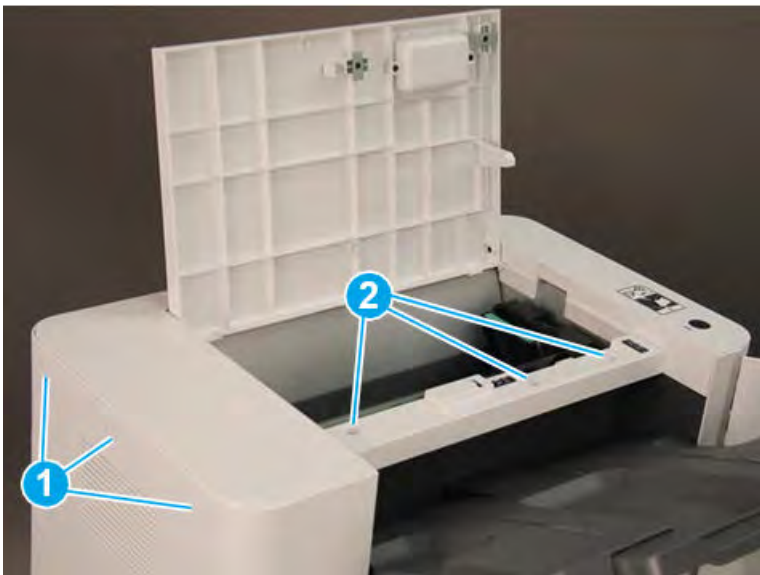


### Remove the top cover (finisher)

Follow these steps to remove the top cover (finisher).

1. Remove three screw caps and three self-tapping screws at the top of the rear cover (callout 1), and then remove three machine screws (callout 2) on top of the cover.

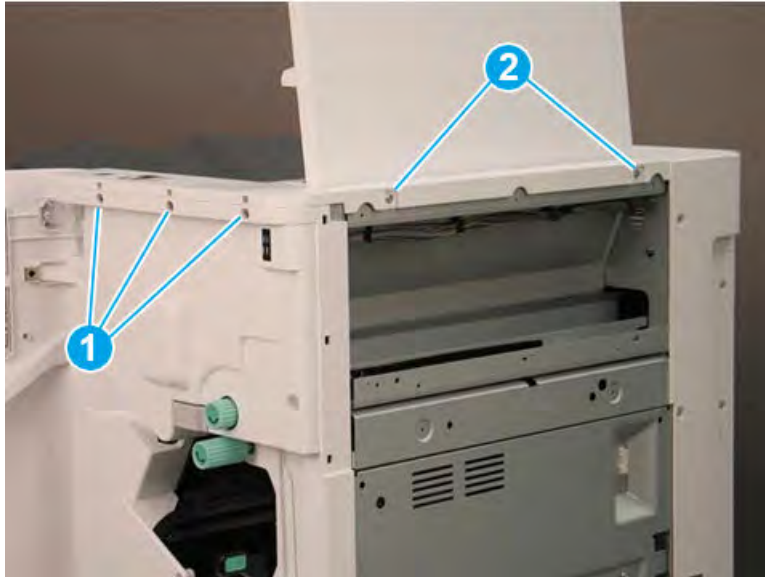
**Figure 5-176** Remove six screws





2. Remove three self-tapping screws at the top of the front cover (callout 1), and then remove two machine screws (callout 2) at the top of the right side.

Figure 5-177 Remove five screws



3. Lift the cover up slightly. Disconnect one in-line connector (callout 1), and then release one retainer (callout 2).


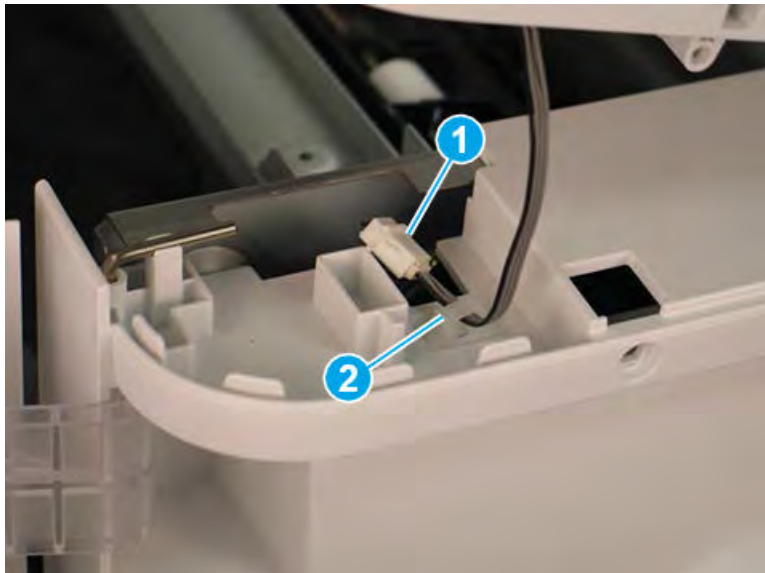
 **TIP:** Reverse the removal steps to install the assembly.

Figure 5-178 Disconnect one connector and release retainer

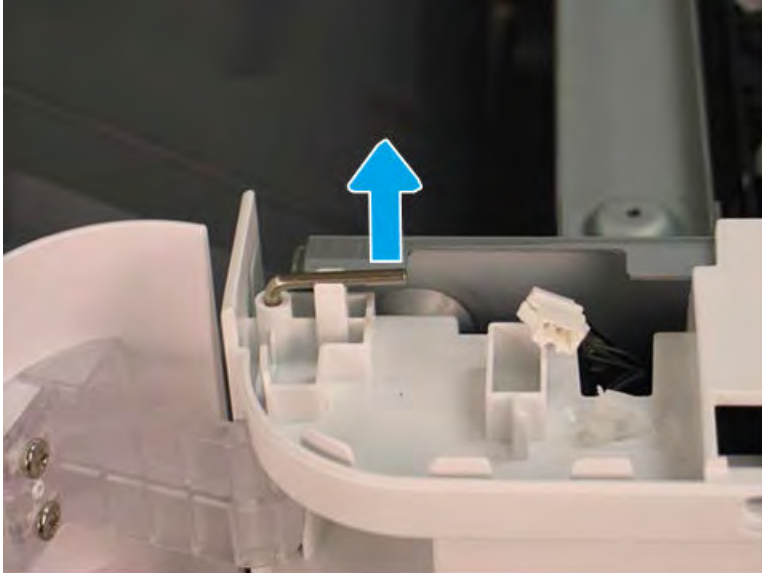


### Remove the front door (finisher)

Follow these steps to remove the front door (finisher).

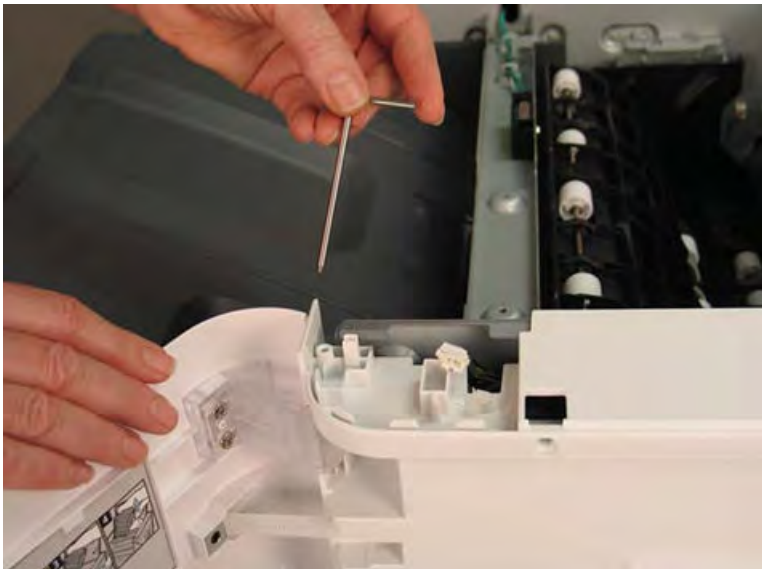
1. Lift the top hinge pin up to release it from the retainer.

Figure 5-179 Lift the top hinge pin



2. Pull the top hinge pin up to remove it.

Figure 5-180 Remove the top hinge pin



3. Use a small, flat-blade screwdriver to release the lower hinge pin from the retainer, and then rotate it away from the finisher.

Figure 5-181 Release the lower hinge pin




4. Support the door with one hand, and then pull the lower hinge pin straight up to remove it.

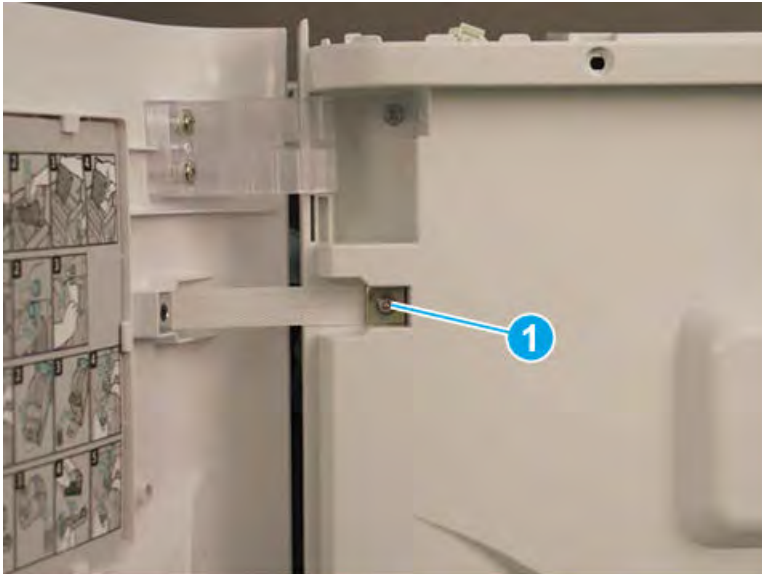
Figure 5-182 Remove the lower hinge pin



5. Support the door with one hand, and then remove one screw (callout 1) to release the strap. Remove the front door.

 **TIP:** Reverse the removal steps to install the assembly.

**Figure 5-183** Remove the front door

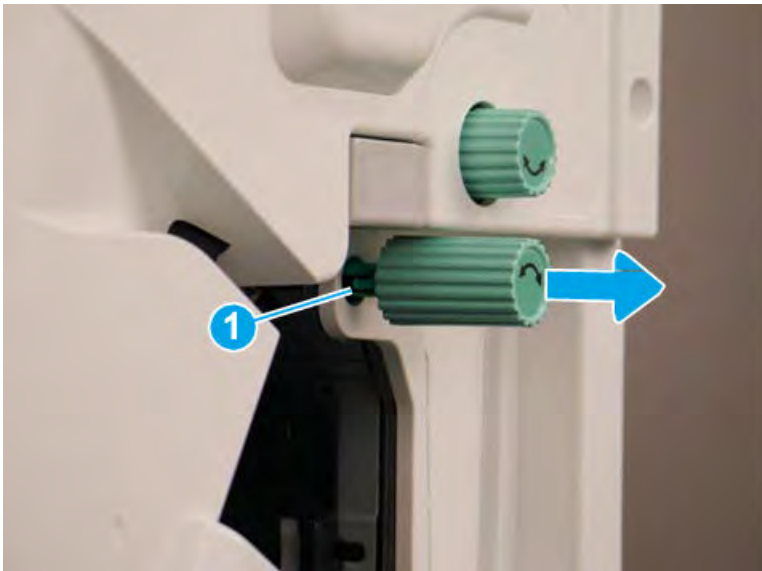


#### Remove the front cover (finisher)

Follow these steps to remove the front cover (finisher).

1. Release one tab (callout 1), and then pull the jam-access knob away from the finisher to remove it.

**Figure 5-184** Remove the jam-access knob



2. If the punch unit is installed, remove the punch waste bin (callout 1).


3. Remove one screw (callout 1) on top of the front cover.

Figure 5-185 Remove one screw



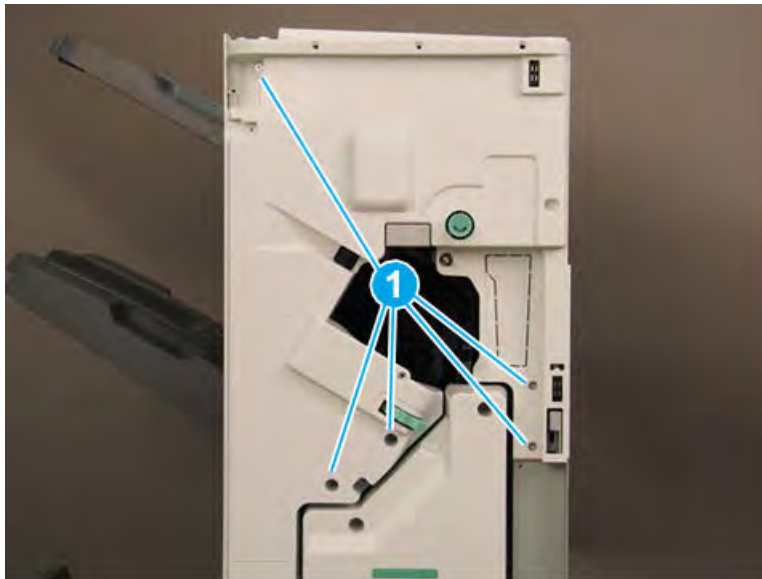
4. Remove five machine screws (callout 1), and then remove the front cover.

---

 **TIP:** Reverse the removal steps to install the assembly.

---

Figure 5-186 Remove the front cover



### Unpack the replacement assembly

Follow these steps to unpack the replacement assembly.

1. Dispose of the defective part.



---


 **NOTE:** HP recommends responsible disposal of the defective part.


<http://www8.hp.com/us/en/hp-information/environment/product-recycling.html>

---

2. Unpack the replacement part from the packaging.


 **CAUTION:**  Some parts are sensitive to electrostatic discharge (ESD). Always perform service work at an ESD-protected workstation or mat. If an ESD workstation or mat is not available, touch the sheet-metal chassis to provide a static ground before touching an ESD-sensitive assembly. Protect the ESD-sensitive assemblies by placing them in ESD pouches when they are out of the printer.

 **IMPORTANT:** Make sure that all of the shipping materials (for example shipping tape) are removed from the replacement part prior to installation.

 **NOTE:** If the replacement part is a roller or pad, avoid touching the spongy part of it. Skin oils on the roller or pad can cause paper pickup and/or print-quality problems. HP recommends using disposable gloves when handling rollers or pads or washing your hands before touching rollers or pads.

---

3. To install an assembly, reverse the removal steps.

 **NOTE:** When applicable, special installation instructions are provided for an assembly at the end of the removal procedure. Always completely read the removal instructions and follow all special installation instructions.

---

## Removal and replacement: Front lower cover

Learn how to remove and replace the front lower cover.

### Introduction

This document provides the procedures to remove and replace the front lower cover for the finisher.



**IMPORTANT:** When applicable, special installation instructions are provided for an assembly at the end of the removal procedure. Always completely read the removal instructions and follow all special installation instructions.

### Before performing service

- Turn the printer power off. A shutting-down message appears on the control-panel display.
- ⚠ **WARNING!** To avoid damage to the printer, turn the power off and wait until the printer shuts down before removing the power cable.
- Disconnect the printer power cable after the printer has completely shut down (the control-panel display is blank).
- Release the finisher from the printer by pulling out on the release latch inside the finisher door.
- Disconnect the cable from the bridge unit to the finisher.
- Disconnect the cable from the finisher to the printer.

Use the table below to identify the correct part number for your printer. To order the part, go to <https://parts.hp.com>.

**Table 5-91 Part information**

Part number	Part description
JC63-04987B	Front lower cover

### Required tools

- #2 JIS screwdriver with a magnetic tip
- Small, flat-blade screwdriver

### After performing service

- Connect the cable from the finisher to the printer.
- Connect the cable from the bridge unit to the finisher.
- Attach the finisher to the printer, and then push in on the release latch inside the finisher door.
- Connect the printer power cable.
- Turn the printer power on.

### Post service test

Process a job through the finisher and verify that the finisher works correctly.

### Remove the right upper cover (finisher)

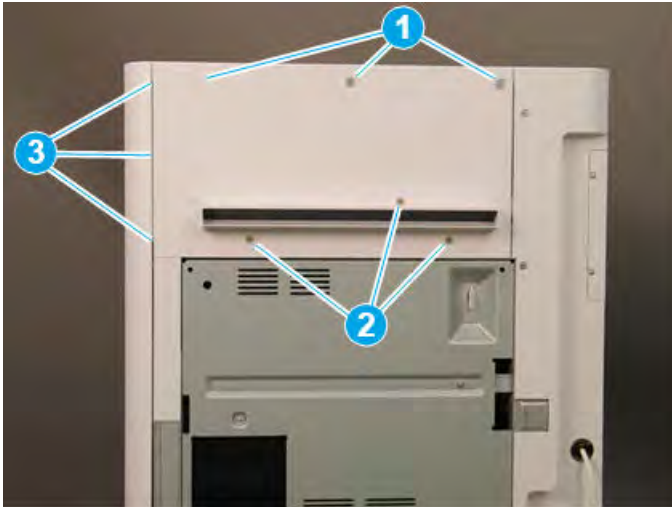
Follow these steps to remove the right upper cover (finisher).

- ▲ Remove one screw cap and three machine screws on the upper edge of the cover (callout 1). Remove three sheet metal screws (callout 2) on the lower portion of the cover. Rotate the right edge of the cover away from the finisher, and then slide the cover right to release three tabs (callout 3).

💡 **TIP:** The lower screws are shorter in length than the upper screws.

**TIP:** Reverse the removal steps to install the assembly.

**Figure 5-187** Remove the right upper cover

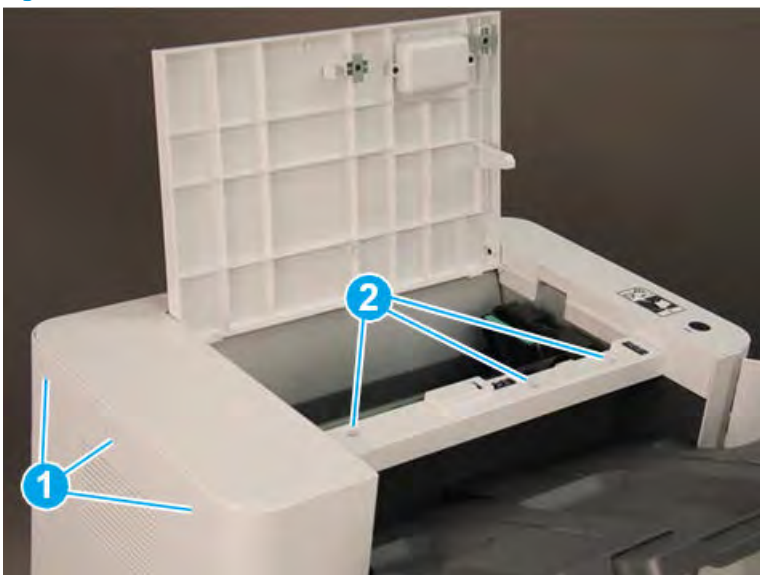


### Remove the top cover (finisher)

Follow these steps to remove the top cover (finisher).

1. Remove three screw caps and three self-tapping screws at the top of the rear cover (callout 1), and then remove three machine screws (callout 2) on top of the cover.

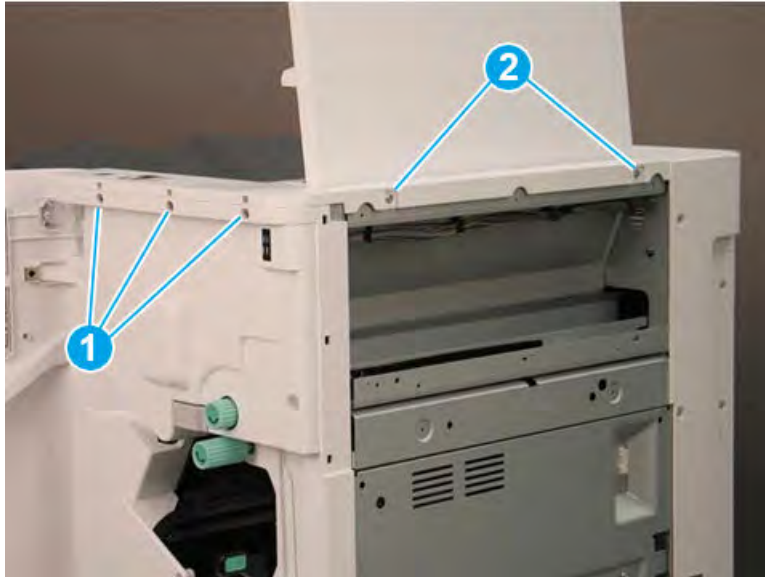
**Figure 5-188** Remove six screws





2. Remove three self-tapping screws at the top of the front cover (callout 1), and then remove two machine screws (callout 2) at the top of the right side.

Figure 5-189 Remove five screws



3. Lift the cover up slightly. Disconnect one in-line connector (callout 1), and then release one retainer (callout 2).


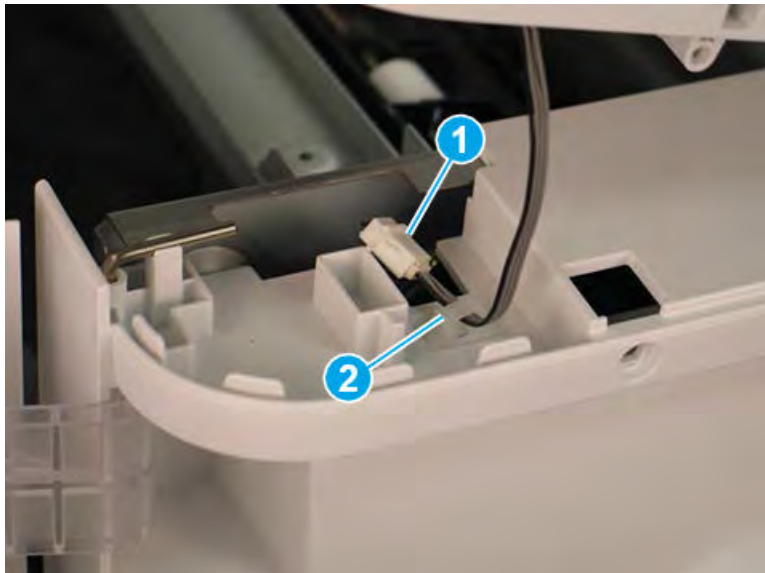
 **TIP:** Reverse the removal steps to install the assembly.

Figure 5-190 Disconnect one connector and release retainer

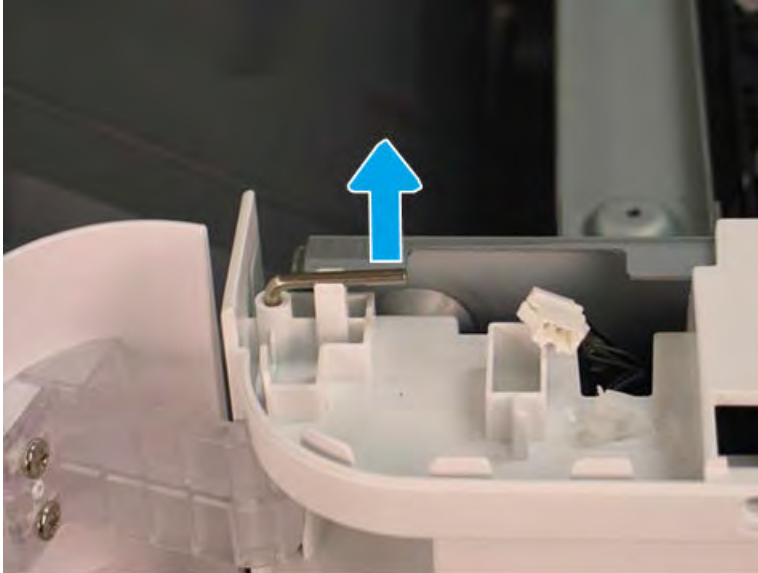


### Remove the front door (finisher)

Follow these steps to remove the front door (finisher).

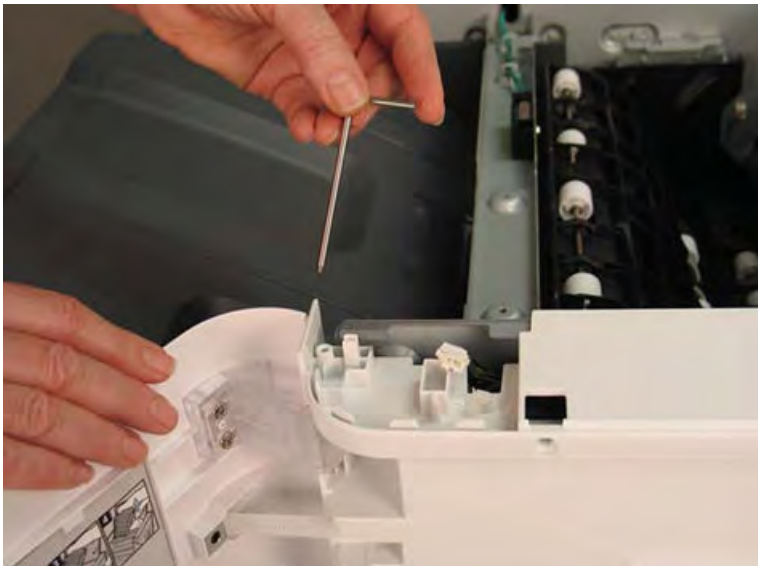
1. Lift the top hinge pin up to release it from the retainer.

Figure 5-191 Lift the top hinge pin



2. Pull the top hinge pin up to remove it.

Figure 5-192 Remove the top hinge pin



3. Use a small, flat-blade screwdriver to release the lower hinge pin from the retainer, and then rotate it away from the finisher.

Figure 5-193 Release the lower hinge pin



4. Support the door with one hand, and then pull the lower hinge pin straight up to remove it.

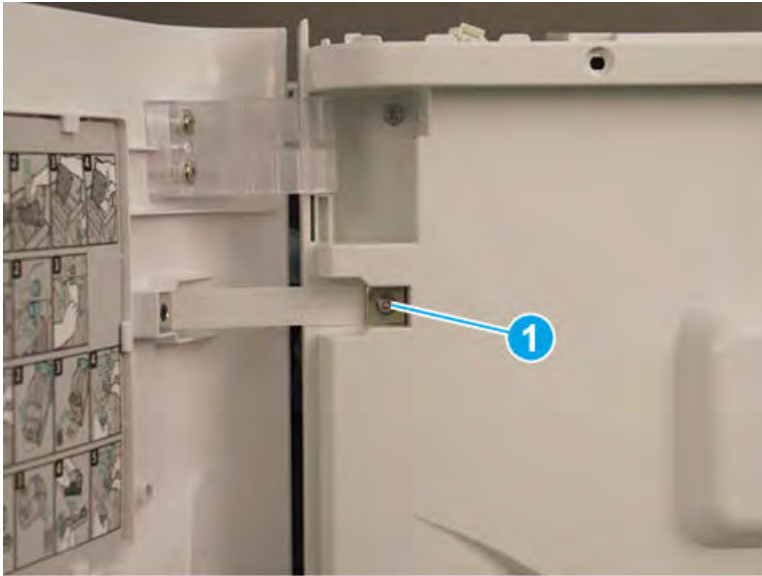
Figure 5-194 Remove the lower hinge pin



5. Support the door with one hand, and then remove one screw (callout 1) to release the strap. Remove the front door.

 **TIP:** Reverse the removal steps to install the assembly.

**Figure 5-195** Remove the front door

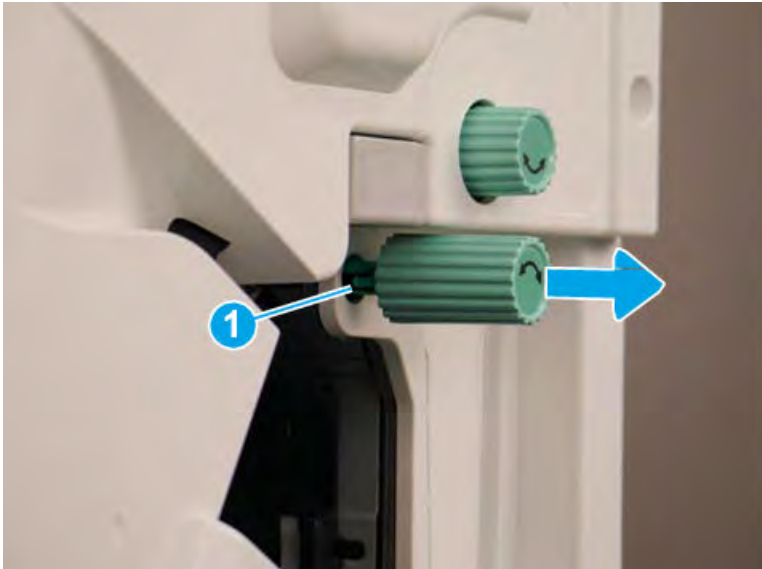


#### Remove the front cover (finisher)

Follow these steps to remove the front cover (finisher).

1. Release one tab (callout 1), and then pull the jam-access knob away from the finisher to remove it.

**Figure 5-196** Remove the jam-access knob



2. If the punch unit is installed, remove the punch waste bin (callout 1).

3. Remove one screw (callout 1) on top of the front cover.

Figure 5-197 Remove one screw



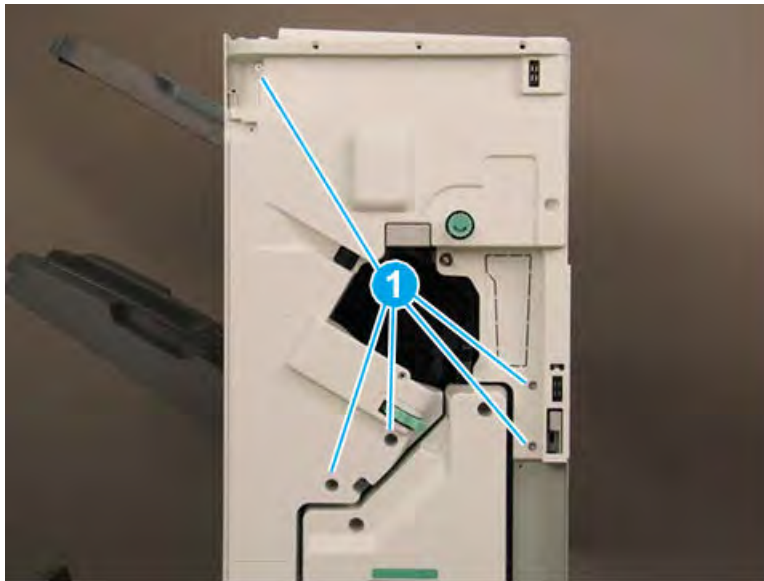
4. Remove five machine screws (callout 1), and then remove the front cover.

---

 **TIP:** Reverse the removal steps to install the assembly.

---

Figure 5-198 Remove the front cover




#### Remove the front lower cover (finisher)

Follow these steps to remove the front lower cover (finisher).

- ▲ Remove three machine screws (callout 1), and then remove the front lower cover.

---

 **TIP:** Reverse the removal steps to install the assembly.

---

Figure 5-199 Remove the front lower cover



### Unpack the replacement assembly

Follow these steps to unpack the replacement assembly.

1. Dispose of the defective part.

---



 **NOTE:** HP recommends responsible disposal of the defective part.


<http://www8.hp.com/us/en/hp-information/environment/product-recycling.html>


---

2. Unpack the replacement part from the packaging.

---

 **CAUTION:**  Some parts are sensitive to electrostatic discharge (ESD). Always perform service work at an ESD-protected workstation or mat. If an ESD workstation or mat is not available, touch the sheet-metal chassis to provide a static ground before touching an ESD-sensitive assembly. Protect the ESD-sensitive assemblies by placing them in ESD pouches when they are out of the printer.


 **IMPORTANT:** Make sure that all of the shipping materials (for example shipping tape) are removed from the replacement part prior to installation.

 **NOTE:** If the replacement part is a roller or pad, avoid touching the spongy part of it. Skin oils on the roller or pad can cause paper pickup and/or print-quality problems. HP recommends using disposable gloves when handling rollers or pads or washing your hands before touching rollers or pads.

---

3. To install an assembly, reverse the removal steps.

---

 **NOTE:** When applicable, special installation instructions are provided for an assembly at the end of the removal procedure. Always completely read the removal instructions and follow all special installation instructions.

---

## Removal and replacement: Caster cover

Learn how to remove and replace the caster cover.

### Introduction

This document provides the procedures to remove and replace the caster cover on the finisher.



**IMPORTANT:** When applicable, special installation instructions are provided for an assembly at the end of the removal procedure. Always completely read the removal instructions and follow all special installation instructions.

### Before performing service

- Turn the printer power off. A shutting-down message appears on the control-panel display.
- ⚠ **WARNING!** To avoid damage to the printer, turn the power off and wait until the printer shuts down before removing the power cable.
- Disconnect the printer power cable after the printer has completely shut down (the control-panel display is blank).
- Release the finisher from the printer by pulling out on the release latch inside the finisher door.
- Disconnect the cable from the bridge unit to the finisher.
- Disconnect the cable from the finisher to the printer.

Use the table below to identify the correct part number for your printer. To order the part, go to <https://parts.hp.com>.

**Table 5-92 Part information**

Part number	Part description
JC63-04985B	Caster cover

### Required tools

- #2 JIS screwdriver with a magnetic tip

### After performing service

- Connect the cable from the finisher to the printer.
- Connect the cable from the bridge unit to the finisher.
- Attach the finisher to the printer, and then push in on the release latch inside the finisher door.
- Connect the printer power cable.
- Turn the printer power on.

### Post service test

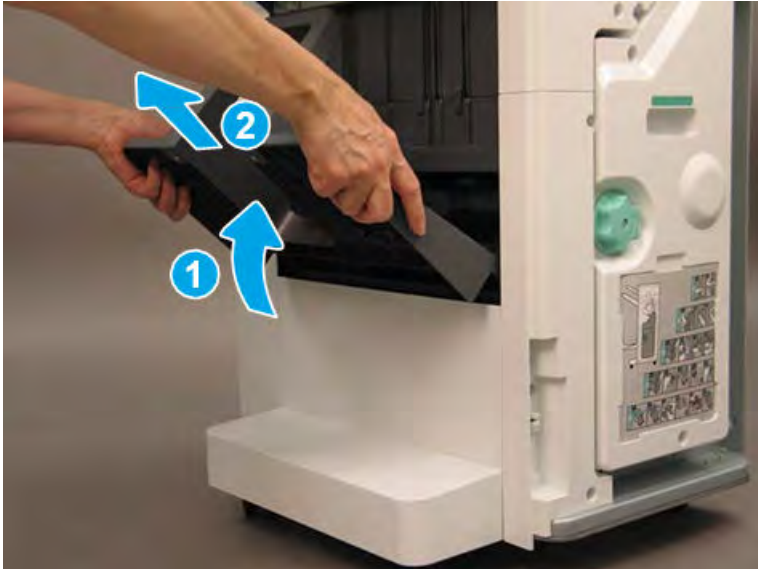
Process a job through the finisher and verify that the finisher works correctly.

## Remove the booklet output tray

Follow these steps to remove the booklet output tray.

1. Raise the booklet output tray up (callout 1), and then pull it away from the finisher (callout 2) to remove it.

**Figure 5-200** Remove the booklet output tray



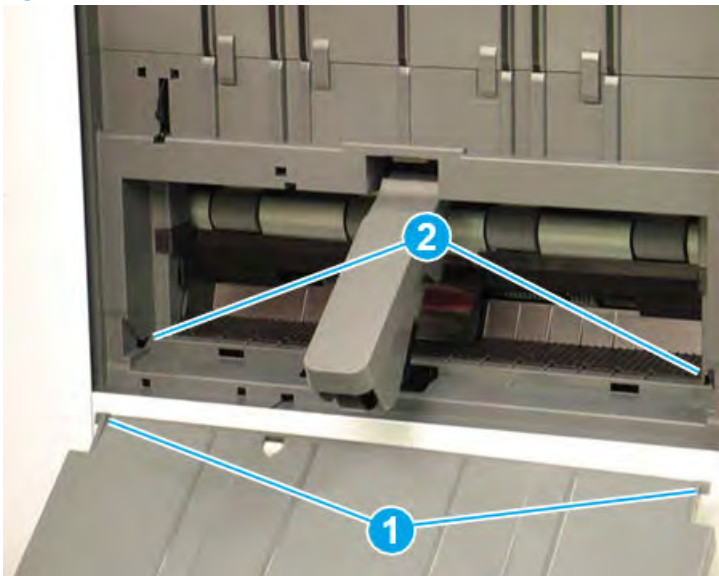
2. Reverse the removal steps to install the assembly. Also use the following special installation instructions.

 **NOTE:** Continue to reverse the removal steps to finish installing the assembly

Special installation instructions: booklet output tray

Position the tabs (callout 1) on the tray into the slots (callout 2) on the finisher.

**Figure 5-201** Install the booklet output tray



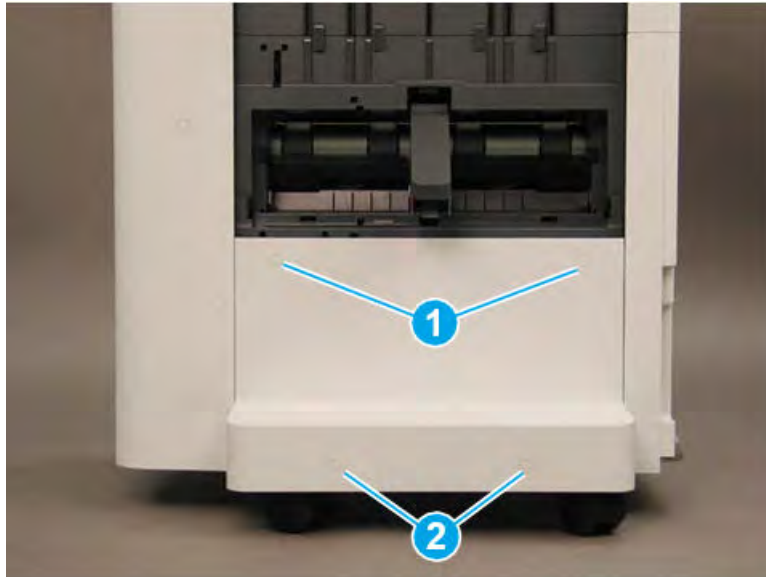


## Remove the caster cover

Follow these steps to remove the caster cover.


1. Remove two screw caps and two self-tapping screws (callout 1). Remove two screw caps and two machine screws (callout 2).

Figure 5-202 Remove four screws



2. Rotate the left edge of the cover away from the finisher (callout 1), and then slide the cover to the left (callout 2) to remove it.

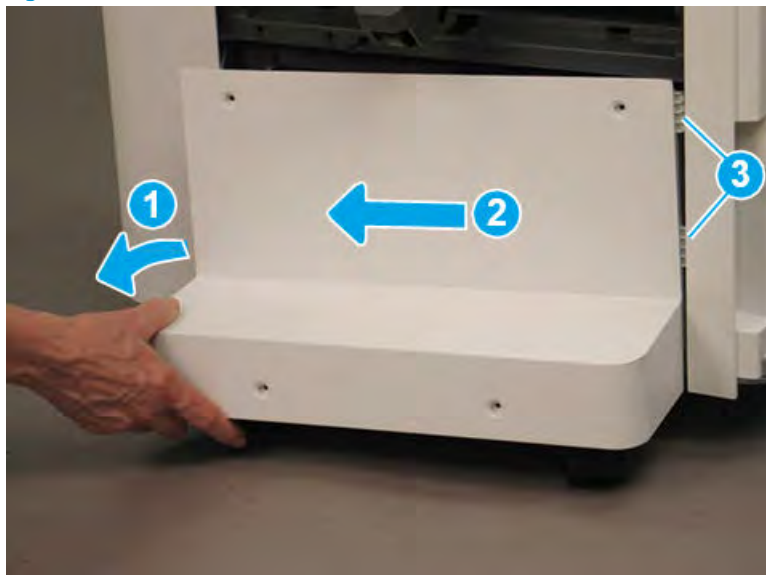
---

 **TIP:** Make sure that two tabs (callout 3) are positioned under the front lower cover when reinstalling the caster cover.

**TIP:** Reverse the removal steps to install the assembly

---

Figure 5-203 Remove the caster cover



## Unpack the replacement assembly

Follow these steps to unpack the replacement assembly.

1. Dispose of the defective part.




**NOTE:** HP recommends responsible disposal of the defective part.

<http://www8.hp.com/us/en/hp-information/environment/product-recycling.html>

---

2. Unpack the replacement part from the packaging.



**CAUTION:**  Some parts are sensitive to electrostatic discharge (ESD). Always perform service work at an ESD-protected workstation or mat. If an ESD workstation or mat is not available, touch the sheet-metal chassis to provide a static ground before touching an ESD-sensitive assembly. Protect the ESD-sensitive assemblies by placing them in ESD pouches when they are out of the printer.



**IMPORTANT:** Make sure that all of the shipping materials (for example shipping tape) are removed from the replacement part prior to installation.



**NOTE:** If the replacement part is a roller or pad, avoid touching the spongy part of it. Skin oils on the roller or pad can cause paper pickup and/or print-quality problems. HP recommends using disposable gloves when handling rollers or pads or washing your hands before touching rollers or pads.

---

3. To install an assembly, reverse the removal steps.



**NOTE:** When applicable, special installation instructions are provided for an assembly at the end of the removal procedure. Always completely read the removal instructions and follow all special installation instructions.


---

## Removal and replacement: Left lower cover

Learn how to remove and replace the left lower cover.

### Introduction

This document provides the procedures to remove and replace the left lower cover on the finisher.

 **IMPORTANT:** When applicable, special installation instructions are provided for an assembly at the end of the removal procedure. Always completely read the removal instructions and follow all special installation instructions.

### Before performing service

- Turn the printer power off. A shutting-down message appears on the control-panel display.
- ⚠ **WARNING!** To avoid damage to the printer, turn the power off and wait until the printer shuts down before removing the power cable.
- Disconnect the printer power cable after the printer has completely shut down (the control-panel display is blank).
- Release the finisher from the printer by pulling out on the release latch inside the finisher door.
- Disconnect the cable from the bridge unit to the finisher.
- Disconnect the cable from the finisher to the printer.

Use the table below to identify the correct part number for your printer. To order the part, go to <https://parts.hp.com>.

**Table 5-93 Part information**

Part number	Part description
JC90-01771B	Left lower cover (for stapler/stacker finisher)
JC90-01417B	Left lower cover (for booklet finisher)

### Required tools

- #2 JIS screwdriver with a magnetic tip
- Small, flat-blade screwdriver

### After performing service

- Connect the cable from the finisher to the printer.
- Connect the cable from the bridge unit to the finisher.
- Attach the finisher to the printer, and then push in on the release latch inside the finisher door.
- Connect the printer power cable.
- Turn the printer power on.

## Post service test

Process a job through the finisher and verify that the finisher works correctly.

## Remove the right upper cover (finisher)

Follow these steps to remove the right upper cover (finisher).

- ▲ Remove one screw cap and three machine screws on the upper edge of the cover (callout 1). Remove three sheet metal screws (callout 2) on the lower portion of the cover. Rotate the right edge of the cover away from the finisher, and then slide the cover right to release three tabs (callout 3).

---

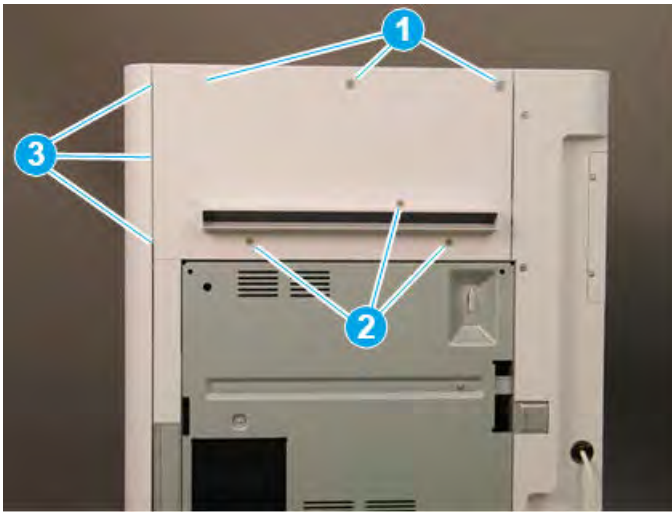
💡 **TIP:** The lower screws are shorter in length than the upper screws.

---

**TIP:** Reverse the removal steps to install the assembly.

---

**Figure 5-204** Remove the right upper cover

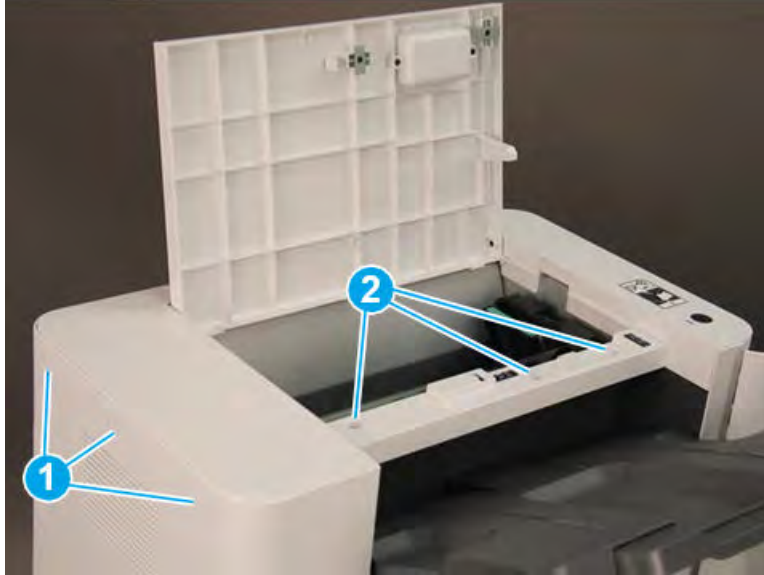


## Remove the top cover (finisher)

Follow these steps to remove the top cover (finisher).

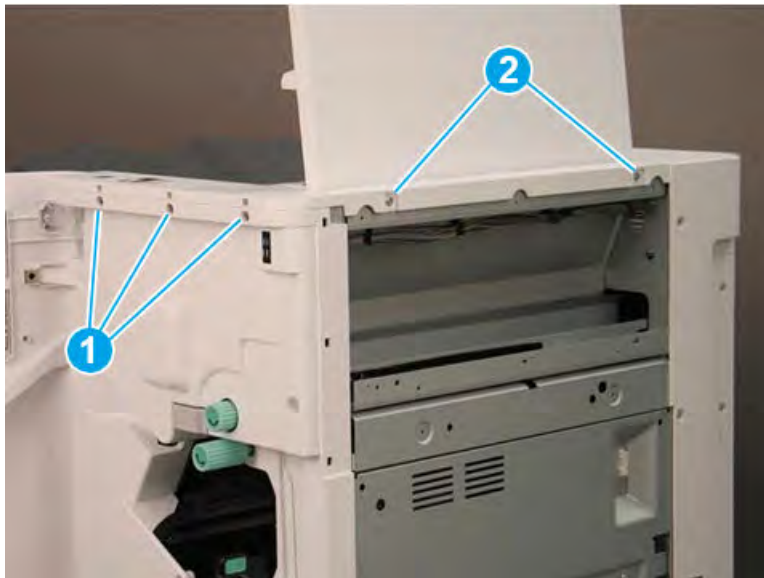
1. Remove three screw caps and three self-tapping screws at the top of the rear cover (callout 1), and then remove three machine screws (callout 2) on top of the cover.

Figure 5-205 Remove six screws




2. Remove three self-tapping screws at the top of the front cover (callout 1), and then remove two machine screws (callout 2) at the top of the right side.

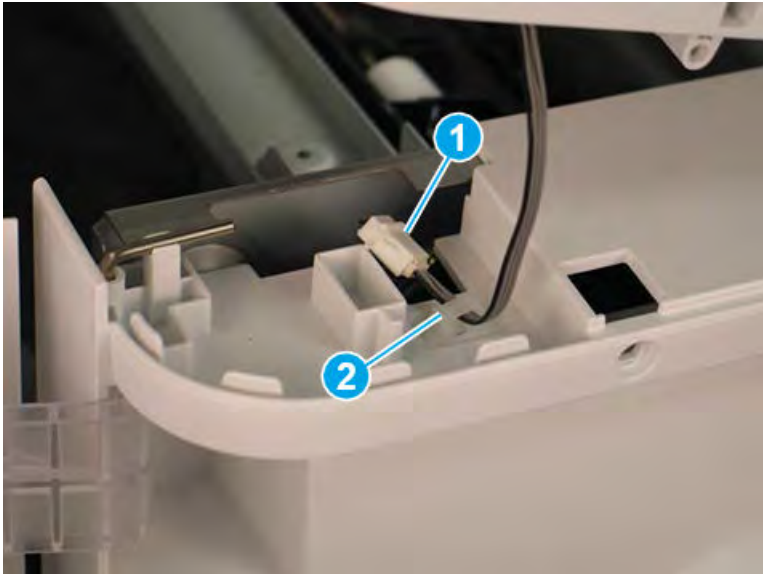
Figure 5-206 Remove five screws



3. Lift the cover up slightly. Disconnect one in-line connector (callout 1), and then release one retainer (callout 2).

 **TIP:** Reverse the removal steps to install the assembly.

**Figure 5-207** Disconnect one connector and release retainer

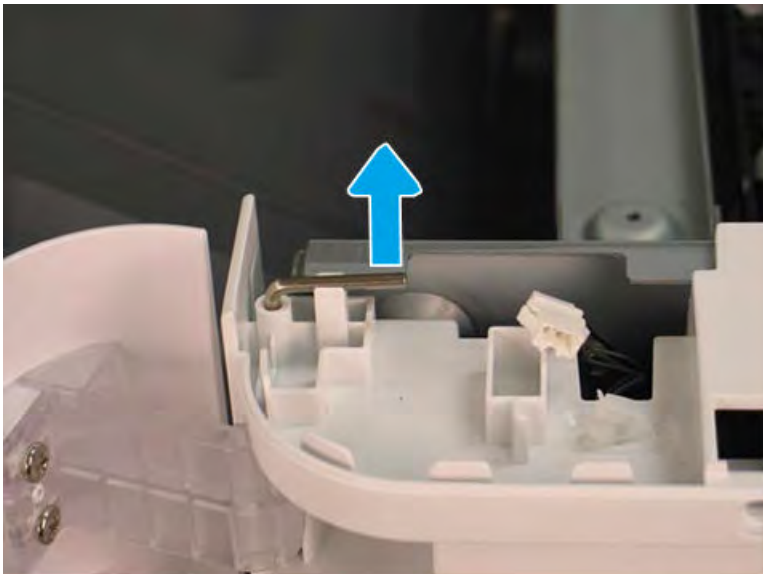


#### Remove the front door (finisher)

Follow these steps to remove the front door (finisher).

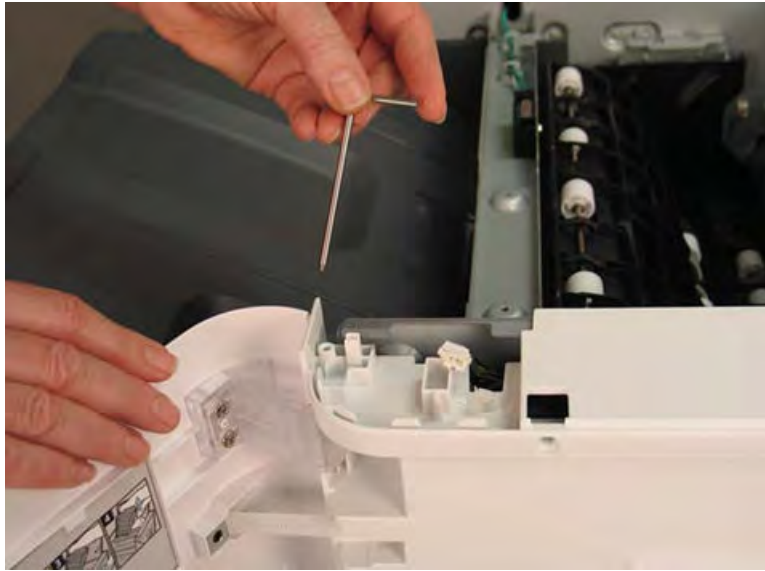
1. Lift the top hinge pin up to release it from the retainer.

**Figure 5-208** Lift the top hinge pin



2. Pull the top hinge pin up to remove it.

Figure 5-209 Remove the top hinge pin



3. Use a small, flat-blade screwdriver to release the lower hinge pin from the retainer, and then rotate it away from the finisher.

Figure 5-210 Release the lower hinge pin




4. Support the door with one hand, and then pull the lower hinge pin straight up to remove it.

**Figure 5-211** Remove the lower hinge pin



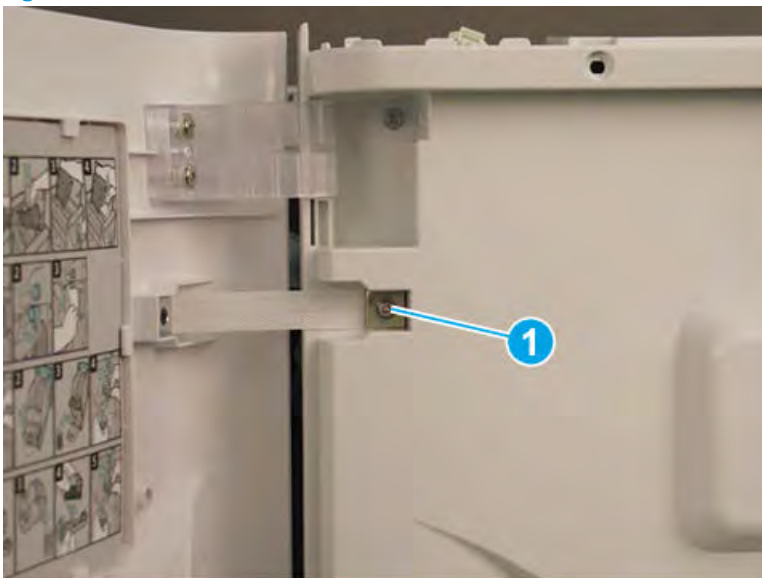
5. Support the door with one hand, and then remove one screw (callout 1) to release the strap. Remove the front door.

---

 **TIP:** Reverse the removal steps to install the assembly.

---

**Figure 5-212** Remove the front door



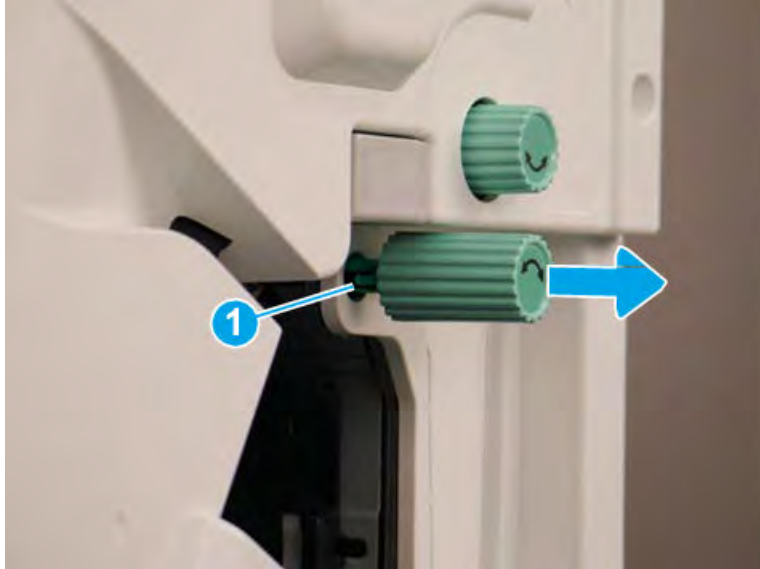
### Remove the front cover (finisher)

Follow these steps to remove the front cover (finisher).

1. Release one tab (callout 1), and then pull the jam-access knob away from the finisher to remove it.



Figure 5-213 Remove the jam-access knob




2. If the punch unit is installed, remove the punch waste bin (callout 1).
3. Remove one screw (callout 1) on top of the front cover.

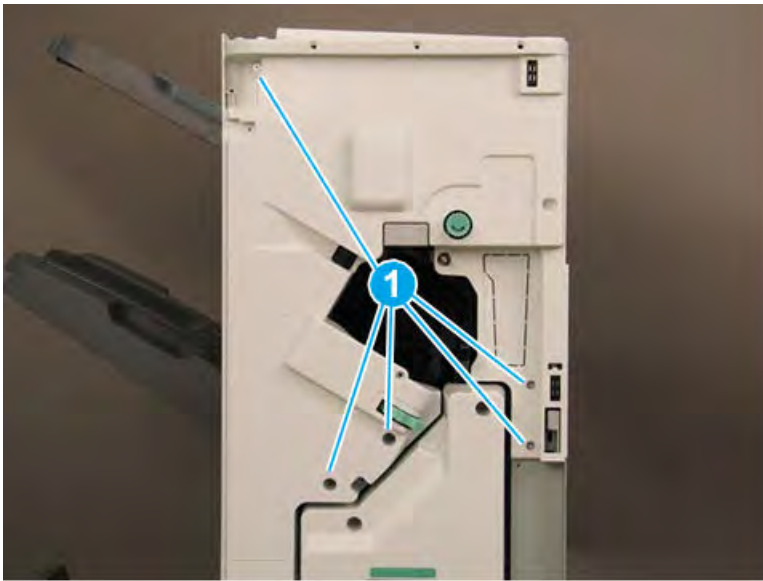
Figure 5-214 Remove one screw



4. Remove five machine screws (callout 1), and then remove the front cover.

 **TIP:** Reverse the removal steps to install the assembly.

**Figure 5-215** Remove the front cover

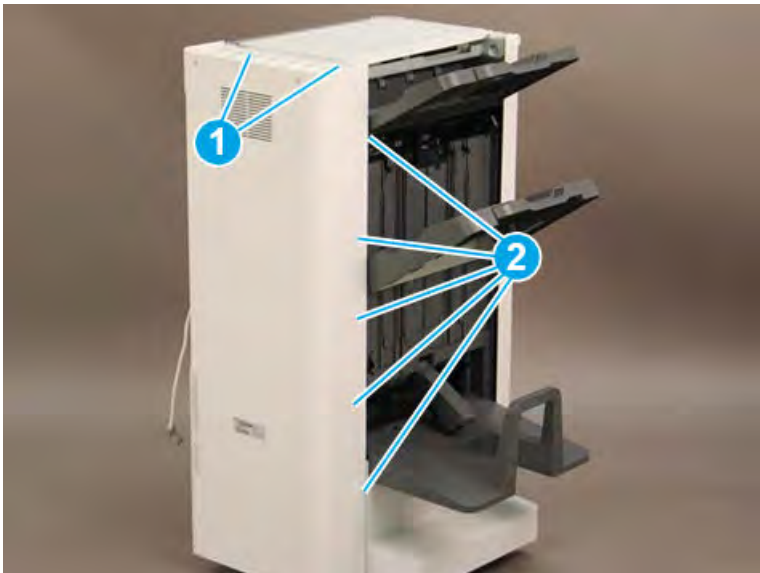


#### Remove the rear cover (finisher)

Follow these steps to remove the rear cover (finisher).


1. Remove two self-tapping screws (callout 1) on the top of the rear cover, and then remove five screw caps and five machine screws (callout 2) on the left side of the cover.

**Figure 5-216** Remove seven screws

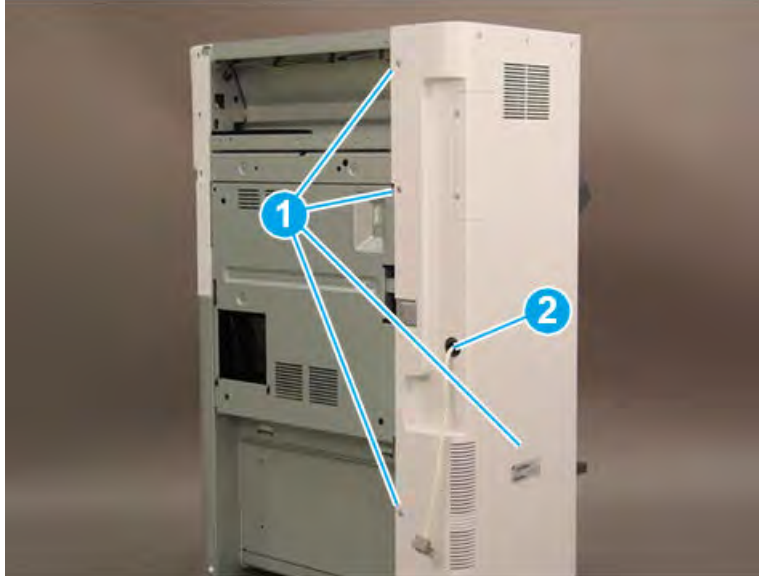


2. Remove one screw cap and four machine screws (callout 1) Remove the rear cover.

 **NOTE:** Make sure to thread the power cable (callout 2) through the opening in the cover.

 **TIP:** Reverse the removal steps to install the assembly

**Figure 5-217** Remove the rear cover

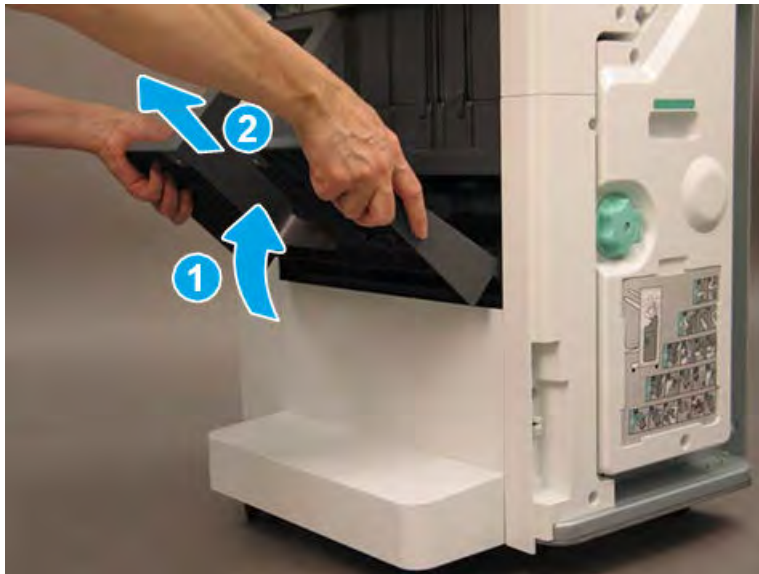


### Remove the booklet output tray

Follow these steps to remove the booklet output tray.

1. Raise the booklet output tray up (callout 1), and then pull it away from the finisher (callout 2) to remove it.

**Figure 5-218** Remove the booklet output tray



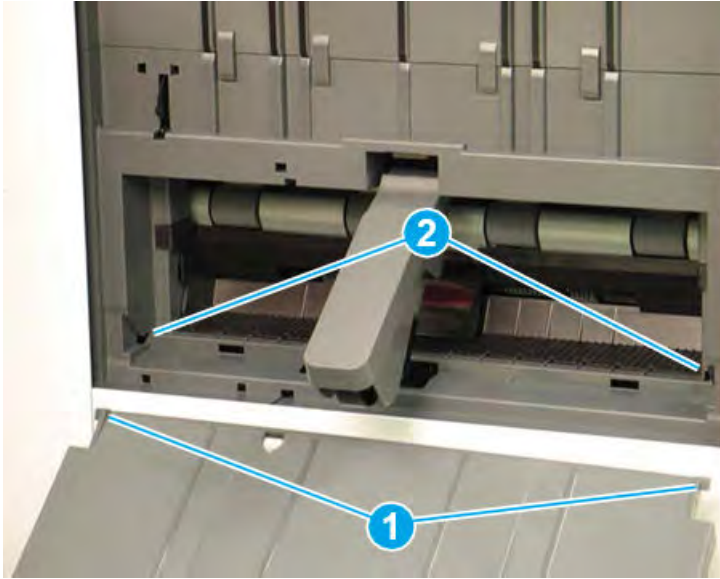
- Reverse the removal steps to install the assembly. Also use the following special installation instructions.

 **NOTE:** Continue to reverse the removal steps to finish installing the assembly

Special installation instructions: booklet output tray

Position the tabs (callout 1) on the tray into the slots (callout 2) on the finisher.

**Figure 5-219** Install the booklet output tray

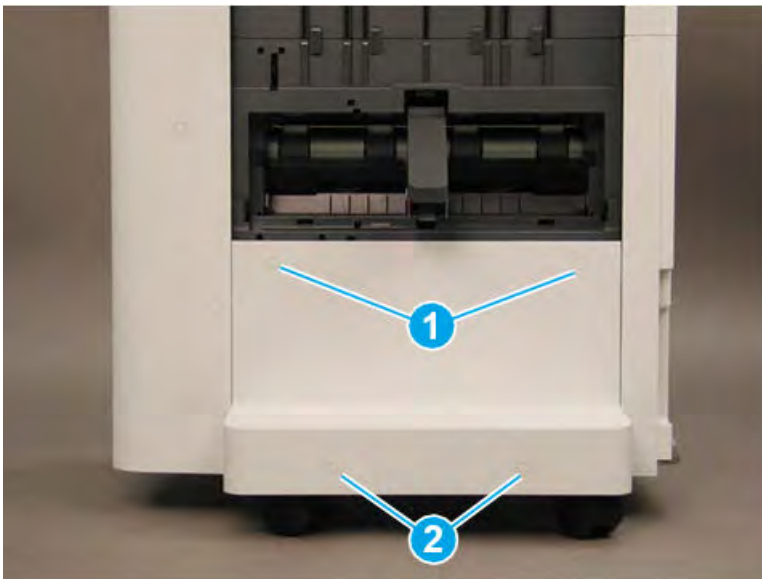


### Remove the caster cover

Follow these steps to remove the caster cover.

- Remove two screw caps and two self-tapping screws (callout 1). Remove two screw caps and two machine screws (callout 2).

**Figure 5-220** Remove four screws

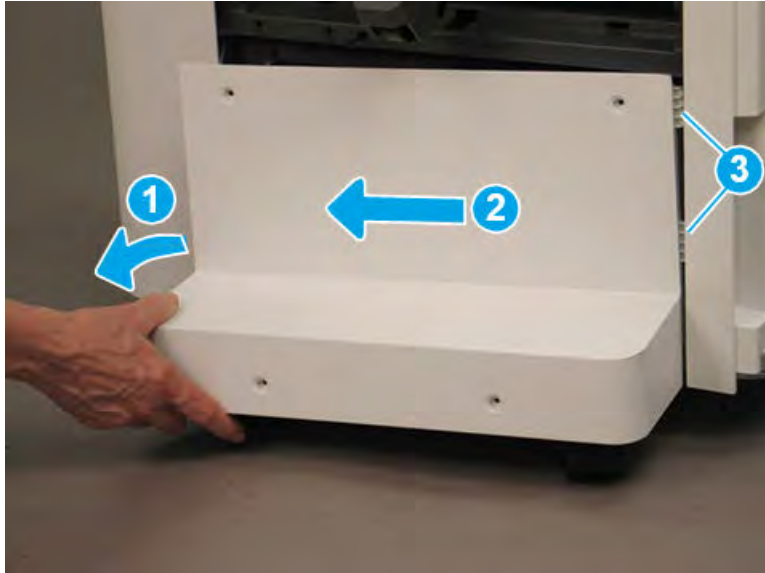


2. Rotate the left edge of the cover away from the finisher (callout 1), and then slide the cover to the left (callout 2) to remove it.

 **TIP:** Make sure that two tabs (callout 3) are positioned under the front lower cover when reinstalling the caster cover.

**TIP:** Reverse the removal steps to install the assembly


**Figure 5-221** Remove the caster cover



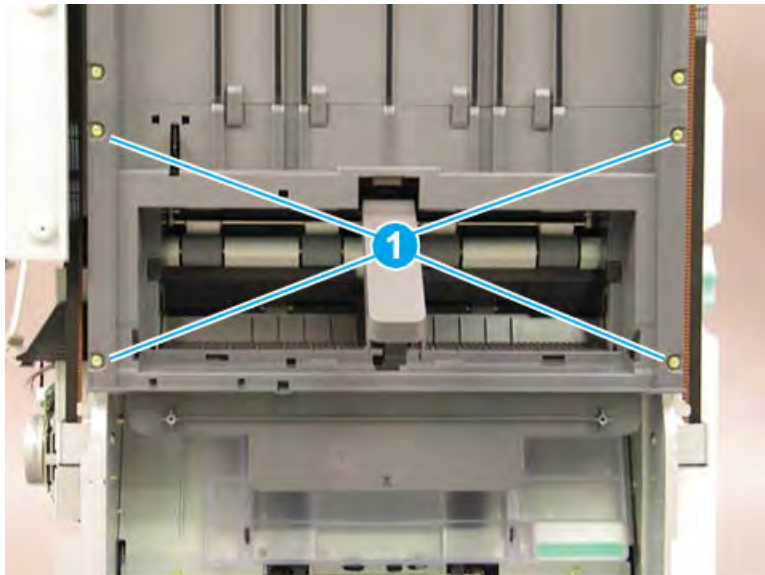
#### Remove the left lower cover (finisher)

Follow these steps to remove the left lower cover (finisher).

1. Remove four screws (callout 1).

 **NOTE:** Raise the lower output tray as needed to access the screws.

**Figure 5-222** Remove four screws

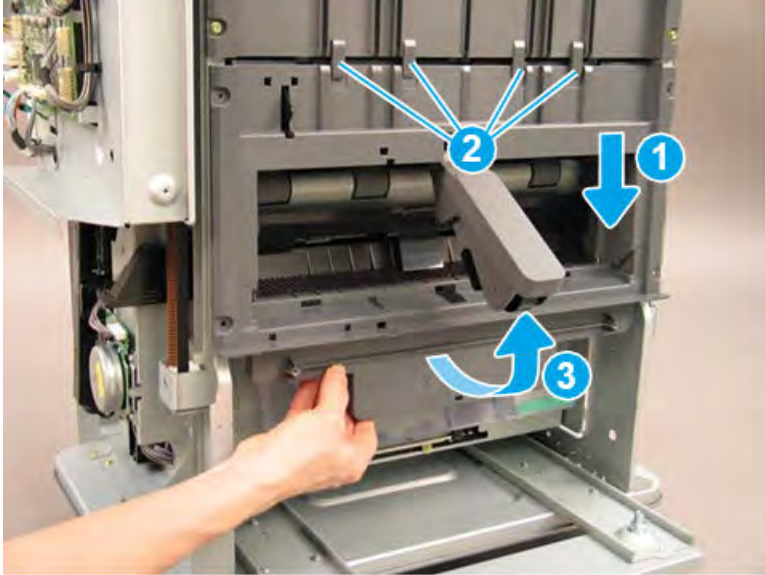


- Slide the shield down (callout 1) to release it from four tabs (callout 2), and then rotate it away from the finisher (callout 3).

**CAUTION:** The shield is still attached to the finisher. Do not attempt to completely remove the shield.

**TIP:** Position the shield under the four tabs (callout 2) when reinstalling it.

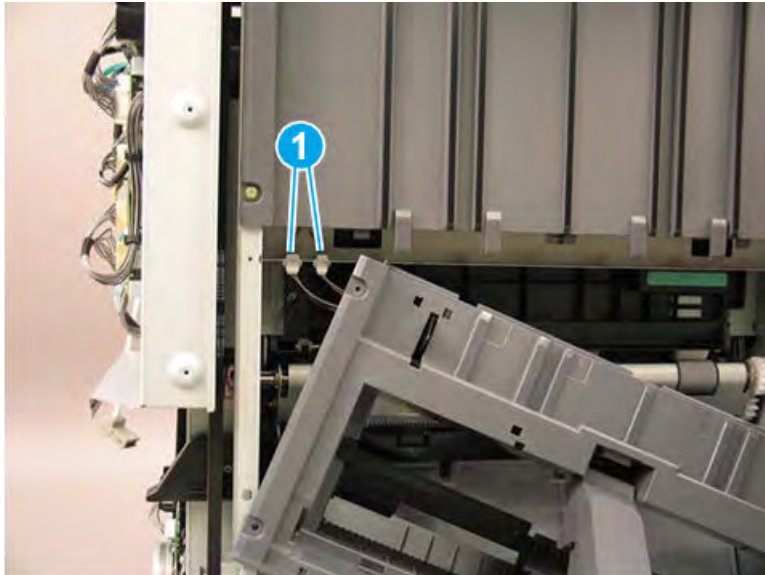
**Figure 5-223** Release the lower shield



- Disconnect two connectors (callout 1), and then remove the shield.

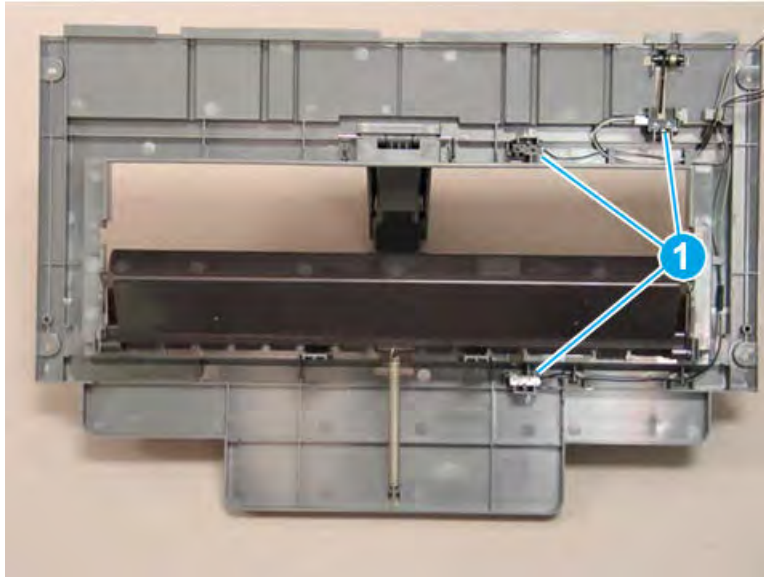
**TIP:** Reverse the removal steps to install the assembly.

**Figure 5-224** Disconnect two connectors



4. If you are replacing the left lower cover, locate three sensors (callout 1) on the back of the left lower cover. Remove these sensors and transfer them to the replacement part.

**Figure 5-225** Remove the left lower cover



### Unpack the replacement assembly

Follow these steps to unpack the replacement assembly.

1. Dispose of the defective part.




**NOTE:** HP recommends responsible disposal of the defective part.

<http://www8.hp.com/us/en/hp-information/environment/product-recycling.html>

2. Unpack the replacement part from the packaging.



**CAUTION:**  Some parts are sensitive to electrostatic discharge (ESD). Always perform service work at an ESD-protected workstation or mat. If an ESD workstation or mat is not available, touch the sheet-metal chassis to provide a static ground before touching an ESD-sensitive assembly. Protect the ESD-sensitive assemblies by placing them in ESD pouches when they are out of the printer.



**IMPORTANT:** Make sure that all of the shipping materials (for example shipping tape) are removed from the replacement part prior to installation.



**NOTE:** If the replacement part is a roller or pad, avoid touching the spongy part of it. Skin oils on the roller or pad can cause paper pickup and/or print-quality problems. HP recommends using disposable gloves when handling rollers or pads or washing your hands before touching rollers or pads.

3. To install an assembly, reverse the removal steps.




**NOTE:** When applicable, special installation instructions are provided for an assembly at the end of the removal procedure. Always completely read the removal instructions and follow all special installation instructions.

## Removal and replacement: Left upper cover

Learn how to remove and replace the left upper cover.

### Introduction

This document provides the procedures to remove and replace the left upper cover on the finisher.

 **IMPORTANT:** When applicable, special installation instructions are provided for an assembly at the end of the removal procedure. Always completely read the removal instructions and follow all special installation instructions.

### Before performing service

- Turn the printer power off. A shutting-down message appears on the control-panel display.
- ⚠ **WARNING!** To avoid damage to the printer, turn the power off and wait until the printer shuts down before removing the power cable.
- Disconnect the printer power cable after the printer has completely shut down (the control-panel display is blank).
- Release the finisher from the printer by pulling out on the release latch inside the finisher door.
- Disconnect the cable from the bridge unit to the finisher.
- Disconnect the cable from the finisher to the printer.

Use the table below to identify the correct part number for your printer. To order the part, go to <https://parts.hp.com>.

**Table 5-94 Part information**

Part number	Part description
JC90-01475B	Left upper cover

### Required tools

- #2 JIS screwdriver with a magnetic tip
- Small, flat-blade screwdriver

### After performing service

- Connect the cable from the finisher to the printer.
- Connect the cable from the bridge unit to the finisher.
- Attach the finisher to the printer, and then push in on the release latch inside the finisher door.
- Connect the printer power cable.
- Turn the printer power on.

### Post service test

Process a job through the finisher and verify that the finisher works correctly.



### Remove the right upper cover (finisher)

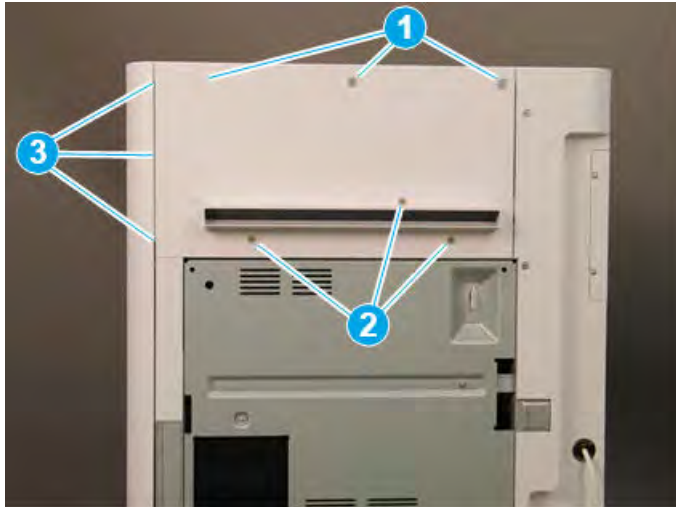
Follow these steps to remove the right upper cover (finisher).

- ▲ Remove one screw cap and three machine screws on the upper edge of the cover (callout 1). Remove three sheet metal screws (callout 2) on the lower portion of the cover. Rotate the right edge of the cover away from the finisher, and then slide the cover right to release three tabs (callout 3).

💡 **TIP:** The lower screws are shorter in length than the upper screws.

**TIP:** Reverse the removal steps to install the assembly.

Figure 5-226 Remove the right upper cover

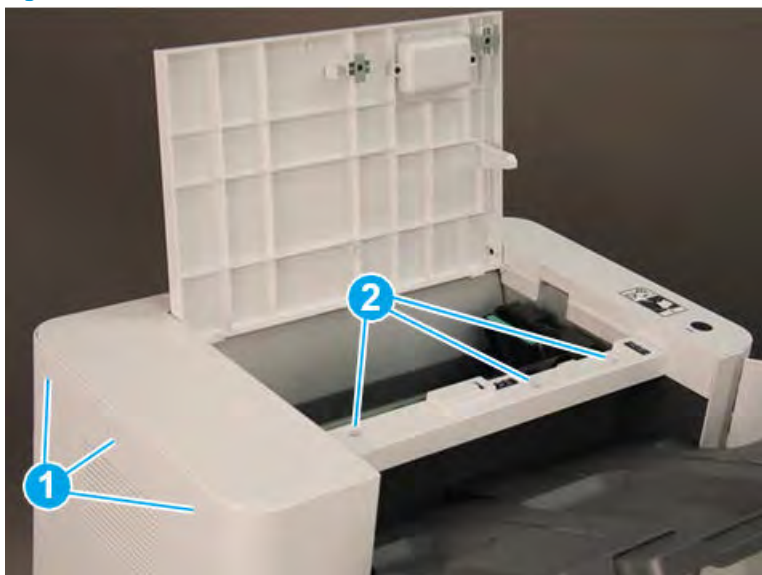


### Remove the top cover (finisher)

Follow these steps to remove the top cover (finisher).

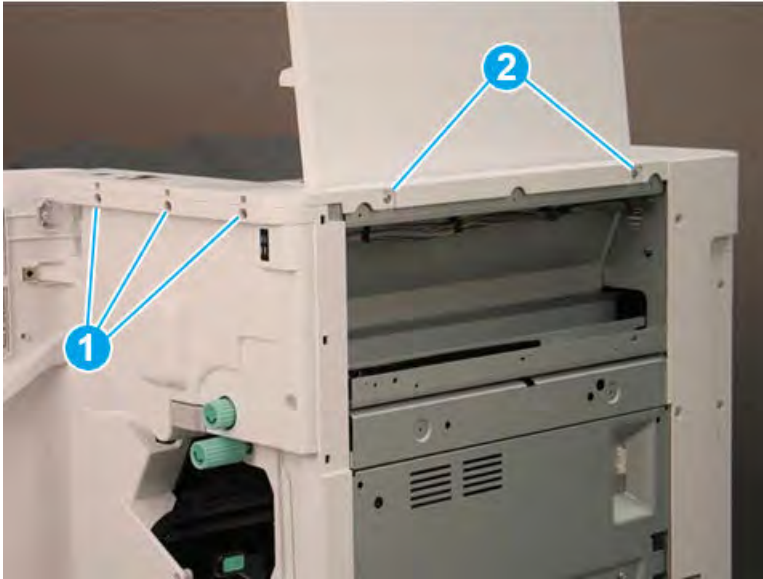
1. Remove three screw caps and three self-tapping screws at the top of the rear cover (callout 1), and then remove three machine screws (callout 2) on top of the cover.

Figure 5-227 Remove six screws




2. Remove three self-tapping screws at the top of the front cover (callout 1), and then remove two machine screws (callout 2) at the top of the right side.

Figure 5-228 Remove five screws



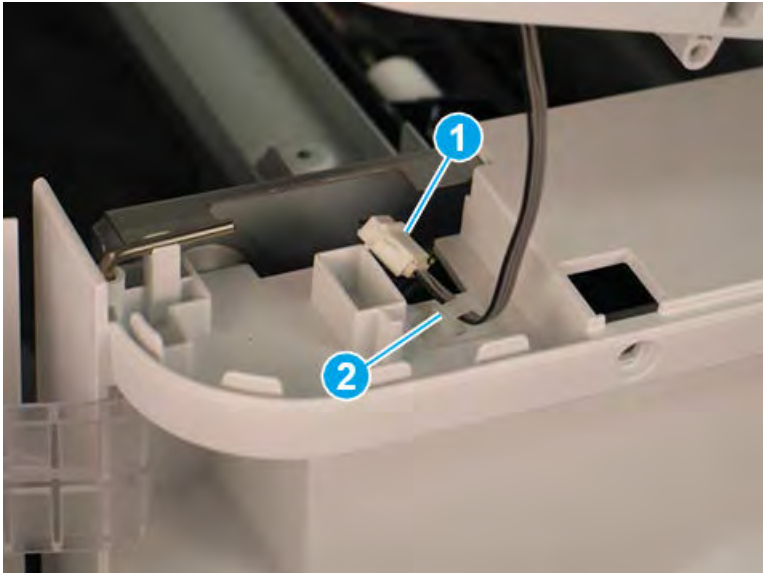
3. Lift the cover up slightly. Disconnect one in-line connector (callout 1), and then release one retainer (callout 2).

---

 **TIP:** Reverse the removal steps to install the assembly.

---

Figure 5-229 Disconnect one connector and release retainer

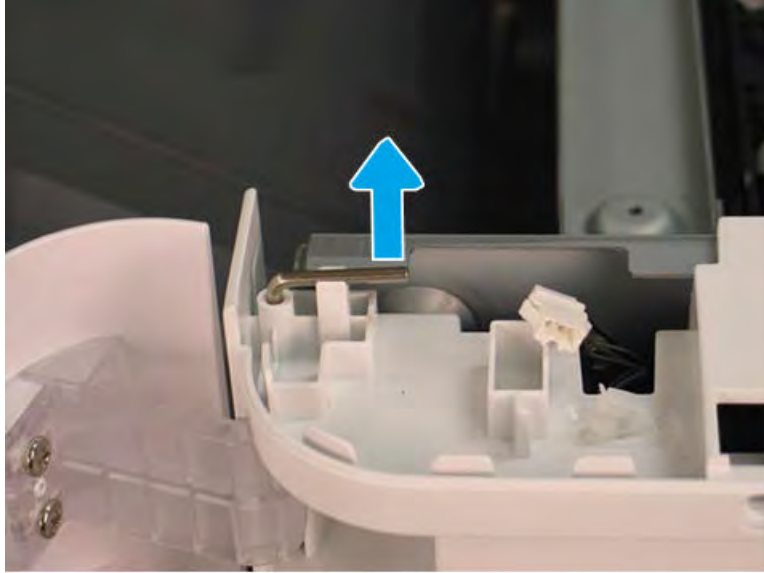


### Remove the front door (finisher)

Follow these steps to remove the front door (finisher).

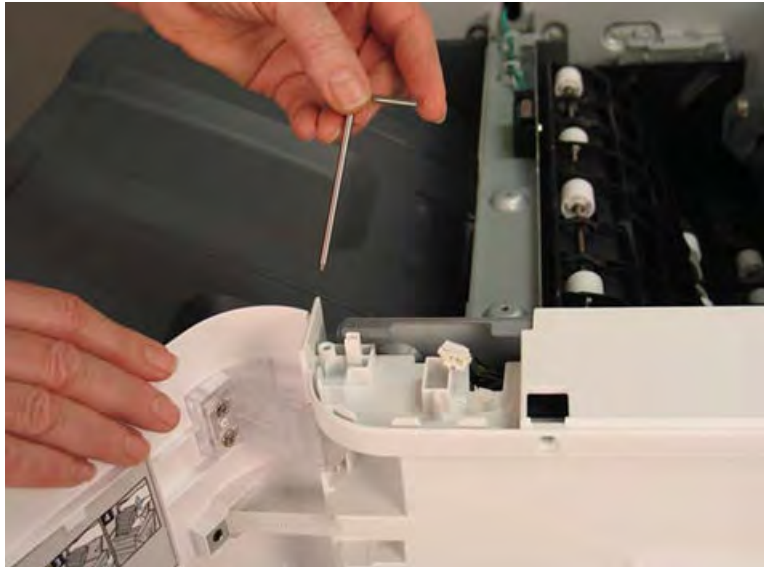
1. Lift the top hinge pin up to release it from the retainer.

Figure 5-230 Lift the top hinge pin



2. Pull the top hinge pin up to remove it.

Figure 5-231 Remove the top hinge pin



3. Use a small, flat-blade screwdriver to release the lower hinge pin from the retainer, and then rotate it away from the finisher.

**Figure 5-232** Release the lower hinge pin




4. Support the door with one hand, and then pull the lower hinge pin straight up to remove it.

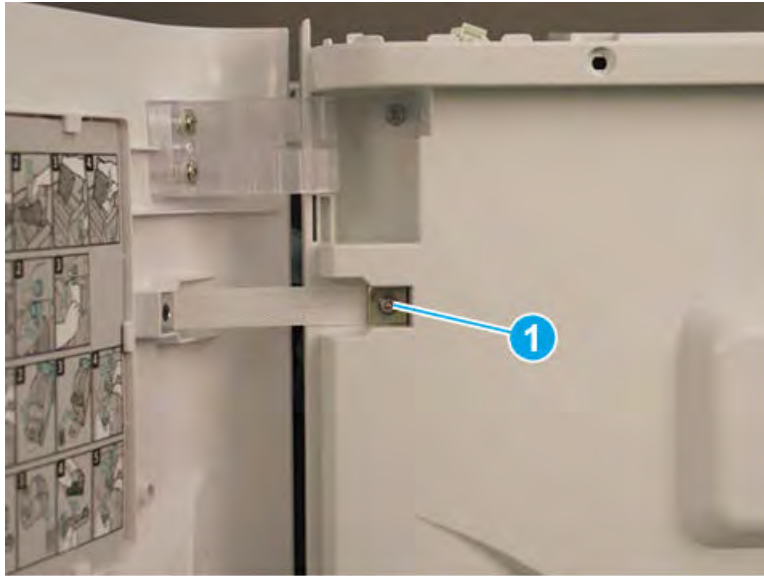
**Figure 5-233** Remove the lower hinge pin



5. Support the door with one hand, and then remove one screw (callout 1) to release the strap. Remove the front door.

 **TIP:** Reverse the removal steps to install the assembly.

**Figure 5-234** Remove the front door

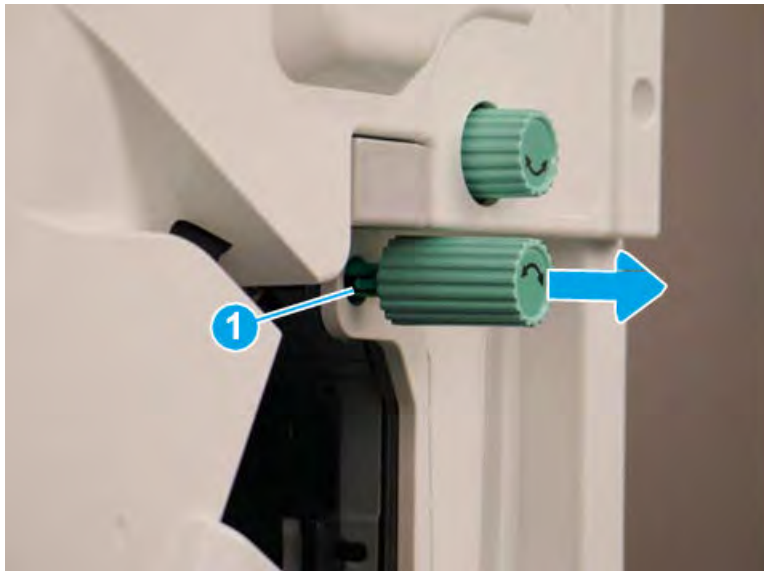


#### Remove the front cover (finisher)

Follow these steps to remove the front cover (finisher).

1. Release one tab (callout 1), and then pull the jam-access knob away from the finisher to remove it.

**Figure 5-235** Remove the jam-access knob



2. If the punch unit is installed, remove the punch waste bin (callout 1).


3. Remove one screw (callout 1) on top of the front cover.

Figure 5-236 Remove one screw



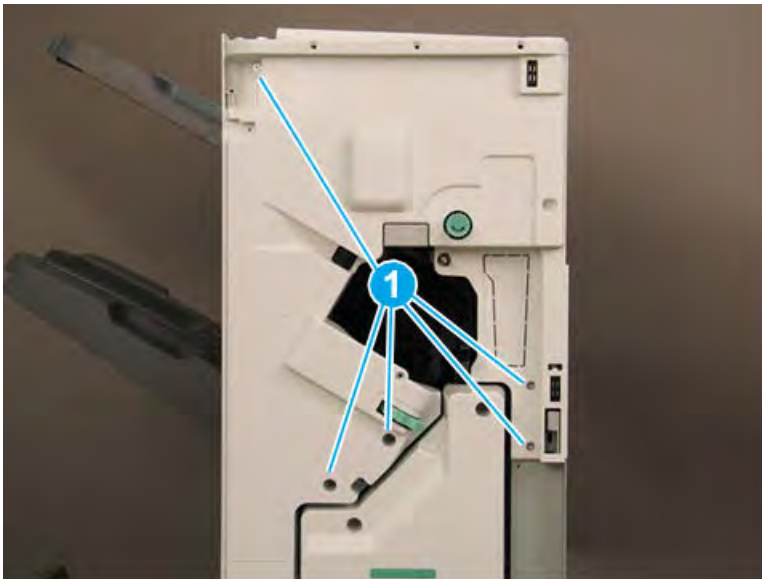
4. Remove five machine screws (callout 1), and then remove the front cover.

---

 **TIP:** Reverse the removal steps to install the assembly.

---

Figure 5-237 Remove the front cover

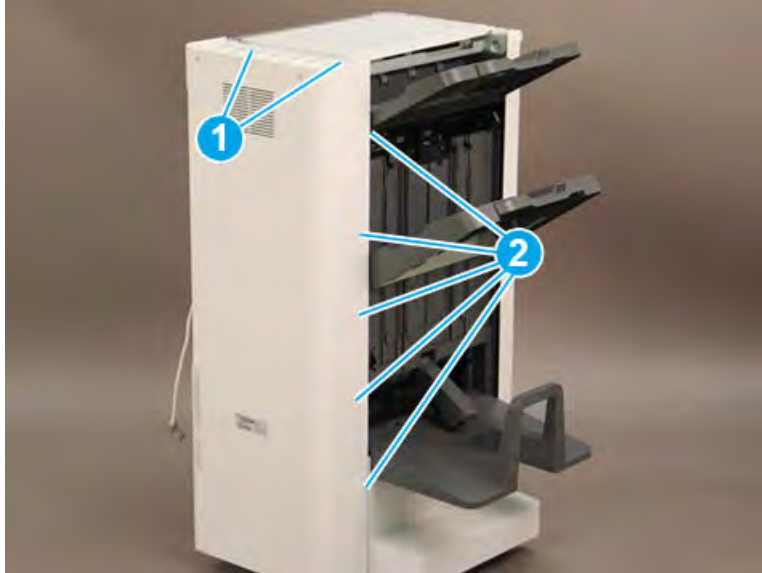


### Remove the rear cover (finisher)

Follow these steps to remove the rear cover (finisher).

1. Remove two self-tapping screws (callout 1) on the top of the rear cover, and then remove five screw caps and five machine screws (callout 2) on the left side of the cover.

Figure 5-238 Remove seven screws




2. Remove one screw cap and four machine screws (callout 1) Remove the rear cover.

---

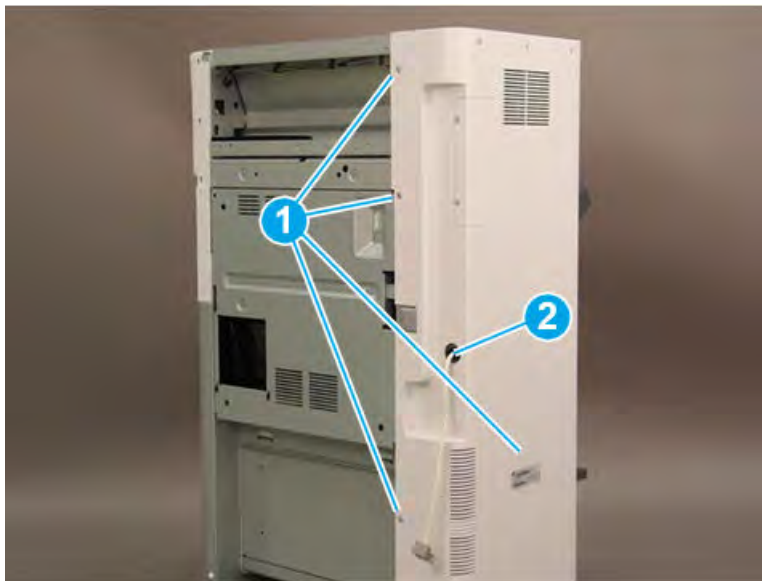
 **NOTE:** Make sure to thread the power cable (callout 2) through the opening in the cover.

---

 **TIP:** Reverse the removal steps to install the assembly

---

Figure 5-239 Remove the rear cover



### Remove the booklet output tray

Follow these steps to remove the booklet output tray.

1. Raise the booklet output tray up (callout 1), and then pull it away from the finisher (callout 2) to remove it.

Figure 5-240 Remove the booklet output tray



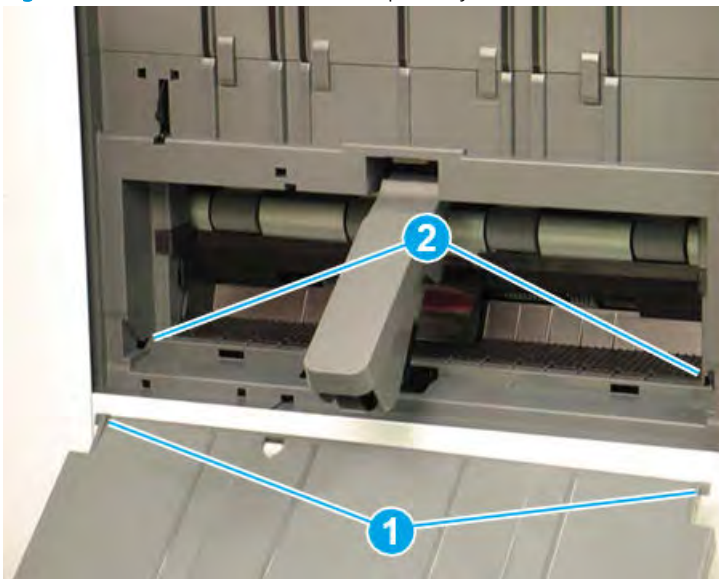
2. Reverse the removal steps to install the assembly. Also use the following special installation instructions.

 **NOTE:** Continue to reverse the removal steps to finish installing the assembly

Special installation instructions: booklet output tray

Position the tabs (callout 1) on the tray into the slots (callout 2) on the finisher.

Figure 5-241 Install the booklet output tray



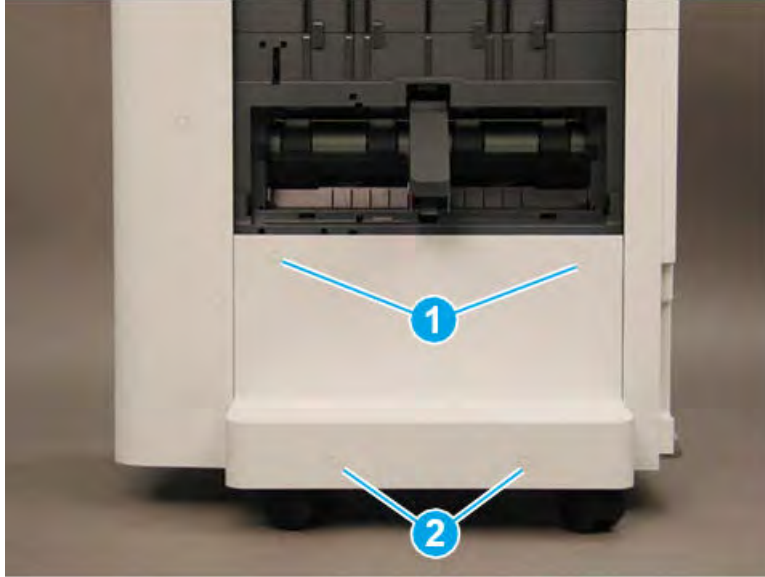
### Remove the caster cover

Follow these steps to remove the caster cover.

1. Remove two screw caps and two self-tapping screws (callout 1). Remove two screw caps and two machine screws (callout 2).



Figure 5-242 Remove four screws



2. Rotate the left edge of the cover away from the finisher (callout 1), and then slide the cover to the left (callout 2) to remove it.

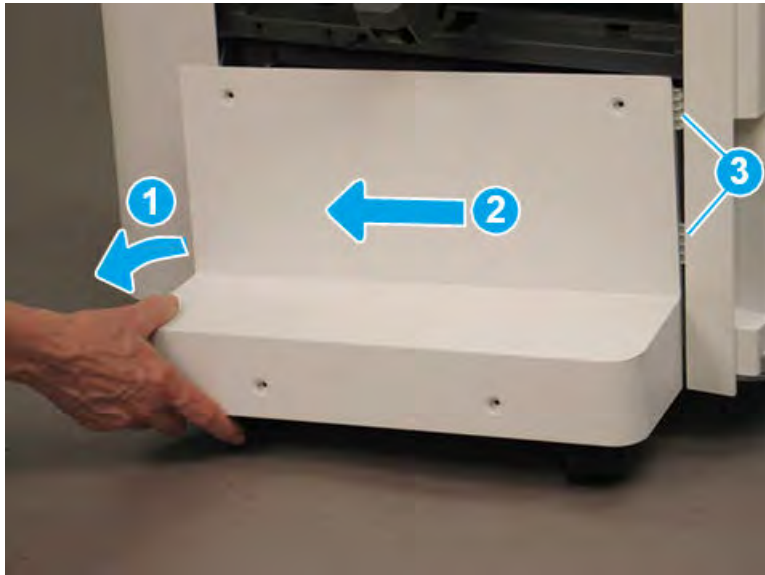
---

 **TIP:** Make sure that two tabs (callout 3) are positioned under the front lower cover when reinstalling the caster cover.

**TIP:** Reverse the removal steps to install the assembly

---

Figure 5-243 Remove the caster cover




### Remove the left lower cover (finisher)

Follow these steps to remove the left lower cover (finisher).

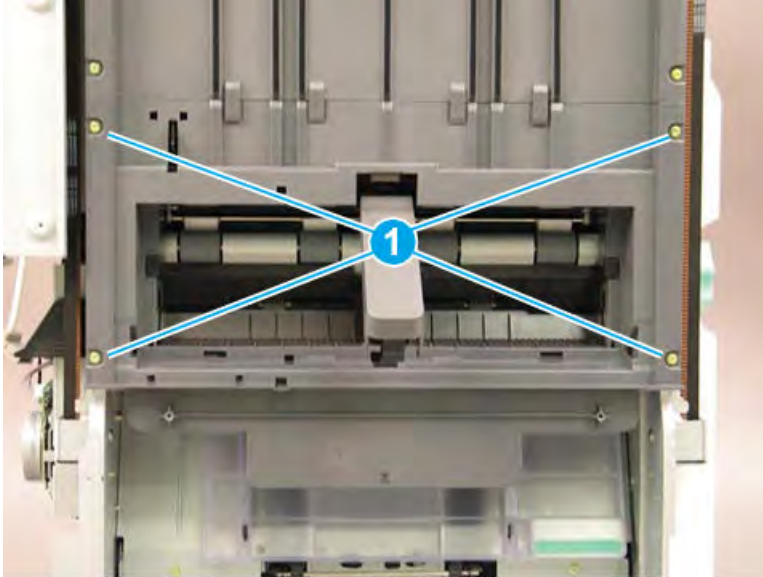
1. Remove four screws (callout 1).

---

 **NOTE:** Raise the lower output tray as needed to access the screws.

---

Figure 5-244 Remove four screws



2. Slide the shield down (callout 1) to release it from four tabs (callout 2), and then rotate it away from the finisher (callout 3).

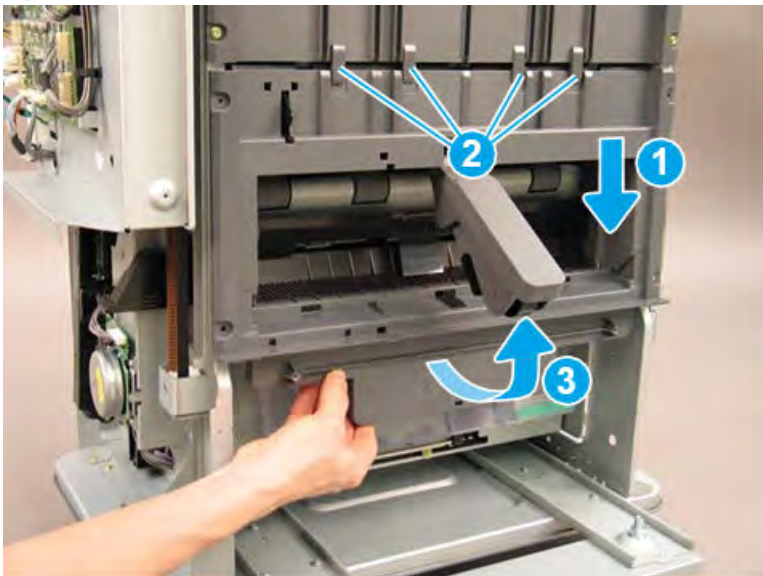
---

**⚠ CAUTION:** The shield is still attached to the finisher. Do not attempt to completely remove the shield.


**💡 TIP:** Position the shield under the four tabs (callout 2) when reinstalling it.

---

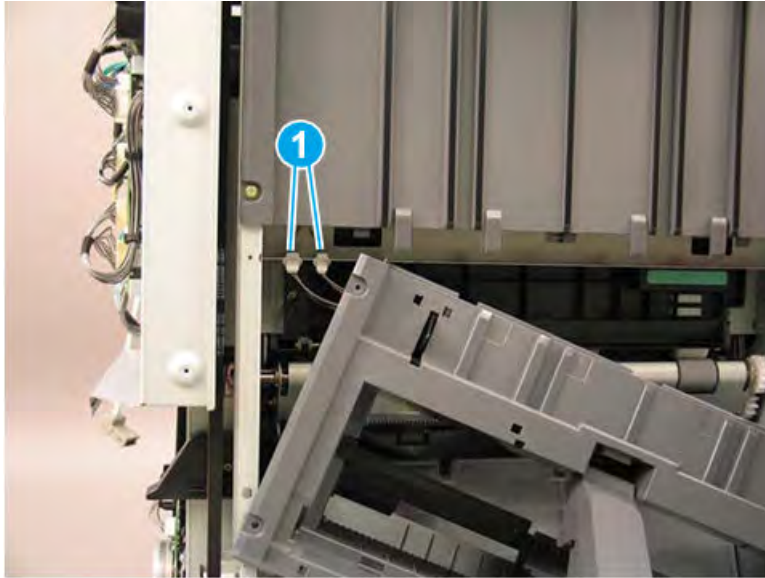
Figure 5-245 Release the lower shield



3. Disconnect two connectors (callout 1), and then remove the shield.

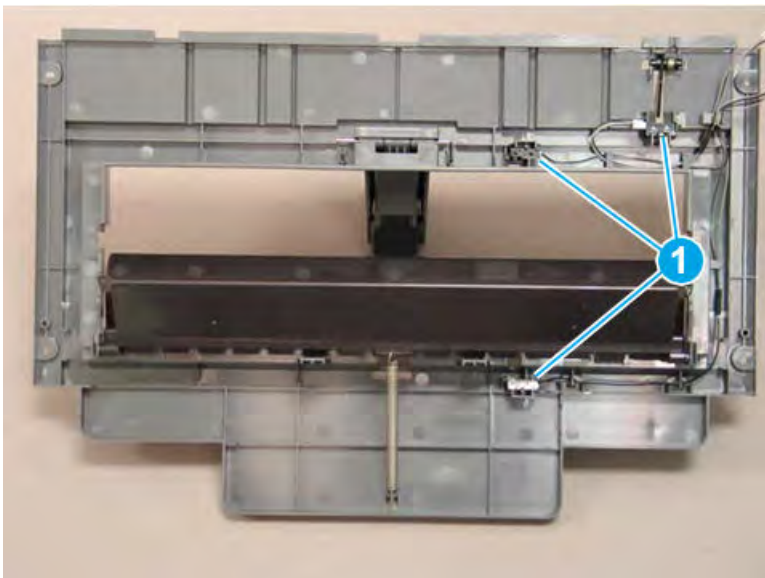
 **TIP:** Reverse the removal steps to install the assembly.

**Figure 5-246** Disconnect two connectors



4. If you are replacing the left lower cover, locate three sensors (callout 1) on the back of the left lower cover. Remove these sensors and transfer them to the replacement part.

**Figure 5-247** Remove the left lower cover

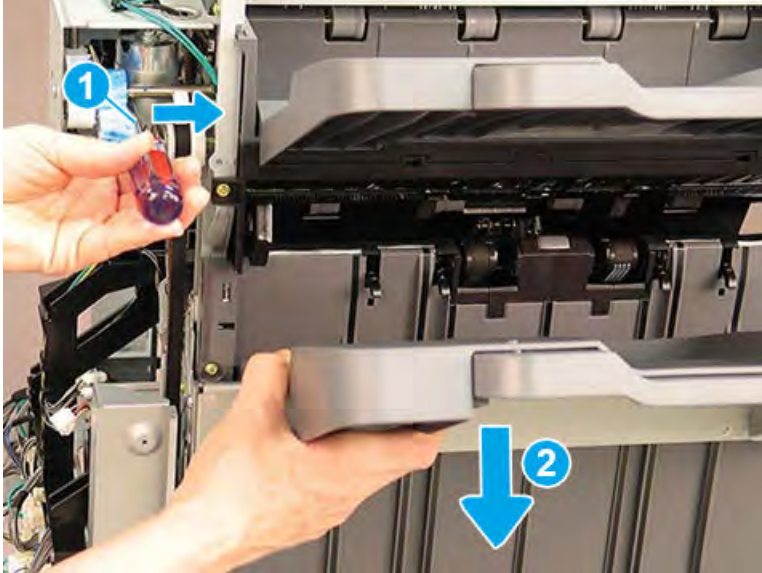


### Remove the left upper cover (finisher)

Follow these steps to remove the left upper cover (finisher).

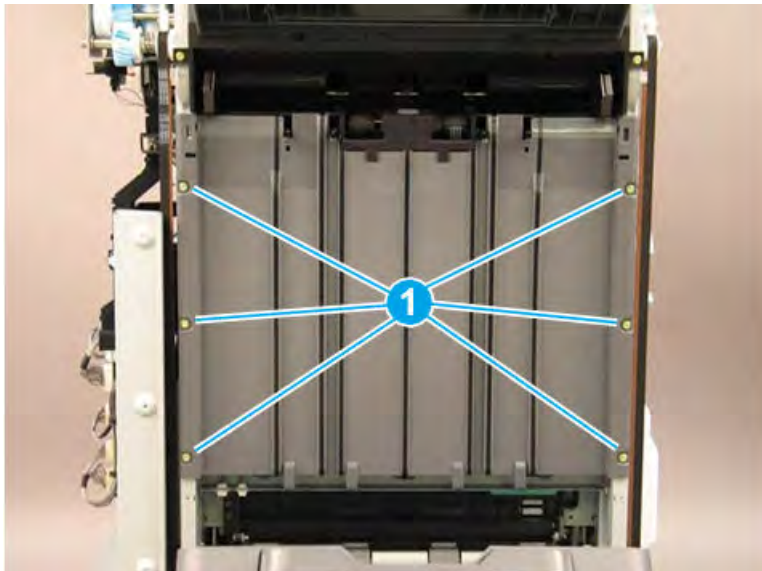
1. Bring the lower output tray down by positioning the shaft of a screwdriver on the clutch (callout 1) and gently pressing to the right to release the clutch. Hold the clutch in the released position and lower the tray (callout 2) to the lowest position.

Figure 5-248 Lower the output tray



2. Remove six machine screws (callout 1).

Figure 5-249 Remove six screws

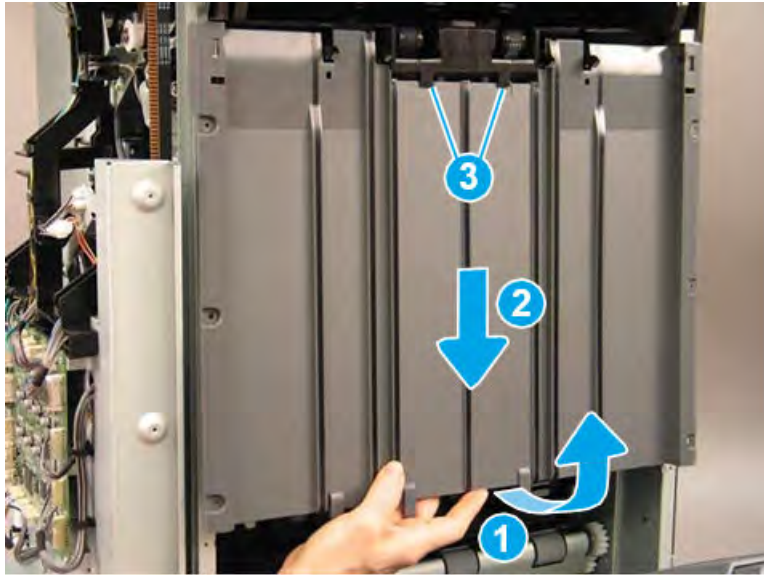


3. Rotate the lower edge of the shield away from the finisher (callout 1), and then slide the shield down (callout 2) to release it from two tabs (callout 3).

**CAUTION:** The shield is still attached to the finisher. Do not attempt to completely remove the shield.

**TIP:** Position the shield under the two tabs (callout 3) when reinstalling it.

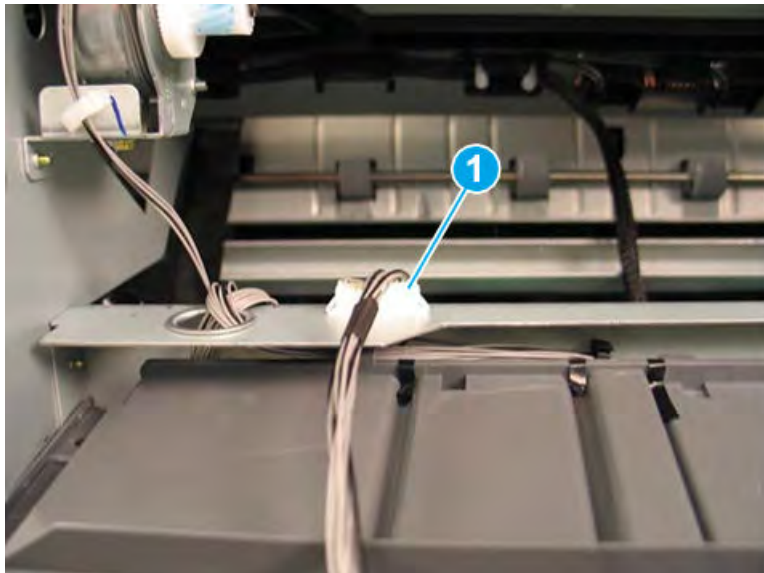
Figure 5-250 Release the shield



4. Disconnect one connector (callout 1), and then remove the upper shield assembly.

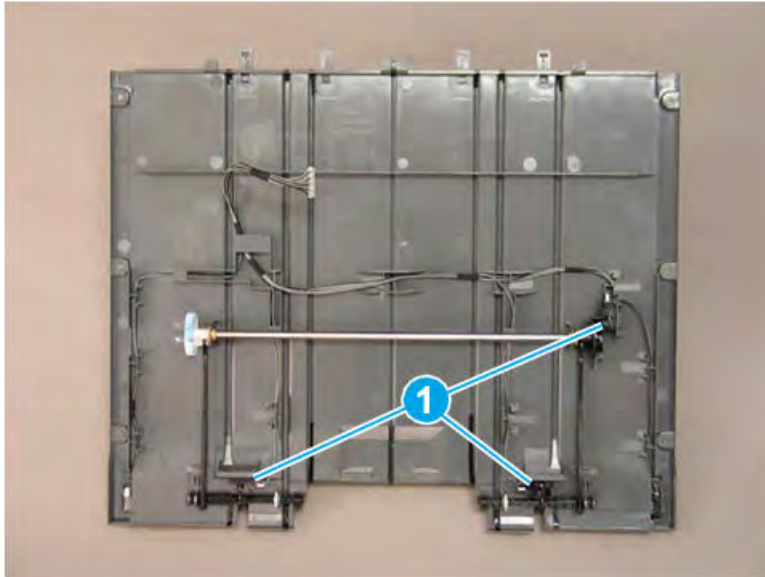
**TIP:** Reverse the removal steps to install the assembly.

Figure 5-251 Disconnect one connector



5. If you are replacing the left upper cover, locate three sensors (callout 1) on the back of the left upper cover. Remove these sensors and transfer them to the replacement part.

**Figure 5-252** Remove the left upper cover



### Unpack the replacement assembly

Follow these steps to unpack the replacement assembly.

1. Dispose of the defective part.




**NOTE:** HP recommends responsible disposal of the defective part.

<http://www8.hp.com/us/en/hp-information/environment/product-recycling.html>

2. Unpack the replacement part from the packaging.



**CAUTION:**  Some parts are sensitive to electrostatic discharge (ESD). Always perform service work at an ESD-protected workstation or mat. If an ESD workstation or mat is not available, touch the sheet-metal chassis to provide a static ground before touching an ESD-sensitive assembly. Protect the ESD-sensitive assemblies by placing them in ESD pouches when they are out of the printer.



**IMPORTANT:** Make sure that all of the shipping materials (for example shipping tape) are removed from the replacement part prior to installation.



**NOTE:** If the replacement part is a roller or pad, avoid touching the spongy part of it. Skin oils on the roller or pad can cause paper pickup and/or print-quality problems. HP recommends using disposable gloves when handling rollers or pads or washing your hands before touching rollers or pads.

3. To install an assembly, reverse the removal steps.



**NOTE:** When applicable, special installation instructions are provided for an assembly at the end of the removal procedure. Always completely read the removal instructions and follow all special installation instructions.

## Removal and replacement: Booklet finisher front cover

Learn how to remove and replace the booklet front cover.

### Introduction

This document provides the procedures to remove and replace the booklet front cover on the finisher.



**IMPORTANT:** When applicable, special installation instructions are provided for an assembly at the end of the removal procedure. Always completely read the removal instructions and follow all special installation instructions.

### Before performing service

- Turn the printer power off. A shutting-down message appears on the control-panel display.
- ⚠ **WARNING!** To avoid damage to the printer, turn the power off and wait until the printer shuts down before removing the power cable.
- Disconnect the printer power cable after the printer has completely shut down (the control-panel display is blank).
- Release the finisher from the printer by pulling out on the release latch inside the finisher door.
- Disconnect the cable from the bridge unit to the finisher.
- Disconnect the cable from the finisher to the printer.

Use the table below to identify the correct part number for your printer. To order the part, go to <https://parts.hp.com>.

**Table 5-95 Part information**

Part number	Part description
JC90-01478B	Booklet front cover

### Required tools

- #2 JIS screwdriver with a magnetic tip

### After performing service

- Connect the cable from the finisher to the printer.
- Connect the cable from the bridge unit to the finisher.
- Attach the finisher to the printer, and then push in on the release latch inside the finisher door.
- Connect the printer power cable.
- Turn the printer power on.

### Post service test

Process a job through the finisher and verify that the finisher works correctly.

## Remove the booklet front cover

Follow these steps to remove the booklet front cover.

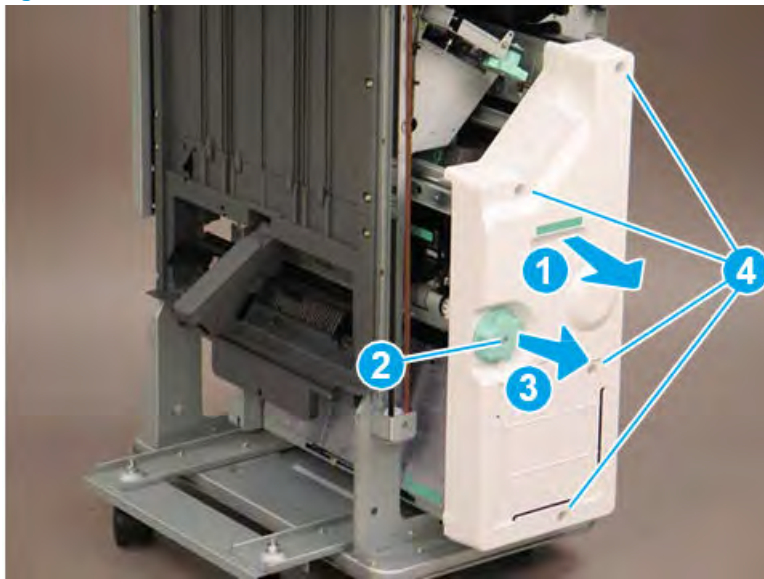
- ▲ Slide the booklet maker slightly away from the finisher (callout 1). Remove one screw (callout 2), and then slide the green knob away from the booklet maker to remove it (callout 3). Remove four screws (callout 4), and then remove the booklet front cover.

---

💡 **TIP:** Reverse the removal steps to install the assembly

---

**Figure 5-253** Remove five screws and the cover



## Unpack the replacement assembly

Follow these steps to unpack the replacement assembly.

1. Dispose of the defective part.

---


📄 **NOTE:** HP recommends responsible disposal of the defective part.

<http://www8.hp.com/us/en/hp-information/environment/product-recycling.html>

---

2. Unpack the replacement part from the packaging.

---

⚠️ **CAUTION:**  Some parts are sensitive to electrostatic discharge (ESD). Always perform service work at an ESD-protected workstation or mat. If an ESD workstation or mat is not available, touch the sheet-metal chassis to provide a static ground before touching an ESD-sensitive assembly. Protect the ESD-sensitive assemblies by placing them in ESD pouches when they are out of the printer.

📄 **IMPORTANT:** Make sure that all of the shipping materials (for example shipping tape) are removed from the replacement part prior to installation.

📄 **NOTE:** If the replacement part is a roller or pad, avoid touching the spongy part of it. Skin oils on the roller or pad can cause paper pickup and/or print-quality problems. HP recommends using disposable gloves when handling rollers or pads or washing your hands before touching rollers or pads.

---

3. To install an assembly, reverse the removal steps.





---

**NOTE:** When applicable, special installation instructions are provided for an assembly at the end of the removal procedure. Always completely read the removal instructions and follow all special installation instructions.

---

## Entrance unit

## Removal and replacement: Entrance motor (M12)

Learn how to remove and replace the feed entrance motor.

### Introduction

This document provides the procedures to remove and replace the entrance motor on the finisher.



**IMPORTANT:** When applicable, special installation instructions are provided for an assembly at the end of the removal procedure. Always completely read the removal instructions and follow all special installation instructions.

### Before performing service

- Turn the printer power off. A shutting-down message appears on the control-panel display.
- ⚠ **WARNING!** To avoid damage to the printer, turn the power off and wait until the printer shuts down before removing the power cable.
- Disconnect the printer power cable after the printer has completely shut down (the control-panel display is blank).
- Release the finisher from the printer by pulling out on the release latch inside the finisher door.
- Disconnect the cable from the bridge unit to the finisher.
- Disconnect the cable from the finisher to the printer.

Use the table below to identify the correct part number for your printer. To order the part, go to <https://parts.hp.com>.

**Table 5-96 Part information**

Part number	Part description
JC90-01459A	Entrance motor assembly
JC31-00163B	Entrance motor

### Required tools

- #2 JIS screwdriver with a magnetic tip

### After performing service

- Connect the cable from the finisher to the printer.
- Connect the cable from the bridge unit to the finisher.
- Attach the finisher to the printer, and then push in on the release latch inside the finisher door.
- Connect the printer power cable.
- Turn the printer power on.

### Post service test

Process a job through the finisher and verify that the finisher works correctly.

### Remove the right upper cover (finisher)

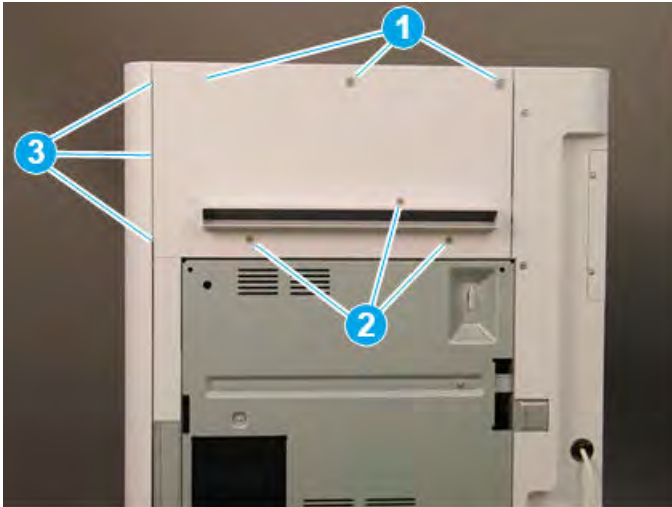
Follow these steps to remove the right upper cover (finisher).

- ▲ Remove one screw cap and three machine screws on the upper edge of the cover (callout 1). Remove three sheet metal screws (callout 2) on the lower portion of the cover. Rotate the right edge of the cover away from the finisher, and then slide the cover right to release three tabs (callout 3).

💡 **TIP:** The lower screws are shorter in length than the upper screws.

**TIP:** Reverse the removal steps to install the assembly.

**Figure 5-254** Remove the right upper cover

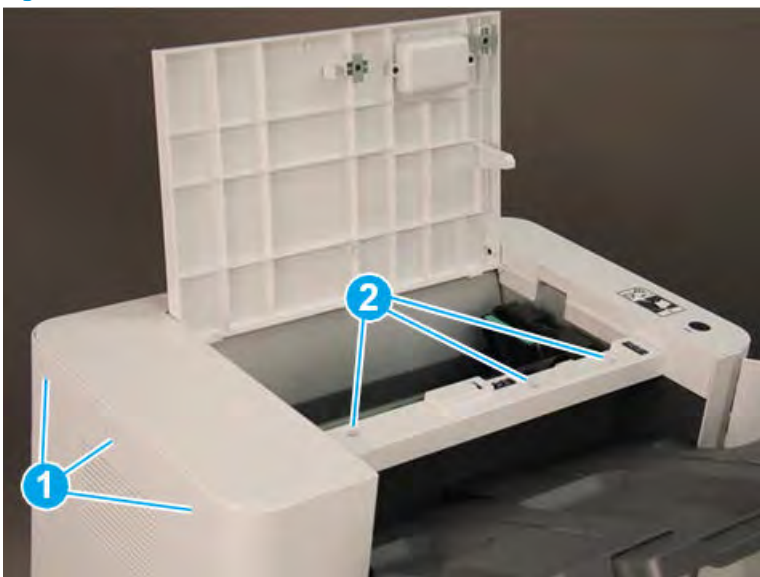


### Remove the top cover (finisher)

Follow these steps to remove the top cover (finisher).

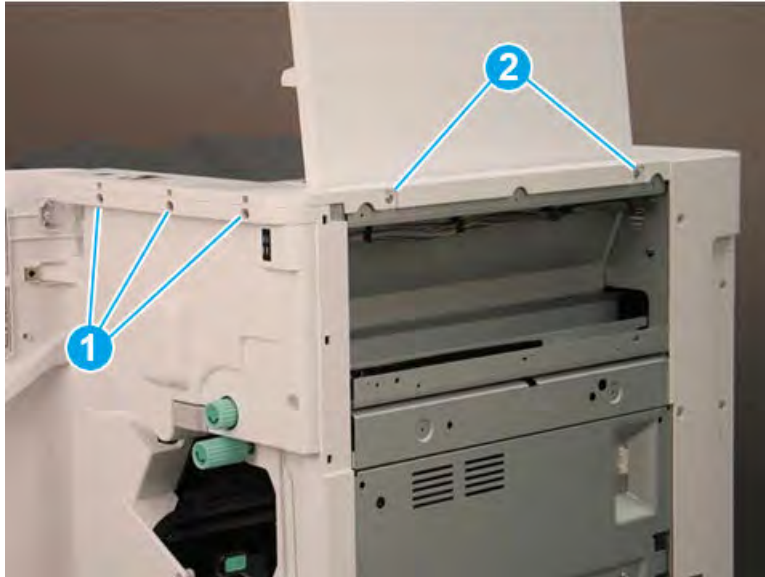
1. Remove three screw caps and three self-tapping screws at the top of the rear cover (callout 1), and then remove three machine screws (callout 2) on top of the cover.

**Figure 5-255** Remove six screws



2. Remove three self-tapping screws at the top of the front cover (callout 1), and then remove two machine screws (callout 2) at the top of the right side.

Figure 5-256 Remove five screws



3. Lift the cover up slightly. Disconnect one in-line connector (callout 1), and then release one retainer (callout 2).


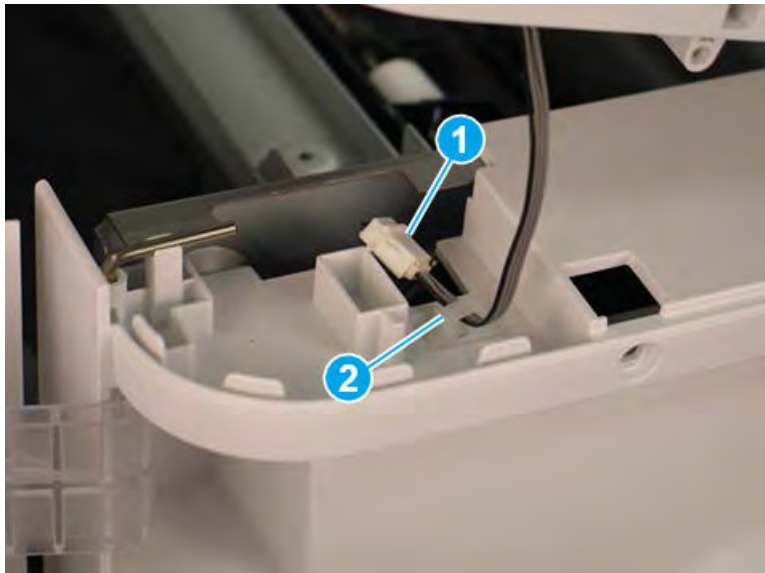
 **TIP:** Reverse the removal steps to install the assembly.

Figure 5-257 Disconnect one connector and release retainer



### Remove the rear cover (finisher)

Follow these steps to remove the rear cover (finisher).

1. Remove two self-tapping screws (callout 1) on the top of the rear cover, and then remove five screw caps and five machine screws (callout 2) on the left side of the cover.

Figure 5-258 Remove seven screws

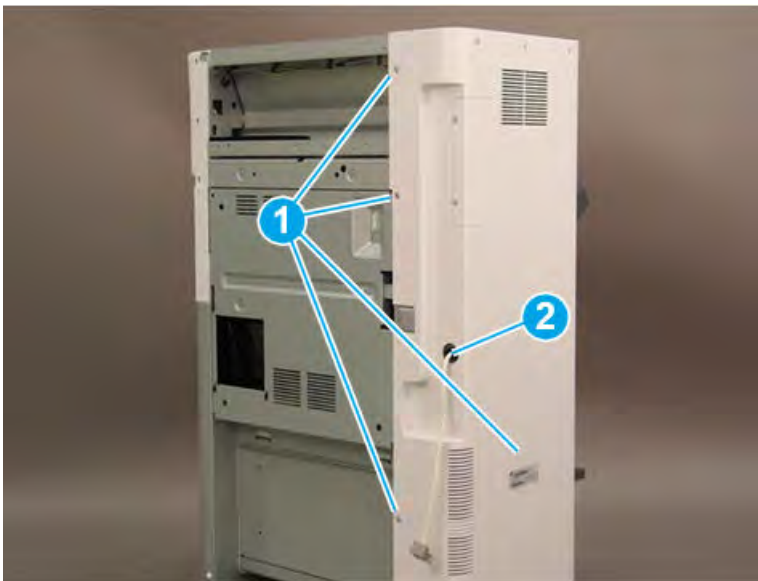


2. Remove one screw cap and four machine screws (callout 1) Remove the rear cover.

 **NOTE:** Make sure to thread the power cable (callout 2) through the opening in the cover.

 **TIP:** Reverse the removal steps to install the assembly


Figure 5-259 Remove the rear cover



### Remove the entrance motor (M12)

Follow these steps to remove the entrance motor (M12).

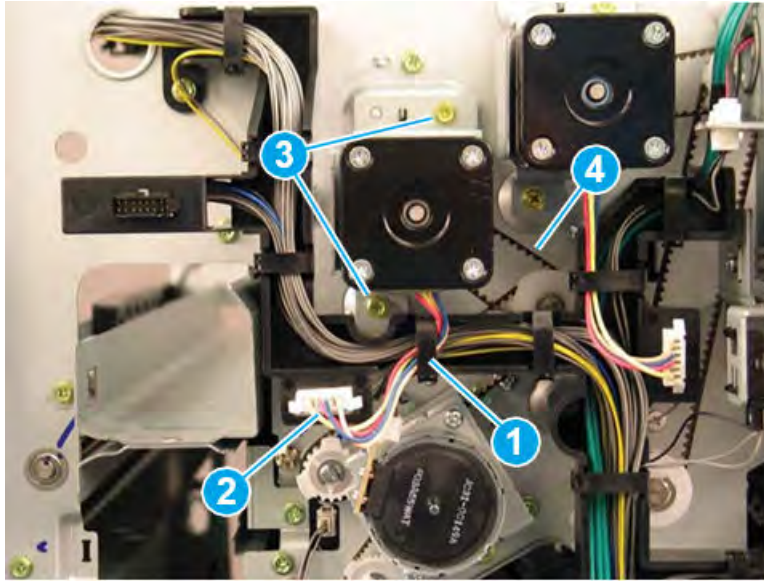
- ▲ Release one retainer (callout 1), and then disconnect one connector (callout 2). Remove two screws (callout 3), and then remove the entrance motor.

 **TIP:** Make sure that the belt (callout 4) is positioned on the gear behind the motor when reinstalling the motor.

**TIP:** Reverse the removal steps to install the assembly.

---

**Figure 5-260** Remove the entrance motor



### Unpack the replacement assembly

Follow these steps to unpack the replacement assembly.



1. Dispose of the defective part.


 **NOTE:** HP recommends responsible disposal of the defective part.


<http://www8.hp.com/us/en/hp-information/environment/product-recycling.html>

---

2. Unpack the replacement part from the packaging.


 **CAUTION:**  Some parts are sensitive to electrostatic discharge (ESD). Always perform service work at an ESD-protected workstation or mat. If an ESD workstation or mat is not available, touch the sheet-metal chassis to provide a static ground before touching an ESD-sensitive assembly. Protect the ESD-sensitive assemblies by placing them in ESD pouches when they are out of the printer.

 **IMPORTANT:** Make sure that all of the shipping materials (for example shipping tape) are removed from the replacement part prior to installation.

 **NOTE:** If the replacement part is a roller or pad, avoid touching the spongy part of it. Skin oils on the roller or pad can cause paper pickup and/or print-quality problems. HP recommends using disposable gloves when handling rollers or pads or washing your hands before touching rollers or pads.

---

3. To install an assembly, reverse the removal steps.

 **NOTE:** When applicable, special installation instructions are provided for an assembly at the end of the removal procedure. Always completely read the removal instructions and follow all special installation instructions.

---

## Punch unit



## Removal and replacement: Dummy feed guide

Learn how to remove and replace the dummy feed guide.

### Introduction

This document provides the procedures to remove and replace the dummy feed guide on the finisher.



**IMPORTANT:** When applicable, special installation instructions are provided for an assembly at the end of the removal procedure. Always completely read the removal instructions and follow all special installation instructions.

### Before performing service

- Turn the printer power off. A shutting-down message appears on the control-panel display.
- ⚠ **WARNING!** To avoid damage to the printer, turn the power off and wait until the printer shuts down before removing the power cable.
- Disconnect the printer power cable after the printer has completely shut down (the control-panel display is blank).
- Release the finisher from the printer by pulling out on the release latch inside the finisher door.
- Disconnect the cable from the bridge unit to the finisher.
- Disconnect the cable from the finisher to the printer.

Use the table below to identify the correct part number for your printer. To order the part, go to <https://parts.hp.com>.

**Table 5-97 Part information**

Part number	Part description
JC93-01161A	Dummy feed guide
Y1G10-67901	HP LaserJet Hole Punch 2/3 Accessory
Y1G11-67901	HP LaserJet Hole Punch 2/4 Accessory
Y1G12-67901	HP LaserJet Hole Punch Swedish Accessory

### Required tools

- #2 JIS screwdriver with a magnetic tip

### After performing service

- Connect the cable from the finisher to the printer.
- Connect the cable from the bridge unit to the finisher.
- Attach the finisher to the printer, and then push in on the release latch inside the finisher door.
- Connect the printer power cable.
- Turn the printer power on.

## Post service test

Process a job through the finisher and verify that the finisher works correctly.

## Remove the right upper cover (finisher)

Follow these steps to remove the right upper cover (finisher).

- ▲ Remove one screw cap and three machine screws on the upper edge of the cover (callout 1). Remove three sheet metal screws (callout 2) on the lower portion of the cover. Rotate the right edge of the cover away from the finisher, and then slide the cover right to release three tabs (callout 3).

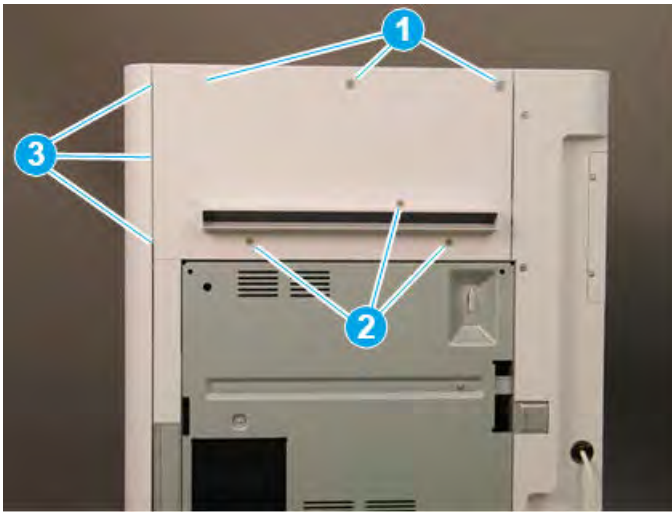
---

💡 **TIP:** The lower screws are shorter in length than the upper screws.

**TIP:** Reverse the removal steps to install the assembly.

---

**Figure 5-261** Remove the right upper cover

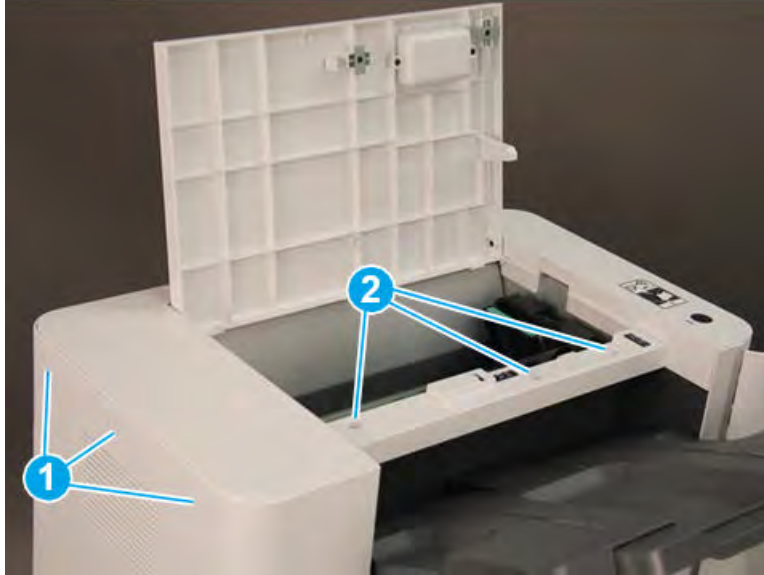


## Remove the top cover (finisher)

Follow these steps to remove the top cover (finisher).

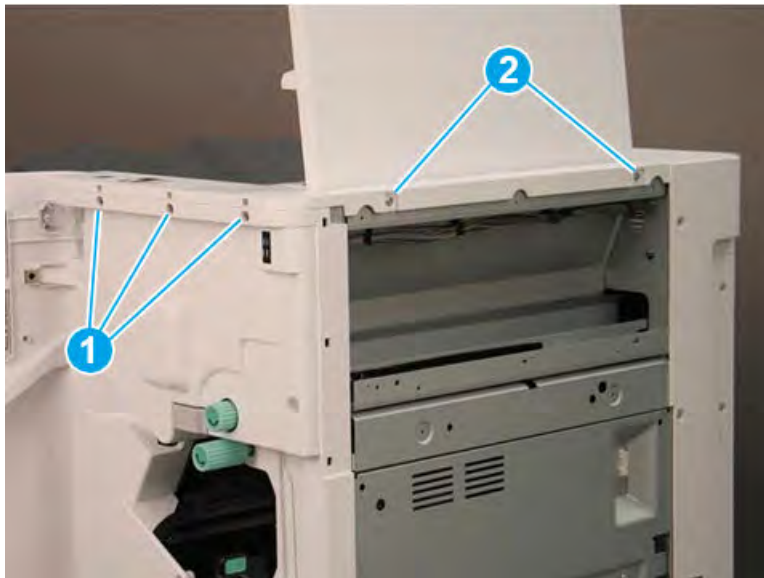
1. Remove three screw caps and three self-tapping screws at the top of the rear cover (callout 1), and then remove three machine screws (callout 2) on top of the cover.

Figure 5-262 Remove six screws




2. Remove three self-tapping screws at the top of the front cover (callout 1), and then remove two machine screws (callout 2) at the top of the right side.

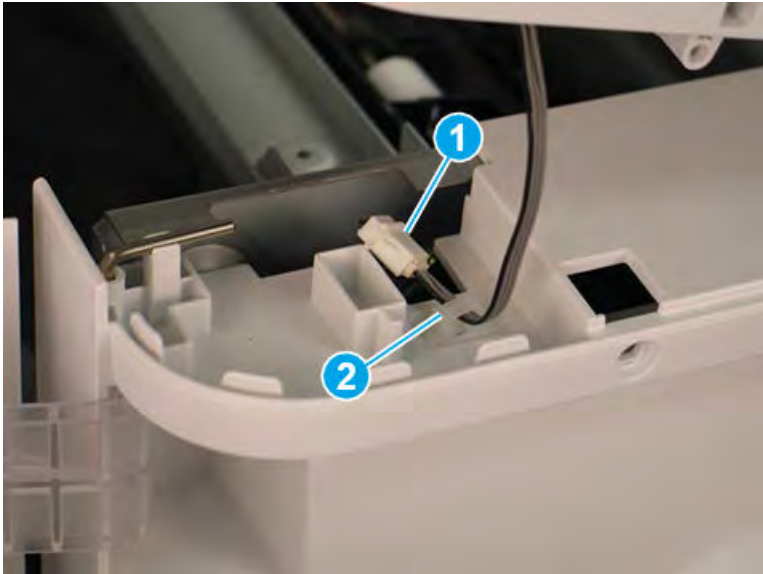
Figure 5-263 Remove five screws



3. Lift the cover up slightly. Disconnect one in-line connector (callout 1), and then release one retainer (callout 2).

 **TIP:** Reverse the removal steps to install the assembly.

**Figure 5-264** Disconnect one connector and release retainer

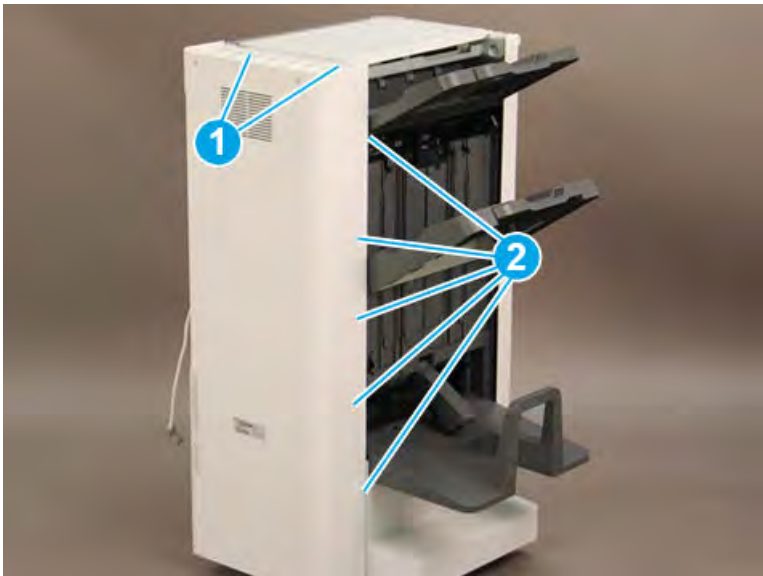


#### Remove the rear cover (finisher)

Follow these steps to remove the rear cover (finisher).


1. Remove two self-tapping screws (callout 1) on the top of the rear cover, and then remove five screw caps and five machine screws (callout 2) on the left side of the cover.

**Figure 5-265** Remove seven screws

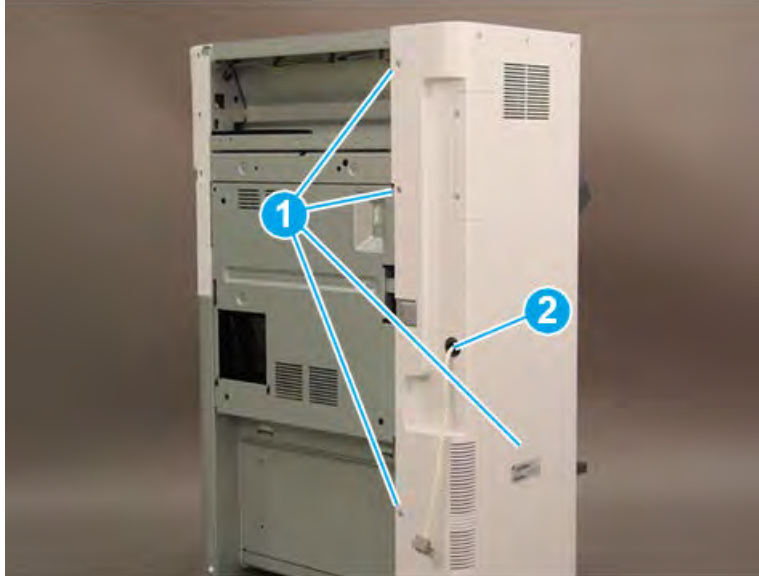


2. Remove one screw cap and four machine screws (callout 1) Remove the rear cover.

 **NOTE:** Make sure to thread the power cable (callout 2) through the opening in the cover.

 **TIP:** Reverse the removal steps to install the assembly


**Figure 5-266** Remove the rear cover



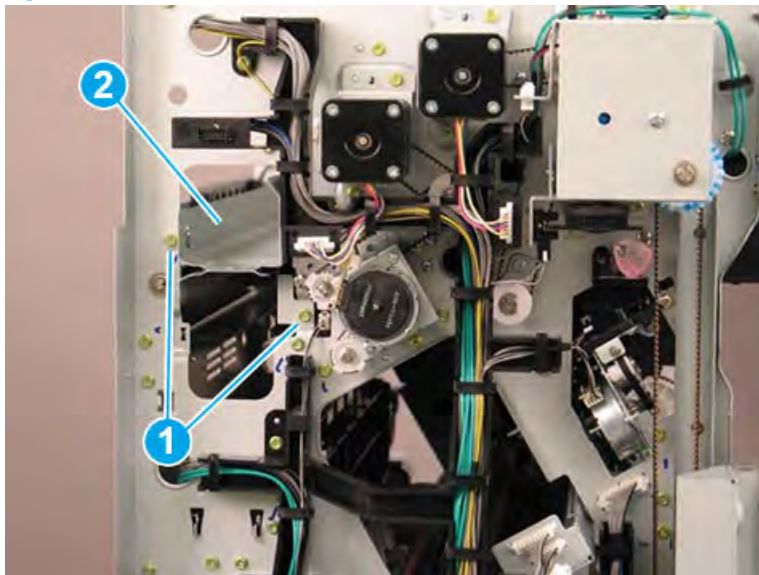
### Remove the dummy feed guide (finisher)

Follow these steps to remove the dummy feed guide (finisher).

- ▲ At the rear of the finisher, remove two screws (callout 1), and then remove the dummy feed guide (callout 2).

 **TIP:** Reverse the removal steps to install the assembly.

**Figure 5-267** Remove two screws and the feed guide



## Unpack the replacement assembly

Follow these steps to unpack the replacement assembly.

1. Dispose of the defective part.

---



 **NOTE:** HP recommends responsible disposal of the defective part.

<http://www8.hp.com/us/en/hp-information/environment/product-recycling.html>


---

2. Unpack the replacement part from the packaging.

---

 **CAUTION:**  Some parts are sensitive to electrostatic discharge (ESD). Always perform service work at an ESD-protected workstation or mat. If an ESD workstation or mat is not available, touch the sheet-metal chassis to provide a static ground before touching an ESD-sensitive assembly. Protect the ESD-sensitive assemblies by placing them in ESD pouches when they are out of the printer.


 **IMPORTANT:** Make sure that all of the shipping materials (for example shipping tape) are removed from the replacement part prior to installation.

 **NOTE:** If the replacement part is a roller or pad, avoid touching the spongy part of it. Skin oils on the roller or pad can cause paper pickup and/or print-quality problems. HP recommends using disposable gloves when handling rollers or pads or washing your hands before touching rollers or pads.

---

3. To install an assembly, reverse the removal steps.

---

 **NOTE:** When applicable, special installation instructions are provided for an assembly at the end of the removal procedure. Always completely read the removal instructions and follow all special installation instructions.

---


## Tray diverter unit

# HP LaserJet Managed MFP E82540-E82560, E87640-E87660, E82540du-E82560du, E87640du-E87660du, E72525-E72535, E77822-E77830 – Removal and replacement: Top jam access cover

Learn how to remove and replace the top jam cover assembly.

## Introduction

This document provides the procedures to remove and replace the top jam cover assembly for the finisher.

 **IMPORTANT:** When applicable, special installation instructions are provided for an assembly at the end of the removal procedure. Always completely read the removal instructions and follow all special installation instructions.

## Before performing service

- Turn the printer power off. A shutting-down message appears on the control-panel display.
- ⚠ **WARNING!** To avoid damage to the printer, turn the power off and wait until the printer shuts down before removing the power cable.
- Disconnect the printer power cable after the printer has completely shut down (the control-panel display is blank).
- Release the finisher from the printer by pulling out on the release latch inside the finisher door.
- Disconnect the cable from the bridge unit to the finisher.
- Disconnect the cable from the finisher to the printer.

Use the table below to identify the correct part number for your printer. To order the part, go to <https://parts.hp.com>.

**Table 5-98 Part information**

Part number	Part description
JC90-01455A	Top jam cover assembly

## Required tools

- #2 JIS screwdriver with a magnetic tip

## After performing service

- Connect the cable from the finisher to the printer.
- Connect the cable from the bridge unit to the finisher.
- Attach the finisher to the printer, and then push in on the release latch inside the finisher door.
- Connect the printer power cable.
- Turn the printer power on.

## Post service test

Process a job through the finisher and verify that the finisher works correctly.



### Remove the right upper cover (finisher)

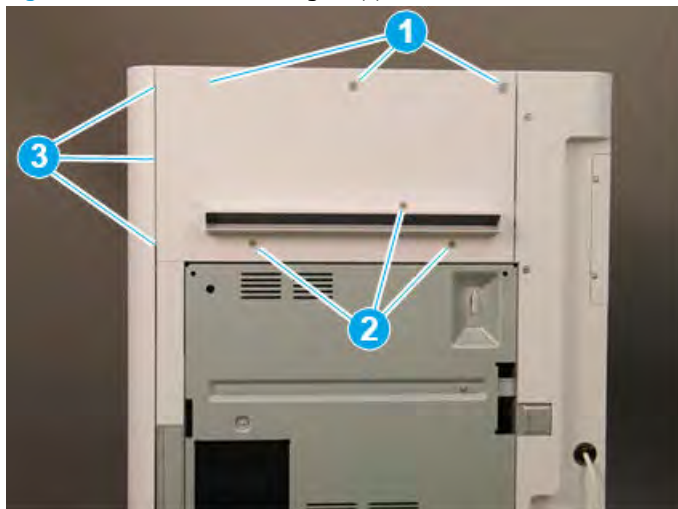
Follow these steps to remove the right upper cover (finisher).

- ▲ Remove one screw cap and three machine screws on the upper edge of the cover (callout 1). Remove three sheet metal screws (callout 2) on the lower portion of the cover. Rotate the right edge of the cover away from the finisher, and then slide the cover right to release three tabs (callout 3).

💡 **TIP:** The lower screws are shorter in length than the upper screws.

**TIP:** Reverse the removal steps to install the assembly.

Figure 5-268 Remove the right upper cover

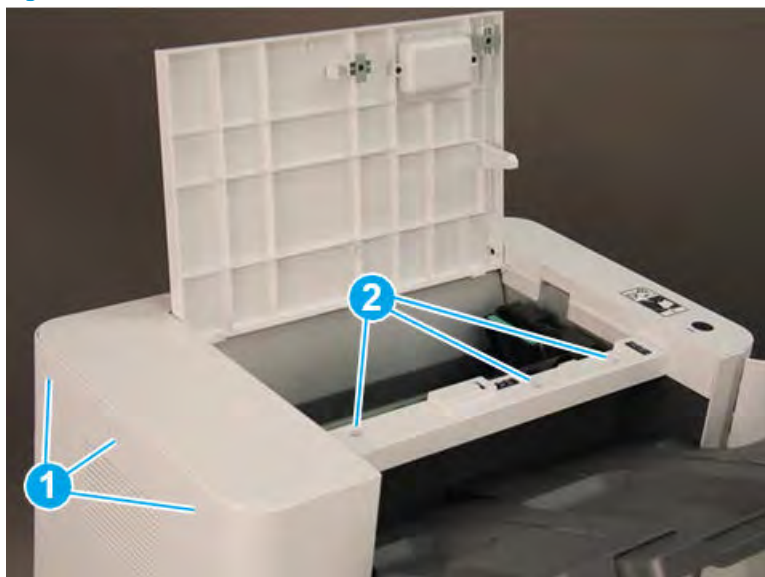


### Remove the top cover (finisher)

Follow these steps to remove the top cover (finisher).

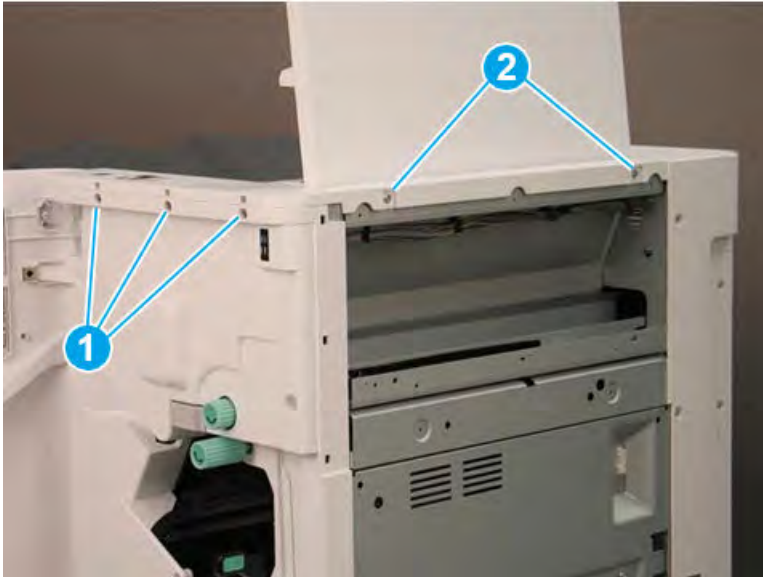
1. Remove three screw caps and three self-tapping screws at the top of the rear cover (callout 1), and then remove three machine screws (callout 2) on top of the cover.

Figure 5-269 Remove six screws




2. Remove three self-tapping screws at the top of the front cover (callout 1), and then remove two machine screws (callout 2) at the top of the right side.

Figure 5-270 Remove five screws



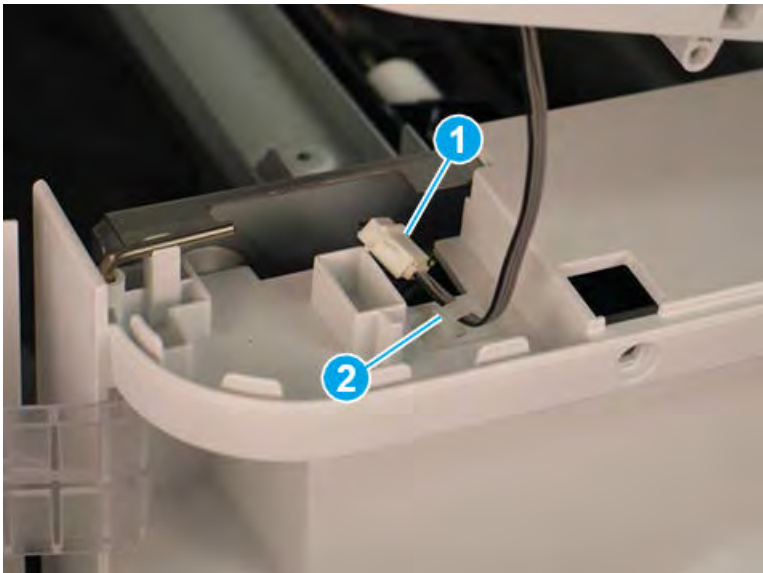
3. Lift the cover up slightly. Disconnect one in-line connector (callout 1), and then release one retainer (callout 2).

---

 **TIP:** Reverse the removal steps to install the assembly.

---

Figure 5-271 Disconnect one connector and release retainer

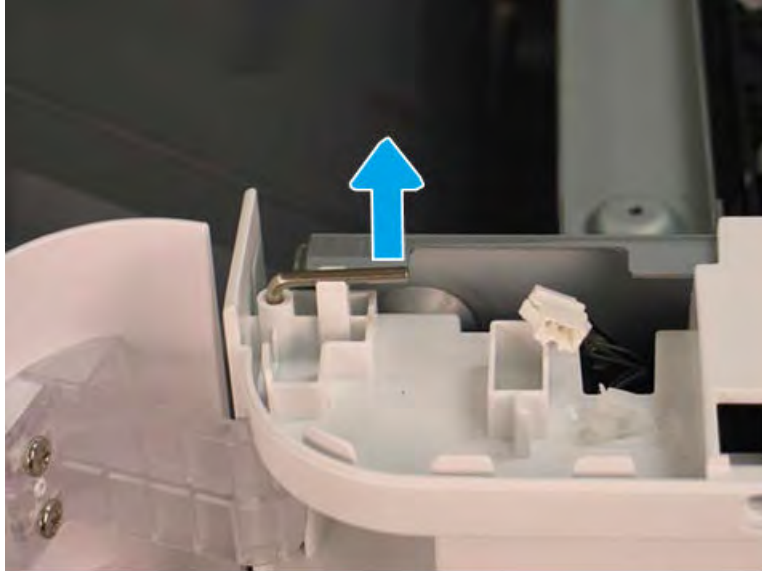


### Remove the front door (finisher)

Follow these steps to remove the front door (finisher).

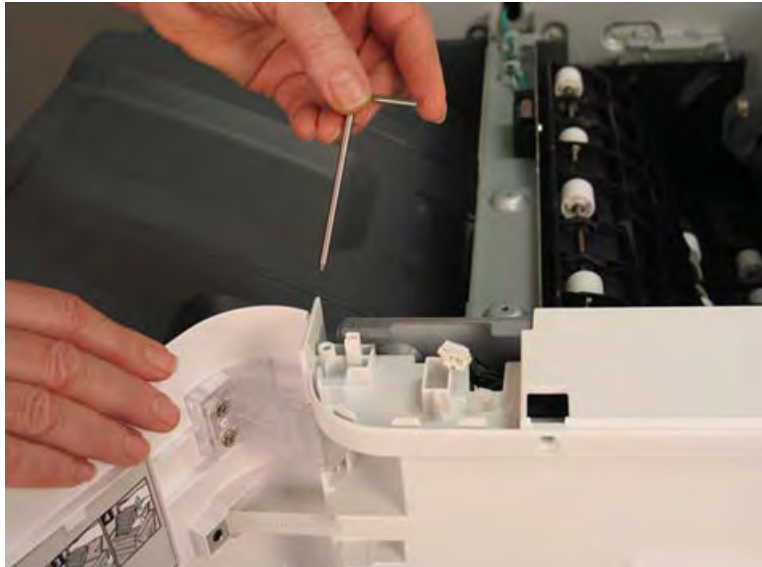
1. Lift the top hinge pin up to release it from the retainer.

Figure 5-272 Lift the top hinge pin



2. Pull the top hinge pin up to remove it.

Figure 5-273 Remove the top hinge pin



3. Use a small, flat-blade screwdriver to release the lower hinge pin from the retainer, and then rotate it away from the finisher.

**Figure 5-274** Release the lower hinge pin




4. Support the door with one hand, and then pull the lower hinge pin straight up to remove it.

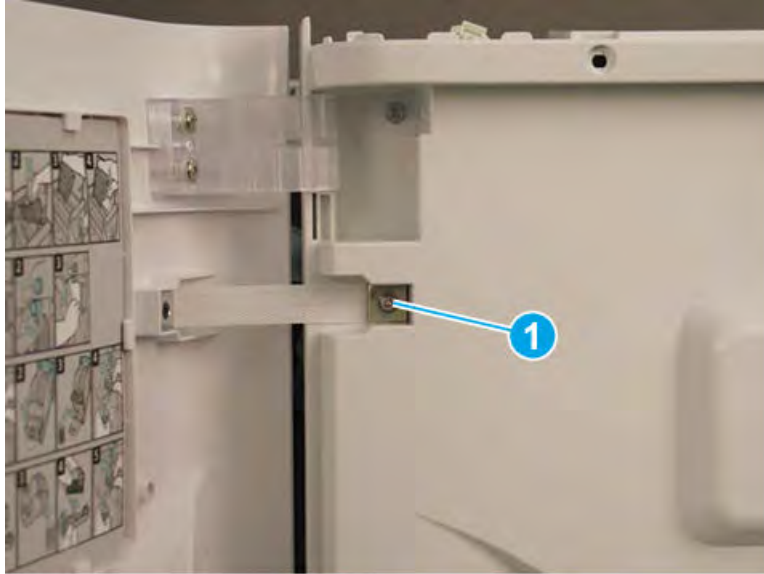
**Figure 5-275** Remove the lower hinge pin



5. Support the door with one hand, and then remove one screw (callout 1) to release the strap. Remove the front door.

 **TIP:** Reverse the removal steps to install the assembly.

**Figure 5-276** Remove the front door

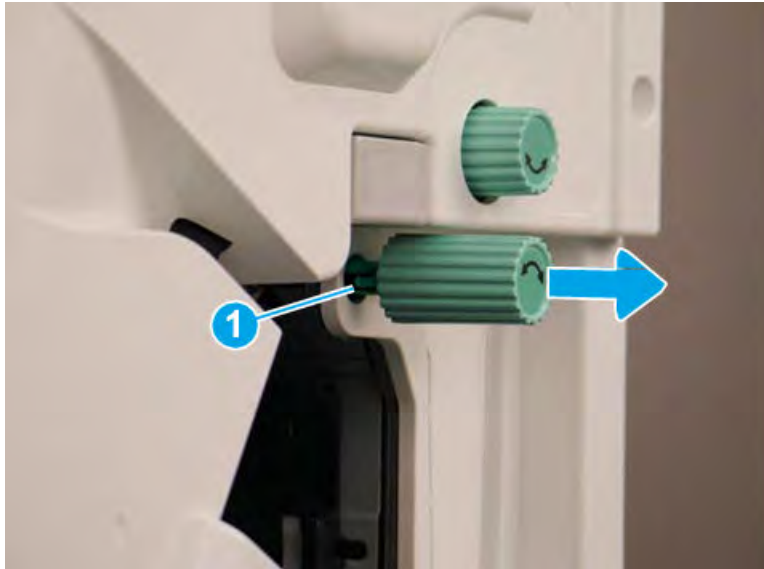


#### Remove the front cover (finisher)

Follow these steps to remove the front cover (finisher).

1. Release one tab (callout 1), and then pull the jam-access knob away from the finisher to remove it.

**Figure 5-277** Remove the jam-access knob



2. If the punch unit is installed, remove the punch waste bin (callout 1).


3. Remove one screw (callout 1) on top of the front cover.

Figure 5-278 Remove one screw



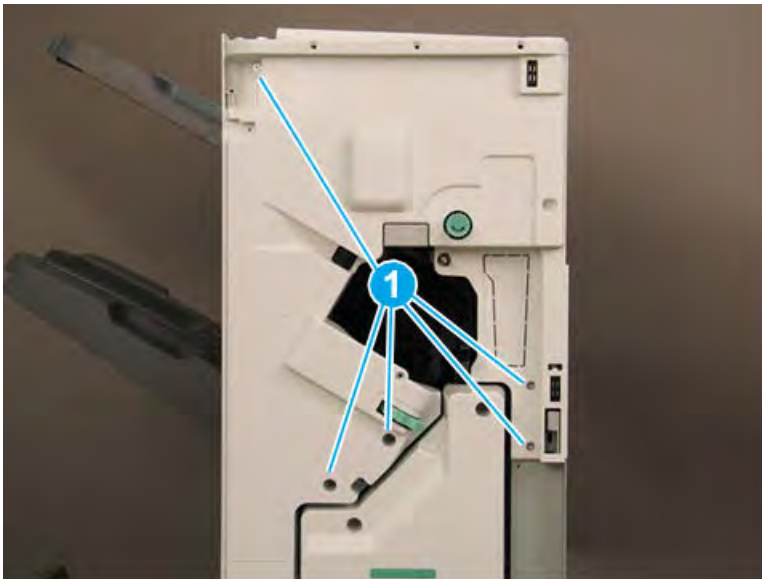
4. Remove five machine screws (callout 1), and then remove the front cover.

---

 **TIP:** Reverse the removal steps to install the assembly.

---

Figure 5-279 Remove the front cover



### Remove the rear cover (finisher)

Follow these steps to remove the rear cover (finisher).

1. Remove two self-tapping screws (callout 1) on the top of the rear cover, and then remove five screw caps and five machine screws (callout 2) on the left side of the cover.

Figure 5-280 Remove seven screws



2. Remove one screw cap and four machine screws (callout 1) Remove the rear cover.

 **NOTE:** Make sure to thread the power cable (callout 2) through the opening in the cover.


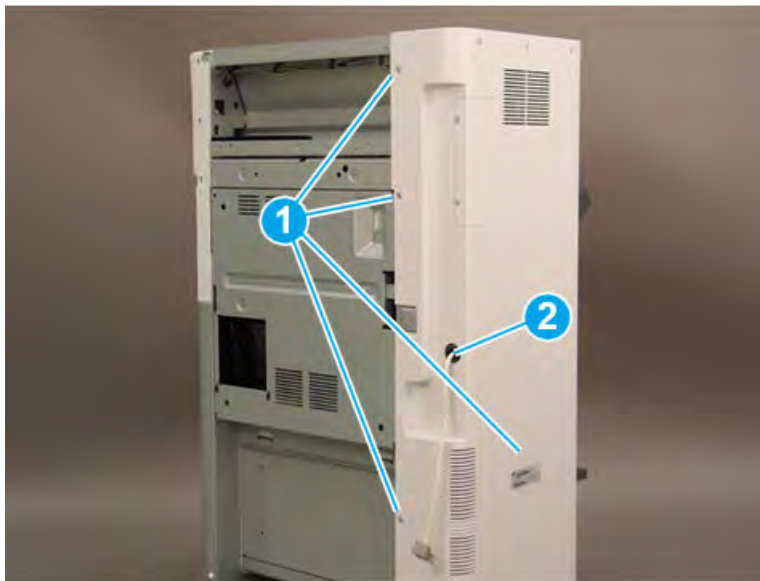
 **TIP:** Reverse the removal steps to install the assembly


Figure 5-281 Remove the rear cover



### Remove the exit motor (M13)

Follow these steps to remove the exit motor (M13).

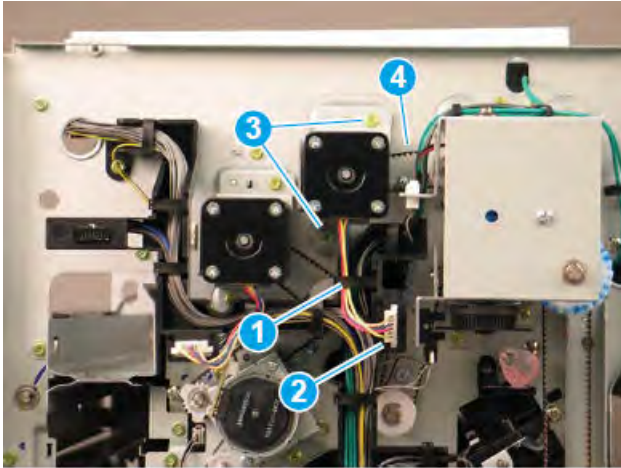
- ▲ Release one retainer (callout 1), and then disconnect one connector (callout 2). Remove two screws (callout 3), and then remove the exit motor.

 **TIP:** Make sure that the belt (callout 4) is positioned on the gear behind the motor when reinstalling the motor.

**TIP:** Reverse the removal steps to install the assembly.

---

**Figure 5-282** Remove the exit motor

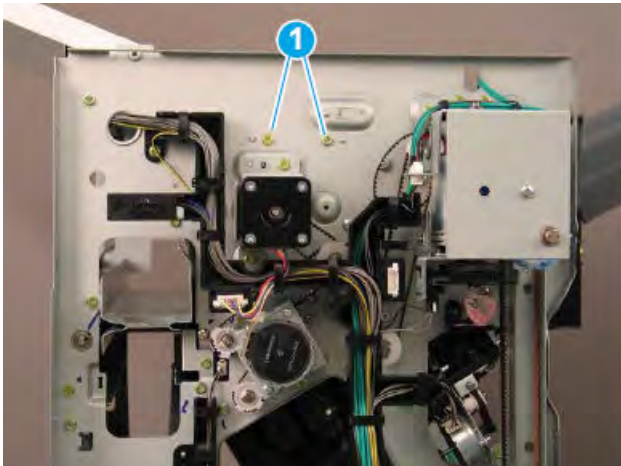


### Remove the top jam access cover

Follow these steps to remove the top jam access cover.

1. At the rear of the finisher, remove two screws (callout 1).


**Figure 5-283** Remove two screws





2. Remove the top jam access cover.

---

 **TIP:** Reverse the removal steps to install the assembly.

---

**Figure 5-284** Remove the top jam access cover



### Unpack the replacement assembly

Follow these steps to unpack the replacement assembly.

1. Dispose of the defective part.

---



 **NOTE:** HP recommends responsible disposal of the defective part.


<http://www8.hp.com/us/en/hp-information/environment/product-recycling.html>


---

2. Unpack the replacement part from the packaging.

---

 **CAUTION:**  Some parts are sensitive to electrostatic discharge (ESD). Always perform service work at an ESD-protected workstation or mat. If an ESD workstation or mat is not available, touch the sheet-metal chassis to provide a static ground before touching an ESD-sensitive assembly. Protect the ESD-sensitive assemblies by placing them in ESD pouches when they are out of the printer.


 **IMPORTANT:** Make sure that all of the shipping materials (for example shipping tape) are removed from the replacement part prior to installation.

 **NOTE:** If the replacement part is a roller or pad, avoid touching the spongy part of it. Skin oils on the roller or pad can cause paper pickup and/or print-quality problems. HP recommends using disposable gloves when handling rollers or pads or washing your hands before touching rollers or pads.

---

3. To install an assembly, reverse the removal steps.

---

 **NOTE:** When applicable, special installation instructions are provided for an assembly at the end of the removal procedure. Always completely read the removal instructions and follow all special installation instructions.


---

## Removal and replacement: Tray diverter

Learn how to remove and replace the tray diverter.

### Introduction

This document provides the procedures to remove and replace the tray diverter on the finisher.

 **IMPORTANT:** When applicable, special installation instructions are provided for an assembly at the end of the removal procedure. Always completely read the removal instructions and follow all special installation instructions.

### Before performing service

- Turn the printer power off. A shutting-down message appears on the control-panel display.
- ⚠ **WARNING!** To avoid damage to the printer, turn the power off and wait until the printer shuts down before removing the power cable.
- Disconnect the printer power cable after the printer has completely shut down (the control-panel display is blank).
- Release the finisher from the printer by pulling out on the release latch inside the finisher door.
- Disconnect the cable from the bridge unit to the finisher.
- Disconnect the cable from the finisher to the printer.

Use the table below to identify the correct part number for your printer. To order the part, go to <https://parts.hp.com>.

**Table 5-99 Part information**

Part number	Part description
JC61-07205A	Tray diverter

### Required tools

- #2 JIS screwdriver with a magnetic tip

### After performing service

- Connect the cable from the finisher to the printer.
- Connect the cable from the bridge unit to the finisher.
- Attach the finisher to the printer, and then push in on the release latch inside the finisher door.
- Connect the printer power cable.
- Turn the printer power on.

### Post service test

Process a job through the finisher and verify that the finisher works correctly.

### Remove the right upper cover (finisher)

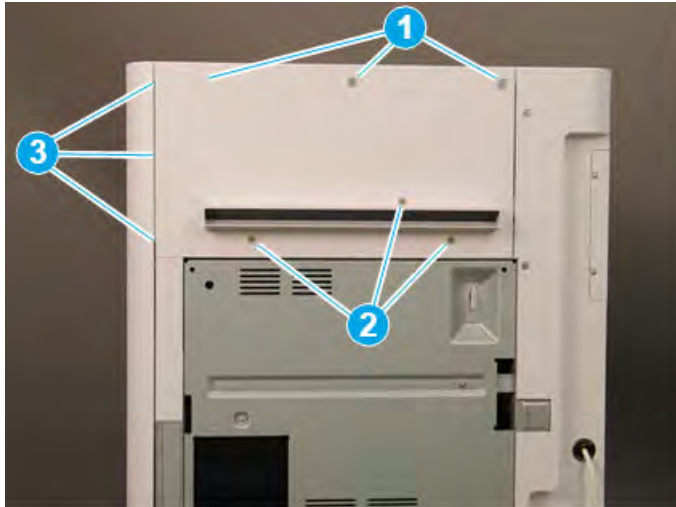
Follow these steps to remove the right upper cover (finisher).

- ▲ Remove one screw cap and three machine screws on the upper edge of the cover (callout 1). Remove three sheet metal screws (callout 2) on the lower portion of the cover. Rotate the right edge of the cover away from the finisher, and then slide the cover right to release three tabs (callout 3).

💡 **TIP:** The lower screws are shorter in length than the upper screws.

**TIP:** Reverse the removal steps to install the assembly.

Figure 5-285 Remove the right upper cover

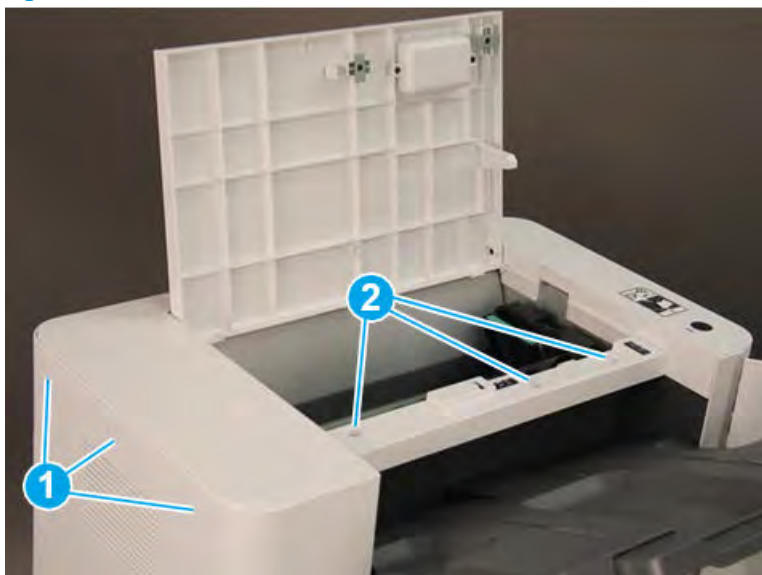


### Remove the top cover (finisher)

Follow these steps to remove the top cover (finisher).

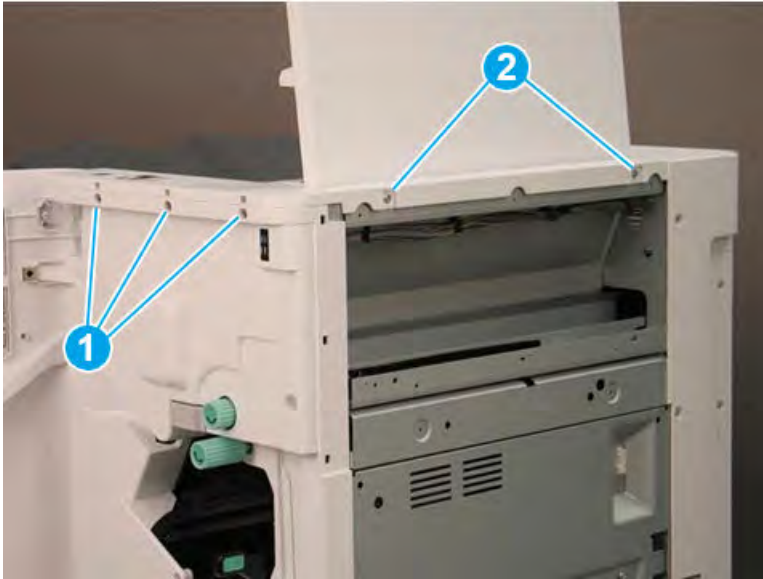
1. Remove three screw caps and three self-tapping screws at the top of the rear cover (callout 1), and then remove three machine screws (callout 2) on top of the cover.

Figure 5-286 Remove six screws




2. Remove three self-tapping screws at the top of the front cover (callout 1), and then remove two machine screws (callout 2) at the top of the right side.

Figure 5-287 Remove five screws



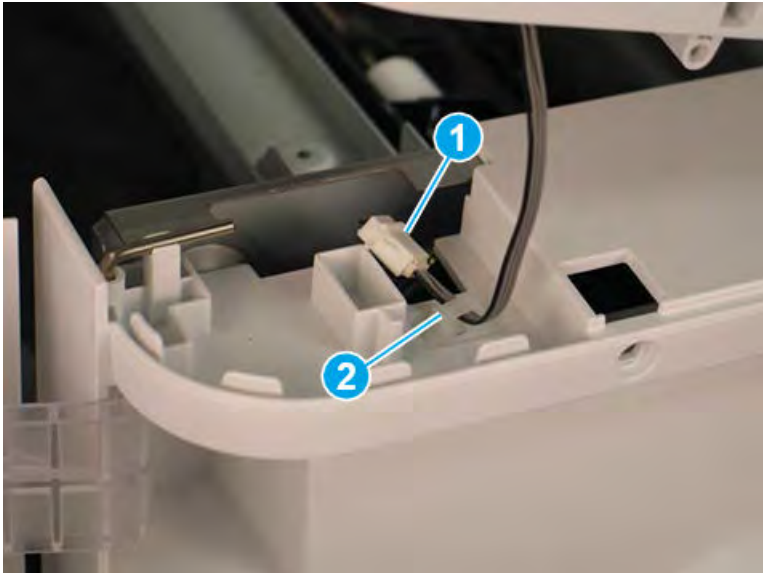
3. Lift the cover up slightly. Disconnect one in-line connector (callout 1), and then release one retainer (callout 2).

---

 **TIP:** Reverse the removal steps to install the assembly.

---

Figure 5-288 Disconnect one connector and release retainer

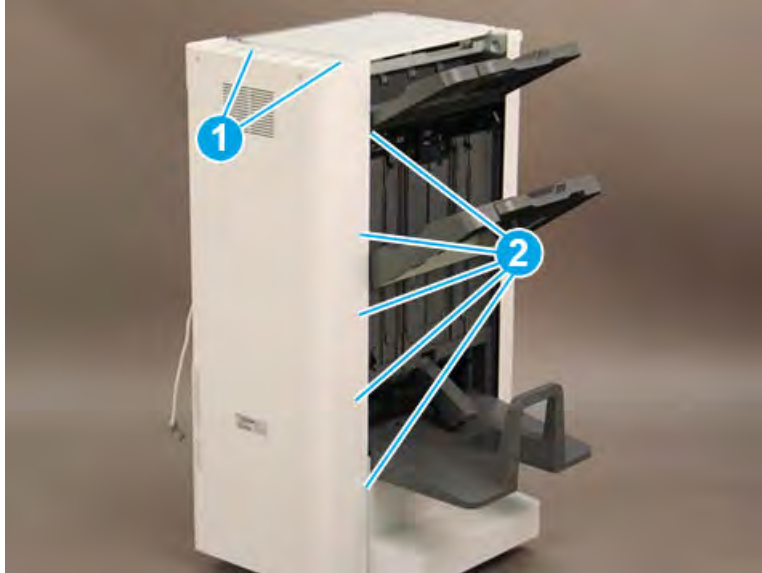


### Remove the rear cover (finisher)

Follow these steps to remove the rear cover (finisher).

1. Remove two self-tapping screws (callout 1) on the top of the rear cover, and then remove five screw caps and five machine screws (callout 2) on the left side of the cover.

Figure 5-289 Remove seven screws



2. Remove one screw cap and four machine screws (callout 1) Remove the rear cover.

---

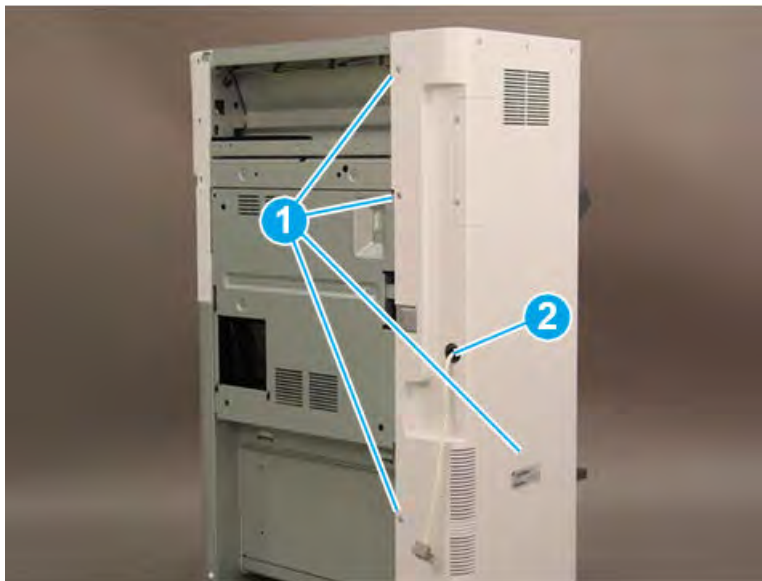
 **NOTE:** Make sure to thread the power cable (callout 2) through the opening in the cover.

---

 **TIP:** Reverse the removal steps to install the assembly

---

Figure 5-290 Remove the rear cover

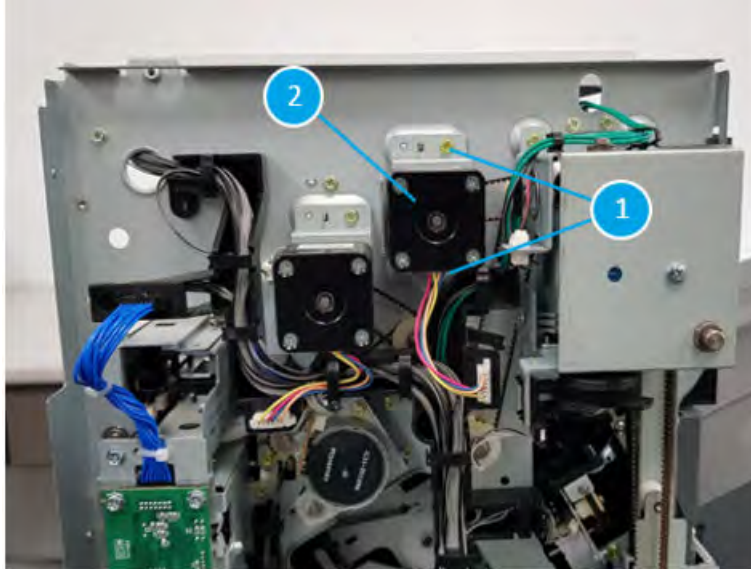


### Remove the tray diverter

Follow these steps to remove the tray diverter.

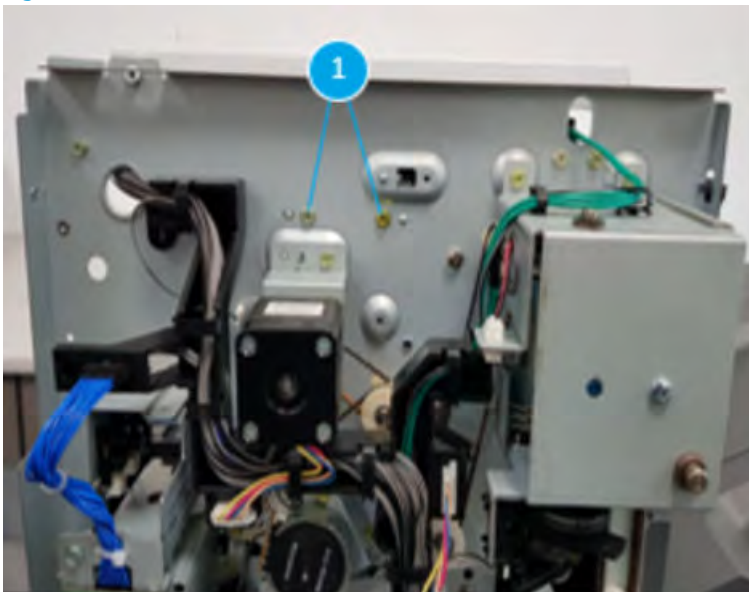
1. Remove two screws(callout 1) to take out the exit motor (callout 2)

Figure 5-291 Take out the exit motor



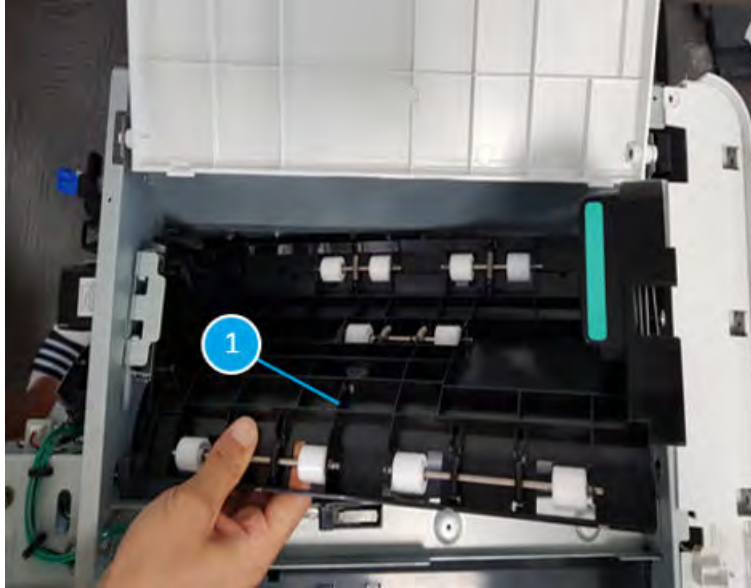
2. Remove two screws (callout 1)

Figure 5-292 Remove two screws



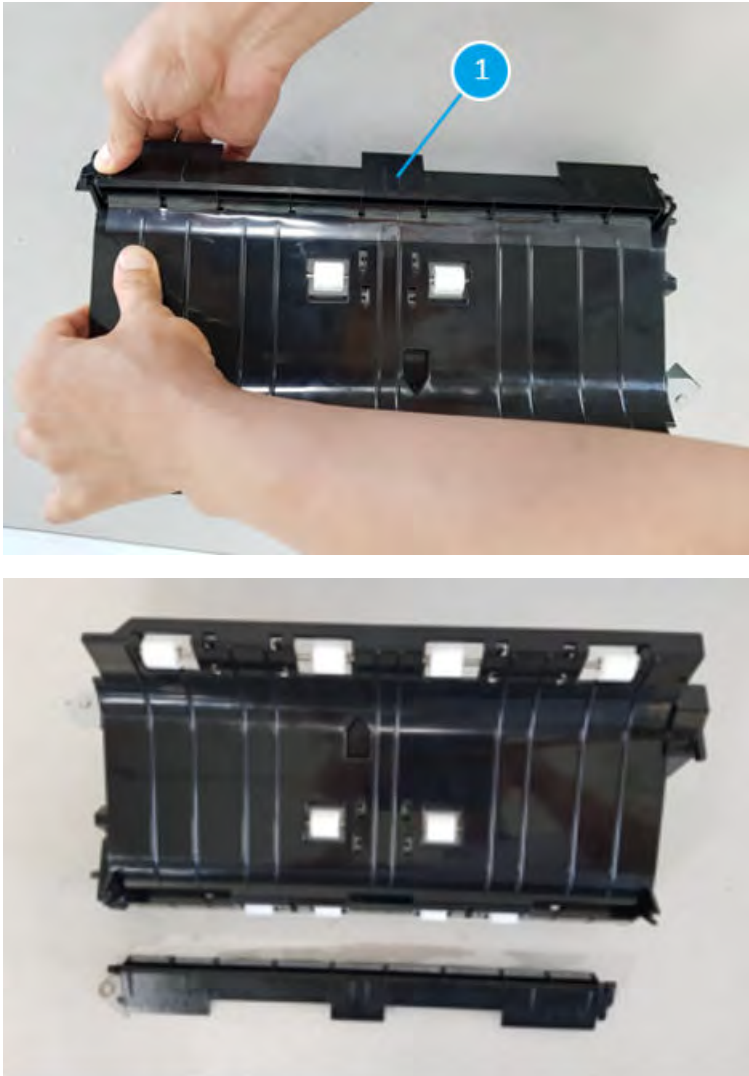
3. Pull the top jam cover assembly out.

Figure 5-293 Pull the top jam cover assembly out



4. Remove the tray diverter (callout 1) from top jam cover assembly.

Figure 5-294 Remove the tray diverter



#### Unpack the replacement assembly

Follow these steps to unpack the replacement assembly.

1. Dispose of the defective part.





---

 **NOTE:** HP recommends responsible disposal of the defective part.


<http://www8.hp.com/us/en/hp-information/environment/product-recycling.html>

---

2. Unpack the replacement part from the packaging.


 **CAUTION:**  Some parts are sensitive to electrostatic discharge (ESD). Always perform service work at an ESD-protected workstation or mat. If an ESD workstation or mat is not available, touch the sheet-metal chassis to provide a static ground before touching an ESD-sensitive assembly. Protect the ESD-sensitive assemblies by placing them in ESD pouches when they are out of the printer.

 **IMPORTANT:** Make sure that all of the shipping materials (for example shipping tape) are removed from the replacement part prior to installation.

 **NOTE:** If the replacement part is a roller or pad, avoid touching the spongy part of it. Skin oils on the roller or pad can cause paper pickup and/or print-quality problems. HP recommends using disposable gloves when handling rollers or pads or washing your hands before touching rollers or pads.

---

3. To install an assembly, reverse the removal steps.

 **NOTE:** When applicable, special installation instructions are provided for an assembly at the end of the removal procedure. Always completely read the removal instructions and follow all special installation instructions.


---

## Removal and replacement: Tray diverter home sensor (S4)


Learn how to remove and replace the tray diverter home sensor.

### Introduction

This document provides the procedures to remove and replace the tray diverter home sensor on the finisher.

 **IMPORTANT:** When applicable, special installation instructions are provided for an assembly at the end of the removal procedure. Always completely read the removal instructions and follow all special installation instructions.

### Before performing service

- Turn the printer power off. A shutting-down message appears on the control-panel display.
-  **WARNING!** To avoid damage to the printer, turn the power off and wait until the printer shuts down before removing the power cable.
- Disconnect the printer power cable after the printer has completely shut down (the control-panel display is blank).
- Release the finisher from the printer by pulling out on the release latch inside the finisher door.
- Disconnect the cable from the bridge unit to the finisher.
- Disconnect the cable from the finisher to the printer.

Use the table below to identify the correct part number for your printer. To order the part, go to <https://parts.hp.com>.

**Table 5-100 Part information**

Part number	Part description
0604-001415	Tray diverter home sensor

### Required tools

- #2 JIS screwdriver with a magnetic tip

### After performing service

- Connect the cable from the finisher to the printer.
- Connect the cable from the bridge unit to the finisher.
- Attach the finisher to the printer, and then push in on the release latch inside the finisher door.
- Connect the printer power cable.
- Turn the printer power on.

### Post service test

Process a job through the finisher and verify that the finisher works correctly.

### Remove the right upper cover (finisher)

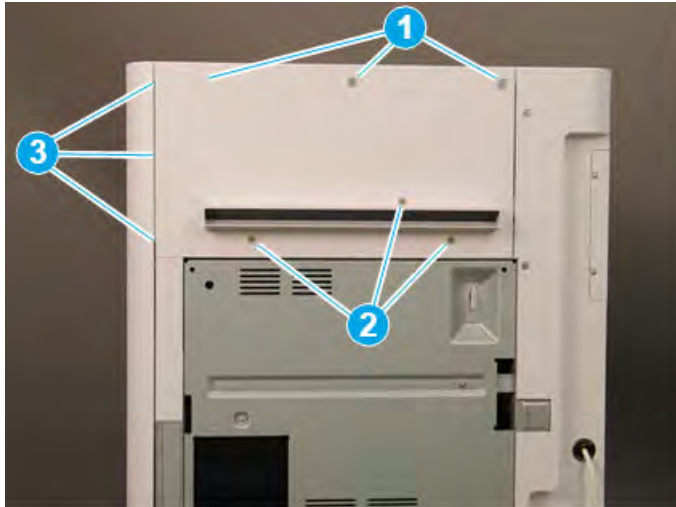
Follow these steps to remove the right upper cover (finisher).

- ▲ Remove one screw cap and three machine screws on the upper edge of the cover (callout 1). Remove three sheet metal screws (callout 2) on the lower portion of the cover. Rotate the right edge of the cover away from the finisher, and then slide the cover right to release three tabs (callout 3).

💡 **TIP:** The lower screws are shorter in length than the upper screws.

**TIP:** Reverse the removal steps to install the assembly.

Figure 5-295 Remove the right upper cover

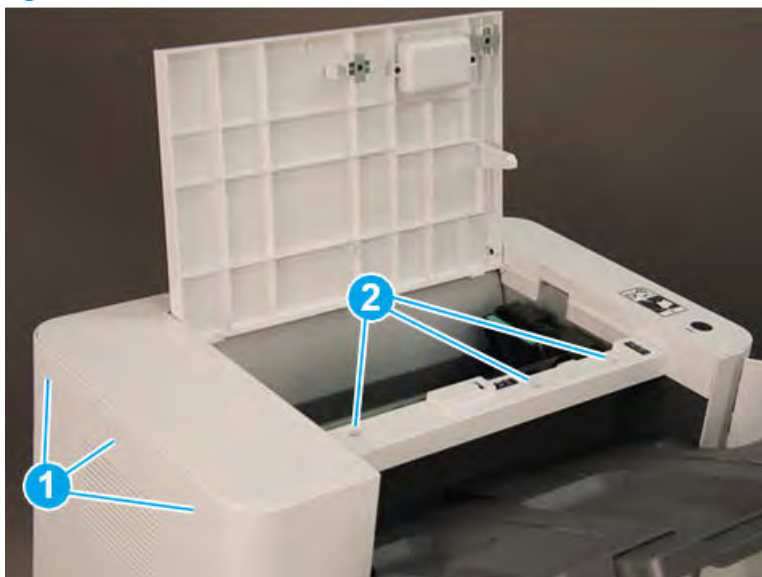


### Remove the top cover (finisher)

Follow these steps to remove the top cover (finisher).

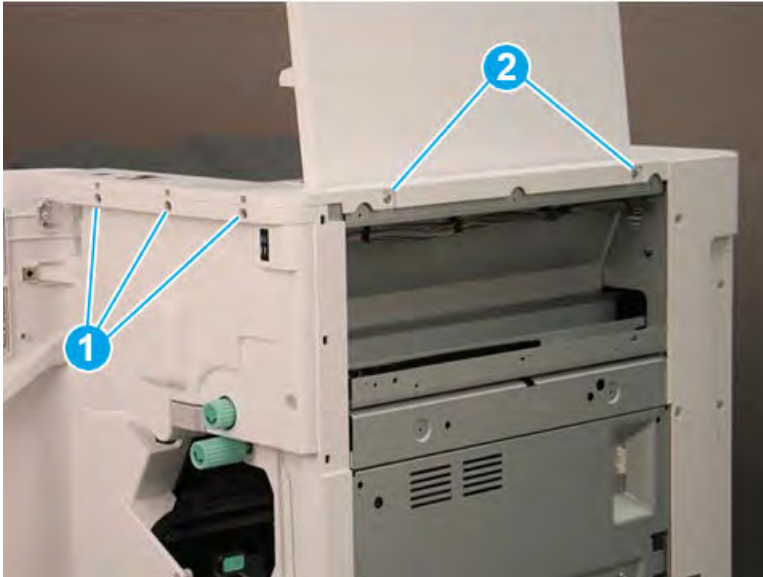
1. Remove three screw caps and three self-tapping screws at the top of the rear cover (callout 1), and then remove three machine screws (callout 2) on top of the cover.

Figure 5-296 Remove six screws




2. Remove three self-tapping screws at the top of the front cover (callout 1), and then remove two machine screws (callout 2) at the top of the right side.

Figure 5-297 Remove five screws



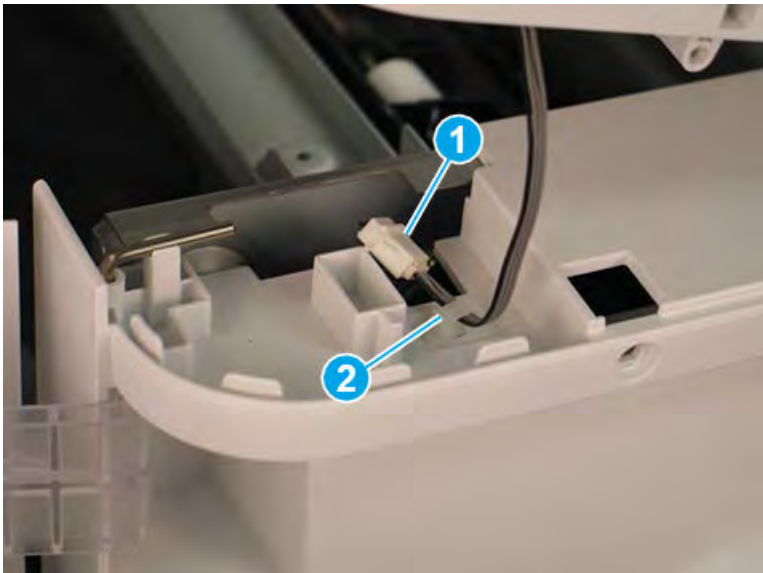
3. Lift the cover up slightly. Disconnect one in-line connector (callout 1), and then release one retainer (callout 2).

---

 **TIP:** Reverse the removal steps to install the assembly.

---

Figure 5-298 Disconnect one connector and release retainer

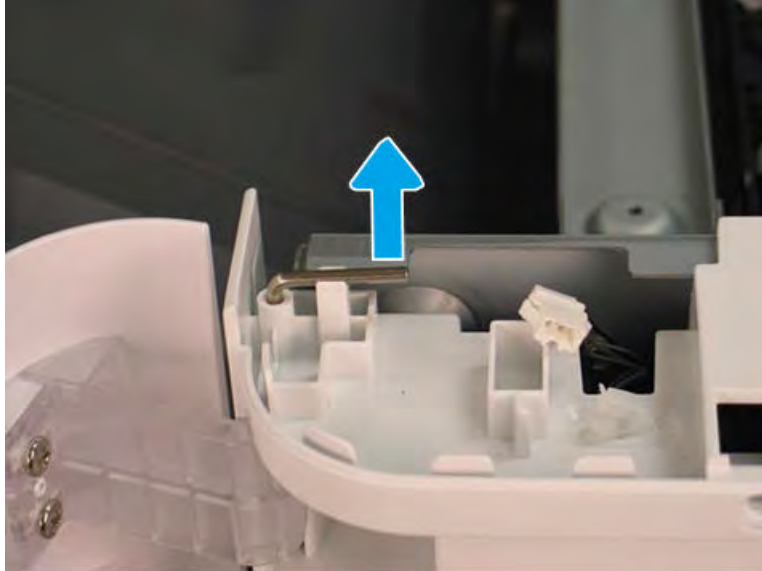


### Remove the front door (finisher)

Follow these steps to remove the front door (finisher).

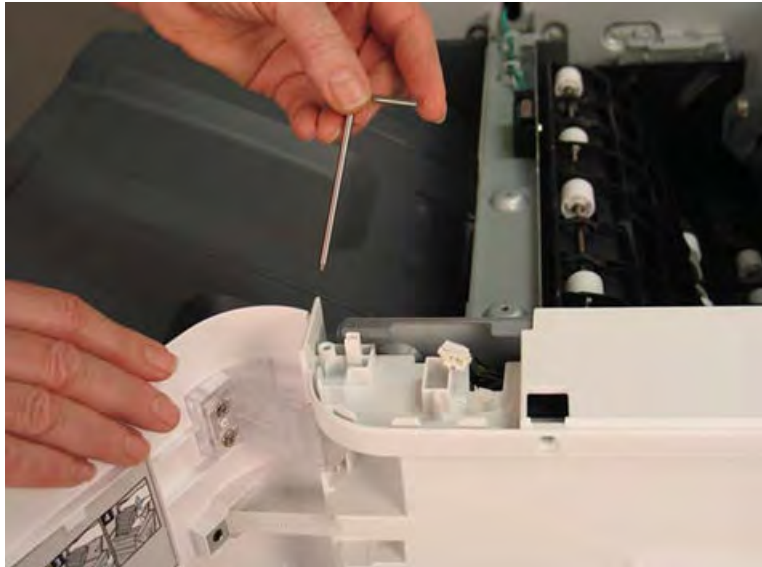
1. Lift the top hinge pin up to release it from the retainer.

Figure 5-299 Lift the top hinge pin



2. Pull the top hinge pin up to remove it.

Figure 5-300 Remove the top hinge pin



3. Use a small, flat-blade screwdriver to release the lower hinge pin from the retainer, and then rotate it away from the finisher.

**Figure 5-301** Release the lower hinge pin




4. Support the door with one hand, and then pull the lower hinge pin straight up to remove it.

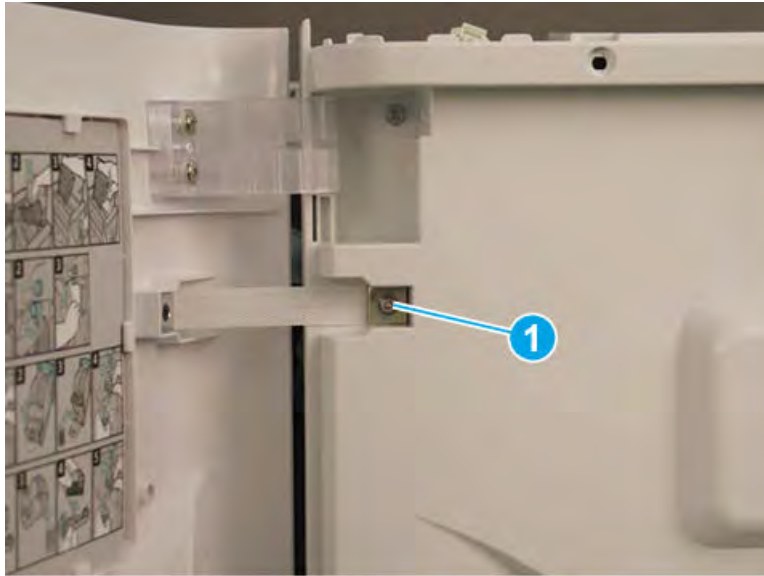
**Figure 5-302** Remove the lower hinge pin



5. Support the door with one hand, and then remove one screw (callout 1) to release the strap. Remove the front door.

 **TIP:** Reverse the removal steps to install the assembly.

**Figure 5-303** Remove the front door

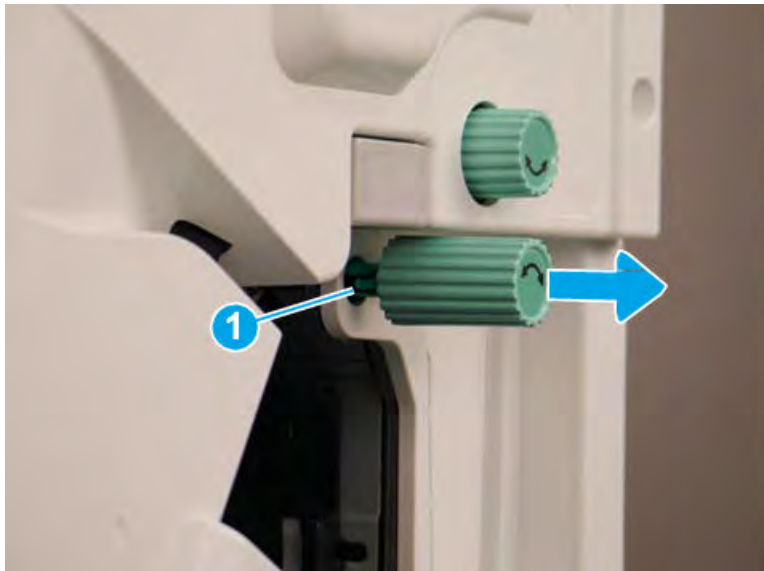


#### Remove the front cover (finisher)

Follow these steps to remove the front cover (finisher).

1. Release one tab (callout 1), and then pull the jam-access knob away from the finisher to remove it.

**Figure 5-304** Remove the jam-access knob



2. If the punch unit is installed, remove the punch waste bin (callout 1).


3. Remove one screw (callout 1) on top of the front cover.

Figure 5-305 Remove one screw



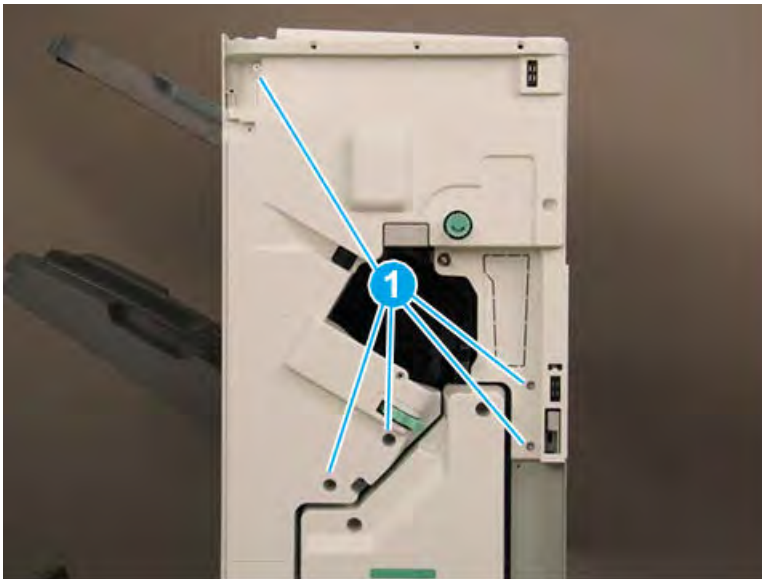
4. Remove five machine screws (callout 1), and then remove the front cover.

---

 **TIP:** Reverse the removal steps to install the assembly.

---

Figure 5-306 Remove the front cover



#### Remove the tray diverter home sensor (S4)

Follow these steps to remove the tray diverter home sensor (S4).

1. Disconnect one connector (callout 1)

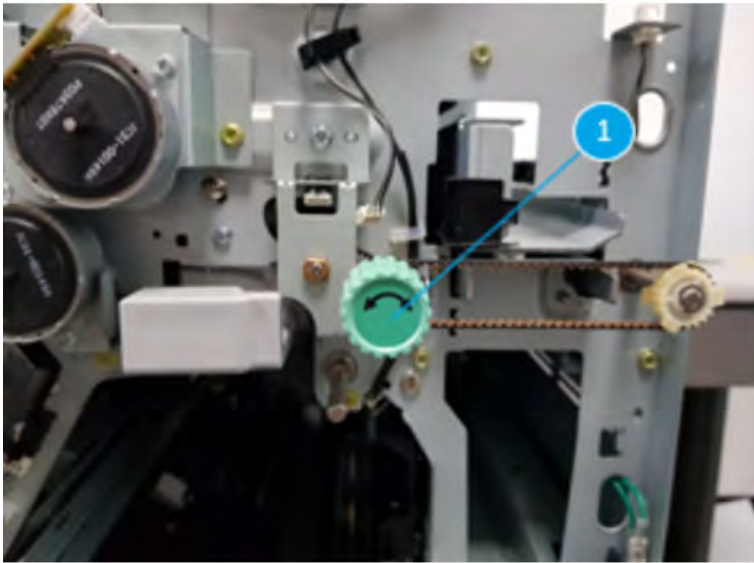


Figure 5-307 Disconnect one connector



2. Remove the green handle (callout 1)

Figure 5-308 Remove the green handle



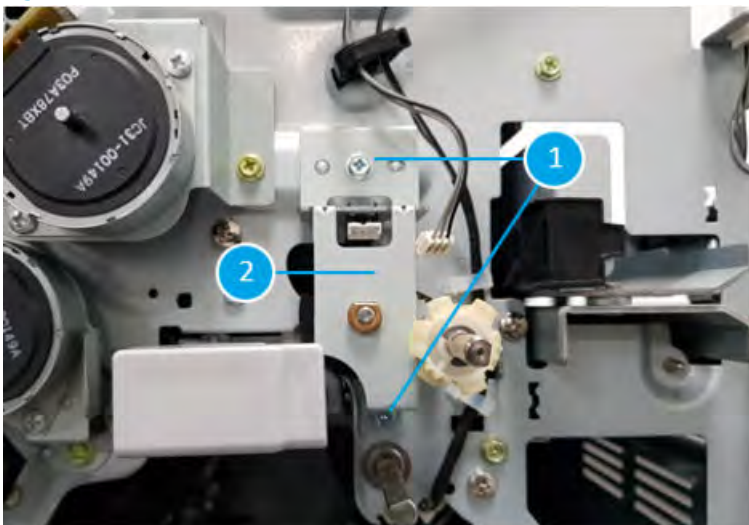
3. Remove the belt (callout 1)

Figure 5-309 Remove the belt



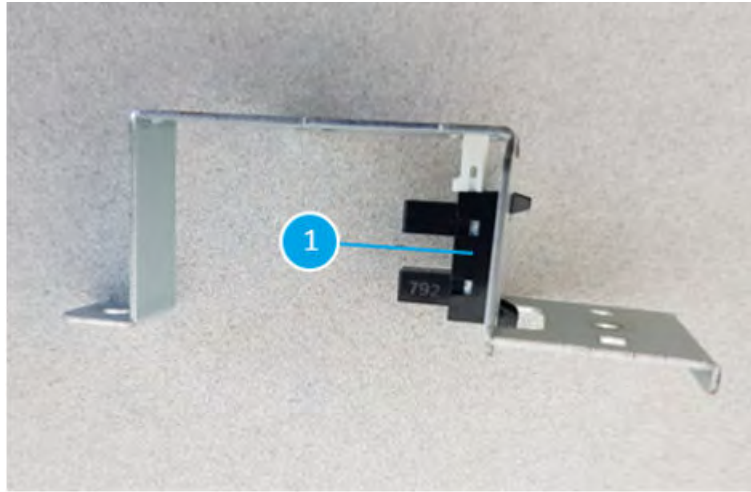
4. Remove two screws (callout 1) and remove the bracket (callout 2) to reach out the tray diverter home sensor

Figure 5-310 Remove two screws and remove the bracket



5. Remove the tray diverter home sensor (S4, callout 1)

Figure 5-311 Remove the tray diverter home sensor



### Unpack the replacement assembly

Follow these steps to unpack the replacement assembly.

1. Dispose of the defective part.




**NOTE:** HP recommends responsible disposal of the defective part.

<http://www8.hp.com/us/en/hp-information/environment/product-recycling.html>

2. Unpack the replacement part from the packaging.



**CAUTION:**  Some parts are sensitive to electrostatic discharge (ESD). Always perform service work at an ESD-protected workstation or mat. If an ESD workstation or mat is not available, touch the sheet-metal chassis to provide a static ground before touching an ESD-sensitive assembly. Protect the ESD-sensitive assemblies by placing them in ESD pouches when they are out of the printer.



**IMPORTANT:** Make sure that all of the shipping materials (for example shipping tape) are removed from the replacement part prior to installation.



**NOTE:** If the replacement part is a roller or pad, avoid touching the spongy part of it. Skin oils on the roller or pad can cause paper pickup and/or print-quality problems. HP recommends using disposable gloves when handling rollers or pads or washing your hands before touching rollers or pads.

3. To install an assembly, reverse the removal steps.



**NOTE:** When applicable, special installation instructions are provided for an assembly at the end of the removal procedure. Always completely read the removal instructions and follow all special installation instructions.


## Top exit unit

## Removal and replacement: Top lower feed assembly

Learn how to remove and replace the top lower feed assembly.

### Introduction

This document provides the procedures to remove and replace the top lower feed assembly for the finisher.

 **IMPORTANT:** When applicable, special installation instructions are provided for an assembly at the end of the removal procedure. Always completely read the removal instructions and follow all special installation instructions.

### Before performing service

- Turn the printer power off. A shutting-down message appears on the control-panel display.
- ⚠ **WARNING!** To avoid damage to the printer, turn the power off and wait until the printer shuts down before removing the power cable.
- Disconnect the printer power cable after the printer has completely shut down (the control-panel display is blank).
- Release the finisher from the printer by pulling out on the release latch inside the finisher door.
- Disconnect the cable from the bridge unit to the finisher.
- Disconnect the cable from the finisher to the printer.

Use the table below to identify the correct part number for your printer. To order the part, go to <https://parts.hp.com>.

**Table 5-101 Part information**

Part number	Part description
JC90-01454A	Top lower feed assembly

### Required tools

- #2 JIS screwdriver with a magnetic tip

### After performing service

- Connect the cable from the finisher to the printer.
- Connect the cable from the bridge unit to the finisher.
- Attach the finisher to the printer, and then push in on the release latch inside the finisher door.
- Connect the printer power cable.
- Turn the printer power on.

### Post service test

Process a job through the finisher and verify that the finisher works correctly.

## Remove the right upper cover (finisher)

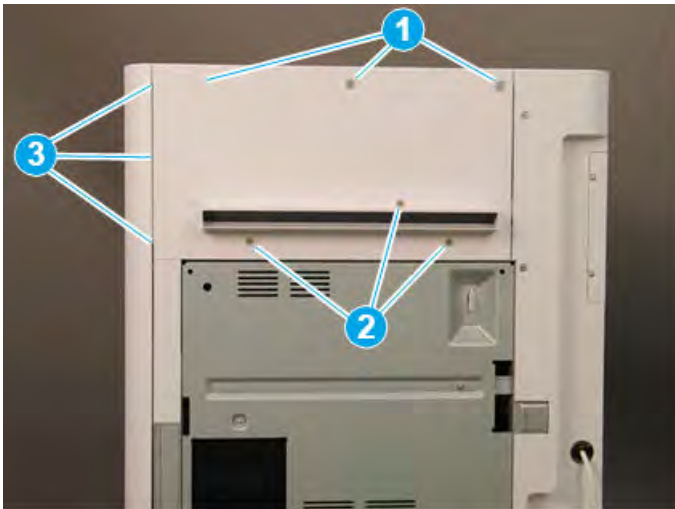
Follow these steps to remove the right upper cover (finisher).

- ▲ Remove one screw cap and three machine screws on the upper edge of the cover (callout 1). Remove three sheet metal screws (callout 2) on the lower portion of the cover. Rotate the right edge of the cover away from the finisher, and then slide the cover right to release three tabs (callout 3).

💡 **TIP:** The lower screws are shorter in length than the upper screws.

**TIP:** Reverse the removal steps to install the assembly.

**Figure 5-312** Remove the right upper cover

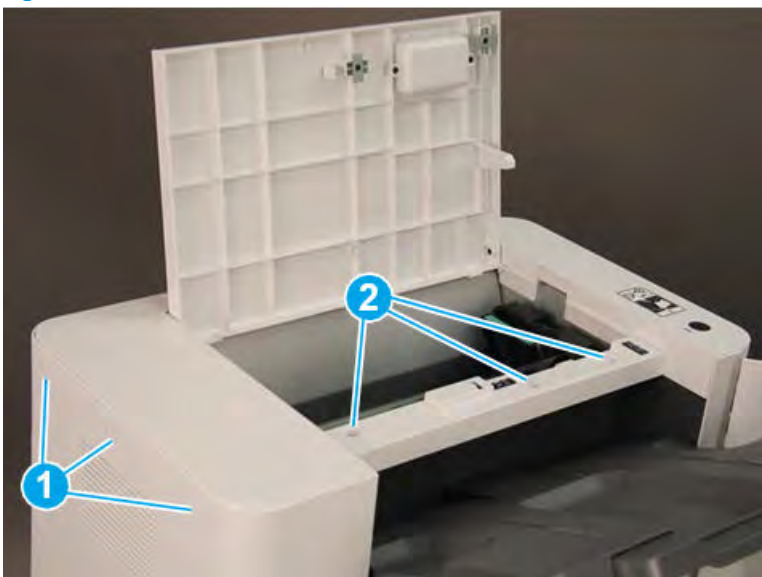


## Remove the top cover (finisher)

Follow these steps to remove the top cover (finisher).

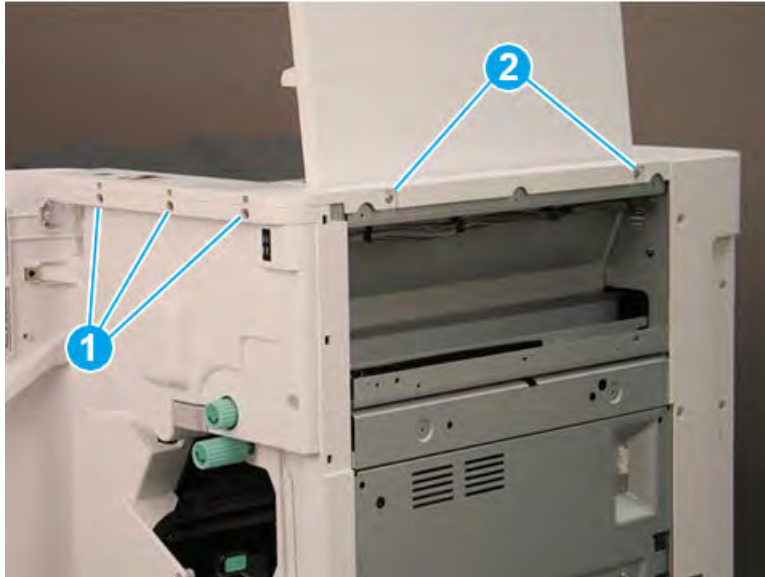
1. Remove three screw caps and three self-tapping screws at the top of the rear cover (callout 1), and then remove three machine screws (callout 2) on top of the cover.

**Figure 5-313** Remove six screws




2. Remove three self-tapping screws at the top of the front cover (callout 1), and then remove two machine screws (callout 2) at the top of the right side.

Figure 5-314 Remove five screws



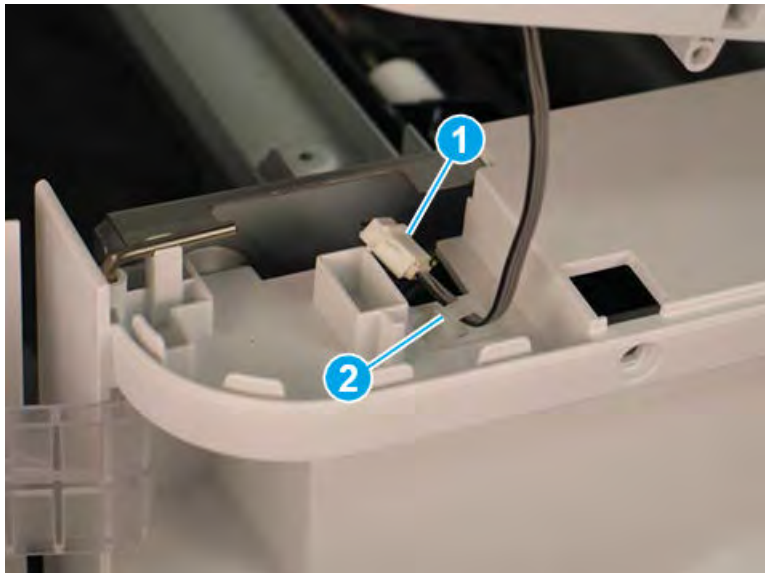
3. Lift the cover up slightly. Disconnect one in-line connector (callout 1), and then release one retainer (callout 2).

---

 **TIP:** Reverse the removal steps to install the assembly.

---

Figure 5-315 Disconnect one connector and release retainer

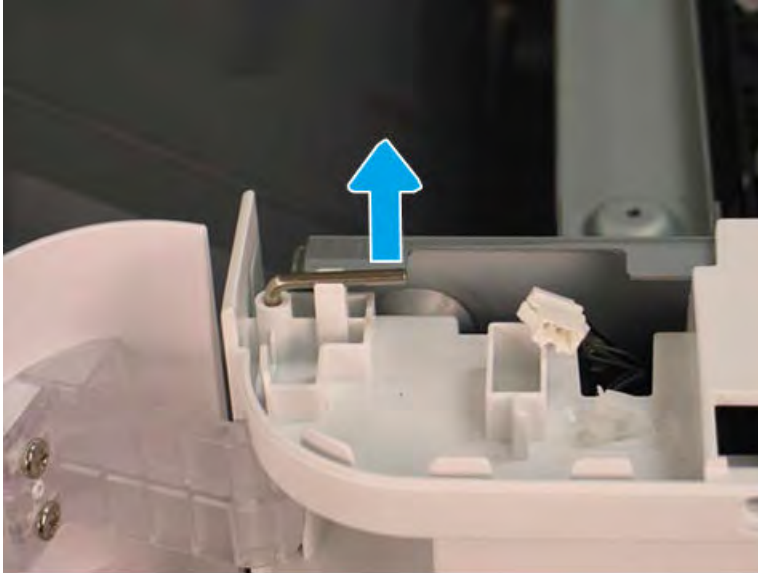


### Remove the front door (finisher)

Follow these steps to remove the front door (finisher).

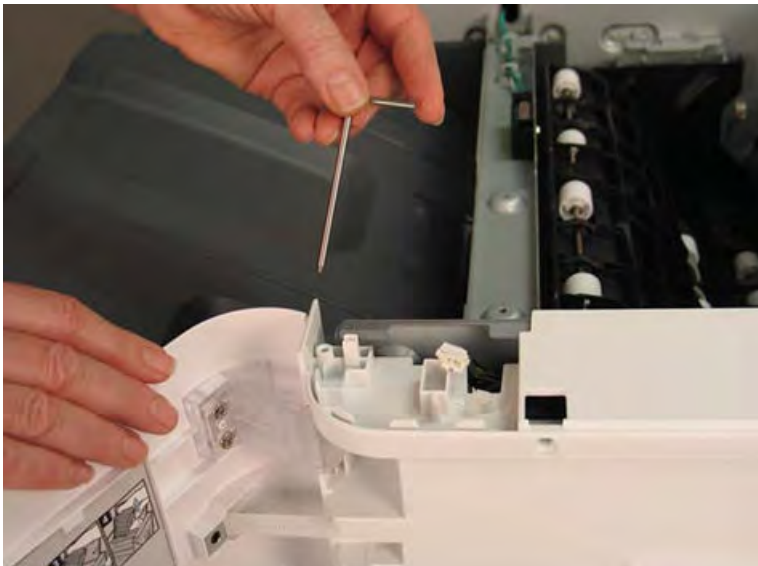
1. Lift the top hinge pin up to release it from the retainer.

Figure 5-316 Lift the top hinge pin



2. Pull the top hinge pin up to remove it.

Figure 5-317 Remove the top hinge pin





3. Use a small, flat-blade screwdriver to release the lower hinge pin from the retainer, and then rotate it away from the finisher.

Figure 5-318 Release the lower hinge pin




4. Support the door with one hand, and then pull the lower hinge pin straight up to remove it.

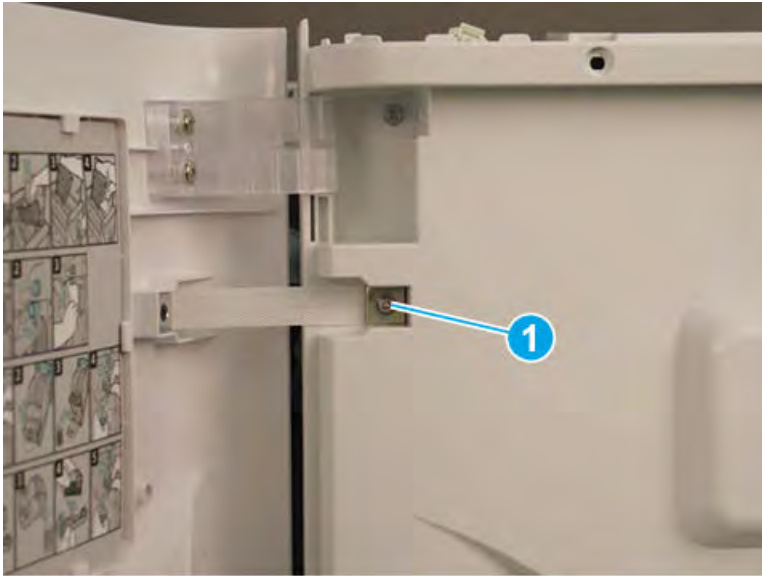
Figure 5-319 Remove the lower hinge pin



5. Support the door with one hand, and then remove one screw (callout 1) to release the strap. Remove the front door.

 **TIP:** Reverse the removal steps to install the assembly.

**Figure 5-320** Remove the front door

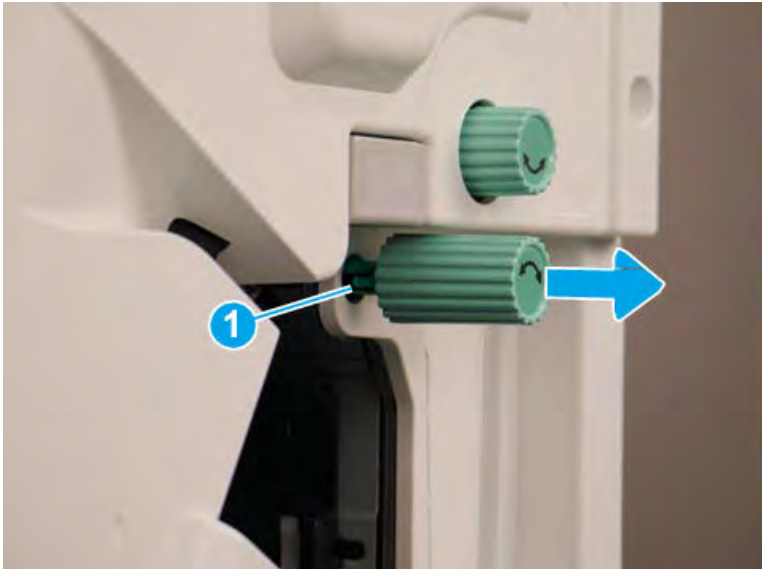


#### Remove the front cover (finisher)

Follow these steps to remove the front cover (finisher).

1. Release one tab (callout 1), and then pull the jam-access knob away from the finisher to remove it.

**Figure 5-321** Remove the jam-access knob



2. If the punch unit is installed, remove the punch waste bin (callout 1).

3. Remove one screw (callout 1) on top of the front cover.

Figure 5-322 Remove one screw



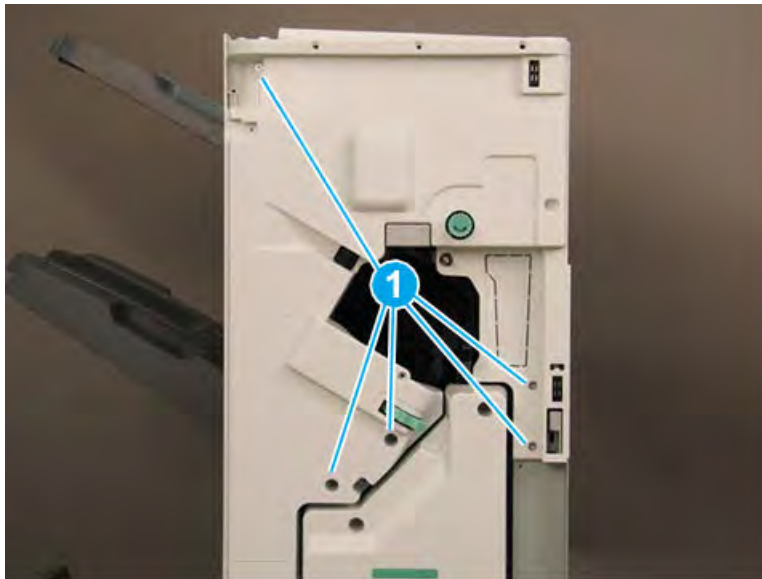
4. Remove five machine screws (callout 1), and then remove the front cover.

---

 **TIP:** Reverse the removal steps to install the assembly.

---

Figure 5-323 Remove the front cover

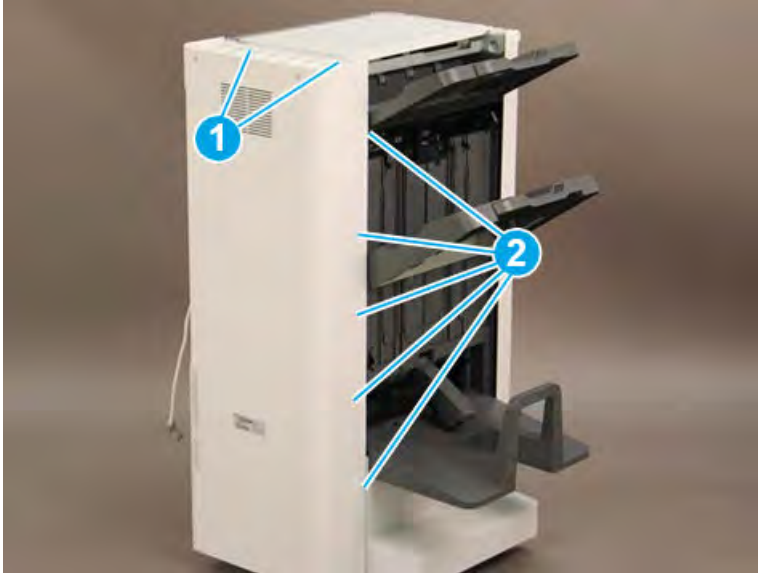


### Remove the rear cover (finisher)

Follow these steps to remove the rear cover (finisher).

1. Remove two self-tapping screws (callout 1) on the top of the rear cover, and then remove five screw caps and five machine screws (callout 2) on the left side of the cover.

Figure 5-324 Remove seven screws

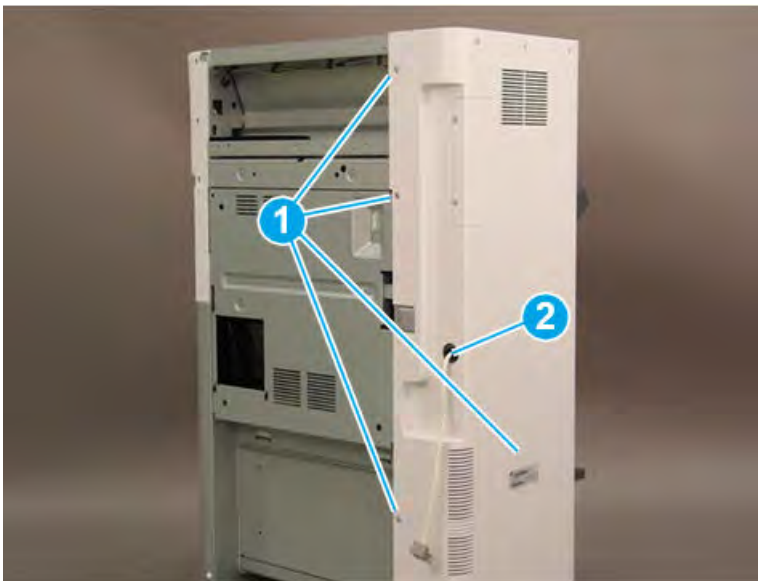


2. Remove one screw cap and four machine screws (callout 1) Remove the rear cover.

 **NOTE:** Make sure to thread the power cable (callout 2) through the opening in the cover.

 **TIP:** Reverse the removal steps to install the assembly


Figure 5-325 Remove the rear cover



### Remove the exit motor (M13)

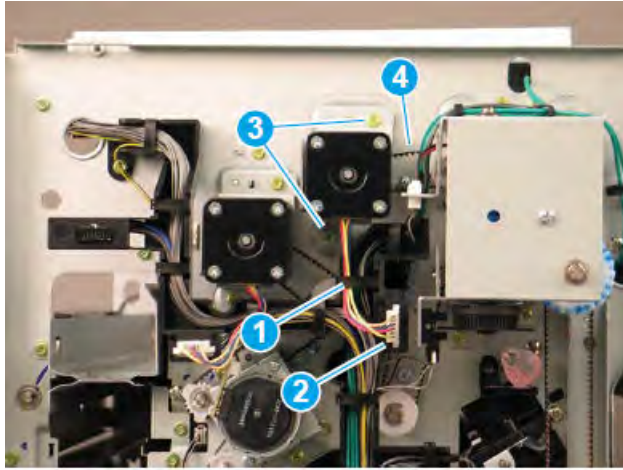
Follow these steps to remove the exit motor (M13).

- ▲ Release one retainer (callout 1), and then disconnect one connector (callout 2). Remove two screws (callout 3), and then remove the exit motor.

 **TIP:** Make sure that the belt (callout 4) is positioned on the gear behind the motor when reinstalling the motor.

**TIP:** Reverse the removal steps to install the assembly.

**Figure 5-326** Remove the exit motor

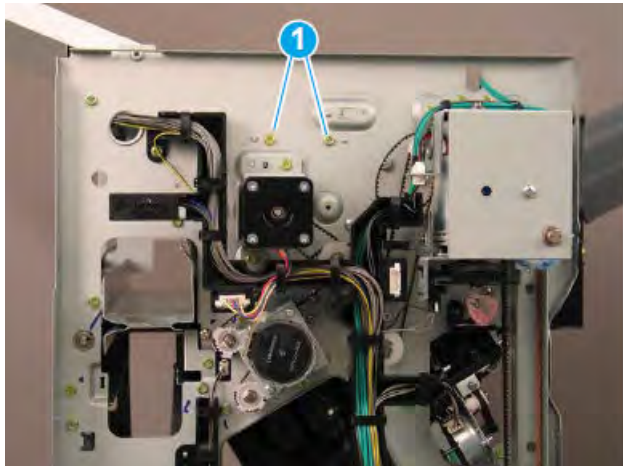


### Remove the top jam access cover


Follow these steps to remove the top jam access cover.

1. At the rear of the finisher, remove two screws (callout 1).

**Figure 5-327** Remove two screws



2. Remove the top jam access cover.

 **TIP:** Reverse the removal steps to install the assembly.

---

**Figure 5-328** Remove the top jam access cover

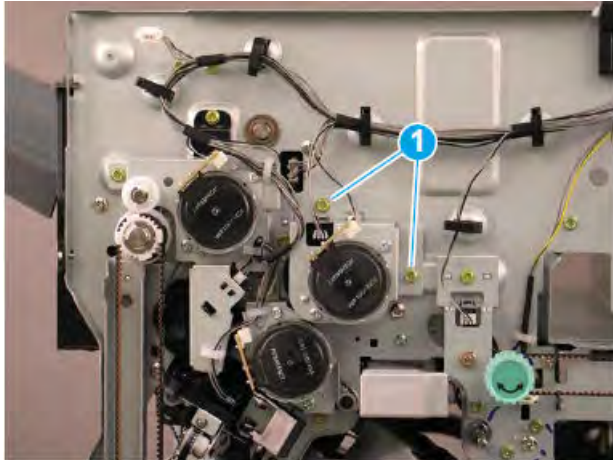


### Remove the top lower feed assembly (finisher)

Follow these steps to remove the top lower feed assembly (finisher).

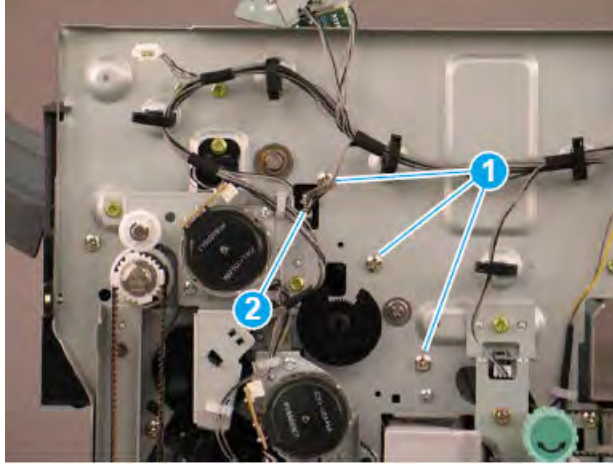
1. At the front of the printer, remove two screws (callout 1) on the main exit cam motor housing, and then tilt the motor aside to access the screws under it.

**Figure 5-329** Remove two screws



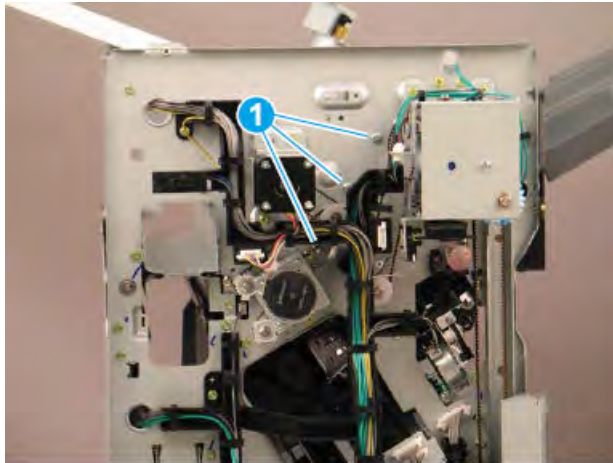
2. At the front of the finisher, remove three self-tapping screws (callout 1), and then disconnect one connector (callout 2).

Figure 5-330 Remove three screws and disconnect one connector



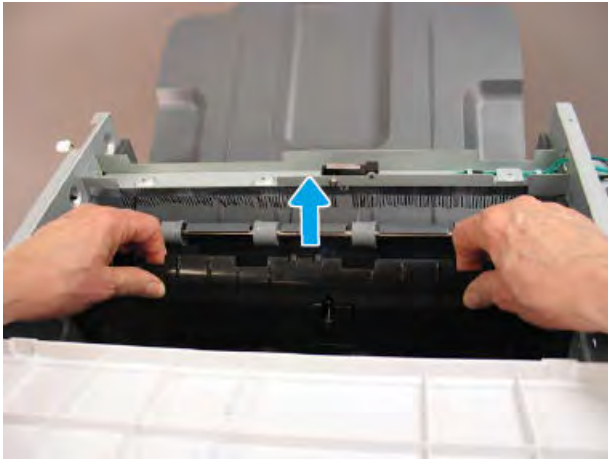
3. At the rear of the finisher, remove three machine screws (callout 1).

Figure 5-331 Remove three screws



4. At the top of the finisher, lift the feed assembly straight up to disengage two tabs on the bottom and remove the assembly.

**Figure 5-332** Remove the top lower feed assembly



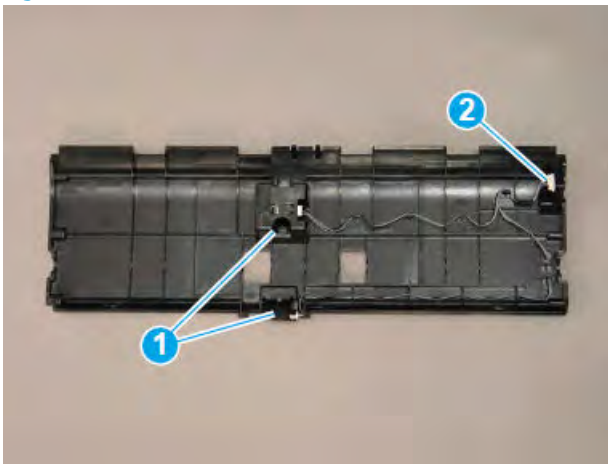
5. If you are replacing the top lower feed assembly, locate two sensors (callout 1) and one connector (callout 2) on the back of the assembly. Remove these items and transfer them to the replacement part.

---

 **TIP:** Reverse the removal steps to install the assembly.

---

**Figure 5-333** Locate sensors and connector



### Unpack the replacement assembly

Follow these steps to unpack the replacement assembly.

1. Dispose of the defective part.





---

 **NOTE:** HP recommends responsible disposal of the defective part.


<http://www8.hp.com/us/en/hp-information/environment/product-recycling.html>

---

2. Unpack the replacement part from the packaging.


 **CAUTION:**  Some parts are sensitive to electrostatic discharge (ESD). Always perform service work at an ESD-protected workstation or mat. If an ESD workstation or mat is not available, touch the sheet-metal chassis to provide a static ground before touching an ESD-sensitive assembly. Protect the ESD-sensitive assemblies by placing them in ESD pouches when they are out of the printer.

 **IMPORTANT:** Make sure that all of the shipping materials (for example shipping tape) are removed from the replacement part prior to installation.

 **NOTE:** If the replacement part is a roller or pad, avoid touching the spongy part of it. Skin oils on the roller or pad can cause paper pickup and/or print-quality problems. HP recommends using disposable gloves when handling rollers or pads or washing your hands before touching rollers or pads.

---

3. To install an assembly, reverse the removal steps.

 **NOTE:** When applicable, special installation instructions are provided for an assembly at the end of the removal procedure. Always completely read the removal instructions and follow all special installation instructions.


---

# HP LaserJet Managed MFP E82540-E82560, E87640-E87660, E82540du-E82560du, E87640du-E87660du, E72525-E72535, E77822-E77830 – Removal and replacement: Top exit sensor (S11)

Learn how to remove and replace the top exit sensor.

## Introduction

This document provides the procedures to remove and replace the top exit sensor for the finisher.

 **IMPORTANT:** When applicable, special installation instructions are provided for an assembly at the end of the removal procedure. Always completely read the removal instructions and follow all special installation instructions.

## Before performing service

- Turn the printer power off. A shutting-down message appears on the control-panel display.
- ⚠ **WARNING!** To avoid damage to the printer, turn the power off and wait until the printer shuts down before removing the power cable.
- Disconnect the printer power cable after the printer has completely shut down (the control-panel display is blank).
- Release the finisher from the printer by pulling out on the release latch inside the finisher door.
- Disconnect the cable from the bridge unit to the finisher.
- Disconnect the cable from the finisher to the printer.

Use the table below to identify the correct part number for your printer. To order the part, go to <https://parts.hp.com>.

**Table 5-102 Part information**

Part number	Part description
0604-001393	Top exit sensor

## Required tools

- #2 JIS screwdriver with a magnetic tip

## After performing service

- Connect the cable from the finisher to the printer.
- Connect the cable from the bridge unit to the finisher.
- Attach the finisher to the printer, and then push in on the release latch inside the finisher door.
- Connect the printer power cable.
- Turn the printer power on.

## Post service test

Process a job through the finisher and verify that the finisher works correctly.

### Remove the right upper cover (finisher)

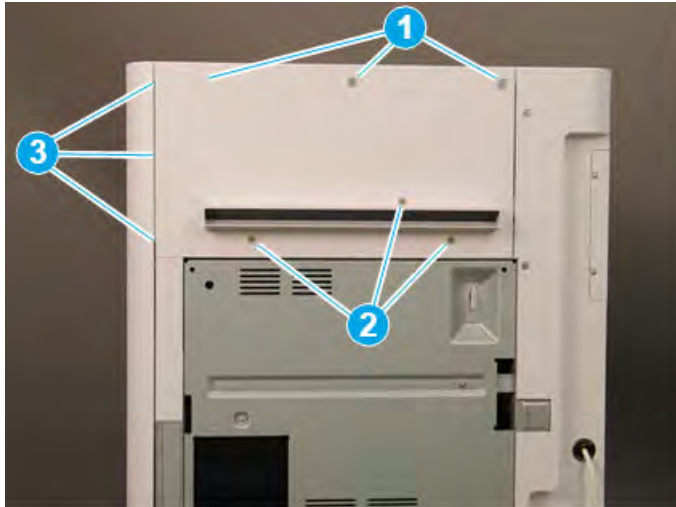
Follow these steps to remove the right upper cover (finisher).

- ▲ Remove one screw cap and three machine screws on the upper edge of the cover (callout 1). Remove three sheet metal screws (callout 2) on the lower portion of the cover. Rotate the right edge of the cover away from the finisher, and then slide the cover right to release three tabs (callout 3).

💡 **TIP:** The lower screws are shorter in length than the upper screws.

**TIP:** Reverse the removal steps to install the assembly.

Figure 5-334 Remove the right upper cover

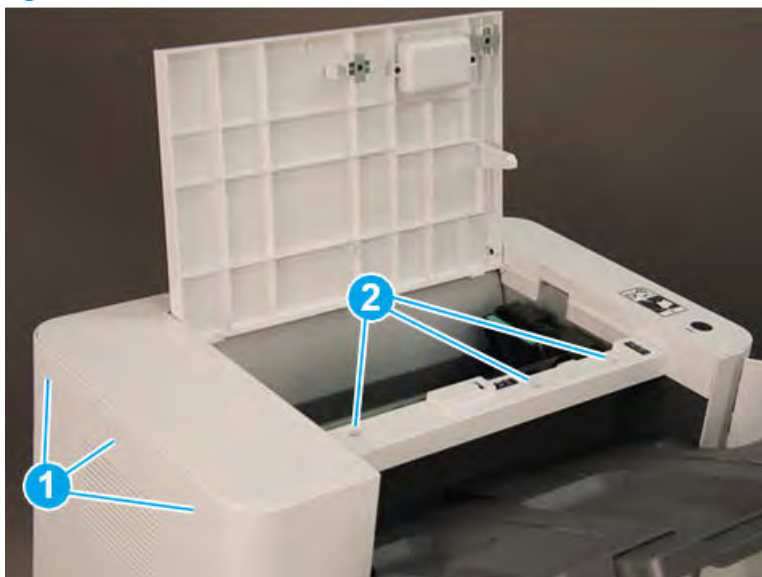


### Remove the top cover (finisher)

Follow these steps to remove the top cover (finisher).

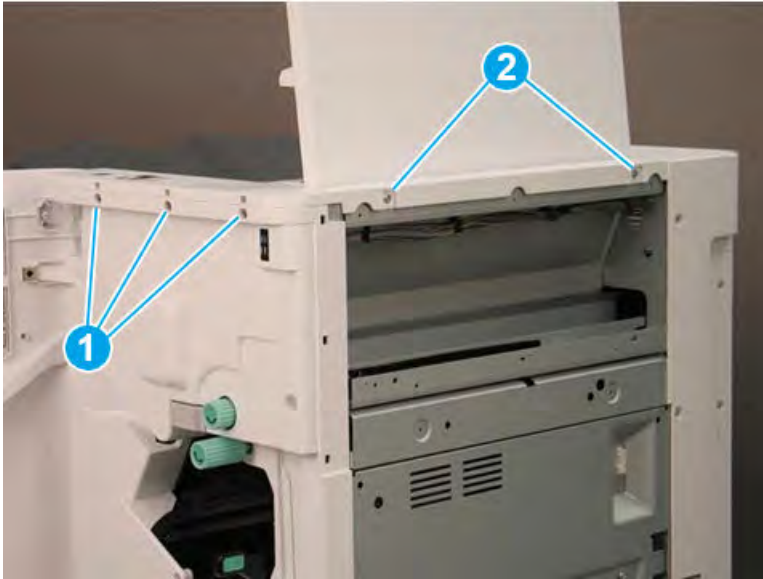
1. Remove three screw caps and three self-tapping screws at the top of the rear cover (callout 1), and then remove three machine screws (callout 2) on top of the cover.

Figure 5-335 Remove six screws




2. Remove three self-tapping screws at the top of the front cover (callout 1), and then remove two machine screws (callout 2) at the top of the right side.

Figure 5-336 Remove five screws



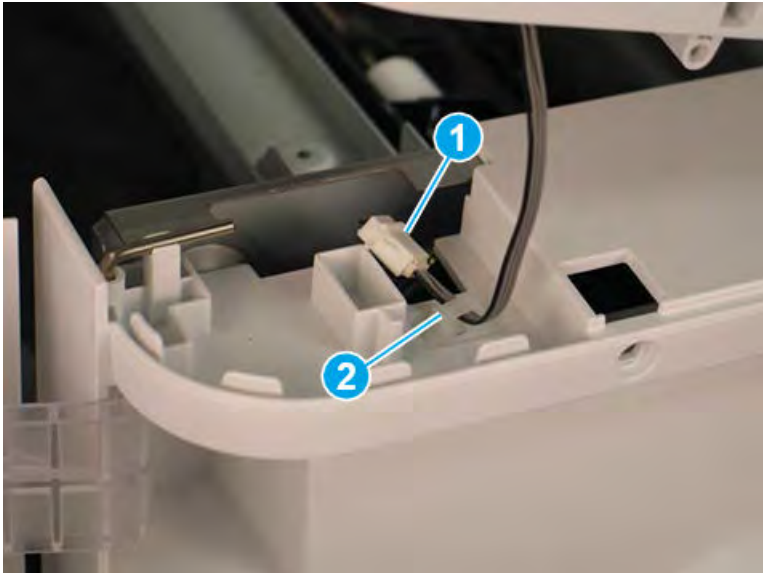
3. Lift the cover up slightly. Disconnect one in-line connector (callout 1), and then release one retainer (callout 2).

---

 **TIP:** Reverse the removal steps to install the assembly.

---

Figure 5-337 Disconnect one connector and release retainer

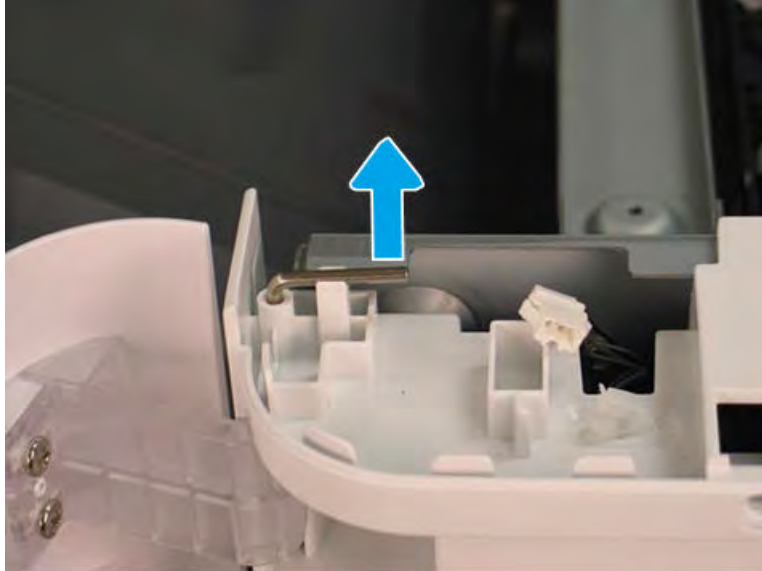


### Remove the front door (finisher)

Follow these steps to remove the front door (finisher).

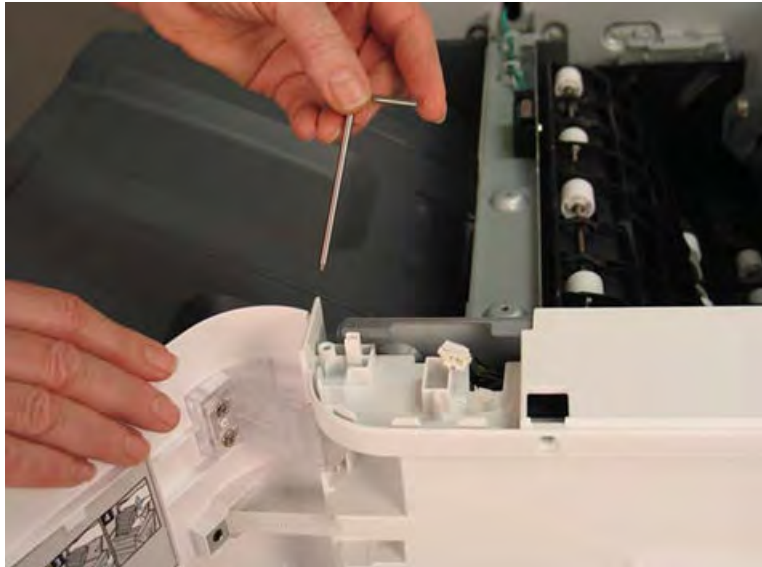
1. Lift the top hinge pin up to release it from the retainer.

Figure 5-338 Lift the top hinge pin



2. Pull the top hinge pin up to remove it.

Figure 5-339 Remove the top hinge pin



3. Use a small, flat-blade screwdriver to release the lower hinge pin from the retainer, and then rotate it away from the finisher.

**Figure 5-340** Release the lower hinge pin




4. Support the door with one hand, and then pull the lower hinge pin straight up to remove it.

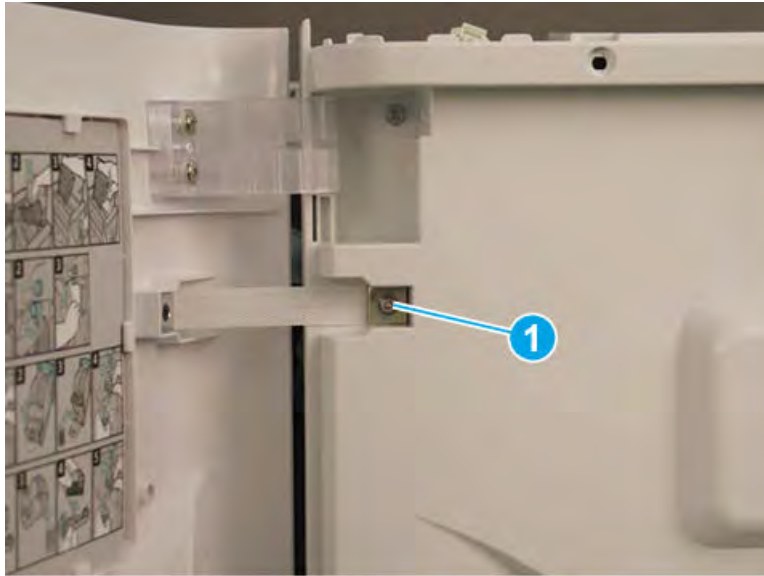
**Figure 5-341** Remove the lower hinge pin



5. Support the door with one hand, and then remove one screw (callout 1) to release the strap. Remove the front door.

 **TIP:** Reverse the removal steps to install the assembly.

**Figure 5-342** Remove the front door

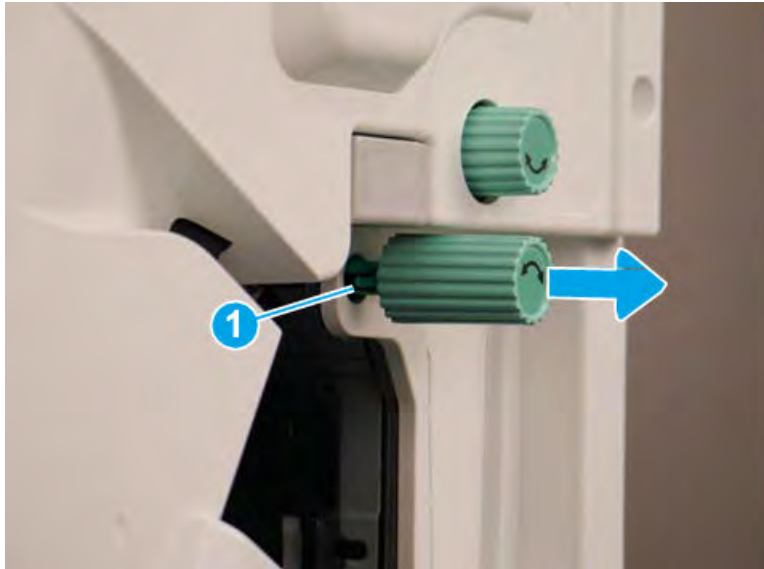


#### Remove the front cover (finisher)

Follow these steps to remove the front cover (finisher).

1. Release one tab (callout 1), and then pull the jam-access knob away from the finisher to remove it.

**Figure 5-343** Remove the jam-access knob



2. If the punch unit is installed, remove the punch waste bin (callout 1).


3. Remove one screw (callout 1) on top of the front cover.

Figure 5-344 Remove one screw



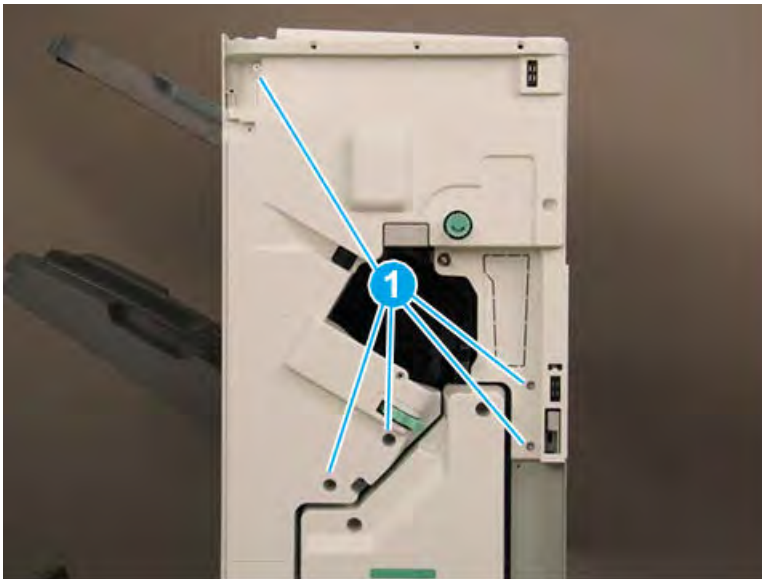
4. Remove five machine screws (callout 1), and then remove the front cover.

---

 **TIP:** Reverse the removal steps to install the assembly.

---

Figure 5-345 Remove the front cover



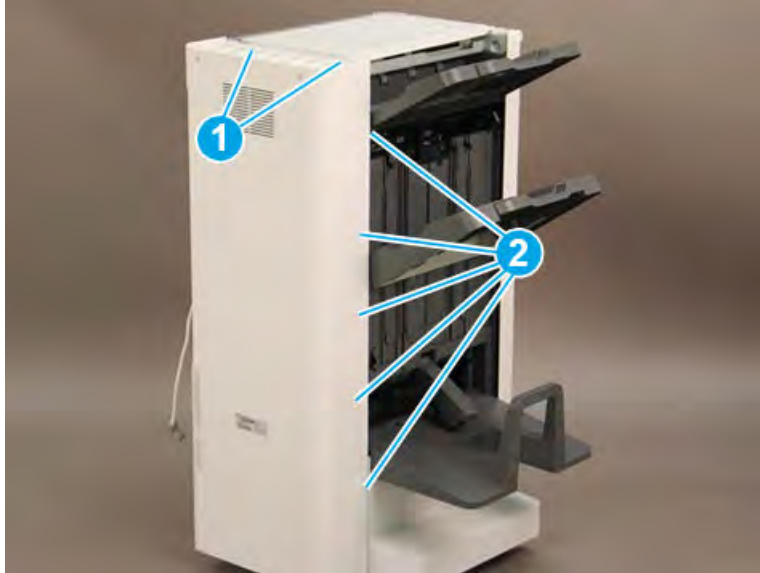
### Remove the rear cover (finisher)

Follow these steps to remove the rear cover (finisher).

1. Remove two self-tapping screws (callout 1) on the top of the rear cover, and then remove five screw caps and five machine screws (callout 2) on the left side of the cover.



Figure 5-346 Remove seven screws

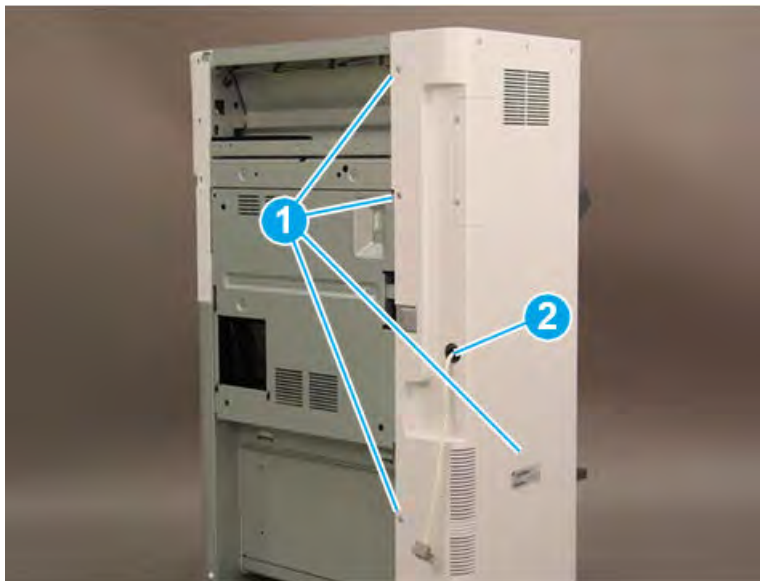


2. Remove one screw cap and four machine screws (callout 1) Remove the rear cover.

 **NOTE:** Make sure to thread the power cable (callout 2) through the opening in the cover.

 **TIP:** Reverse the removal steps to install the assembly


Figure 5-347 Remove the rear cover



### Remove the exit motor (M13)

Follow these steps to remove the exit motor (M13).

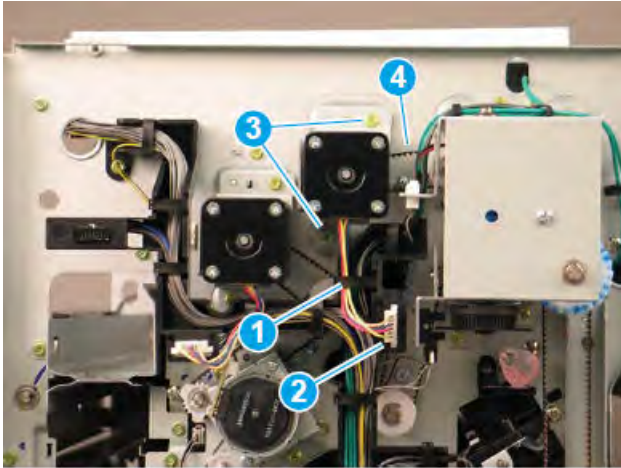
- ▲ Release one retainer (callout 1), and then disconnect one connector (callout 2). Remove two screws (callout 3), and then remove the exit motor.

 **TIP:** Make sure that the belt (callout 4) is positioned on the gear behind the motor when reinstalling the motor.

**TIP:** Reverse the removal steps to install the assembly.

---

**Figure 5-348** Remove the exit motor

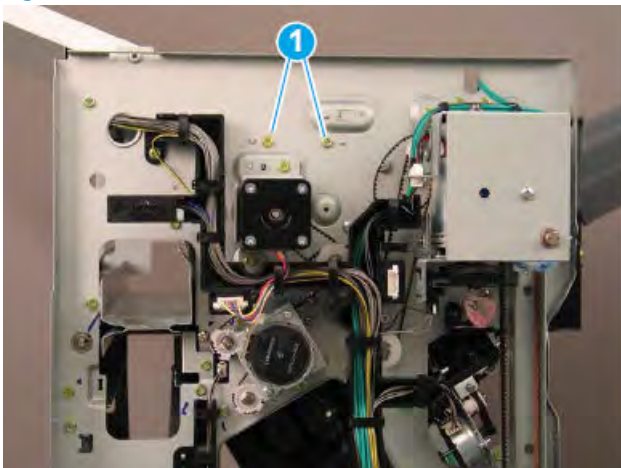


### Remove the top jam access cover


Follow these steps to remove the top jam access cover.

1. At the rear of the finisher, remove two screws (callout 1).

**Figure 5-349** Remove two screws



2. Remove the top jam access cover.

 **TIP:** Reverse the removal steps to install the assembly.

**Figure 5-350** Remove the top jam access cover

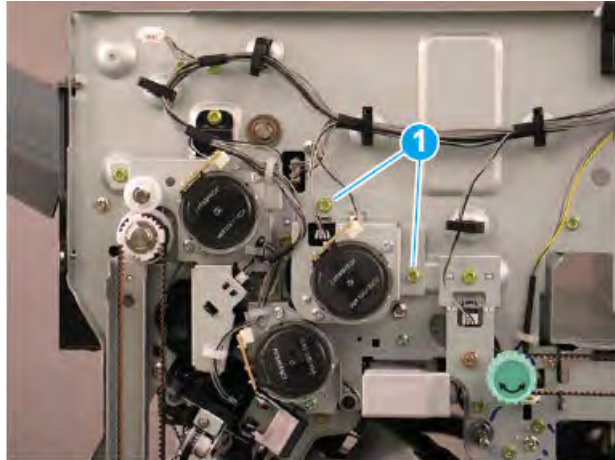


### Remove the top lower feed assembly (finisher)

Follow these steps to remove the top lower feed assembly (finisher).

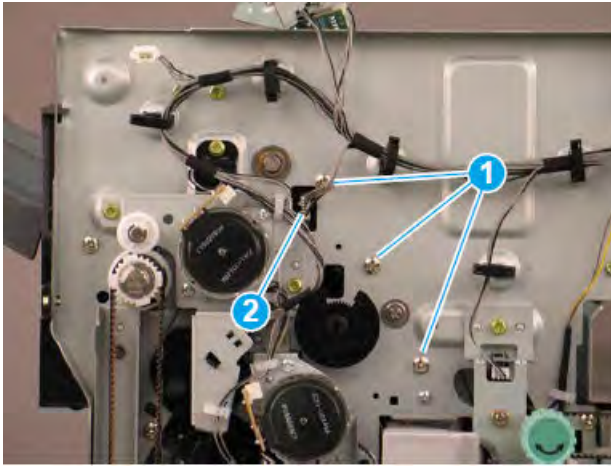
1. At the front of the printer, remove two screws (callout 1) on the main exit cam motor housing, and then tilt the motor aside to access the screws under it.

**Figure 5-351** Remove two screws



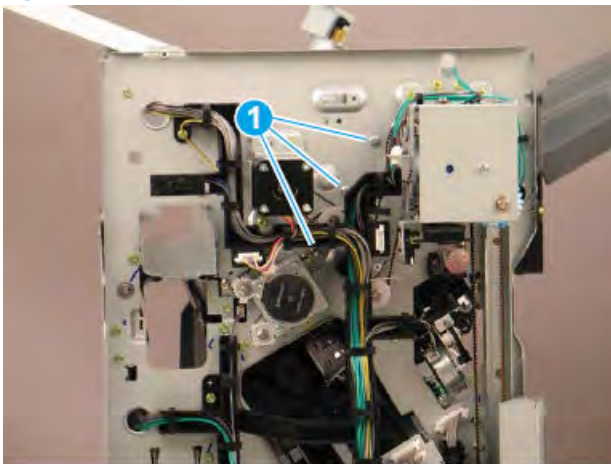
2. At the front of the finisher, remove three self-tapping screws (callout 1), and then disconnect one connector (callout 2).

**Figure 5-352** Remove three screws and disconnect one connector



3. At the rear of the finisher, remove three machine screws (callout 1).

**Figure 5-353** Remove three screws




4. At the top of the finisher, lift the feed assembly straight up to disengage two tabs on the bottom and remove the assembly.

**Figure 5-354** Remove the top lower feed assembly



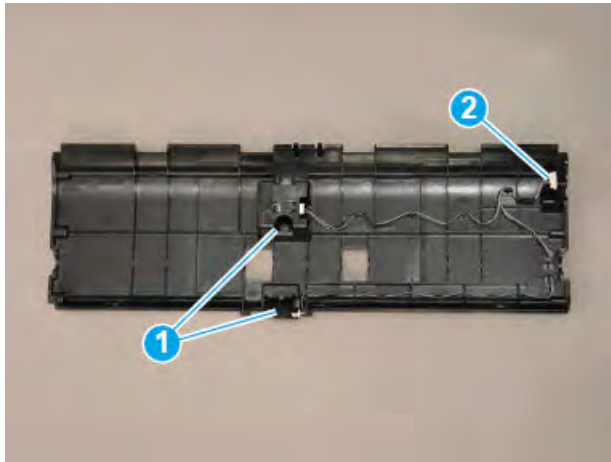
5. If you are replacing the top lower feed assembly, locate two sensors (callout 1) and one connector (callout 2) on the back of the assembly. Remove these items and transfer them to the replacement part.

---

 **TIP:** Reverse the removal steps to install the assembly.

---

**Figure 5-355** Locate sensors and connector



### Remove the top exit sensor(S11)

Follow these steps to remove the top exit sensor(S11).

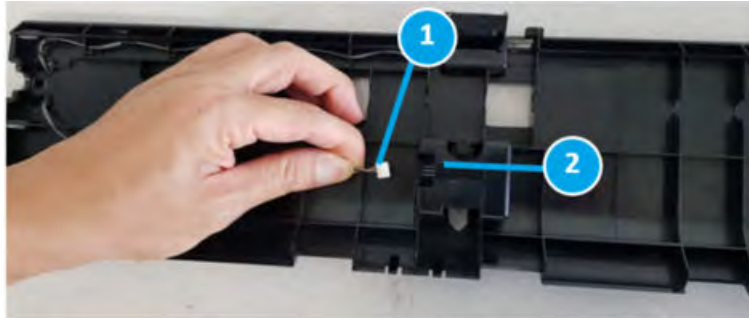
1. Remove one screw(callout 1) at the top lower feed assembly.

**Figure 5-356** Remove one screw and then top lower feed assembly



2. Remove harness (callout 1) and top exit sensor (S11, callout 2)

**Figure 5-357** Remove harness and then top exit sensor



### Unpack the replacement assembly



Follow these steps to unpack the replacement assembly.

1. Dispose of the defective part.


 **NOTE:** HP recommends responsible disposal of the defective part.

<http://www8.hp.com/us/en/hp-information/environment/product-recycling.html>


2. Unpack the replacement part from the packaging.

 **CAUTION:**  Some parts are sensitive to electrostatic discharge (ESD). Always perform service work at an ESD-protected workstation or mat. If an ESD workstation or mat is not available, touch the sheet-metal chassis to provide a static ground before touching an ESD-sensitive assembly. Protect the ESD-sensitive assemblies by placing them in ESD pouches when they are out of the printer.

 **IMPORTANT:** Make sure that all of the shipping materials (for example shipping tape) are removed from the replacement part prior to installation.

 **NOTE:** If the replacement part is a roller or pad, avoid touching the spongy part of it. Skin oils on the roller or pad can cause paper pickup and/or print-quality problems. HP recommends using disposable gloves when handling rollers or pads or washing your hands before touching rollers or pads.

3. To install an assembly, reverse the removal steps.

 **NOTE:** When applicable, special installation instructions are provided for an assembly at the end of the removal procedure. Always completely read the removal instructions and follow all special installation instructions.


## Top output tray unit

## Removal and replacement: Top output tray

Learn how to remove and replace the top output tray.

### Introduction

This document provides the procedures to remove and replace the top output tray on the finisher.

 **IMPORTANT:** When applicable, special installation instructions are provided for an assembly at the end of the removal procedure. Always completely read the removal instructions and follow all special installation instructions.

### Before performing service

- Turn the printer power off. A shutting-down message appears on the control-panel display.
- ⚠ **WARNING!** To avoid damage to the printer, turn the power off and wait until the printer shuts down before removing the power cable.
- Disconnect the printer power cable after the printer has completely shut down (the control-panel display is blank).
- Release the finisher from the printer by pulling out on the release latch inside the finisher door.
- Disconnect the cable from the bridge unit to the finisher.
- Disconnect the cable from the finisher to the printer.

Use the table below to identify the correct part number for your printer. To order the part, go to <https://parts.hp.com>.

**Table 5-103 Part information**

Part number	Part description
JC63-04995B	Top output tray

### Required tools

- No special tools are needed to remove or install this assembly.

### After performing service

- Connect the cable from the finisher to the printer.
- Connect the cable from the bridge unit to the finisher.
- Attach the finisher to the printer, and then push in on the release latch inside the finisher door.
- Connect the printer power cable.
- Turn the printer power on.

### Post service test

Process a job through the finisher and verify that the finisher works correctly.

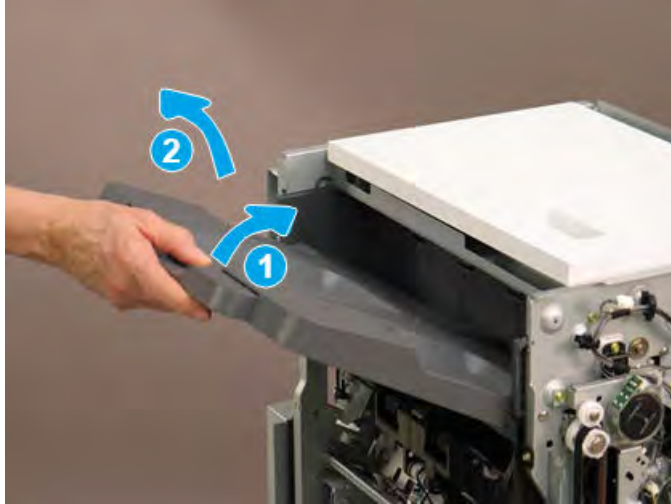


## Remove the top output tray

Follow these steps to remove the top output tray.

- ▲ Raise the end of the top output tray (callout 1), and then lift it away from the finisher (callout 2) to remove it.

Figure 5-358 Remove the top output tray



## Unpack the replacement assembly

Follow these steps to unpack the replacement assembly.

1. Dispose of the defective part.

---



 **NOTE:** HP recommends responsible disposal of the defective part.


<http://www8.hp.com/us/en/hp-information/environment/product-recycling.html>


---

2. Unpack the replacement part from the packaging.

---

 **CAUTION:**  Some parts are sensitive to electrostatic discharge (ESD). Always perform service work at an ESD-protected workstation or mat. If an ESD workstation or mat is not available, touch the sheet-metal chassis to provide a static ground before touching an ESD-sensitive assembly. Protect the ESD-sensitive assemblies by placing them in ESD pouches when they are out of the printer.


 **IMPORTANT:** Make sure that all of the shipping materials (for example shipping tape) are removed from the replacement part prior to installation.

 **NOTE:** If the replacement part is a roller or pad, avoid touching the spongy part of it. Skin oils on the roller or pad can cause paper pickup and/or print-quality problems. HP recommends using disposable gloves when handling rollers or pads or washing your hands before touching rollers or pads.

---

3. To install an assembly, reverse the removal steps.

---

 **NOTE:** When applicable, special installation instructions are provided for an assembly at the end of the removal procedure. Always completely read the removal instructions and follow all special installation instructions.


---

# HP LaserJet Managed MFP E82540-E82560, E87640-E87660, E82540du-E82560du, E87640du-E87660du, E72525-E72535, E77822-E77830 - Top output tray paper full sensor (S15)

Learn how to remove and replace the top output tray paper full sensor.

## Introduction

This document provides the procedures to remove and replace the top output tray paper full sensor for the finisher.

 **IMPORTANT:** When applicable, special installation instructions are provided for an assembly at the end of the removal procedure. Always completely read the removal instructions and follow all special installation instructions.

## Before performing service

- Turn the printer power off. A shutting-down message appears on the control-panel display.
- ⚠ **WARNING!** To avoid damage to the printer, turn the power off and wait until the printer shuts down before removing the power cable.
- Disconnect the printer power cable after the printer has completely shut down (the control-panel display is blank).
- Release the finisher from the printer by pulling out on the release latch inside the finisher door.
- Disconnect the cable from the bridge unit to the finisher.
- Disconnect the cable from the finisher to the printer.

Use the table below to identify the correct part number for your printer. To order the part, go to <https://parts.hp.com>.

**Table 5-104 Part information**

Part number	Part description
JC82-01039A	Top output tray paper full sensor

## Required tools

- #2 JIS screwdriver with a magnetic tip

## After performing service

- Connect the cable from the finisher to the printer.
- Connect the cable from the bridge unit to the finisher.
- Attach the finisher to the printer, and then push in on the release latch inside the finisher door.
- Connect the printer power cable.
- Turn the printer power on.

## Post service test

Process a job through the finisher and verify that the finisher works correctly.

### Remove the right upper cover (finisher)

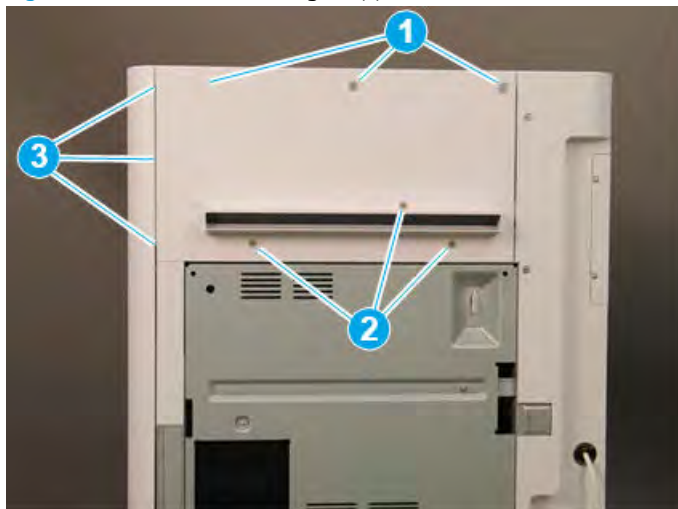
Follow these steps to remove the right upper cover (finisher).

- ▲ Remove one screw cap and three machine screws on the upper edge of the cover (callout 1). Remove three sheet metal screws (callout 2) on the lower portion of the cover. Rotate the right edge of the cover away from the finisher, and then slide the cover right to release three tabs (callout 3).

💡 **TIP:** The lower screws are shorter in length than the upper screws.

**TIP:** Reverse the removal steps to install the assembly.

Figure 5-359 Remove the right upper cover

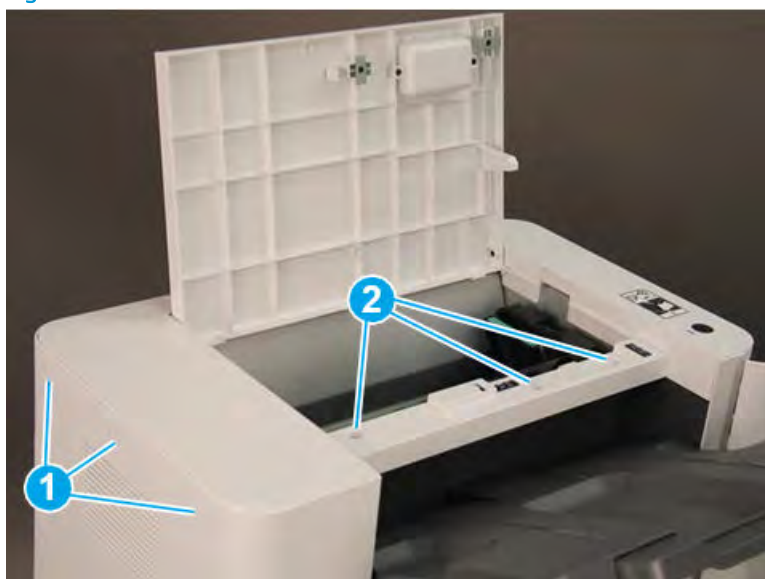


### Remove the top cover (finisher)

Follow these steps to remove the top cover (finisher).

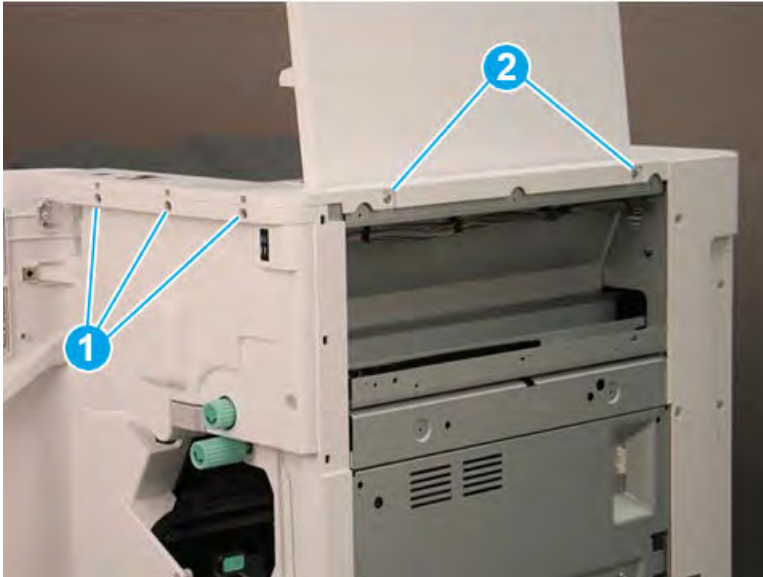
1. Remove three screw caps and three self-tapping screws at the top of the rear cover (callout 1), and then remove three machine screws (callout 2) on top of the cover.

Figure 5-360 Remove six screws




2. Remove three self-tapping screws at the top of the front cover (callout 1), and then remove two machine screws (callout 2) at the top of the right side.

**Figure 5-361** Remove five screws



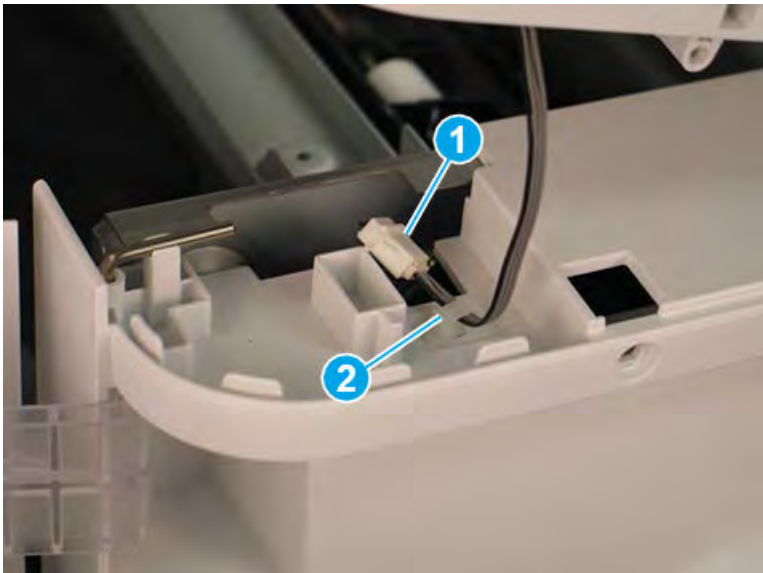
3. Lift the cover up slightly. Disconnect one in-line connector (callout 1), and then release one retainer (callout 2).

---

 **TIP:** Reverse the removal steps to install the assembly.

---

**Figure 5-362** Disconnect one connector and release retainer

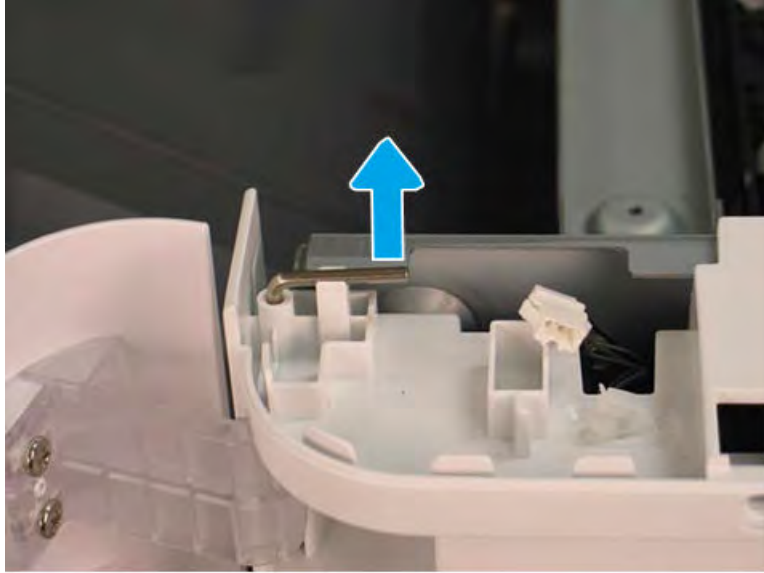


### Remove the front door (finisher)

Follow these steps to remove the front door (finisher).

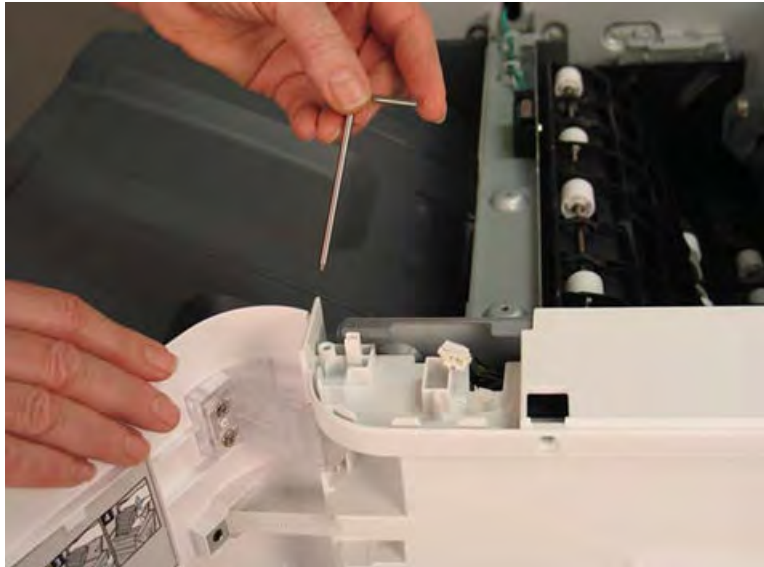
1. Lift the top hinge pin up to release it from the retainer.

Figure 5-363 Lift the top hinge pin



2. Pull the top hinge pin up to remove it.

Figure 5-364 Remove the top hinge pin



3. Use a small, flat-blade screwdriver to release the lower hinge pin from the retainer, and then rotate it away from the finisher.

**Figure 5-365** Release the lower hinge pin




4. Support the door with one hand, and then pull the lower hinge pin straight up to remove it.

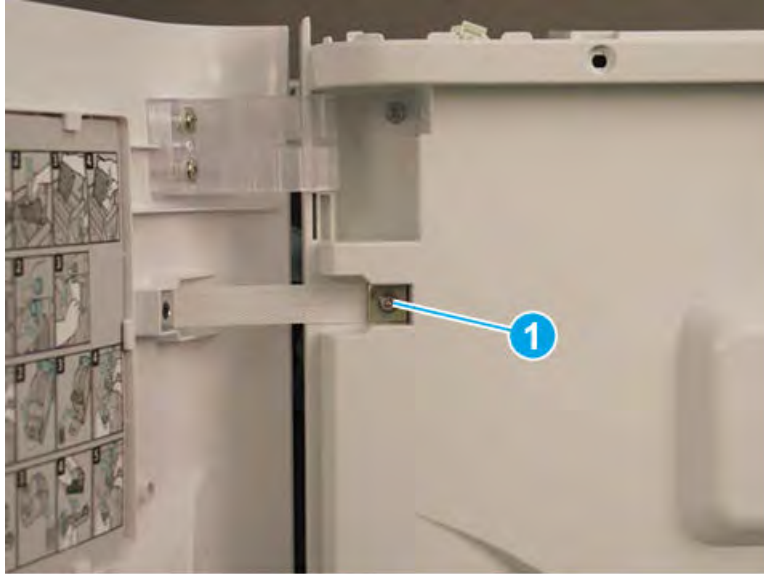
**Figure 5-366** Remove the lower hinge pin



5. Support the door with one hand, and then remove one screw (callout 1) to release the strap. Remove the front door.

 **TIP:** Reverse the removal steps to install the assembly.

**Figure 5-367** Remove the front door

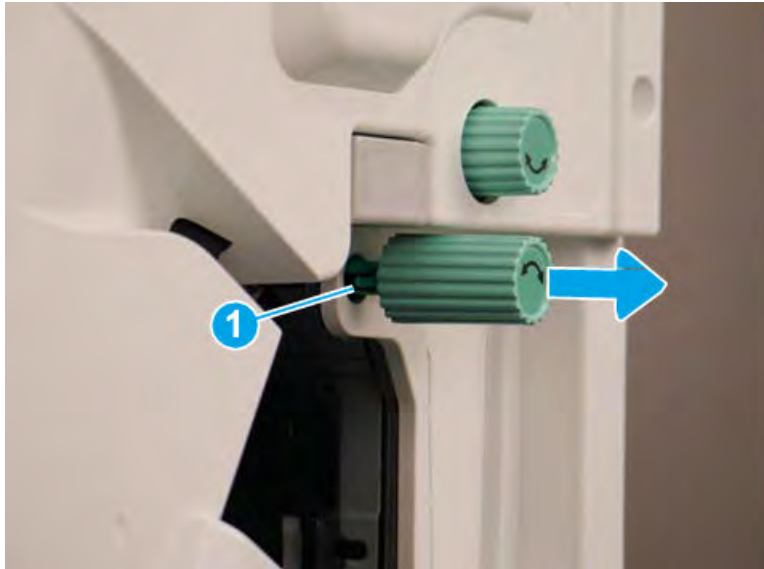


#### Remove the front cover (finisher)

Follow these steps to remove the front cover (finisher).

1. Release one tab (callout 1), and then pull the jam-access knob away from the finisher to remove it.

**Figure 5-368** Remove the jam-access knob



2. If the punch unit is installed, remove the punch waste bin (callout 1).


3. Remove one screw (callout 1) on top of the front cover.

Figure 5-369 Remove one screw



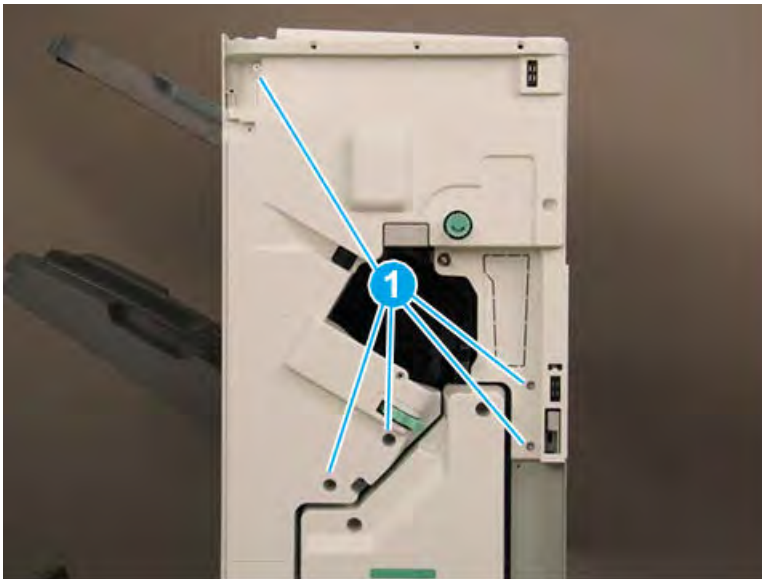
4. Remove five machine screws (callout 1), and then remove the front cover.

---

 **TIP:** Reverse the removal steps to install the assembly.

---

Figure 5-370 Remove the front cover



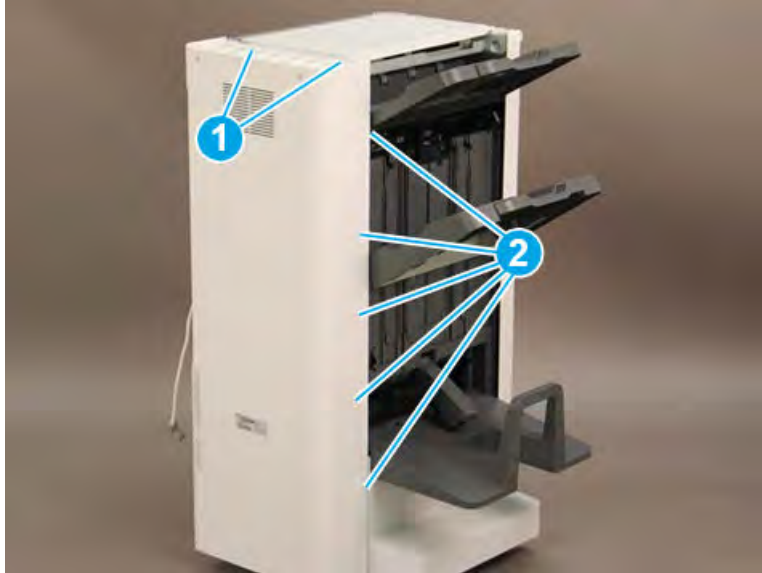
### Remove the rear cover (finisher)

Follow these steps to remove the rear cover (finisher).

1. Remove two self-tapping screws (callout 1) on the top of the rear cover, and then remove five screw caps and five machine screws (callout 2) on the left side of the cover.




Figure 5-371 Remove seven screws



2. Remove one screw cap and four machine screws (callout 1) Remove the rear cover.

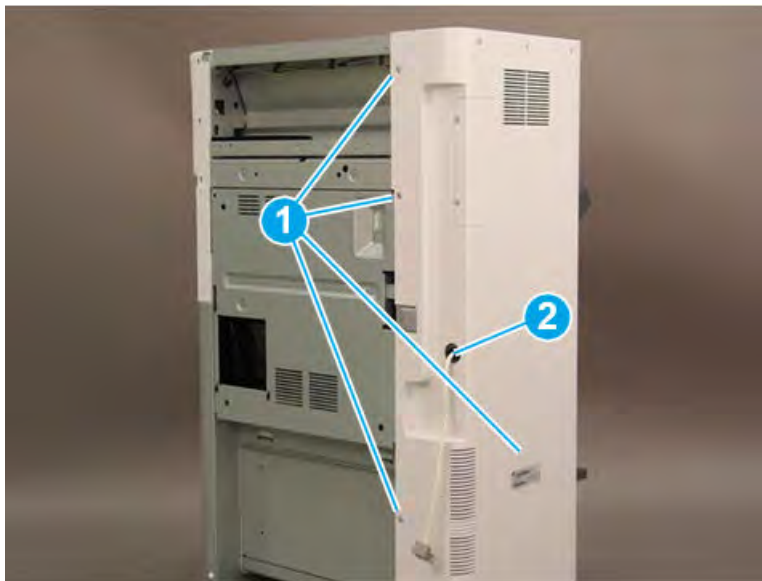
---

 **NOTE:** Make sure to thread the power cable (callout 2) through the opening in the cover.

 **TIP:** Reverse the removal steps to install the assembly

---

Figure 5-372 Remove the rear cover

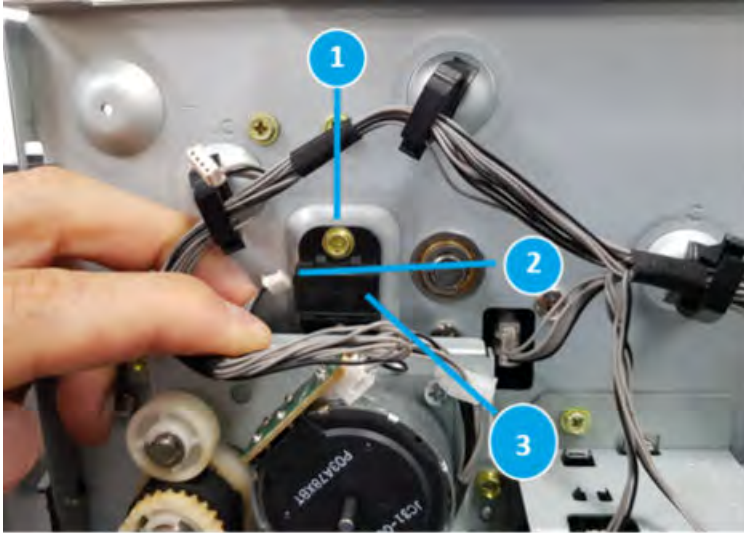


### Remove top output tray paper full sensor (S15)

Follow these steps to remove top output tray paper full sensor (S15).

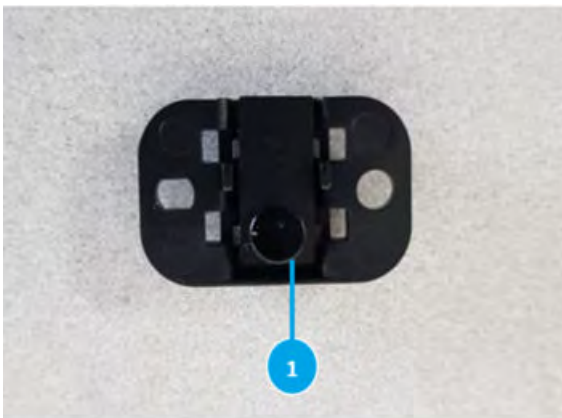
1. At the front of the finisher, remove screw (callout 1), disconnect the connector (callout 2) and then remove the sensor assembly (callout 3)

Figure 5-373 Remove screw and connector and sensor assy



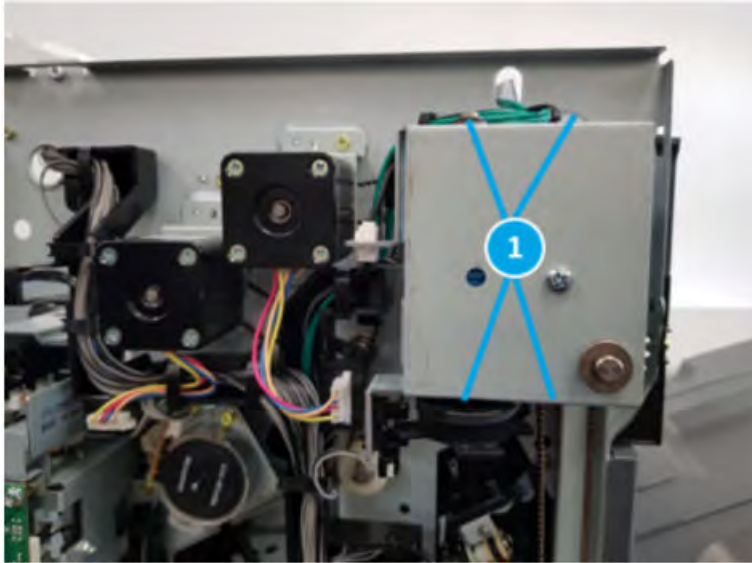
2. Remove top output tray paper full sensor- detector (callout 1).

Figure 5-374 Remove top output tray paper full sensor



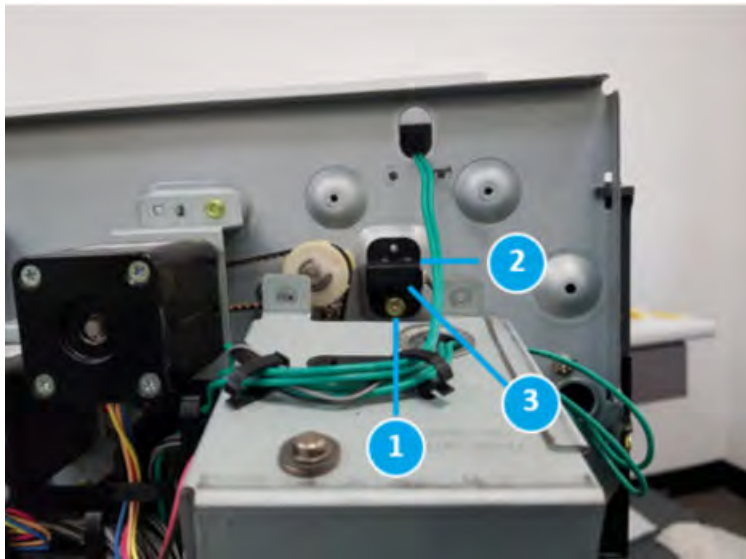
3. At the rear of the finisher, remove four screws (callout 1).

Figure 5-375 Remove four screws



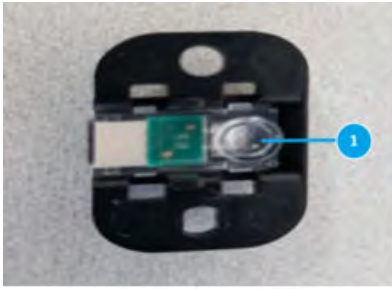
4. Remove screw (callout 1), disconnect the connector (callout 2), and then remove the sensor assembly (callout 3).

Figure 5-376 Remove screw and connector and sensor assy



5. Remove top output tray paper full sensor- emitter (callout 1).

**Figure 5-377** Remove top output tray paper full sensor



### Unpack the replacement assembly

Follow these steps to unpack the replacement assembly.

1. Dispose of the defective part.

---



 **NOTE:** HP recommends responsible disposal of the defective part.


<http://www8.hp.com/us/en/hp-information/environment/product-recycling.html>


---

2. Unpack the replacement part from the packaging.

---

 **CAUTION:**  Some parts are sensitive to electrostatic discharge (ESD). Always perform service work at an ESD-protected workstation or mat. If an ESD workstation or mat is not available, touch the sheet-metal chassis to provide a static ground before touching an ESD-sensitive assembly. Protect the ESD-sensitive assemblies by placing them in ESD pouches when they are out of the printer.


 **IMPORTANT:** Make sure that all of the shipping materials (for example shipping tape) are removed from the replacement part prior to installation.

 **NOTE:** If the replacement part is a roller or pad, avoid touching the spongy part of it. Skin oils on the roller or pad can cause paper pickup and/or print-quality problems. HP recommends using disposable gloves when handling rollers or pads or washing your hands before touching rollers or pads.

---

3. To install an assembly, reverse the removal steps.

---

 **NOTE:** When applicable, special installation instructions are provided for an assembly at the end of the removal procedure. Always completely read the removal instructions and follow all special installation instructions.

---


## Main exit unit

## Removal and replacement: Main exit sensor (S10)

Learn how to remove and replace the main exit sensor.

### Introduction

This document provides the procedures to remove and replace the main exit sensor for the finisher.

 **IMPORTANT:** When applicable, special installation instructions are provided for an assembly at the end of the removal procedure. Always completely read the removal instructions and follow all special installation instructions.

### Before performing service

- Turn the printer power off. A shutting-down message appears on the control-panel display.
- ⚠ **WARNING!** To avoid damage to the printer, turn the power off and wait until the printer shuts down before removing the power cable.
- Disconnect the printer power cable after the printer has completely shut down (the control-panel display is blank).
- Release the finisher from the printer by pulling out on the release latch inside the finisher door.
- Disconnect the cable from the bridge unit to the finisher.
- Disconnect the cable from the finisher to the printer.

Use the table below to identify the correct part number for your printer. To order the part, go to <https://parts.hp.com>.

**Table 5-105 Part information**

Part number	Part description
JC32-00020A	Main exit sensor

### Required tools

- #2 JIS screwdriver with a magnetic tip

### After performing service

- Connect the cable from the finisher to the printer.
- Connect the cable from the bridge unit to the finisher.
- Attach the finisher to the printer, and then push in on the release latch inside the finisher door.
- Connect the printer power cable.
- Turn the printer power on.

### Post service test

Process a job through the finisher and verify that the finisher works correctly.

### Remove the right upper cover (finisher)

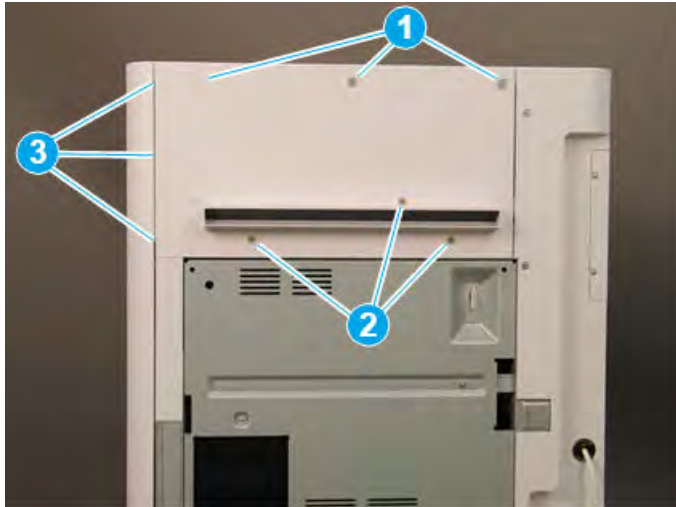
Follow these steps to remove the right upper cover (finisher).

- ▲ Remove one screw cap and three machine screws on the upper edge of the cover (callout 1). Remove three sheet metal screws (callout 2) on the lower portion of the cover. Rotate the right edge of the cover away from the finisher, and then slide the cover right to release three tabs (callout 3).

💡 **TIP:** The lower screws are shorter in length than the upper screws.

**TIP:** Reverse the removal steps to install the assembly.

Figure 5-378 Remove the right upper cover

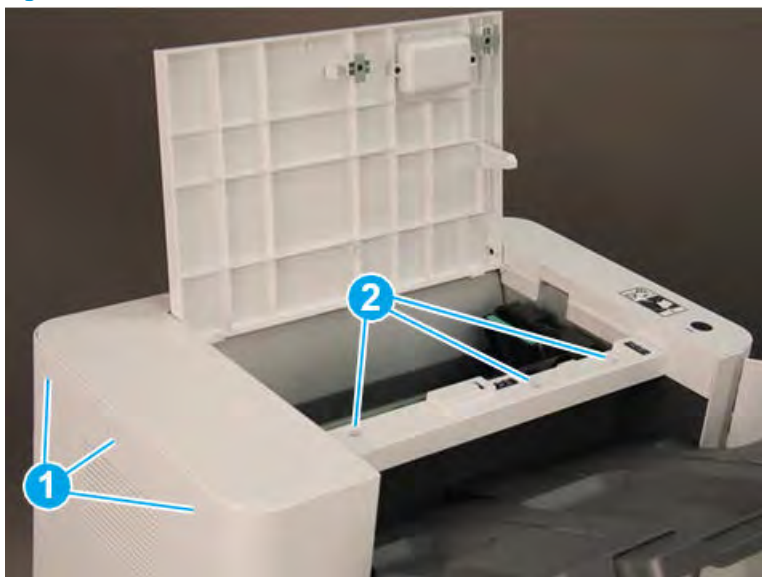


### Remove the top cover (finisher)

Follow these steps to remove the top cover (finisher).

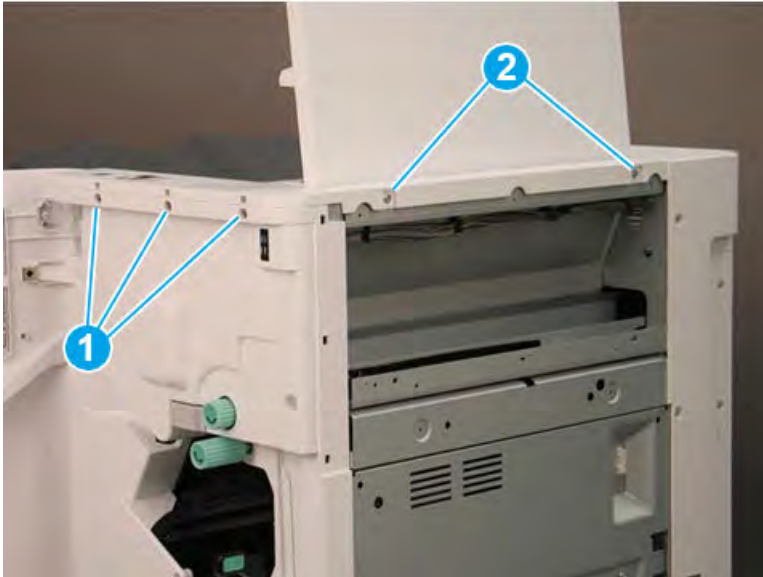
1. Remove three screw caps and three self-tapping screws at the top of the rear cover (callout 1), and then remove three machine screws (callout 2) on top of the cover.

Figure 5-379 Remove six screws




2. Remove three self-tapping screws at the top of the front cover (callout 1), and then remove two machine screws (callout 2) at the top of the right side.

**Figure 5-380** Remove five screws



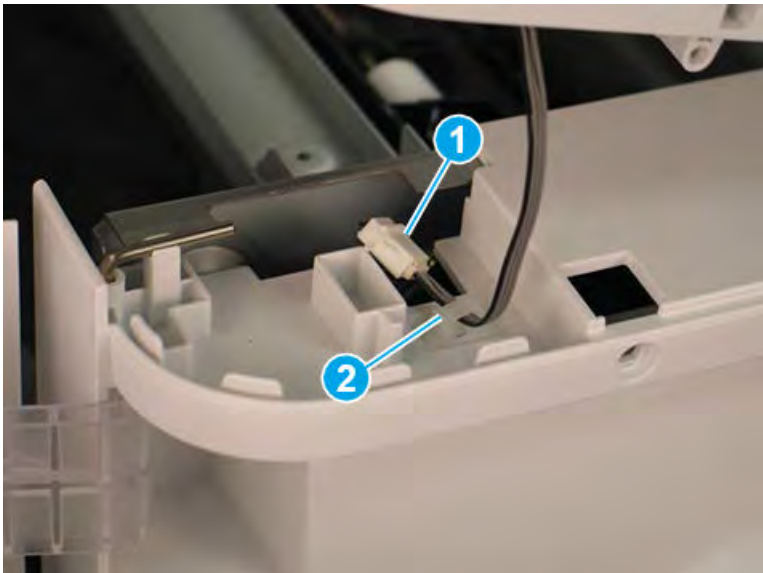
3. Lift the cover up slightly. Disconnect one in-line connector (callout 1), and then release one retainer (callout 2).

---

 **TIP:** Reverse the removal steps to install the assembly.

---

**Figure 5-381** Disconnect one connector and release retainer



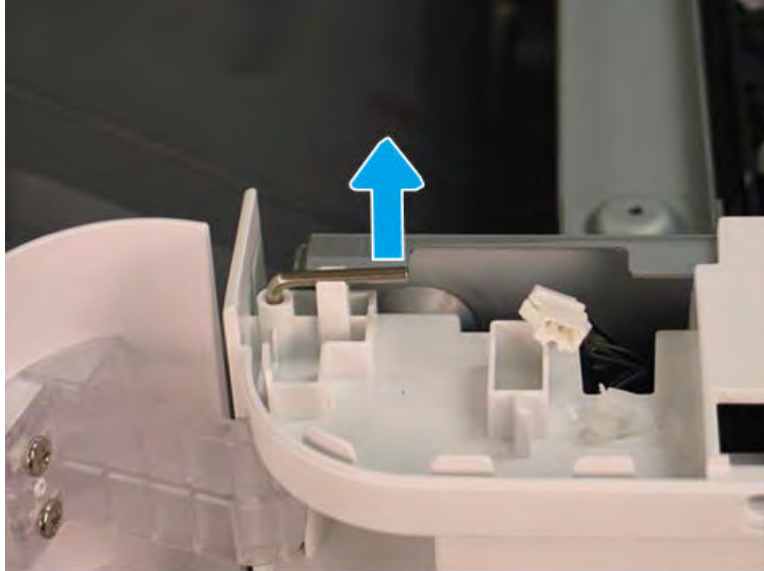
### Remove the front door (finisher)

Follow these steps to remove the front door (finisher).

1. Lift the top hinge pin up to release it from the retainer.

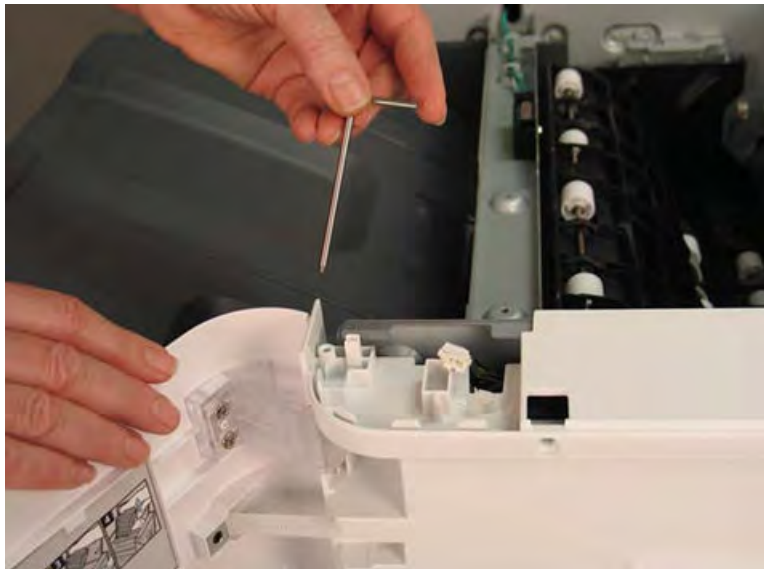


Figure 5-382 Lift the top hinge pin



2. Pull the top hinge pin up to remove it.

Figure 5-383 Remove the top hinge pin



3. Use a small, flat-blade screwdriver to release the lower hinge pin from the retainer, and then rotate it away from the finisher.

**Figure 5-384** Release the lower hinge pin




4. Support the door with one hand, and then pull the lower hinge pin straight up to remove it.

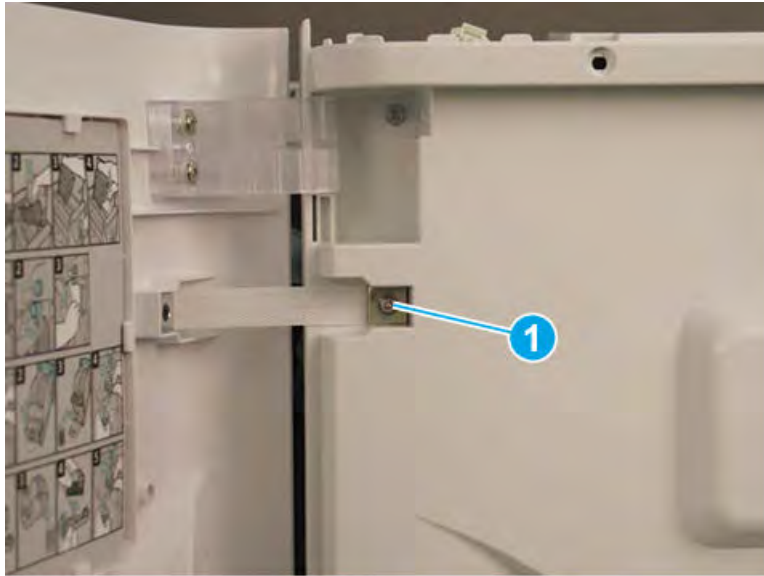
**Figure 5-385** Remove the lower hinge pin



5. Support the door with one hand, and then remove one screw (callout 1) to release the strap. Remove the front door.

 **TIP:** Reverse the removal steps to install the assembly.

**Figure 5-386** Remove the front door

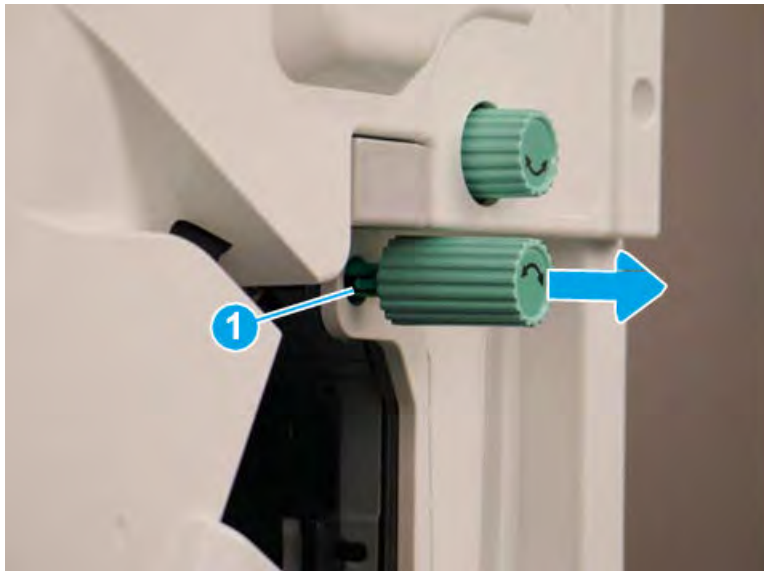


#### Remove the front cover (finisher)

Follow these steps to remove the front cover (finisher).

1. Release one tab (callout 1), and then pull the jam-access knob away from the finisher to remove it.

**Figure 5-387** Remove the jam-access knob



2. If the punch unit is installed, remove the punch waste bin (callout 1).

3. Remove one screw (callout 1) on top of the front cover.

Figure 5-388 Remove one screw



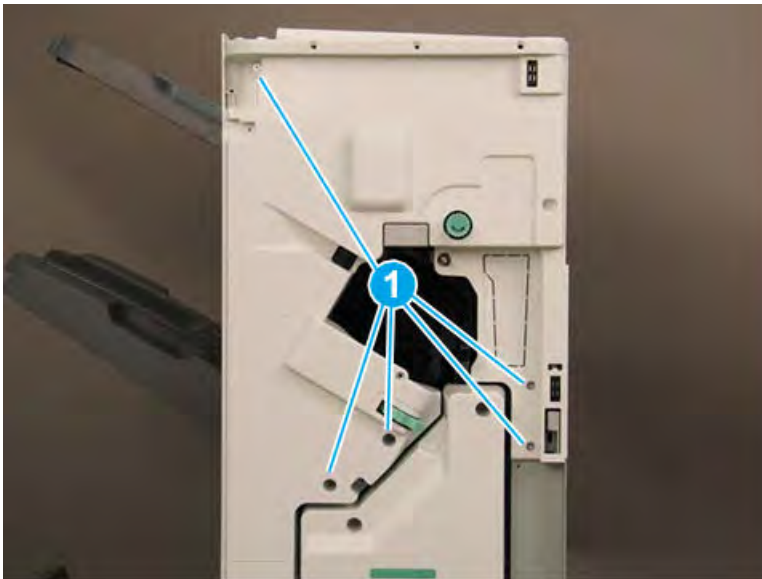
4. Remove five machine screws (callout 1), and then remove the front cover.

---

 **TIP:** Reverse the removal steps to install the assembly.

---

Figure 5-389 Remove the front cover

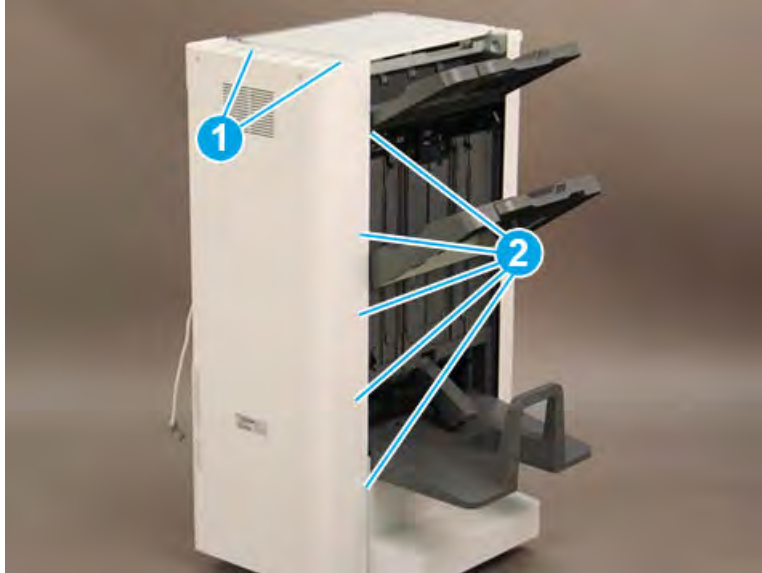


### Remove the rear cover (finisher)


Follow these steps to remove the rear cover (finisher).

1. Remove two self-tapping screws (callout 1) on the top of the rear cover, and then remove five screw caps and five machine screws (callout 2) on the left side of the cover.

Figure 5-390 Remove seven screws



2. Remove one screw cap and four machine screws (callout 1) Remove the rear cover.

 **NOTE:** Make sure to thread the power cable (callout 2) through the opening in the cover.


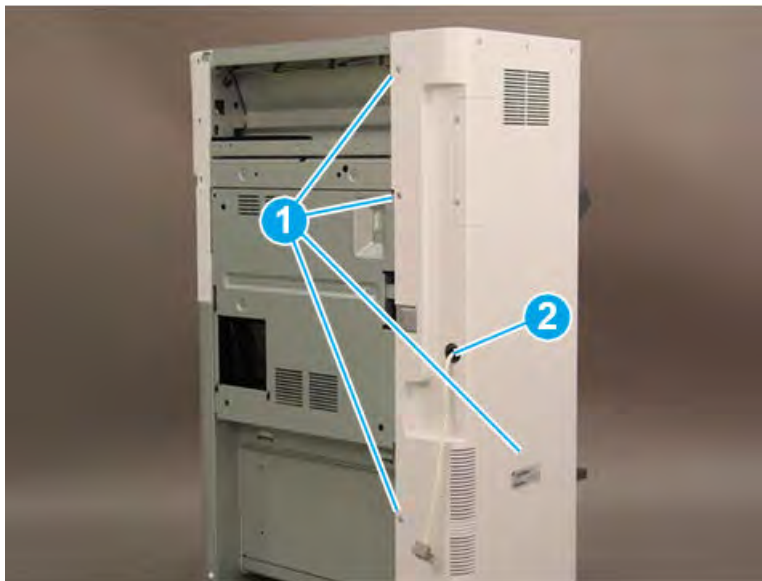
 **TIP:** Reverse the removal steps to install the assembly


Figure 5-391 Remove the rear cover



### Remove the exit motor (M13)

Follow these steps to remove the exit motor (M13).

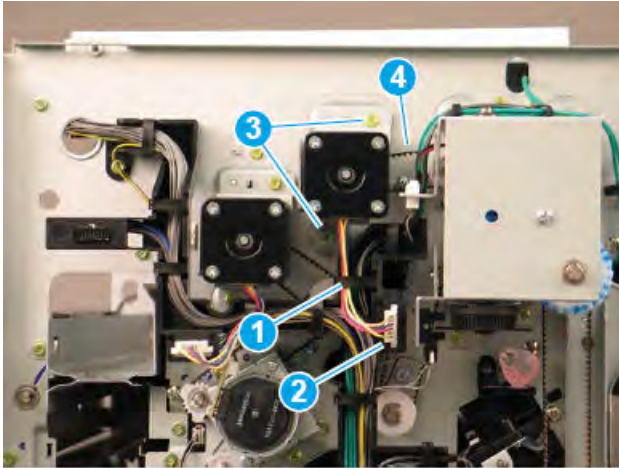
- ▲ Release one retainer (callout 1), and then disconnect one connector (callout 2). Remove two screws (callout 3), and then remove the exit motor.

 **TIP:** Make sure that the belt (callout 4) is positioned on the gear behind the motor when reinstalling the motor.

**TIP:** Reverse the removal steps to install the assembly.

---

**Figure 5-392** Remove the exit motor

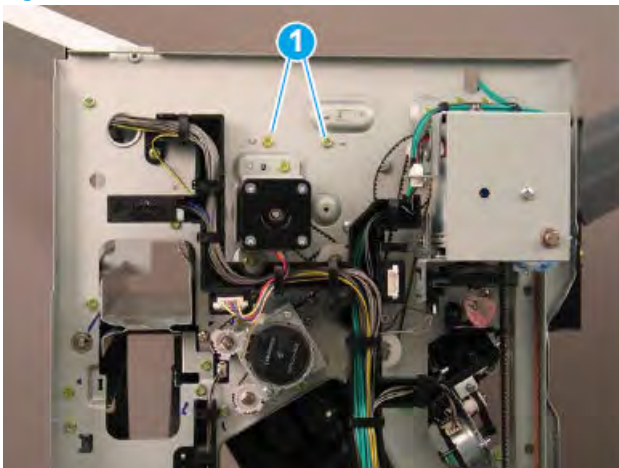


### Remove the top jam access cover


Follow these steps to remove the top jam access cover.

1. At the rear of the finisher, remove two screws (callout 1).

**Figure 5-393** Remove two screws



2. Remove the top jam access cover.

 **TIP:** Reverse the removal steps to install the assembly.

**Figure 5-394** Remove the top jam access cover

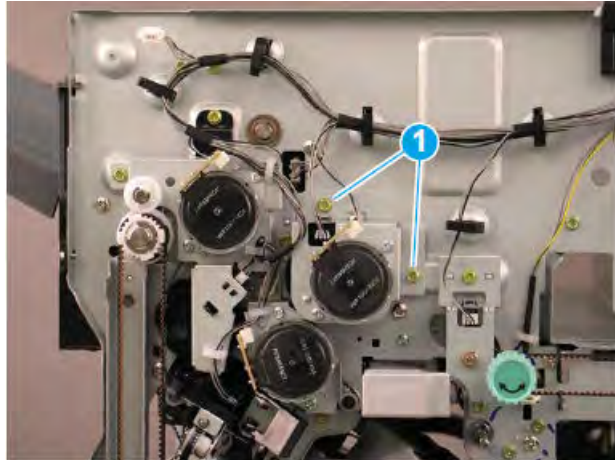


### Remove the top lower feed assembly (finisher)

Follow these steps to remove the top lower feed assembly (finisher).

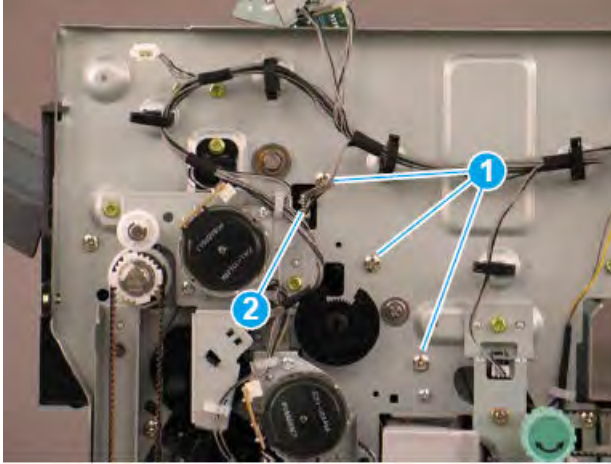
1. At the front of the printer, remove two screws (callout 1) on the main exit cam motor housing, and then tilt the motor aside to access the screws under it.

**Figure 5-395** Remove two screws



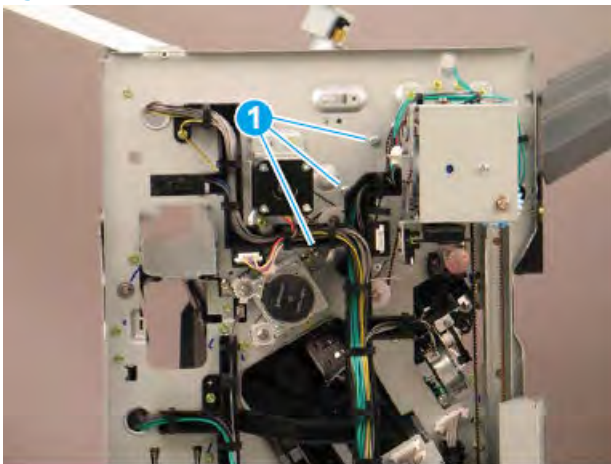
2. At the front of the finisher, remove three self-tapping screws (callout 1), and then disconnect one connector (callout 2).

**Figure 5-396** Remove three screws and disconnect one connector



3. At the rear of the finisher, remove three machine screws (callout 1).

**Figure 5-397** Remove three screws





4. At the top of the finisher, lift the feed assembly straight up to disengage two tabs on the bottom and remove the assembly.

**Figure 5-398** Remove the top lower feed assembly



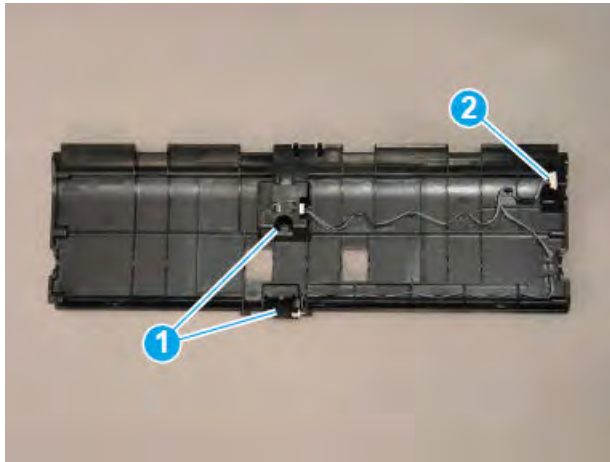
5. If you are replacing the top lower feed assembly, locate two sensors (callout 1) and one connector (callout 2) on the back of the assembly. Remove these items and transfer them to the replacement part.

---

 **TIP:** Reverse the removal steps to install the assembly.

---

**Figure 5-399** Locate sensors and connector

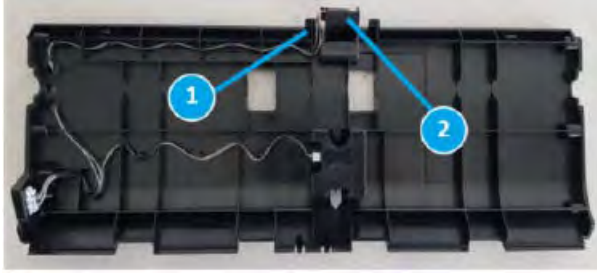


### Remove the main exit sensor(S10)

Follow these steps to remove the main exit sensor(S10).

- ▲ Remove one screw (callout 1) and main exit sensor (S10; callout 2) at the top lower feed assembly.

Figure 5-400 Remove the main exit sensor



### Unpack the replacement assembly

Follow these steps to unpack the replacement assembly.

1. Dispose of the defective part.




**NOTE:** HP recommends responsible disposal of the defective part.

<http://www8.hp.com/us/en/hp-information/environment/product-recycling.html>

2. Unpack the replacement part from the packaging.



**CAUTION:**  Some parts are sensitive to electrostatic discharge (ESD). Always perform service work at an ESD-protected workstation or mat. If an ESD workstation or mat is not available, touch the sheet-metal chassis to provide a static ground before touching an ESD-sensitive assembly. Protect the ESD-sensitive assemblies by placing them in ESD pouches when they are out of the printer.



**IMPORTANT:** Make sure that all of the shipping materials (for example shipping tape) are removed from the replacement part prior to installation.



**NOTE:** If the replacement part is a roller or pad, avoid touching the spongy part of it. Skin oils on the roller or pad can cause paper pickup and/or print-quality problems. HP recommends using disposable gloves when handling rollers or pads or washing your hands before touching rollers or pads.

3. To install an assembly, reverse the removal steps.



**NOTE:** When applicable, special installation instructions are provided for an assembly at the end of the removal procedure. Always completely read the removal instructions and follow all special installation instructions.

## Removal and replacement: Exit motor (M13)

Learn how to remove and replace the exit motor.

### Introduction

This document provides the procedures to remove and replace the exit motor on the finisher.



**IMPORTANT:** When applicable, special installation instructions are provided for an assembly at the end of the removal procedure. Always completely read the removal instructions and follow all special installation instructions.

### Before performing service

- Turn the printer power off. A shutting-down message appears on the control-panel display.
- ⚠ **WARNING!** To avoid damage to the printer, turn the power off and wait until the printer shuts down before removing the power cable.
- Disconnect the printer power cable after the printer has completely shut down (the control-panel display is blank).
- Release the finisher from the printer by pulling out on the release latch inside the finisher door.
- Disconnect the cable from the bridge unit to the finisher.
- Disconnect the cable from the finisher to the printer.

Use the table below to identify the correct part number for your printer. To order the part, go to <https://parts.hp.com>.

**Table 5-106 Part information**

Part number	Part description
JC90-01459A	Exit motor assembly

### Required tools

- #2 JIS screwdriver with a magnetic tip

### After performing service

- Connect the cable from the finisher to the printer.
- Connect the cable from the bridge unit to the finisher.
- Attach the finisher to the printer, and then push in on the release latch inside the finisher door.
- Connect the printer power cable.
- Turn the printer power on.

### Post service test

Process a job through the finisher and verify that the finisher works correctly.

### Remove the right upper cover (finisher)

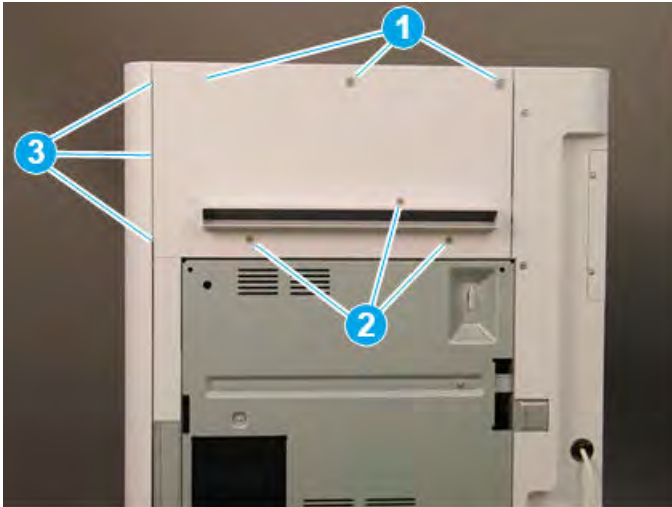
Follow these steps to remove the right upper cover (finisher).

- ▲ Remove one screw cap and three machine screws on the upper edge of the cover (callout 1). Remove three sheet metal screws (callout 2) on the lower portion of the cover. Rotate the right edge of the cover away from the finisher, and then slide the cover right to release three tabs (callout 3).

💡 **TIP:** The lower screws are shorter in length than the upper screws.

**TIP:** Reverse the removal steps to install the assembly.

**Figure 5-401** Remove the right upper cover

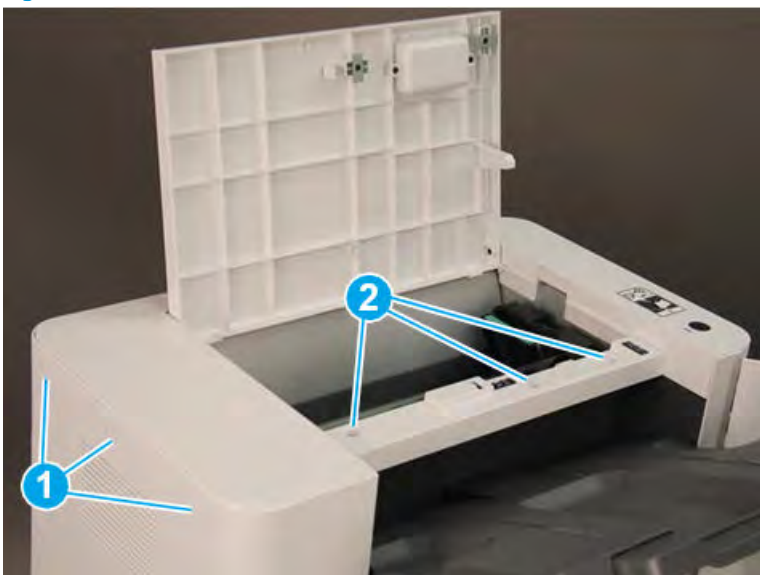


### Remove the top cover (finisher)

Follow these steps to remove the top cover (finisher).

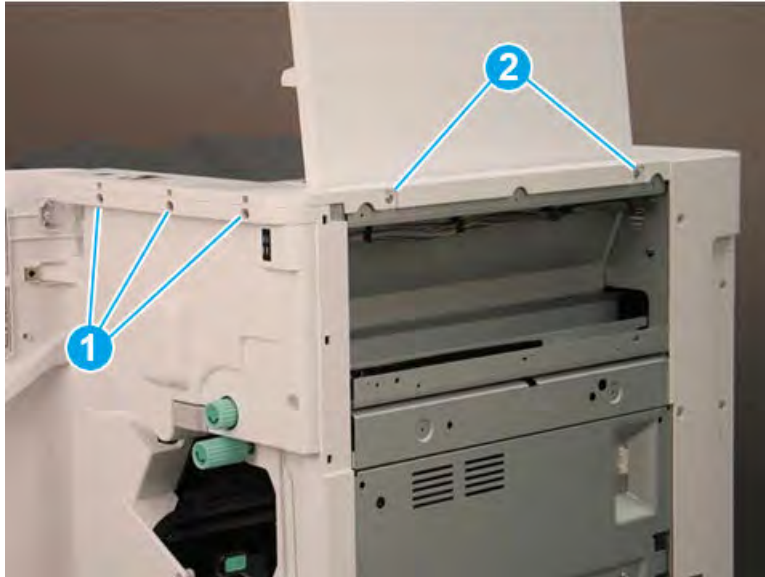
1. Remove three screw caps and three self-tapping screws at the top of the rear cover (callout 1), and then remove three machine screws (callout 2) on top of the cover.

**Figure 5-402** Remove six screws




2. Remove three self-tapping screws at the top of the front cover (callout 1), and then remove two machine screws (callout 2) at the top of the right side.

Figure 5-403 Remove five screws



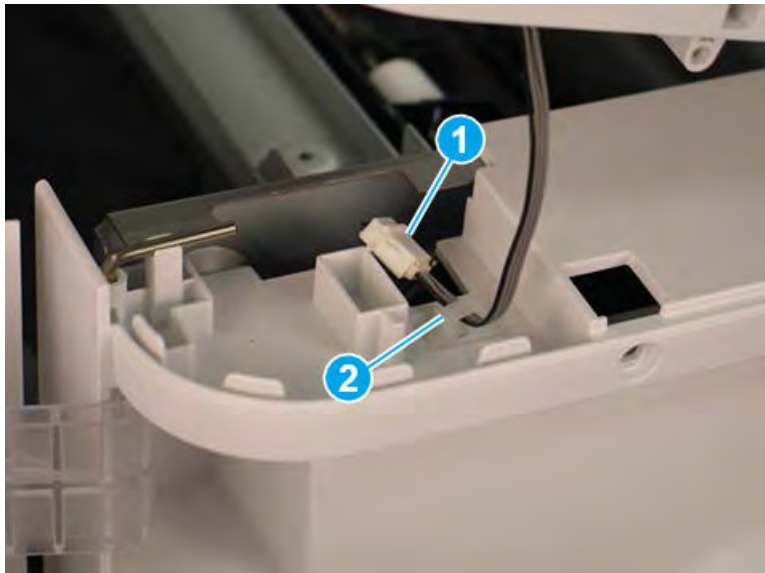
3. Lift the cover up slightly. Disconnect one in-line connector (callout 1), and then release one retainer (callout 2).

---

 **TIP:** Reverse the removal steps to install the assembly.

---

Figure 5-404 Disconnect one connector and release retainer



### Remove the rear cover (finisher)

Follow these steps to remove the rear cover (finisher).

1. Remove two self-tapping screws (callout 1) on the top of the rear cover, and then remove five screw caps and five machine screws (callout 2) on the left side of the cover.

Figure 5-405 Remove seven screws

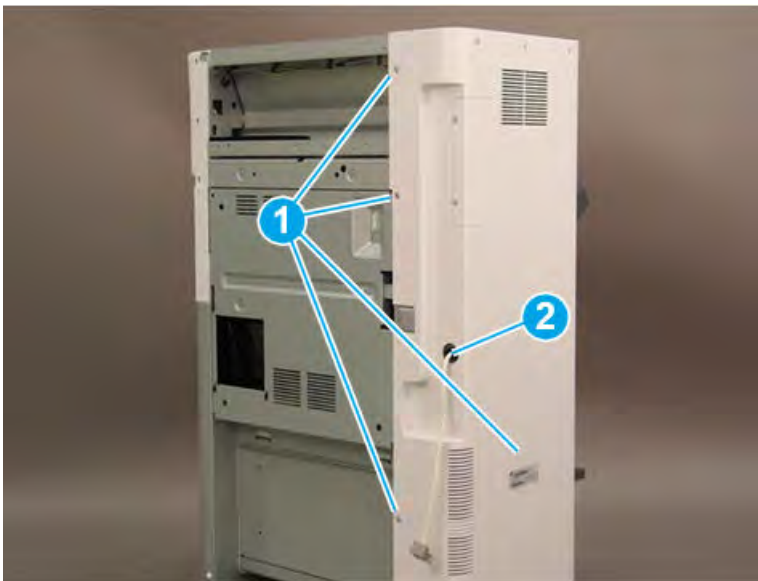


2. Remove one screw cap and four machine screws (callout 1) Remove the rear cover.

 **NOTE:** Make sure to thread the power cable (callout 2) through the opening in the cover.

 **TIP:** Reverse the removal steps to install the assembly


Figure 5-406 Remove the rear cover



### Remove the exit motor (M13)

Follow these steps to remove the exit motor (M13).

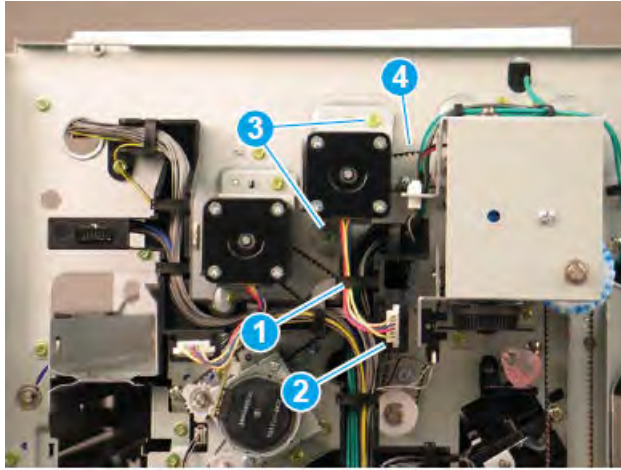
- ▲ Release one retainer (callout 1), and then disconnect one connector (callout 2). Remove two screws (callout 3), and then remove the exit motor.

 **TIP:** Make sure that the belt (callout 4) is positioned on the gear behind the motor when reinstalling the motor.

**TIP:** Reverse the removal steps to install the assembly.

---

**Figure 5-407** Remove the exit motor



### Unpack the replacement assembly

Follow these steps to unpack the replacement assembly.

1. Dispose of the defective part.




**NOTE:** HP recommends responsible disposal of the defective part.

<http://www8.hp.com/us/en/hp-information/environment/product-recycling.html>

---

2. Unpack the replacement part from the packaging.



**CAUTION:**  Some parts are sensitive to electrostatic discharge (ESD). Always perform service work at an ESD-protected workstation or mat. If an ESD workstation or mat is not available, touch the sheet-metal chassis to provide a static ground before touching an ESD-sensitive assembly. Protect the ESD-sensitive assemblies by placing them in ESD pouches when they are out of the printer.



**IMPORTANT:** Make sure that all of the shipping materials (for example shipping tape) are removed from the replacement part prior to installation.



**NOTE:** If the replacement part is a roller or pad, avoid touching the spongy part of it. Skin oils on the roller or pad can cause paper pickup and/or print-quality problems. HP recommends using disposable gloves when handling rollers or pads or washing your hands before touching rollers or pads.

---

3. To install an assembly, reverse the removal steps.



**NOTE:** When applicable, special installation instructions are provided for an assembly at the end of the removal procedure. Always completely read the removal instructions and follow all special installation instructions.


---

## Removal and replacement: Main exit cam motor (M2)


Learn how to remove and replace the main exit cam motor.

### Introduction

This document provides the procedures to remove and replace the main exit cam motor on the finisher.

 **IMPORTANT:** When applicable, special installation instructions are provided for an assembly at the end of the removal procedure. Always completely read the removal instructions and follow all special installation instructions.

### Before performing service

- Turn the printer power off. A shutting-down message appears on the control-panel display.
-  **WARNING!** To avoid damage to the printer, turn the power off and wait until the printer shuts down before removing the power cable.
- Disconnect the printer power cable after the printer has completely shut down (the control-panel display is blank).
- Release the finisher from the printer by pulling out on the release latch inside the finisher door.
- Disconnect the cable from the bridge unit to the finisher.
- Disconnect the cable from the finisher to the printer.

Use the table below to identify the correct part number for your printer. To order the part, go to <https://parts.hp.com>.

**Table 5-107 Part information**

Part number	Part description
JC90-01453A	Main exit cam motor assembly

### Required tools

- #2 JIS screwdriver with a magnetic tip
- Small, flat-blade screwdriver

### After performing service

- Connect the cable from the finisher to the printer.
- Connect the cable from the bridge unit to the finisher.
- Attach the finisher to the printer, and then push in on the release latch inside the finisher door.
- Connect the printer power cable.
- Turn the printer power on.

### Post service test

Process a job through the finisher and verify that the finisher works correctly.



### Remove the right upper cover (finisher)

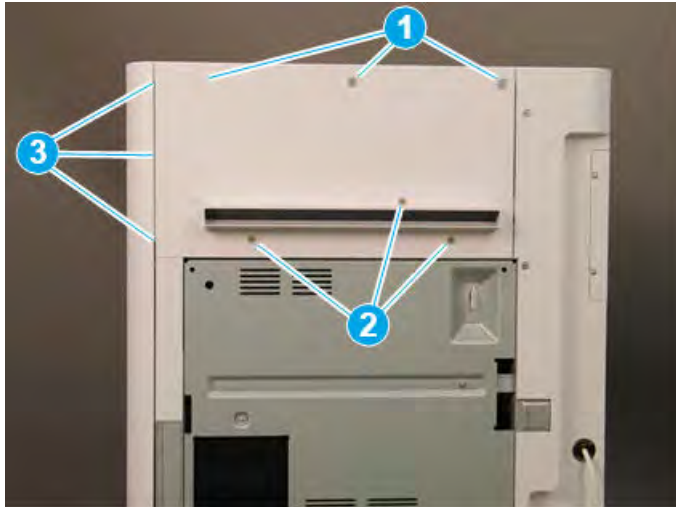
Follow these steps to remove the right upper cover (finisher).

- ▲ Remove one screw cap and three machine screws on the upper edge of the cover (callout 1). Remove three sheet metal screws (callout 2) on the lower portion of the cover. Rotate the right edge of the cover away from the finisher, and then slide the cover right to release three tabs (callout 3).

💡 **TIP:** The lower screws are shorter in length than the upper screws.

**TIP:** Reverse the removal steps to install the assembly.

Figure 5-408 Remove the right upper cover

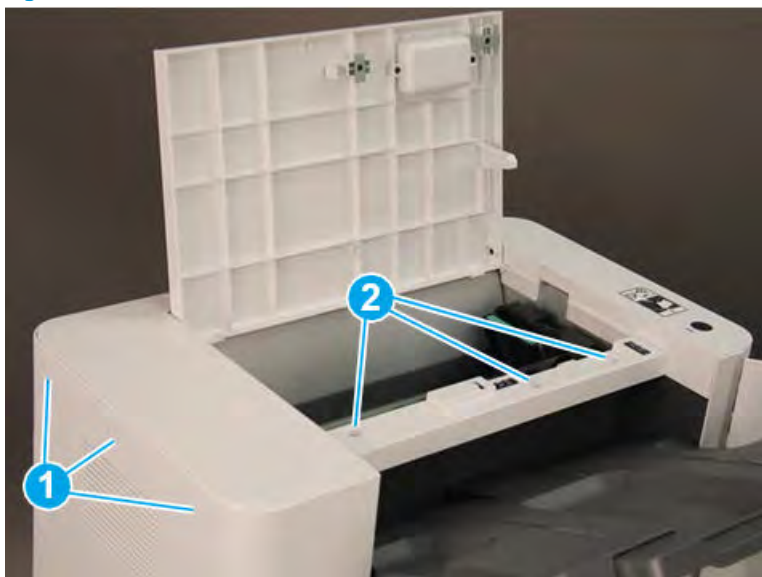


### Remove the top cover (finisher)

Follow these steps to remove the top cover (finisher).

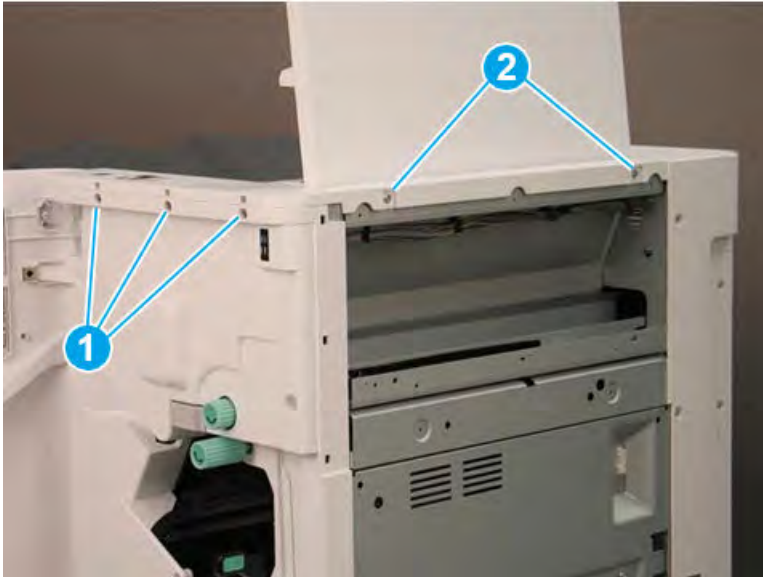
1. Remove three screw caps and three self-tapping screws at the top of the rear cover (callout 1), and then remove three machine screws (callout 2) on top of the cover.

Figure 5-409 Remove six screws




2. Remove three self-tapping screws at the top of the front cover (callout 1), and then remove two machine screws (callout 2) at the top of the right side.

Figure 5-410 Remove five screws



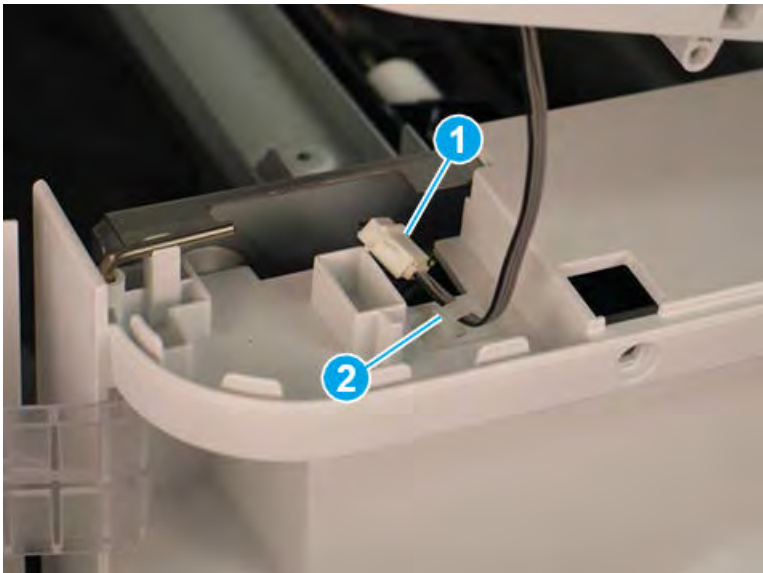
3. Lift the cover up slightly. Disconnect one in-line connector (callout 1), and then release one retainer (callout 2).

---

 **TIP:** Reverse the removal steps to install the assembly.

---

Figure 5-411 Disconnect one connector and release retainer

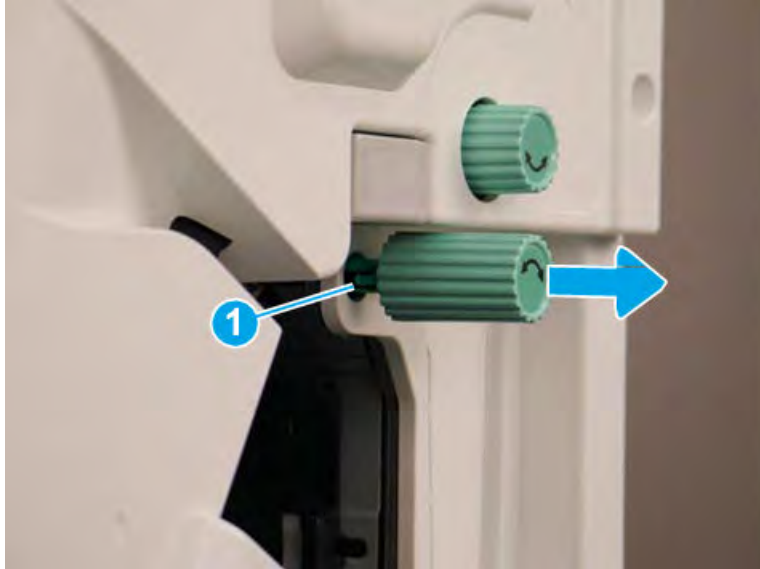


### Remove the front cover (finisher)

Follow these steps to remove the front cover (finisher).

1. Release one tab (callout 1), and then pull the jam-access knob away from the finisher to remove it.

Figure 5-412 Remove the jam-access knob




2. If the punch unit is installed, remove the punch waste bin (callout 1).
3. Remove one screw (callout 1) on top of the front cover.

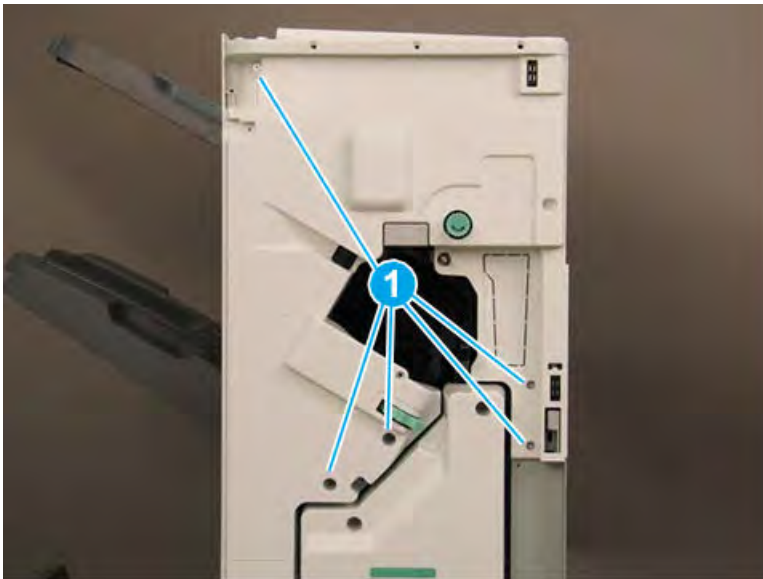
Figure 5-413 Remove one screw



4. Remove five machine screws (callout 1), and then remove the front cover.

 **TIP:** Reverse the removal steps to install the assembly.

**Figure 5-414** Remove the front cover

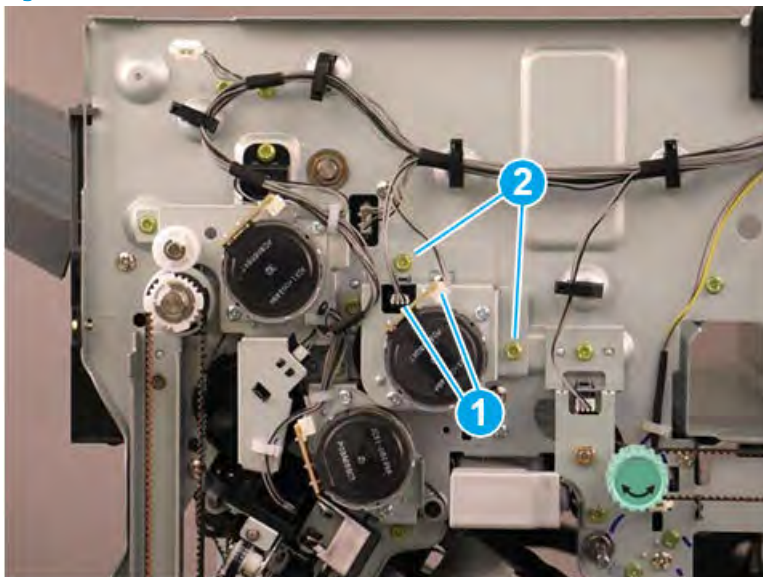


#### Remove the Main exit cam motor (M2)

Follow these steps to remove the Main exit cam motor (M2).

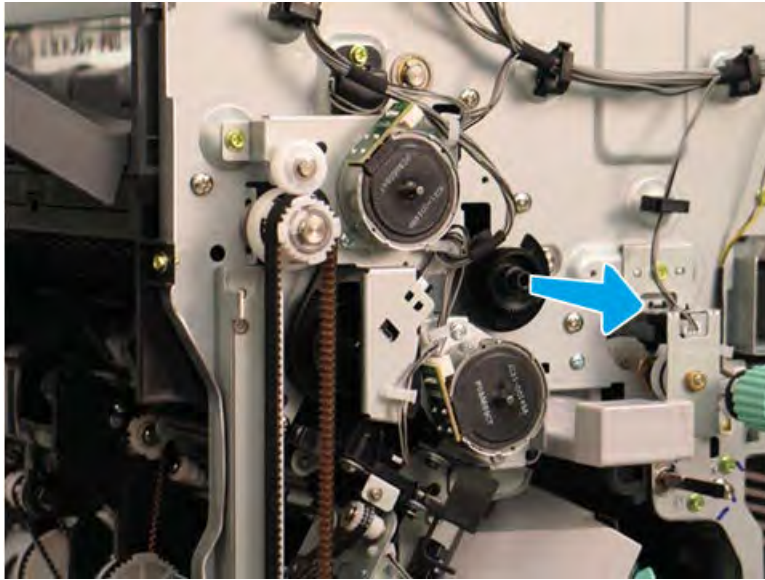
1. Disconnect two connectors (callout 1), and then remove two screws (callout 2).

**Figure 5-415** Disconnect two connectors and then two screws



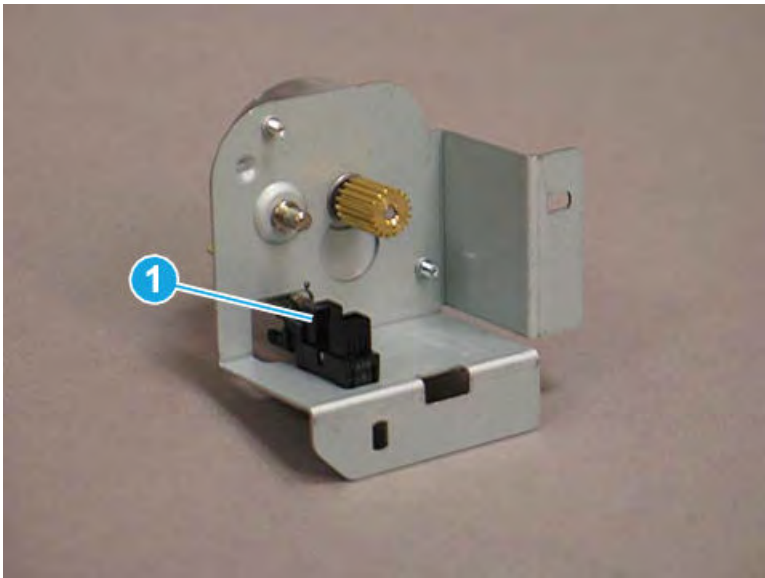
2. If you are replacing the gear, slide it off of the shaft

Figure 5-416 Slide the gear off of the shaft

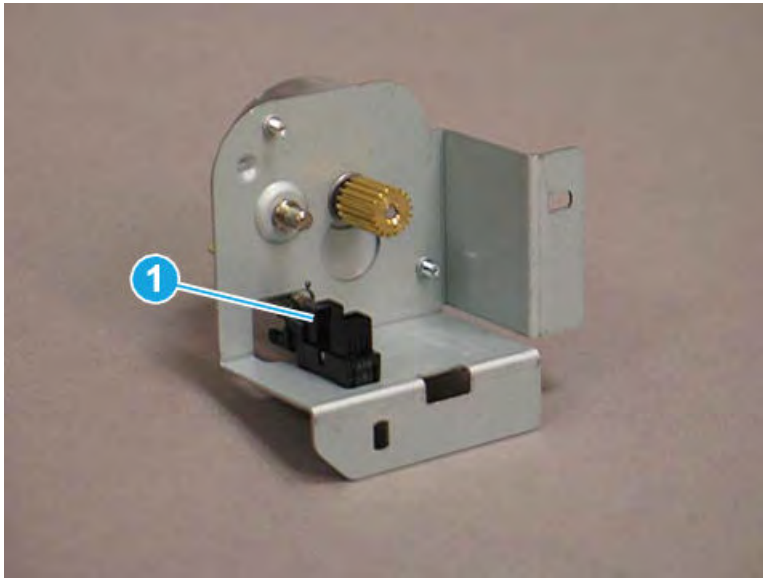


3. If you are replacing the sensor (callout 1), remove it from the motor housing.

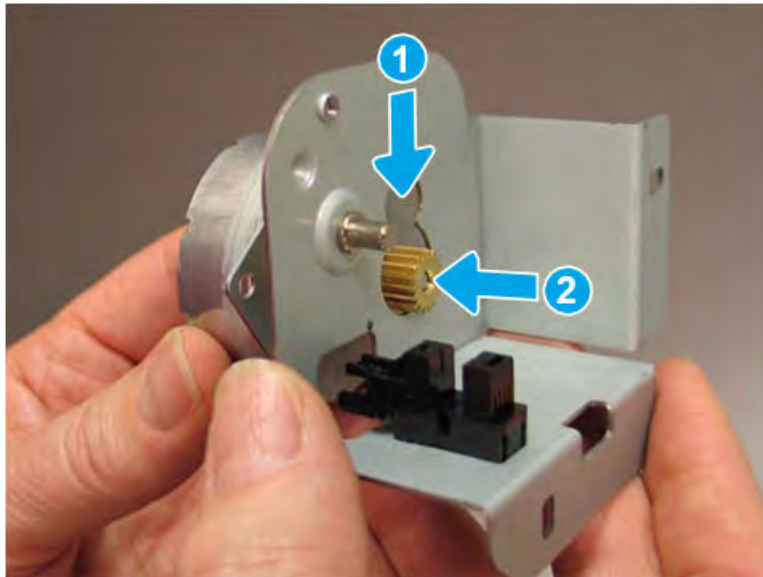
Figure 5-417 Remove the sensor



4. If you are replacing the motor, do the following.
  - a. Remove two screws (callout 1)



- b. Lower the motor (callout 1) and then pull it away from the housing (callout 2) to remove it.



### Unpack the replacement assembly

Follow these steps to unpack the replacement assembly.

1. Dispose of the defective part.



---


 **NOTE:** HP recommends responsible disposal of the defective part.


<http://www8.hp.com/us/en/hp-information/environment/product-recycling.html>

---

2. Unpack the replacement part from the packaging.


 **CAUTION:**  Some parts are sensitive to electrostatic discharge (ESD). Always perform service work at an ESD-protected workstation or mat. If an ESD workstation or mat is not available, touch the sheet-metal chassis to provide a static ground before touching an ESD-sensitive assembly. Protect the ESD-sensitive assemblies by placing them in ESD pouches when they are out of the printer.

 **IMPORTANT:** Make sure that all of the shipping materials (for example shipping tape) are removed from the replacement part prior to installation.

 **NOTE:** If the replacement part is a roller or pad, avoid touching the spongy part of it. Skin oils on the roller or pad can cause paper pickup and/or print-quality problems. HP recommends using disposable gloves when handling rollers or pads or washing your hands before touching rollers or pads.

---

3. To install an assembly, reverse the removal steps.

 **NOTE:** When applicable, special installation instructions are provided for an assembly at the end of the removal procedure. Always completely read the removal instructions and follow all special installation instructions.

---

## Paddle unit




## Removal and replacement: Paddle

Learn how to remove and replace the paddle.

### Introduction

This document provides the procedures to remove and replace the paddle for the finisher.

 **IMPORTANT:** When applicable, special installation instructions are provided for an assembly at the end of the removal procedure. Always completely read the removal instructions and follow all special installation instructions.

### Before performing service

- Turn the printer power off. A shutting-down message appears on the control-panel display.
- ⚠ **WARNING!** To avoid damage to the printer, turn the power off and wait until the printer shuts down before removing the power cable.
- Disconnect the printer power cable after the printer has completely shut down (the control-panel display is blank).
- Release the finisher from the printer by pulling out on the release latch inside the finisher door.
- Disconnect the cable from the bridge unit to the finisher.
- Disconnect the cable from the finisher to the printer.

Use the table below to identify the correct part number for your printer. To order the part, go to <https://parts.hp.com>.

**Table 5-108** Part information

Part number	Part description
JC90-01462A	Paddle mid
JC90-01463A	Paddle wing

### Required tools

- #2 JIS screwdriver with a magnetic tip

### After performing service

- Connect the cable from the finisher to the printer.
- Connect the cable from the bridge unit to the finisher.
- Attach the finisher to the printer, and then push in on the release latch inside the finisher door.
- Connect the printer power cable.
- Turn the printer power on.

### Post service test

Process a job through the finisher and verify that the finisher works correctly.

### Remove the right upper cover (finisher)

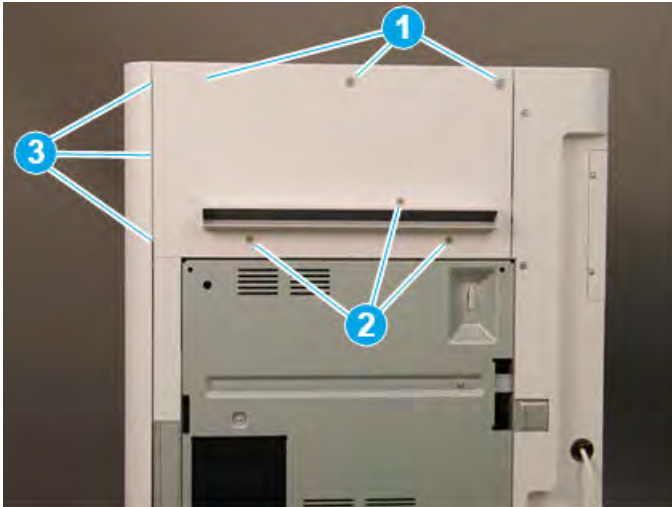
Follow these steps to remove the right upper cover (finisher).

- ▲ Remove one screw cap and three machine screws on the upper edge of the cover (callout 1). Remove three sheet metal screws (callout 2) on the lower portion of the cover. Rotate the right edge of the cover away from the finisher, and then slide the cover right to release three tabs (callout 3).

💡 **TIP:** The lower screws are shorter in length than the upper screws.

**TIP:** Reverse the removal steps to install the assembly.

**Figure 5-418** Remove the right upper cover

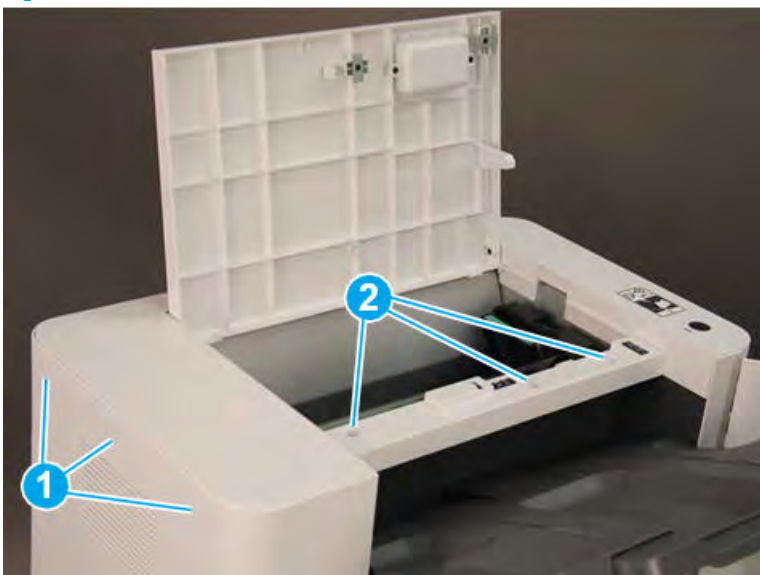


### Remove the top cover (finisher)

Follow these steps to remove the top cover (finisher).

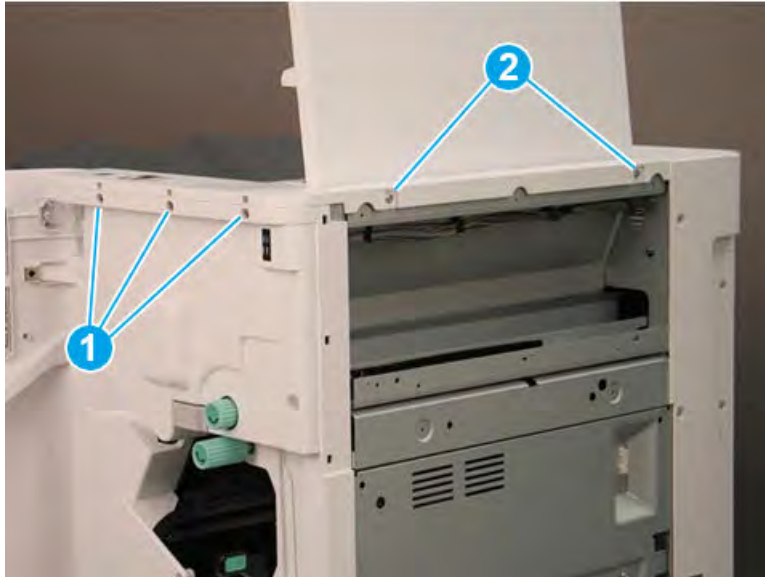
1. Remove three screw caps and three self-tapping screws at the top of the rear cover (callout 1), and then remove three machine screws (callout 2) on top of the cover.

**Figure 5-419** Remove six screws




2. Remove three self-tapping screws at the top of the front cover (callout 1), and then remove two machine screws (callout 2) at the top of the right side.

Figure 5-420 Remove five screws



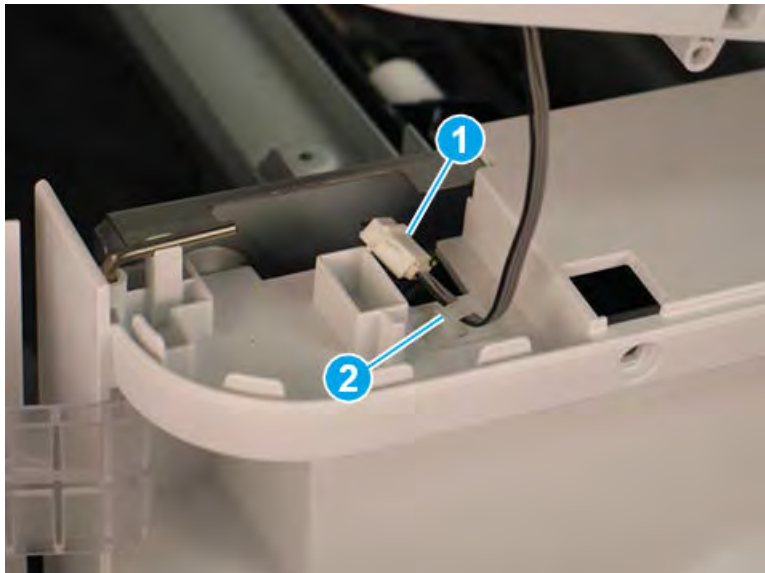
3. Lift the cover up slightly. Disconnect one in-line connector (callout 1), and then release one retainer (callout 2).

---

 **TIP:** Reverse the removal steps to install the assembly.

---

Figure 5-421 Disconnect one connector and release retainer

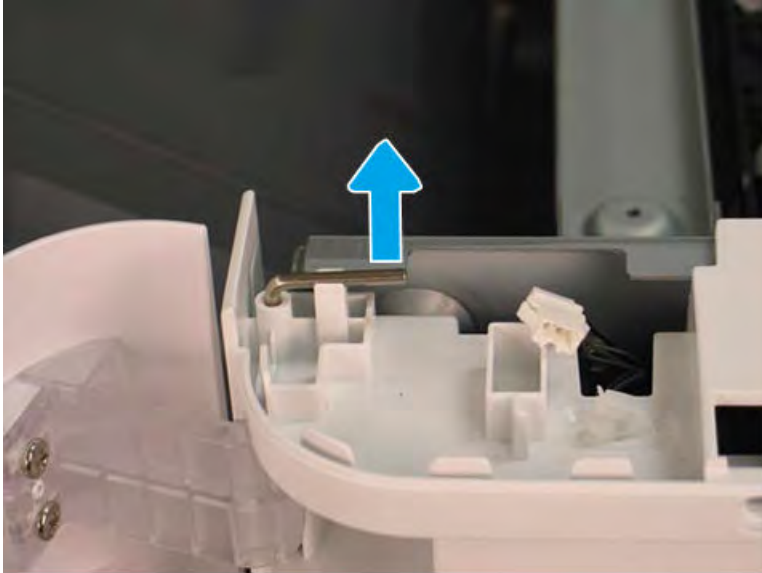


### Remove the front door (finisher)

Follow these steps to remove the front door (finisher).

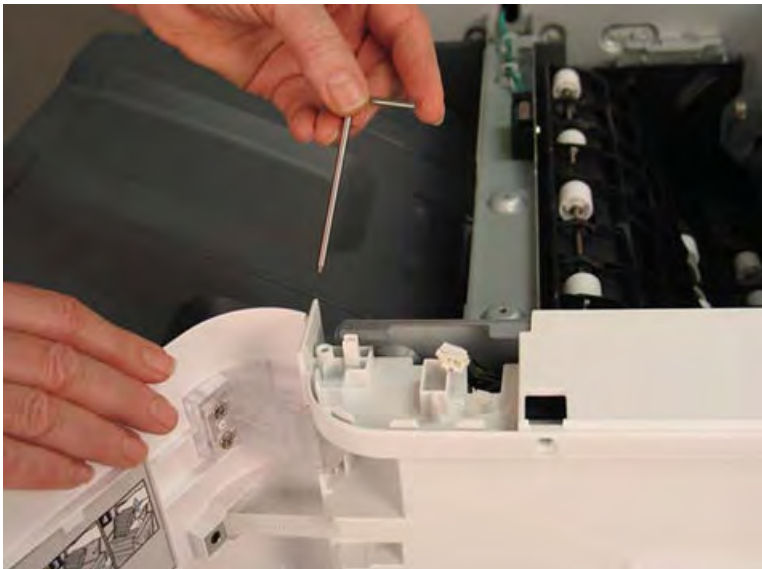
1. Lift the top hinge pin up to release it from the retainer.

Figure 5-422 Lift the top hinge pin



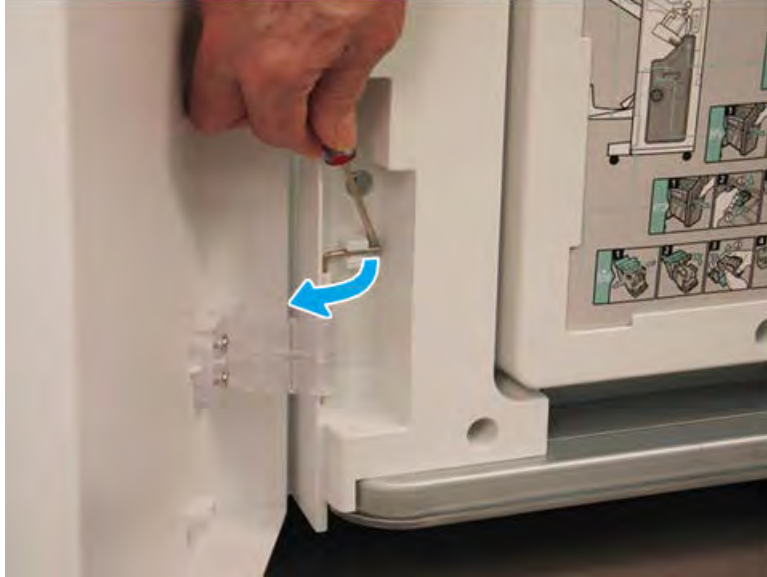
2. Pull the top hinge pin up to remove it.

Figure 5-423 Remove the top hinge pin



3. Use a small, flat-blade screwdriver to release the lower hinge pin from the retainer, and then rotate it away from the finisher.

Figure 5-424 Release the lower hinge pin




4. Support the door with one hand, and then pull the lower hinge pin straight up to remove it.

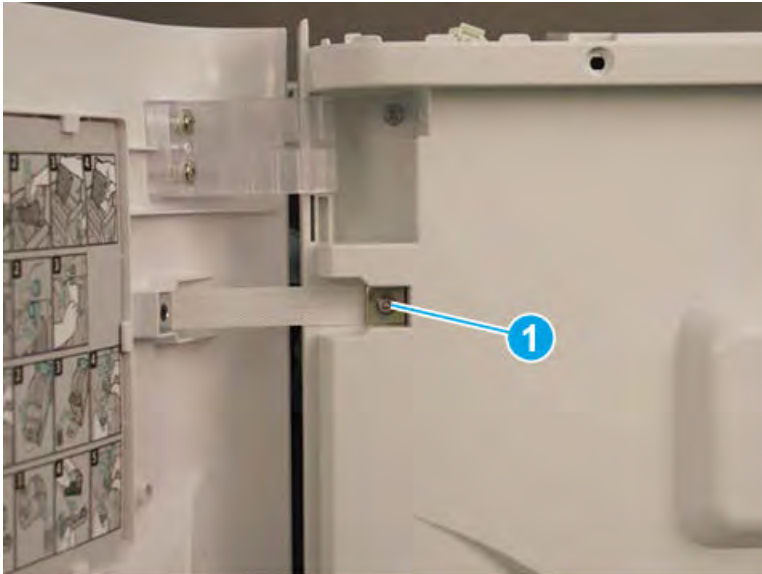
Figure 5-425 Remove the lower hinge pin



5. Support the door with one hand, and then remove one screw (callout 1) to release the strap. Remove the front door.

 **TIP:** Reverse the removal steps to install the assembly.

**Figure 5-426** Remove the front door

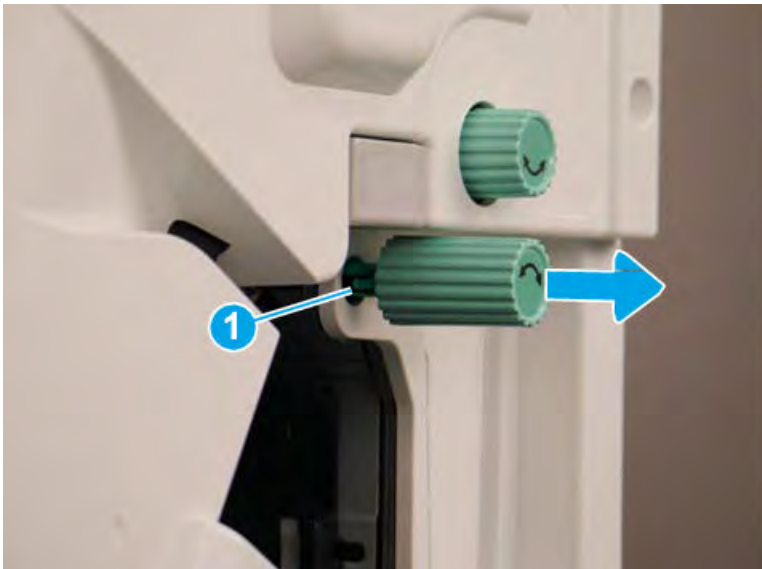


#### Remove the front cover (finisher)

Follow these steps to remove the front cover (finisher).

1. Release one tab (callout 1), and then pull the jam-access knob away from the finisher to remove it.

**Figure 5-427** Remove the jam-access knob



2. If the punch unit is installed, remove the punch waste bin (callout 1).


3. Remove one screw (callout 1) on top of the front cover.

Figure 5-428 Remove one screw



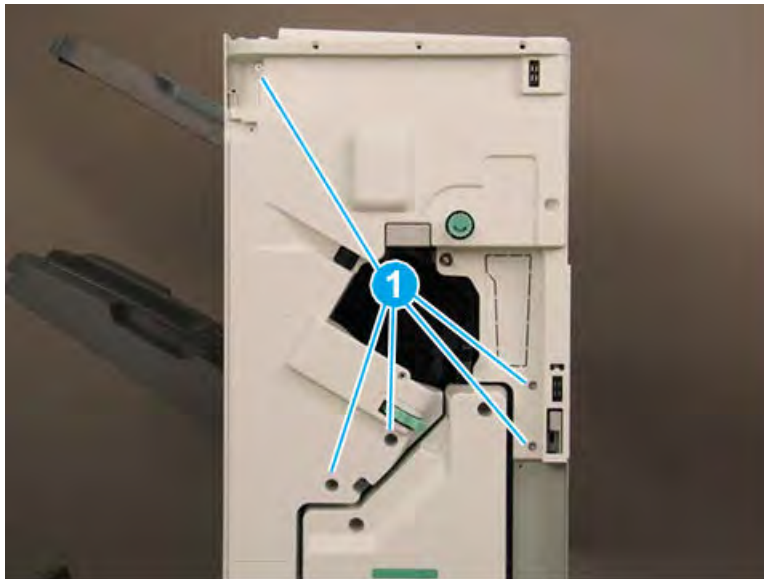
4. Remove five machine screws (callout 1), and then remove the front cover.

---

 **TIP:** Reverse the removal steps to install the assembly.

---

Figure 5-429 Remove the front cover

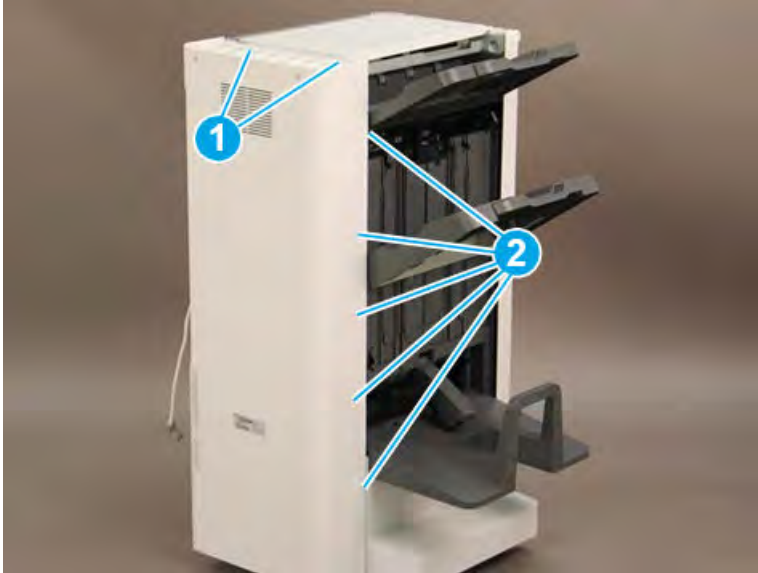


### Remove the rear cover (finisher)

Follow these steps to remove the rear cover (finisher).

1. Remove two self-tapping screws (callout 1) on the top of the rear cover, and then remove five screw caps and five machine screws (callout 2) on the left side of the cover.

Figure 5-430 Remove seven screws

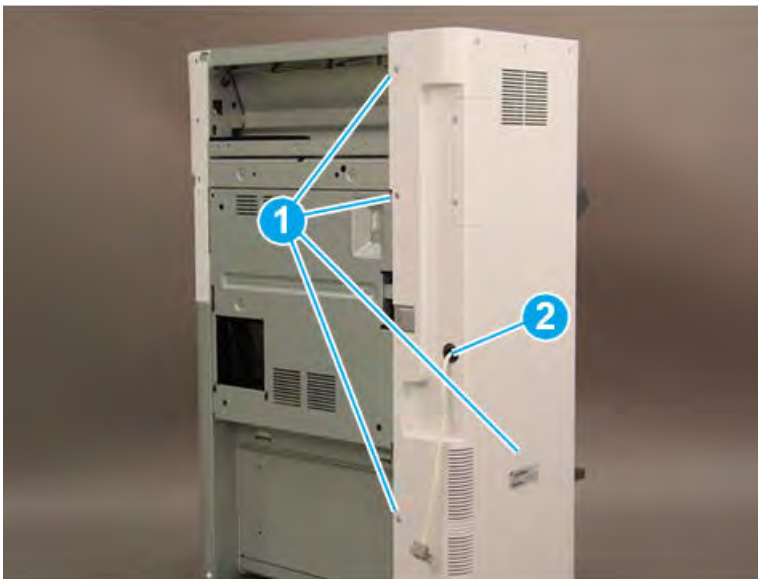


2. Remove one screw cap and four machine screws (callout 1) Remove the rear cover.

 **NOTE:** Make sure to thread the power cable (callout 2) through the opening in the cover.

 **TIP:** Reverse the removal steps to install the assembly

Figure 5-431 Remove the rear cover



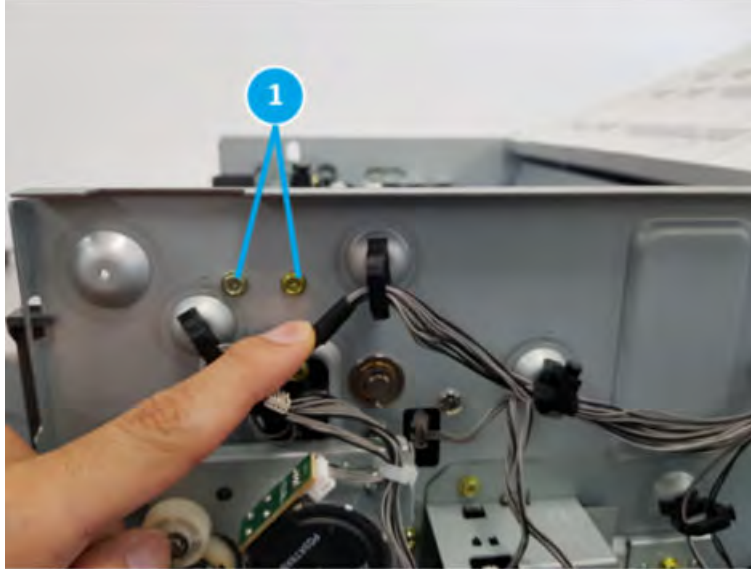
### Remove the paddle (finisher)

Follow these steps to remove the paddle (finisher).

1. At the front of the finisher, remove two screws (callout 1).



Figure 5-432 Remove two screws



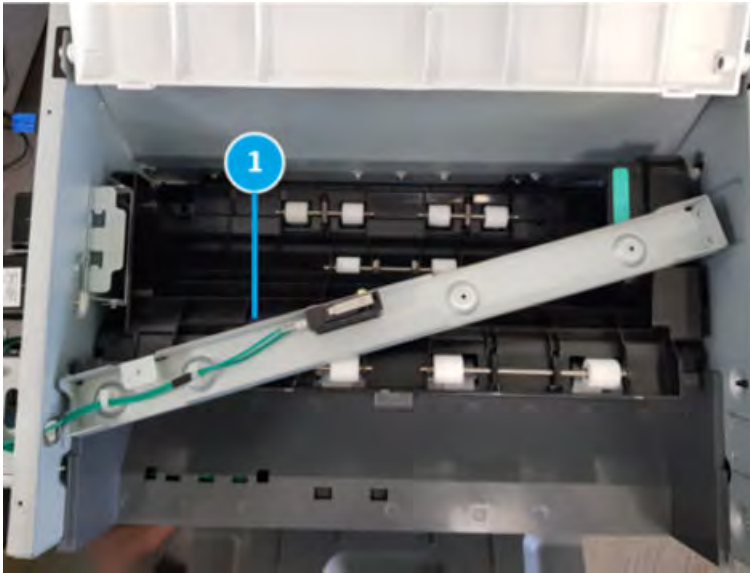
2. At the rear of the finisher, remove two screws (callout 1).

Figure 5-433 Remove two screws



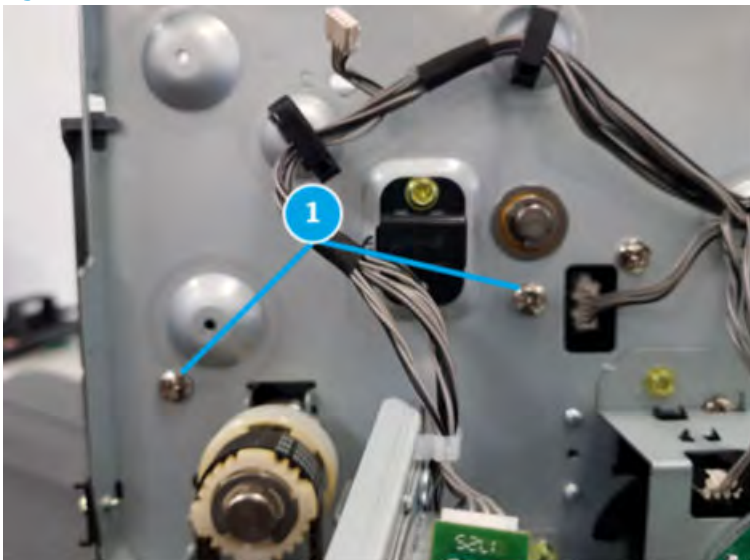
3. Do not remove the frame (callout 1) but pull it one side.

Figure 5-434 Pull it one side



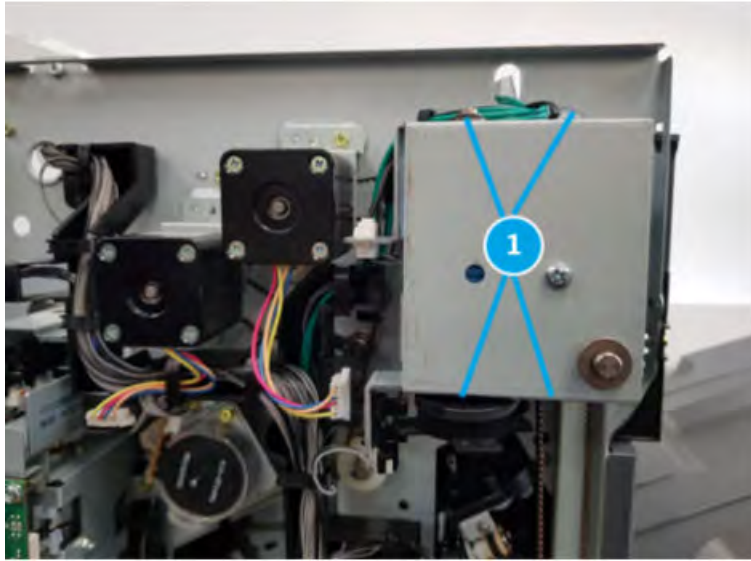
4. At the front of the finisher, remove two screws (callout 1)

Figure 5-435 Remove two screws



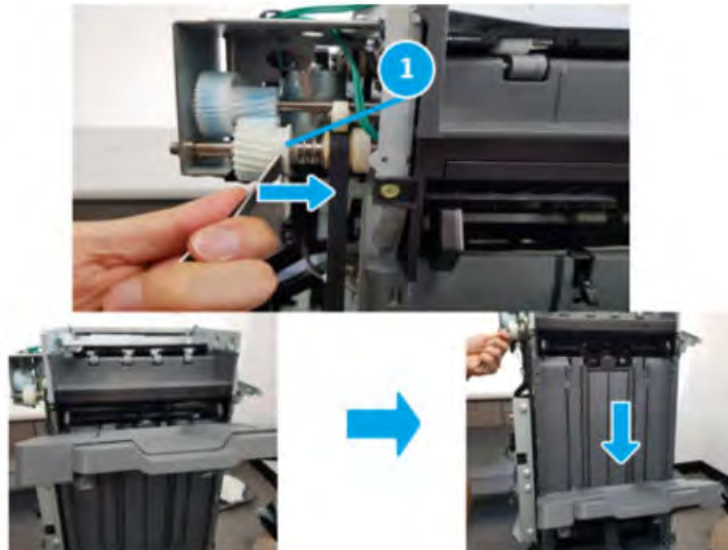
5. At the rear of the finisher, remove four screws (callout 1).

Figure 5-436 Remove four screws



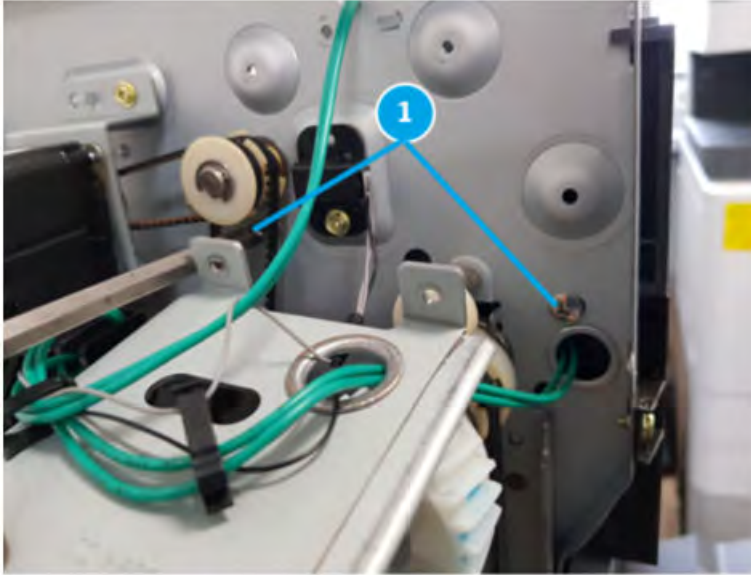
6. Bring the lower output tray down by positioning the shaft of a screwdriver or tweezers on the clutch (callout 1) and gently pressing to the right to release the clutch. Hold the clutch in the released position and lower the tray (callout 2) to the lowest position.(S11)

Figure 5-437 Pressing to the right to release the clutch



7. At the rear of the finisher, remove two screws (callout 1).

Figure 5-438 Remove two screws



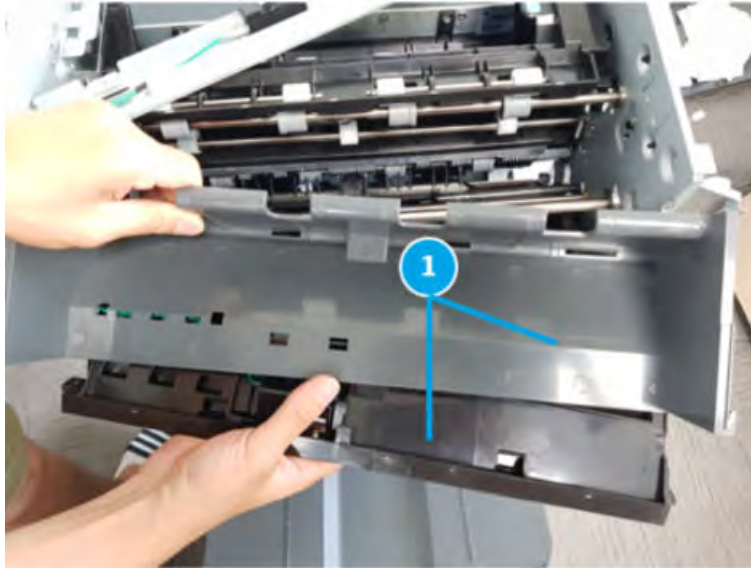
8. Remove two screws (callout 1)

Figure 5-439 Remove two screws



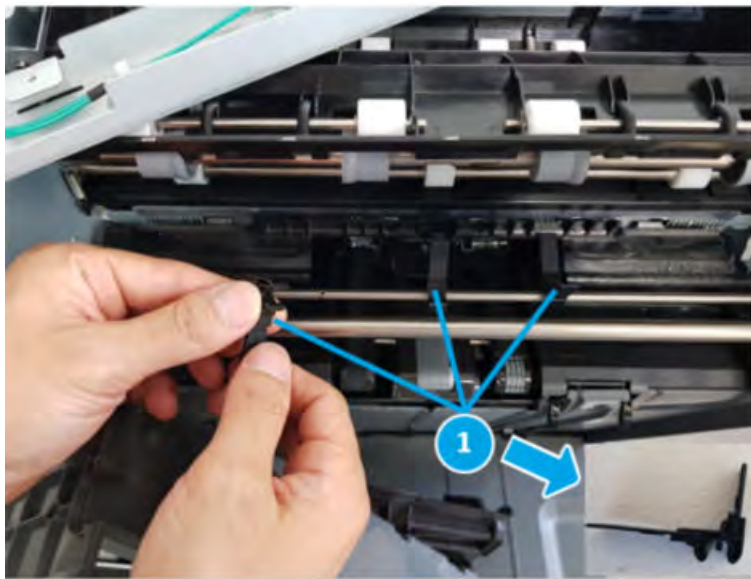
9. Take supporter of top output bin (callout 1) forward and put it down.

Figure 5-440 Take supporter of top output bin forward and put it down.



10. Remove three paddles (callout 1) from shaft

Figure 5-441 Remove the paddle



### Unpack the replacement assembly

Follow these steps to unpack the replacement assembly.

1. Dispose of the defective part.



---


 **NOTE:** HP recommends responsible disposal of the defective part.


<http://www8.hp.com/us/en/hp-information/environment/product-recycling.html>

---

2. Unpack the replacement part from the packaging.


 **CAUTION:**  Some parts are sensitive to electrostatic discharge (ESD). Always perform service work at an ESD-protected workstation or mat. If an ESD workstation or mat is not available, touch the sheet-metal chassis to provide a static ground before touching an ESD-sensitive assembly. Protect the ESD-sensitive assemblies by placing them in ESD pouches when they are out of the printer.

 **IMPORTANT:** Make sure that all of the shipping materials (for example shipping tape) are removed from the replacement part prior to installation.

 **NOTE:** If the replacement part is a roller or pad, avoid touching the spongy part of it. Skin oils on the roller or pad can cause paper pickup and/or print-quality problems. HP recommends using disposable gloves when handling rollers or pads or washing your hands before touching rollers or pads.

---

3. To install an assembly, reverse the removal steps.

 **NOTE:** When applicable, special installation instructions are provided for an assembly at the end of the removal procedure. Always completely read the removal instructions and follow all special installation instructions.


---

## Removal and replacement: Paddle home sensor (S8)

Learn how to remove and replace the paddle home sensor.

### Introduction

This document provides the procedures to remove and replace the paddle home sensor for the finisher.

 **IMPORTANT:** When applicable, special installation instructions are provided for an assembly at the end of the removal procedure. Always completely read the removal instructions and follow all special installation instructions.

### Before performing service

- Turn the printer power off. A shutting-down message appears on the control-panel display.
- ⚠ **WARNING!** To avoid damage to the printer, turn the power off and wait until the printer shuts down before removing the power cable.
- Disconnect the printer power cable after the printer has completely shut down (the control-panel display is blank).
- Release the finisher from the printer by pulling out on the release latch inside the finisher door.
- Disconnect the cable from the bridge unit to the finisher.
- Disconnect the cable from the finisher to the printer.

Use the table below to identify the correct part number for your printer. To order the part, go to <https://parts.hp.com>.

**Table 5-109** Part information

Part number	Part description
0604-001393	Paddle home sensor

### Required tools

- #2 JIS screwdriver with a magnetic tip
- Small, flat-blade screwdriver

### After performing service

- Connect the cable from the finisher to the printer.
- Connect the cable from the bridge unit to the finisher.
- Attach the finisher to the printer, and then push in on the release latch inside the finisher door.
- Connect the printer power cable.
- Turn the printer power on.

### Post service test

Process a job through the finisher and verify that the finisher works correctly.

## Remove the right upper cover (finisher)

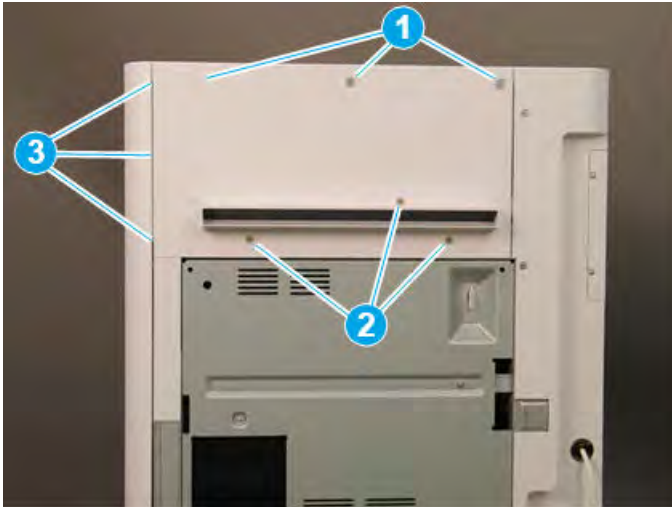
Follow these steps to remove the right upper cover (finisher).

- ▲ Remove one screw cap and three machine screws on the upper edge of the cover (callout 1). Remove three sheet metal screws (callout 2) on the lower portion of the cover. Rotate the right edge of the cover away from the finisher, and then slide the cover right to release three tabs (callout 3).

💡 **TIP:** The lower screws are shorter in length than the upper screws.

**TIP:** Reverse the removal steps to install the assembly.

**Figure 5-442** Remove the right upper cover

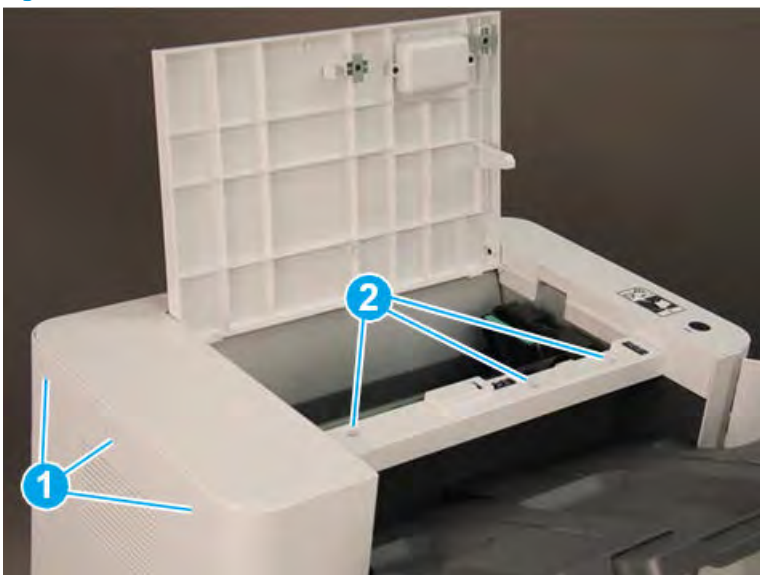


## Remove the top cover (finisher)

Follow these steps to remove the top cover (finisher).

1. Remove three screw caps and three self-tapping screws at the top of the rear cover (callout 1), and then remove three machine screws (callout 2) on top of the cover.

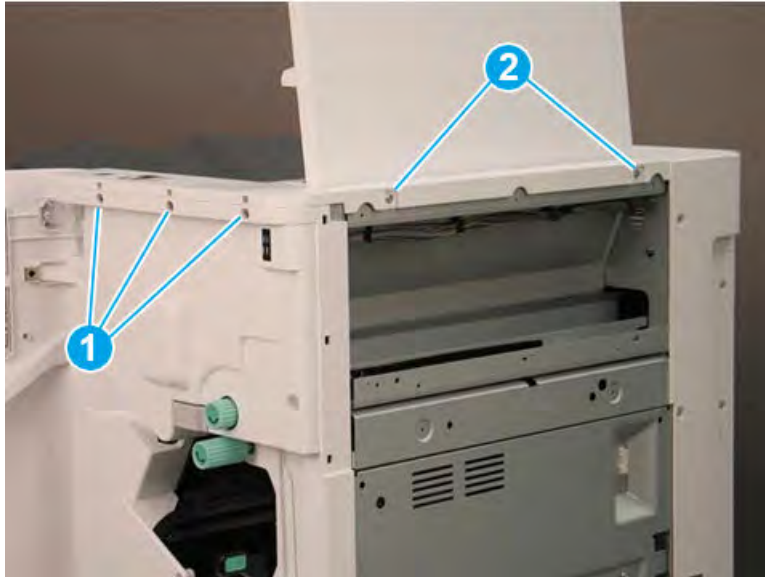
**Figure 5-443** Remove six screws






2. Remove three self-tapping screws at the top of the front cover (callout 1), and then remove two machine screws (callout 2) at the top of the right side.

Figure 5-444 Remove five screws



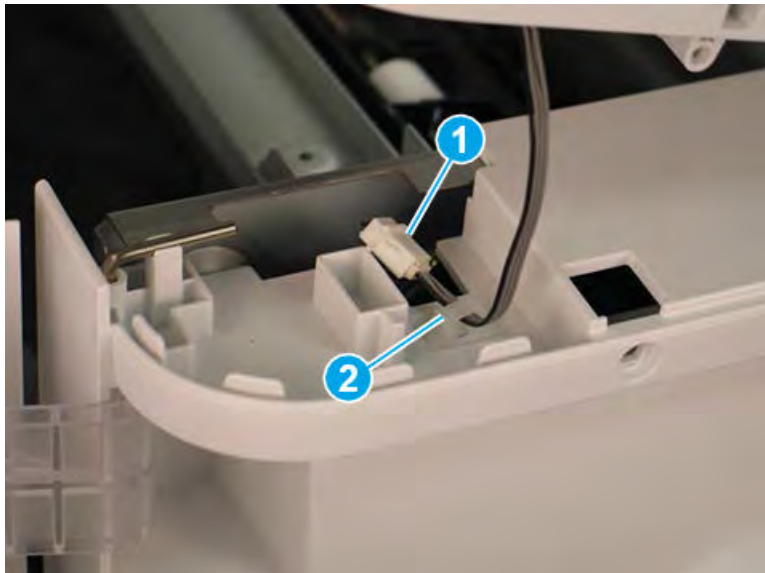
3. Lift the cover up slightly. Disconnect one in-line connector (callout 1), and then release one retainer (callout 2).

---

 **TIP:** Reverse the removal steps to install the assembly.

---

Figure 5-445 Disconnect one connector and release retainer

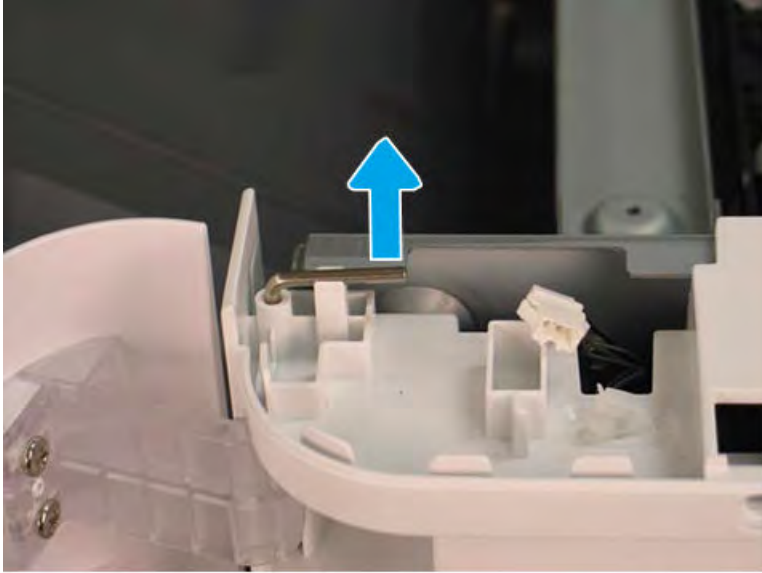


### Remove the front door (finisher)

Follow these steps to remove the front door (finisher).

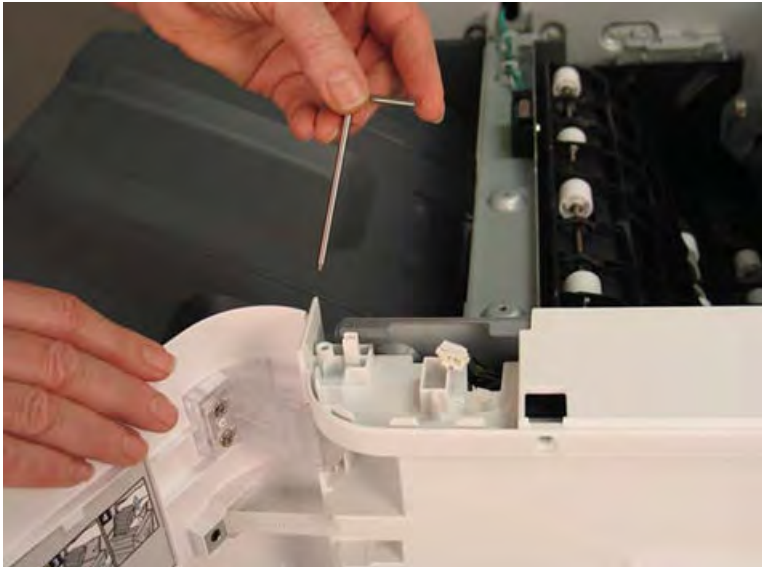
1. Lift the top hinge pin up to release it from the retainer.

Figure 5-446 Lift the top hinge pin



2. Pull the top hinge pin up to remove it.

Figure 5-447 Remove the top hinge pin



3. Use a small, flat-blade screwdriver to release the lower hinge pin from the retainer, and then rotate it away from the finisher.

Figure 5-448 Release the lower hinge pin



4. Support the door with one hand, and then pull the lower hinge pin straight up to remove it.

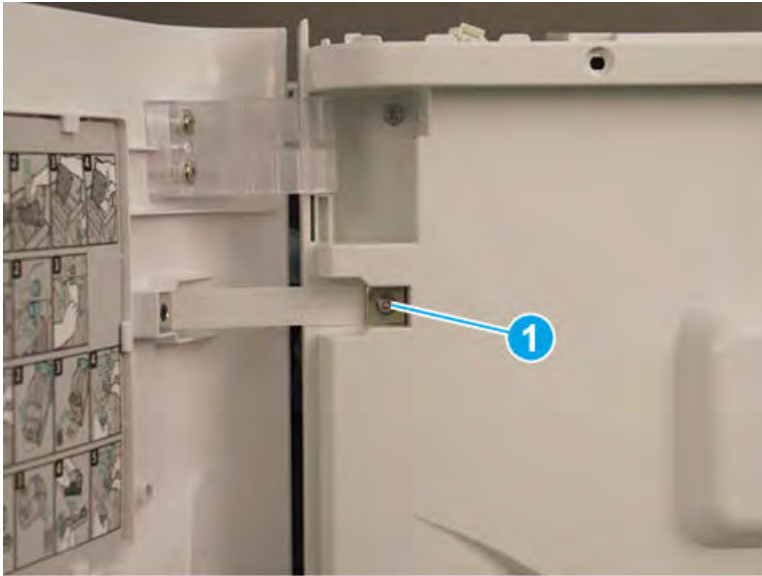
Figure 5-449 Remove the lower hinge pin



5. Support the door with one hand, and then remove one screw (callout 1) to release the strap. Remove the front door.

 **TIP:** Reverse the removal steps to install the assembly.

**Figure 5-450** Remove the front door

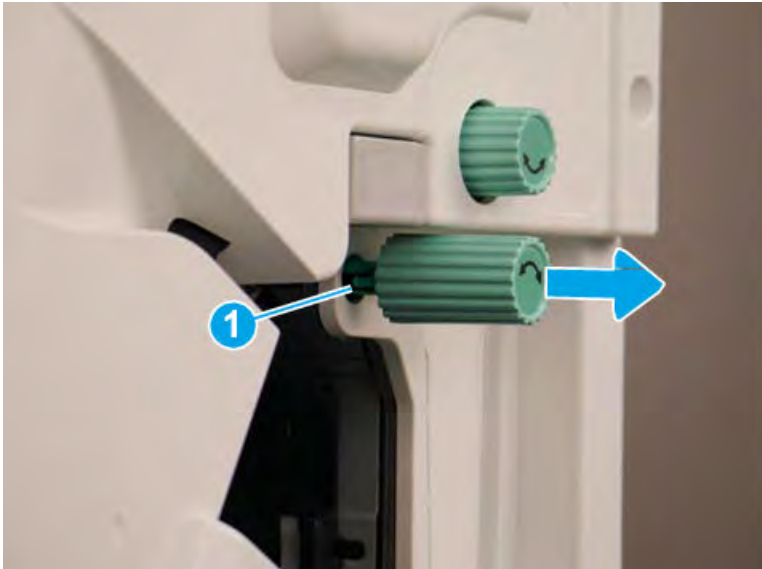


#### Remove the front cover (finisher)

Follow these steps to remove the front cover (finisher).

1. Release one tab (callout 1), and then pull the jam-access knob away from the finisher to remove it.

**Figure 5-451** Remove the jam-access knob



2. If the punch unit is installed, remove the punch waste bin (callout 1).


3. Remove one screw (callout 1) on top of the front cover.

Figure 5-452 Remove one screw



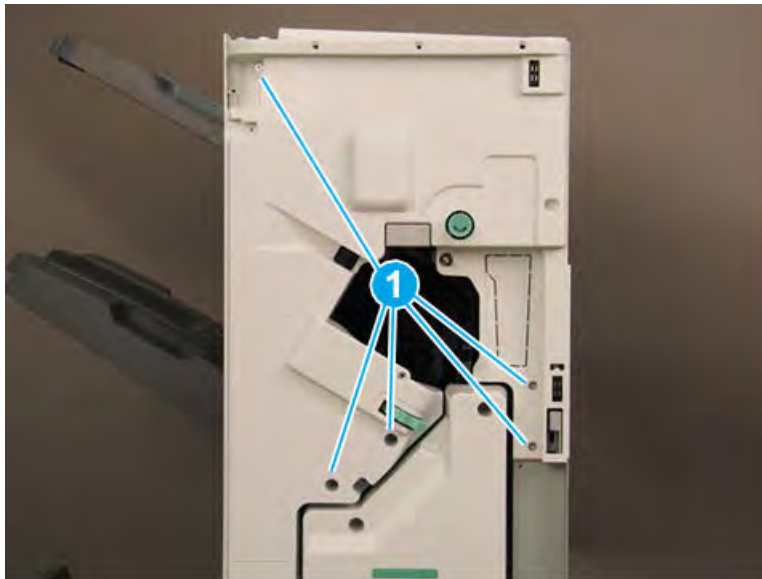
4. Remove five machine screws (callout 1), and then remove the front cover.

---

 **TIP:** Reverse the removal steps to install the assembly.

---

Figure 5-453 Remove the front cover

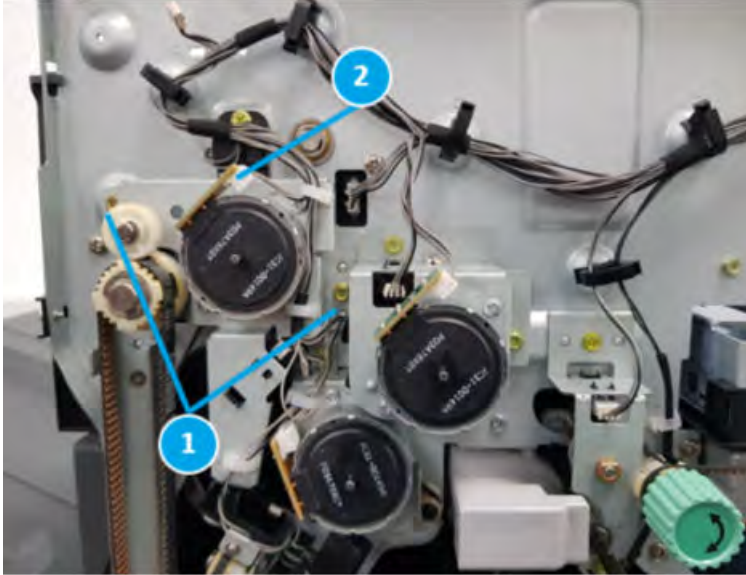


### Remove the paddle home sensor (S8)

Follow these steps to remove the paddle home sensor (S8).

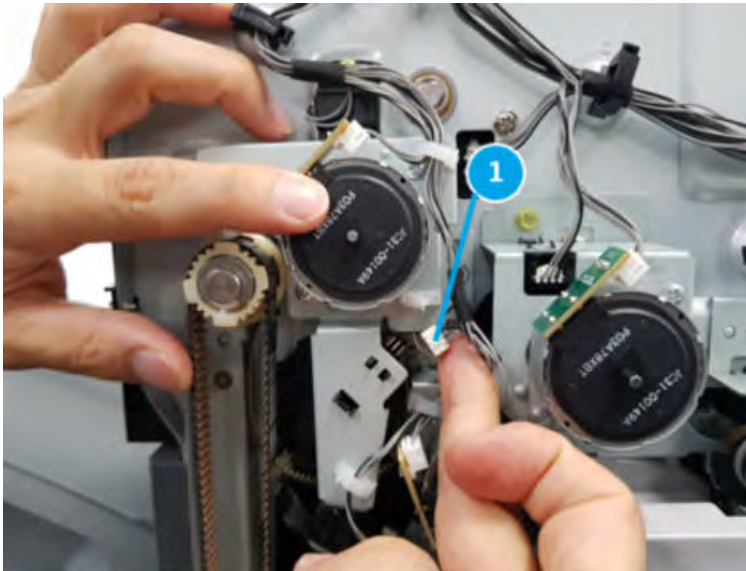
1. At the front of the finisher, remove two screws (callout 1) and disconnect two connectors (callout 2)

Figure 5-454 Remove two screws and disconnect two connectors



2. Disconnect connector from paddle home sensor

Figure 5-455 Disconnect connector from paddle home sensor



3. Remove paddle home sensor (S8; callout1)

Figure 5-456 Remove paddle home sensor



### Unpack the replacement assembly

Follow these steps to unpack the replacement assembly.

1. Dispose of the defective part.




**NOTE:** HP recommends responsible disposal of the defective part.

<http://www8.hp.com/us/en/hp-information/environment/product-recycling.html>

2. Unpack the replacement part from the packaging.



**CAUTION:**  Some parts are sensitive to electrostatic discharge (ESD). Always perform service work at an ESD-protected workstation or mat. If an ESD workstation or mat is not available, touch the sheet-metal chassis to provide a static ground before touching an ESD-sensitive assembly. Protect the ESD-sensitive assemblies by placing them in ESD pouches when they are out of the printer.



**IMPORTANT:** Make sure that all of the shipping materials (for example shipping tape) are removed from the replacement part prior to installation.



**NOTE:** If the replacement part is a roller or pad, avoid touching the spongy part of it. Skin oils on the roller or pad can cause paper pickup and/or print-quality problems. HP recommends using disposable gloves when handling rollers or pads or washing your hands before touching rollers or pads.

3. To install an assembly, reverse the removal steps.




**NOTE:** When applicable, special installation instructions are provided for an assembly at the end of the removal procedure. Always completely read the removal instructions and follow all special installation instructions.

## Removal and replacement: Paddle motor (M1)

Learn how to remove and replace the paddle motor.

### Introduction

This document provides the procedures to remove and replace the paddle motor for the finisher.

 **IMPORTANT:** When applicable, special installation instructions are provided for an assembly at the end of the removal procedure. Always completely read the removal instructions and follow all special installation instructions.

### Before performing service

- Turn the printer power off. A shutting-down message appears on the control-panel display.
- ⚠ **WARNING!** To avoid damage to the printer, turn the power off and wait until the printer shuts down before removing the power cable.
- Disconnect the printer power cable after the printer has completely shut down (the control-panel display is blank).
- Release the finisher from the printer by pulling out on the release latch inside the finisher door.
- Disconnect the cable from the bridge unit to the finisher.
- Disconnect the cable from the finisher to the printer.

Use the table below to identify the correct part number for your printer. To order the part, go to <https://parts.hp.com>.

**Table 5-110 Part information**

Part number	Part description
JC90-01461A	Paddle motor assembly
JC93-01001A	Paddle motor

### Required tools

- #2 JIS screwdriver with a magnetic tip
- Small, flat-blade screwdriver

### After performing service

- Connect the cable from the finisher to the printer.
- Connect the cable from the bridge unit to the finisher.
- Attach the finisher to the printer, and then push in on the release latch inside the finisher door.
- Connect the printer power cable.
- Turn the printer power on.



## Post service test

Process a job through the finisher and verify that the finisher works correctly.

## Remove the right upper cover (finisher)

Follow these steps to remove the right upper cover (finisher).

- ▲ Remove one screw cap and three machine screws on the upper edge of the cover (callout 1). Remove three sheet metal screws (callout 2) on the lower portion of the cover. Rotate the right edge of the cover away from the finisher, and then slide the cover right to release three tabs (callout 3).

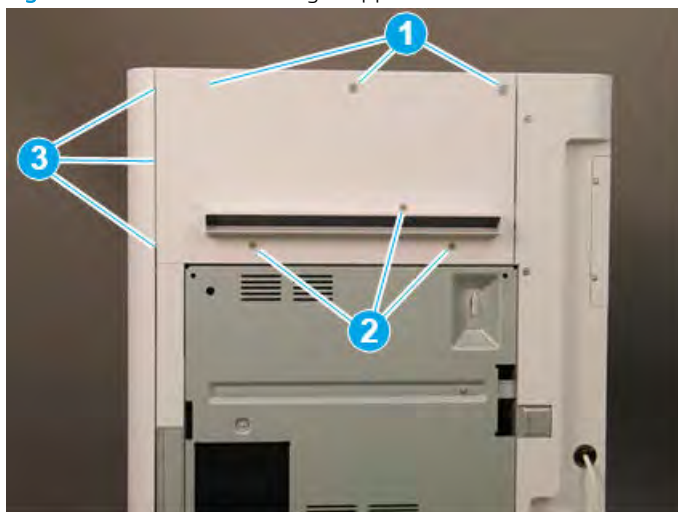
---

💡 **TIP:** The lower screws are shorter in length than the upper screws.

**TIP:** Reverse the removal steps to install the assembly.

---

**Figure 5-457** Remove the right upper cover

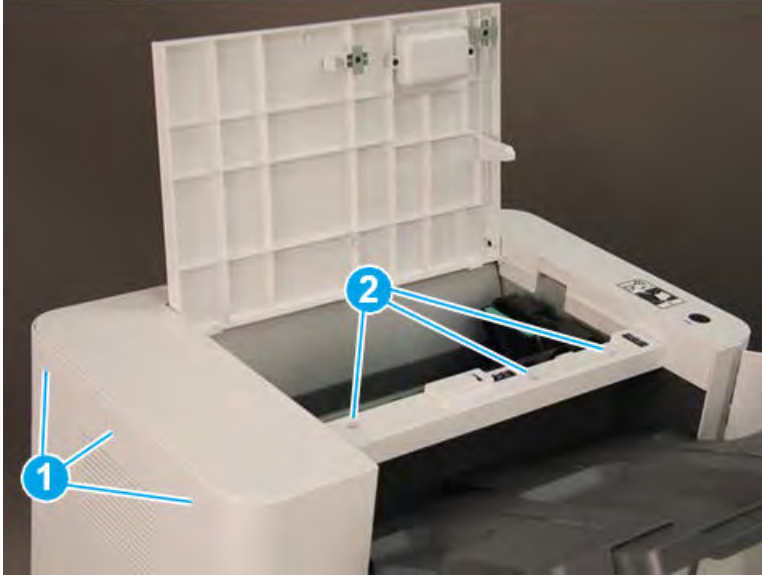


## Remove the top cover (finisher)

Follow these steps to remove the top cover (finisher).

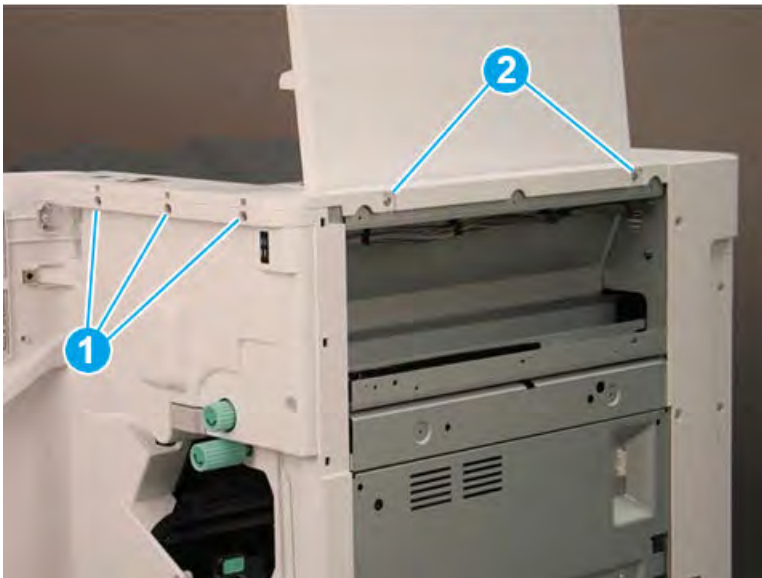
1. Remove three screw caps and three self-tapping screws at the top of the rear cover (callout 1), and then remove three machine screws (callout 2) on top of the cover.

Figure 5-458 Remove six screws




2. Remove three self-tapping screws at the top of the front cover (callout 1), and then remove two machine screws (callout 2) at the top of the right side.

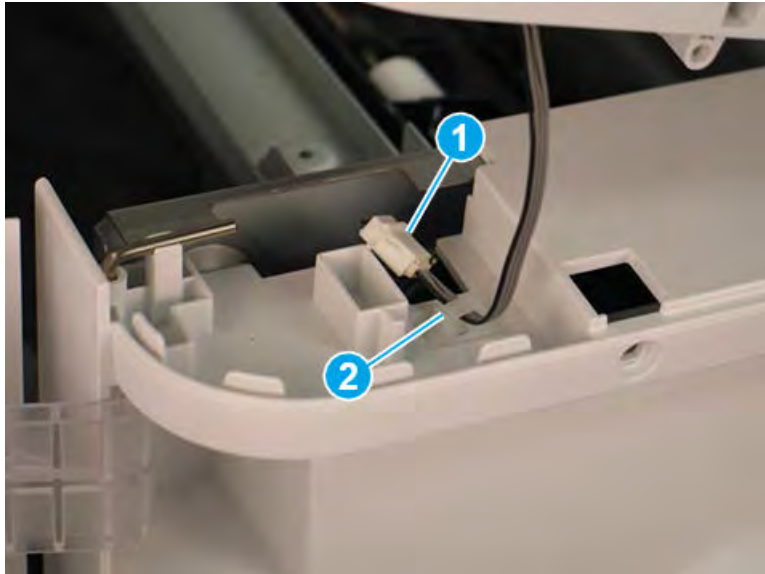
Figure 5-459 Remove five screws



3. Lift the cover up slightly. Disconnect one in-line connector (callout 1), and then release one retainer (callout 2).

 **TIP:** Reverse the removal steps to install the assembly.

**Figure 5-460** Disconnect one connector and release retainer

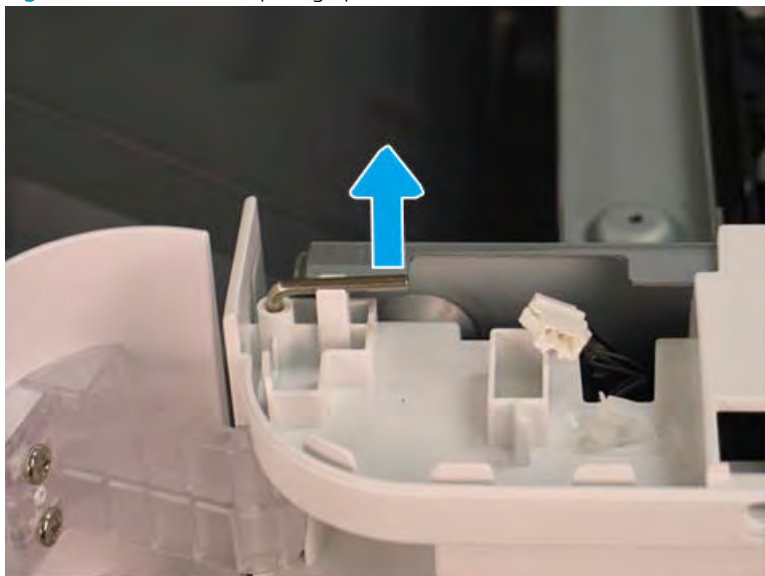


#### Remove the front door (finisher)

Follow these steps to remove the front door (finisher).

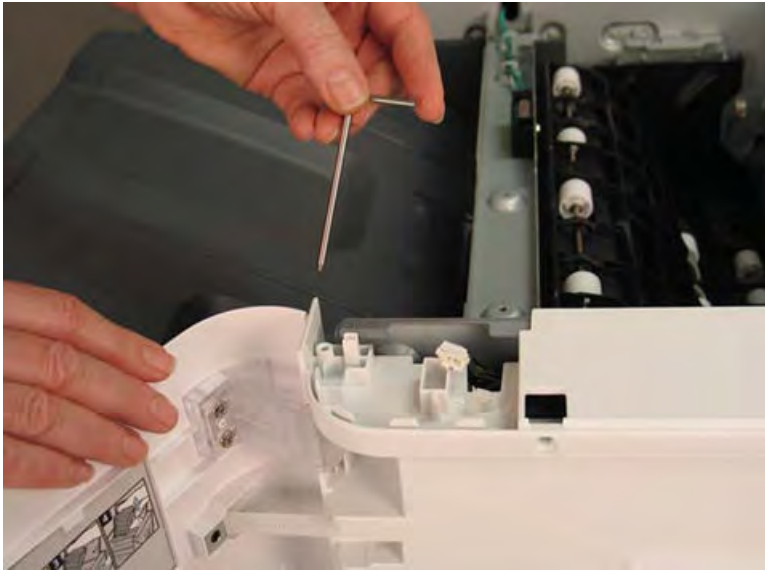
1. Lift the top hinge pin up to release it from the retainer.

**Figure 5-461** Lift the top hinge pin



2. Pull the top hinge pin up to remove it.

Figure 5-462 Remove the top hinge pin



3. Use a small, flat-blade screwdriver to release the lower hinge pin from the retainer, and then rotate it away from the finisher.

Figure 5-463 Release the lower hinge pin




4. Support the door with one hand, and then pull the lower hinge pin straight up to remove it.

Figure 5-464 Remove the lower hinge pin



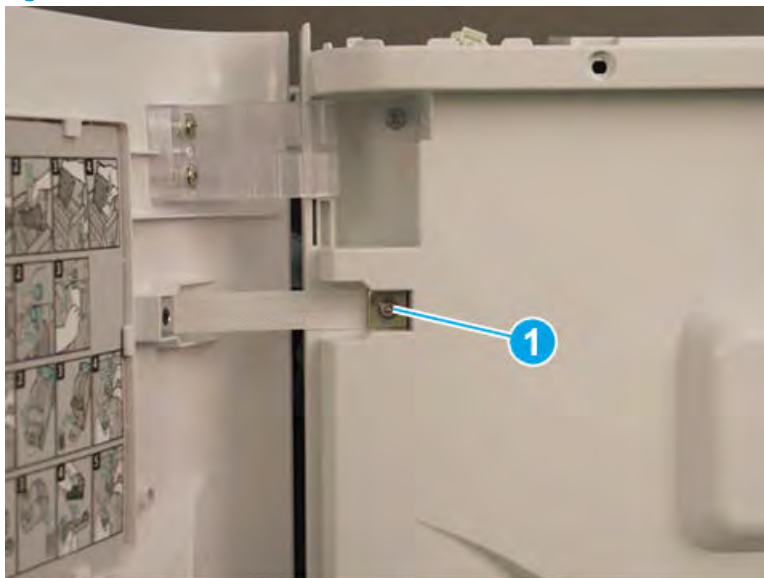
5. Support the door with one hand, and then remove one screw (callout 1) to release the strap. Remove the front door.

---

 **TIP:** Reverse the removal steps to install the assembly.

---

Figure 5-465 Remove the front door

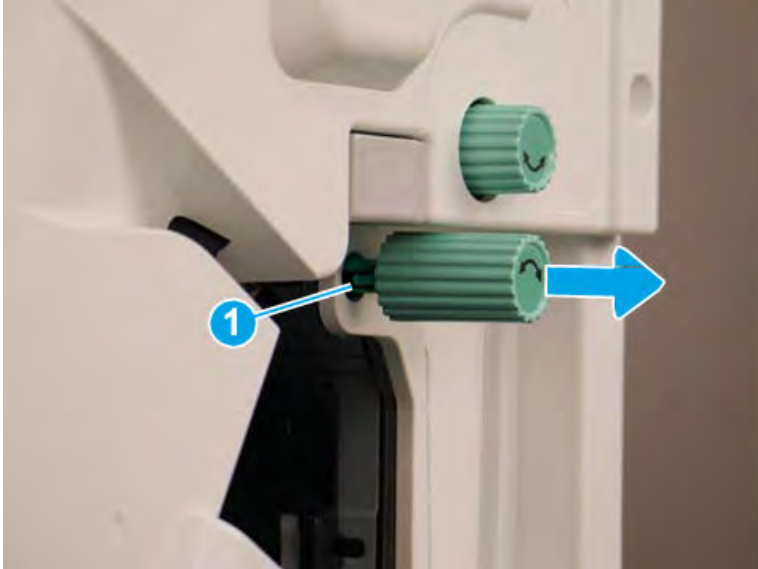


### Remove the front cover (finisher)

Follow these steps to remove the front cover (finisher).

1. Release one tab (callout 1), and then pull the jam-access knob away from the finisher to remove it.

Figure 5-466 Remove the jam-access knob




2. If the punch unit is installed, remove the punch waste bin (callout 1).
3. Remove one screw (callout 1) on top of the front cover.

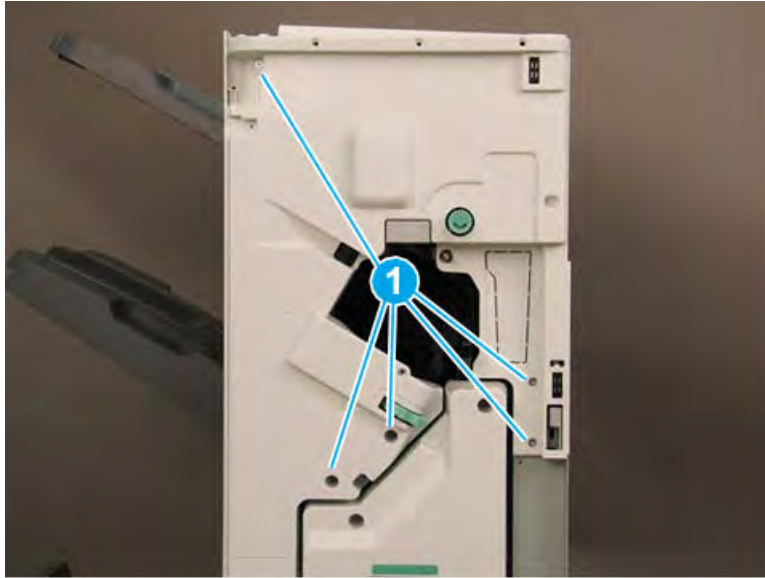
Figure 5-467 Remove one screw



4. Remove five machine screws (callout 1), and then remove the front cover.

 **TIP:** Reverse the removal steps to install the assembly.

**Figure 5-468** Remove the front cover

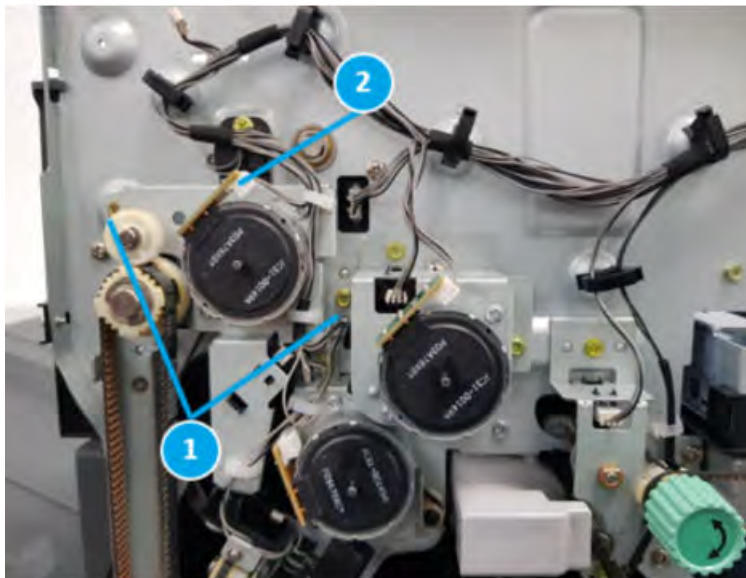


#### Remove the paddle motor (M1)

Follow these steps to remove the paddle motor (M1).

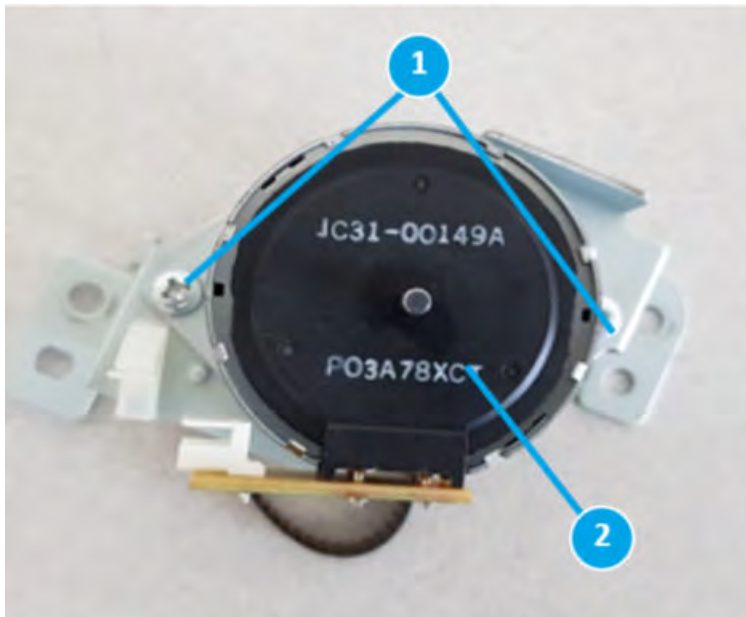
1. At the front of the finisher, remove two screws (callout 1) and disconnect two connectors (callout 2)

**Figure 5-469** Remove two screws and disconnect two connectors



2. Remove two screws (callout 1) and then remove paddle motor (M1; callout 2)

Figure 5-470 Remove the paddle motor



### Unpack the replacement assembly

Follow these steps to unpack the replacement assembly.

1. Dispose of the defective part.

---



 **NOTE:** HP recommends responsible disposal of the defective part.


<http://www8.hp.com/us/en/hp-information/environment/product-recycling.html>


---

2. Unpack the replacement part from the packaging.

---

 **CAUTION:**  Some parts are sensitive to electrostatic discharge (ESD). Always perform service work at an ESD-protected workstation or mat. If an ESD workstation or mat is not available, touch the sheet-metal chassis to provide a static ground before touching an ESD-sensitive assembly. Protect the ESD-sensitive assemblies by placing them in ESD pouches when they are out of the printer.


 **IMPORTANT:** Make sure that all of the shipping materials (for example shipping tape) are removed from the replacement part prior to installation.

 **NOTE:** If the replacement part is a roller or pad, avoid touching the spongy part of it. Skin oils on the roller or pad can cause paper pickup and/or print-quality problems. HP recommends using disposable gloves when handling rollers or pads or washing your hands before touching rollers or pads.

---

3. To install an assembly, reverse the removal steps.

---

 **NOTE:** When applicable, special installation instructions are provided for an assembly at the end of the removal procedure. Always completely read the removal instructions and follow all special installation instructions.

---




## End fence unit

## Removal and replacement: End fence home sensor (S7)

Learn how to remove and replace the end fence home sensor.

### Introduction

This document provides the procedures to remove and replace the end fence home sensor on the finisher.

 **IMPORTANT:** When applicable, special installation instructions are provided for an assembly at the end of the removal procedure. Always completely read the removal instructions and follow all special installation instructions.

### Before performing service

- Turn the printer power off. A shutting-down message appears on the control-panel display.
- ⚠ **WARNING!** To avoid damage to the printer, turn the power off and wait until the printer shuts down before removing the power cable.
- Disconnect the printer power cable after the printer has completely shut down (the control-panel display is blank).
- Release the finisher from the printer by pulling out on the release latch inside the finisher door.
- Disconnect the cable from the bridge unit to the finisher.
- Disconnect the cable from the finisher to the printer.

Use the table below to identify the correct part number for your printer. To order the part, go to <https://parts.hp.com>.

**Table 5-111 Part information**

Part number	Part description
0604-001393	End fence home sensor

### Required tools

- #2 JIS screwdriver with a magnetic tip
- Small, flat-blade screwdriver

### After performing service

- Connect the cable from the finisher to the printer.
- Connect the cable from the bridge unit to the finisher.
- Attach the finisher to the printer, and then push in on the release latch inside the finisher door.
- Connect the printer power cable.
- Turn the printer power on.

### Post service test

Process a job through the finisher and verify that the finisher works correctly.

### Remove the right upper cover (finisher)

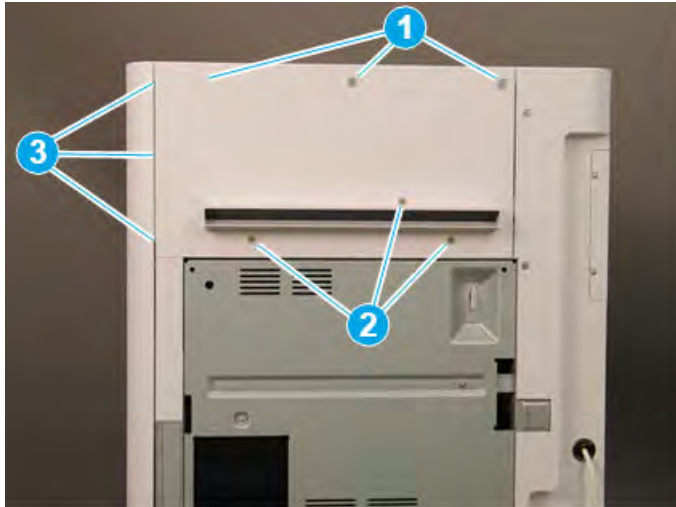
Follow these steps to remove the right upper cover (finisher).

- ▲ Remove one screw cap and three machine screws on the upper edge of the cover (callout 1). Remove three sheet metal screws (callout 2) on the lower portion of the cover. Rotate the right edge of the cover away from the finisher, and then slide the cover right to release three tabs (callout 3).

💡 **TIP:** The lower screws are shorter in length than the upper screws.

**TIP:** Reverse the removal steps to install the assembly.

Figure 5-471 Remove the right upper cover

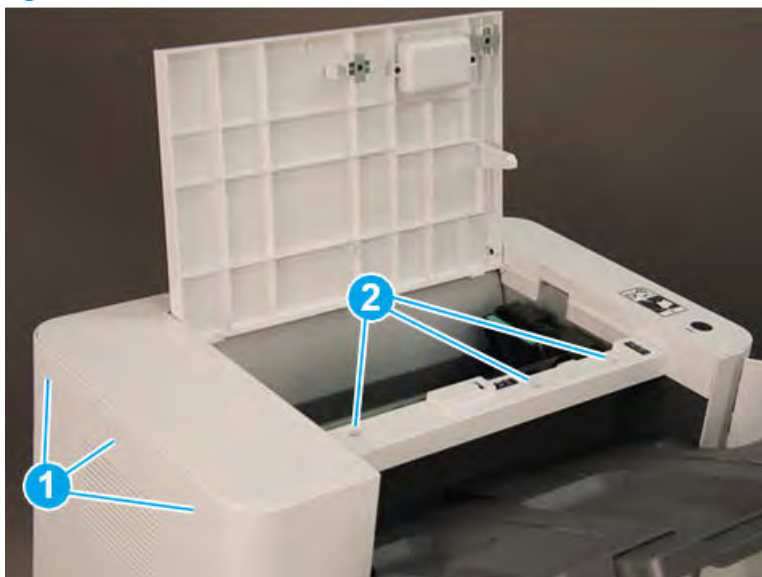


### Remove the top cover (finisher)

Follow these steps to remove the top cover (finisher).

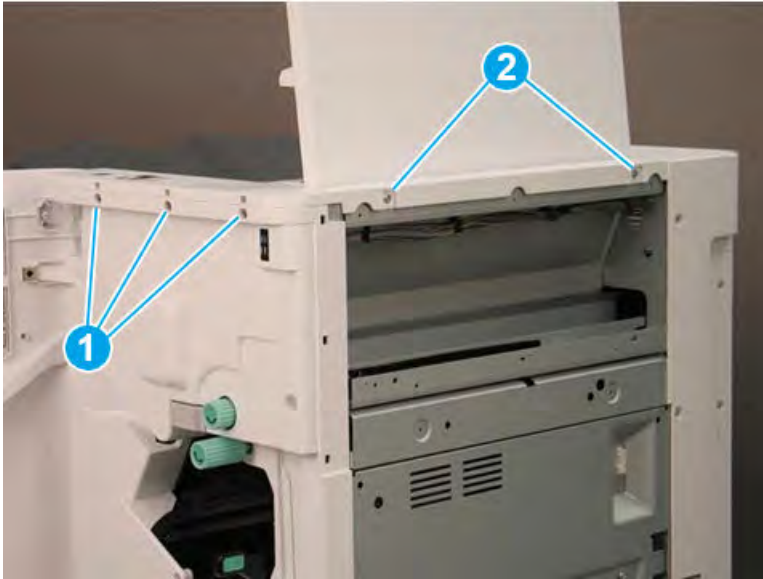
1. Remove three screw caps and three self-tapping screws at the top of the rear cover (callout 1), and then remove three machine screws (callout 2) on top of the cover.

Figure 5-472 Remove six screws




2. Remove three self-tapping screws at the top of the front cover (callout 1), and then remove two machine screws (callout 2) at the top of the right side.

Figure 5-473 Remove five screws



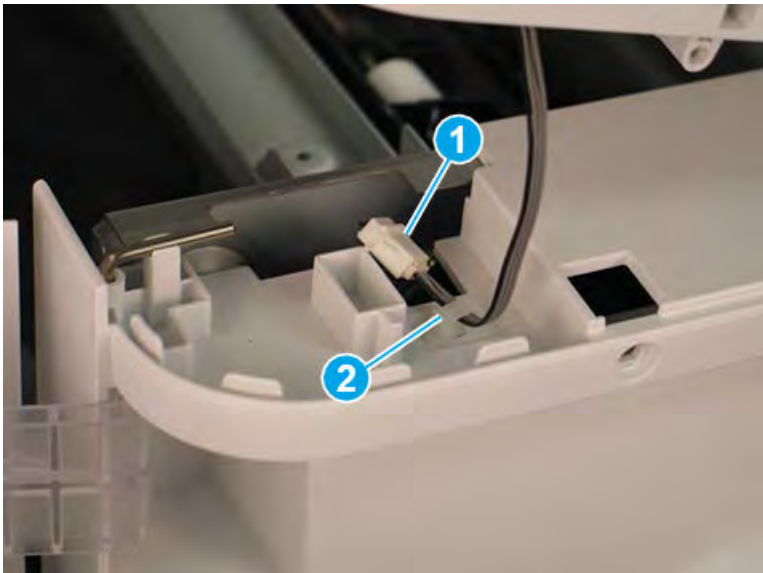
3. Lift the cover up slightly. Disconnect one in-line connector (callout 1), and then release one retainer (callout 2).

---

 **TIP:** Reverse the removal steps to install the assembly.

---

Figure 5-474 Disconnect one connector and release retainer

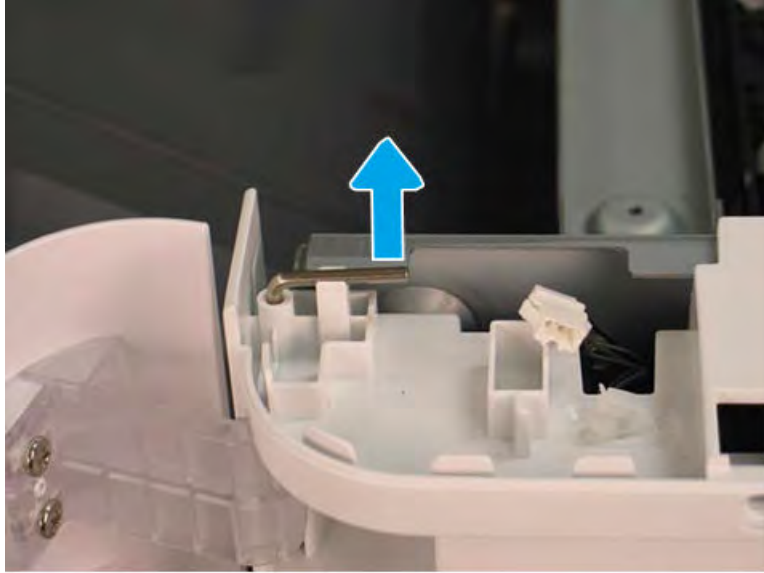


### Remove the front door (finisher)

Follow these steps to remove the front door (finisher).

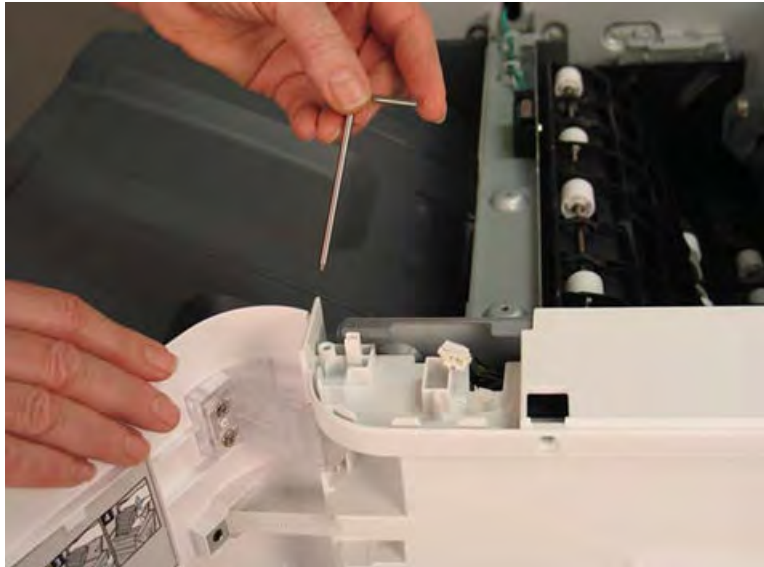
1. Lift the top hinge pin up to release it from the retainer.

Figure 5-475 Lift the top hinge pin



2. Pull the top hinge pin up to remove it.

Figure 5-476 Remove the top hinge pin



3. Use a small, flat-blade screwdriver to release the lower hinge pin from the retainer, and then rotate it away from the finisher.

**Figure 5-477** Release the lower hinge pin




4. Support the door with one hand, and then pull the lower hinge pin straight up to remove it.

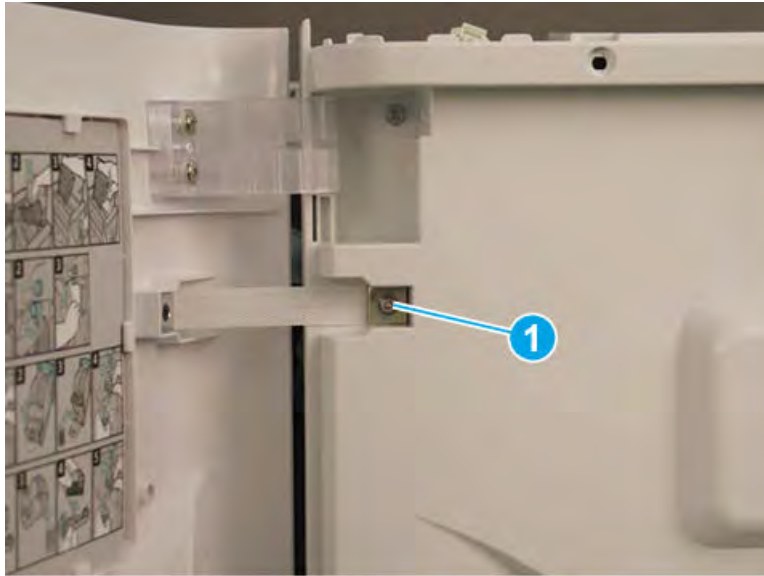
**Figure 5-478** Remove the lower hinge pin



5. Support the door with one hand, and then remove one screw (callout 1) to release the strap. Remove the front door.

 **TIP:** Reverse the removal steps to install the assembly.

**Figure 5-479** Remove the front door

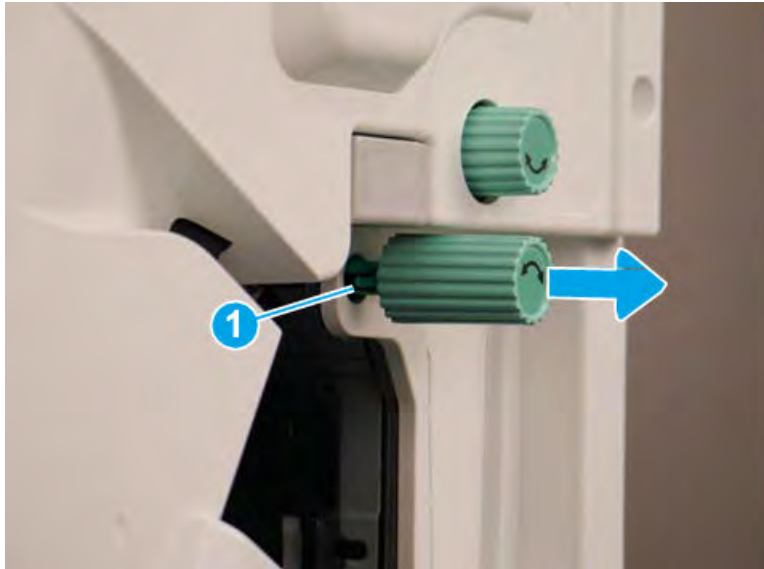


#### Remove the front cover (finisher)

Follow these steps to remove the front cover (finisher).

1. Release one tab (callout 1), and then pull the jam-access knob away from the finisher to remove it.

**Figure 5-480** Remove the jam-access knob



2. If the punch unit is installed, remove the punch waste bin (callout 1).


3. Remove one screw (callout 1) on top of the front cover.

Figure 5-481 Remove one screw



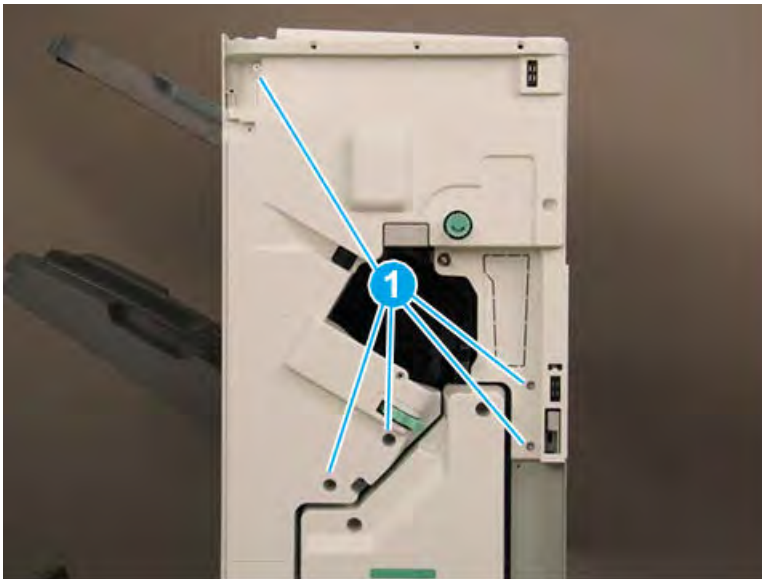
4. Remove five machine screws (callout 1), and then remove the front cover.

---

 **TIP:** Reverse the removal steps to install the assembly.

---

Figure 5-482 Remove the front cover



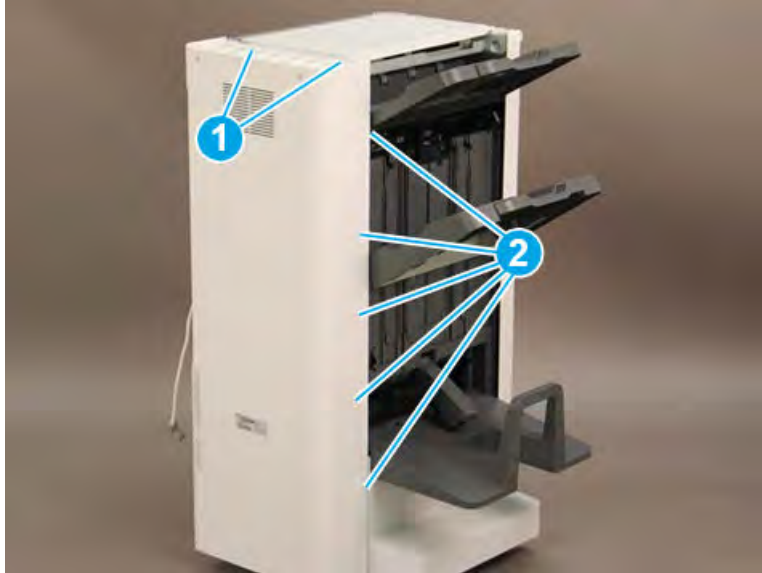
### Remove the rear cover (finisher)

Follow these steps to remove the rear cover (finisher).

1. Remove two self-tapping screws (callout 1) on the top of the rear cover, and then remove five screw caps and five machine screws (callout 2) on the left side of the cover.




Figure 5-483 Remove seven screws



2. Remove one screw cap and four machine screws (callout 1) Remove the rear cover.

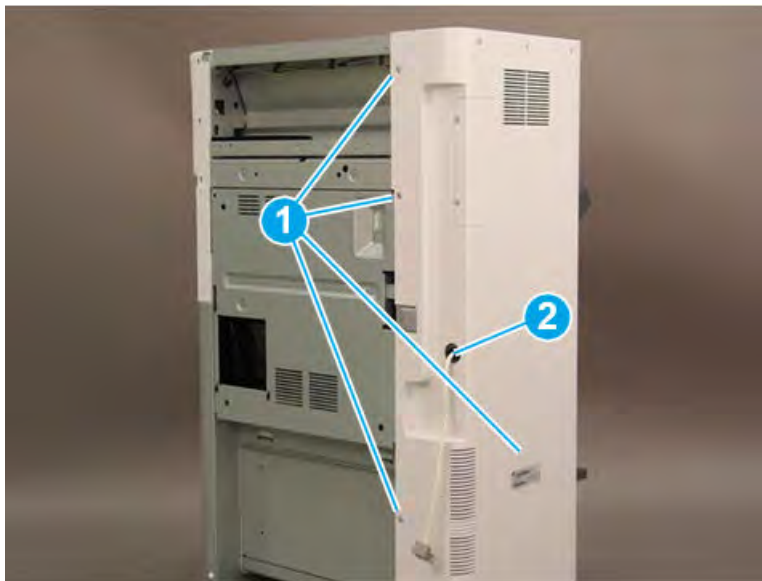
---

 **NOTE:** Make sure to thread the power cable (callout 2) through the opening in the cover.

 **TIP:** Reverse the removal steps to install the assembly

---

Figure 5-484 Remove the rear cover



### Remove the booklet output tray

Follow these steps to remove the booklet output tray.

1. Raise the booklet output tray up (callout 1), and then pull it away from the finisher (callout 2) to remove it.

Figure 5-485 Remove the booklet output tray



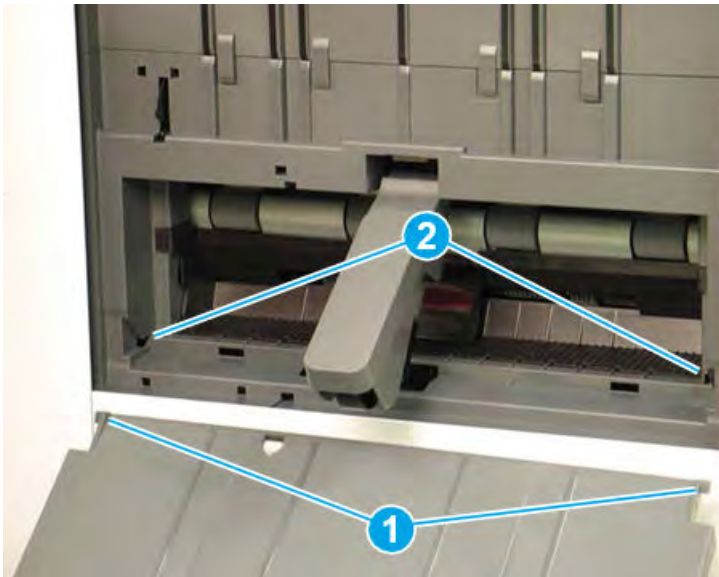
2. Reverse the removal steps to install the assembly. Also use the following special installation instructions.

 **NOTE:** Continue to reverse the removal steps to finish installing the assembly

Special installation instructions: booklet output tray

Position the tabs (callout 1) on the tray into the slots (callout 2) on the finisher.

Figure 5-486 Install the booklet output tray

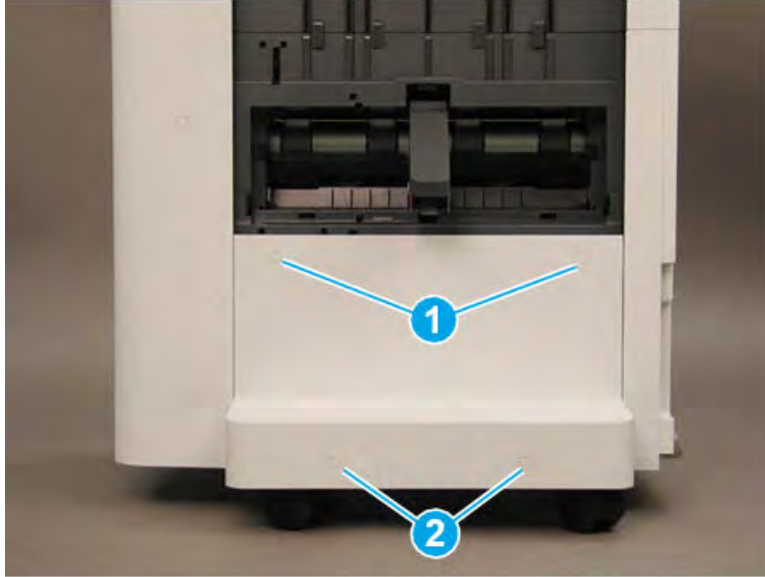


### Remove the caster cover

Follow these steps to remove the caster cover.

1. Remove two screw caps and two self-tapping screws (callout 1). Remove two screw caps and two machine screws (callout 2).

Figure 5-487 Remove four screws



2. Rotate the left edge of the cover away from the finisher (callout 1), and then slide the cover to the left (callout 2) to remove it.

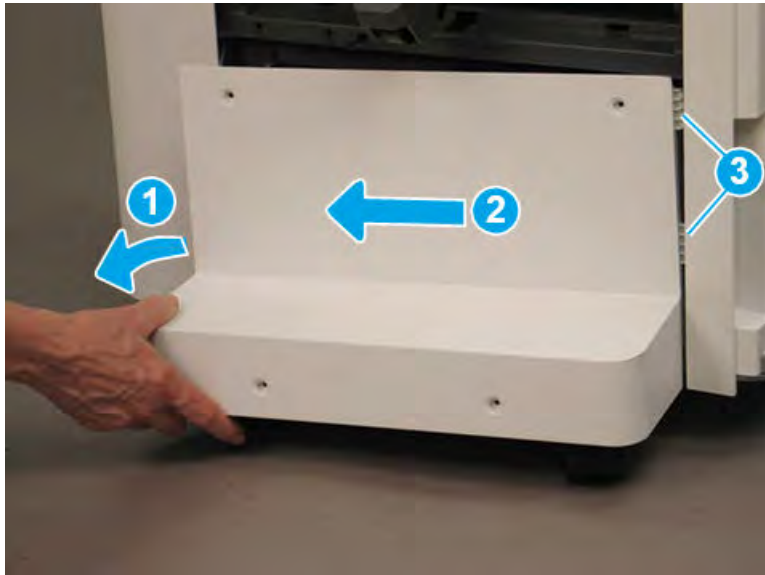
---

 **TIP:** Make sure that two tabs (callout 3) are positioned under the front lower cover when reinstalling the caster cover.

**TIP:** Reverse the removal steps to install the assembly

---

Figure 5-488 Remove the caster cover




### Remove the left lower cover (finisher)

Follow these steps to remove the left lower cover (finisher).

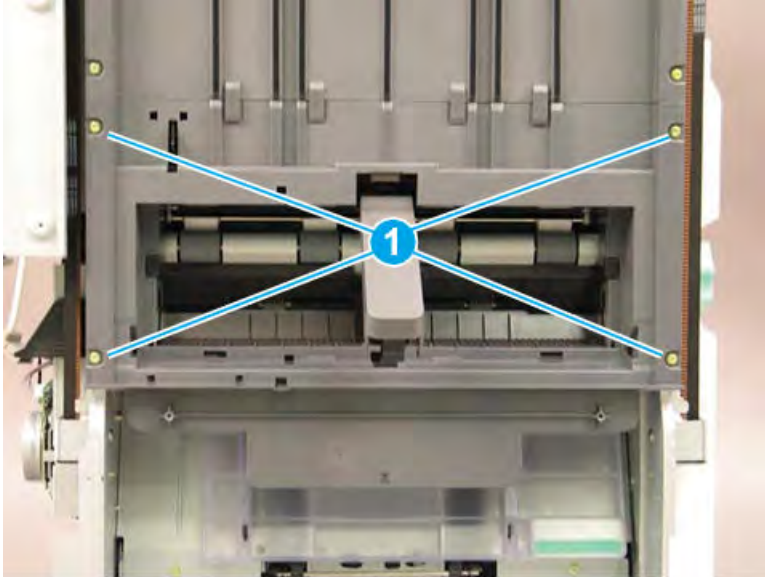
1. Remove four screws (callout 1).

---

 **NOTE:** Raise the lower output tray as needed to access the screws.

---

Figure 5-489 Remove four screws



2. Slide the shield down (callout 1) to release it from four tabs (callout 2), and then rotate it away from the finisher (callout 3).

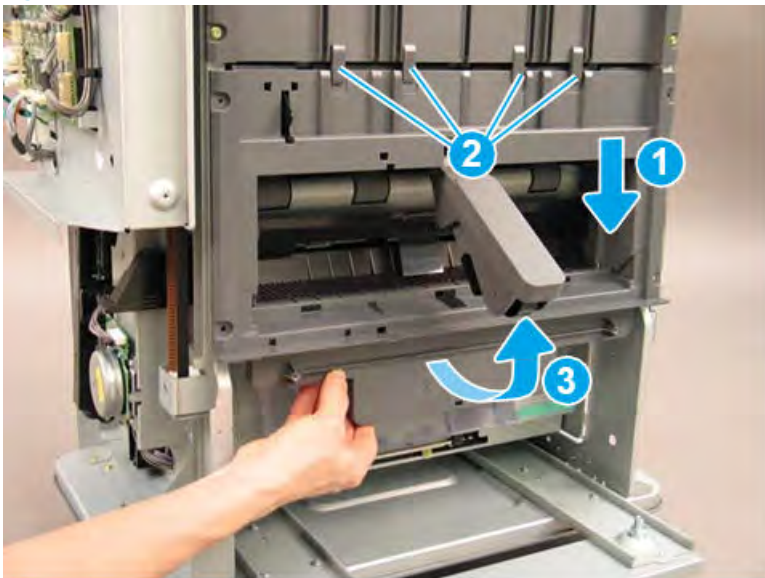
---

**⚠ CAUTION:** The shield is still attached to the finisher. Do not attempt to completely remove the shield.


**💡 TIP:** Position the shield under the four tabs (callout 2) when reinstalling it.

---

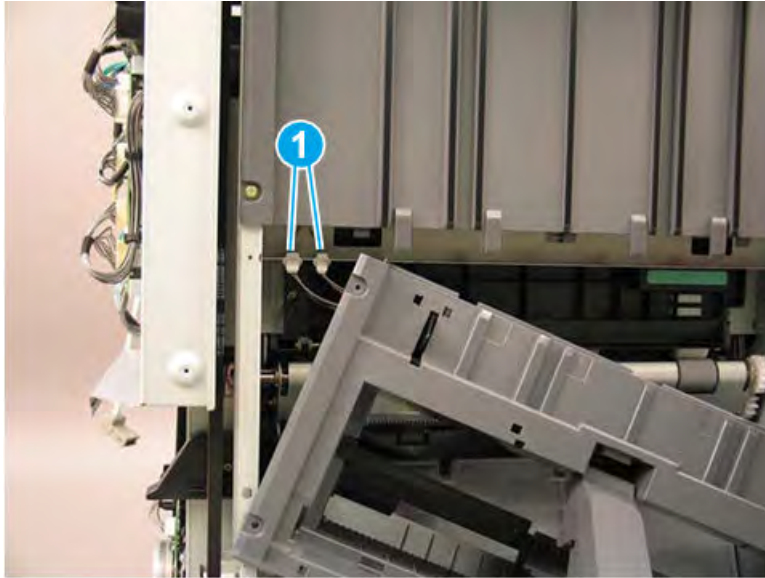
Figure 5-490 Release the lower shield



3. Disconnect two connectors (callout 1), and then remove the shield.

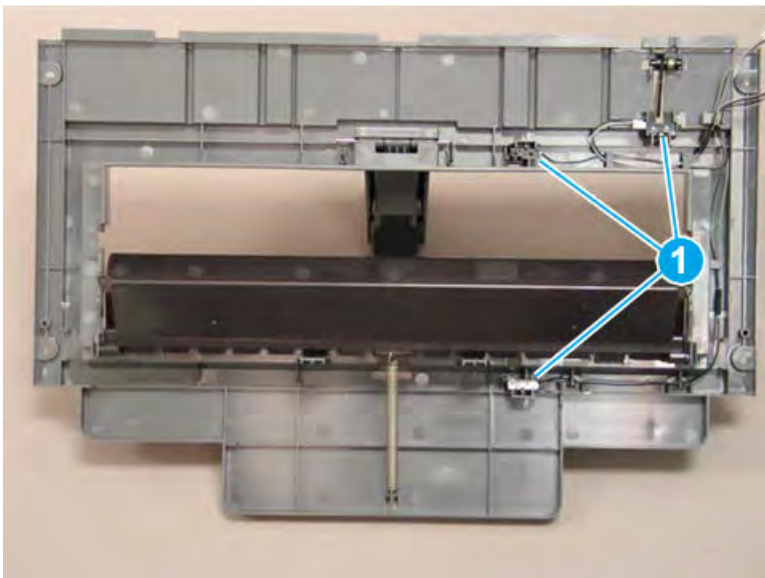
 **TIP:** Reverse the removal steps to install the assembly.

**Figure 5-491** Disconnect two connectors



4. If you are replacing the left lower cover, locate three sensors (callout 1) on the back of the left lower cover. Remove these sensors and transfer them to the replacement part.

**Figure 5-492** Remove the left lower cover

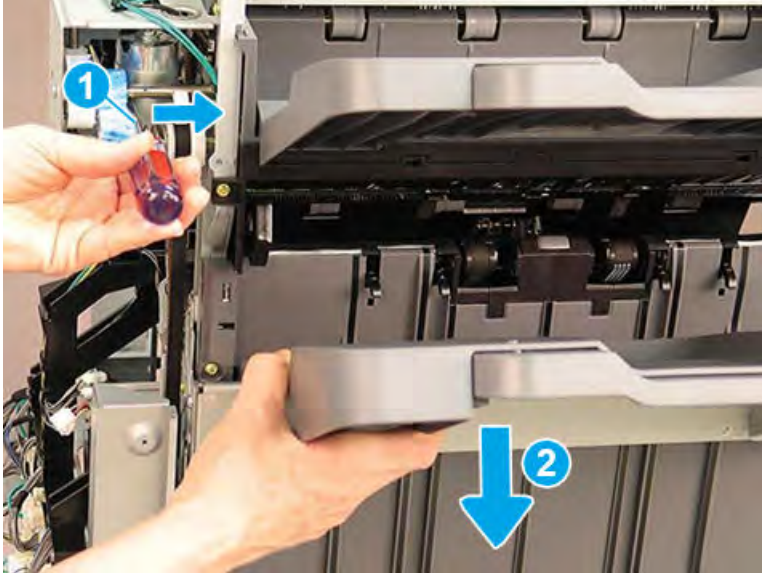


### Remove the left upper cover (finisher)

Follow these steps to remove the left upper cover (finisher).

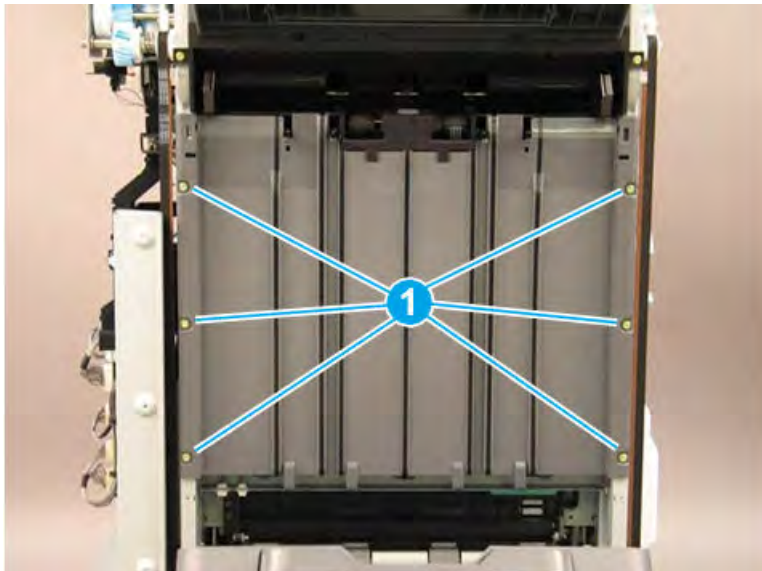
1. Bring the lower output tray down by positioning the shaft of a screwdriver on the clutch (callout 1) and gently pressing to the right to release the clutch. Hold the clutch in the released position and lower the tray (callout 2) to the lowest position.

Figure 5-493 Lower the output tray



2. Remove six machine screws (callout 1).

Figure 5-494 Remove six screws

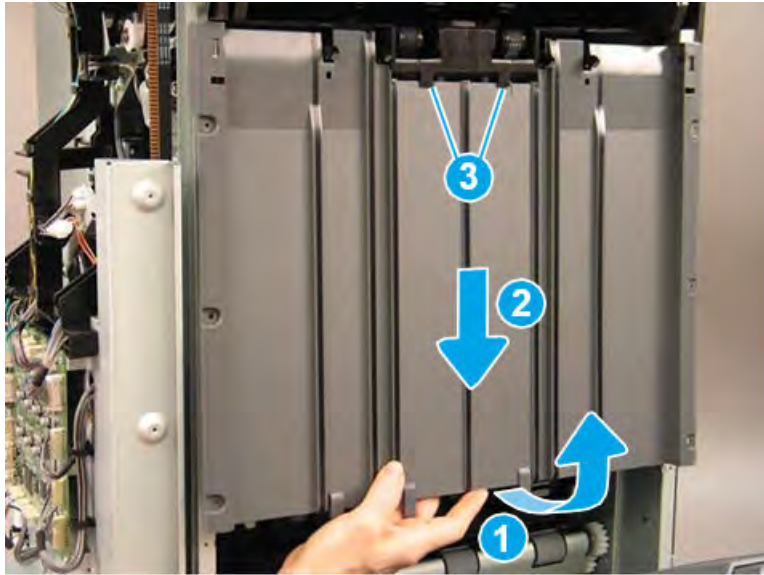


3. Rotate the lower edge of the shield away from the finisher (callout 1), and then slide the shield down (callout 2) to release it from two tabs (callout 3).

**CAUTION:** The shield is still attached to the finisher. Do not attempt to completely remove the shield.

**TIP:** Position the shield under the two tabs (callout 3) when reinstalling it.

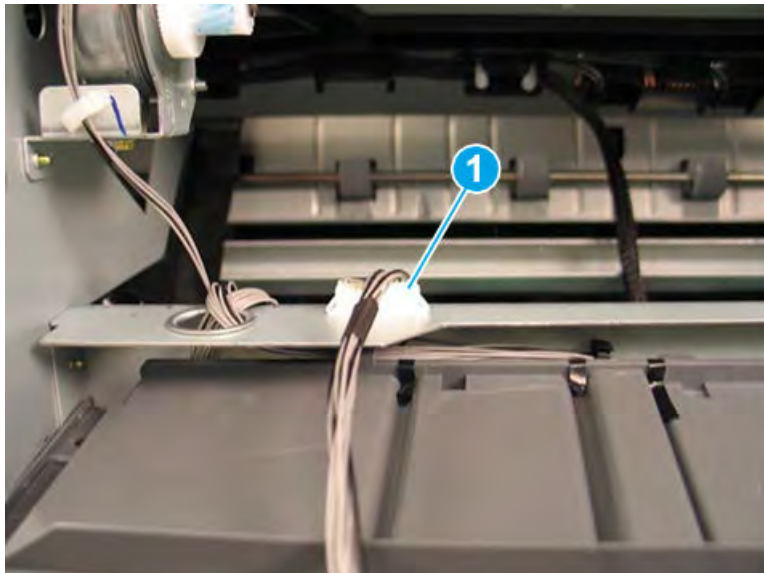
Figure 5-495 Release the shield



4. Disconnect one connector (callout 1), and then remove the upper shield assembly.

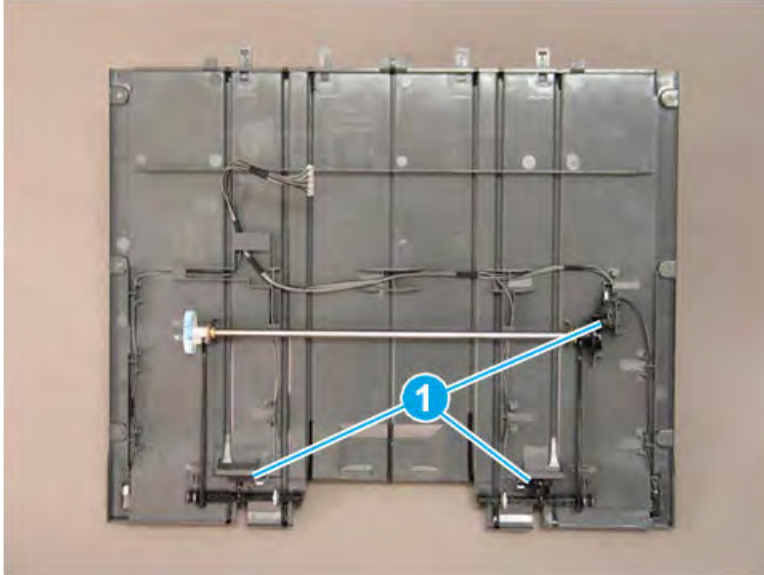
**TIP:** Reverse the removal steps to install the assembly.

Figure 5-496 Disconnect one connector



5. If you are replacing the left upper cover, locate three sensors (callout 1) on the back of the left upper cover. Remove these sensors and transfer them to the replacement part.

Figure 5-497 Remove the left upper cover

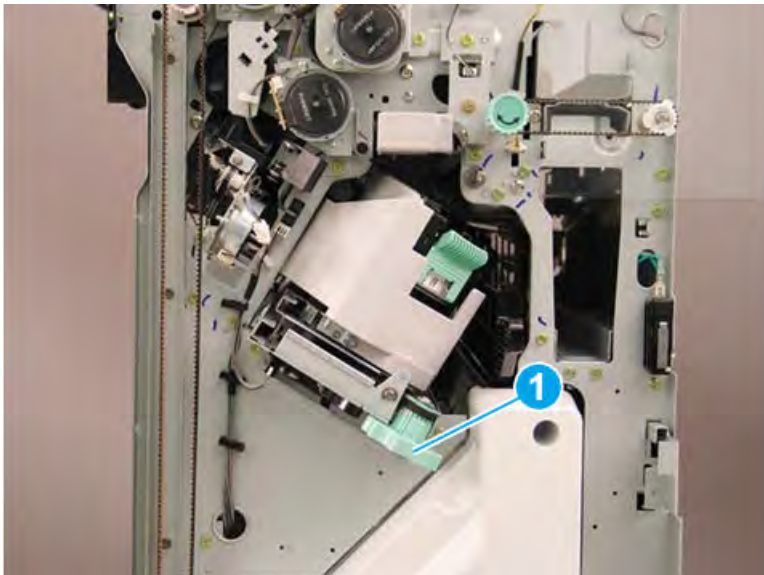


#### Remove the ejector unit (finisher)

Follow these steps to remove the ejector unit (finisher).

1. Rotate the green wheel to move the staple unit to the center of the finisher.

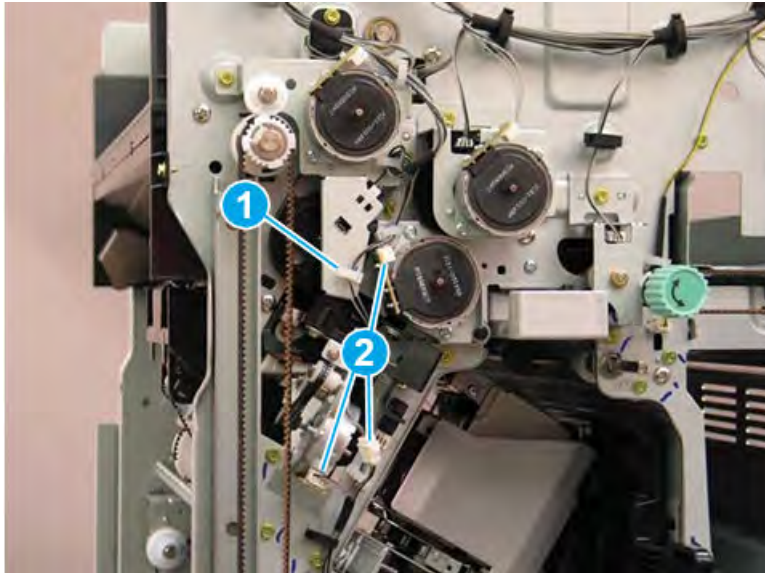
Figure 5-498 Move the staple unit to the center





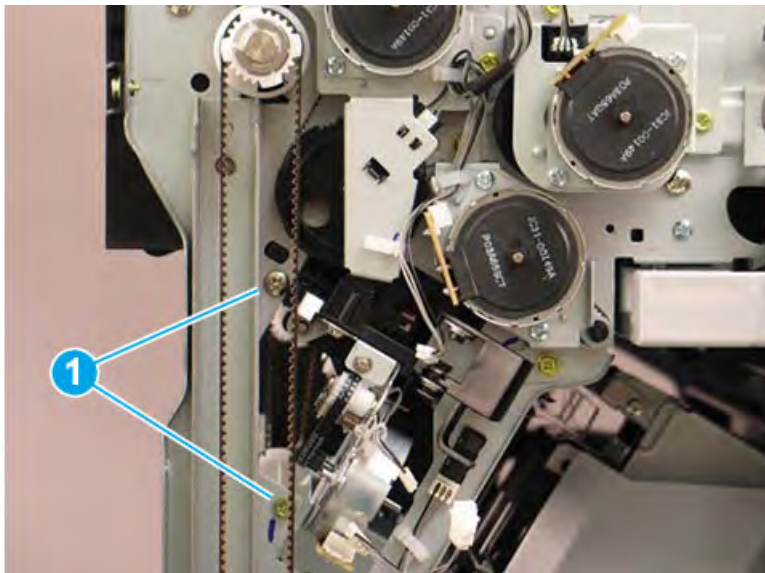
2. Release one retainer (callout 1), and then disconnect three connectors (callout 2).

Figure 5-499 Disconnect three connectors



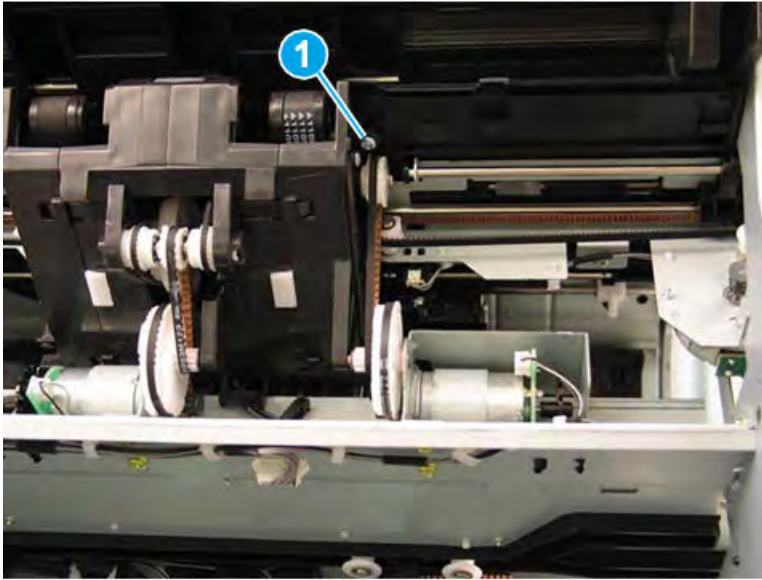
3. Remove two screws (callout 1).

Figure 5-500 Remove two screws



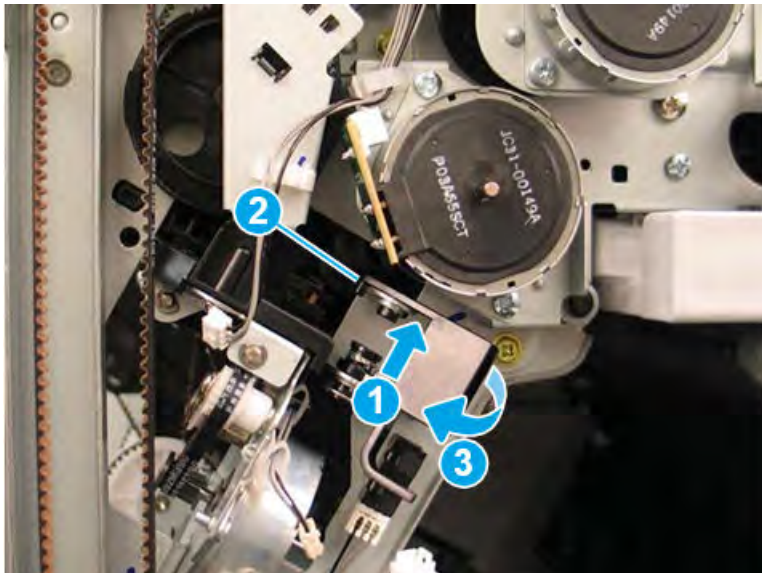
4. At the left side of the finisher, remove one screw (callout 1).

Figure 5-501 Remove one screw



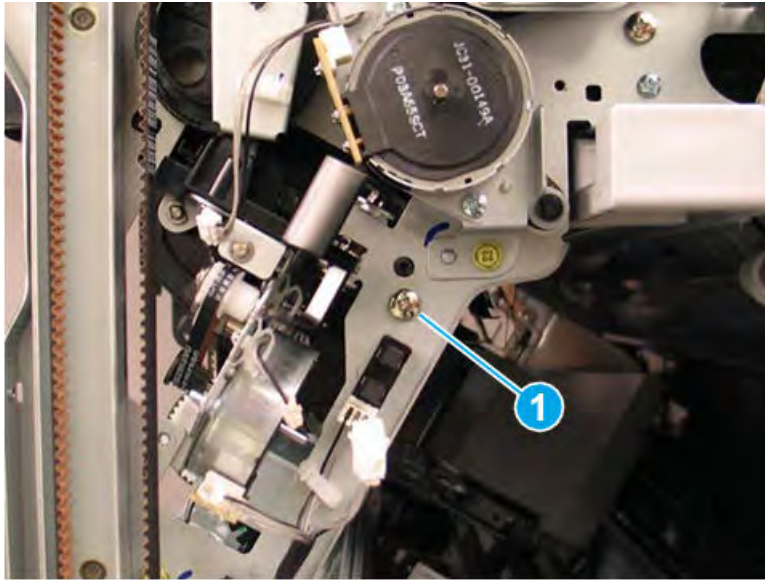
5. Press up on the hinge (callout 1), release one tab (callout 2), and then rotate the sensor away from the finisher (callout 3).

Figure 5-502 Rotate the sensor



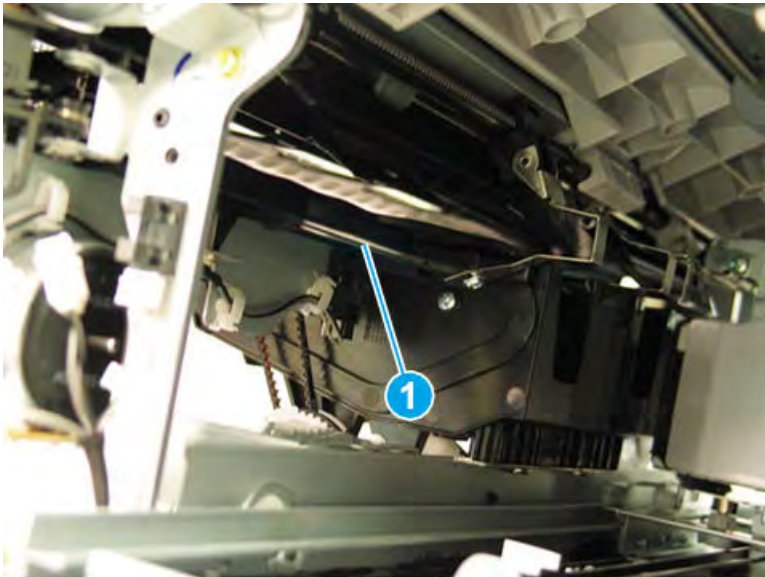
6. Remove one screw (callout 1).

Figure 5-503 Remove one screw



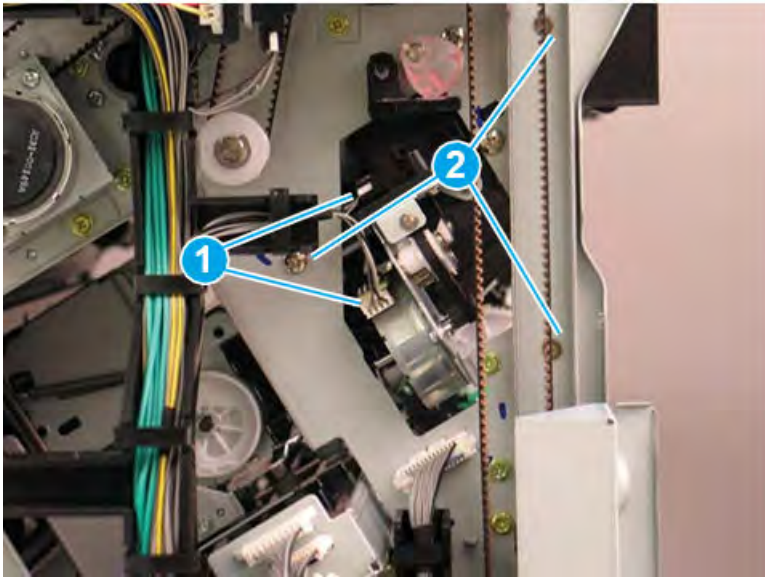
7. Look inside the finisher through the stapler opening in the front and pull down to release and remove one shaft (callout 1) on the front tamper unit.

Figure 5-504 Remove the front tamper shaft



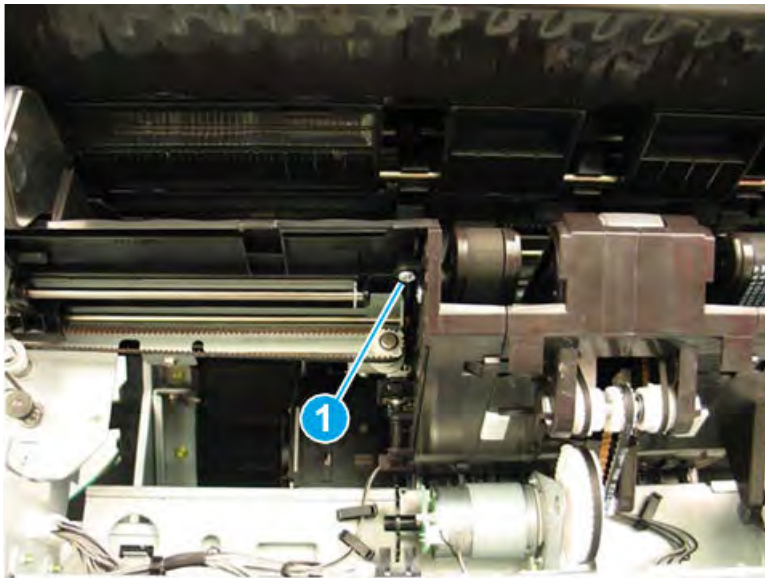
8. At the rear of the finisher, disconnect two connectors (callout 1), and then remove three screws (callout 2).

Figure 5-505 Disconnect two connectors and remove three screws



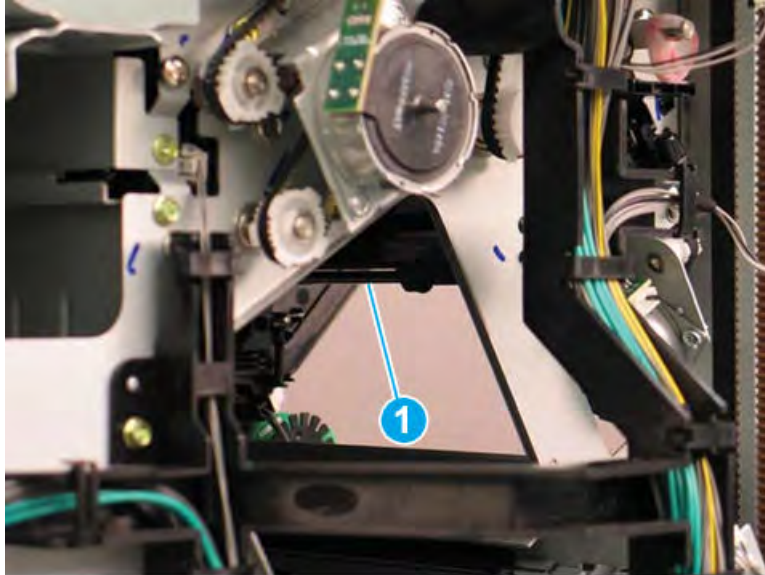
9. At the left side of the finisher, remove one screw (callout 1).

Figure 5-506 Remove one screw



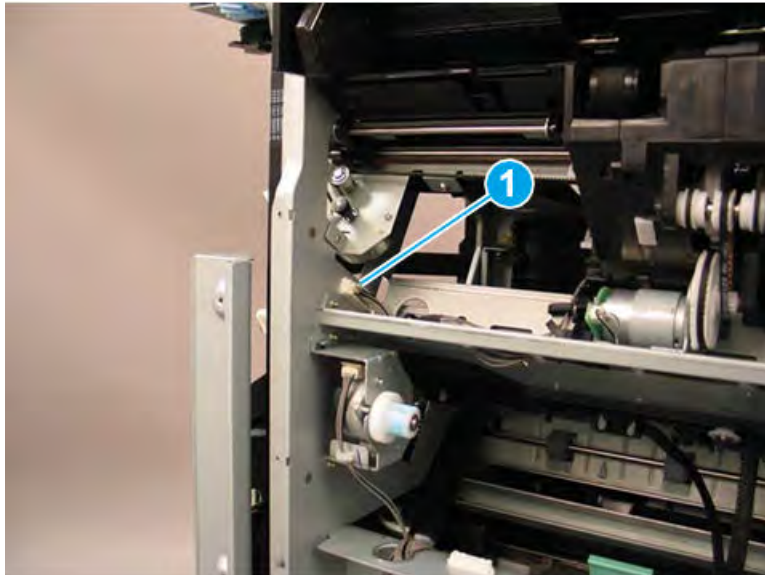
10. Look inside the finisher through the stapler opening in the rear and pull down to release and remove one shaft (callout 1) on the rear tamper unit.

Figure 5-507 Remove the rear tamper shaft



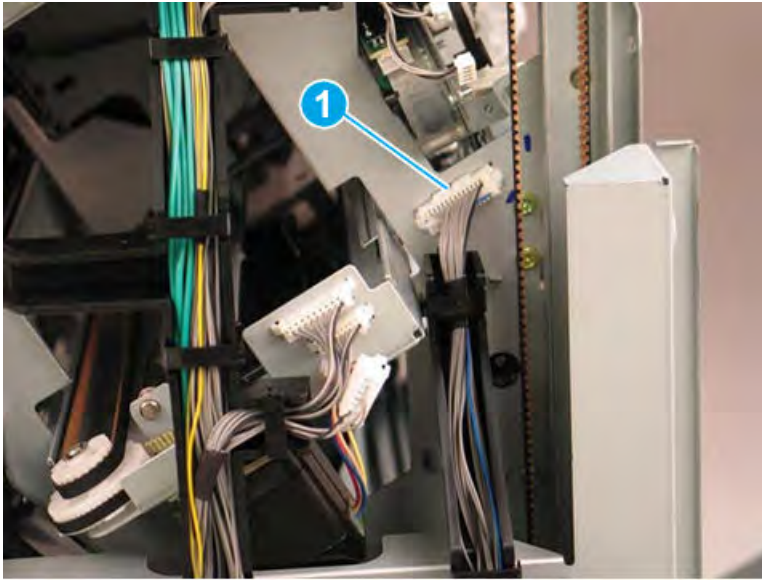
11. At the left side of the finisher, disconnect one connector (callout 1).

Figure 5-508 Disconnect one connector



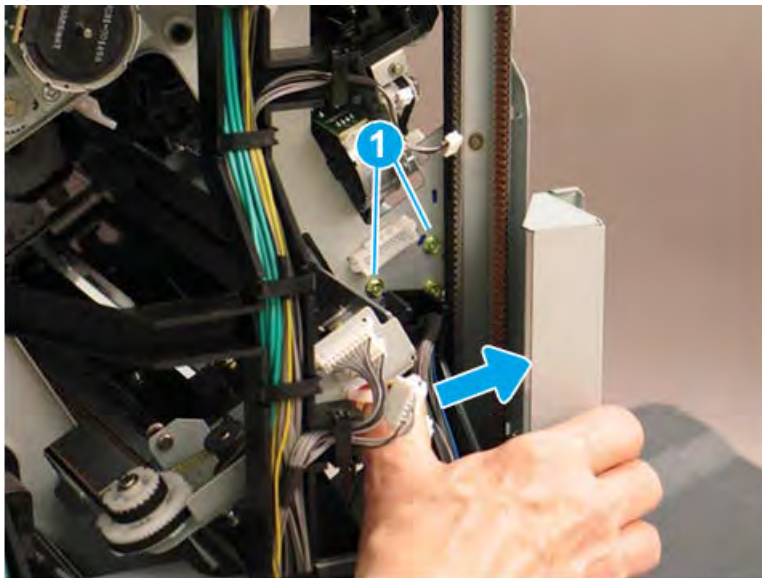
12. At the rear of the finisher, disconnect one connector (callout 1).

Figure 5-509 Disconnect one connector



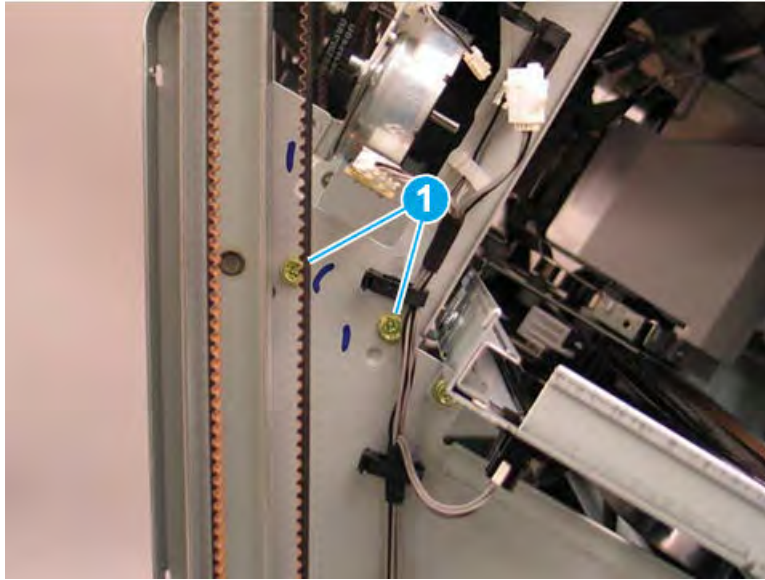
13. At the rear of the finisher, press the wire retainer to the right to access and remove two screws (callout 1).

Figure 5-510 Disconnect one connector



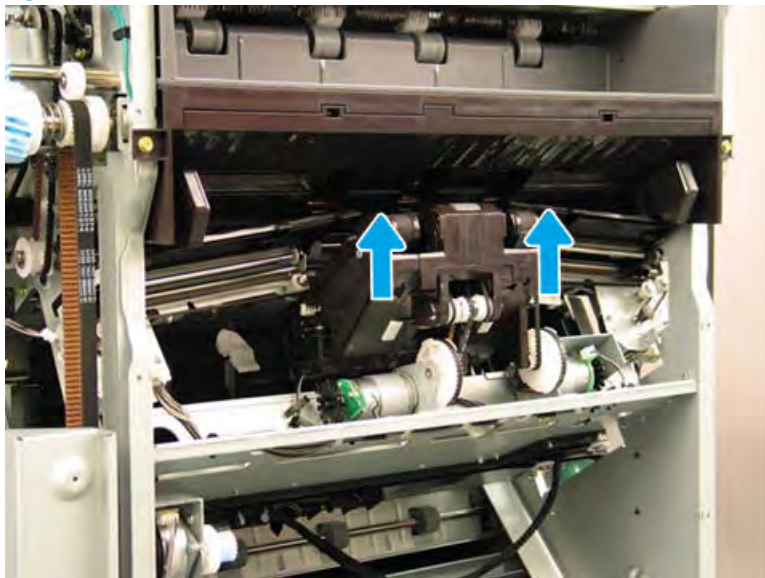
14. At the front of the finisher, remove two screws (callout 1).

Figure 5-511 Remove two screws



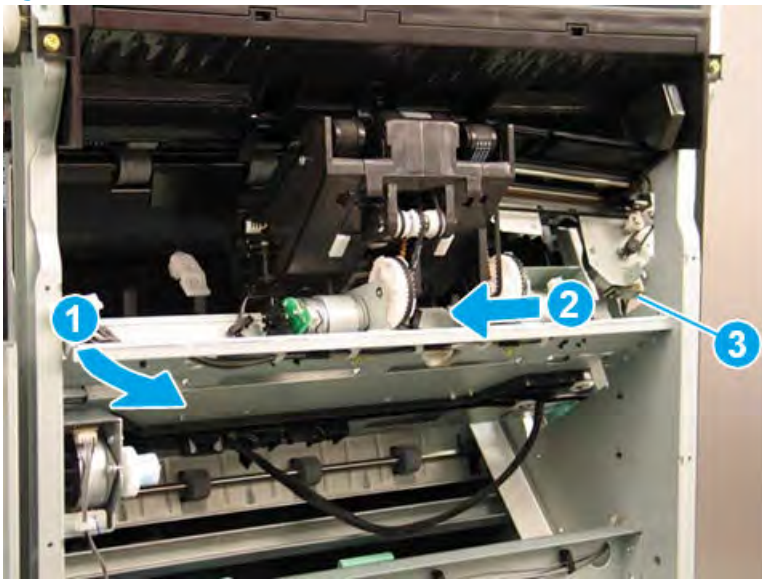
15. Lift the inside edges of the front and rear tampers up.

Figure 5-512 Lift the edges of the tampers



16. Rotate the rear edge of the ejector unit away from the finisher (callout 1), and then slide it toward the rear of the finisher (callout 2) to remove it. Make sure that the PCA (callout 3) stays clear of the sheet metal frame.

Figure 5-513 Remove the ejector unit



17. Reverse the removal steps to install the assembly. Also use the following special installation instructions.

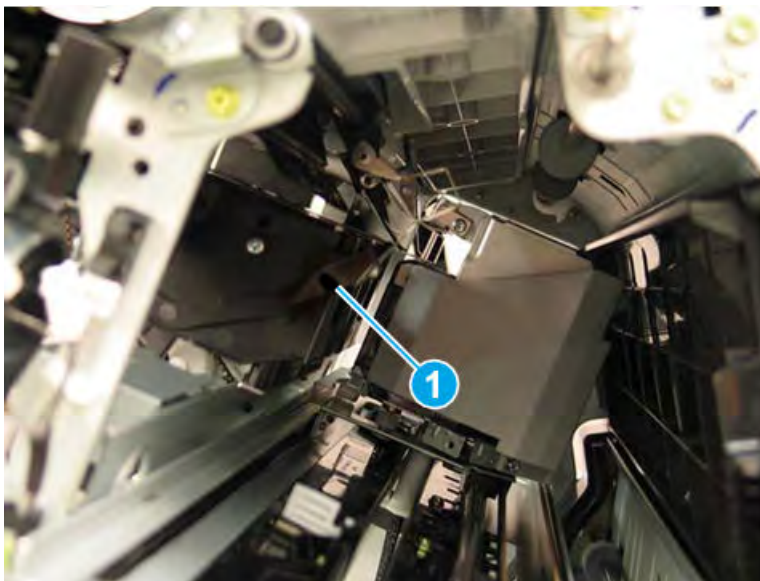
---

 **NOTE:** Continue to reverse the removal steps to finish installing the assembly.

---

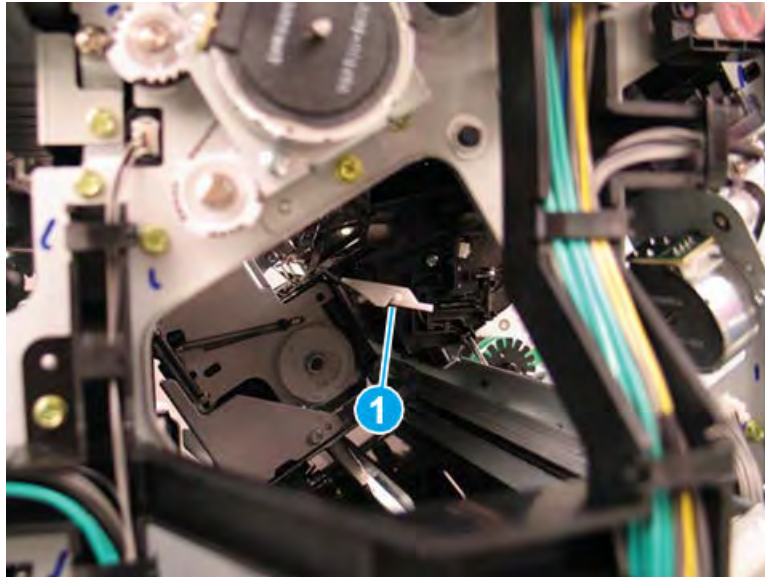
**Special installation instructions: Ejector unit**

- a. When the front tamper shaft is removed, the retainer arm that held the one end of the shaft will drop down. When reinstalling the shaft, raise the retainer arm and position the end of the shaft in the notch (callout 1).





- b. When the rear tamper shaft is removed, the retainer arm that held the one end of the shaft will drop down. When reinstalling the shaft, raise the retainer arm and position the end of the shaft in the notch (callout 1).



### Remove the front tamper unit

Follow these steps to remove the front tamper unit.

- ▲ Lift the front tamper away from the finisher to remove it

**Figure 5-514** Remove the front tamper

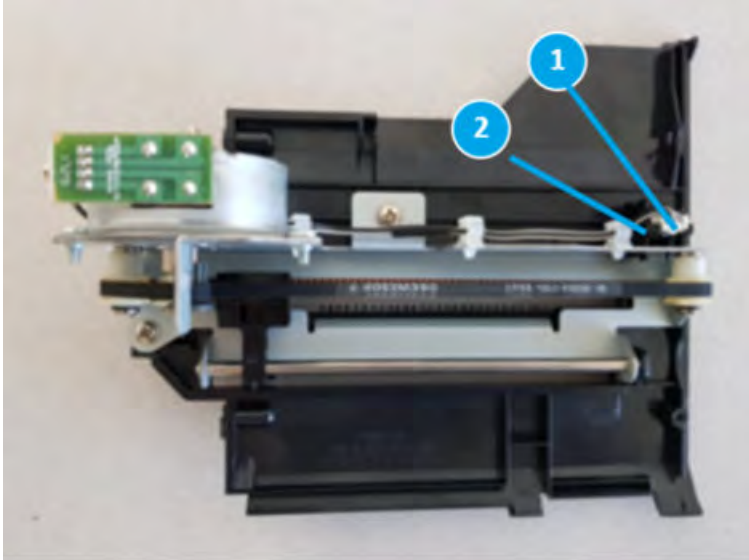


### Remove the end of fence home sensor(S7)

Follow these steps to remove the end of fence home sensor(S7).

- ▲ At the front tamper, disconnect the connector(callout 1) and remove end fence home sensor(S7, callout 2)

Figure 5-515 Remove end fence home sensor



### Unpack the replacement assembly

Follow these steps to unpack the replacement assembly.

1. Dispose of the defective part.




**NOTE:** HP recommends responsible disposal of the defective part.

<http://www8.hp.com/us/en/hp-information/environment/product-recycling.html>

2. Unpack the replacement part from the packaging.



**CAUTION:**  Some parts are sensitive to electrostatic discharge (ESD). Always perform service work at an ESD-protected workstation or mat. If an ESD workstation or mat is not available, touch the sheet-metal chassis to provide a static ground before touching an ESD-sensitive assembly. Protect the ESD-sensitive assemblies by placing them in ESD pouches when they are out of the printer.



**IMPORTANT:** Make sure that all of the shipping materials (for example shipping tape) are removed from the replacement part prior to installation.



**NOTE:** If the replacement part is a roller or pad, avoid touching the spongy part of it. Skin oils on the roller or pad can cause paper pickup and/or print-quality problems. HP recommends using disposable gloves when handling rollers or pads or washing your hands before touching rollers or pads.

3. To install an assembly, reverse the removal steps.




**NOTE:** When applicable, special installation instructions are provided for an assembly at the end of the removal procedure. Always completely read the removal instructions and follow all special installation instructions.

# HP LaserJet Managed MFP E82540-E82560, E87640-E87660, E82540du-E82560du, E87640du-E87660du, E72525-E72535, E77822-E77830 - Removal and replacement: End fence motor (M3)

Learn how to remove and replace the end fence motor.

## Introduction

This document provides the procedures to remove and replace the end fence motor for the finisher.

 **IMPORTANT:** When applicable, special installation instructions are provided for an assembly at the end of the removal procedure. Always completely read the removal instructions and follow all special installation instructions.

## Before performing service

- Turn the printer power off. A shutting-down message appears on the control-panel display.
- ⚠ **WARNING!** To avoid damage to the printer, turn the power off and wait until the printer shuts down before removing the power cable.
- Disconnect the printer power cable after the printer has completely shut down (the control-panel display is blank).
- Release the finisher from the printer by pulling out on the release latch inside the finisher door.
- Disconnect the cable from the bridge unit to the finisher.
- Disconnect the cable from the finisher to the printer.

Use the table below to identify the correct part number for your printer. To order the part, go to <https://parts.hp.com>.

**Table 5-112 Part information**

Part number	Part description
JC90-01467A	End fence motor

## Required tools

- #2 JIS screwdriver with a magnetic tip

## After performing service

- Connect the cable from the finisher to the printer.
- Connect the cable from the bridge unit to the finisher.
- Attach the finisher to the printer, and then push in on the release latch inside the finisher door.
- Connect the printer power cable.
- Turn the printer power on.

## Post service test

Process a job through the finisher and verify that the finisher works correctly.

### Remove the right upper cover (finisher)

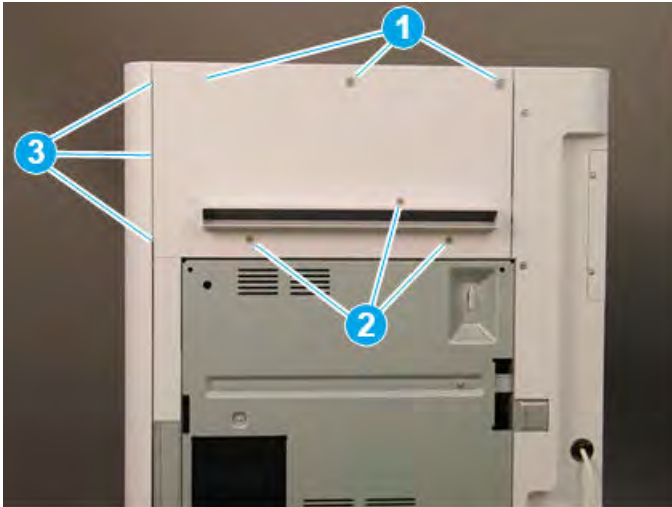
Follow these steps to remove the right upper cover (finisher).

- ▲ Remove one screw cap and three machine screws on the upper edge of the cover (callout 1). Remove three sheet metal screws (callout 2) on the lower portion of the cover. Rotate the right edge of the cover away from the finisher, and then slide the cover right to release three tabs (callout 3).

💡 **TIP:** The lower screws are shorter in length than the upper screws.

**TIP:** Reverse the removal steps to install the assembly.

**Figure 5-516** Remove the right upper cover

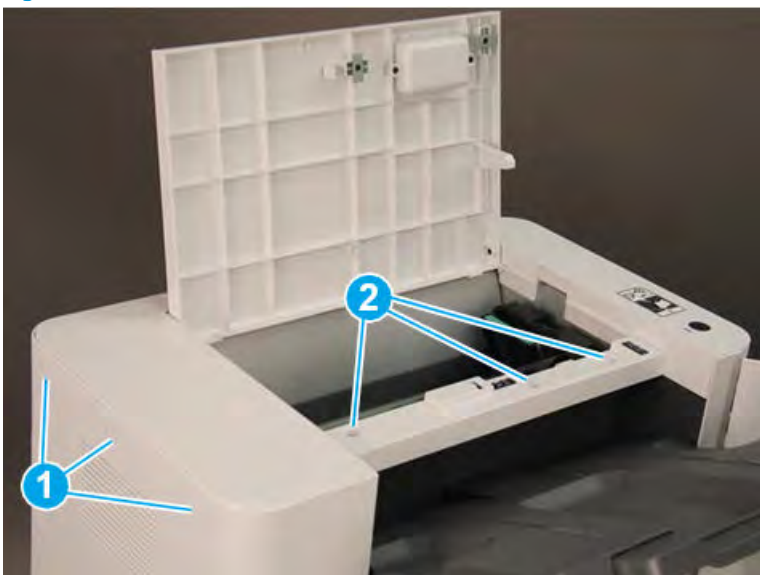


### Remove the top cover (finisher)

Follow these steps to remove the top cover (finisher).

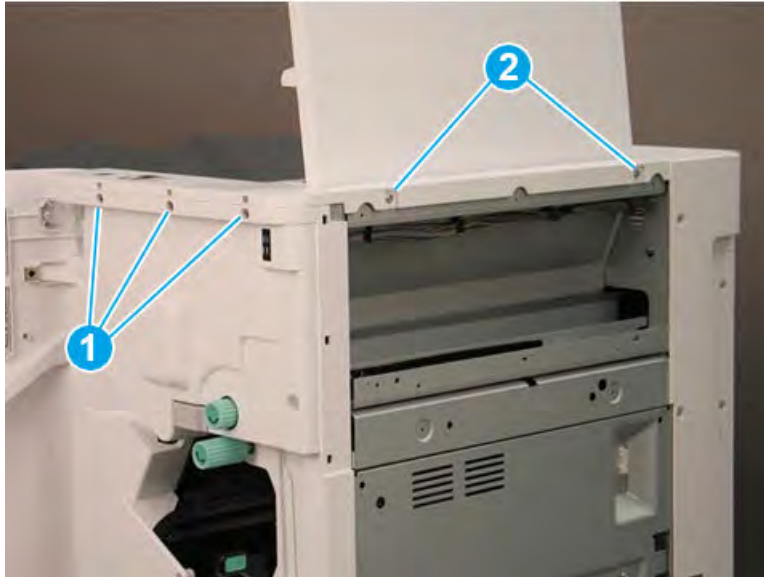
1. Remove three screw caps and three self-tapping screws at the top of the rear cover (callout 1), and then remove three machine screws (callout 2) on top of the cover.

**Figure 5-517** Remove six screws




2. Remove three self-tapping screws at the top of the front cover (callout 1), and then remove two machine screws (callout 2) at the top of the right side.

Figure 5-518 Remove five screws



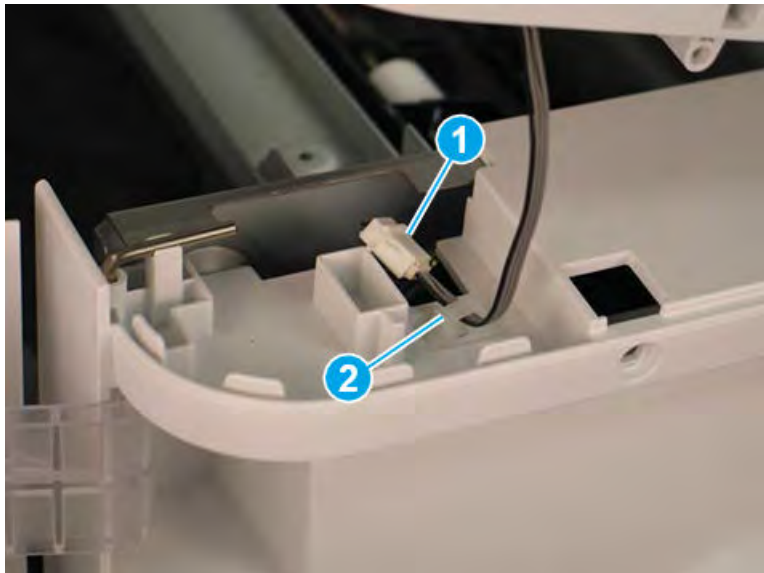
3. Lift the cover up slightly. Disconnect one in-line connector (callout 1), and then release one retainer (callout 2).

---

 **TIP:** Reverse the removal steps to install the assembly.

---

Figure 5-519 Disconnect one connector and release retainer

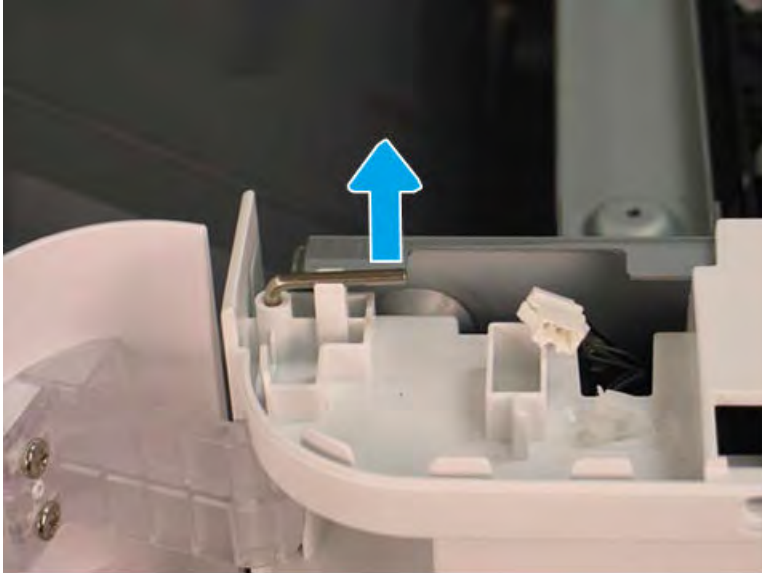


### Remove the front door (finisher)

Follow these steps to remove the front door (finisher).

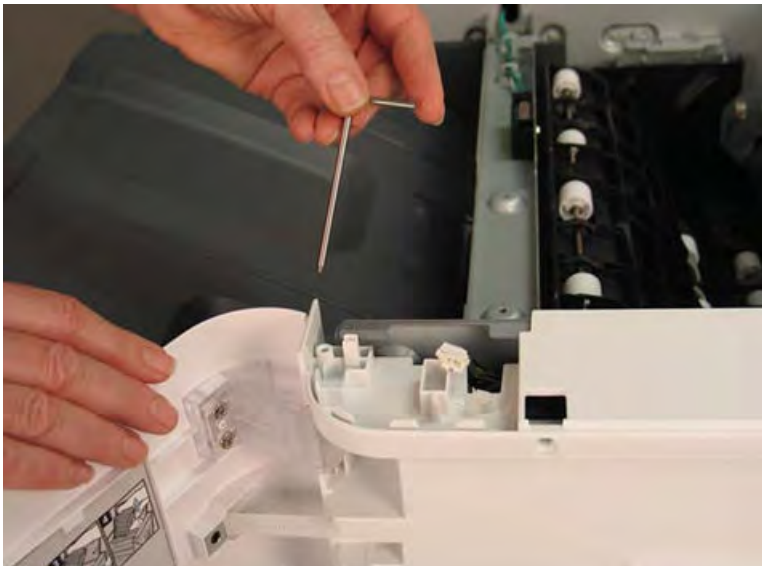
1. Lift the top hinge pin up to release it from the retainer.

Figure 5-520 Lift the top hinge pin



2. Pull the top hinge pin up to remove it.

Figure 5-521 Remove the top hinge pin



3. Use a small, flat-blade screwdriver to release the lower hinge pin from the retainer, and then rotate it away from the finisher.

Figure 5-522 Release the lower hinge pin




4. Support the door with one hand, and then pull the lower hinge pin straight up to remove it.

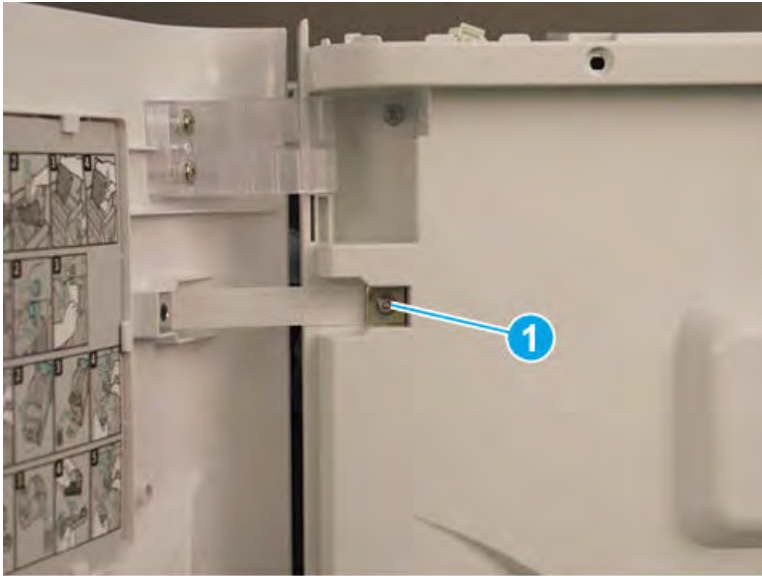
Figure 5-523 Remove the lower hinge pin



5. Support the door with one hand, and then remove one screw (callout 1) to release the strap. Remove the front door.

 **TIP:** Reverse the removal steps to install the assembly.

**Figure 5-524** Remove the front door

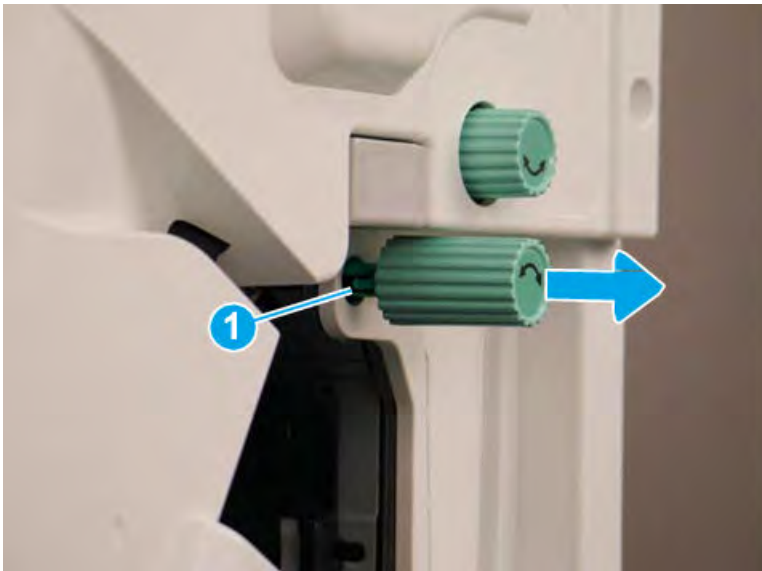


#### Remove the front cover (finisher)

Follow these steps to remove the front cover (finisher).

1. Release one tab (callout 1), and then pull the jam-access knob away from the finisher to remove it.

**Figure 5-525** Remove the jam-access knob



2. If the punch unit is installed, remove the punch waste bin (callout 1).



3. Remove one screw (callout 1) on top of the front cover.

Figure 5-526 Remove one screw



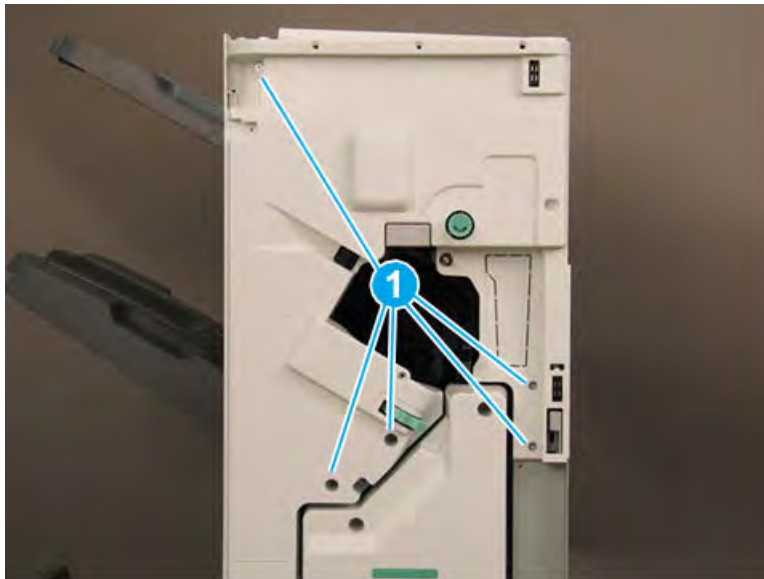
4. Remove five machine screws (callout 1), and then remove the front cover.

---

 **TIP:** Reverse the removal steps to install the assembly.

---

Figure 5-527 Remove the front cover

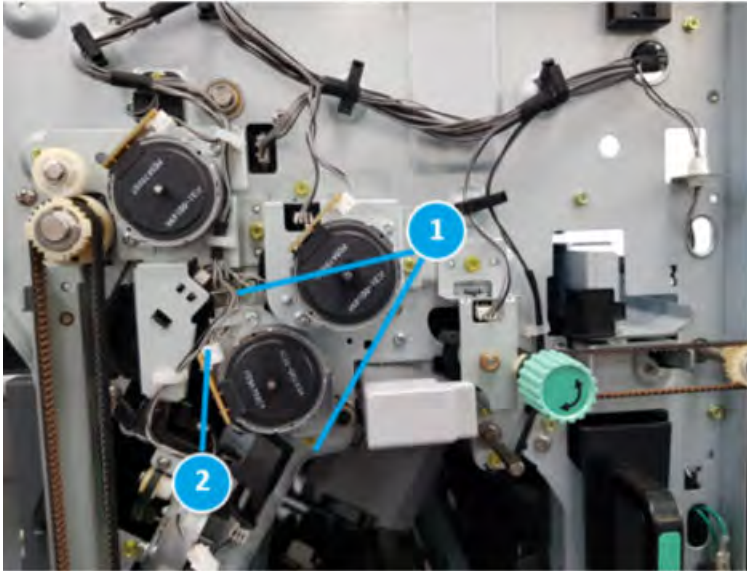


### Remove the end fence motor(M3)

Follow these steps to remove the end fence motor(M3).

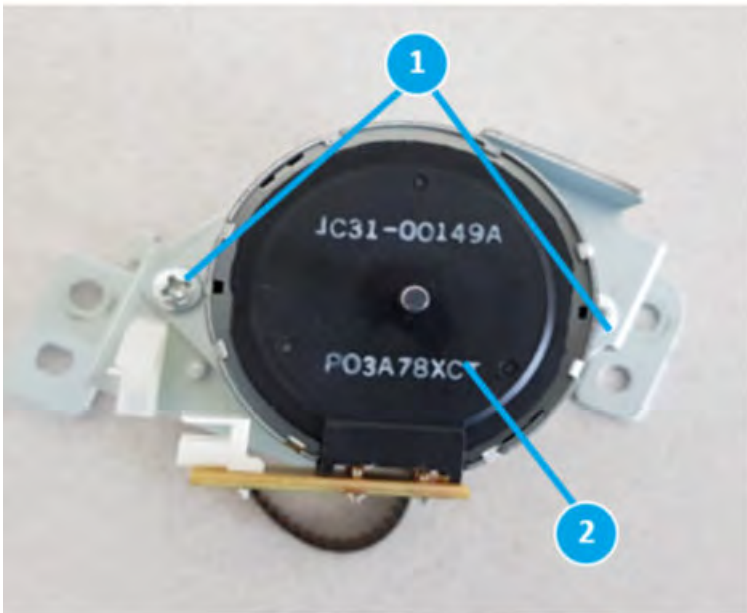
1. At the front of the finisher, remove two screws(callout 1) and disconnect connector(callout 2)

Figure 5-528 Remove two screws and disconnect connector



2. Remove two screws(callout 1) and end fence motor (M3, callout 1)

Figure 5-529 Remove end fence motor



#### Unpack the replacement assembly

Follow these steps to unpack the replacement assembly.

1. Dispose of the defective part.



---

 **NOTE:** HP recommends responsible disposal of the defective part.


<http://www8.hp.com/us/en/hp-information/environment/product-recycling.html>

---

2. Unpack the replacement part from the packaging.


 **CAUTION:**  Some parts are sensitive to electrostatic discharge (ESD). Always perform service work at an ESD-protected workstation or mat. If an ESD workstation or mat is not available, touch the sheet-metal chassis to provide a static ground before touching an ESD-sensitive assembly. Protect the ESD-sensitive assemblies by placing them in ESD pouches when they are out of the printer.

 **IMPORTANT:** Make sure that all of the shipping materials (for example shipping tape) are removed from the replacement part prior to installation.

 **NOTE:** If the replacement part is a roller or pad, avoid touching the spongy part of it. Skin oils on the roller or pad can cause paper pickup and/or print-quality problems. HP recommends using disposable gloves when handling rollers or pads or washing your hands before touching rollers or pads.

---

3. To install an assembly, reverse the removal steps.

 **NOTE:** When applicable, special installation instructions are provided for an assembly at the end of the removal procedure. Always completely read the removal instructions and follow all special installation instructions.

---

## Tamper unit


Front tamper

## HP LaserJet Managed MFP E82540-E82560, E87640-E87660, E82540du-E82560du, E87640du-E87660du, E72525-E72535, E77822-E77830 - Removal and replacement: Front tamper unit


Learn how to remove and replace the front tamper unit.

### Introduction

This document provides the procedures to remove and replace the front tamper unit on the finisher.

 **IMPORTANT:** When applicable, special installation instructions are provided for an assembly at the end of the removal procedure. Always completely read the removal instructions and follow all special installation instructions.

### Before performing service

- Turn the printer power off. A shutting-down message appears on the control-panel display.
-  **WARNING!** To avoid damage to the printer, turn the power off and wait until the printer shuts down before removing the power cable.
- Disconnect the printer power cable after the printer has completely shut down (the control-panel display is blank).
- Release the finisher from the printer by pulling out on the release latch inside the finisher door.
- Disconnect the cable from the bridge unit to the finisher.
- Disconnect the cable from the finisher to the printer.

Use the table below to identify the correct part number for your printer. To order the part, go to <https://parts.hp.com>.

**Table 5-113 Part information**

Part number	Part description
JC82-00901A	Front tamper

### Required tools

- #2 JIS screwdriver with a magnetic tip
- Small, flat-blade screwdriver

### After performing service

- Connect the cable from the finisher to the printer.
- Connect the cable from the bridge unit to the finisher.
- Attach the finisher to the printer, and then push in on the release latch inside the finisher door.
- Connect the printer power cable.
- Turn the printer power on.

## Post service test

Process a job through the finisher and verify that the finisher works correctly.

## Remove the right upper cover (finisher)

Follow these steps to remove the right upper cover (finisher).

- ▲ Remove one screw cap and three machine screws on the upper edge of the cover (callout 1). Remove three sheet metal screws (callout 2) on the lower portion of the cover. Rotate the right edge of the cover away from the finisher, and then slide the cover right to release three tabs (callout 3).

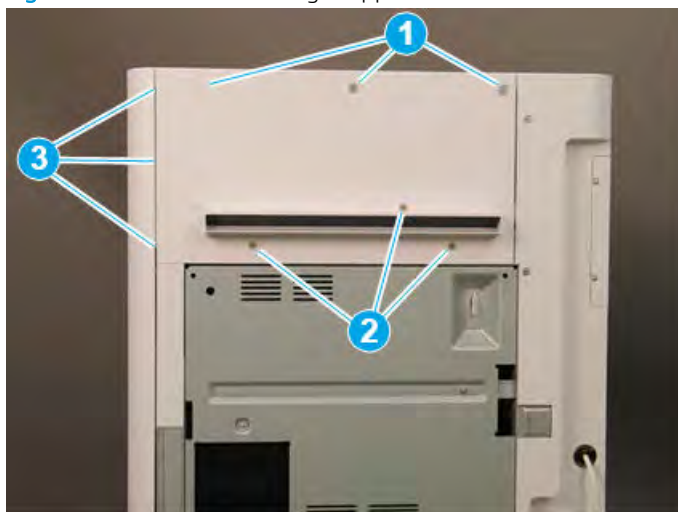
---

💡 **TIP:** The lower screws are shorter in length than the upper screws.

**TIP:** Reverse the removal steps to install the assembly.

---

**Figure 5-530** Remove the right upper cover

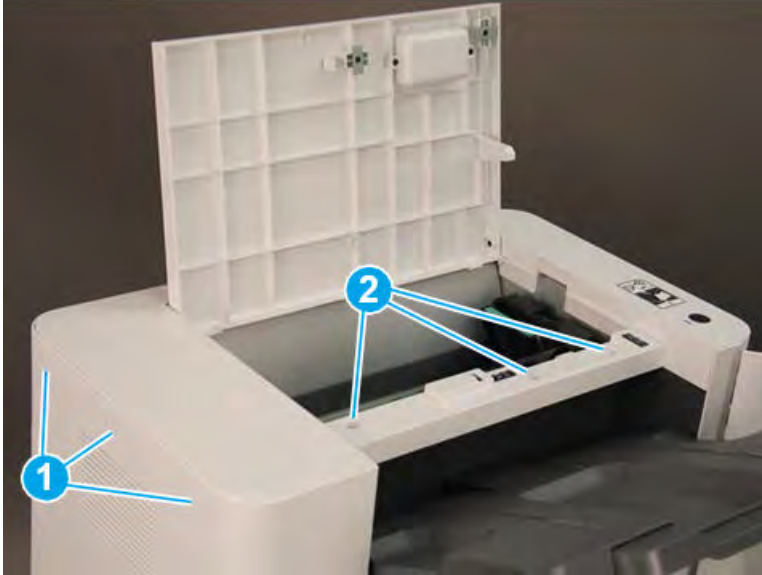


## Remove the top cover (finisher)

Follow these steps to remove the top cover (finisher).

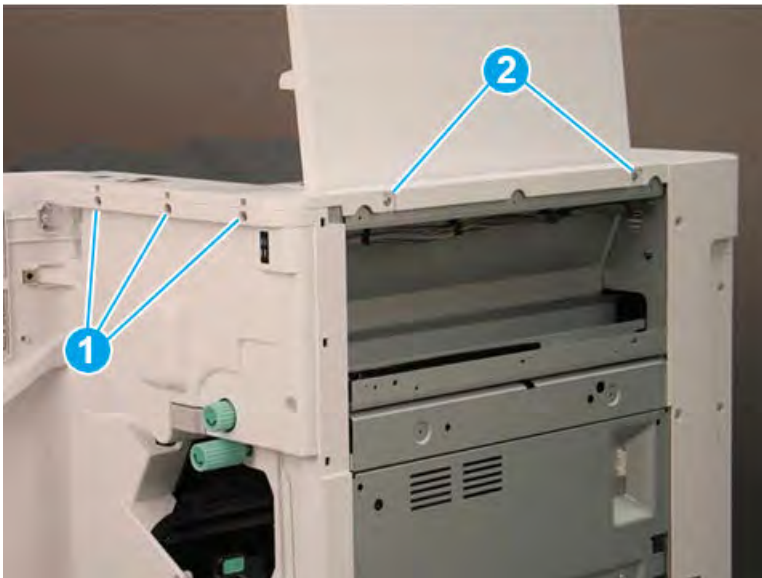
1. Remove three screw caps and three self-tapping screws at the top of the rear cover (callout 1), and then remove three machine screws (callout 2) on top of the cover.

Figure 5-531 Remove six screws




2. Remove three self-tapping screws at the top of the front cover (callout 1), and then remove two machine screws (callout 2) at the top of the right side.

Figure 5-532 Remove five screws

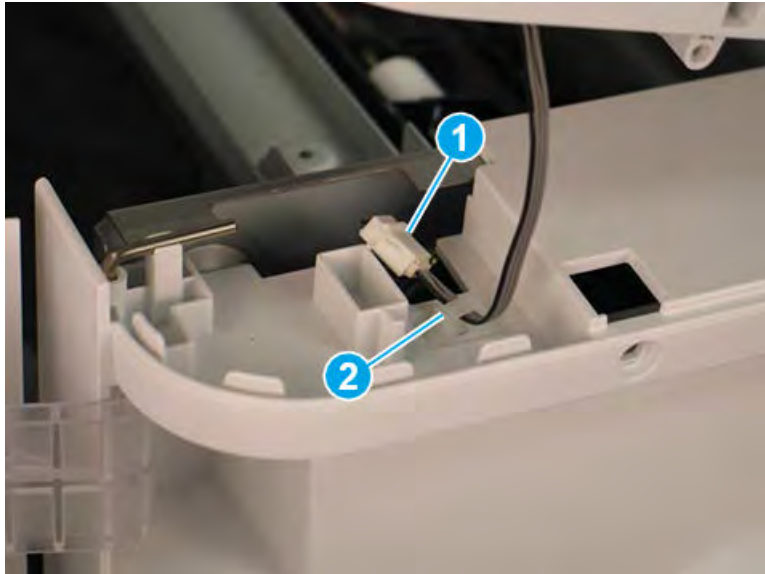




3. Lift the cover up slightly. Disconnect one in-line connector (callout 1), and then release one retainer (callout 2).

 **TIP:** Reverse the removal steps to install the assembly.

**Figure 5-533** Disconnect one connector and release retainer

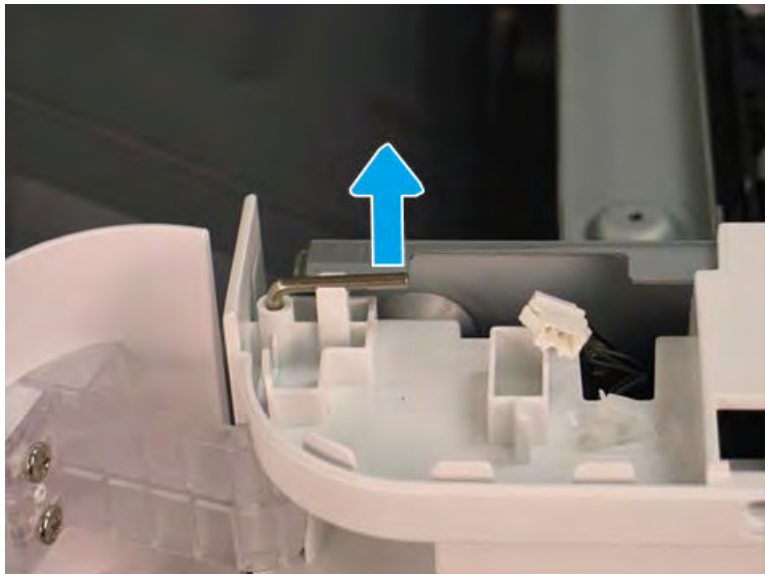


#### Remove the front door (finisher)

Follow these steps to remove the front door (finisher).

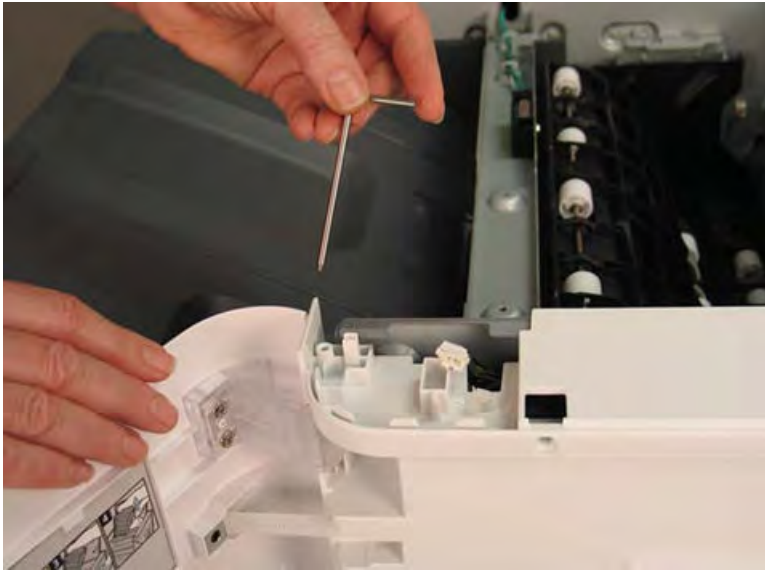
1. Lift the top hinge pin up to release it from the retainer.

**Figure 5-534** Lift the top hinge pin



2. Pull the top hinge pin up to remove it.

**Figure 5-535** Remove the top hinge pin



3. Use a small, flat-blade screwdriver to release the lower hinge pin from the retainer, and then rotate it away from the finisher.

**Figure 5-536** Release the lower hinge pin




4. Support the door with one hand, and then pull the lower hinge pin straight up to remove it.

Figure 5-537 Remove the lower hinge pin



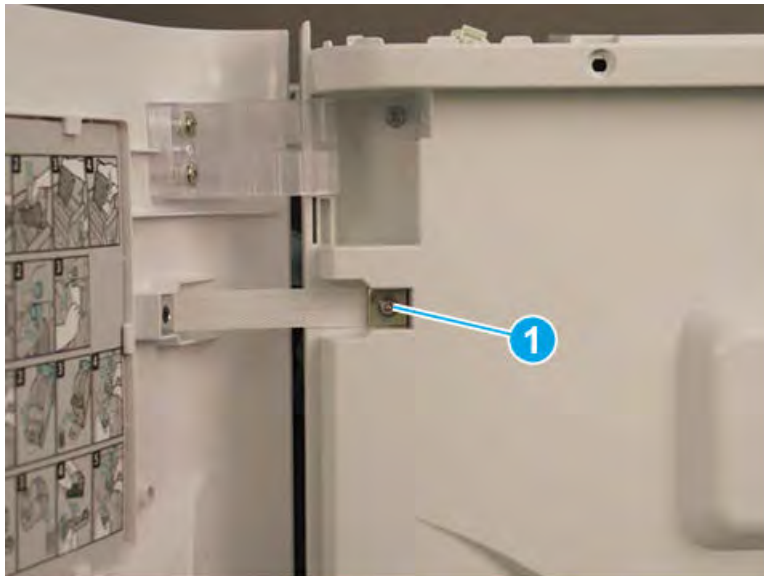
5. Support the door with one hand, and then remove one screw (callout 1) to release the strap. Remove the front door.

---

 **TIP:** Reverse the removal steps to install the assembly.

---

Figure 5-538 Remove the front door

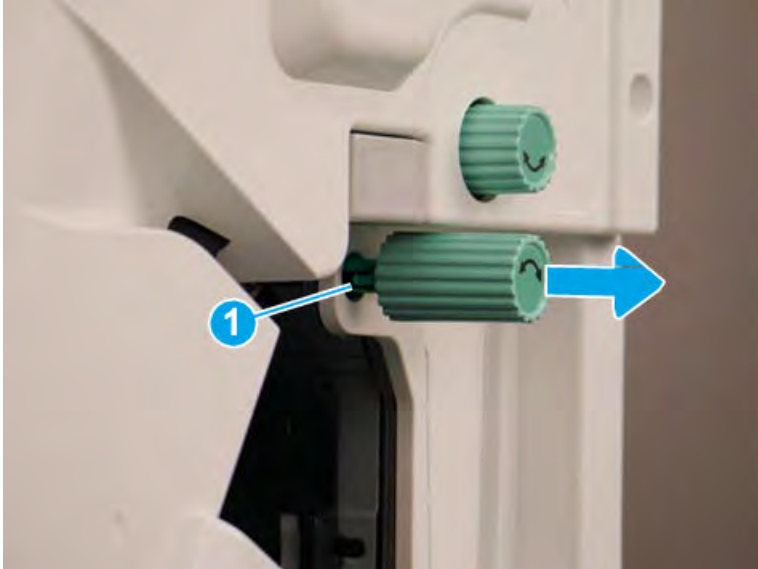


### Remove the front cover (finisher)

Follow these steps to remove the front cover (finisher).

1. Release one tab (callout 1), and then pull the jam-access knob away from the finisher to remove it.

Figure 5-539 Remove the jam-access knob




2. If the punch unit is installed, remove the punch waste bin (callout 1).
3. Remove one screw (callout 1) on top of the front cover.

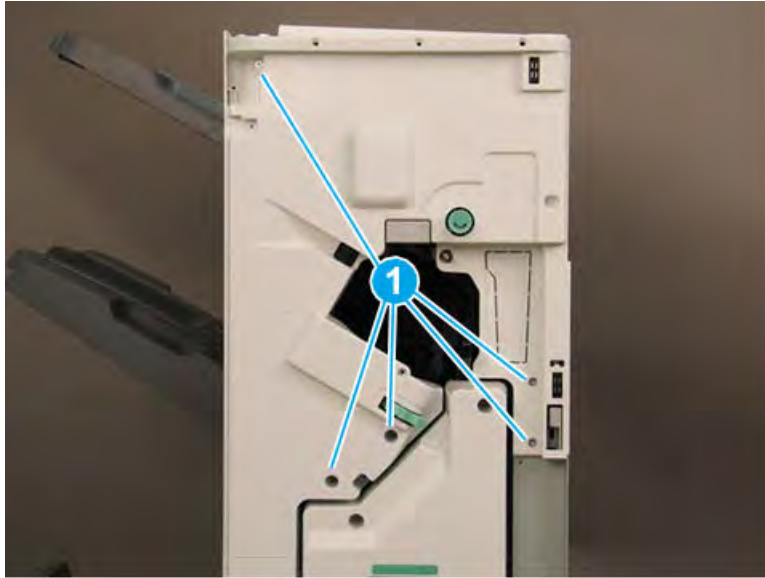
Figure 5-540 Remove one screw



4. Remove five machine screws (callout 1), and then remove the front cover.

 **TIP:** Reverse the removal steps to install the assembly.

**Figure 5-541** Remove the front cover

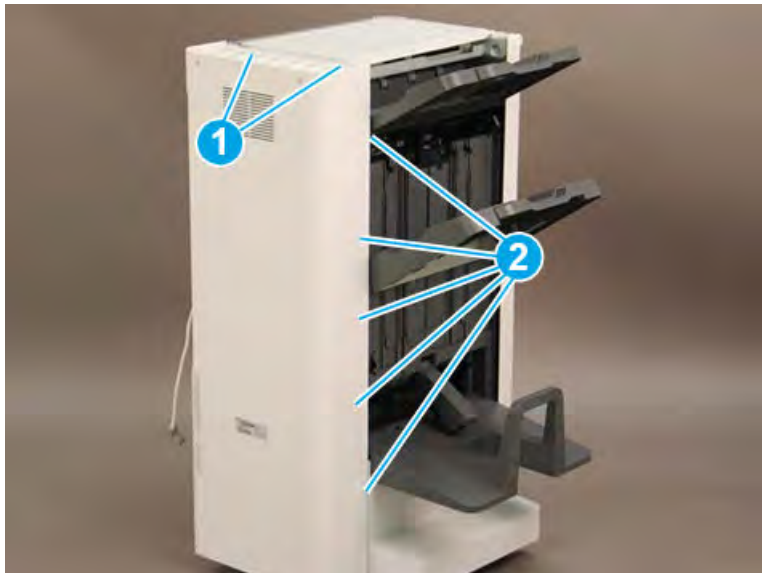


#### Remove the rear cover (finisher)

Follow these steps to remove the rear cover (finisher).

1. Remove two self-tapping screws (callout 1) on the top of the rear cover, and then remove five screw caps and five machine screws (callout 2) on the left side of the cover.

**Figure 5-542** Remove seven screws

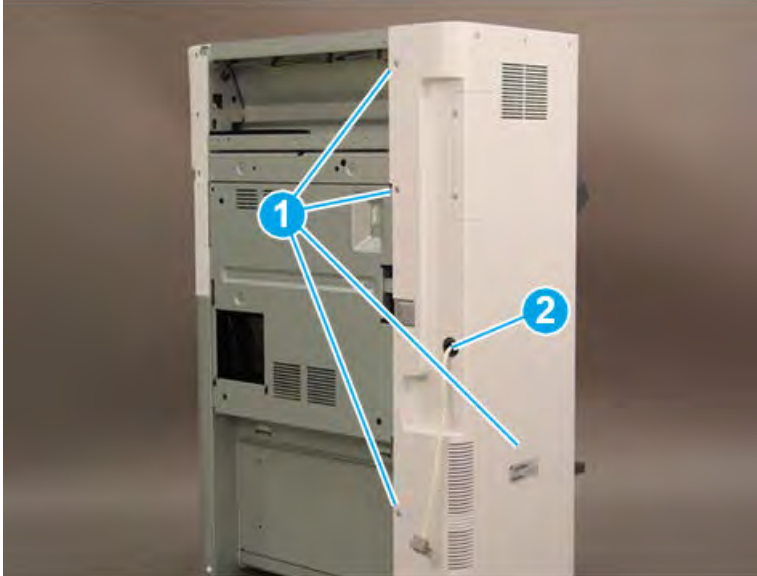


2. Remove one screw cap and four machine screws (callout 1) Remove the rear cover.

 **NOTE:** Make sure to thread the power cable (callout 2) through the opening in the cover.

 **TIP:** Reverse the removal steps to install the assembly

**Figure 5-543** Remove the rear cover

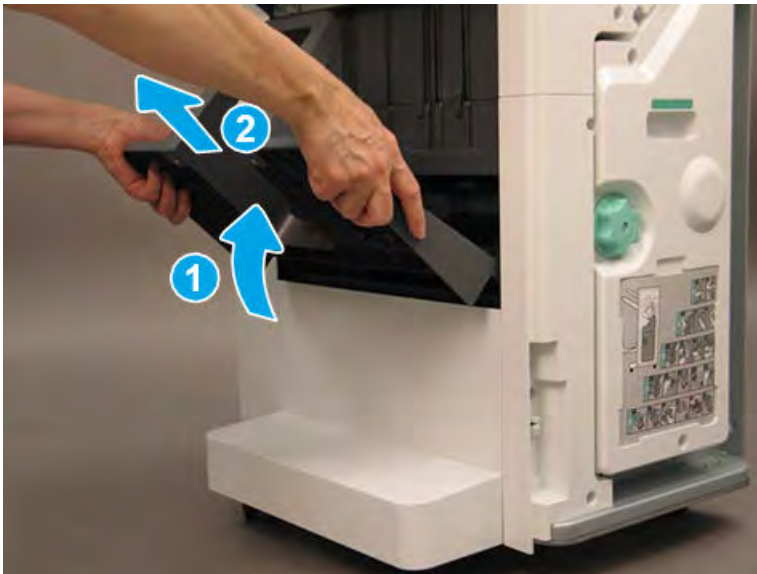


### Remove the booklet output tray

Follow these steps to remove the booklet output tray.

1. Raise the booklet output tray up (callout 1), and then pull it away from the finisher (callout 2) to remove it.

**Figure 5-544** Remove the booklet output tray



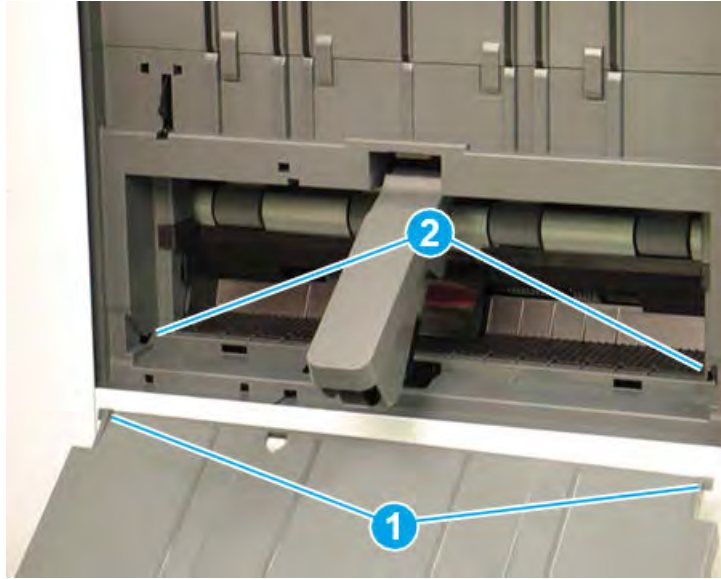
- Reverse the removal steps to install the assembly. Also use the following special installation instructions.

 **NOTE:** Continue to reverse the removal steps to finish installing the assembly

Special installation instructions: booklet output tray

Position the tabs (callout 1) on the tray into the slots (callout 2) on the finisher.

**Figure 5-545** Install the booklet output tray

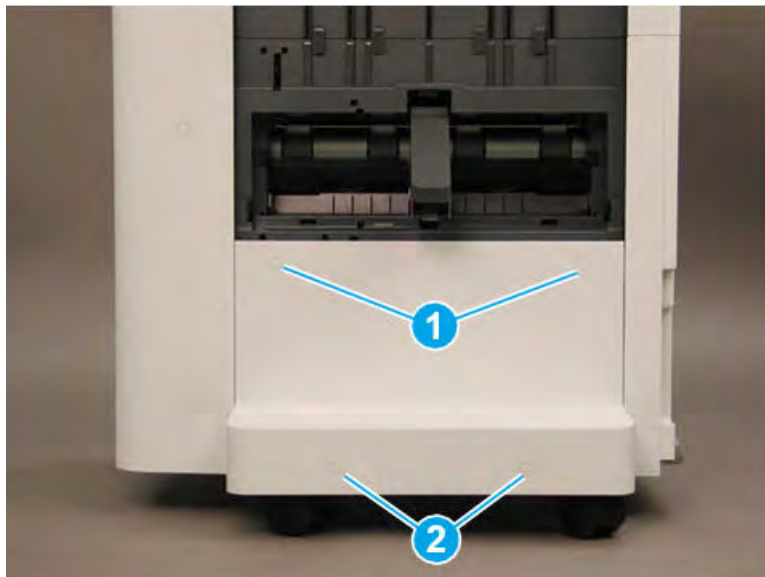


### Remove the caster cover

Follow these steps to remove the caster cover.


- Remove two screw caps and two self-tapping screws (callout 1). Remove two screw caps and two machine screws (callout 2).

**Figure 5-546** Remove four screws



2. Rotate the left edge of the cover away from the finisher (callout 1), and then slide the cover to the left (callout 2) to remove it.

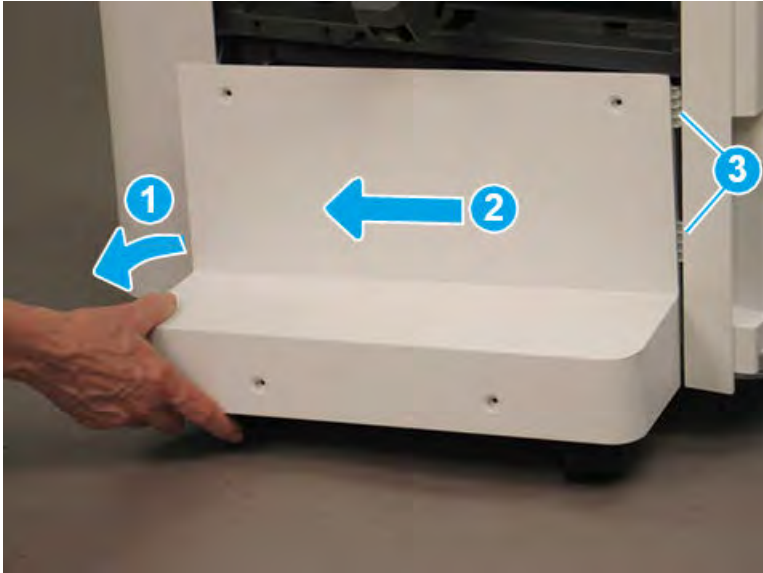
---

 **TIP:** Make sure that two tabs (callout 3) are positioned under the front lower cover when reinstalling the caster cover.

**TIP:** Reverse the removal steps to install the assembly

---

**Figure 5-547** Remove the caster cover




#### Remove the left lower cover (finisher)

Follow these steps to remove the left lower cover (finisher).

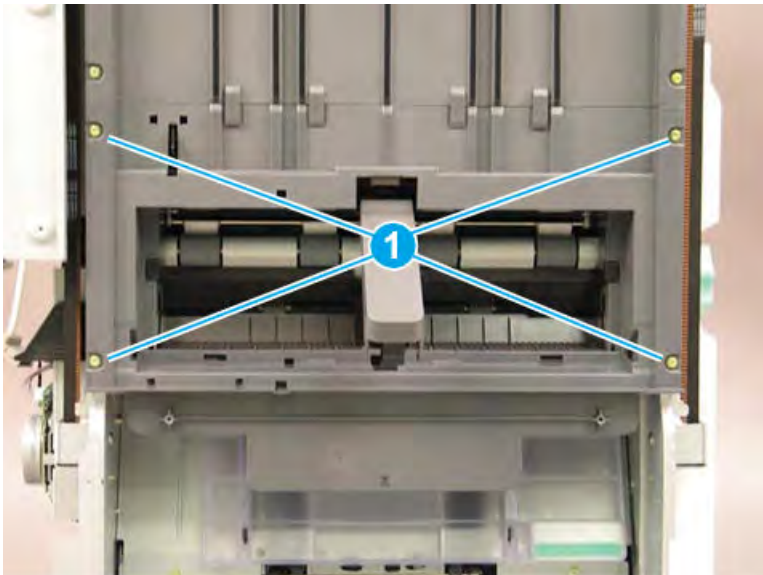
1. Remove four screws (callout 1).

---

 **NOTE:** Raise the lower output tray as needed to access the screws.

---

**Figure 5-548** Remove four screws



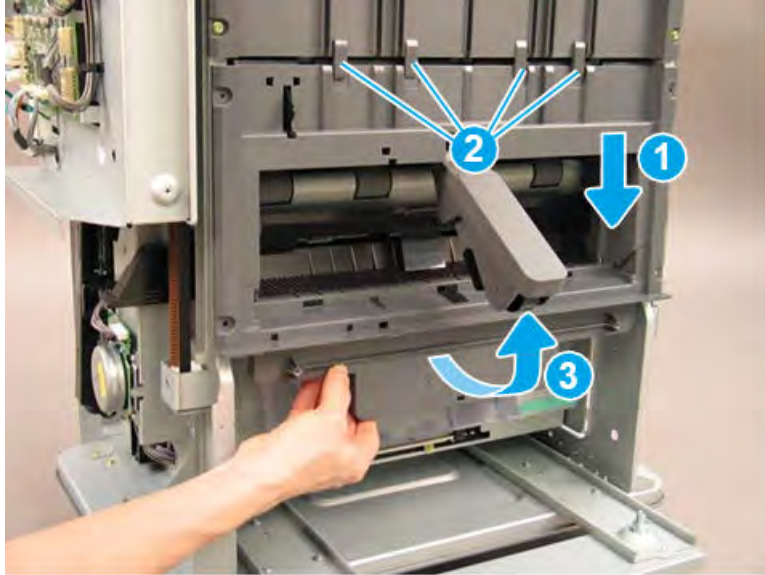


- Slide the shield down (callout 1) to release it from four tabs (callout 2), and then rotate it away from the finisher (callout 3).

**CAUTION:** The shield is still attached to the finisher. Do not attempt to completely remove the shield.

**TIP:** Position the shield under the four tabs (callout 2) when reinstalling it.

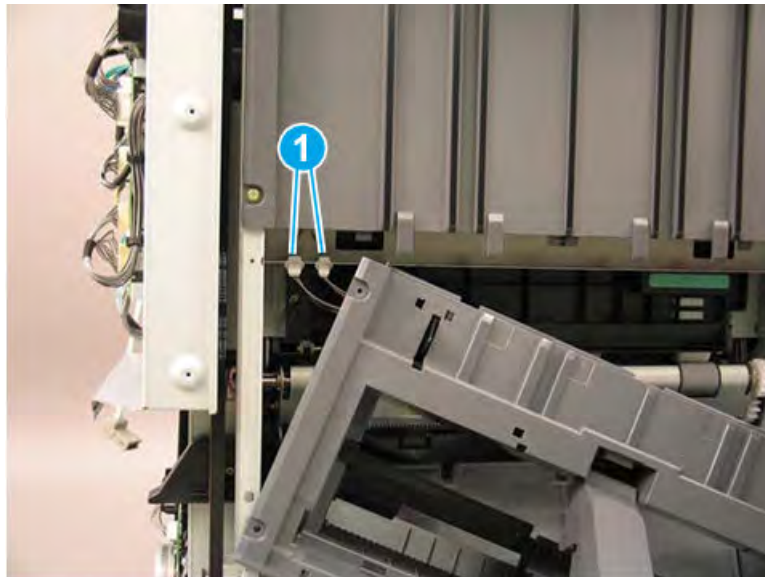
Figure 5-549 Release the lower shield



- Disconnect two connectors (callout 1), and then remove the shield.

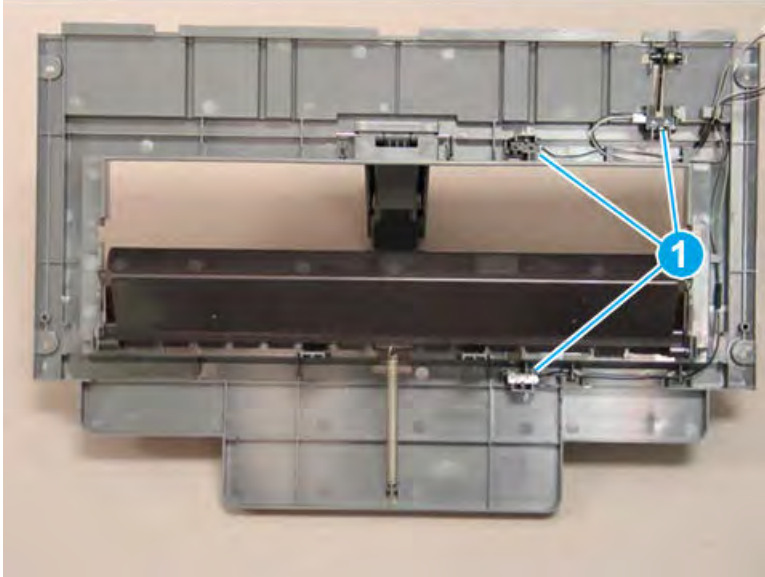
**TIP:** Reverse the removal steps to install the assembly.

Figure 5-550 Disconnect two connectors



4. If you are replacing the left lower cover, locate three sensors (callout 1) on the back of the left lower cover. Remove these sensors and transfer them to the replacement part.

**Figure 5-551** Remove the left lower cover

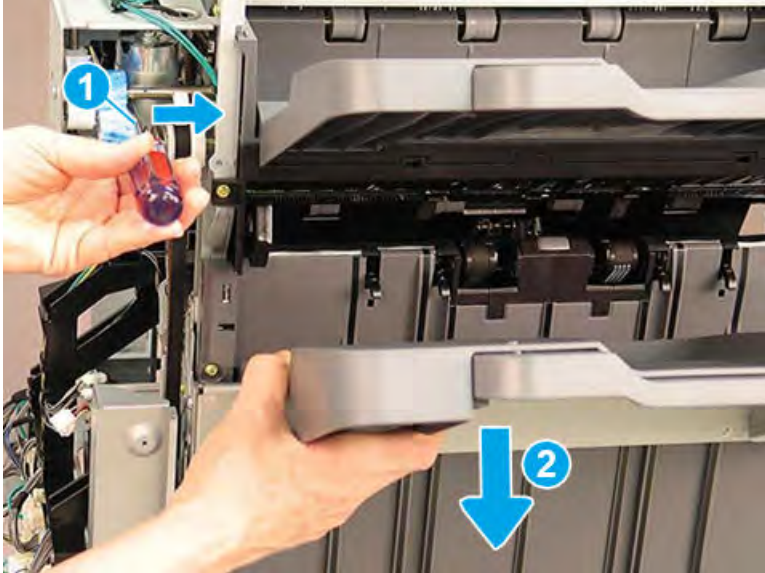


#### Remove the left upper cover (finisher)

Follow these steps to remove the left upper cover (finisher).

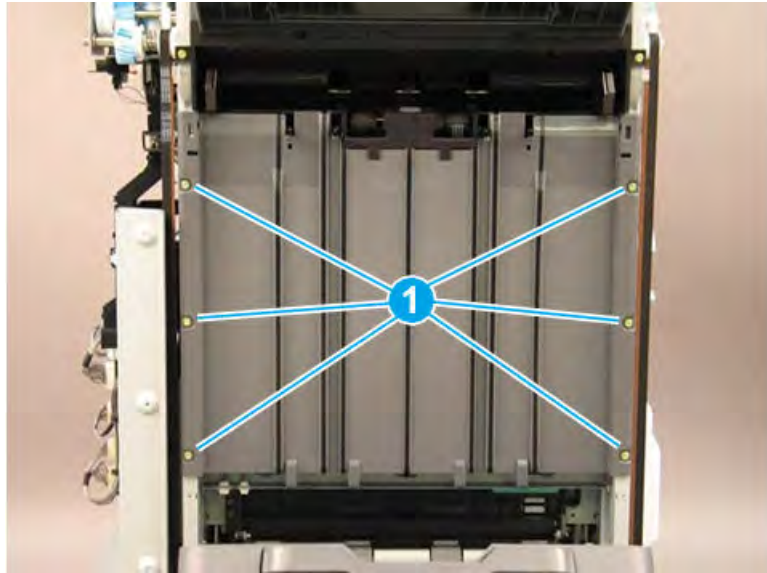
1. Bring the lower output tray down by positioning the shaft of a screwdriver on the clutch (callout 1) and gently pressing to the right to release the clutch. Hold the clutch in the released position and lower the tray (callout 2) to the lowest position.

**Figure 5-552** Lower the output tray



2. Remove six machine screws (callout 1).

Figure 5-553 Remove six screws

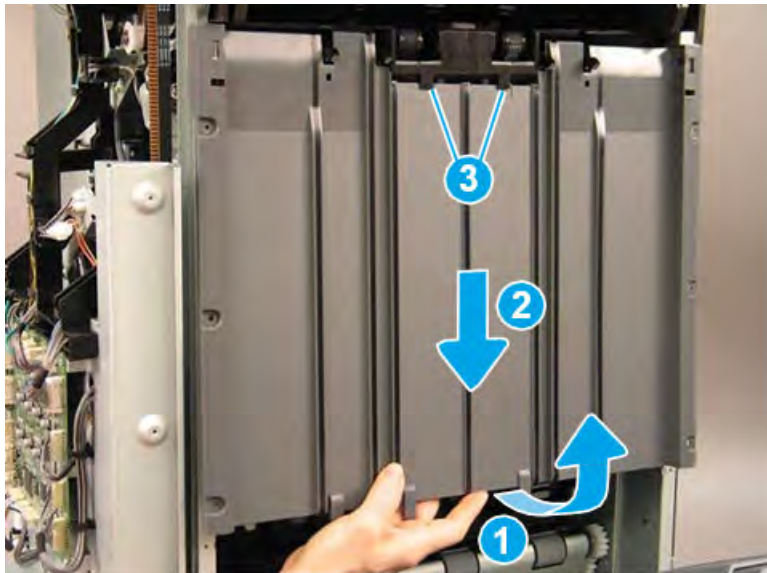


3. Rotate the lower edge of the shield away from the finisher (callout 1), and then slide the shield down (callout 2) to release it from two tabs (callout 3).


**CAUTION:** The shield is still attached to the finisher. Do not attempt to completely remove the shield.

**TIP:** Position the shield under the two tabs (callout 3) when reinstalling it.

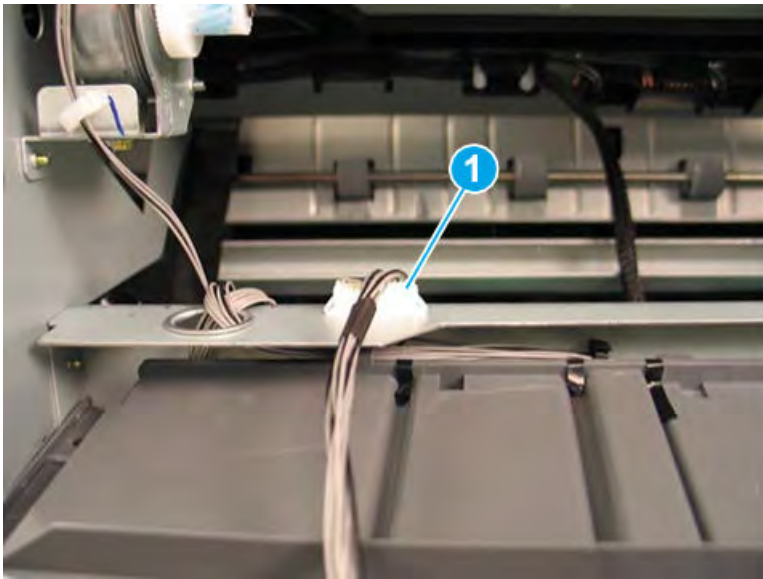
Figure 5-554 Release the shield



4. Disconnect one connector (callout 1), and then remove the upper shield assembly.

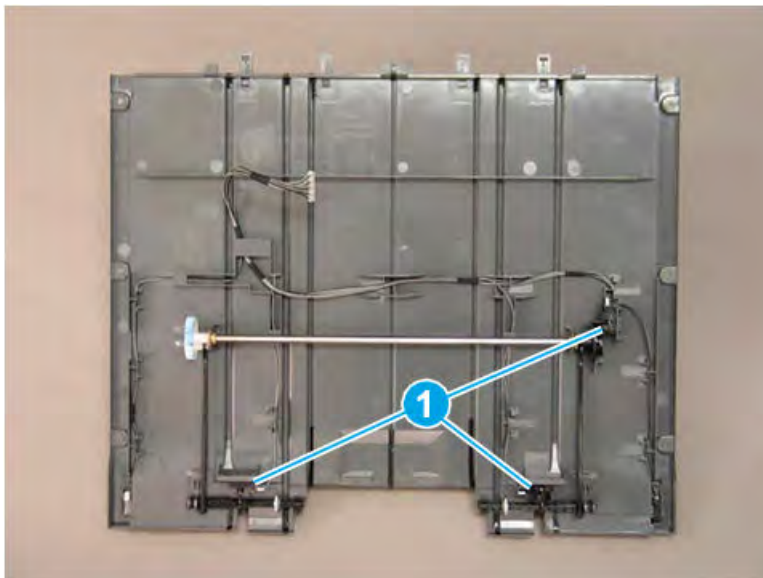
 **TIP:** Reverse the removal steps to install the assembly.

**Figure 5-555** Disconnect one connector



5. If you are replacing the left upper cover, locate three sensors (callout 1) on the back of the left upper cover. Remove these sensors and transfer them to the replacement part.

**Figure 5-556** Remove the left upper cover

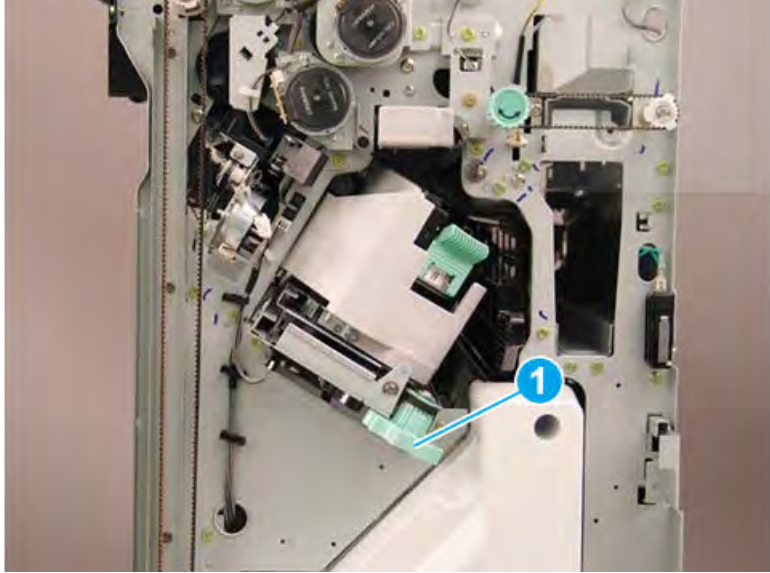


### Remove the ejector unit (finisher)

Follow these steps to remove the ejector unit (finisher).

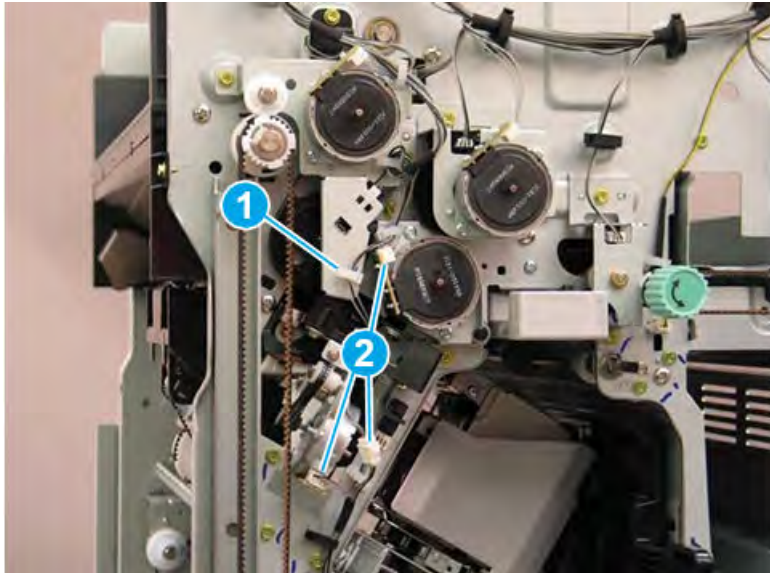
1. Rotate the green wheel to move the staple unit to the center of the finisher.

Figure 5-557 Move the staple unit to the center



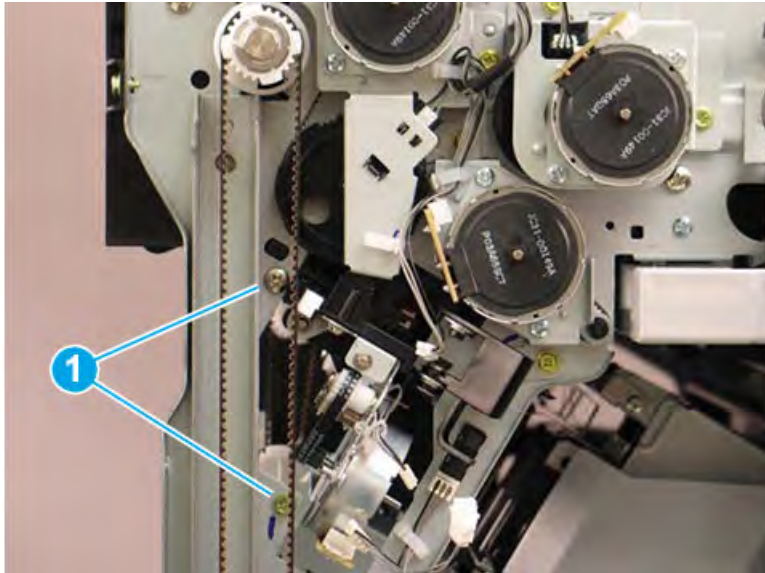
2. Release one retainer (callout 1), and then disconnect three connectors (callout 2).

Figure 5-558 Disconnect three connectors



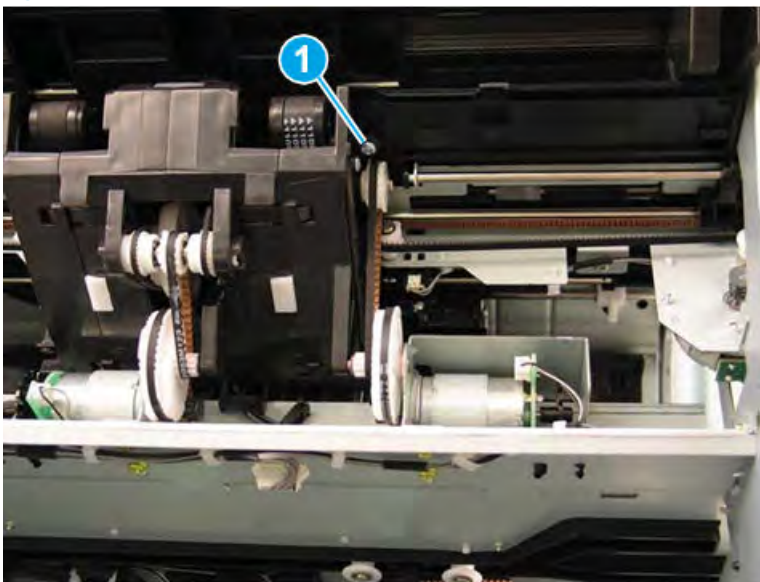
3. Remove two screws (callout 1).

Figure 5-559 Remove two screws



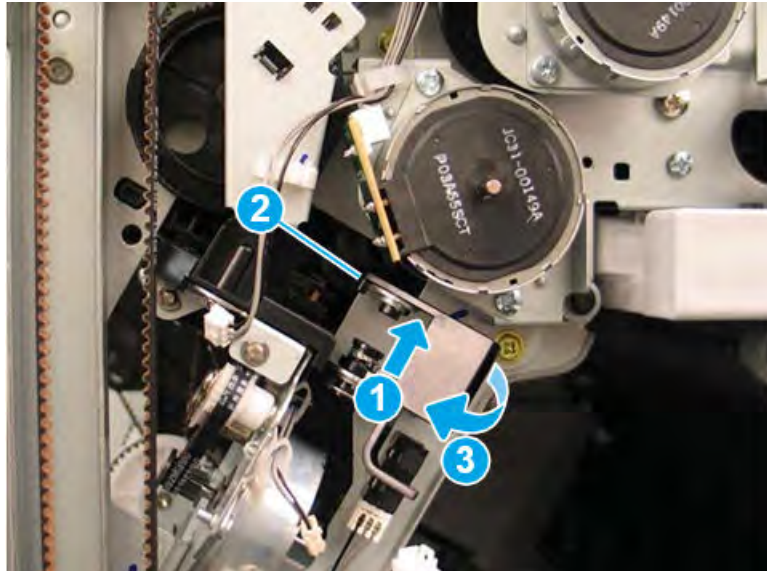
4. At the left side of the finisher, remove one screw (callout 1).

Figure 5-560 Remove one screw



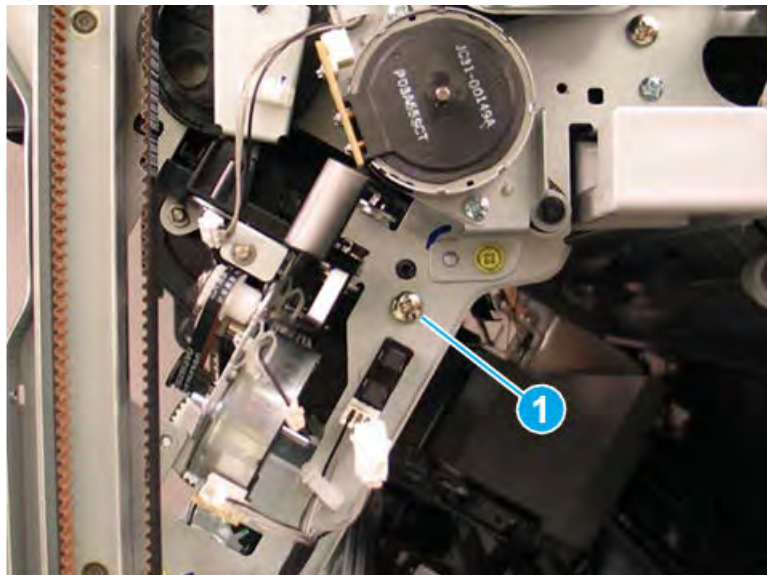
5. Press up on the hinge (callout 1), release one tab (callout 2), and then rotate the sensor away from the finisher (callout 3).

Figure 5-561 Rotate the sensor



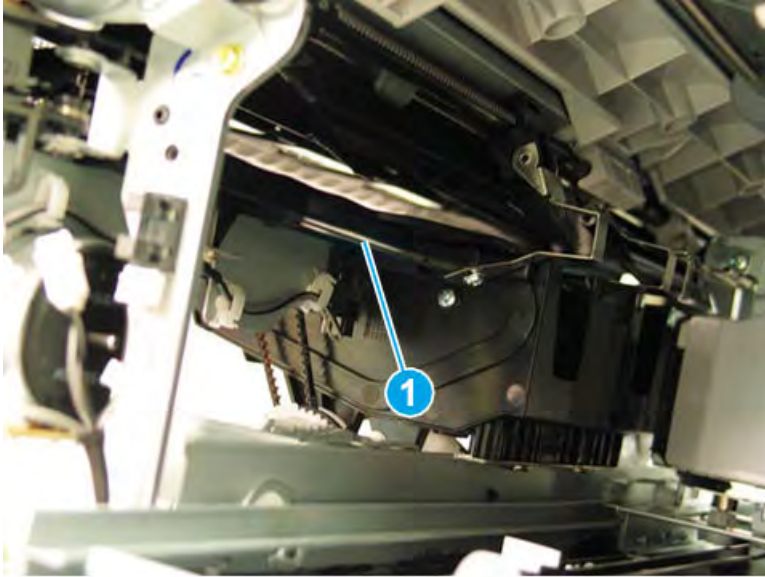
6. Remove one screw (callout 1).

Figure 5-562 Remove one screw



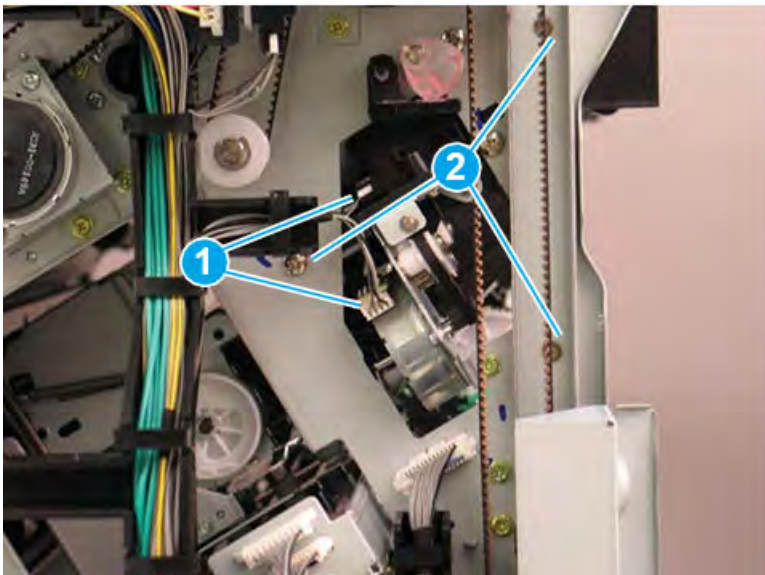
7. Look inside the finisher through the stapler opening in the front and pull down to release and remove one shaft (callout 1) on the front tamper unit.

**Figure 5-563** Remove the front tamper shaft



8. At the rear of the finisher, disconnect two connectors (callout 1), and then remove three screws (callout 2).

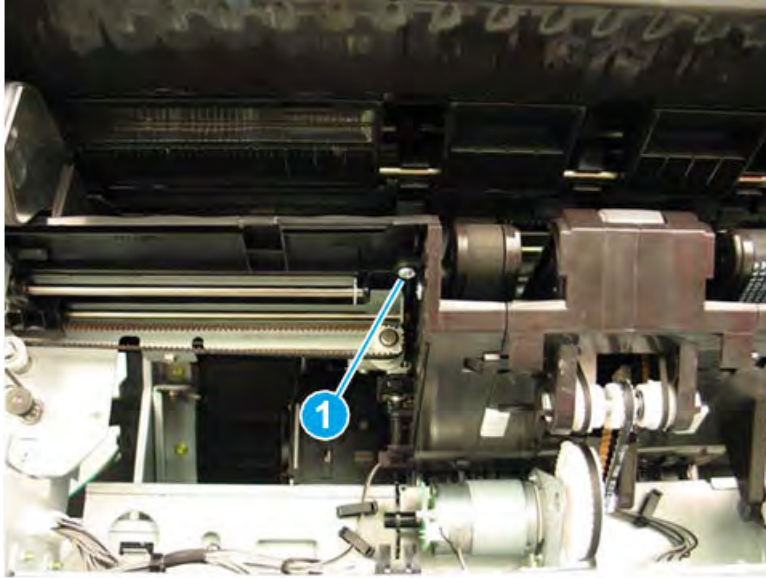
**Figure 5-564** Disconnect two connectors and remove three screws





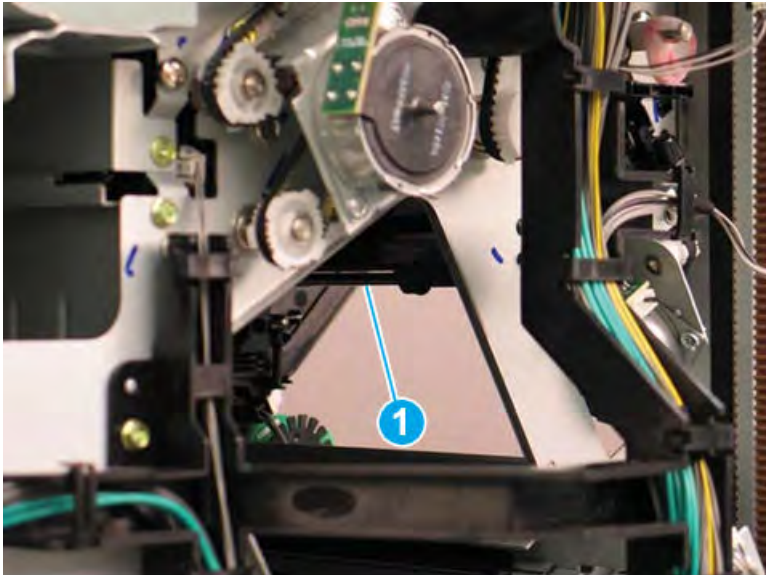
9. At the left side of the finisher, remove one screw (callout 1).

Figure 5-565 Remove one screw



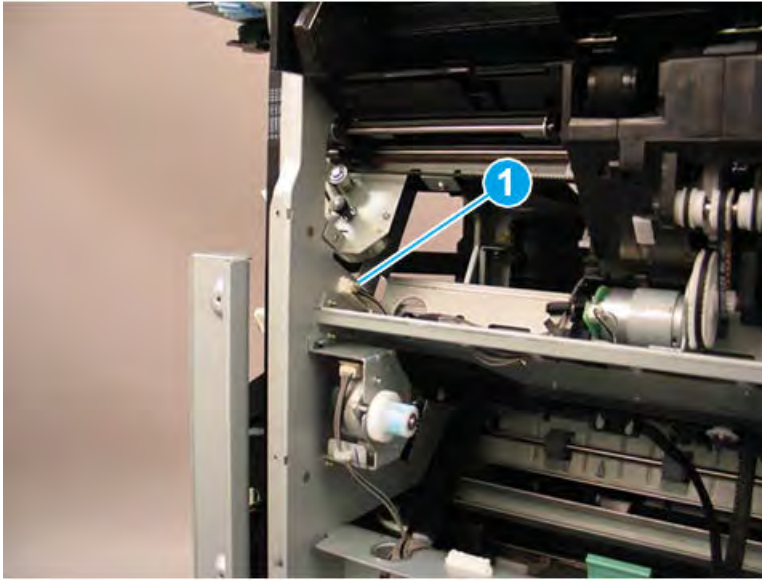
10. Look inside the finisher through the stapler opening in the rear and pull down to release and remove one shaft (callout 1) on the rear tamper unit.

Figure 5-566 Remove the rear tamper shaft



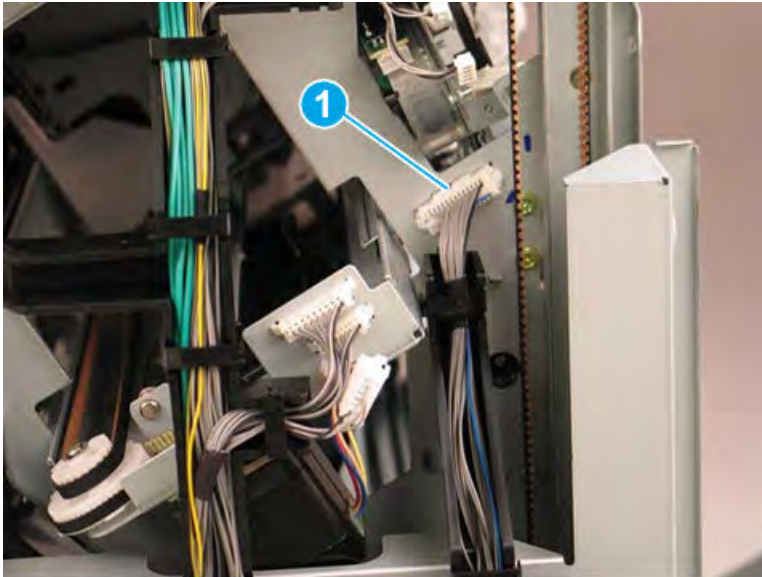
11. At the left side of the finisher, disconnect one connector (callout 1).

Figure 5-567 Disconnect one connector



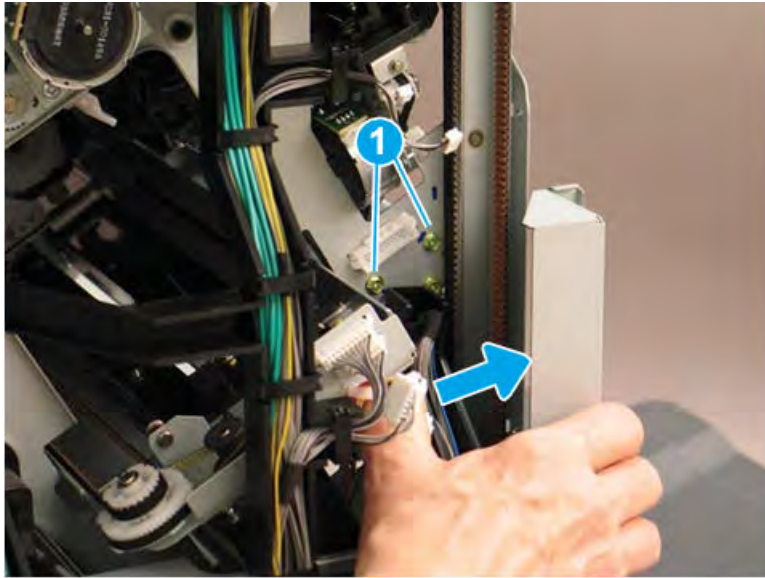
12. At the rear of the finisher, disconnect one connector (callout 1).

Figure 5-568 Disconnect one connector



13. At the rear of the finisher, press the wire retainer to the right to access and remove two screws (callout 1).

Figure 5-569 Disconnect one connector



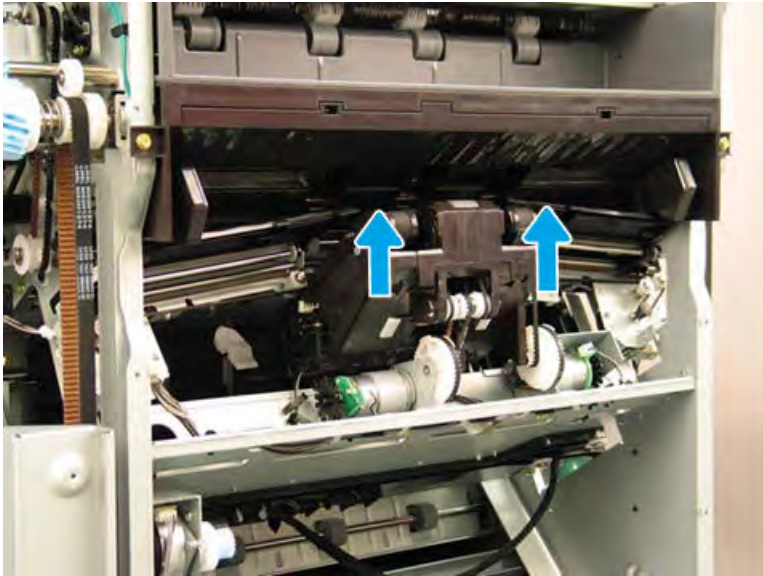
14. At the front of the finisher, remove two screws (callout 1).

Figure 5-570 Remove two screws



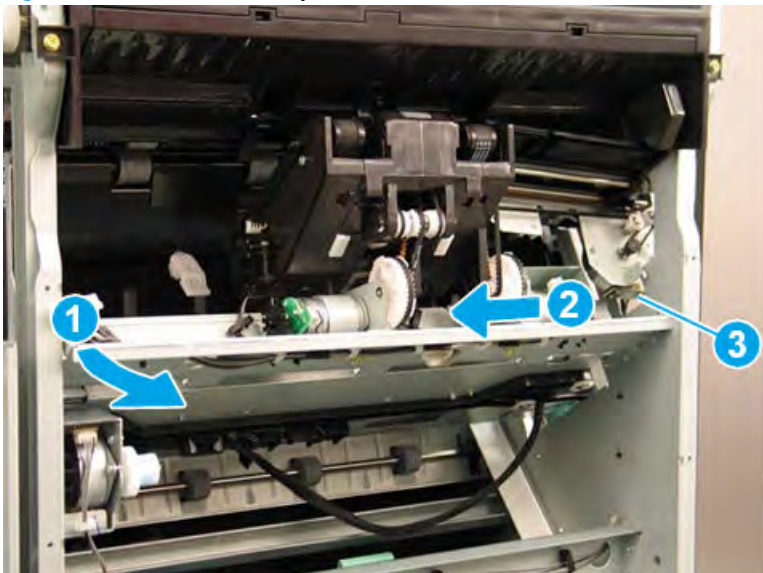
15. Lift the inside edges of the front and rear tampers up.

**Figure 5-571** Lift the edges of the tampers



16. Rotate the rear edge of the ejector unit away from the finisher (callout 1), and then slide it toward the rear of the finisher (callout 2) to remove it. Make sure that the PCA (callout 3) stays clear of the sheet metal frame.

**Figure 5-572** Remove the ejector unit

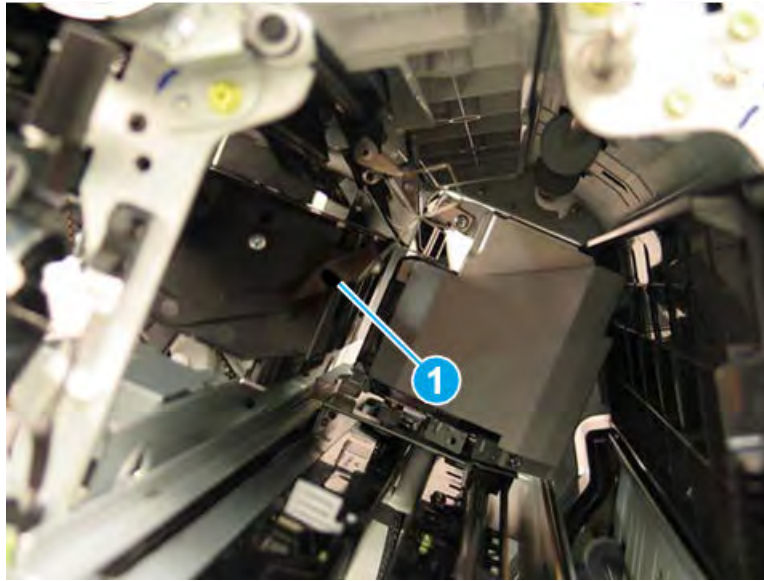


17. Reverse the removal steps to install the assembly. Also use the following special installation instructions.

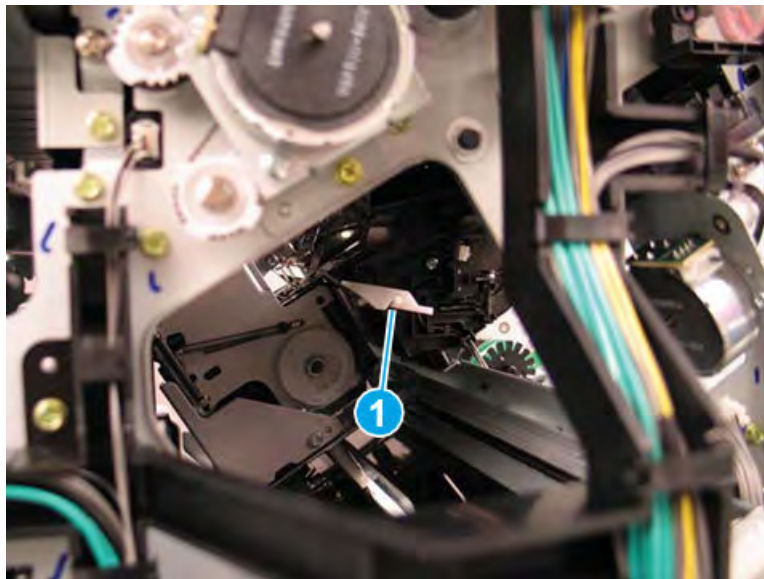
 **NOTE:** Continue to reverse the removal steps to finish installing the assembly.

**Special installation instructions: Ejector unit**

- a. When the front tamper shaft is removed, the retainer arm that held the one end of the shaft will drop down. When reinstalling the shaft, raise the retainer arm and position the end of the shaft in the notch (callout 1).



- b. When the rear tamper shaft is removed, the retainer arm that held the one end of the shaft will drop down. When reinstalling the shaft, raise the retainer arm and position the end of the shaft in the notch (callout 1).



### Remove the front tamper unit

Follow these steps to remove the front tamper unit.

- ▲ Lift the front tamper away from the finisher to remove it

Figure 5-573 Remove the front tamper



### Unpack the replacement assembly

Follow these steps to unpack the replacement assembly.

1. Dispose of the defective part.



---

 **NOTE:** HP recommends responsible disposal of the defective part.


<http://www8.hp.com/us/en/hp-information/environment/product-recycling.html>

---

2. Unpack the replacement part from the packaging.


 **CAUTION:**  Some parts are sensitive to electrostatic discharge (ESD). Always perform service work at an ESD-protected workstation or mat. If an ESD workstation or mat is not available, touch the sheet-metal chassis to provide a static ground before touching an ESD-sensitive assembly. Protect the ESD-sensitive assemblies by placing them in ESD pouches when they are out of the printer.

 **IMPORTANT:** Make sure that all of the shipping materials (for example shipping tape) are removed from the replacement part prior to installation.

 **NOTE:** If the replacement part is a roller or pad, avoid touching the spongy part of it. Skin oils on the roller or pad can cause paper pickup and/or print-quality problems. HP recommends using disposable gloves when handling rollers or pads or washing your hands before touching rollers or pads.

---

3. To install an assembly, reverse the removal steps.

 **NOTE:** When applicable, special installation instructions are provided for an assembly at the end of the removal procedure. Always completely read the removal instructions and follow all special installation instructions.


---

## Removal and replacement: Front tamper home sensor (S6)

Learn how to remove and replace the front tamper home sensor.

### Introduction

This document provides the procedures to remove and replace the front tamper home sensor on the finisher.

 **IMPORTANT:** When applicable, special installation instructions are provided for an assembly at the end of the removal procedure. Always completely read the removal instructions and follow all special installation instructions.

### Before performing service

- Turn the printer power off. A shutting-down message appears on the control-panel display.
- ⚠ **WARNING!** To avoid damage to the printer, turn the power off and wait until the printer shuts down before removing the power cable.
- Disconnect the printer power cable after the printer has completely shut down (the control-panel display is blank).
- Release the finisher from the printer by pulling out on the release latch inside the finisher door.
- Disconnect the cable from the bridge unit to the finisher.
- Disconnect the cable from the finisher to the printer.

Use the table below to identify the correct part number for your printer. To order the part, go to <https://parts.hp.com>.

**Table 5-114** Part information

Part number	Part description
0604-001393	Front tamper home sensor

### Required tools

- #2 JIS screwdriver with a magnetic tip
- Small, flat-blade screwdriver

### After performing service

- Connect the cable from the finisher to the printer.
- Connect the cable from the bridge unit to the finisher.
- Attach the finisher to the printer, and then push in on the release latch inside the finisher door.
- Connect the printer power cable.
- Turn the printer power on.

### Post service test

Process a job through the finisher and verify that the finisher works correctly.

### Remove the right upper cover (finisher)

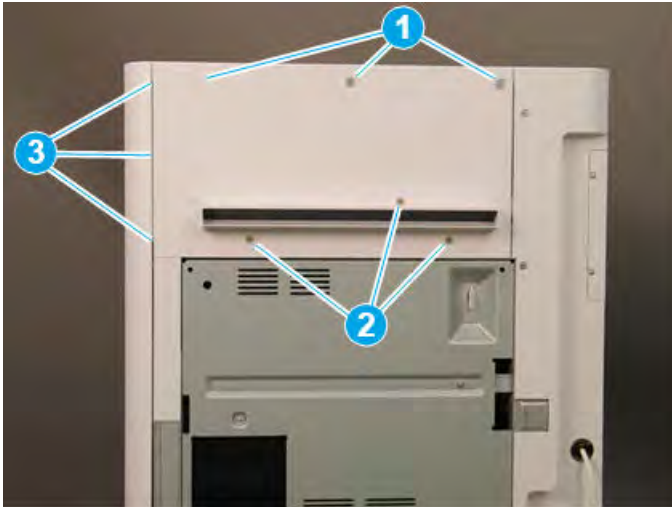
Follow these steps to remove the right upper cover (finisher).

- ▲ Remove one screw cap and three machine screws on the upper edge of the cover (callout 1). Remove three sheet metal screws (callout 2) on the lower portion of the cover. Rotate the right edge of the cover away from the finisher, and then slide the cover right to release three tabs (callout 3).

💡 **TIP:** The lower screws are shorter in length than the upper screws.

**TIP:** Reverse the removal steps to install the assembly.

**Figure 5-574** Remove the right upper cover

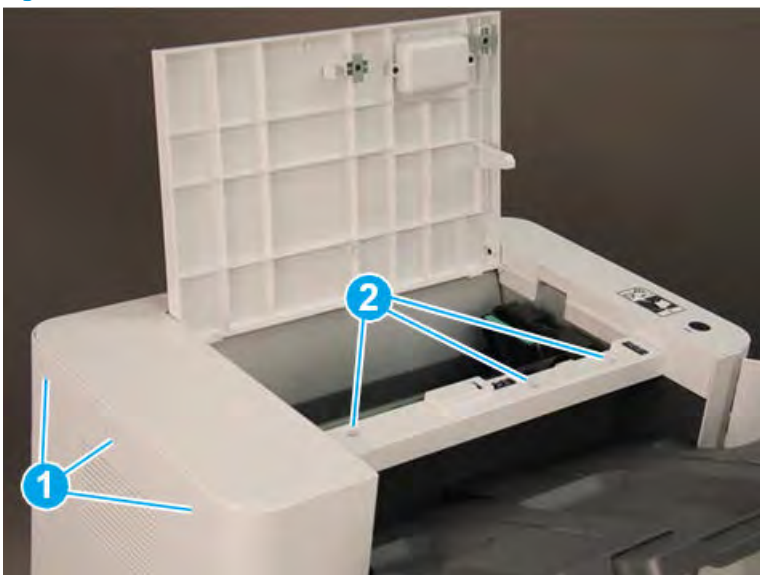


### Remove the top cover (finisher)

Follow these steps to remove the top cover (finisher).

1. Remove three screw caps and three self-tapping screws at the top of the rear cover (callout 1), and then remove three machine screws (callout 2) on top of the cover.

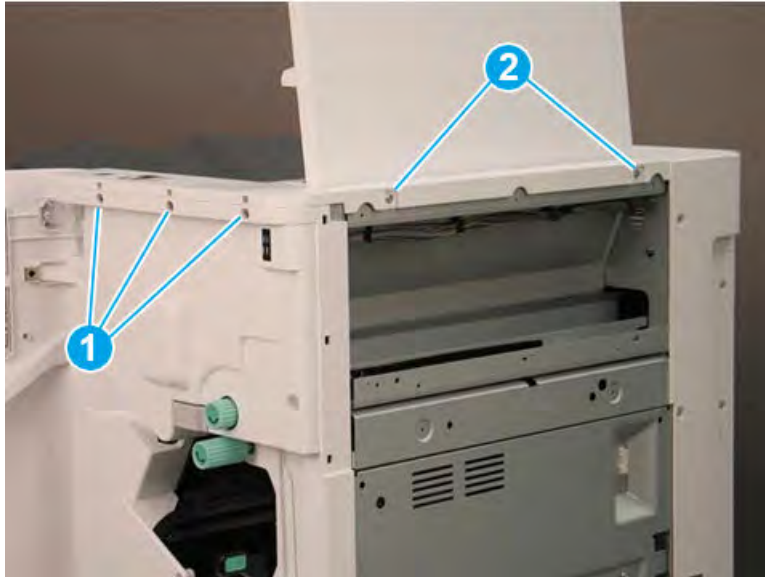
**Figure 5-575** Remove six screws






2. Remove three self-tapping screws at the top of the front cover (callout 1), and then remove two machine screws (callout 2) at the top of the right side.

Figure 5-576 Remove five screws



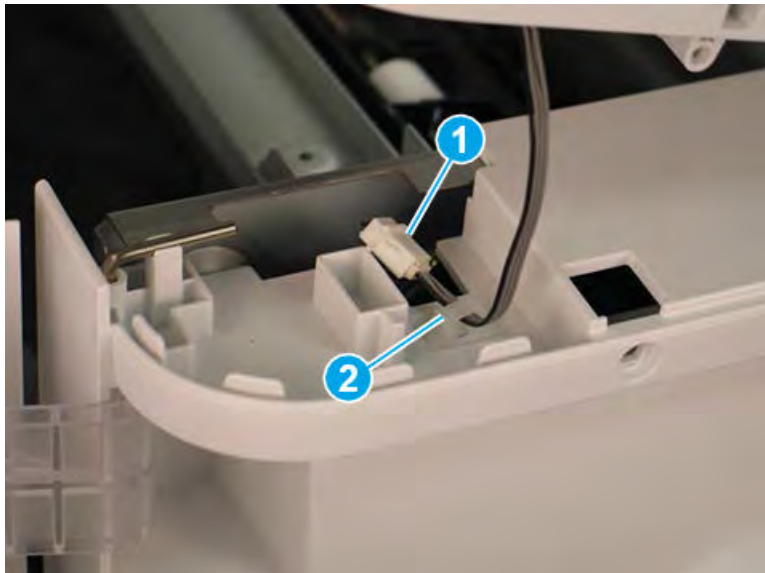
3. Lift the cover up slightly. Disconnect one in-line connector (callout 1), and then release one retainer (callout 2).

---

 **TIP:** Reverse the removal steps to install the assembly.

---

Figure 5-577 Disconnect one connector and release retainer

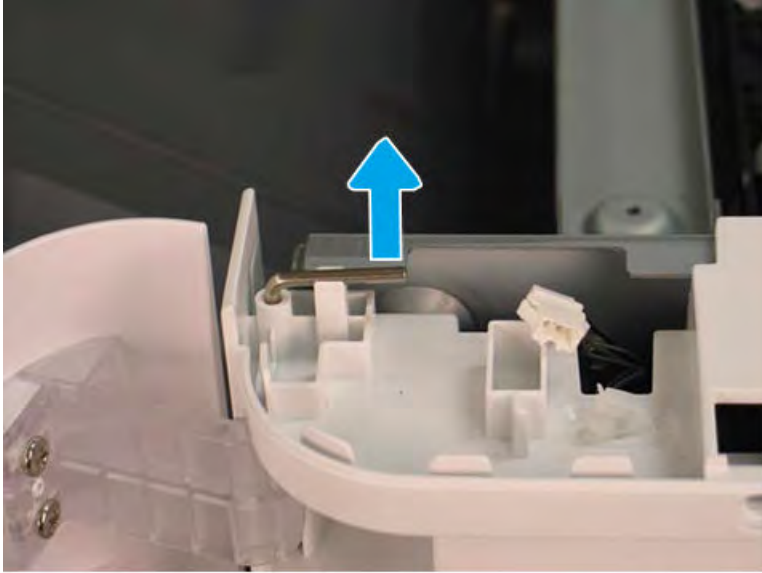


### Remove the front door (finisher)

Follow these steps to remove the front door (finisher).

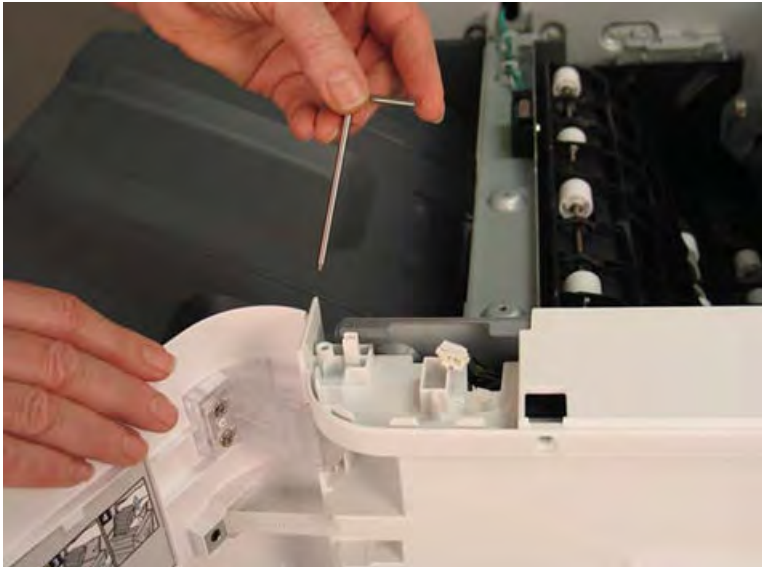
1. Lift the top hinge pin up to release it from the retainer.

Figure 5-578 Lift the top hinge pin



2. Pull the top hinge pin up to remove it.

Figure 5-579 Remove the top hinge pin



3. Use a small, flat-blade screwdriver to release the lower hinge pin from the retainer, and then rotate it away from the finisher.

Figure 5-580 Release the lower hinge pin




4. Support the door with one hand, and then pull the lower hinge pin straight up to remove it.

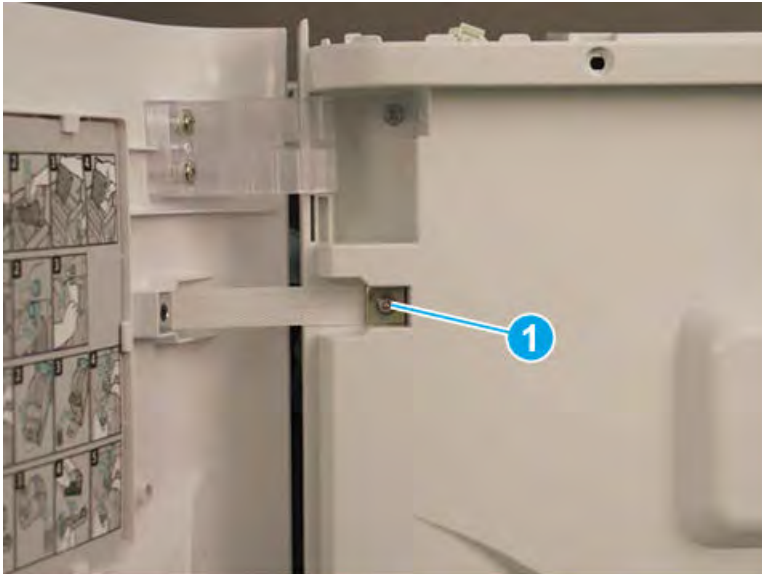
Figure 5-581 Remove the lower hinge pin



5. Support the door with one hand, and then remove one screw (callout 1) to release the strap. Remove the front door.

 **TIP:** Reverse the removal steps to install the assembly.

**Figure 5-582** Remove the front door

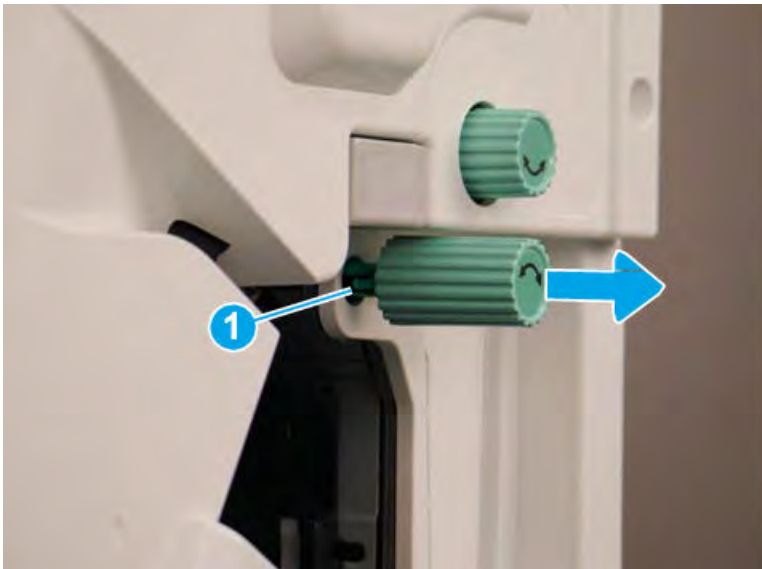


#### Remove the front cover (finisher)

Follow these steps to remove the front cover (finisher).

1. Release one tab (callout 1), and then pull the jam-access knob away from the finisher to remove it.

**Figure 5-583** Remove the jam-access knob



2. If the punch unit is installed, remove the punch waste bin (callout 1).

3. Remove one screw (callout 1) on top of the front cover.

Figure 5-584 Remove one screw



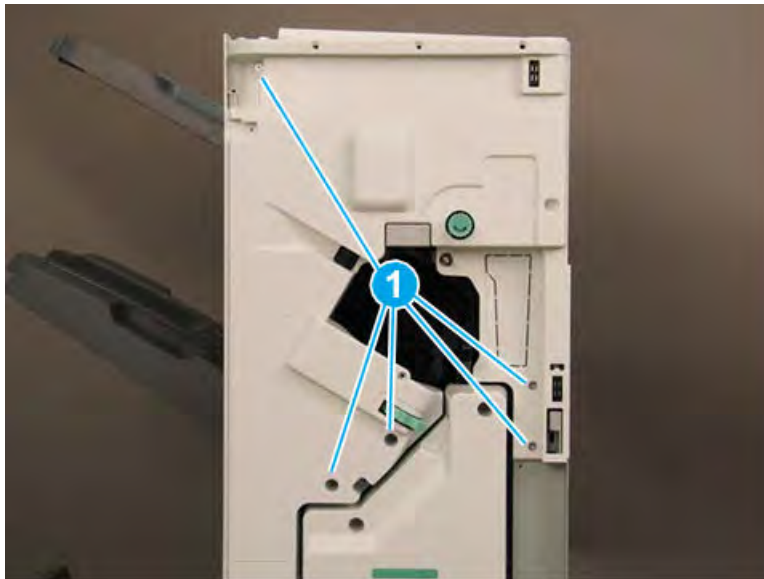
4. Remove five machine screws (callout 1), and then remove the front cover.

---

 **TIP:** Reverse the removal steps to install the assembly.

---

Figure 5-585 Remove the front cover



### Remove the rear cover (finisher)

Follow these steps to remove the rear cover (finisher).

1. Remove two self-tapping screws (callout 1) on the top of the rear cover, and then remove five screw caps and five machine screws (callout 2) on the left side of the cover.

Figure 5-586 Remove seven screws

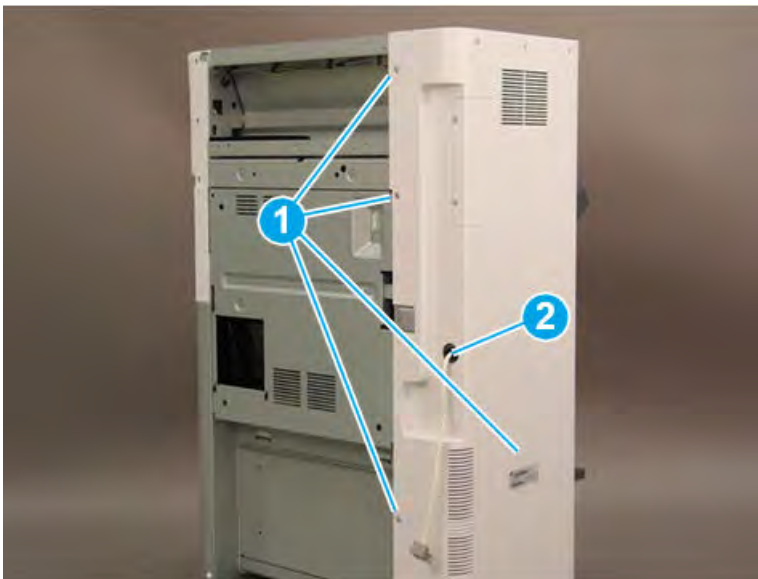


2. Remove one screw cap and four machine screws (callout 1) Remove the rear cover.

 **NOTE:** Make sure to thread the power cable (callout 2) through the opening in the cover.

 **TIP:** Reverse the removal steps to install the assembly

Figure 5-587 Remove the rear cover



### Remove the booklet output tray

Follow these steps to remove the booklet output tray.

1. Raise the booklet output tray up (callout 1), and then pull it away from the finisher (callout 2) to remove it.

Figure 5-588 Remove the booklet output tray



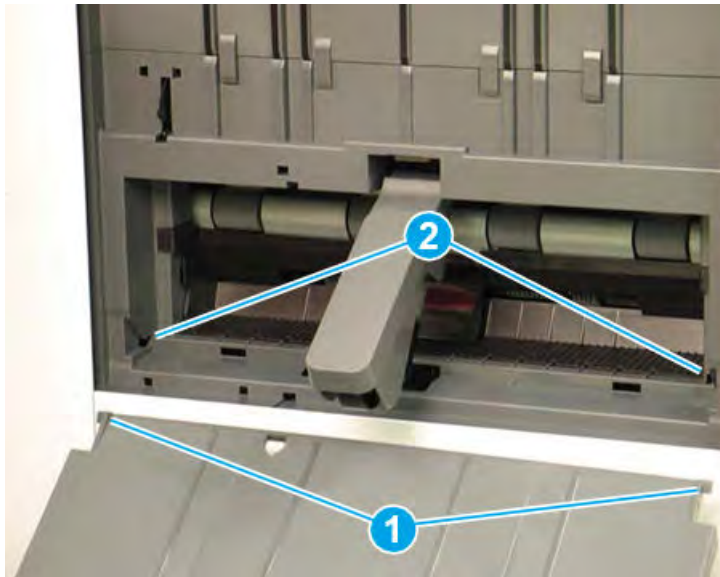
2. Reverse the removal steps to install the assembly. Also use the following special installation instructions.

 **NOTE:** Continue to reverse the removal steps to finish installing the assembly

Special installation instructions: booklet output tray

Position the tabs (callout 1) on the tray into the slots (callout 2) on the finisher.

Figure 5-589 Install the booklet output tray

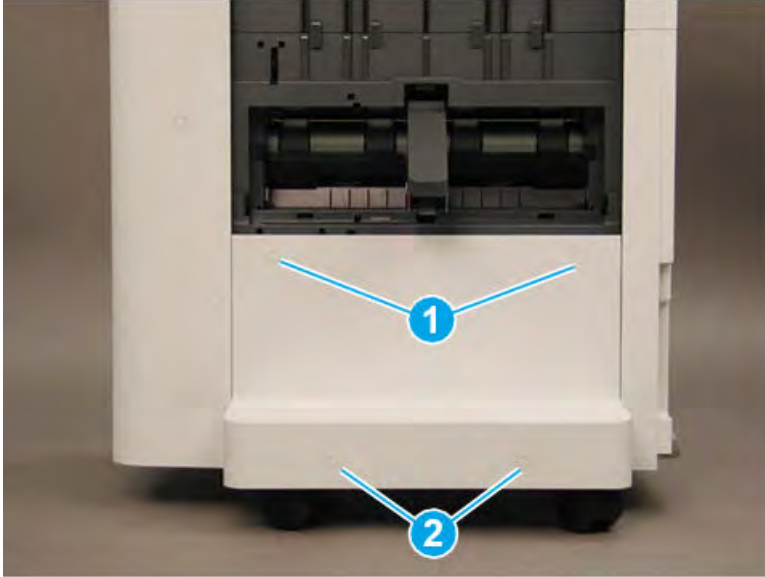


### Remove the caster cover

Follow these steps to remove the caster cover.


1. Remove two screw caps and two self-tapping screws (callout 1). Remove two screw caps and two machine screws (callout 2).

Figure 5-590 Remove four screws



2. Rotate the left edge of the cover away from the finisher (callout 1), and then slide the cover to the left (callout 2) to remove it.

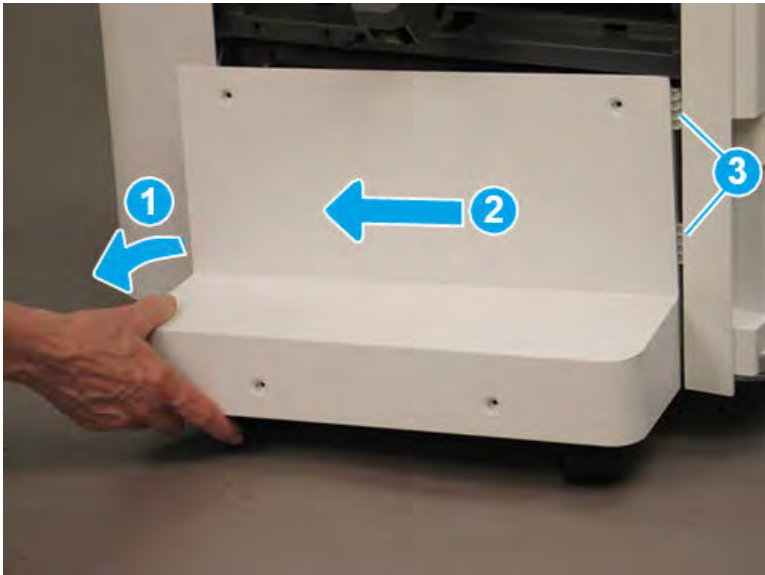
---

 **TIP:** Make sure that two tabs (callout 3) are positioned under the front lower cover when reinstalling the caster cover.

**TIP:** Reverse the removal steps to install the assembly

---

Figure 5-591 Remove the caster cover




### Remove the left lower cover (finisher)

Follow these steps to remove the left lower cover (finisher).

1. Remove four screws (callout 1).

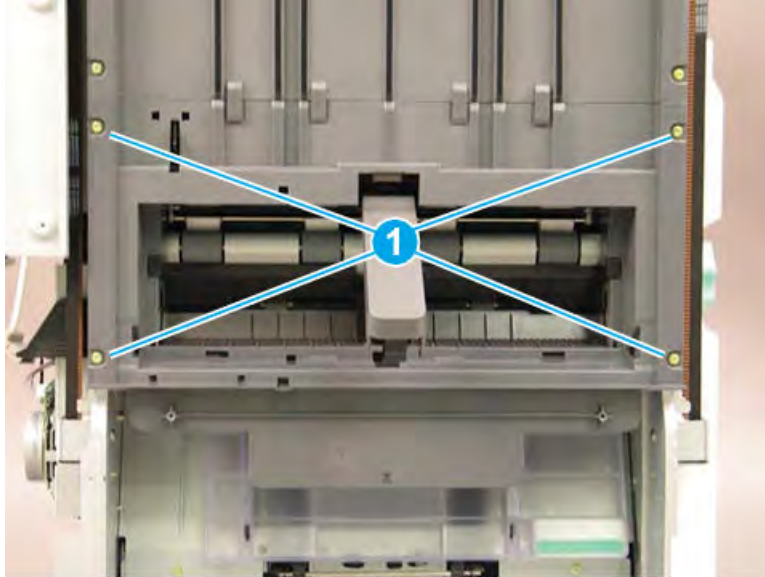
---

 **NOTE:** Raise the lower output tray as needed to access the screws.

---



Figure 5-592 Remove four screws

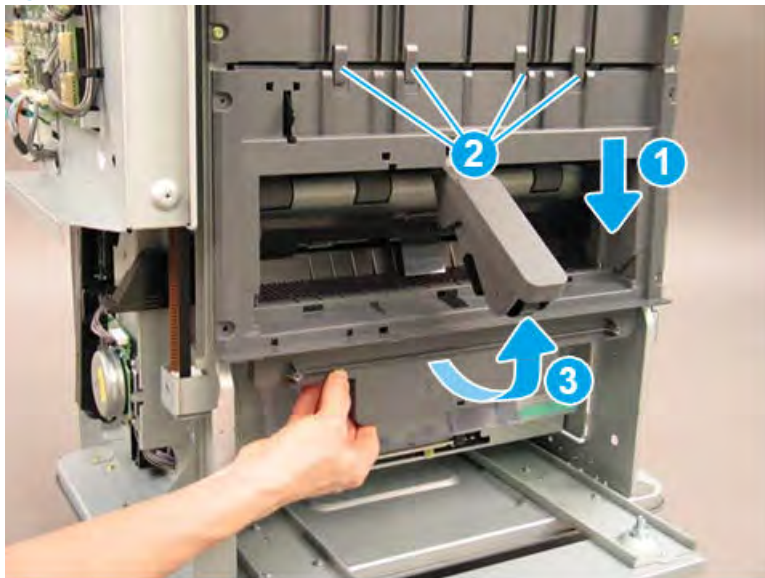


2. Slide the shield down (callout 1) to release it from four tabs (callout 2), and then rotate it away from the finisher (callout 3).


**⚠ CAUTION:** The shield is still attached to the finisher. Do not attempt to completely remove the shield.

**💡 TIP:** Position the shield under the four tabs (callout 2) when reinstalling it.

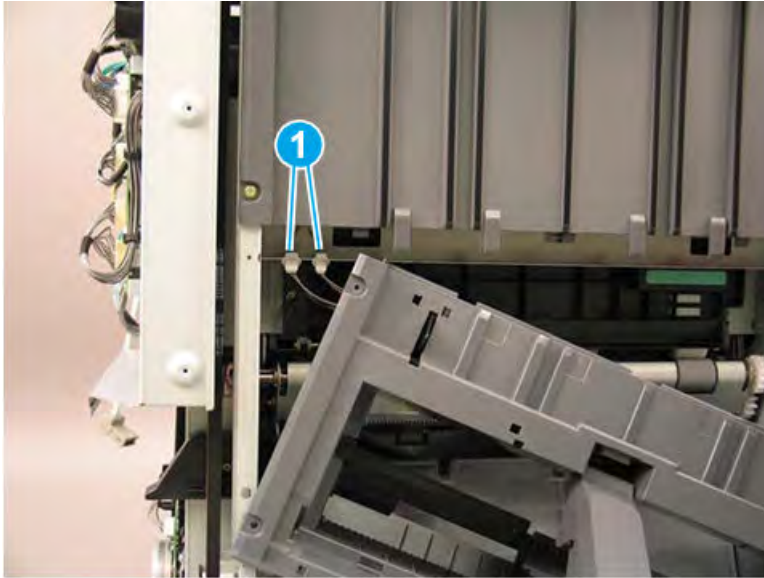
Figure 5-593 Release the lower shield



3. Disconnect two connectors (callout 1), and then remove the shield.

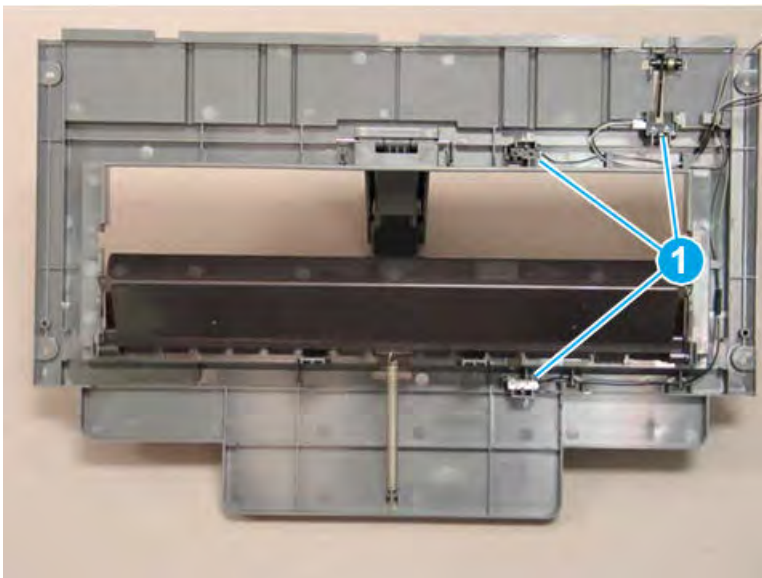
 **TIP:** Reverse the removal steps to install the assembly.

**Figure 5-594** Disconnect two connectors



4. If you are replacing the left lower cover, locate three sensors (callout 1) on the back of the left lower cover. Remove these sensors and transfer them to the replacement part.

**Figure 5-595** Remove the left lower cover

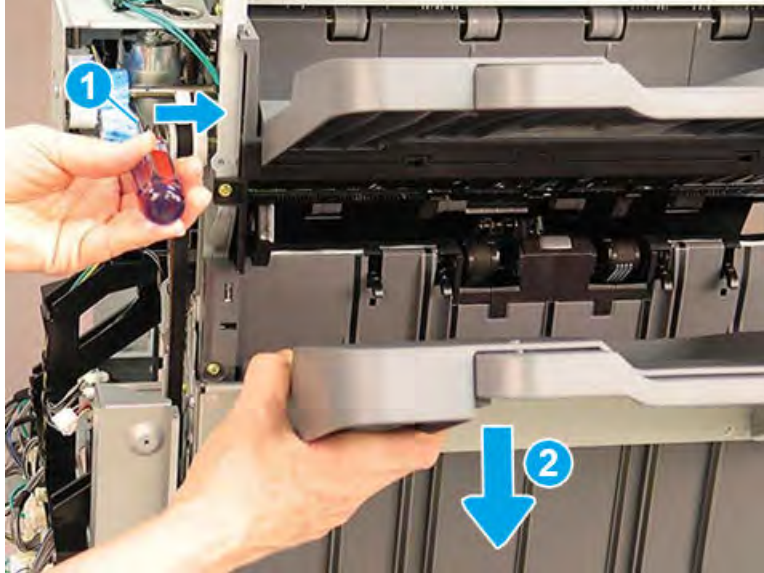


### Remove the left upper cover (finisher)

Follow these steps to remove the left upper cover (finisher).

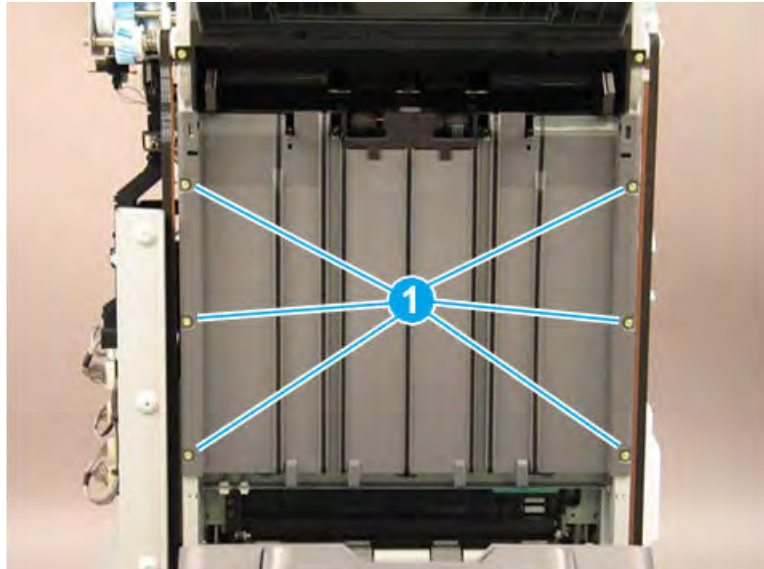
1. Bring the lower output tray down by positioning the shaft of a screwdriver on the clutch (callout 1) and gently pressing to the right to release the clutch. Hold the clutch in the released position and lower the tray (callout 2) to the lowest position.

Figure 5-596 Lower the output tray



2. Remove six machine screws (callout 1).

Figure 5-597 Remove six screws

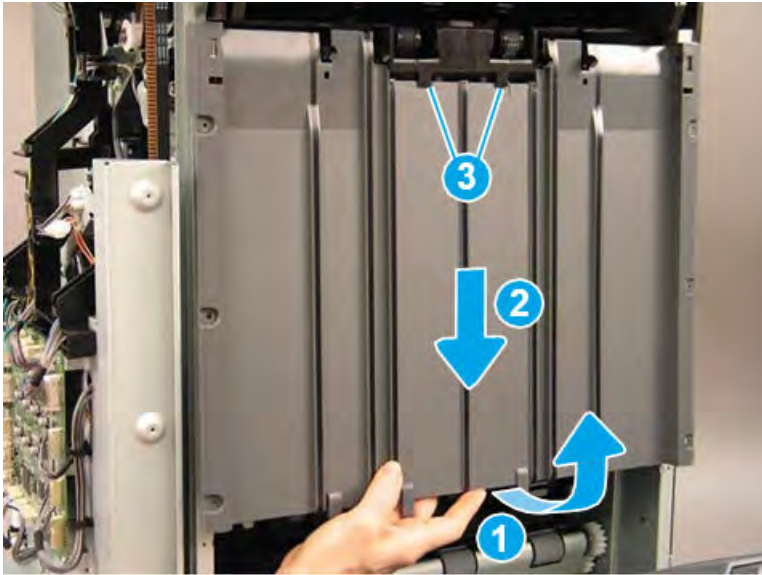


3. Rotate the lower edge of the shield away from the finisher (callout 1), and then slide the shield down (callout 2) to release it from two tabs (callout 3).

**⚠ CAUTION:** The shield is still attached to the finisher. Do not attempt to completely remove the shield.

**💡 TIP:** Position the shield under the two tabs (callout 3) when reinstalling it.

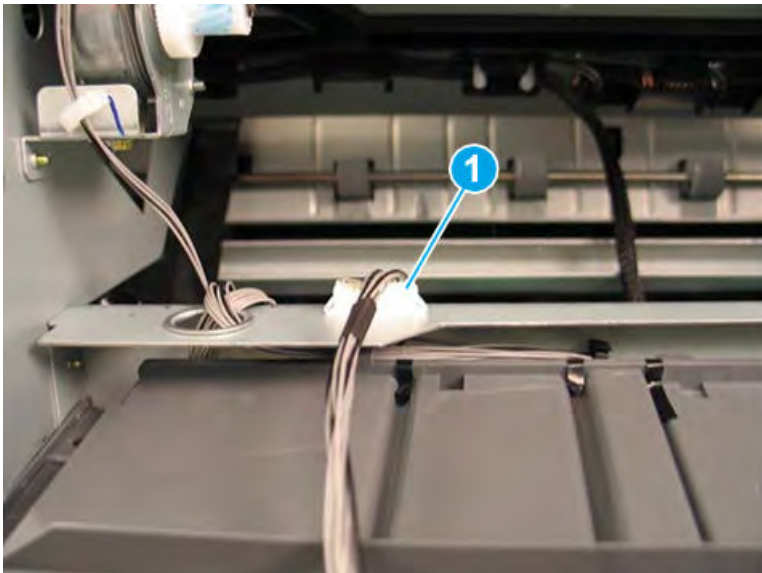
**Figure 5-598** Release the shield



4. Disconnect one connector (callout 1), and then remove the upper shield assembly.

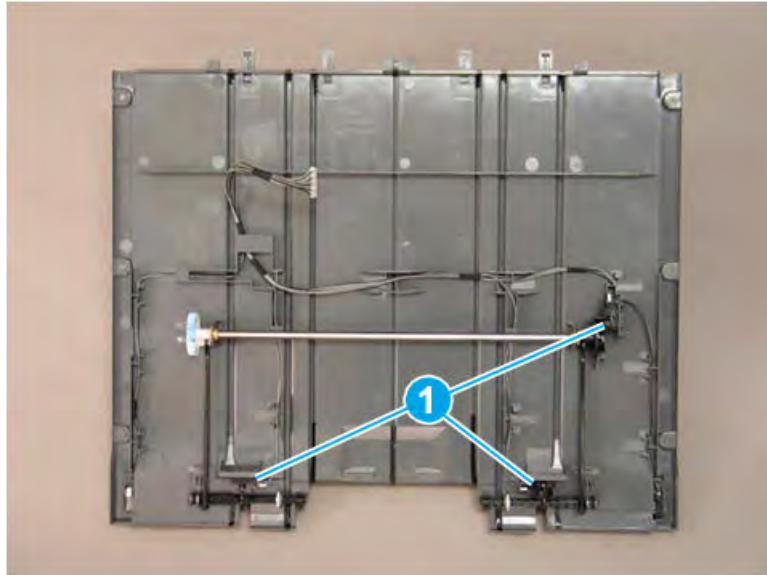
**💡 TIP:** Reverse the removal steps to install the assembly.

**Figure 5-599** Disconnect one connector



5. If you are replacing the left upper cover, locate three sensors (callout 1) on the back of the left upper cover. Remove these sensors and transfer them to the replacement part.

Figure 5-600 Remove the left upper cover

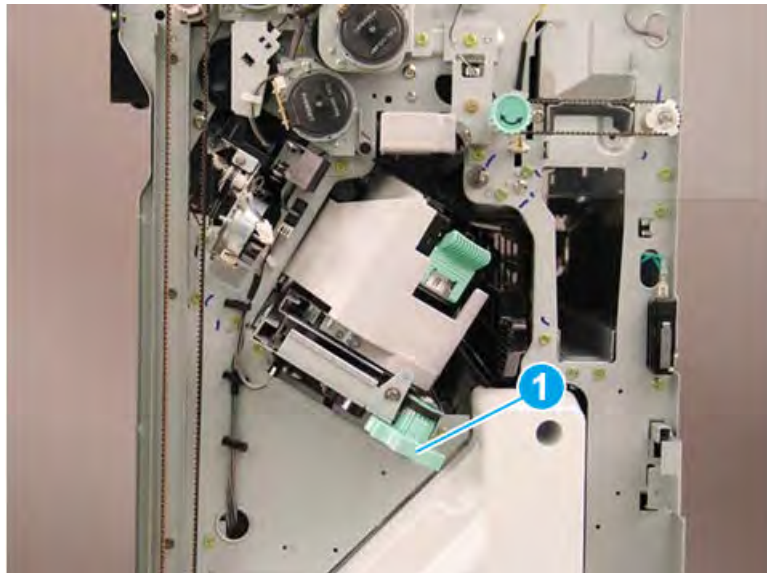


#### Remove the ejector unit (finisher)

Follow these steps to remove the ejector unit (finisher).

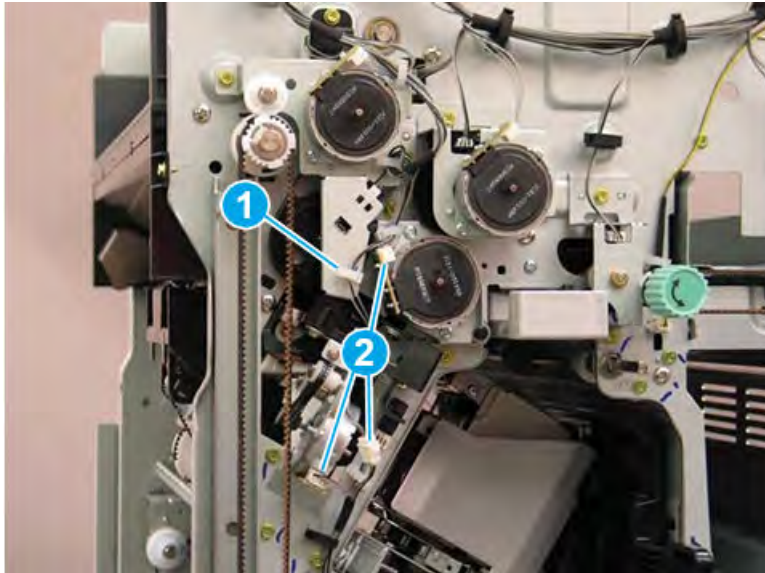
1. Rotate the green wheel to move the staple unit to the center of the finisher.

Figure 5-601 Move the staple unit to the center



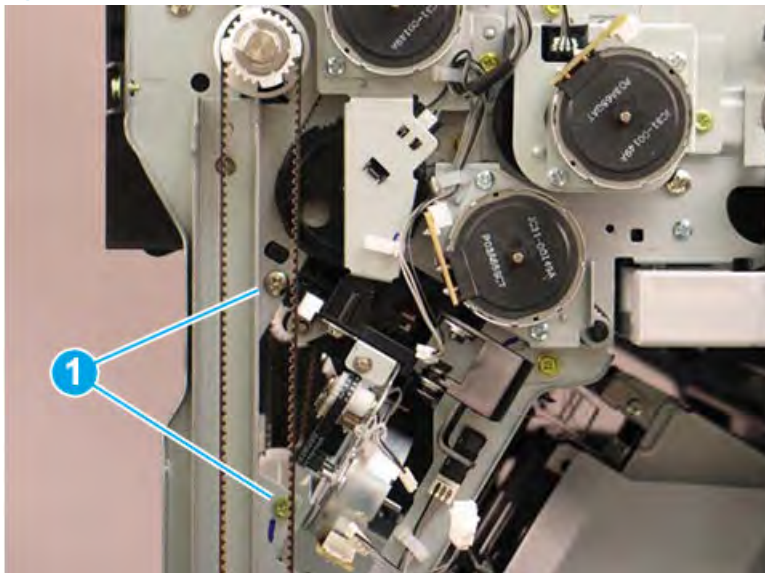
2. Release one retainer (callout 1), and then disconnect three connectors (callout 2).

Figure 5-602 Disconnect three connectors



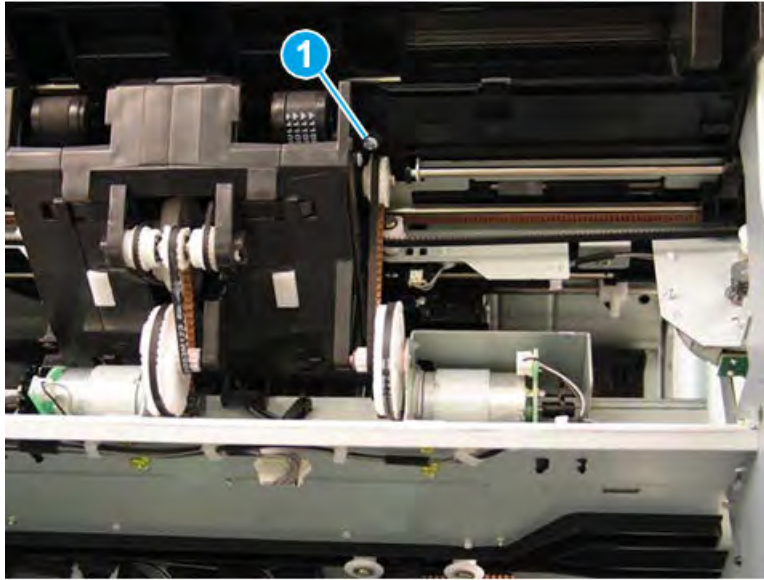
3. Remove two screws (callout 1).

Figure 5-603 Remove two screws



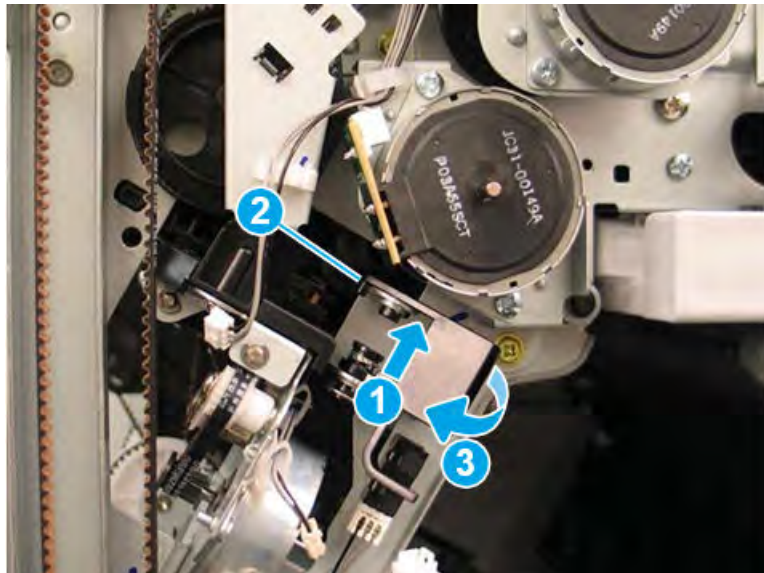
4. At the left side of the finisher, remove one screw (callout 1).

Figure 5-604 Remove one screw



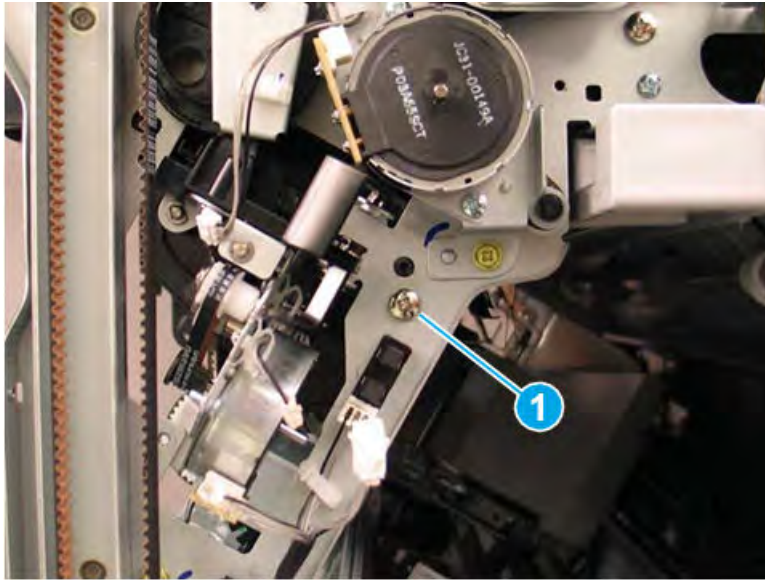
5. Press up on the hinge (callout 1), release one tab (callout 2), and then rotate the sensor away from the finisher (callout 3).

Figure 5-605 Rotate the sensor



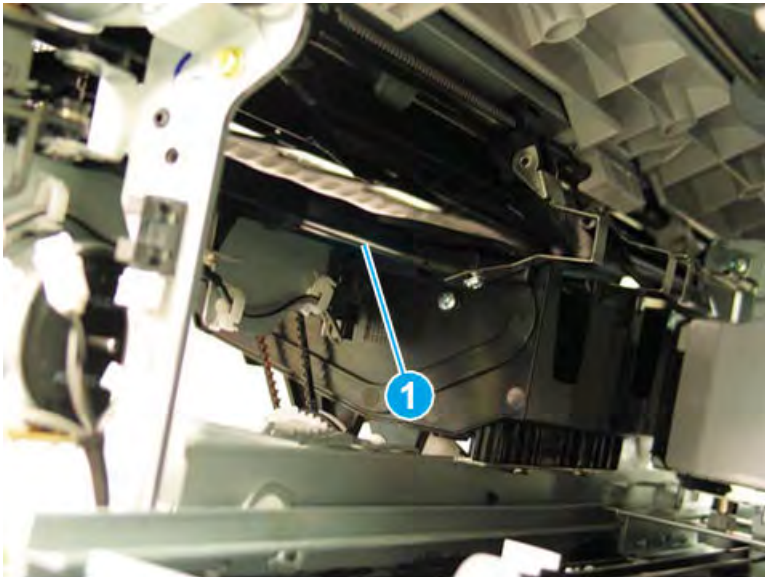
6. Remove one screw (callout 1).

Figure 5-606 Remove one screw



7. Look inside the finisher through the stapler opening in the front and pull down to release and remove one shaft (callout 1) on the front tamper unit.

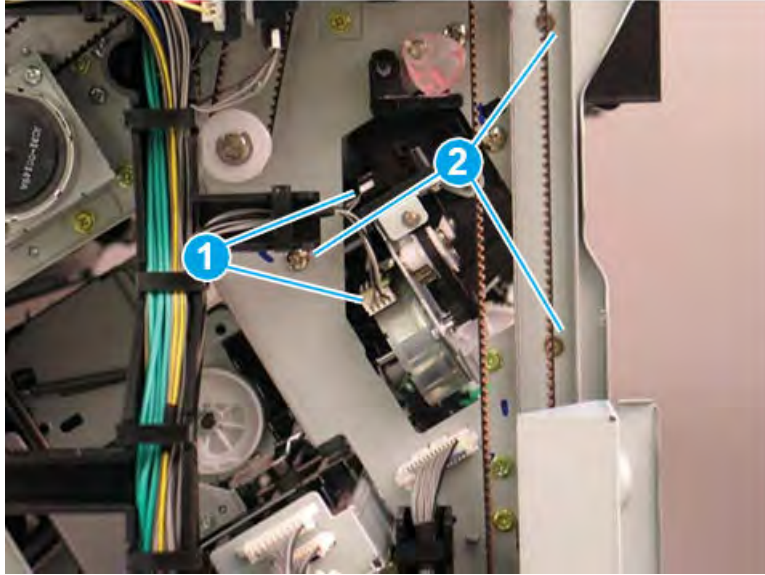
Figure 5-607 Remove the front tamper shaft





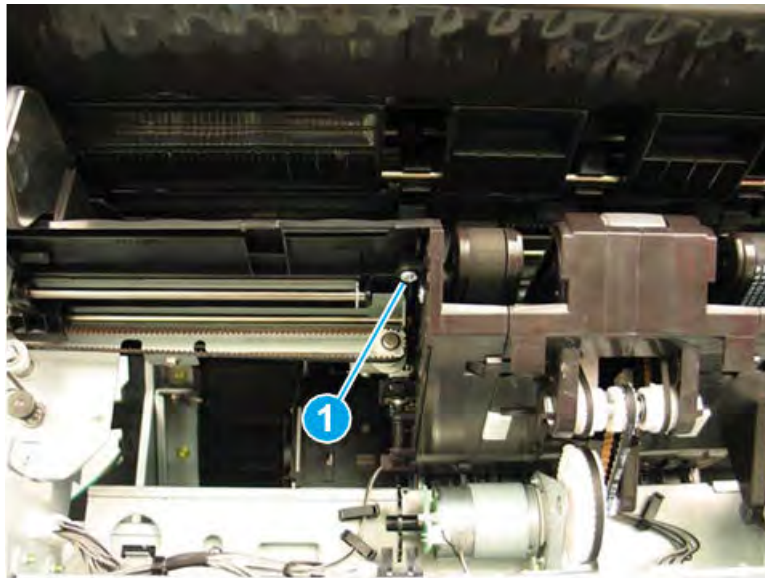
8. At the rear of the finisher, disconnect two connectors (callout 1), and then remove three screws (callout 2).

Figure 5-608 Disconnect two connectors and remove three screws



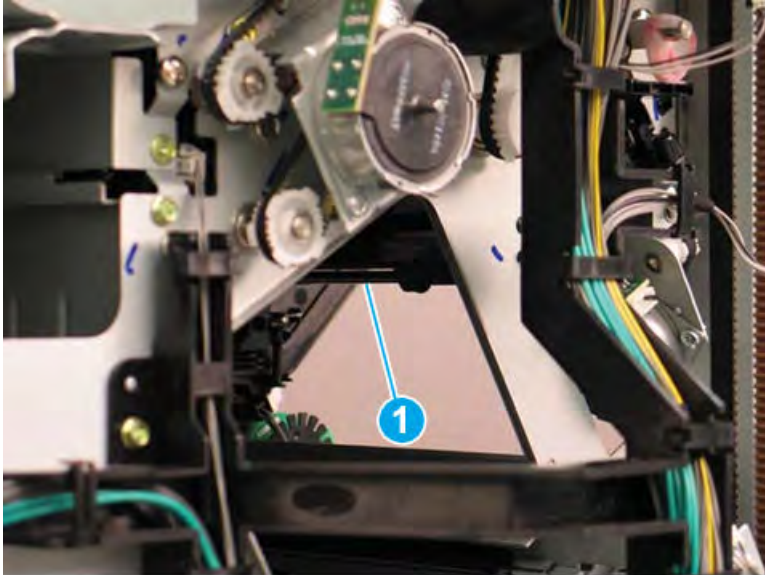
9. At the left side of the finisher, remove one screw (callout 1).

Figure 5-609 Remove one screw



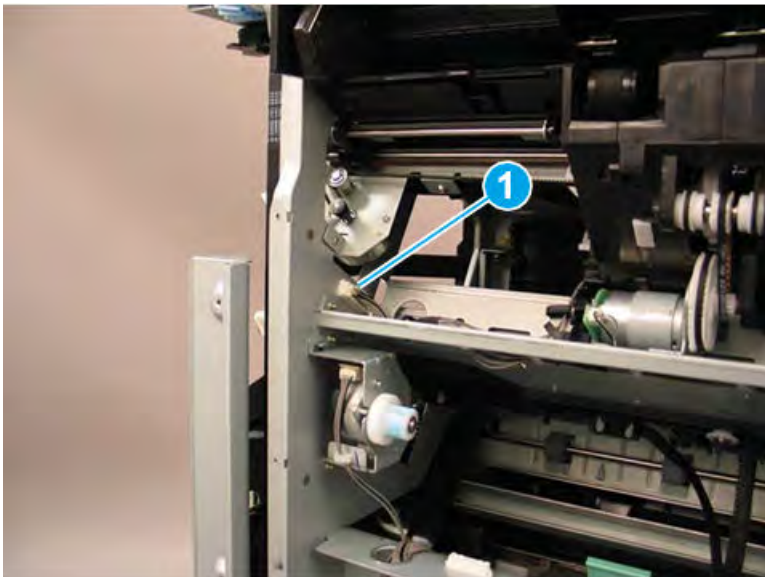
10. Look inside the finisher through the stapler opening in the rear and pull down to release and remove one shaft (callout 1) on the rear tamper unit.

Figure 5-610 Remove the rear tamper shaft



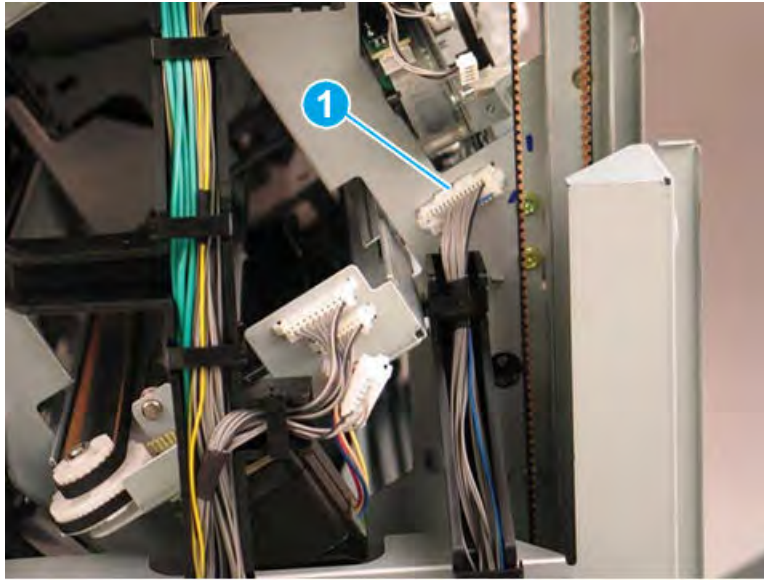
11. At the left side of the finisher, disconnect one connector (callout 1).

Figure 5-611 Disconnect one connector



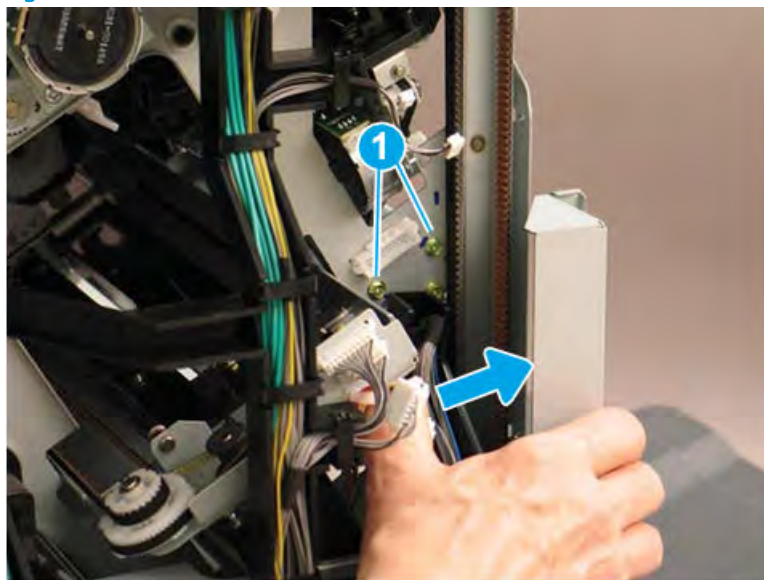
12. At the rear of the finisher, disconnect one connector (callout 1).

Figure 5-612 Disconnect one connector



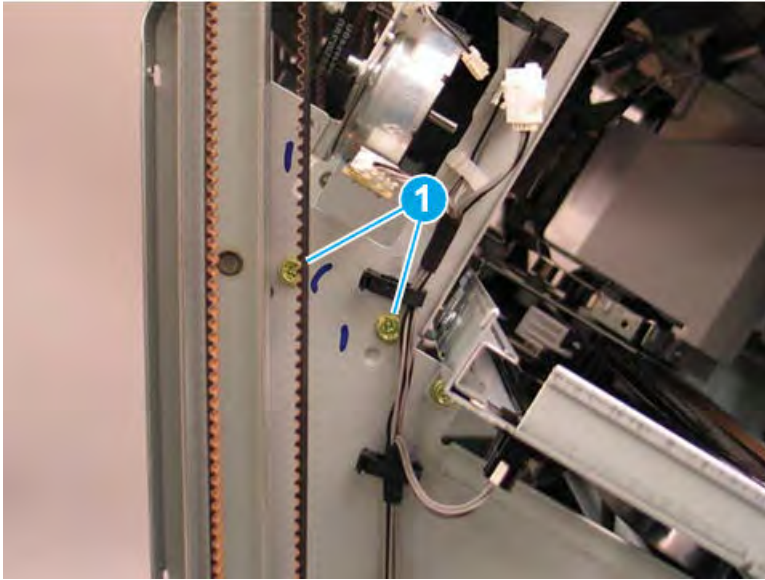
13. At the rear of the finisher, press the wire retainer to the right to access and remove two screws (callout 1).

Figure 5-613 Disconnect one connector



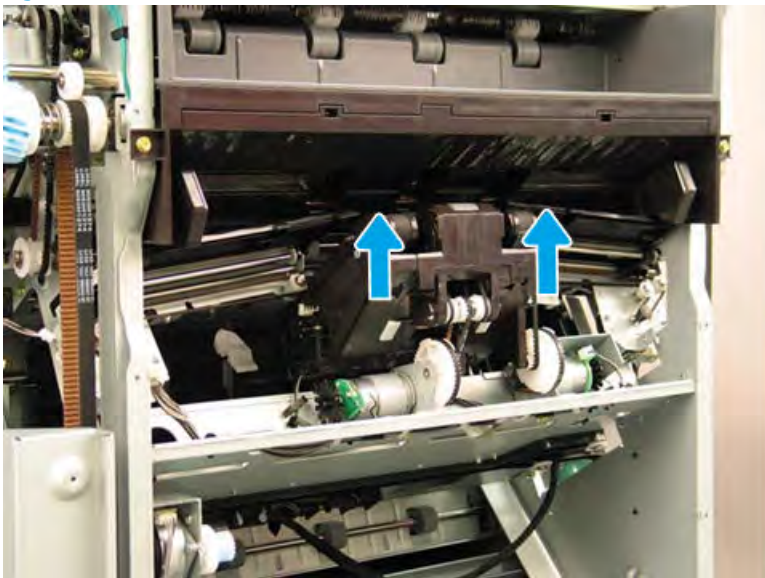
14. At the front of the finisher, remove two screws (callout 1).

Figure 5-614 Remove two screws



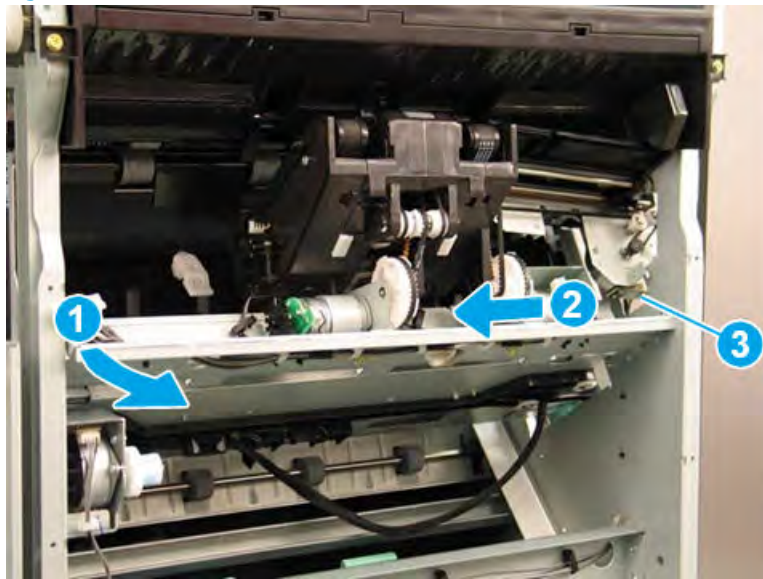
15. Lift the inside edges of the front and rear tampers up.

Figure 5-615 Lift the edges of the tampers



16. Rotate the rear edge of the ejector unit away from the finisher (callout 1), and then slide it toward the rear of the finisher (callout 2) to remove it. Make sure that the PCA (callout 3) stays clear of the sheet metal frame.

Figure 5-616 Remove the ejector unit

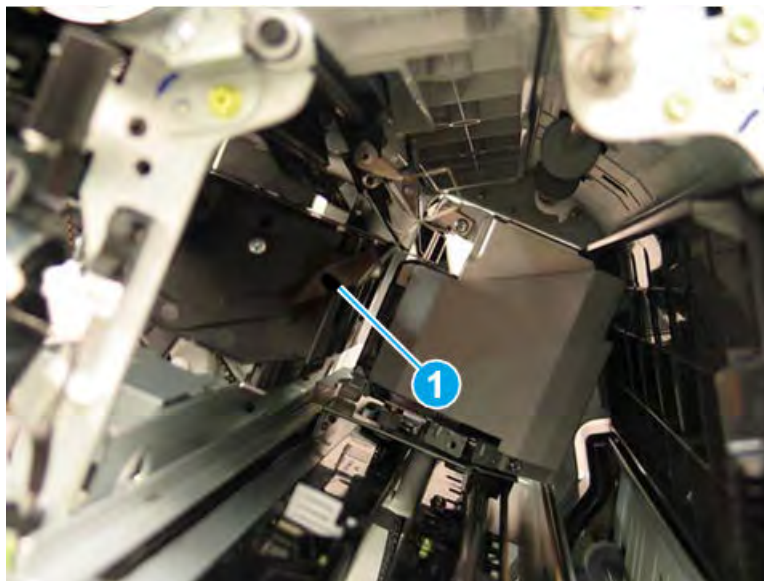


17. Reverse the removal steps to install the assembly. Also use the following special installation instructions.

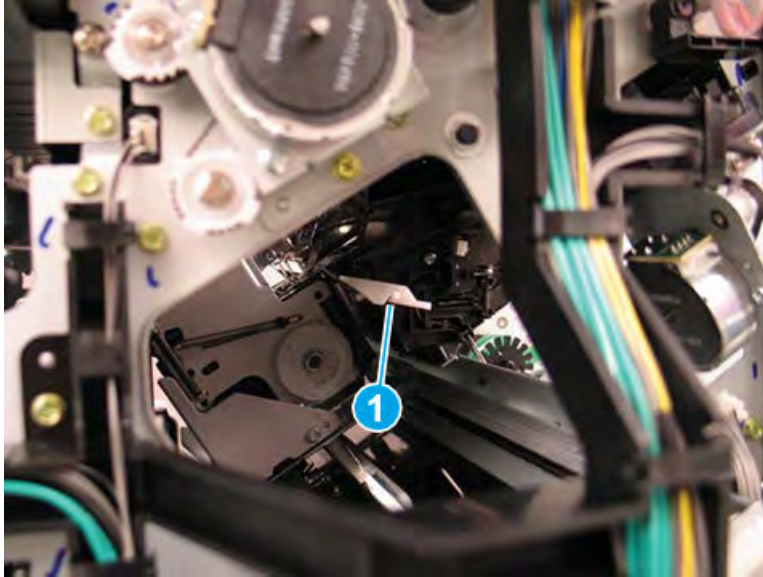
 **NOTE:** Continue to reverse the removal steps to finish installing the assembly.

#### Special installation instructions: Ejector unit

- a. When the front tamper shaft is removed, the retainer arm that held the one end of the shaft will drop down. When reinstalling the shaft, raise the retainer arm and position the end of the shaft in the notch (callout 1).



- b. When the rear tamper shaft is removed, the retainer arm that held the one end of the shaft will drop down. When reinstalling the shaft, raise the retainer arm and position the end of the shaft in the notch (callout 1).



### Remove the front tamper unit

Follow these steps to remove the front tamper unit.

- ▲ Lift the front tamper away from the finisher to remove it

**Figure 5-617** Remove the front tamper

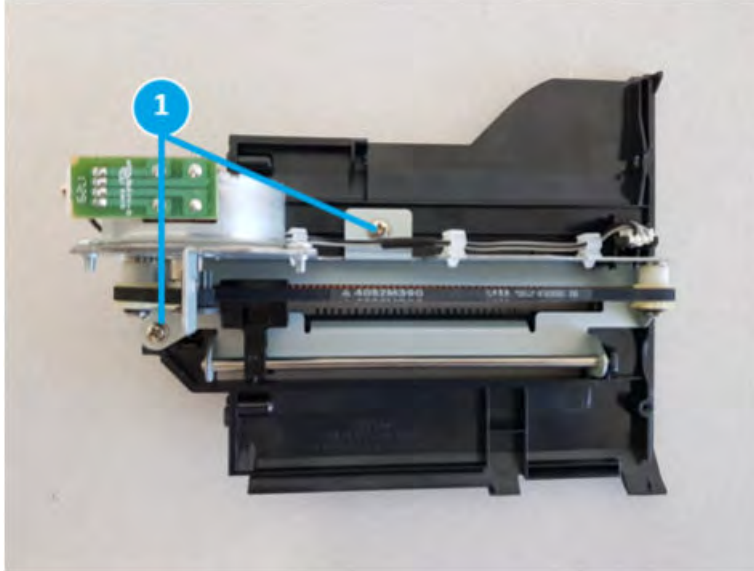


### Remove the front tamper home sensor(S6)

Follow these steps to remove the front tamper home sensor(S6).

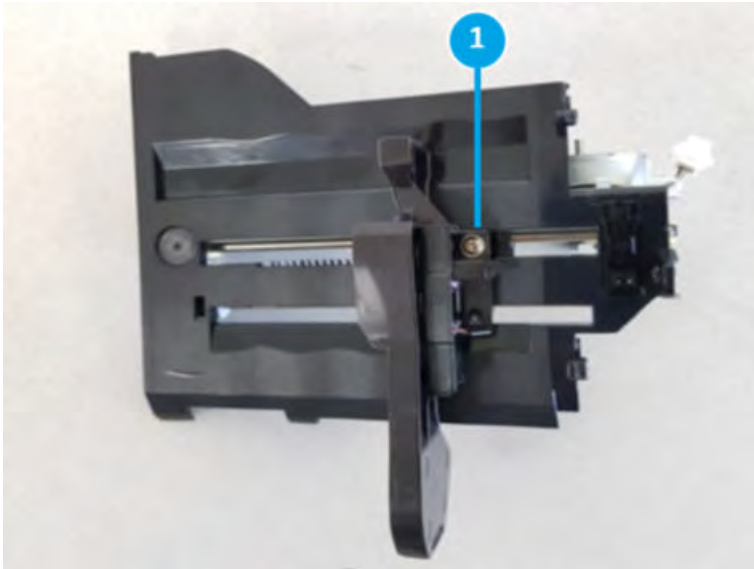
1. Remove two screws (callout 1) at front tamper.

Figure 5-618 Remove two screws



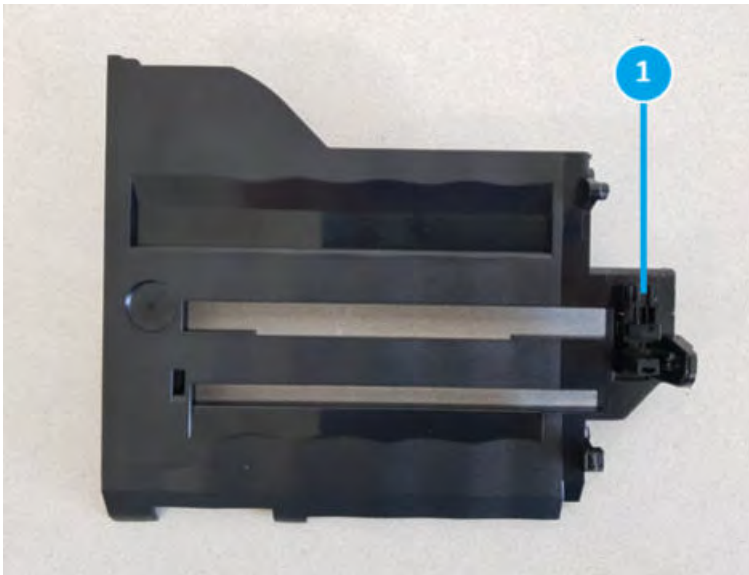
2. Remove one screw (callout 1)

Figure 5-619 Remove one screw



3. Remove front tamper home sensor(S6, callout 1)

Figure 5-620 Remove front tamper home sensor



### Unpack the replacement assembly

Follow these steps to unpack the replacement assembly.

1. Dispose of the defective part.

---



 **NOTE:** HP recommends responsible disposal of the defective part.


<http://www8.hp.com/us/en/hp-information/environment/product-recycling.html>


---

2. Unpack the replacement part from the packaging.

---

 **CAUTION:**  Some parts are sensitive to electrostatic discharge (ESD). Always perform service work at an ESD-protected workstation or mat. If an ESD workstation or mat is not available, touch the sheet-metal chassis to provide a static ground before touching an ESD-sensitive assembly. Protect the ESD-sensitive assemblies by placing them in ESD pouches when they are out of the printer.


 **IMPORTANT:** Make sure that all of the shipping materials (for example shipping tape) are removed from the replacement part prior to installation.

 **NOTE:** If the replacement part is a roller or pad, avoid touching the spongy part of it. Skin oils on the roller or pad can cause paper pickup and/or print-quality problems. HP recommends using disposable gloves when handling rollers or pads or washing your hands before touching rollers or pads.

---

3. To install an assembly, reverse the removal steps.

---

 **NOTE:** When applicable, special installation instructions are provided for an assembly at the end of the removal procedure. Always completely read the removal instructions and follow all special installation instructions.

---




## Removal and replacement: Front tamper motor (M4)


Learn how to remove and replace the front tamper motor.

### Introduction

This document provides the procedures to remove and replace the front tamper motor on the finisher.

 **IMPORTANT:** When applicable, special installation instructions are provided for an assembly at the end of the removal procedure. Always completely read the removal instructions and follow all special installation instructions.

### Before performing service

- Turn the printer power off. A shutting-down message appears on the control-panel display.
-  **WARNING!** To avoid damage to the printer, turn the power off and wait until the printer shuts down before removing the power cable.
- Disconnect the printer power cable after the printer has completely shut down (the control-panel display is blank).
- Release the finisher from the printer by pulling out on the release latch inside the finisher door.
- Disconnect the cable from the bridge unit to the finisher.
- Disconnect the cable from the finisher to the printer.

Use the table below to identify the correct part number for your printer. To order the part, go to <https://parts.hp.com>.

**Table 5-115** Part information

Part number	Part description
JC93-01001A	Front tamper motor

### Required tools

- #2 JIS screwdriver with a magnetic tip

### After performing service

- Connect the cable from the finisher to the printer.
- Connect the cable from the bridge unit to the finisher.
- Attach the finisher to the printer, and then push in on the release latch inside the finisher door.
- Connect the printer power cable.
- Turn the printer power on.

### Post service test

Process a job through the finisher and verify that the finisher works correctly.

## Remove the right upper cover (finisher)

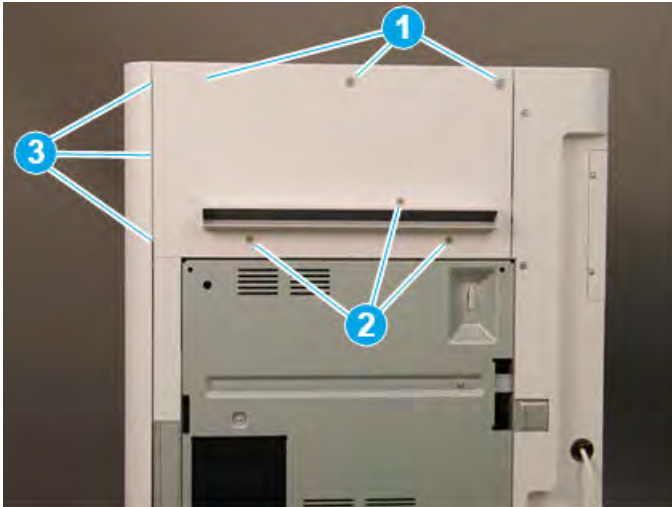
Follow these steps to remove the right upper cover (finisher).

- ▲ Remove one screw cap and three machine screws on the upper edge of the cover (callout 1). Remove three sheet metal screws (callout 2) on the lower portion of the cover. Rotate the right edge of the cover away from the finisher, and then slide the cover right to release three tabs (callout 3).

💡 **TIP:** The lower screws are shorter in length than the upper screws.

**TIP:** Reverse the removal steps to install the assembly.

**Figure 5-621** Remove the right upper cover

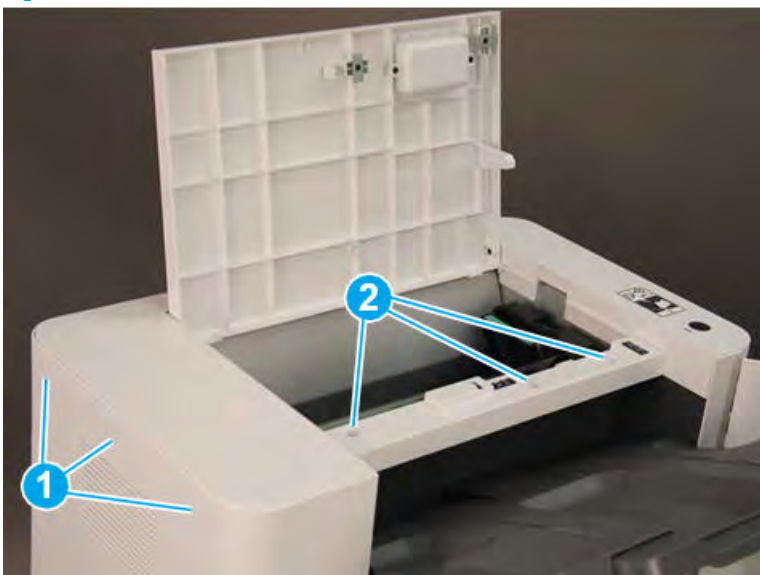


## Remove the top cover (finisher)

Follow these steps to remove the top cover (finisher).

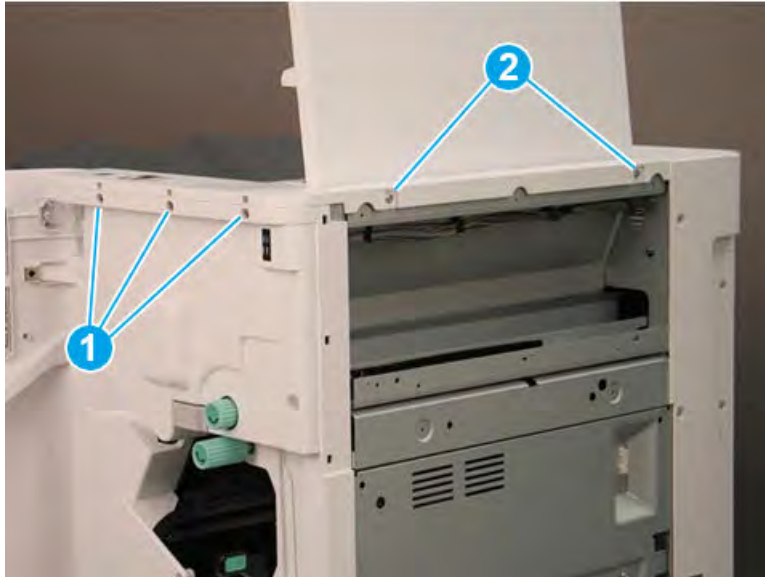
1. Remove three screw caps and three self-tapping screws at the top of the rear cover (callout 1), and then remove three machine screws (callout 2) on top of the cover.

**Figure 5-622** Remove six screws




2. Remove three self-tapping screws at the top of the front cover (callout 1), and then remove two machine screws (callout 2) at the top of the right side.

Figure 5-623 Remove five screws



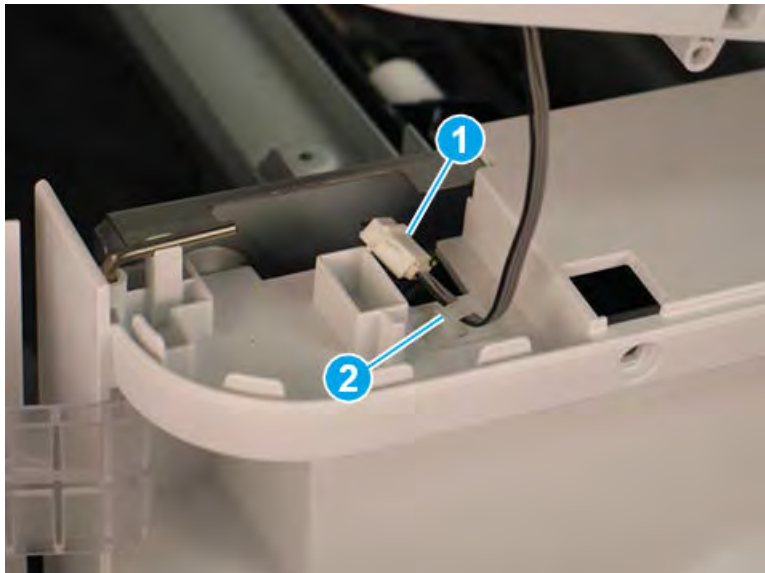
3. Lift the cover up slightly. Disconnect one in-line connector (callout 1), and then release one retainer (callout 2).

---

 **TIP:** Reverse the removal steps to install the assembly.

---

Figure 5-624 Disconnect one connector and release retainer

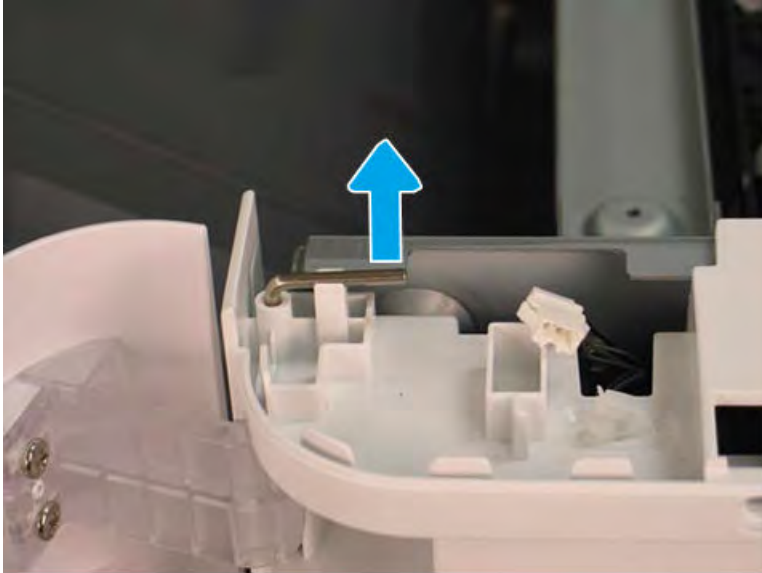


### Remove the front door (finisher)

Follow these steps to remove the front door (finisher).

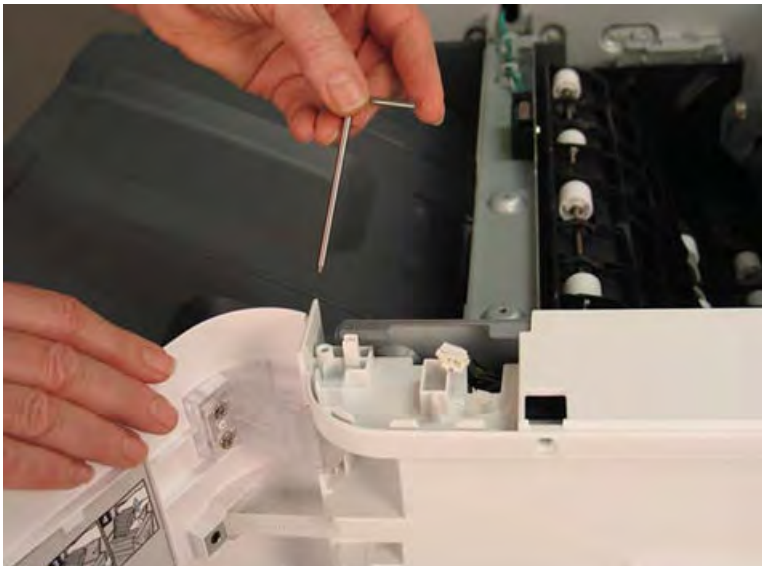
1. Lift the top hinge pin up to release it from the retainer.

Figure 5-625 Lift the top hinge pin



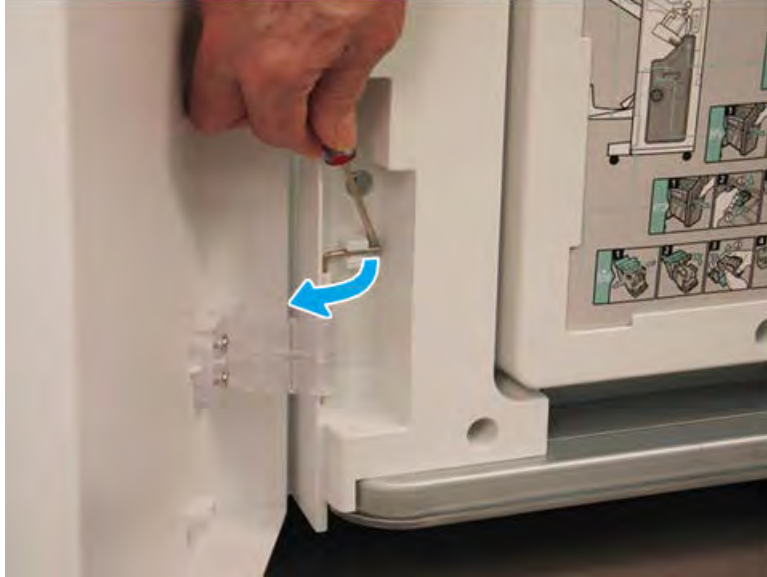
2. Pull the top hinge pin up to remove it.

Figure 5-626 Remove the top hinge pin



3. Use a small, flat-blade screwdriver to release the lower hinge pin from the retainer, and then rotate it away from the finisher.

Figure 5-627 Release the lower hinge pin




4. Support the door with one hand, and then pull the lower hinge pin straight up to remove it.

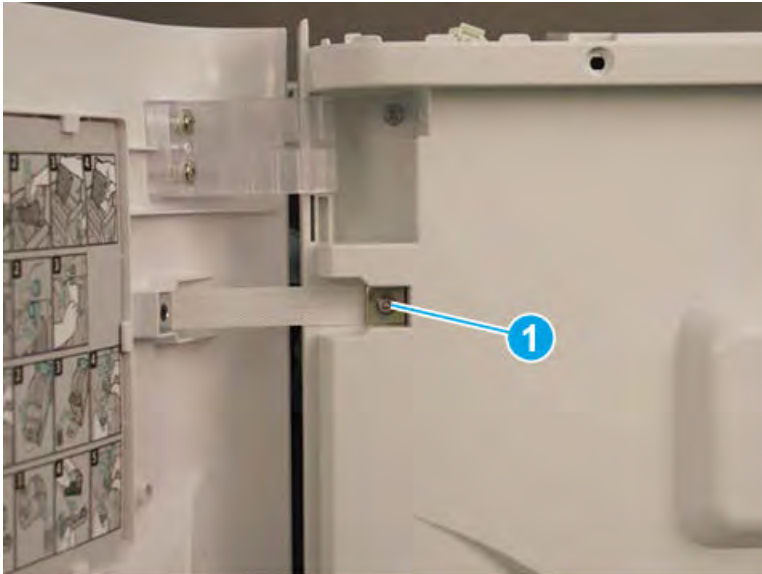
Figure 5-628 Remove the lower hinge pin



5. Support the door with one hand, and then remove one screw (callout 1) to release the strap. Remove the front door.

 **TIP:** Reverse the removal steps to install the assembly.

**Figure 5-629** Remove the front door

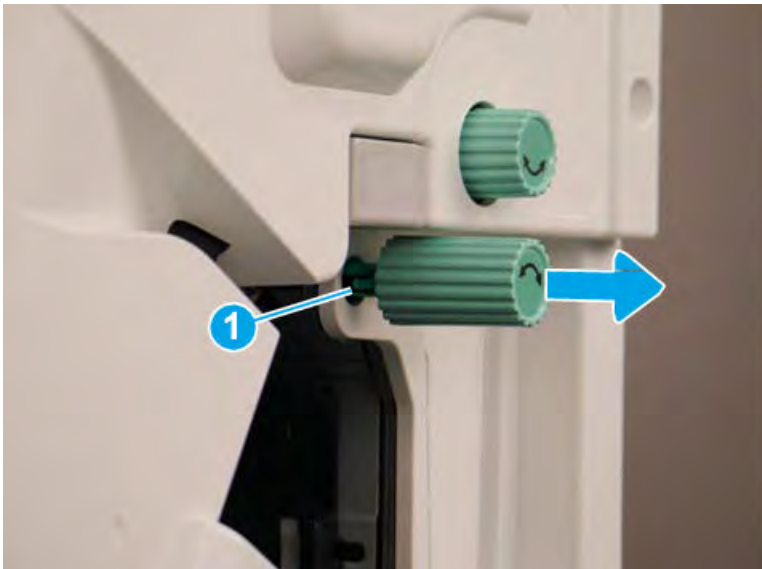


### Remove the front cover (finisher)

Follow these steps to remove the front cover (finisher).

1. Release one tab (callout 1), and then pull the jam-access knob away from the finisher to remove it.

**Figure 5-630** Remove the jam-access knob



2. If the punch unit is installed, remove the punch waste bin (callout 1).


3. Remove one screw (callout 1) on top of the front cover.

Figure 5-631 Remove one screw



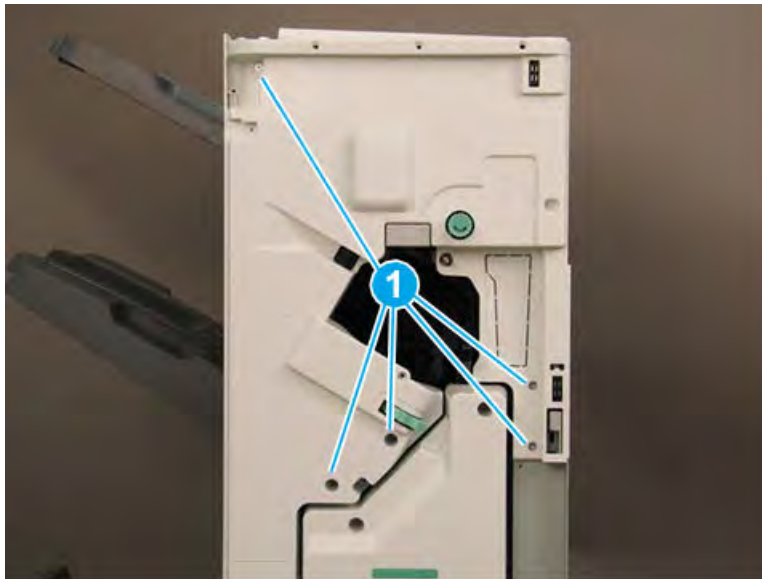
4. Remove five machine screws (callout 1), and then remove the front cover.

---

 **TIP:** Reverse the removal steps to install the assembly.

---

Figure 5-632 Remove the front cover

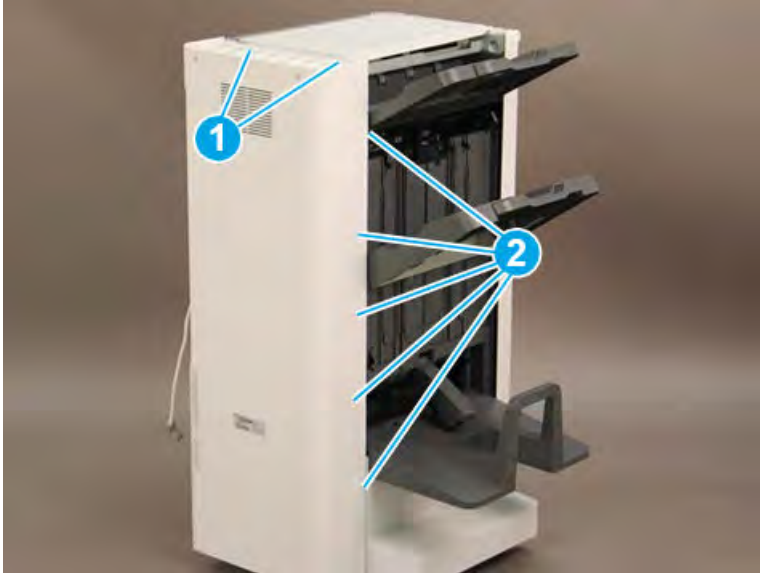


### Remove the rear cover (finisher)

Follow these steps to remove the rear cover (finisher).

1. Remove two self-tapping screws (callout 1) on the top of the rear cover, and then remove five screw caps and five machine screws (callout 2) on the left side of the cover.

Figure 5-633 Remove seven screws

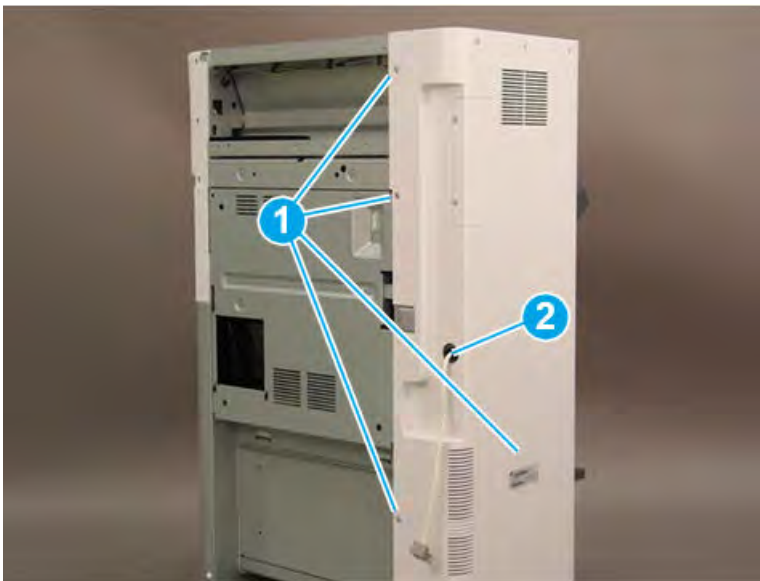


2. Remove one screw cap and four machine screws (callout 1) Remove the rear cover.

 **NOTE:** Make sure to thread the power cable (callout 2) through the opening in the cover.

 **TIP:** Reverse the removal steps to install the assembly

Figure 5-634 Remove the rear cover



### Remove the booklet output tray

Follow these steps to remove the booklet output tray.

1. Raise the booklet output tray up (callout 1), and then pull it away from the finisher (callout 2) to remove it.



Figure 5-635 Remove the booklet output tray



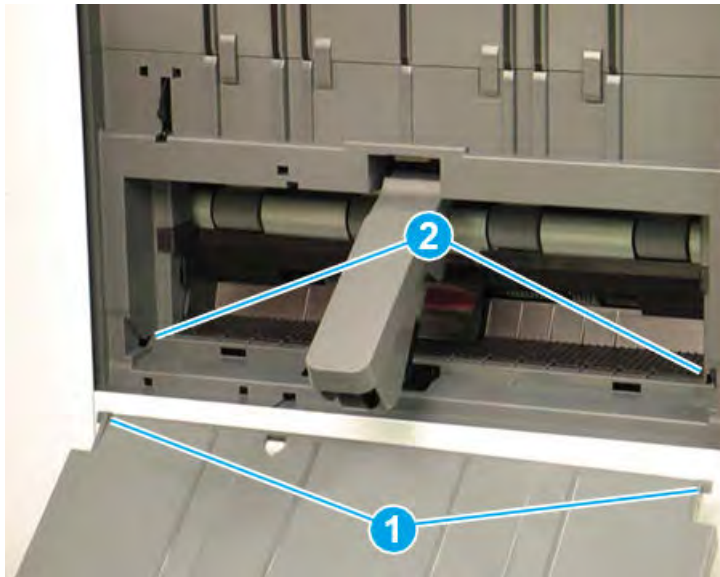
2. Reverse the removal steps to install the assembly. Also use the following special installation instructions.

 **NOTE:** Continue to reverse the removal steps to finish installing the assembly

Special installation instructions: booklet output tray

Position the tabs (callout 1) on the tray into the slots (callout 2) on the finisher.

Figure 5-636 Install the booklet output tray

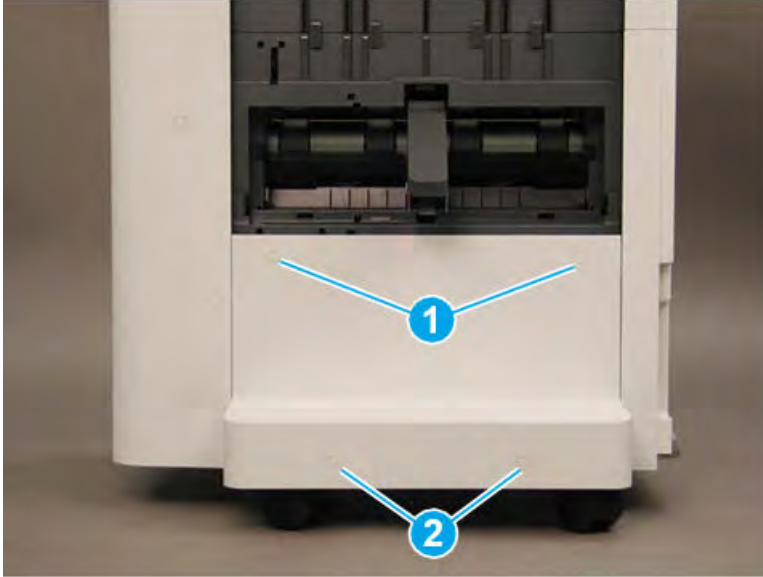


### Remove the caster cover

Follow these steps to remove the caster cover.


1. Remove two screw caps and two self-tapping screws (callout 1). Remove two screw caps and two machine screws (callout 2).

Figure 5-637 Remove four screws



2. Rotate the left edge of the cover away from the finisher (callout 1), and then slide the cover to the left (callout 2) to remove it.

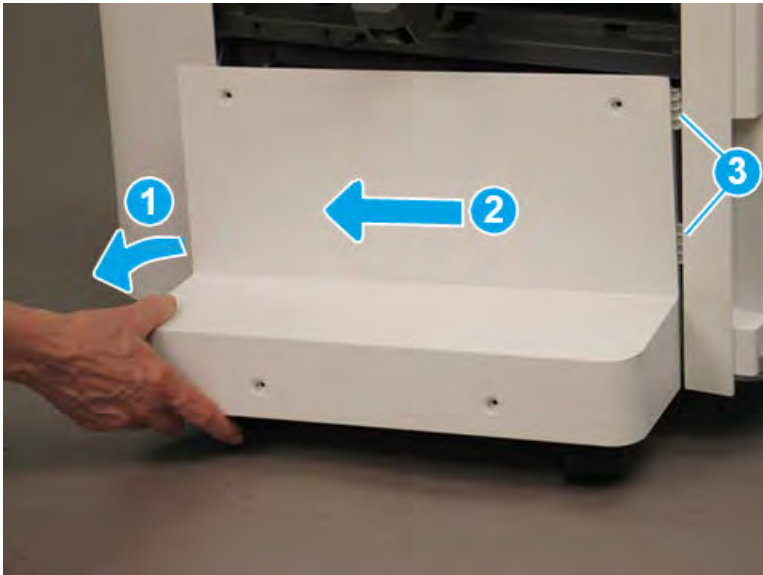
---

 **TIP:** Make sure that two tabs (callout 3) are positioned under the front lower cover when reinstalling the caster cover.

**TIP:** Reverse the removal steps to install the assembly

---

Figure 5-638 Remove the caster cover




### Remove the left lower cover (finisher)

Follow these steps to remove the left lower cover (finisher).

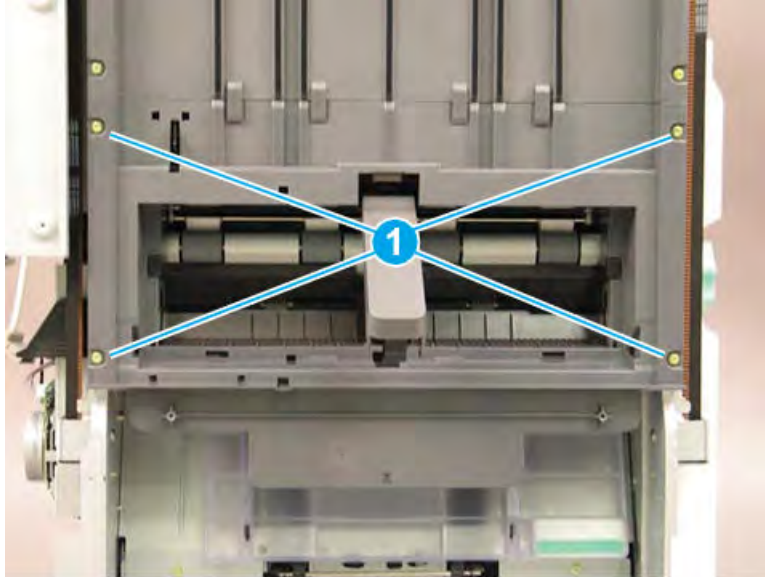
1. Remove four screws (callout 1).

---

 **NOTE:** Raise the lower output tray as needed to access the screws.

---

Figure 5-639 Remove four screws

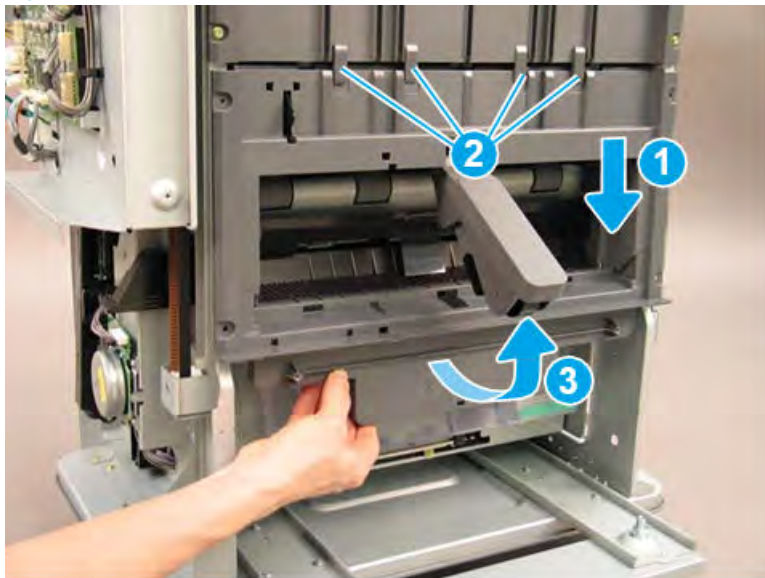


2. Slide the shield down (callout 1) to release it from four tabs (callout 2), and then rotate it away from the finisher (callout 3).

**⚠ CAUTION:** The shield is still attached to the finisher. Do not attempt to completely remove the shield.

**💡 TIP:** Position the shield under the four tabs (callout 2) when reinstalling it.

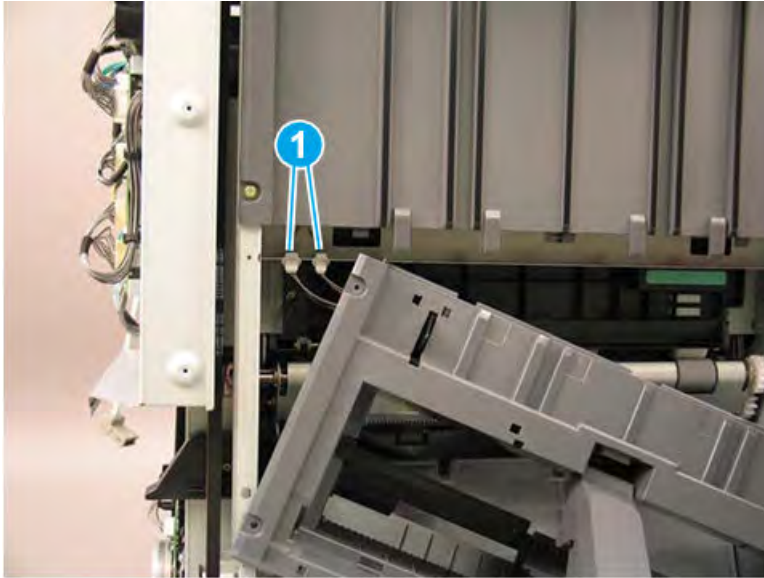
Figure 5-640 Release the lower shield



3. Disconnect two connectors (callout 1), and then remove the shield.

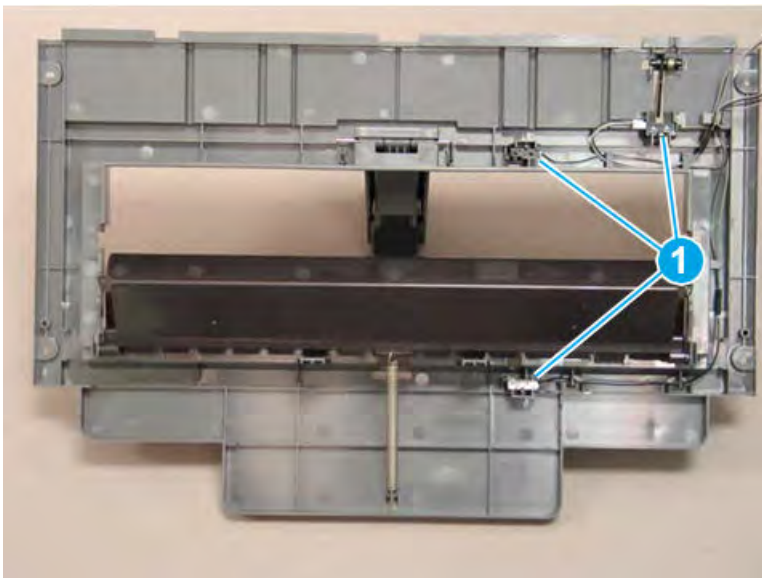
 **TIP:** Reverse the removal steps to install the assembly.

**Figure 5-641** Disconnect two connectors



4. If you are replacing the left lower cover, locate three sensors (callout 1) on the back of the left lower cover. Remove these sensors and transfer them to the replacement part.

**Figure 5-642** Remove the left lower cover

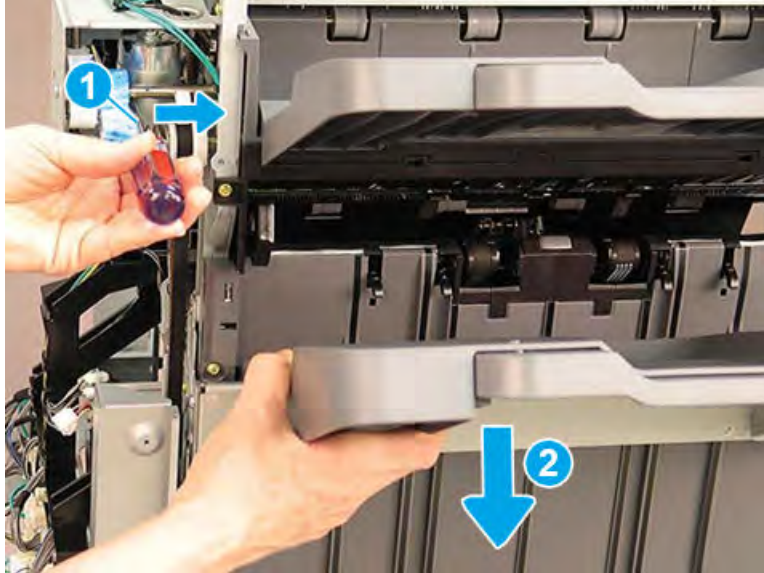


### Remove the left upper cover (finisher)

Follow these steps to remove the left upper cover (finisher).

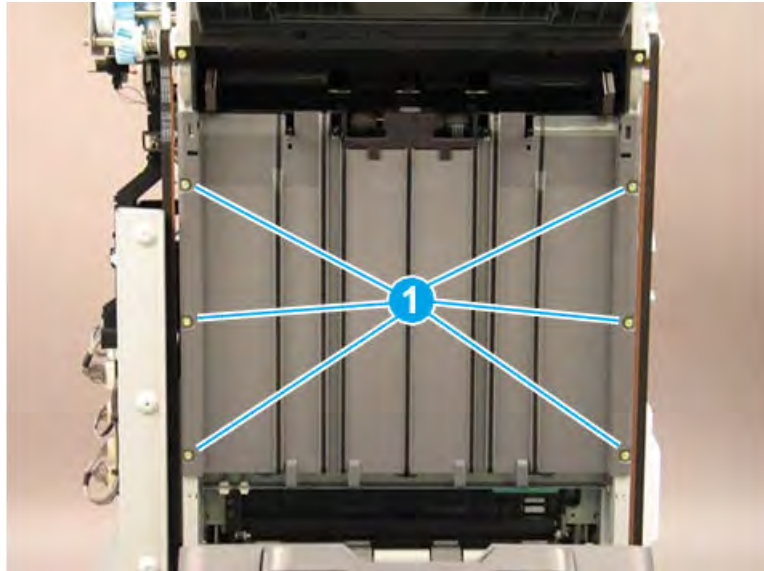
1. Bring the lower output tray down by positioning the shaft of a screwdriver on the clutch (callout 1) and gently pressing to the right to release the clutch. Hold the clutch in the released position and lower the tray (callout 2) to the lowest position.

Figure 5-643 Lower the output tray



2. Remove six machine screws (callout 1).

Figure 5-644 Remove six screws

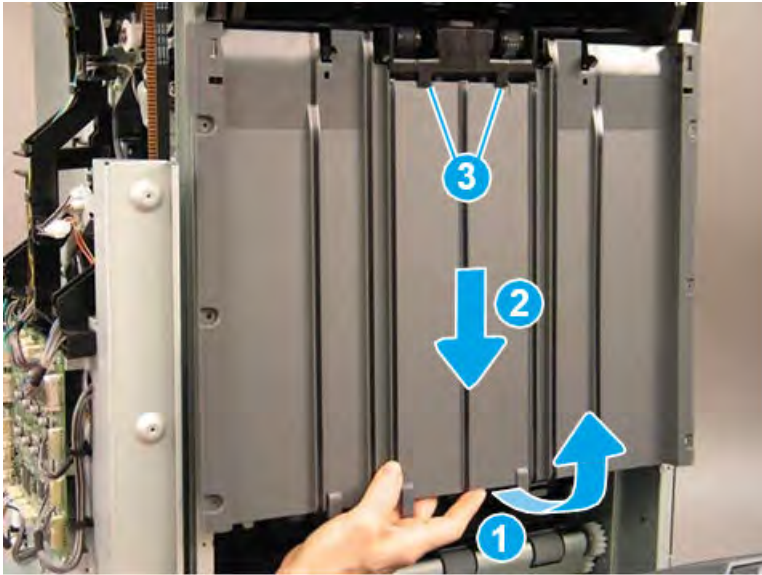


3. Rotate the lower edge of the shield away from the finisher (callout 1), and then slide the shield down (callout 2) to release it from two tabs (callout 3).

**⚠ CAUTION:** The shield is still attached to the finisher. Do not attempt to completely remove the shield.

**💡 TIP:** Position the shield under the two tabs (callout 3) when reinstalling it.

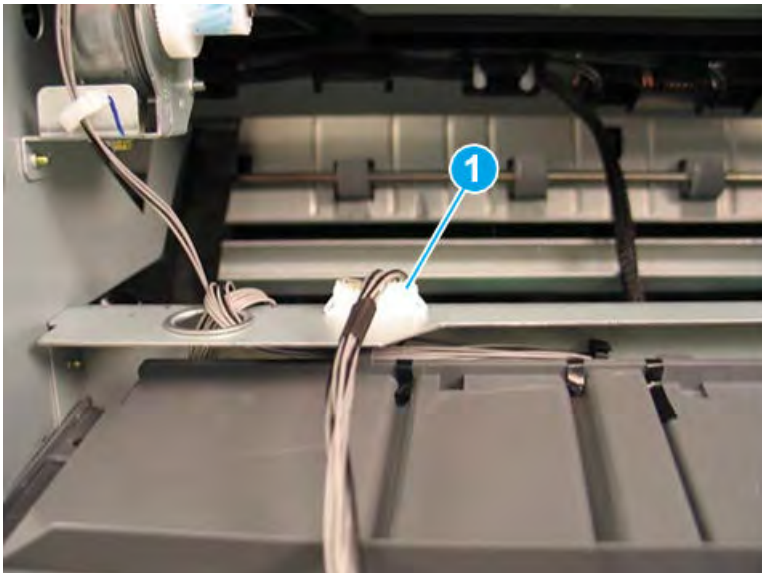
**Figure 5-645** Release the shield



4. Disconnect one connector (callout 1), and then remove the upper shield assembly.

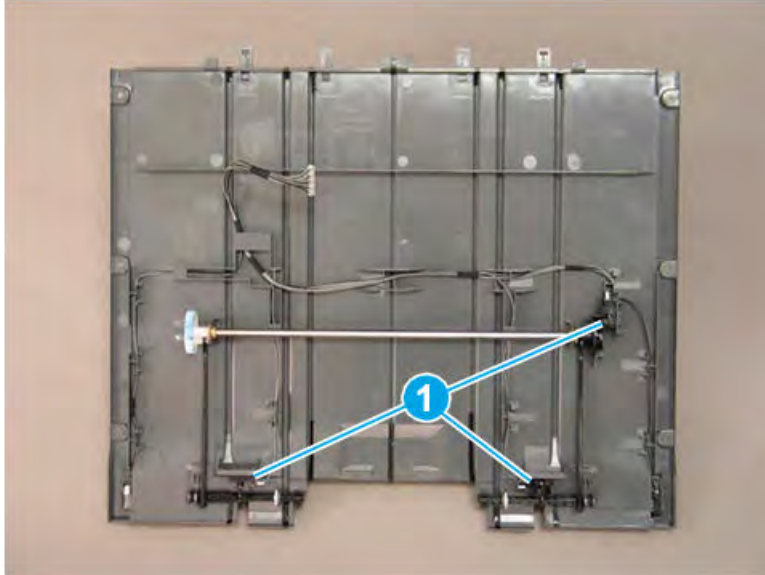
**💡 TIP:** Reverse the removal steps to install the assembly.

**Figure 5-646** Disconnect one connector



5. If you are replacing the left upper cover, locate three sensors (callout 1) on the back of the left upper cover. Remove these sensors and transfer them to the replacement part.

Figure 5-647 Remove the left upper cover

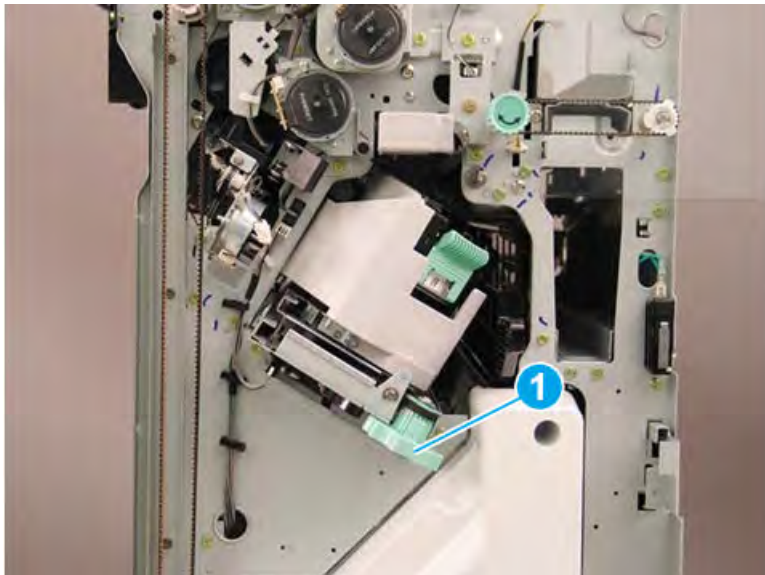


#### Remove the ejector unit (finisher)

Follow these steps to remove the ejector unit (finisher).

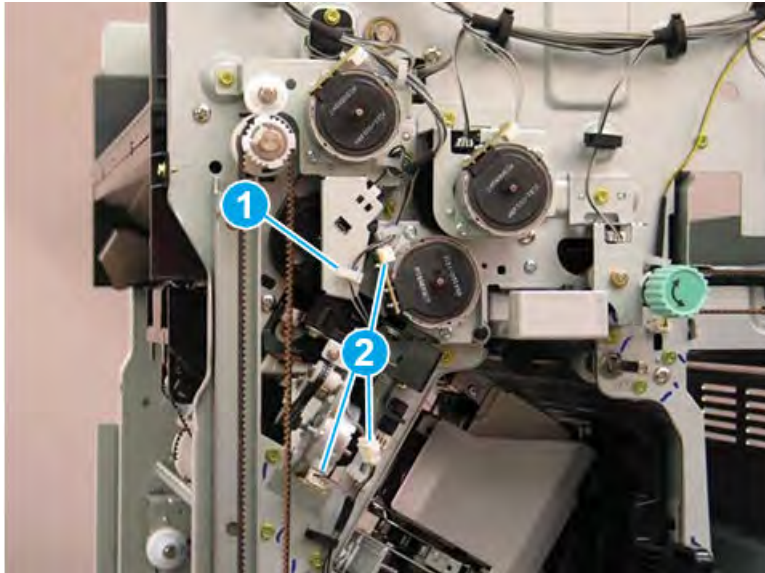
1. Rotate the green wheel to move the staple unit to the center of the finisher.

Figure 5-648 Move the staple unit to the center



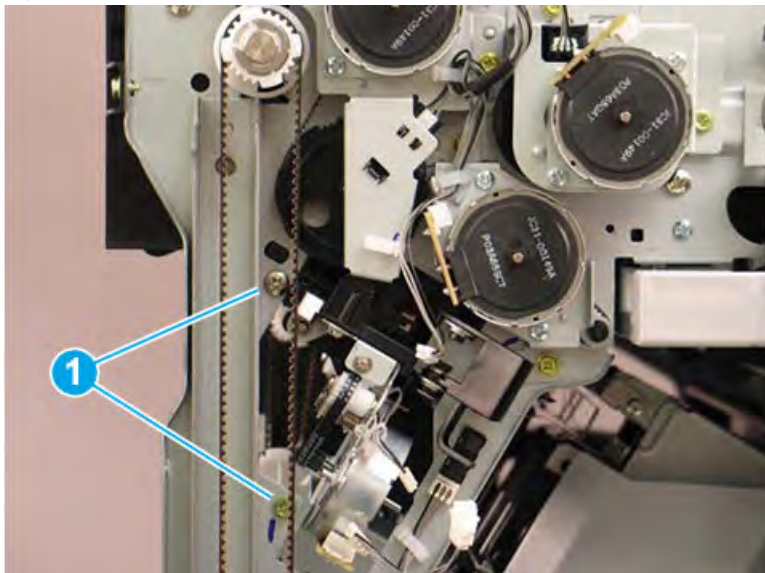
2. Release one retainer (callout 1), and then disconnect three connectors (callout 2).

Figure 5-649 Disconnect three connectors



3. Remove two screws (callout 1).

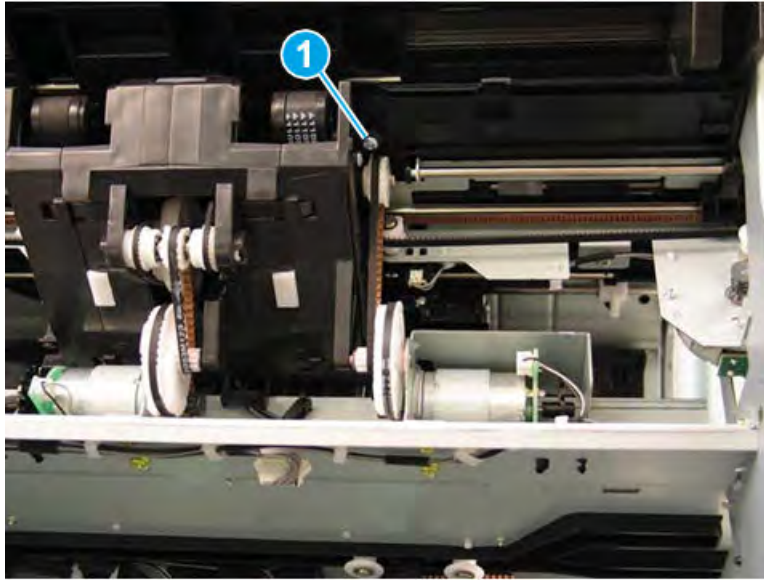
Figure 5-650 Remove two screws





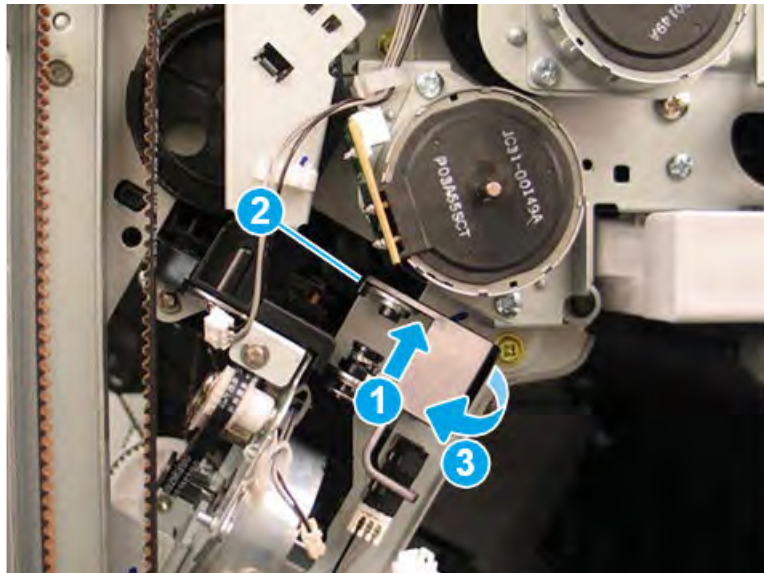
4. At the left side of the finisher, remove one screw (callout 1).

Figure 5-651 Remove one screw



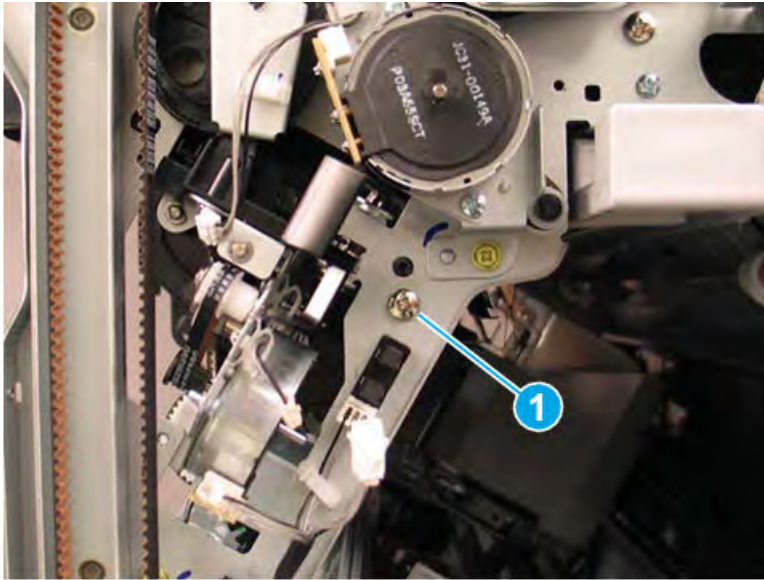
5. Press up on the hinge (callout 1), release one tab (callout 2), and then rotate the sensor away from the finisher (callout 3).

Figure 5-652 Rotate the sensor



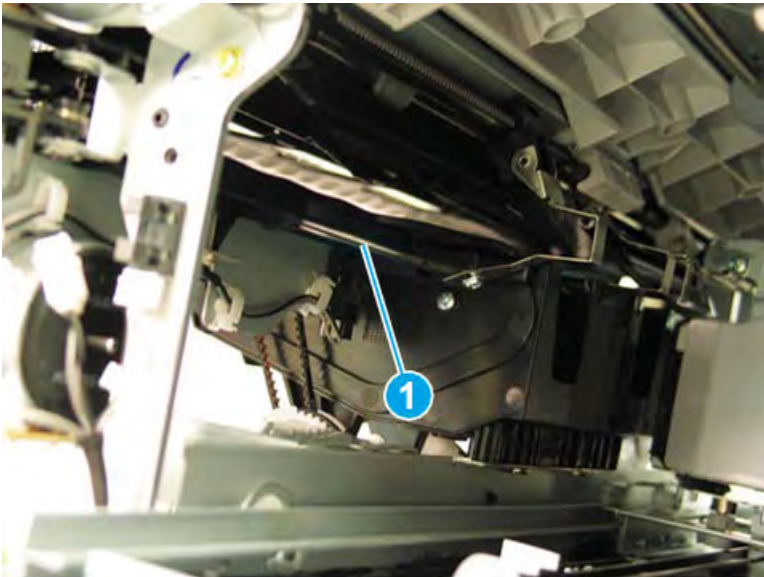
6. Remove one screw (callout 1).

Figure 5-653 Remove one screw



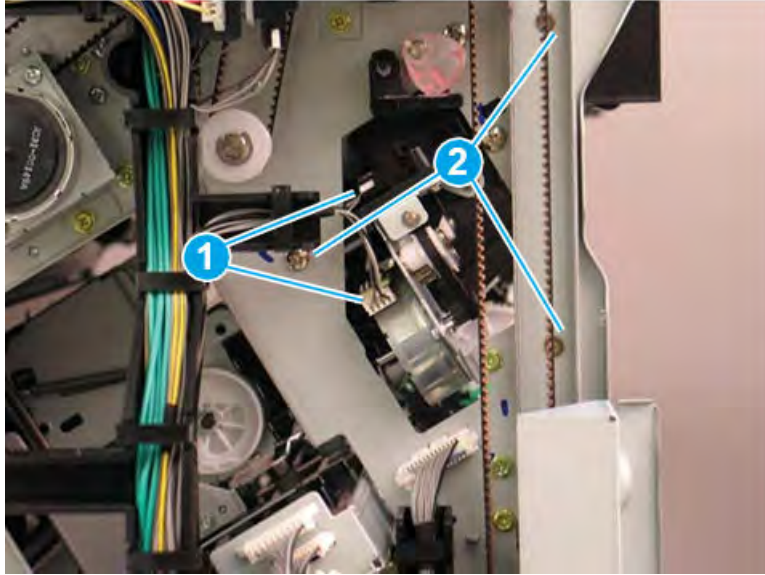
7. Look inside the finisher through the stapler opening in the front and pull down to release and remove one shaft (callout 1) on the front tamper unit.

Figure 5-654 Remove the front tamper shaft



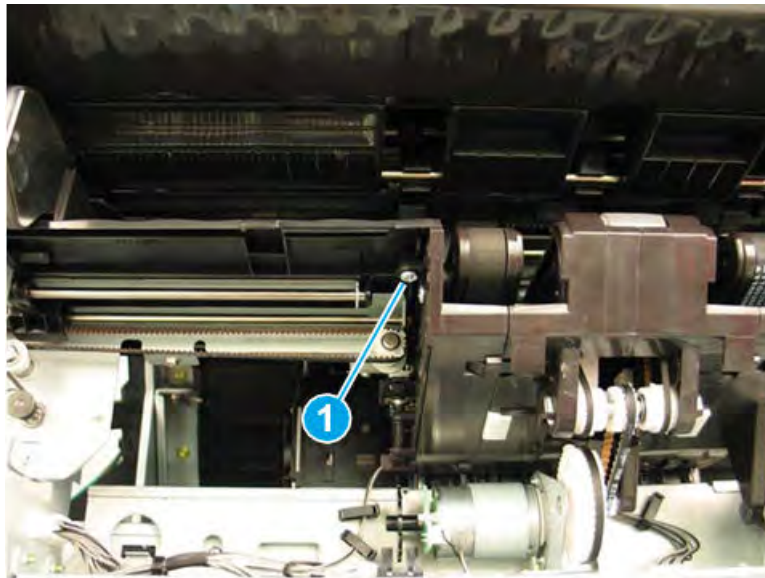
8. At the rear of the finisher, disconnect two connectors (callout 1), and then remove three screws (callout 2).

Figure 5-655 Disconnect two connectors and remove three screws



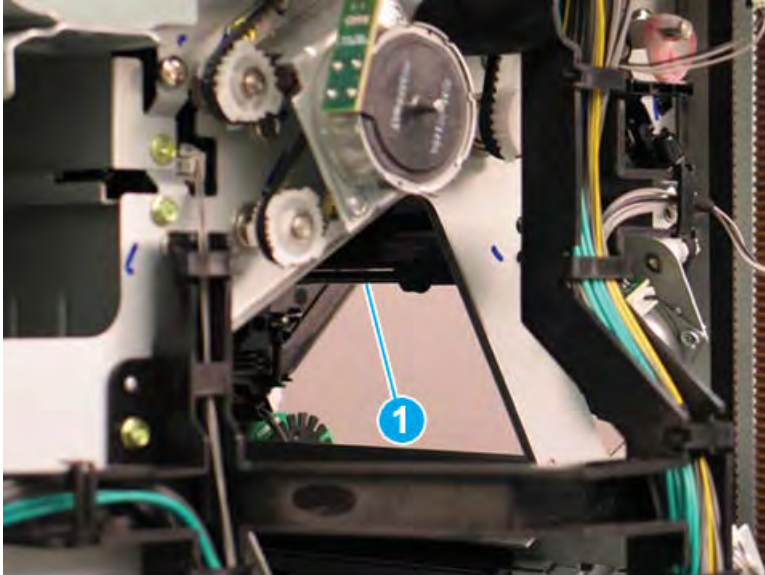
9. At the left side of the finisher, remove one screw (callout 1).

Figure 5-656 Remove one screw



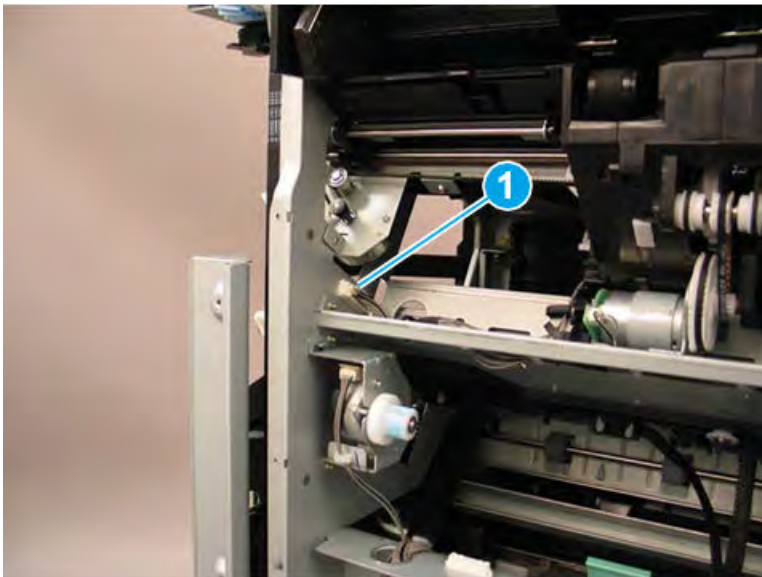
10. Look inside the finisher through the stapler opening in the rear and pull down to release and remove one shaft (callout 1) on the rear tamper unit.

Figure 5-657 Remove the rear tamper shaft



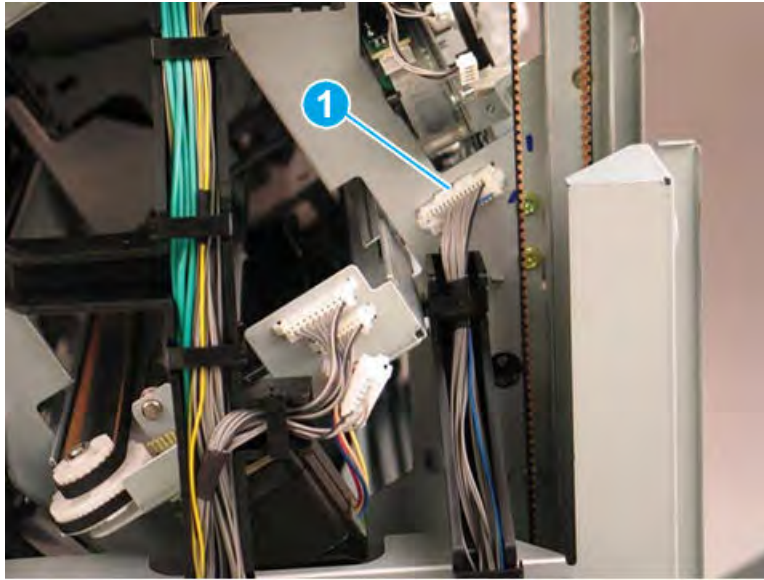
11. At the left side of the finisher, disconnect one connector (callout 1).

Figure 5-658 Disconnect one connector



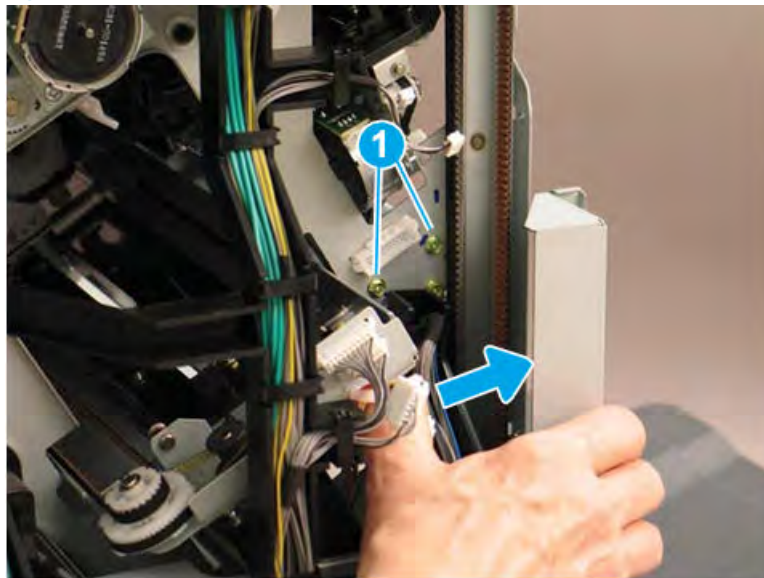
12. At the rear of the finisher, disconnect one connector (callout 1).

Figure 5-659 Disconnect one connector



13. At the rear of the finisher, press the wire retainer to the right to access and remove two screws (callout 1).

Figure 5-660 Disconnect one connector



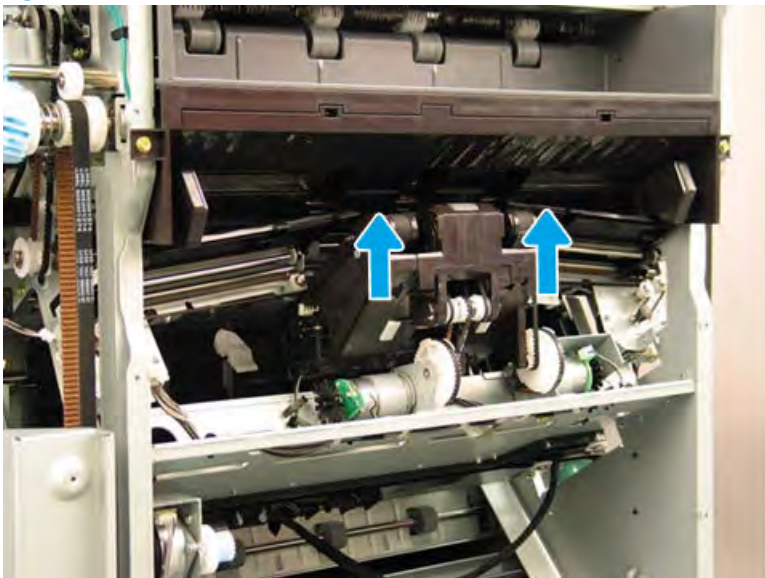
14. At the front of the finisher, remove two screws (callout 1).

Figure 5-661 Remove two screws



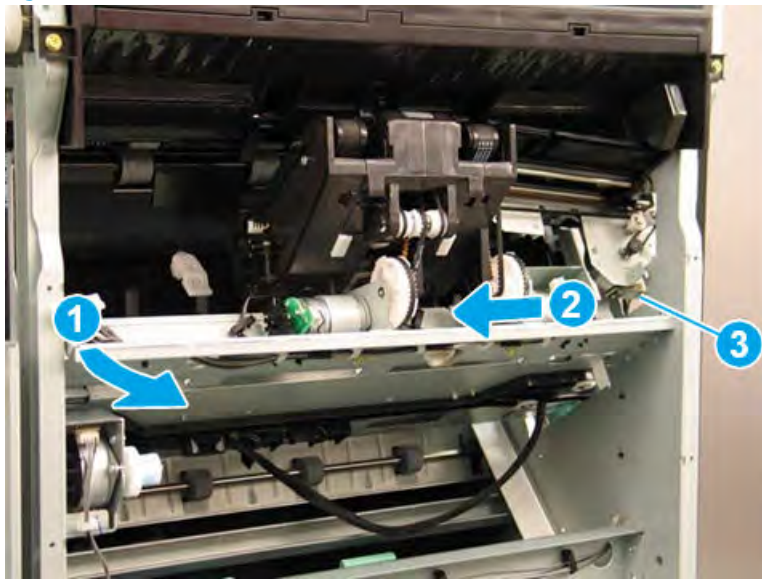
15. Lift the inside edges of the front and rear tampers up.

Figure 5-662 Lift the edges of the tampers



16. Rotate the rear edge of the ejector unit away from the finisher (callout 1), and then slide it toward the rear of the finisher (callout 2) to remove it. Make sure that the PCA (callout 3) stays clear of the sheet metal frame.

Figure 5-663 Remove the ejector unit

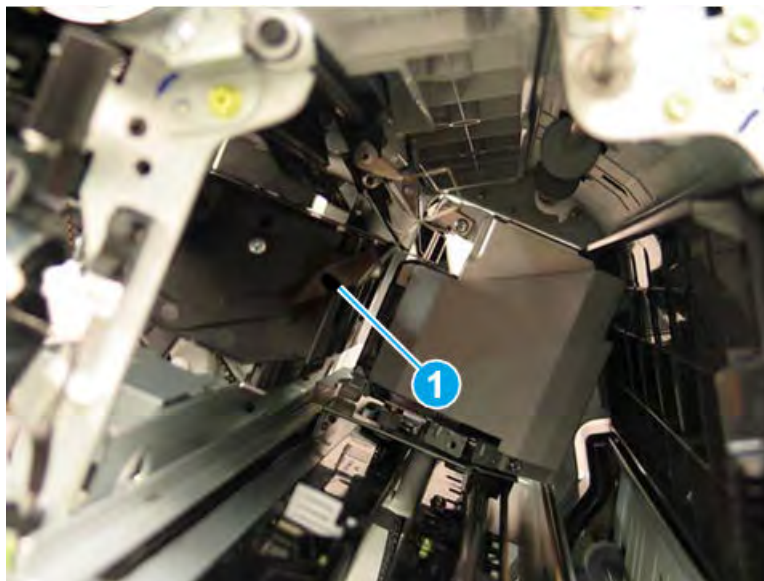


17. Reverse the removal steps to install the assembly. Also use the following special installation instructions.

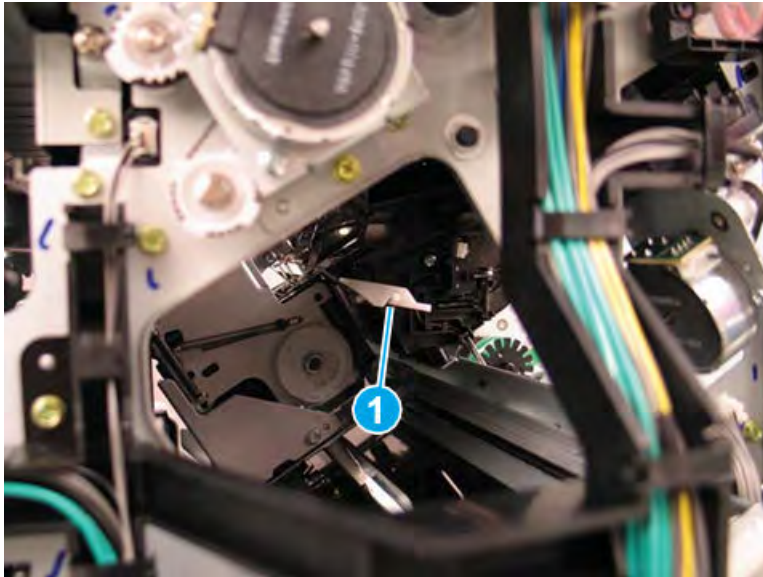
 **NOTE:** Continue to reverse the removal steps to finish installing the assembly.

#### Special installation instructions: Ejector unit

- a. When the front tamper shaft is removed, the retainer arm that held the one end of the shaft will drop down. When reinstalling the shaft, raise the retainer arm and position the end of the shaft in the notch (callout 1).



- b. When the rear tamper shaft is removed, the retainer arm that held the one end of the shaft will drop down. When reinstalling the shaft, raise the retainer arm and position the end of the shaft in the notch (callout 1).



### Remove the front tamper unit

Follow these steps to remove the front tamper unit.

- ▲ Lift the front tamper away from the finisher to remove it

**Figure 5-664** Remove the front tamper



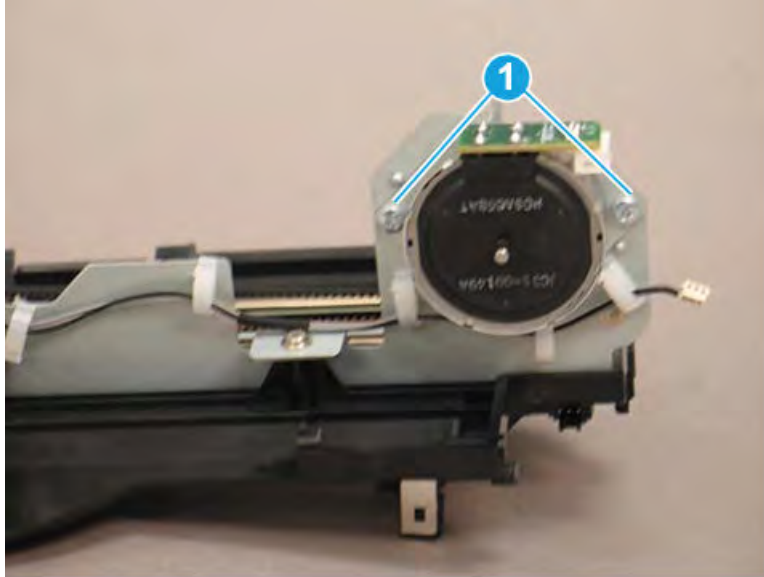
### Remove the front tamper motor (M4)

Follow these steps to remove the front tamper motor (M4).

1. Remove two screws (callout 1).



Figure 5-665 Remove two screws



2. Release the belt (callout 1), and then remove the front tamper motor.

---

 **TIP:** Make sure that the belt is routed correctly when reinstalling the motor.

---

**TIP:** Reverse the removal steps to install the assembly.

---

Figure 5-666 Release the belt and remove the motor



### Unpack the replacement assembly

Follow these steps to unpack the replacement assembly.

1. Dispose of the defective part.

---

 **NOTE:** HP recommends responsible disposal of the defective part.

<http://www8.hp.com/us/en/hp-information/environment/product-recycling.html>

---

2. Unpack the replacement part from the packaging.


 **CAUTION:**  Some parts are sensitive to electrostatic discharge (ESD). Always perform service work at an ESD-protected workstation or mat. If an ESD workstation or mat is not available, touch the sheet-metal chassis to provide a static ground before touching an ESD-sensitive assembly. Protect the ESD-sensitive assemblies by placing them in ESD pouches when they are out of the printer.

 **IMPORTANT:** Make sure that all of the shipping materials (for example shipping tape) are removed from the replacement part prior to installation.

 **NOTE:** If the replacement part is a roller or pad, avoid touching the spongy part of it. Skin oils on the roller or pad can cause paper pickup and/or print-quality problems. HP recommends using disposable gloves when handling rollers or pads or washing your hands before touching rollers or pads.

---

3. To install an assembly, reverse the removal steps.

 **NOTE:** When applicable, special installation instructions are provided for an assembly at the end of the removal procedure. Always completely read the removal instructions and follow all special installation instructions.

---


Rear tamper

## Removal and replacement: Rear tamper unit


Learn how to remove and replace the rear tamper unit.

### Introduction

This document provides the procedures to remove and replace the rear tamper unit on the finisher.

 **IMPORTANT:** When applicable, special installation instructions are provided for an assembly at the end of the removal procedure. Always completely read the removal instructions and follow all special installation instructions.

### Before performing service

- Turn the printer power off. A shutting-down message appears on the control-panel display.
-  **WARNING!** To avoid damage to the printer, turn the power off and wait until the printer shuts down before removing the power cable.
- Disconnect the printer power cable after the printer has completely shut down (the control-panel display is blank).
- Release the finisher from the printer by pulling out on the release latch inside the finisher door.
- Disconnect the cable from the bridge unit to the finisher.
- Disconnect the cable from the finisher to the printer.

Use the table below to identify the correct part number for your printer. To order the part, go to <https://parts.hp.com>.

Table 5-116 Part information

Part number	Part description
JC82-00898A	Rear tamper

### Required tools

- #2 JIS screwdriver with a magnetic tip
- Small, flat-blade screwdriver

### After performing service

- Connect the cable from the finisher to the printer.
- Connect the cable from the bridge unit to the finisher.
- Attach the finisher to the printer, and then push in on the release latch inside the finisher door.
- Connect the printer power cable.
- Turn the printer power on.

### Post service test

Process a job through the finisher and verify that the finisher works correctly.

### Remove the right upper cover (finisher)

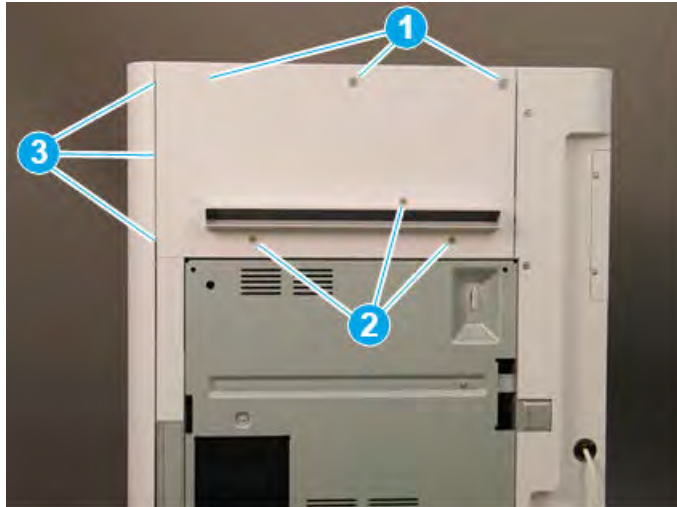
Follow these steps to remove the right upper cover (finisher).

- ▲ Remove one screw cap and three machine screws on the upper edge of the cover (callout 1). Remove three sheet metal screws (callout 2) on the lower portion of the cover. Rotate the right edge of the cover away from the finisher, and then slide the cover right to release three tabs (callout 3).

💡 **TIP:** The lower screws are shorter in length than the upper screws.

**TIP:** Reverse the removal steps to install the assembly.

**Figure 5-667** Remove the right upper cover

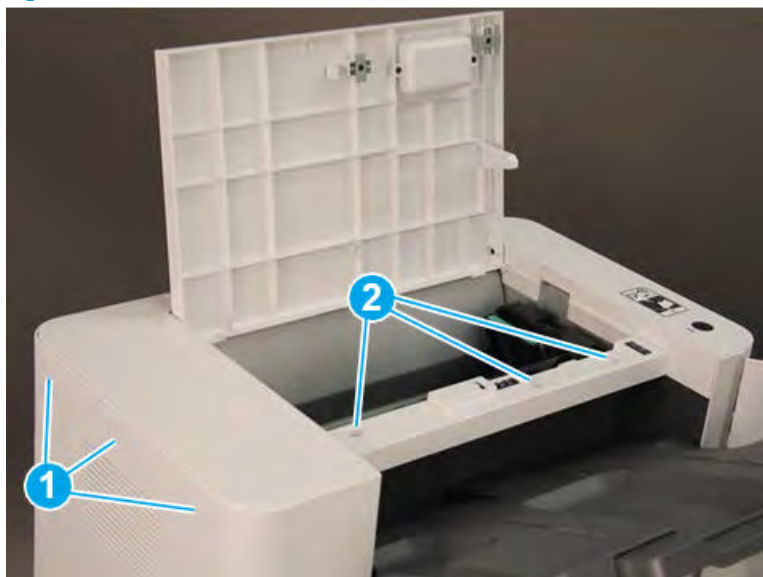


### Remove the top cover (finisher)

Follow these steps to remove the top cover (finisher).

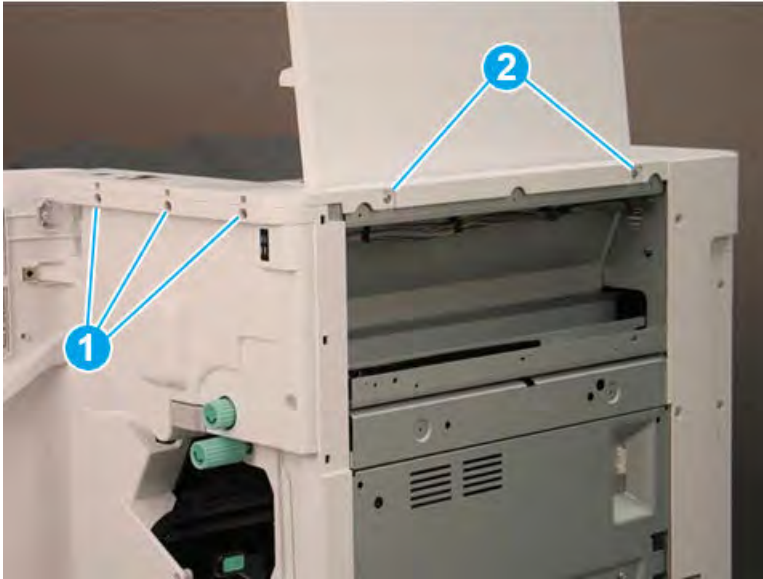
1. Remove three screw caps and three self-tapping screws at the top of the rear cover (callout 1), and then remove three machine screws (callout 2) on top of the cover.

**Figure 5-668** Remove six screws




2. Remove three self-tapping screws at the top of the front cover (callout 1), and then remove two machine screws (callout 2) at the top of the right side.

Figure 5-669 Remove five screws



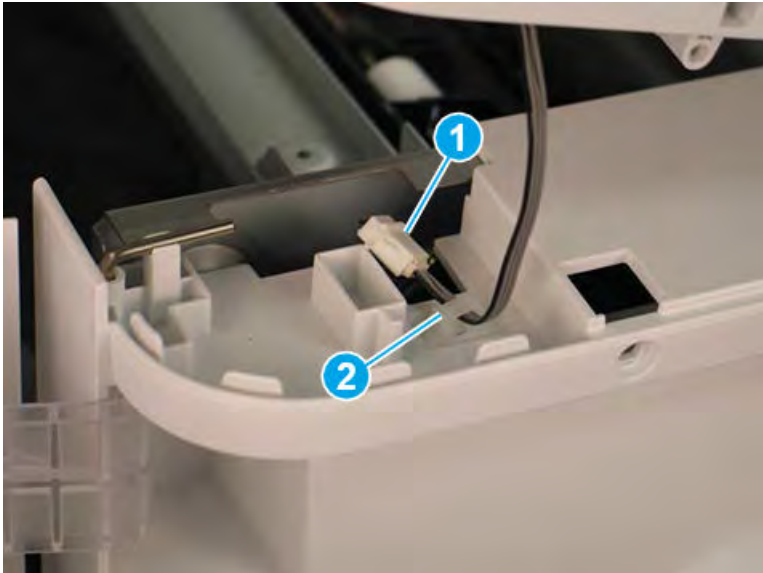
3. Lift the cover up slightly. Disconnect one in-line connector (callout 1), and then release one retainer (callout 2).

---

 **TIP:** Reverse the removal steps to install the assembly.

---

Figure 5-670 Disconnect one connector and release retainer

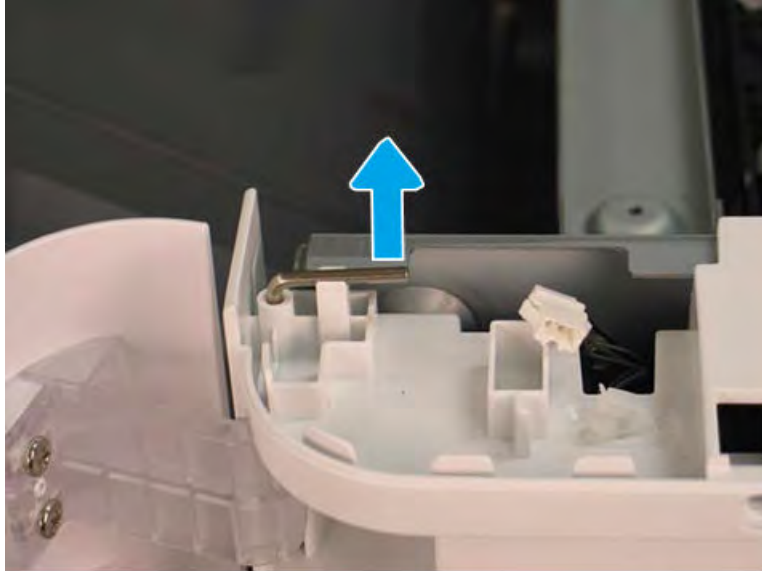


### Remove the front door (finisher)

Follow these steps to remove the front door (finisher).

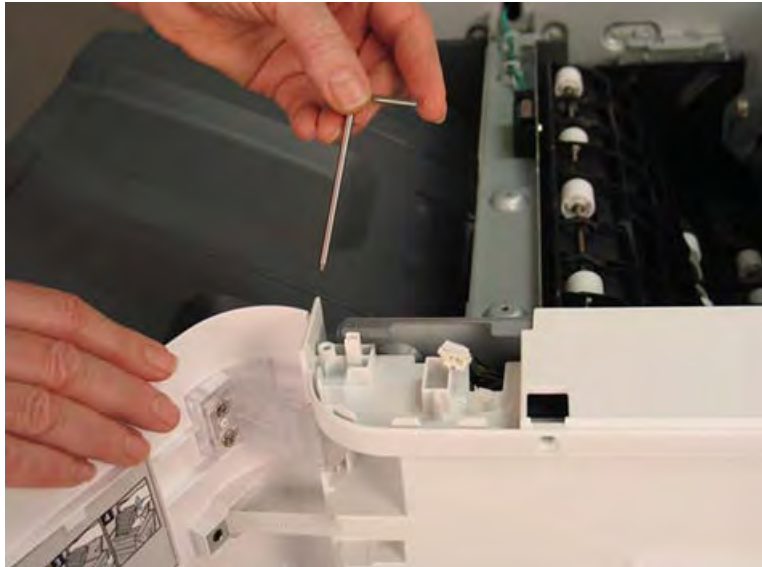
1. Lift the top hinge pin up to release it from the retainer.

Figure 5-671 Lift the top hinge pin



2. Pull the top hinge pin up to remove it.

Figure 5-672 Remove the top hinge pin



3. Use a small, flat-blade screwdriver to release the lower hinge pin from the retainer, and then rotate it away from the finisher.

Figure 5-673 Release the lower hinge pin




4. Support the door with one hand, and then pull the lower hinge pin straight up to remove it.

Figure 5-674 Remove the lower hinge pin

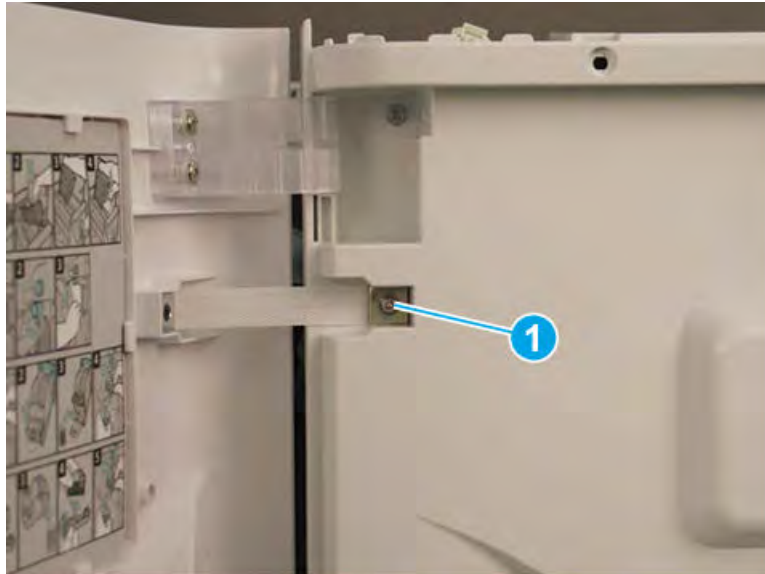




5. Support the door with one hand, and then remove one screw (callout 1) to release the strap. Remove the front door.

 **TIP:** Reverse the removal steps to install the assembly.

**Figure 5-675** Remove the front door

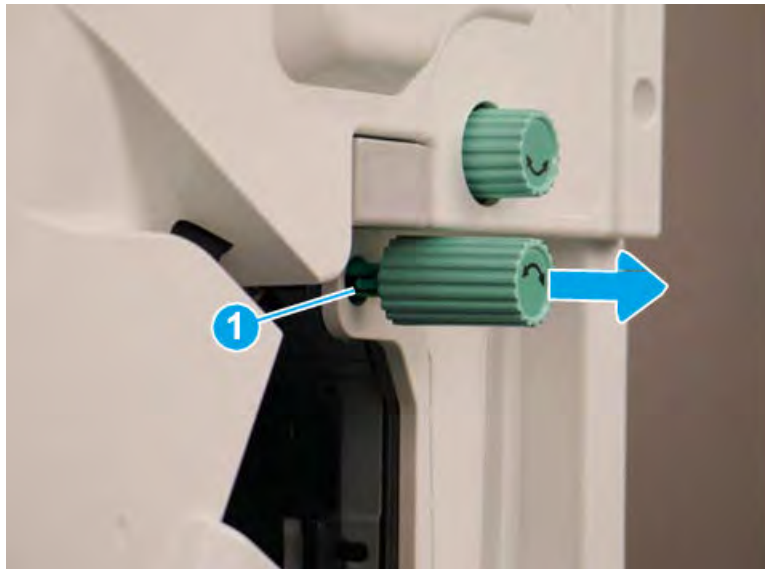


#### Remove the front cover (finisher)

Follow these steps to remove the front cover (finisher).

1. Release one tab (callout 1), and then pull the jam-access knob away from the finisher to remove it.

**Figure 5-676** Remove the jam-access knob



2. If the punch unit is installed, remove the punch waste bin (callout 1).


3. Remove one screw (callout 1) on top of the front cover.

Figure 5-677 Remove one screw



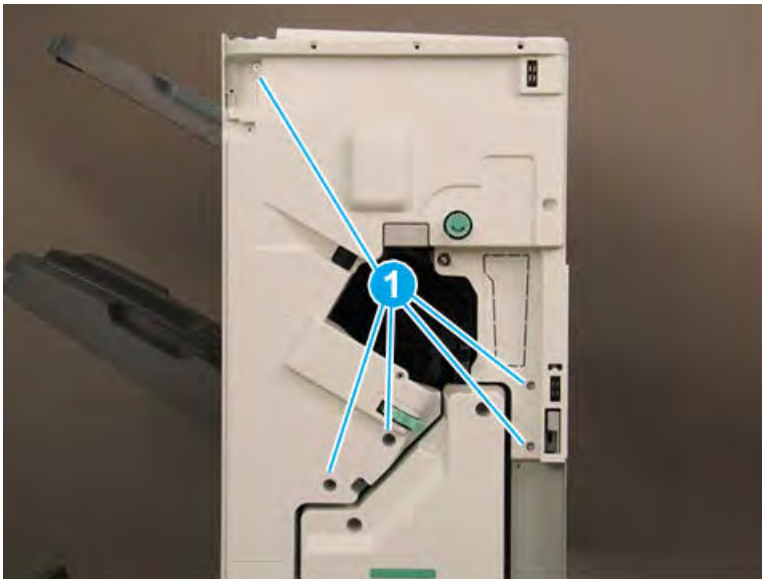
4. Remove five machine screws (callout 1), and then remove the front cover.

---

 **TIP:** Reverse the removal steps to install the assembly.

---

Figure 5-678 Remove the front cover

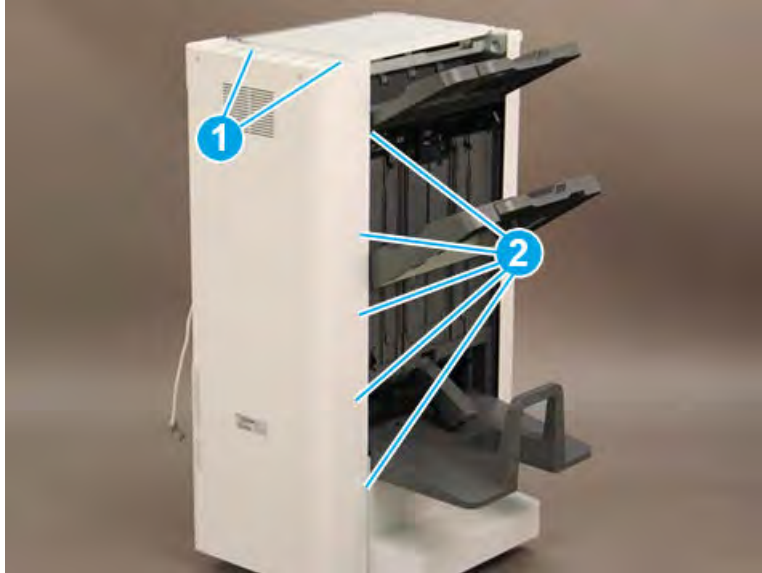


### Remove the rear cover (finisher)

Follow these steps to remove the rear cover (finisher).

1. Remove two self-tapping screws (callout 1) on the top of the rear cover, and then remove five screw caps and five machine screws (callout 2) on the left side of the cover.


Figure 5-679 Remove seven screws



2. Remove one screw cap and four machine screws (callout 1) Remove the rear cover.

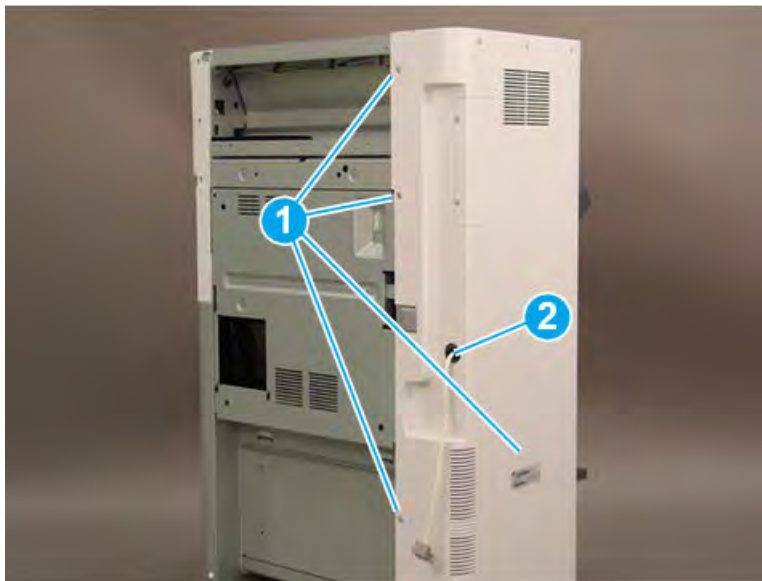
---

 **NOTE:** Make sure to thread the power cable (callout 2) through the opening in the cover.

 **TIP:** Reverse the removal steps to install the assembly

---

Figure 5-680 Remove the rear cover



### Remove the booklet output tray

Follow these steps to remove the booklet output tray.

1. Raise the booklet output tray up (callout 1), and then pull it away from the finisher (callout 2) to remove it.

Figure 5-681 Remove the booklet output tray



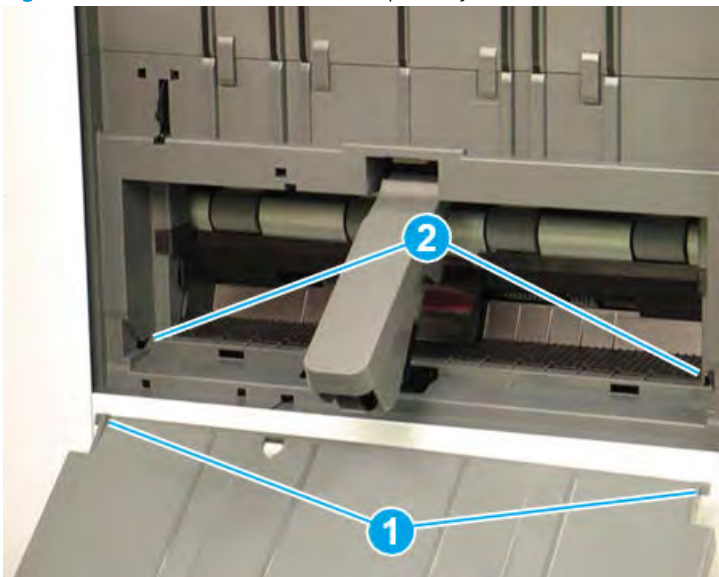
2. Reverse the removal steps to install the assembly. Also use the following special installation instructions.

 **NOTE:** Continue to reverse the removal steps to finish installing the assembly

Special installation instructions: booklet output tray

Position the tabs (callout 1) on the tray into the slots (callout 2) on the finisher.

Figure 5-682 Install the booklet output tray

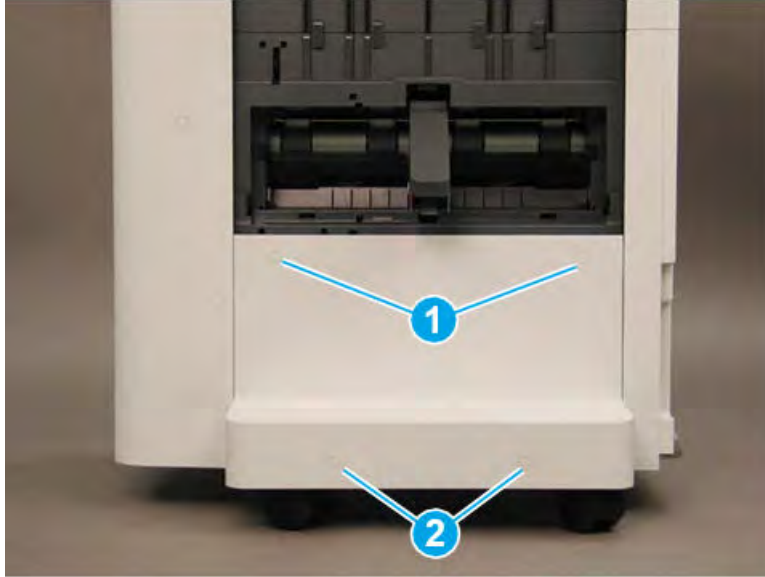


### Remove the caster cover

Follow these steps to remove the caster cover.

1. Remove two screw caps and two self-tapping screws (callout 1). Remove two screw caps and two machine screws (callout 2).

Figure 5-683 Remove four screws



2. Rotate the left edge of the cover away from the finisher (callout 1), and then slide the cover to the left (callout 2) to remove it.

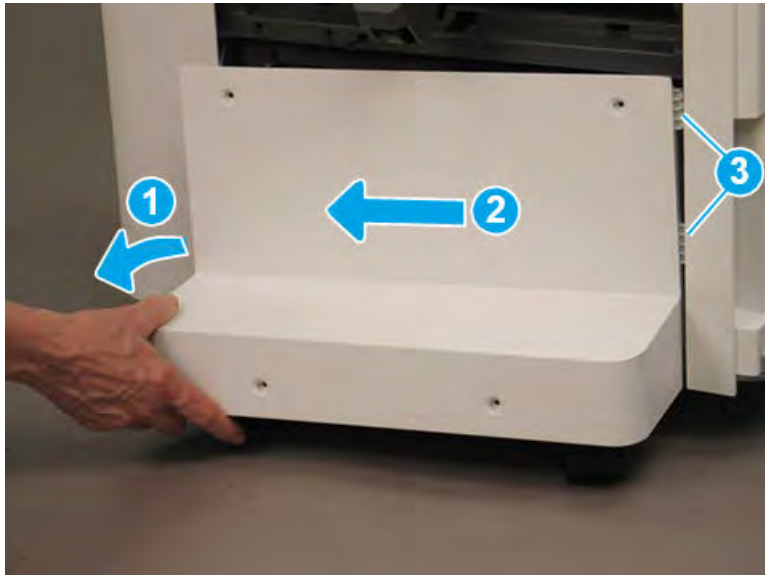
---

 **TIP:** Make sure that two tabs (callout 3) are positioned under the front lower cover when reinstalling the caster cover.

**TIP:** Reverse the removal steps to install the assembly

---

Figure 5-684 Remove the caster cover




### Remove the left lower cover (finisher)

Follow these steps to remove the left lower cover (finisher).

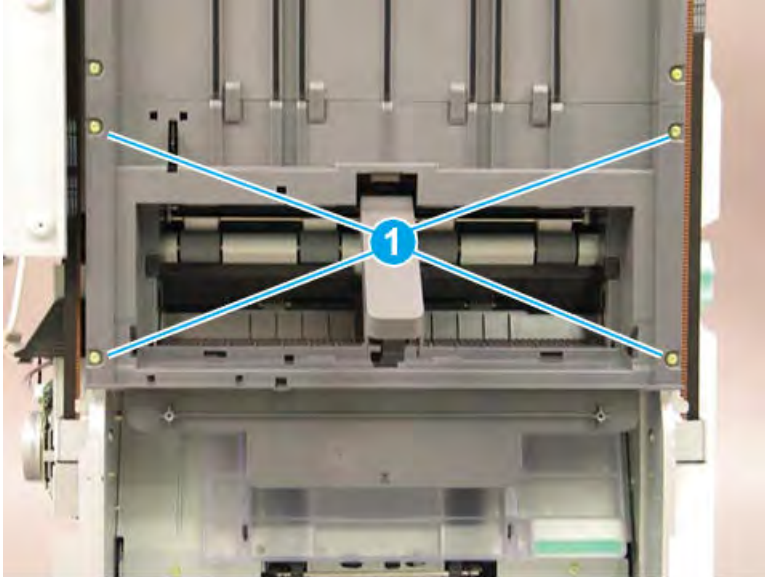
1. Remove four screws (callout 1).

---

 **NOTE:** Raise the lower output tray as needed to access the screws.

---

Figure 5-685 Remove four screws



2. Slide the shield down (callout 1) to release it from four tabs (callout 2), and then rotate it away from the finisher (callout 3).

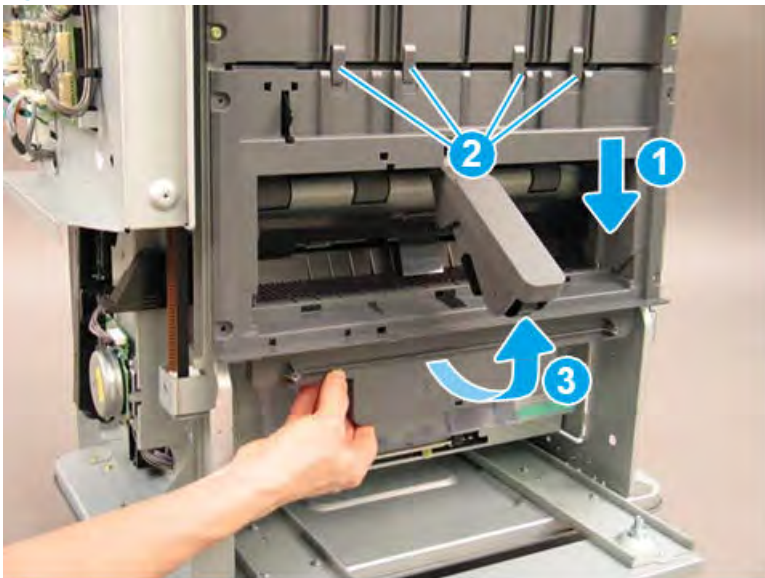
---

**⚠ CAUTION:** The shield is still attached to the finisher. Do not attempt to completely remove the shield.


**💡 TIP:** Position the shield under the four tabs (callout 2) when reinstalling it.

---

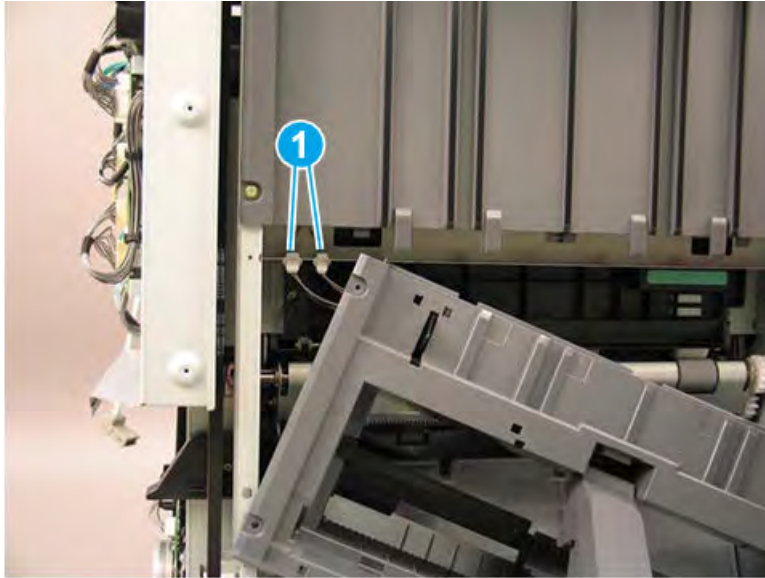
Figure 5-686 Release the lower shield



3. Disconnect two connectors (callout 1), and then remove the shield.

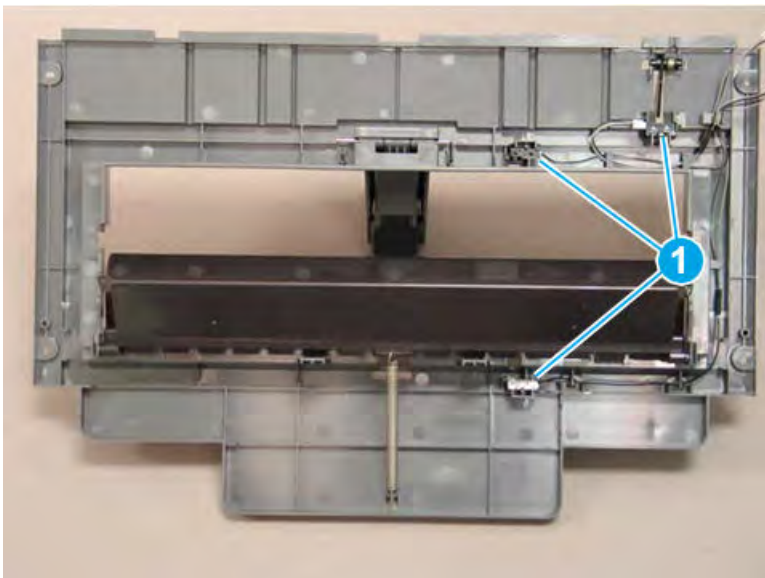
 **TIP:** Reverse the removal steps to install the assembly.

**Figure 5-687** Disconnect two connectors



4. If you are replacing the left lower cover, locate three sensors (callout 1) on the back of the left lower cover. Remove these sensors and transfer them to the replacement part.

**Figure 5-688** Remove the left lower cover

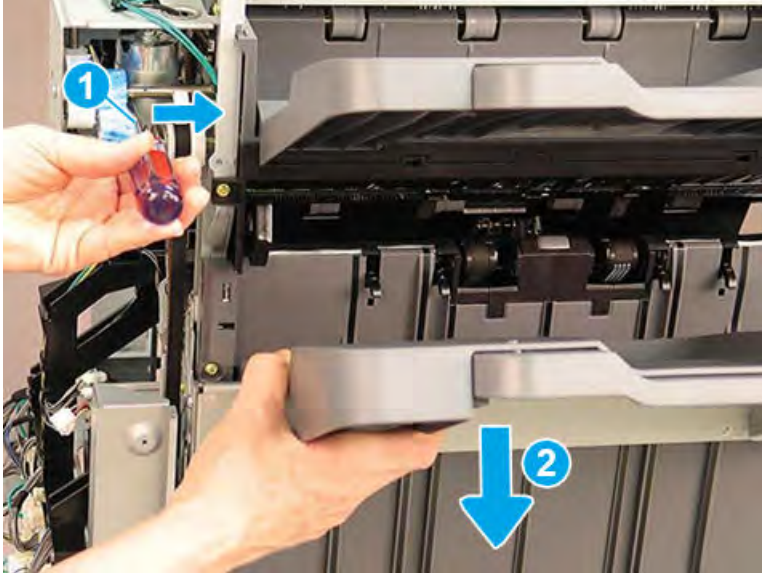


### Remove the left upper cover (finisher)

Follow these steps to remove the left upper cover (finisher).

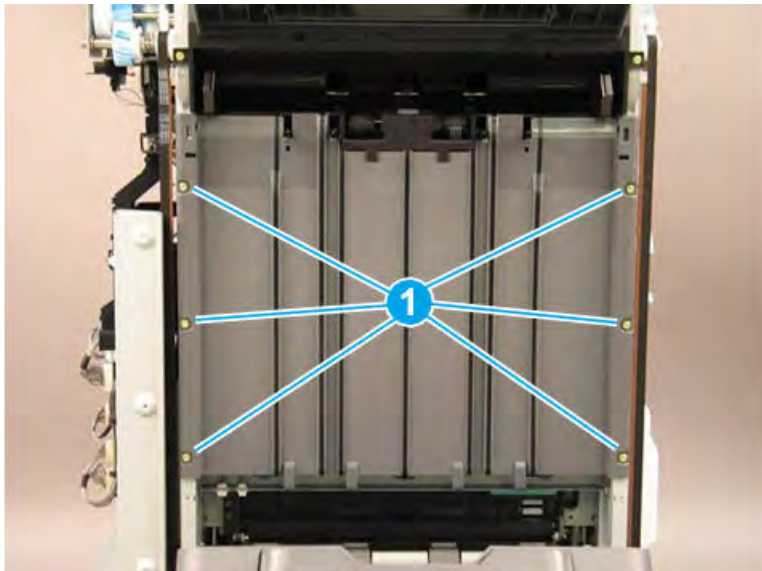
1. Bring the lower output tray down by positioning the shaft of a screwdriver on the clutch (callout 1) and gently pressing to the right to release the clutch. Hold the clutch in the released position and lower the tray (callout 2) to the lowest position.

Figure 5-689 Lower the output tray



2. Remove six machine screws (callout 1).

Figure 5-690 Remove six screws



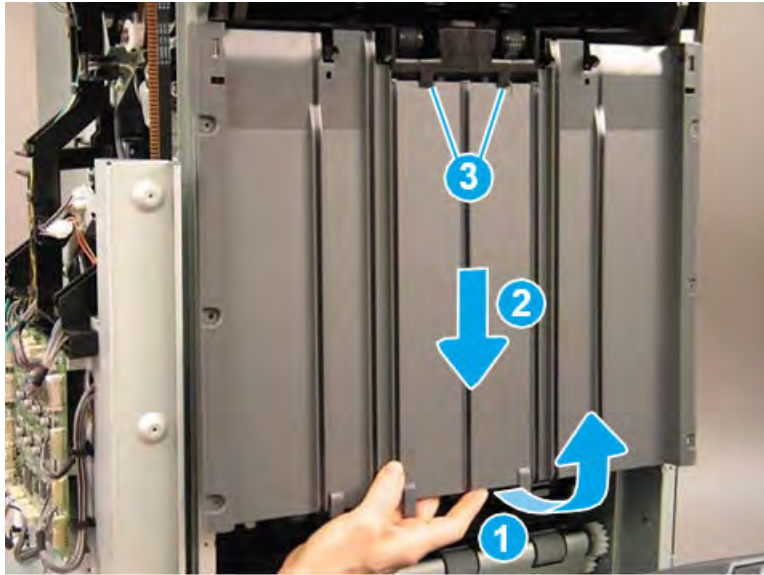


3. Rotate the lower edge of the shield away from the finisher (callout 1), and then slide the shield down (callout 2) to release it from two tabs (callout 3).

**CAUTION:** The shield is still attached to the finisher. Do not attempt to completely remove the shield.

**TIP:** Position the shield under the two tabs (callout 3) when reinstalling it.

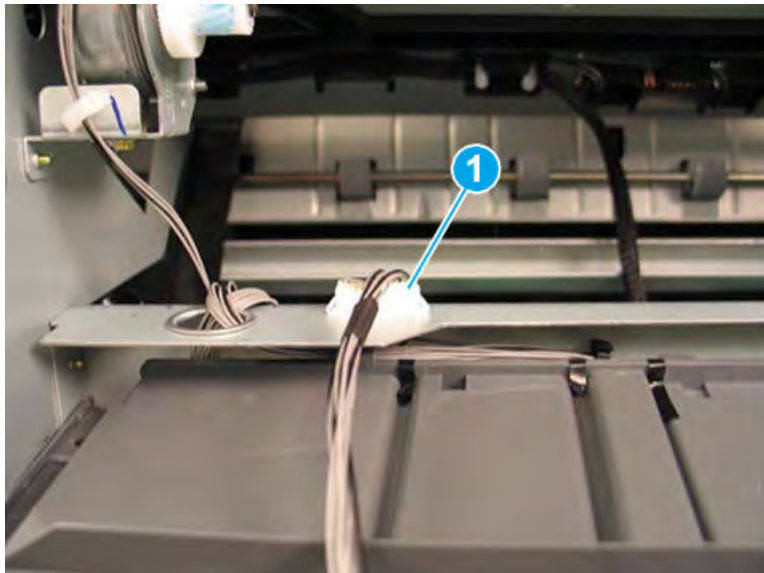
**Figure 5-691** Release the shield



4. Disconnect one connector (callout 1), and then remove the upper shield assembly.

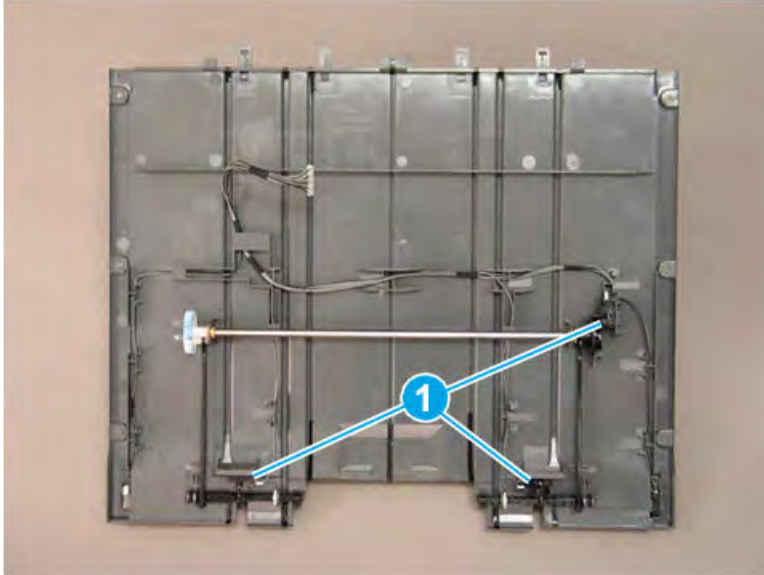
**TIP:** Reverse the removal steps to install the assembly.

**Figure 5-692** Disconnect one connector



5. If you are replacing the left upper cover, locate three sensors (callout 1) on the back of the left upper cover. Remove these sensors and transfer them to the replacement part.

Figure 5-693 Remove the left upper cover

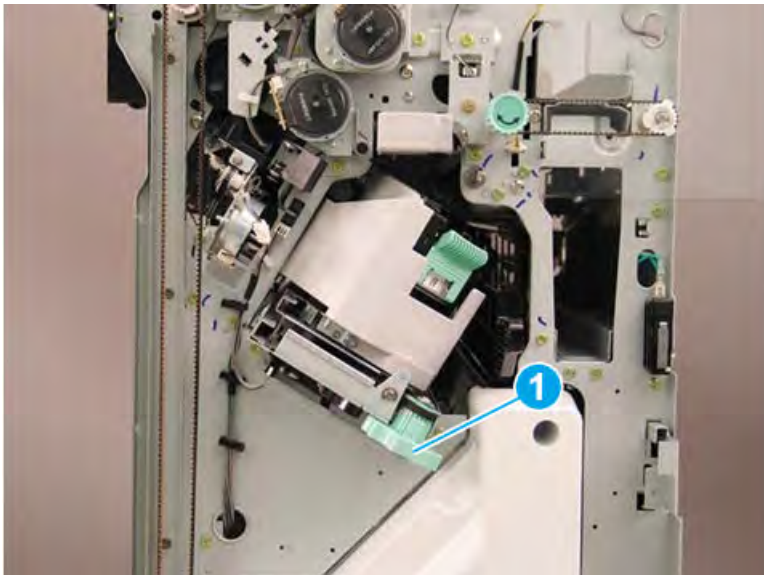


#### Remove the ejector unit (finisher)

Follow these steps to remove the ejector unit (finisher).

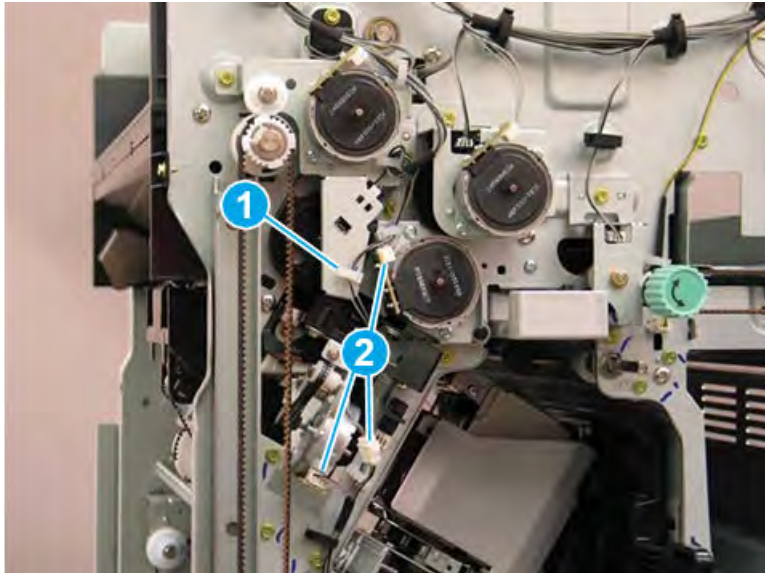
1. Rotate the green wheel to move the staple unit to the center of the finisher.

Figure 5-694 Move the staple unit to the center



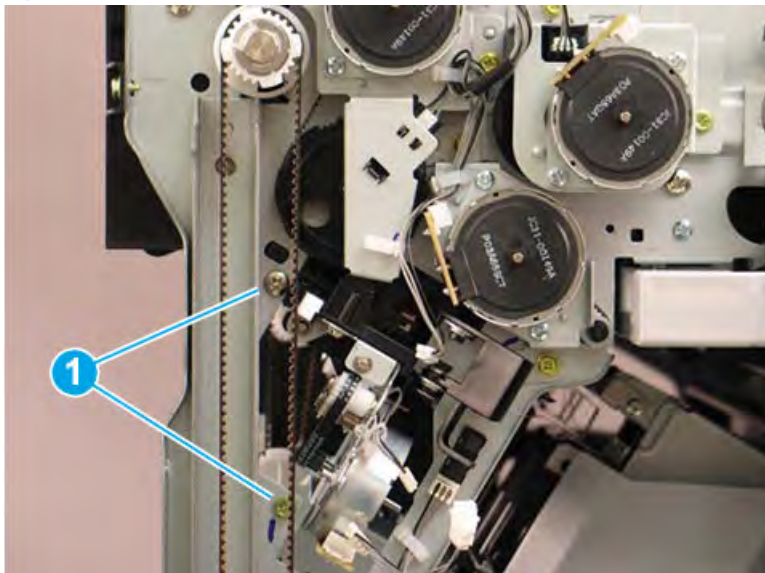
2. Release one retainer (callout 1), and then disconnect three connectors (callout 2).

Figure 5-695 Disconnect three connectors



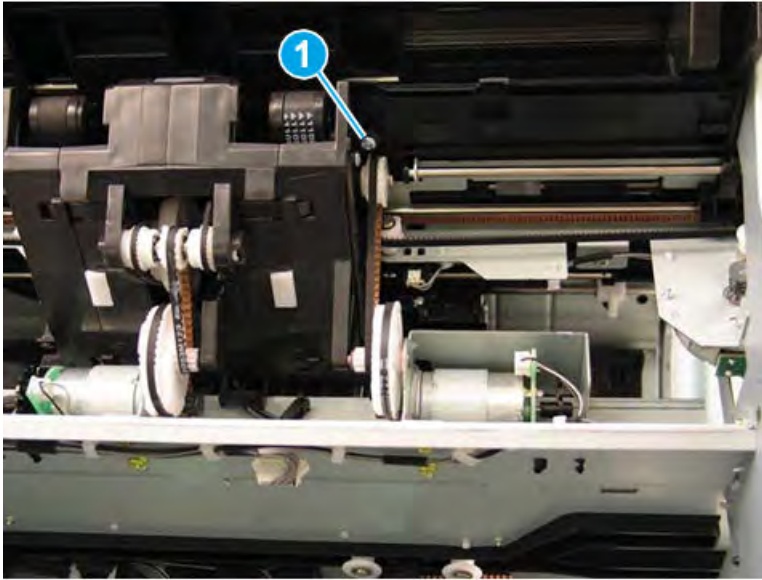
3. Remove two screws (callout 1).

Figure 5-696 Remove two screws



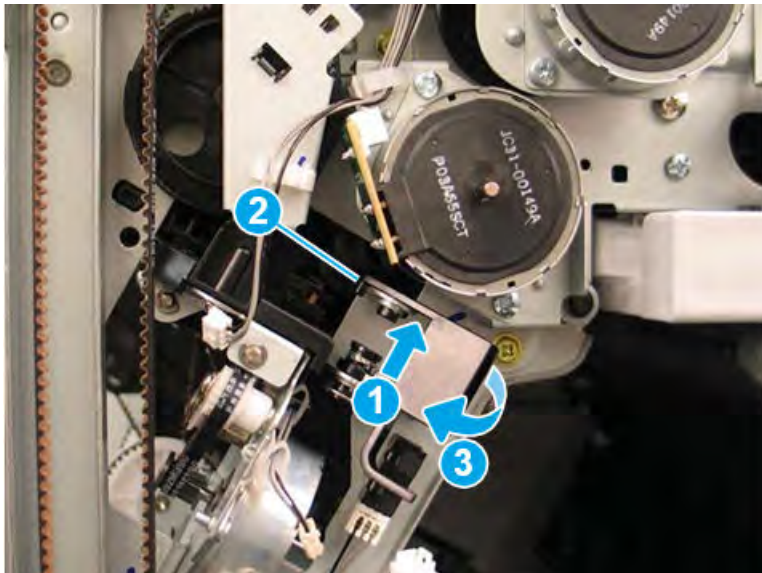
4. At the left side of the finisher, remove one screw (callout 1).

Figure 5-697 Remove one screw



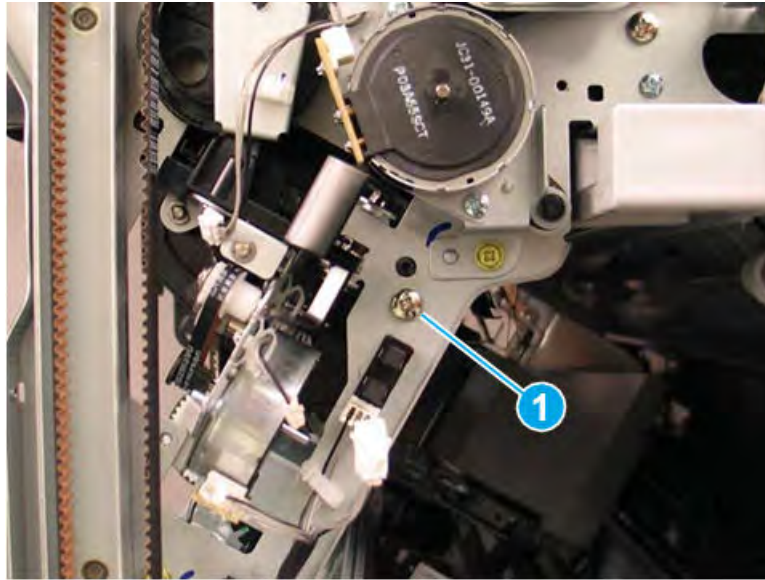
5. Press up on the hinge (callout 1), release one tab (callout 2), and then rotate the sensor away from the finisher (callout 3).

Figure 5-698 Rotate the sensor



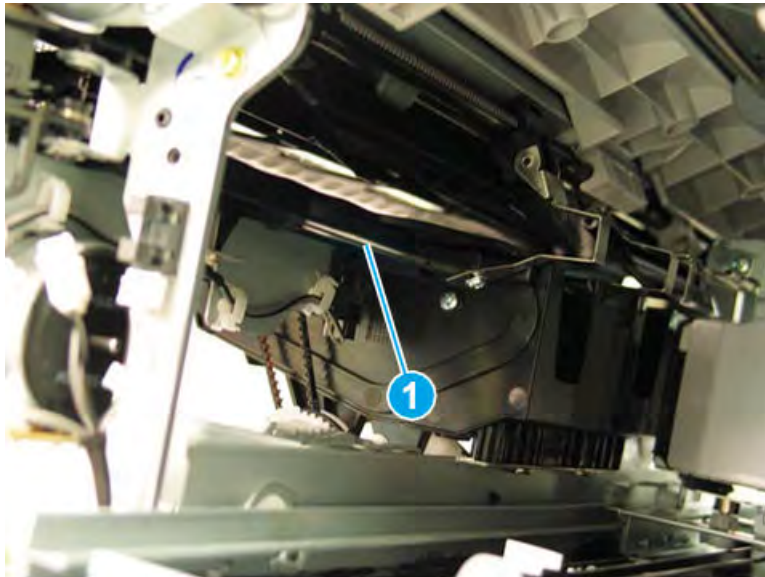
6. Remove one screw (callout 1).

Figure 5-699 Remove one screw



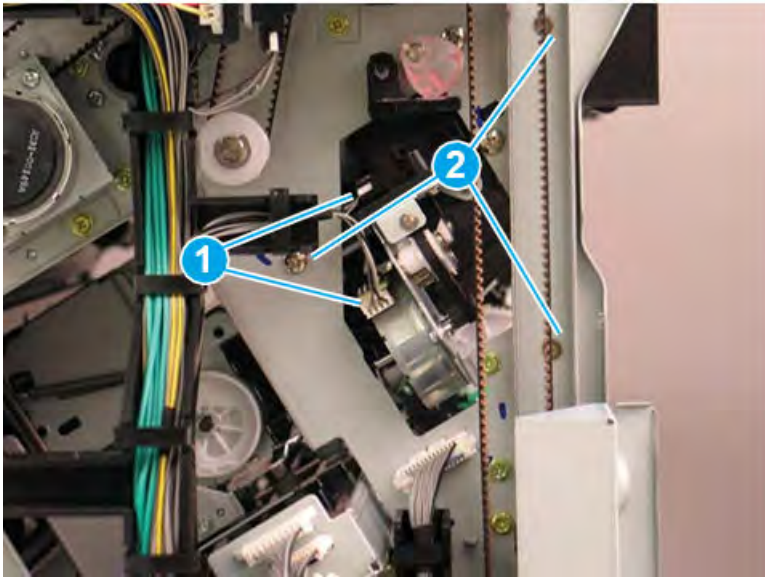
7. Look inside the finisher through the stapler opening in the front and pull down to release and remove one shaft (callout 1) on the front tamper unit.

Figure 5-700 Remove the front tamper shaft



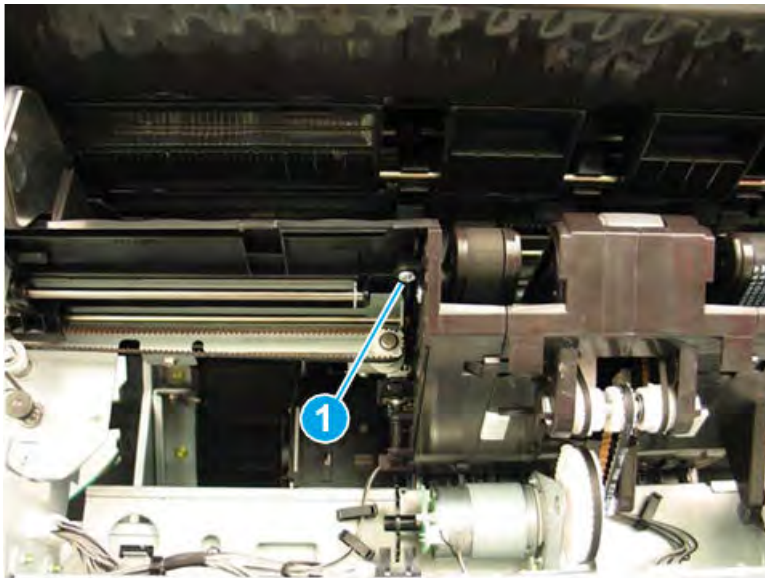
8. At the rear of the finisher, disconnect two connectors (callout 1), and then remove three screws (callout 2).

**Figure 5-701** Disconnect two connectors and remove three screws



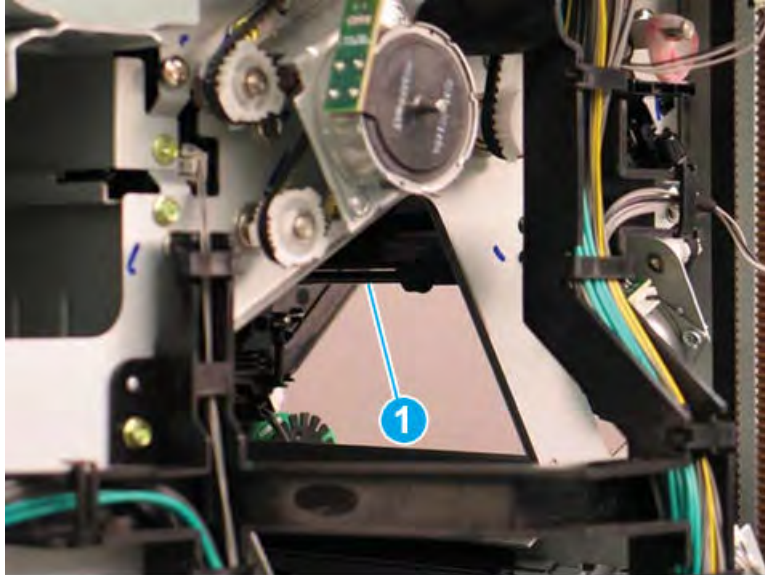
9. At the left side of the finisher, remove one screw (callout 1).

**Figure 5-702** Remove one screw



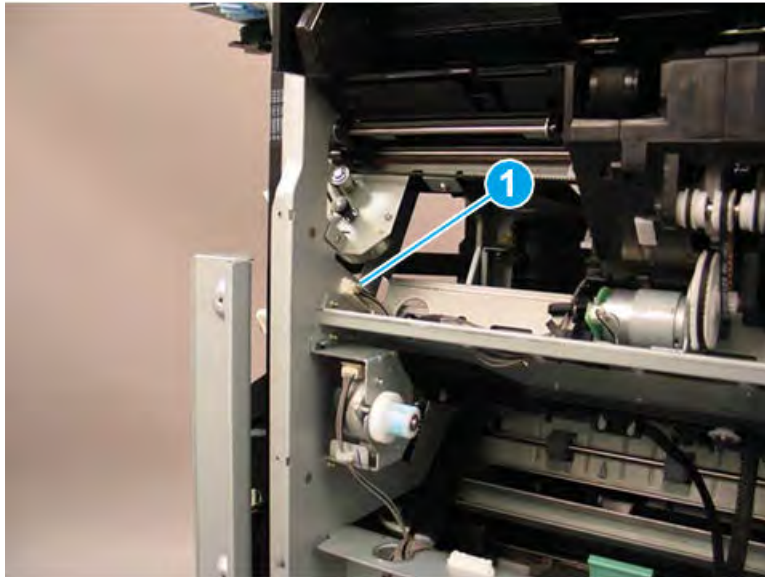
10. Look inside the finisher through the stapler opening in the rear and pull down to release and remove one shaft (callout 1) on the rear tamper unit.

Figure 5-703 Remove the rear tamper shaft



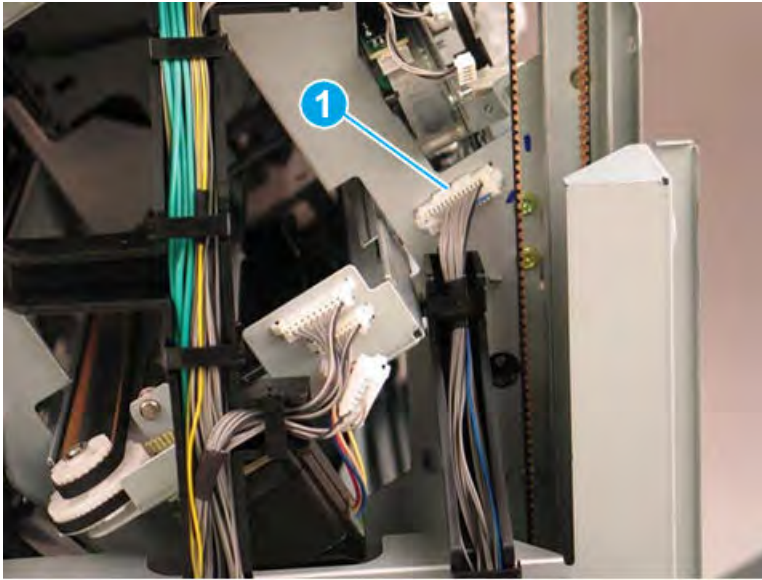
11. At the left side of the finisher, disconnect one connector (callout 1).

Figure 5-704 Disconnect one connector



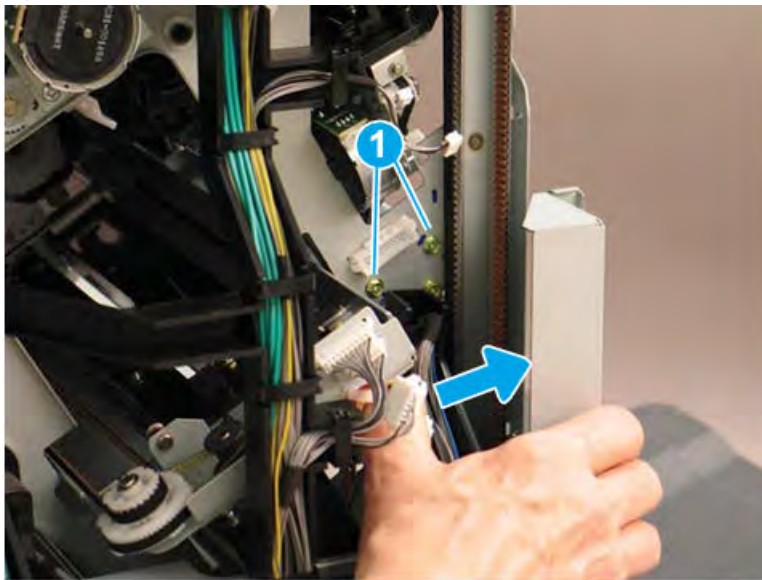
12. At the rear of the finisher, disconnect one connector (callout 1).

Figure 5-705 Disconnect one connector



13. At the rear of the finisher, press the wire retainer to the right to access and remove two screws (callout 1).

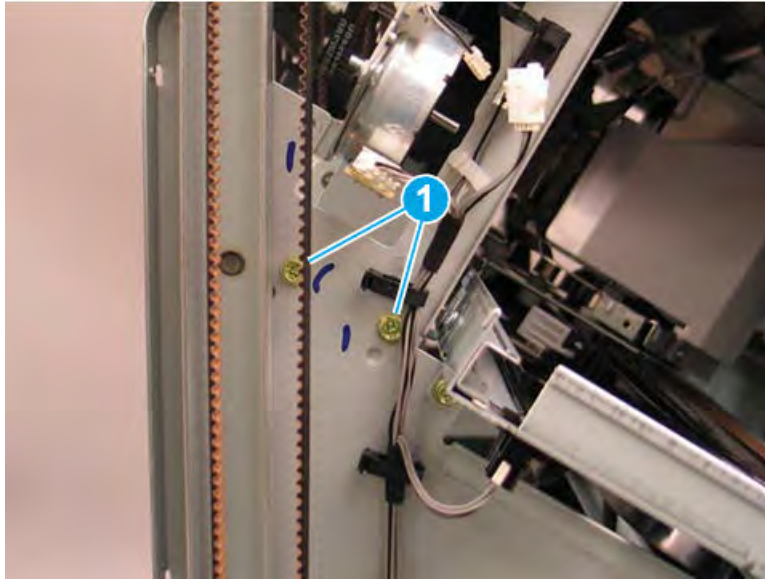
Figure 5-706 Disconnect one connector





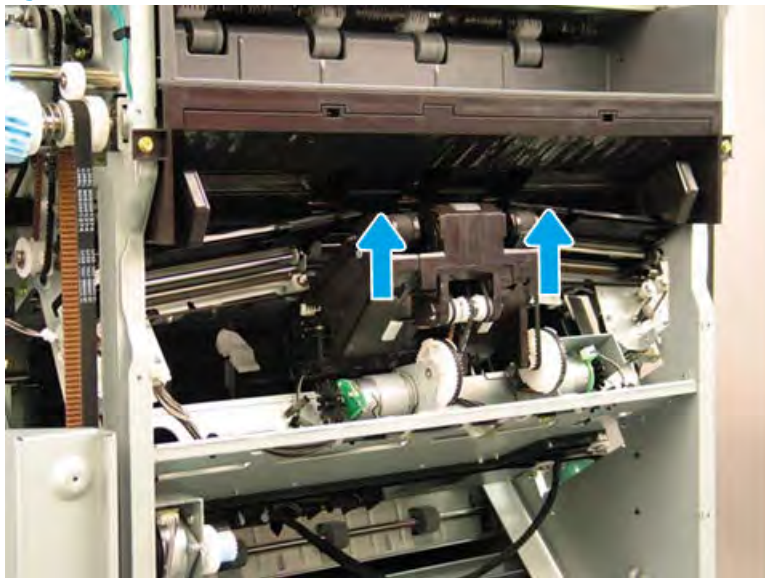
14. At the front of the finisher, remove two screws (callout 1).

Figure 5-707 Remove two screws



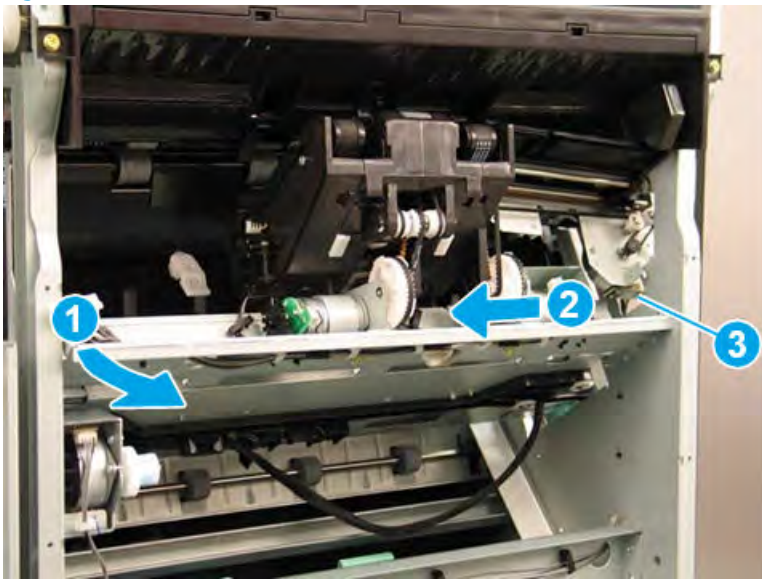
15. Lift the inside edges of the front and rear tampers up.

Figure 5-708 Lift the edges of the tampers



16. Rotate the rear edge of the ejector unit away from the finisher (callout 1), and then slide it toward the rear of the finisher (callout 2) to remove it. Make sure that the PCA (callout 3) stays clear of the sheet metal frame.

Figure 5-709 Remove the ejector unit



17. Reverse the removal steps to install the assembly. Also use the following special installation instructions.

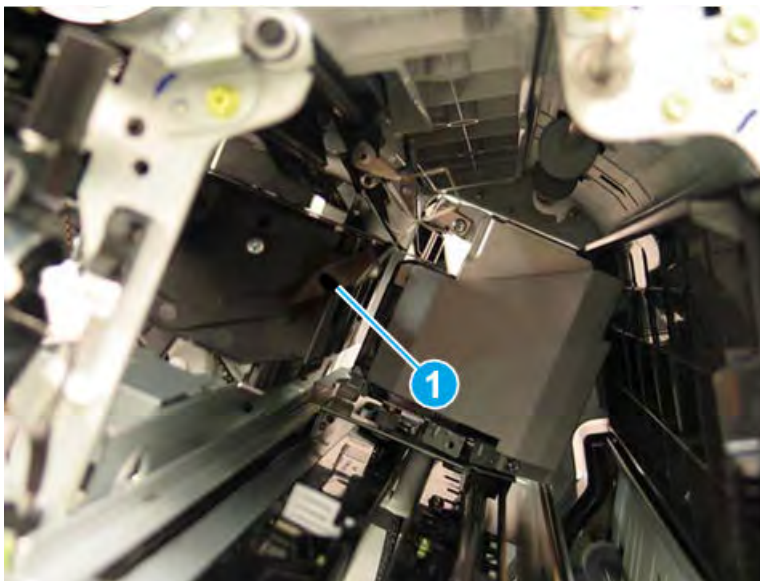
---

 **NOTE:** Continue to reverse the removal steps to finish installing the assembly.

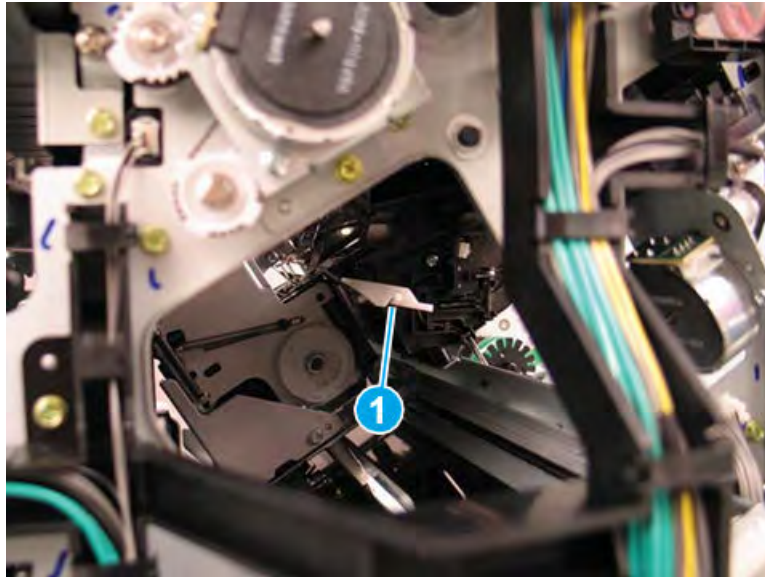
---

**Special installation instructions: Ejector unit**

- a. When the front tamper shaft is removed, the retainer arm that held the one end of the shaft will drop down. When reinstalling the shaft, raise the retainer arm and position the end of the shaft in the notch (callout 1).



- b. When the rear tamper shaft is removed, the retainer arm that held the one end of the shaft will drop down. When reinstalling the shaft, raise the retainer arm and position the end of the shaft in the notch (callout 1).



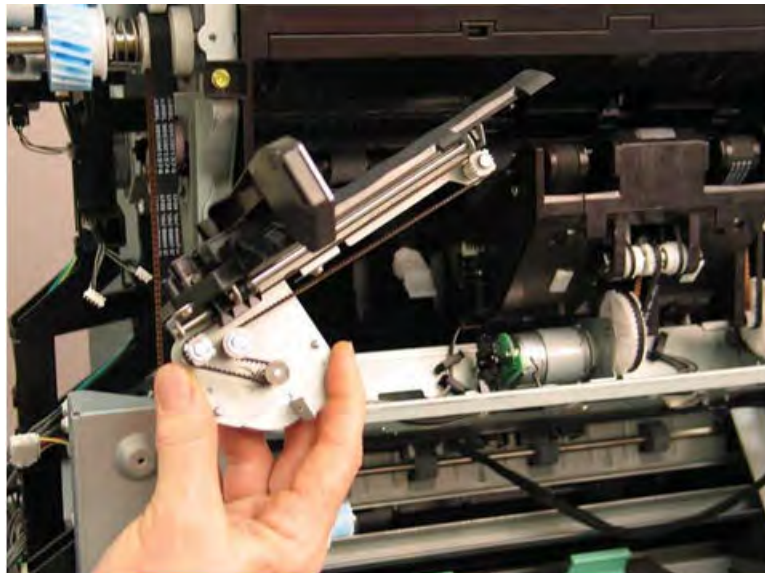
### Remove the rear tamper unit

Follow these steps to remove the rear tamper unit.

- ▲ Lift the rear tamper away from the finisher to remove it

 **NOTE:** Reverse the removal steps to install the assembly.

**Figure 5-710** Remove the rear tamper




### Unpack the replacement assembly

Follow these steps to unpack the replacement assembly.

1. Dispose of the defective part.



---


 **NOTE:** HP recommends responsible disposal of the defective part.


<http://www8.hp.com/us/en/hp-information/environment/product-recycling.html>

---

2. Unpack the replacement part from the packaging.


 **CAUTION:**  Some parts are sensitive to electrostatic discharge (ESD). Always perform service work at an ESD-protected workstation or mat. If an ESD workstation or mat is not available, touch the sheet-metal chassis to provide a static ground before touching an ESD-sensitive assembly. Protect the ESD-sensitive assemblies by placing them in ESD pouches when they are out of the printer.

 **IMPORTANT:** Make sure that all of the shipping materials (for example shipping tape) are removed from the replacement part prior to installation.

 **NOTE:** If the replacement part is a roller or pad, avoid touching the spongy part of it. Skin oils on the roller or pad can cause paper pickup and/or print-quality problems. HP recommends using disposable gloves when handling rollers or pads or washing your hands before touching rollers or pads.

---

3. To install an assembly, reverse the removal steps.

 **NOTE:** When applicable, special installation instructions are provided for an assembly at the end of the removal procedure. Always completely read the removal instructions and follow all special installation instructions.


---

## Removal and replacement: Rear tamper home sensor (S9)

Learn how to remove and replace the rear tamper home sensor.

### Introduction

This document provides the procedures to remove and replace the rear tamper home sensor on the finisher.

 **IMPORTANT:** When applicable, special installation instructions are provided for an assembly at the end of the removal procedure. Always completely read the removal instructions and follow all special installation instructions.

### Before performing service

- Turn the printer power off. A shutting-down message appears on the control-panel display.
- ⚠ **WARNING!** To avoid damage to the printer, turn the power off and wait until the printer shuts down before removing the power cable.
- Disconnect the printer power cable after the printer has completely shut down (the control-panel display is blank).
- Release the finisher from the printer by pulling out on the release latch inside the finisher door.
- Disconnect the cable from the bridge unit to the finisher.
- Disconnect the cable from the finisher to the printer.

Use the table below to identify the correct part number for your printer. To order the part, go to <https://parts.hp.com>.

**Table 5-117** Part information

Part number	Part description
0604-001393	Rear tamper home sensor

### Required tools

- #2 JIS screwdriver with a magnetic tip
- Small, flat-blade screwdriver

### After performing service

- Connect the cable from the finisher to the printer.
- Connect the cable from the bridge unit to the finisher.
- Attach the finisher to the printer, and then push in on the release latch inside the finisher door.
- Connect the printer power cable.
- Turn the printer power on.

### Post service test

Process a job through the finisher and verify that the finisher works correctly.

## Remove the right upper cover (finisher)

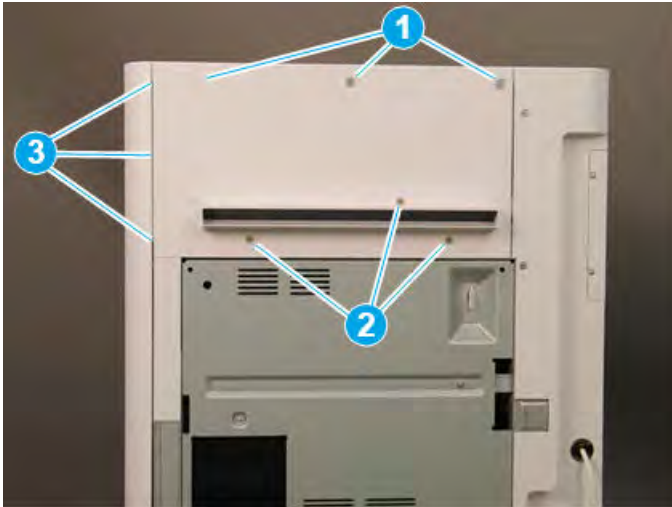
Follow these steps to remove the right upper cover (finisher).

- ▲ Remove one screw cap and three machine screws on the upper edge of the cover (callout 1). Remove three sheet metal screws (callout 2) on the lower portion of the cover. Rotate the right edge of the cover away from the finisher, and then slide the cover right to release three tabs (callout 3).

💡 **TIP:** The lower screws are shorter in length than the upper screws.

**TIP:** Reverse the removal steps to install the assembly.

**Figure 5-711** Remove the right upper cover

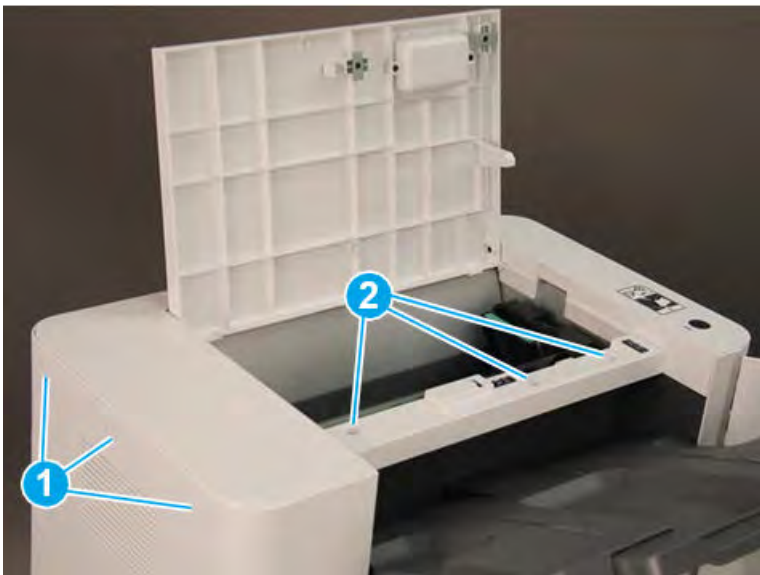


## Remove the top cover (finisher)

Follow these steps to remove the top cover (finisher).

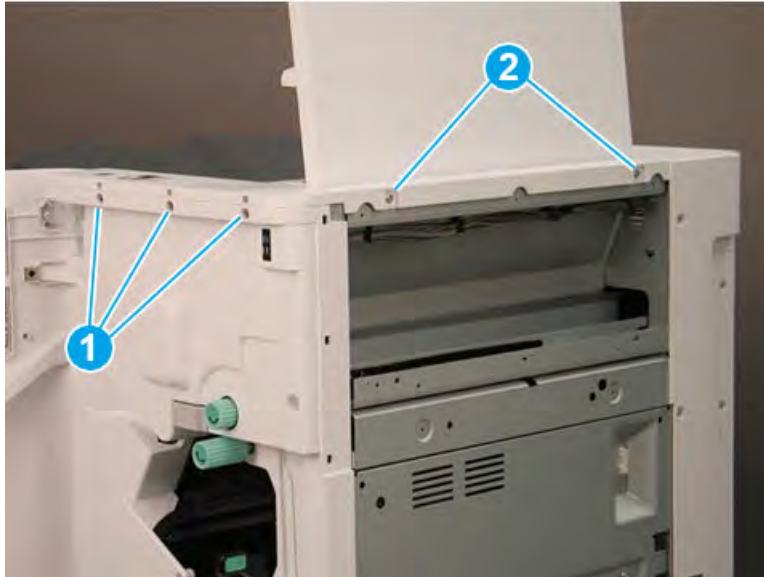
1. Remove three screw caps and three self-tapping screws at the top of the rear cover (callout 1), and then remove three machine screws (callout 2) on top of the cover.

**Figure 5-712** Remove six screws




2. Remove three self-tapping screws at the top of the front cover (callout 1), and then remove two machine screws (callout 2) at the top of the right side.

Figure 5-713 Remove five screws



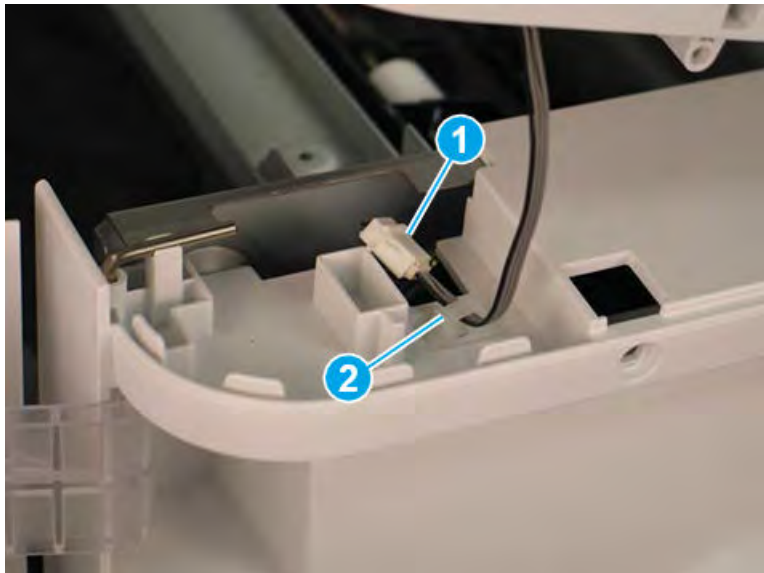
3. Lift the cover up slightly. Disconnect one in-line connector (callout 1), and then release one retainer (callout 2).

---

 **TIP:** Reverse the removal steps to install the assembly.

---

Figure 5-714 Disconnect one connector and release retainer

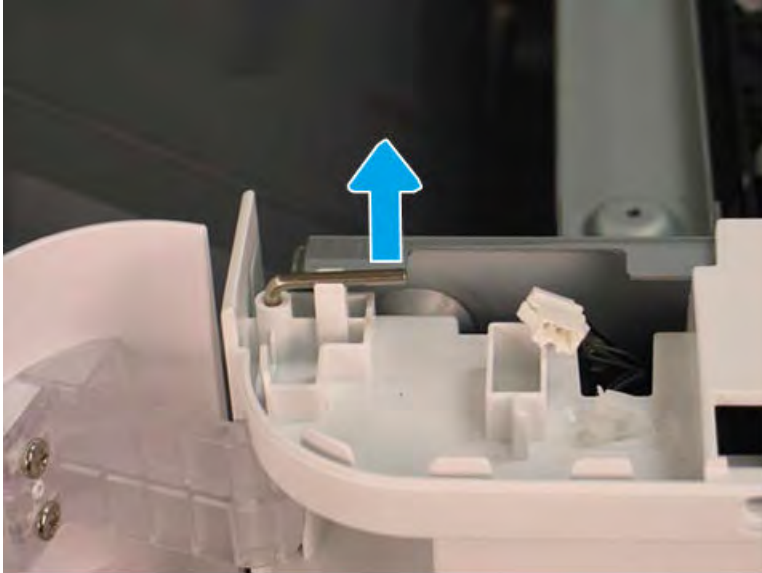


### Remove the front door (finisher)

Follow these steps to remove the front door (finisher).

1. Lift the top hinge pin up to release it from the retainer.

Figure 5-715 Lift the top hinge pin



2. Pull the top hinge pin up to remove it.

Figure 5-716 Remove the top hinge pin





3. Use a small, flat-blade screwdriver to release the lower hinge pin from the retainer, and then rotate it away from the finisher.

Figure 5-717 Release the lower hinge pin




4. Support the door with one hand, and then pull the lower hinge pin straight up to remove it.

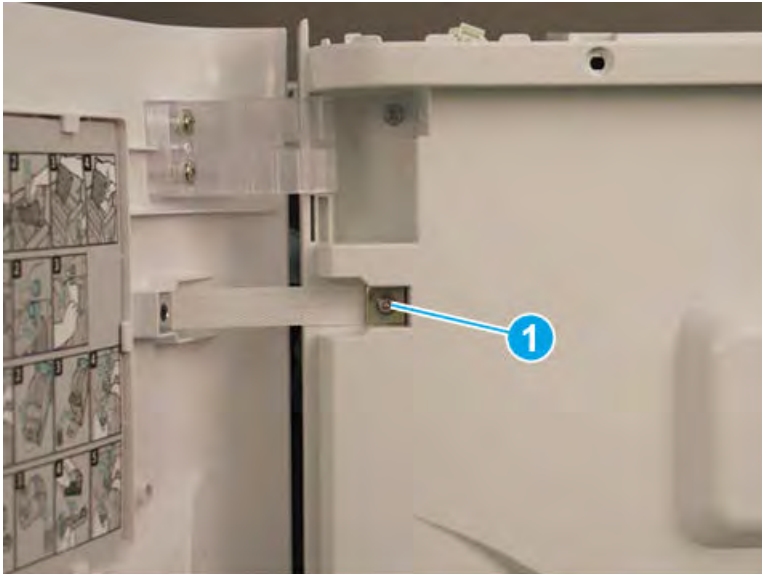
Figure 5-718 Remove the lower hinge pin



5. Support the door with one hand, and then remove one screw (callout 1) to release the strap. Remove the front door.

 **TIP:** Reverse the removal steps to install the assembly.

**Figure 5-719** Remove the front door

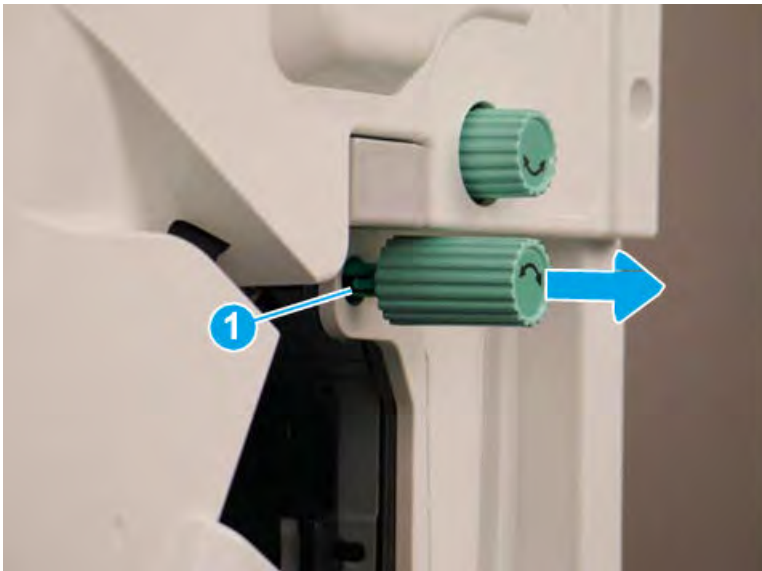


#### Remove the front cover (finisher)

Follow these steps to remove the front cover (finisher).

1. Release one tab (callout 1), and then pull the jam-access knob away from the finisher to remove it.

**Figure 5-720** Remove the jam-access knob



2. If the punch unit is installed, remove the punch waste bin (callout 1).


3. Remove one screw (callout 1) on top of the front cover.

Figure 5-721 Remove one screw



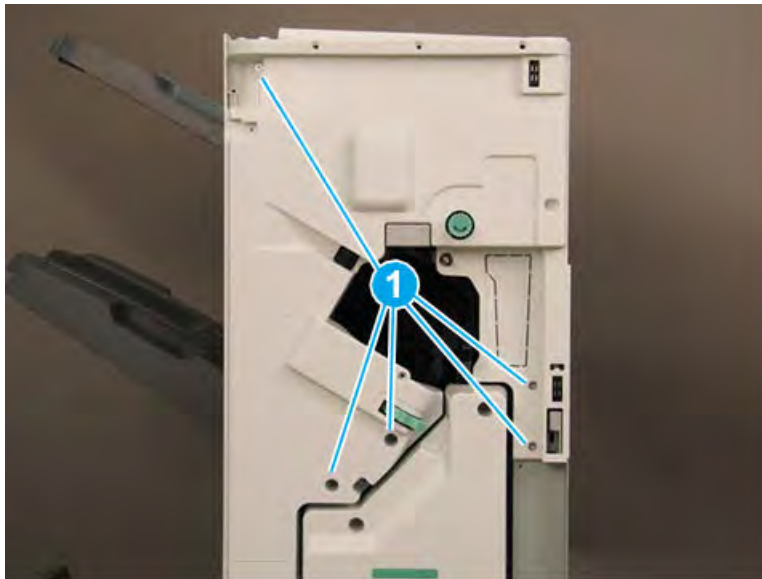
4. Remove five machine screws (callout 1), and then remove the front cover.

---

 **TIP:** Reverse the removal steps to install the assembly.

---

Figure 5-722 Remove the front cover

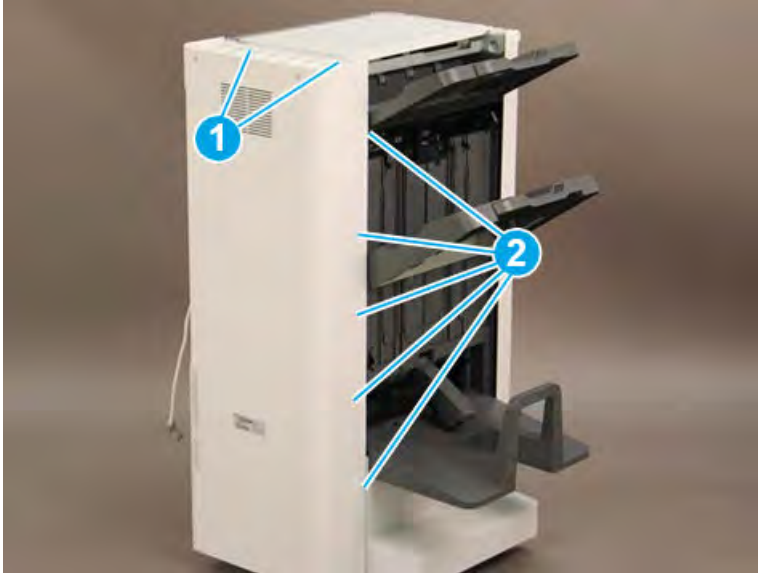


### Remove the rear cover (finisher)

Follow these steps to remove the rear cover (finisher).

1. Remove two self-tapping screws (callout 1) on the top of the rear cover, and then remove five screw caps and five machine screws (callout 2) on the left side of the cover.

Figure 5-723 Remove seven screws

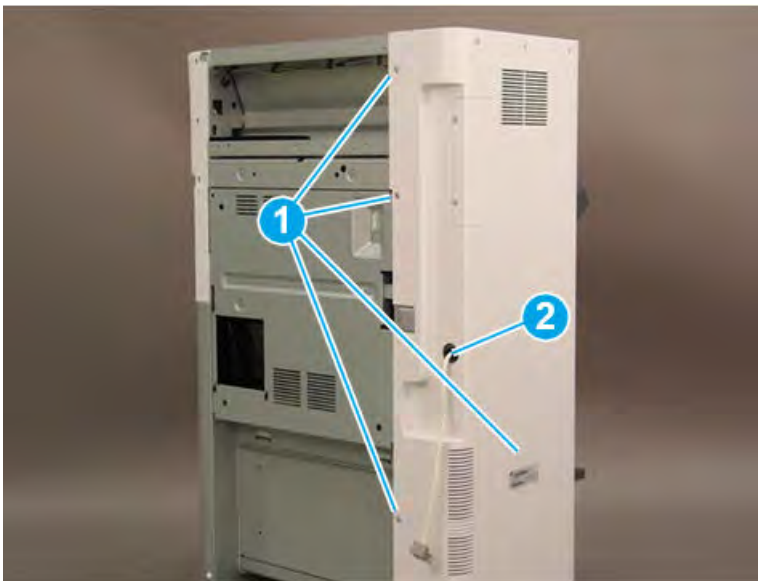


2. Remove one screw cap and four machine screws (callout 1) Remove the rear cover.

 **NOTE:** Make sure to thread the power cable (callout 2) through the opening in the cover.

 **TIP:** Reverse the removal steps to install the assembly

Figure 5-724 Remove the rear cover



### Remove the booklet output tray

Follow these steps to remove the booklet output tray.

1. Raise the booklet output tray up (callout 1), and then pull it away from the finisher (callout 2) to remove it.

Figure 5-725 Remove the booklet output tray



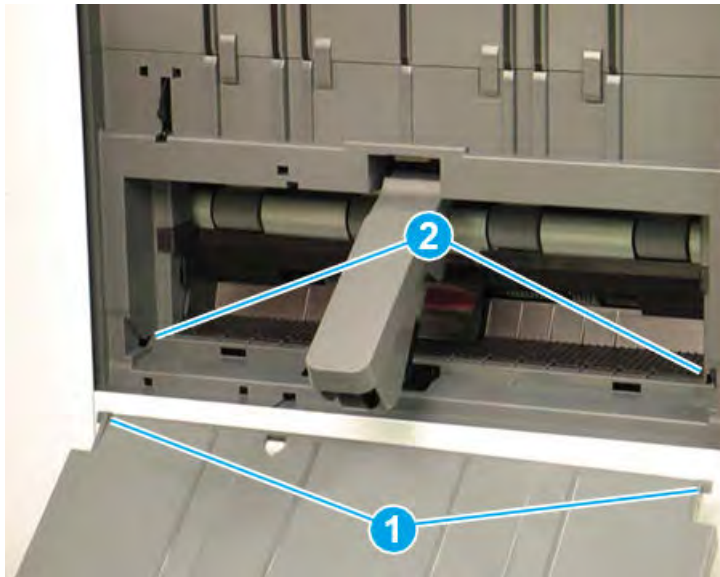
2. Reverse the removal steps to install the assembly. Also use the following special installation instructions.

 **NOTE:** Continue to reverse the removal steps to finish installing the assembly

Special installation instructions: booklet output tray

Position the tabs (callout 1) on the tray into the slots (callout 2) on the finisher.

Figure 5-726 Install the booklet output tray

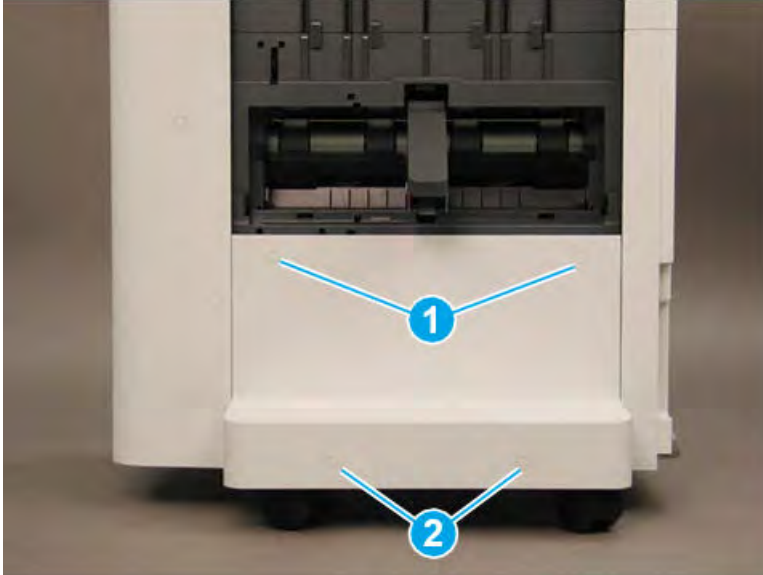


### Remove the caster cover

Follow these steps to remove the caster cover.


1. Remove two screw caps and two self-tapping screws (callout 1). Remove two screw caps and two machine screws (callout 2).

Figure 5-727 Remove four screws



2. Rotate the left edge of the cover away from the finisher (callout 1), and then slide the cover to the left (callout 2) to remove it.

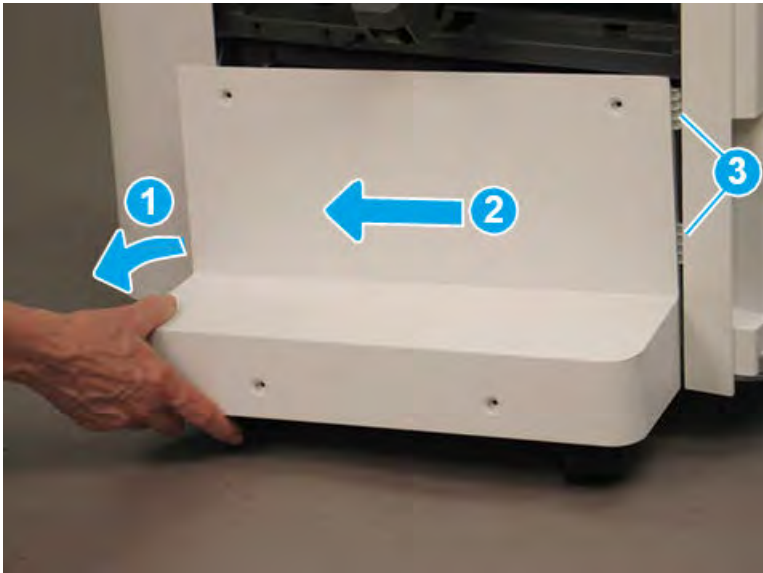
---

 **TIP:** Make sure that two tabs (callout 3) are positioned under the front lower cover when reinstalling the caster cover.

**TIP:** Reverse the removal steps to install the assembly

---

Figure 5-728 Remove the caster cover




### Remove the left lower cover (finisher)

Follow these steps to remove the left lower cover (finisher).

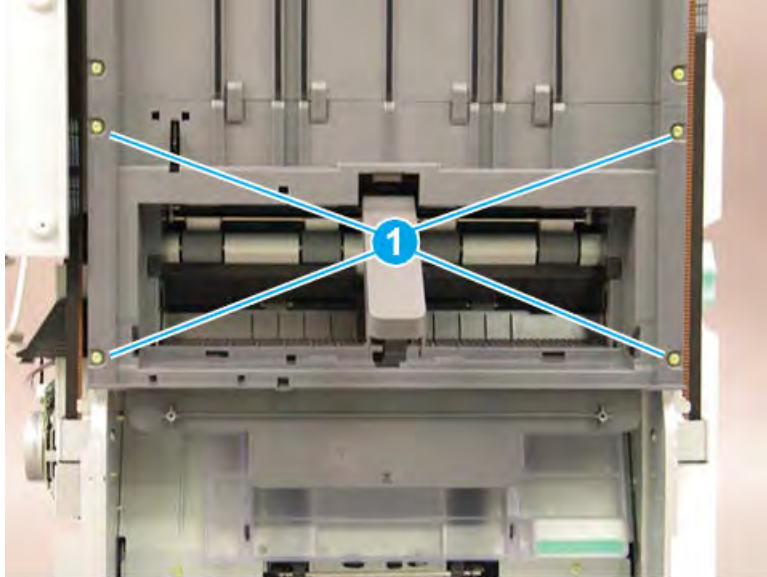
1. Remove four screws (callout 1).

---

 **NOTE:** Raise the lower output tray as needed to access the screws.

---

Figure 5-729 Remove four screws

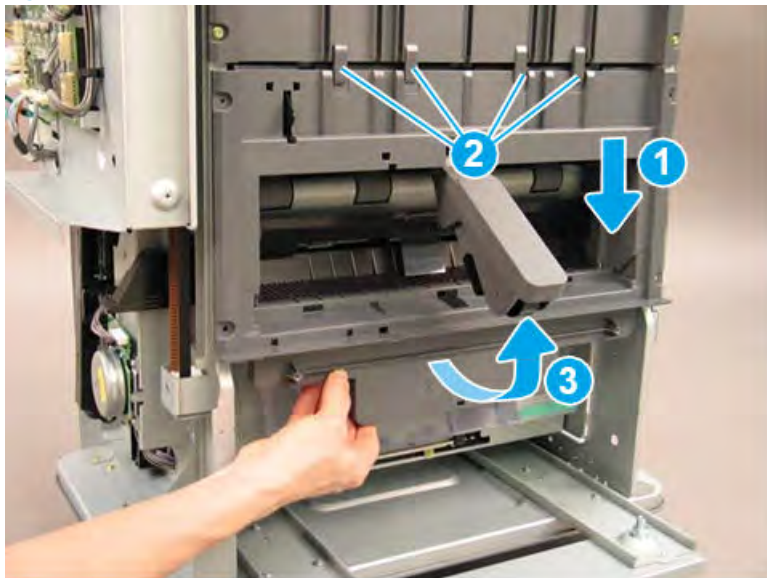


2. Slide the shield down (callout 1) to release it from four tabs (callout 2), and then rotate it away from the finisher (callout 3).


**⚠ CAUTION:** The shield is still attached to the finisher. Do not attempt to completely remove the shield.

**💡 TIP:** Position the shield under the four tabs (callout 2) when reinstalling it.

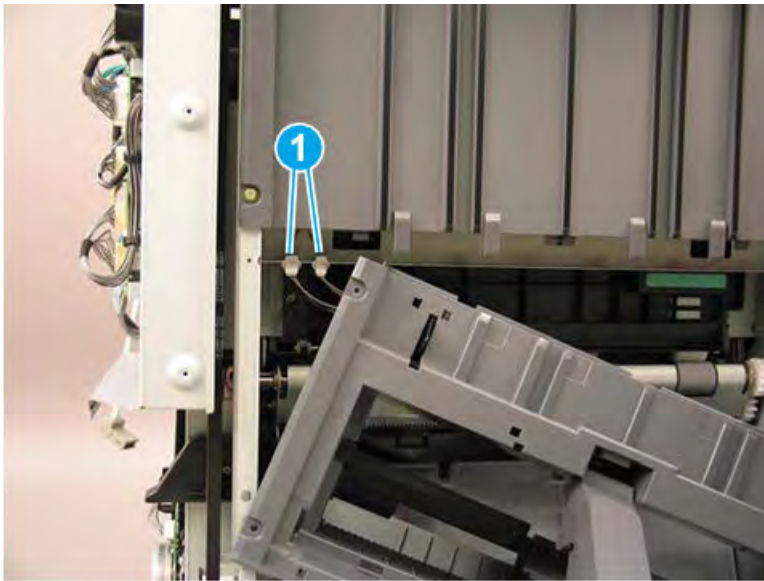
Figure 5-730 Release the lower shield



3. Disconnect two connectors (callout 1), and then remove the shield.

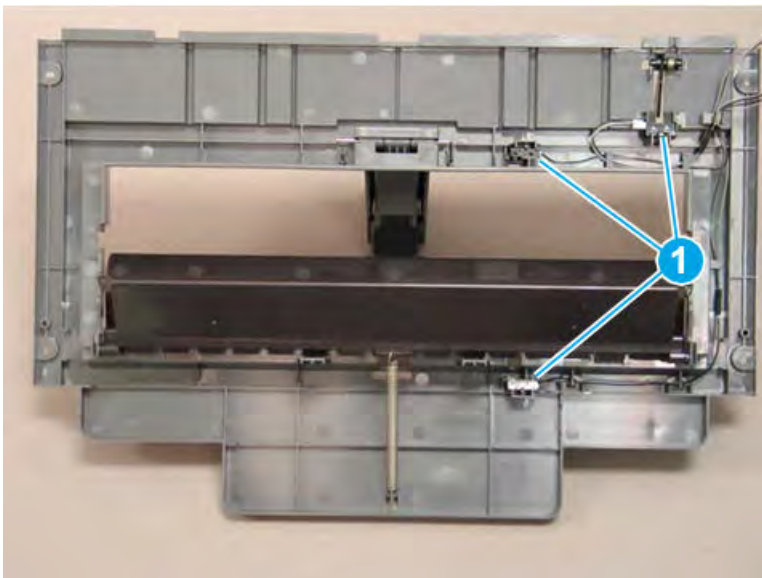
 **TIP:** Reverse the removal steps to install the assembly.

**Figure 5-731** Disconnect two connectors



4. If you are replacing the left lower cover, locate three sensors (callout 1) on the back of the left lower cover. Remove these sensors and transfer them to the replacement part.

**Figure 5-732** Remove the left lower cover



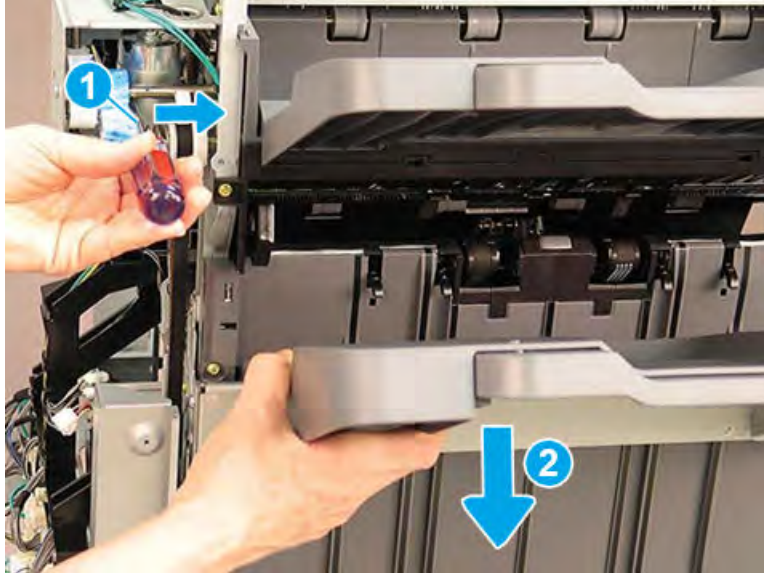
### Remove the left upper cover (finisher)

Follow these steps to remove the left upper cover (finisher).

1. Bring the lower output tray down by positioning the shaft of a screwdriver on the clutch (callout 1) and gently pressing to the right to release the clutch. Hold the clutch in the released position and lower the tray (callout 2) to the lowest position.

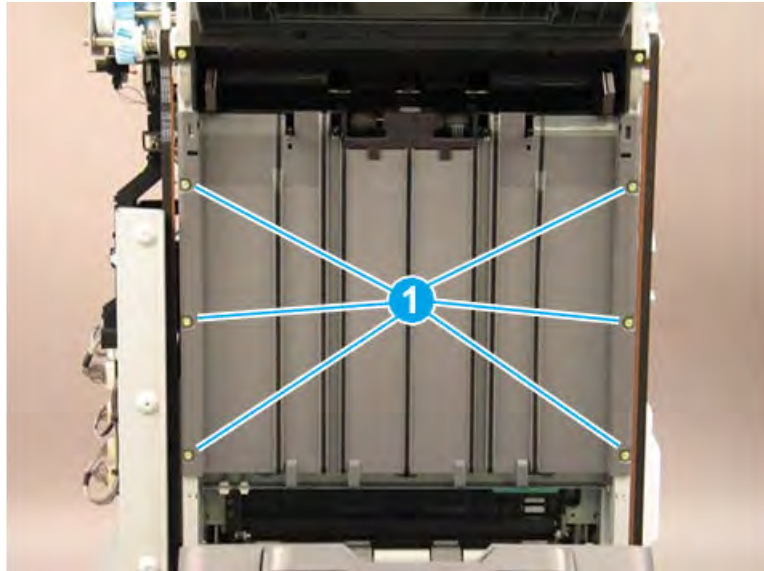


Figure 5-733 Lower the output tray



2. Remove six machine screws (callout 1).

Figure 5-734 Remove six screws

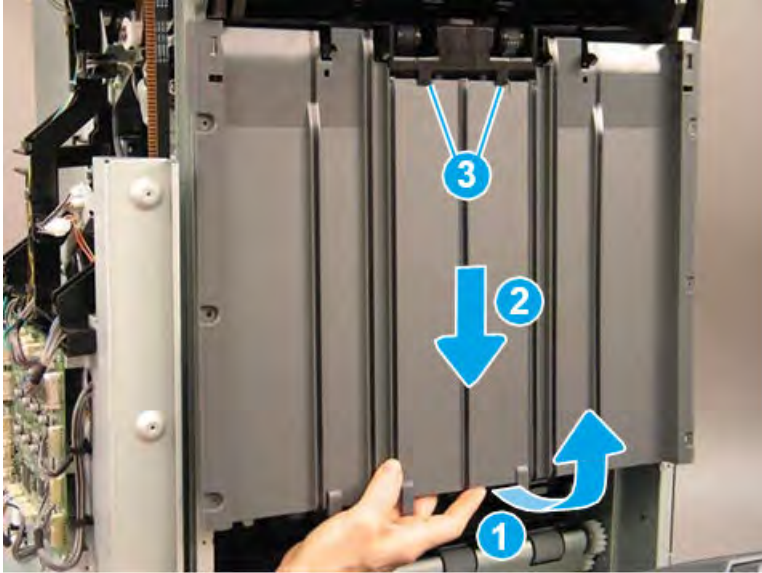


3. Rotate the lower edge of the shield away from the finisher (callout 1), and then slide the shield down (callout 2) to release it from two tabs (callout 3).

**⚠ CAUTION:** The shield is still attached to the finisher. Do not attempt to completely remove the shield.

**💡 TIP:** Position the shield under the two tabs (callout 3) when reinstalling it.

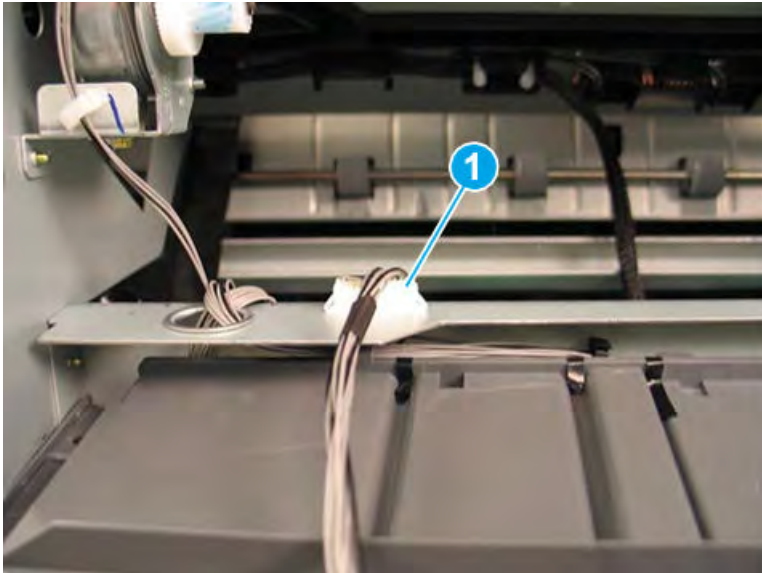
**Figure 5-735** Release the shield



4. Disconnect one connector (callout 1), and then remove the upper shield assembly.

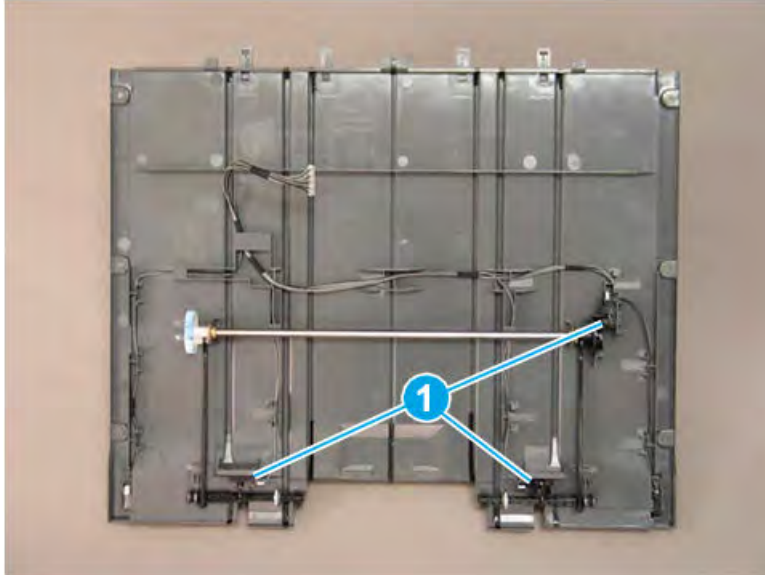
**💡 TIP:** Reverse the removal steps to install the assembly.

**Figure 5-736** Disconnect one connector



5. If you are replacing the left upper cover, locate three sensors (callout 1) on the back of the left upper cover. Remove these sensors and transfer them to the replacement part.

**Figure 5-737** Remove the left upper cover

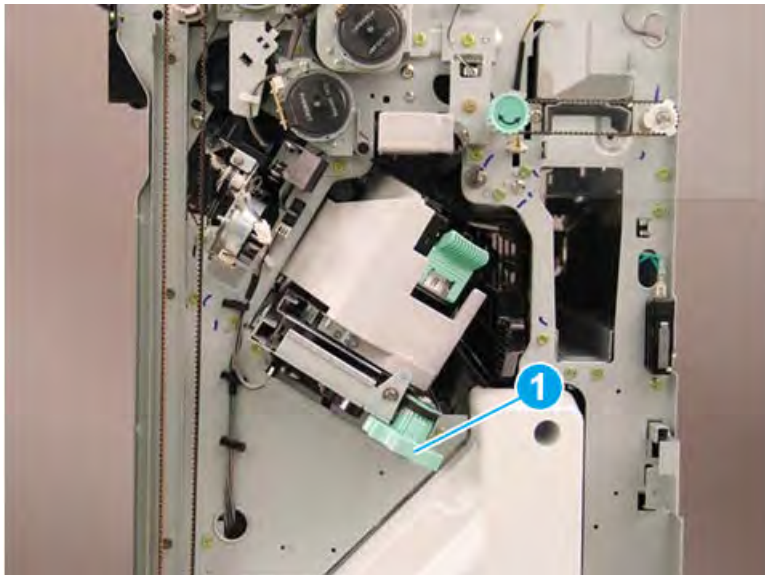


#### Remove the ejector unit (finisher)

Follow these steps to remove the ejector unit (finisher).

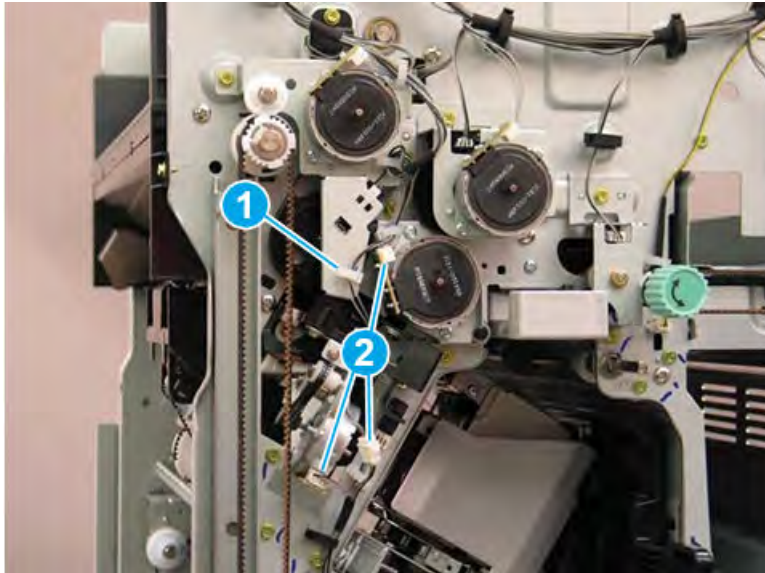
1. Rotate the green wheel to move the staple unit to the center of the finisher.

**Figure 5-738** Move the staple unit to the center



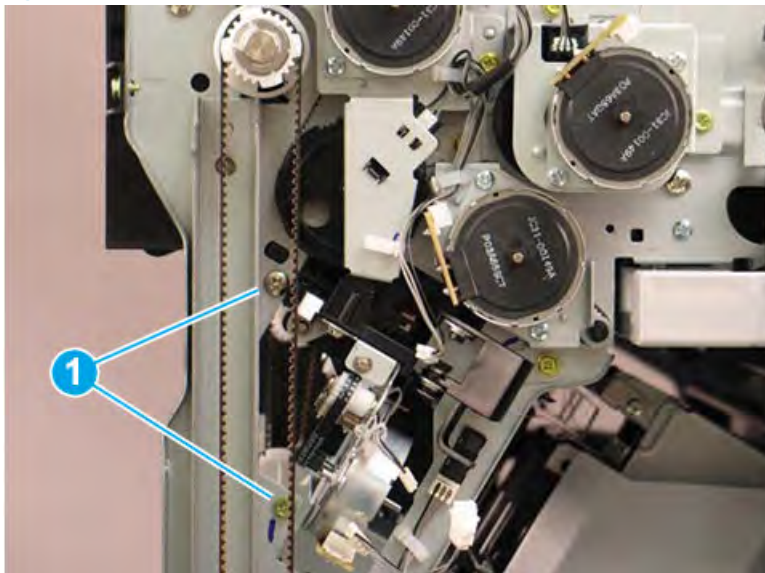
2. Release one retainer (callout 1), and then disconnect three connectors (callout 2).

Figure 5-739 Disconnect three connectors



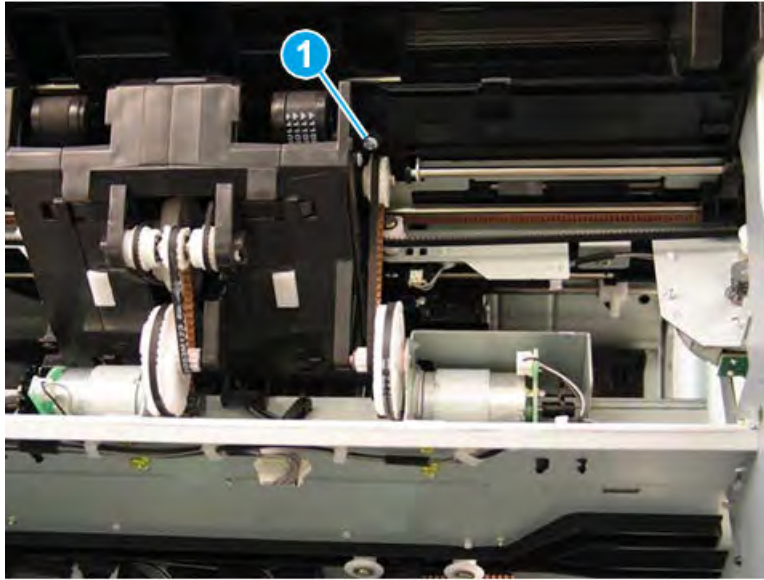
3. Remove two screws (callout 1).

Figure 5-740 Remove two screws



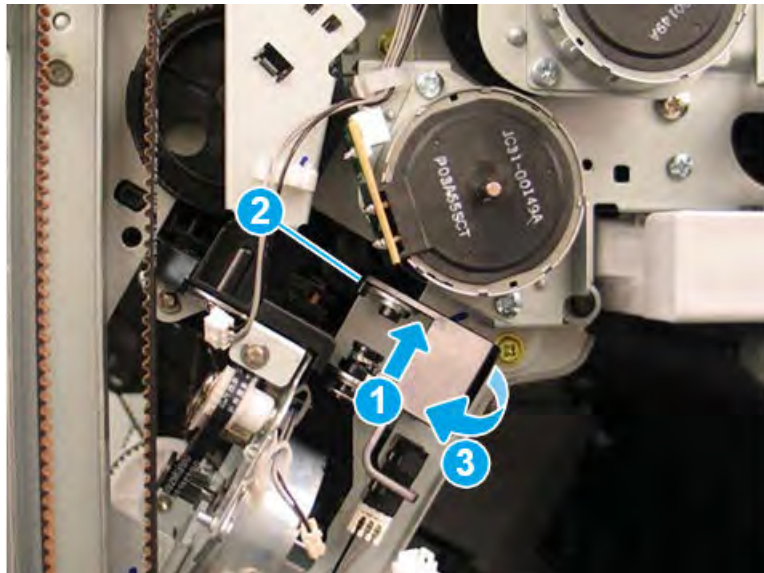
4. At the left side of the finisher, remove one screw (callout 1).

Figure 5-741 Remove one screw



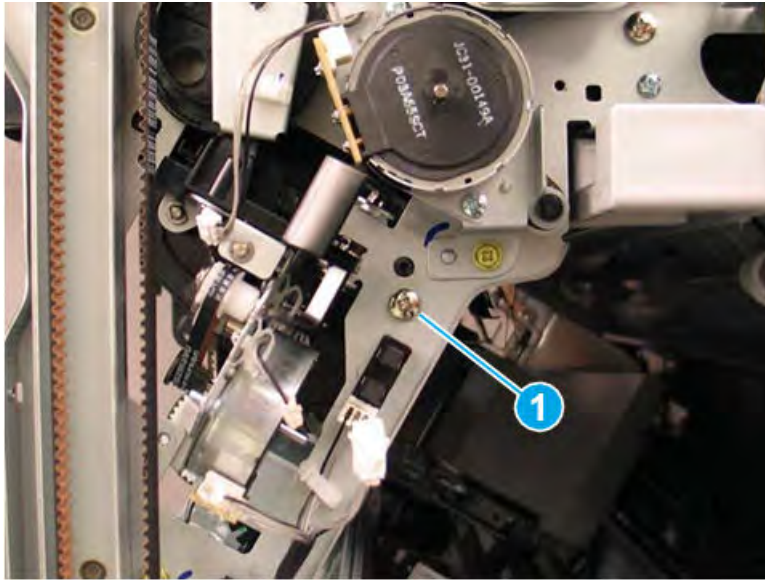
5. Press up on the hinge (callout 1), release one tab (callout 2), and then rotate the sensor away from the finisher (callout 3).

Figure 5-742 Rotate the sensor



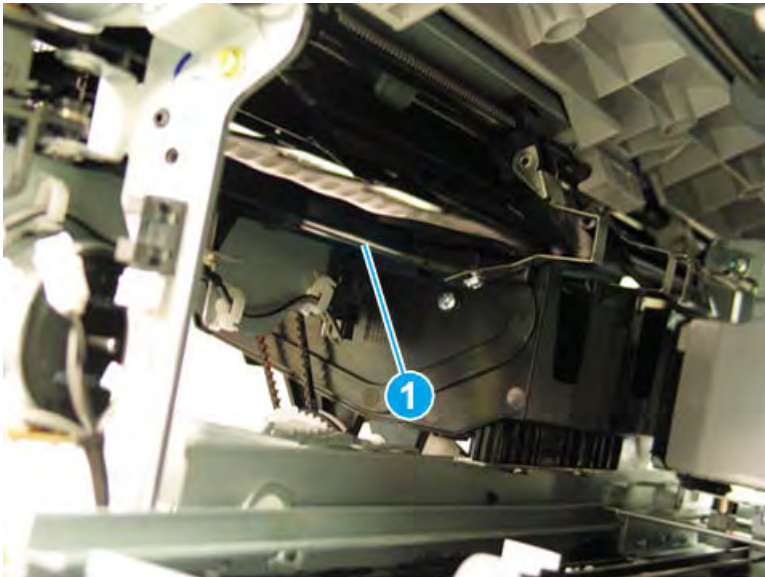
6. Remove one screw (callout 1).

Figure 5-743 Remove one screw



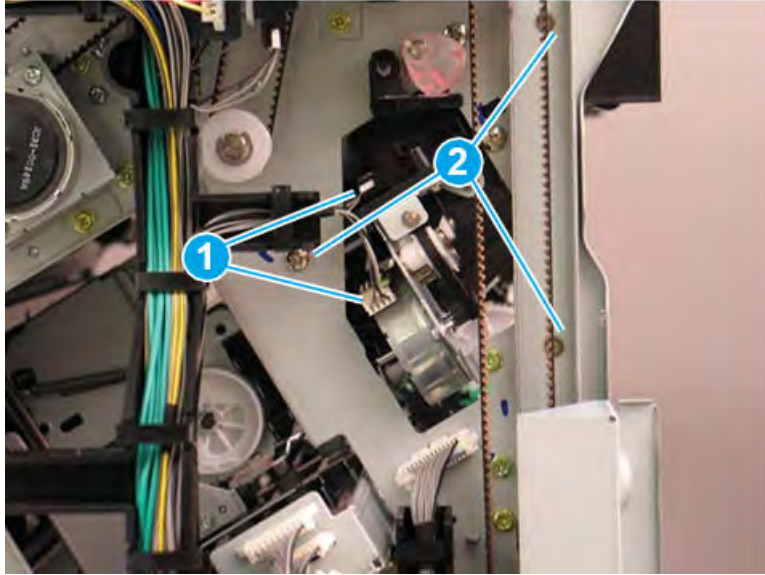
7. Look inside the finisher through the stapler opening in the front and pull down to release and remove one shaft (callout 1) on the front tamper unit.

Figure 5-744 Remove the front tamper shaft



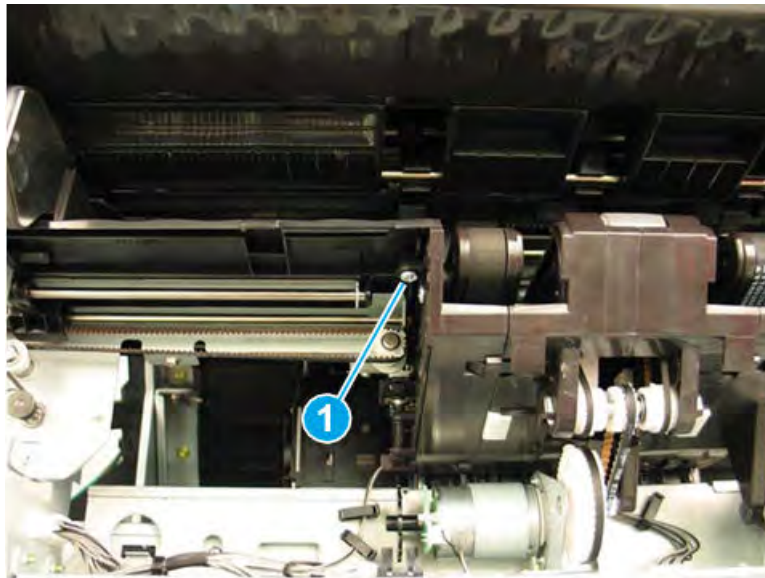
8. At the rear of the finisher, disconnect two connectors (callout 1), and then remove three screws (callout 2).

Figure 5-745 Disconnect two connectors and remove three screws



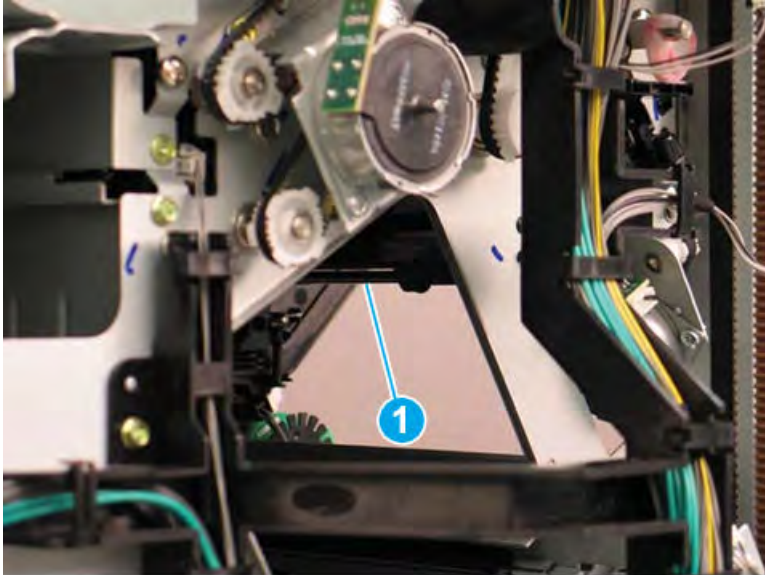
9. At the left side of the finisher, remove one screw (callout 1).

Figure 5-746 Remove one screw



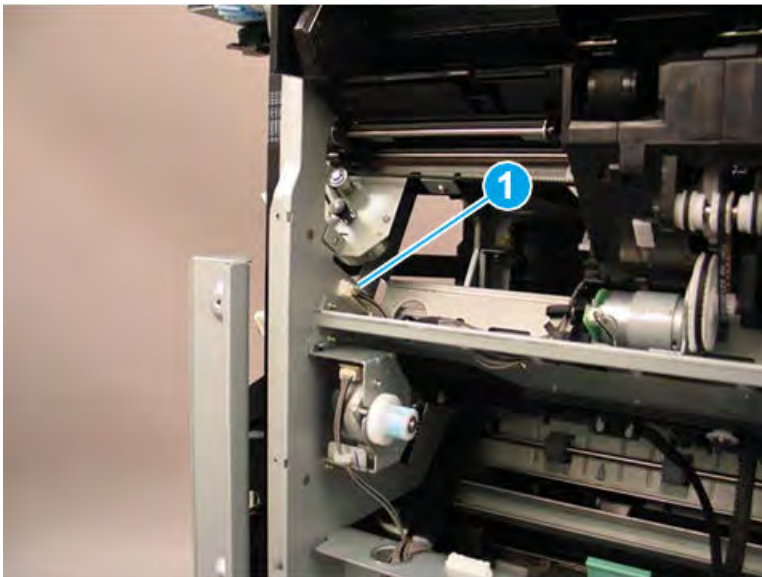
10. Look inside the finisher through the stapler opening in the rear and pull down to release and remove one shaft (callout 1) on the rear tamper unit.

Figure 5-747 Remove the rear tamper shaft



11. At the left side of the finisher, disconnect one connector (callout 1).

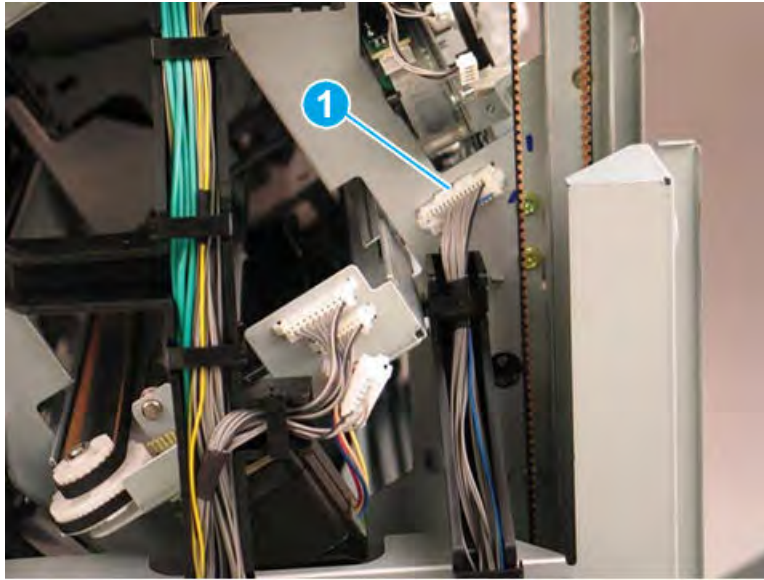
Figure 5-748 Disconnect one connector





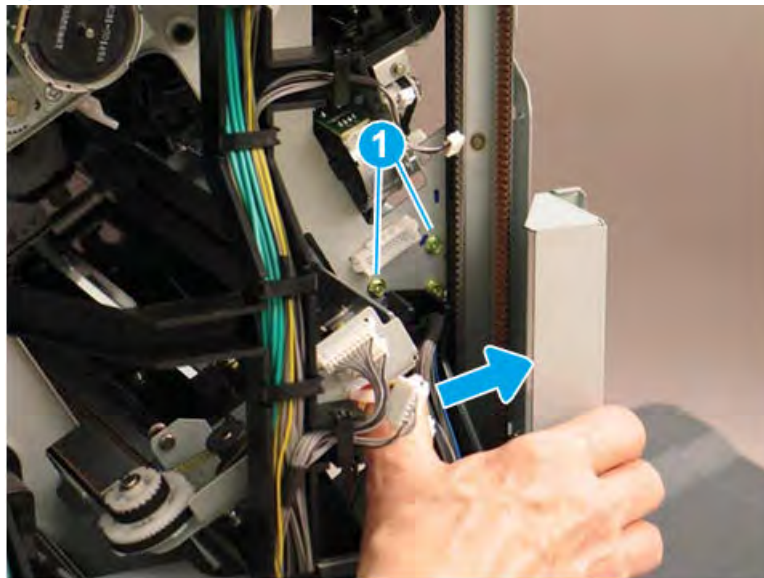
12. At the rear of the finisher, disconnect one connector (callout 1).

Figure 5-749 Disconnect one connector



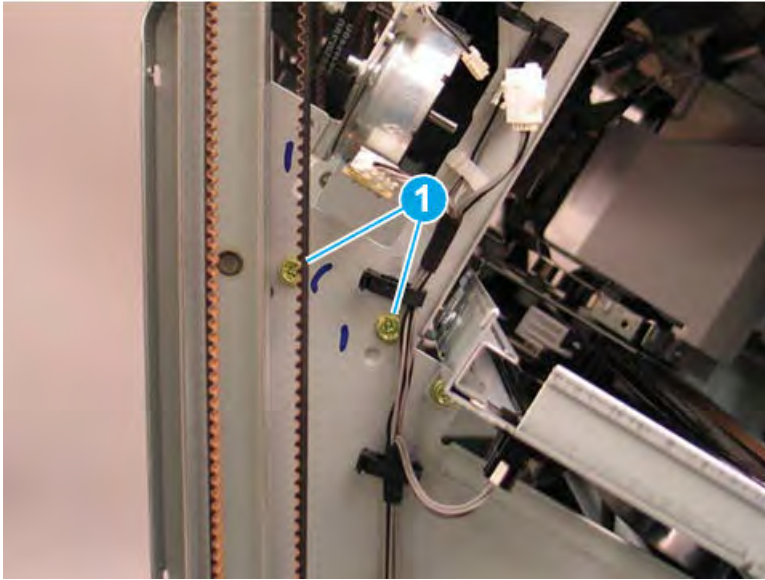
13. At the rear of the finisher, press the wire retainer to the right to access and remove two screws (callout 1).

Figure 5-750 Disconnect one connector



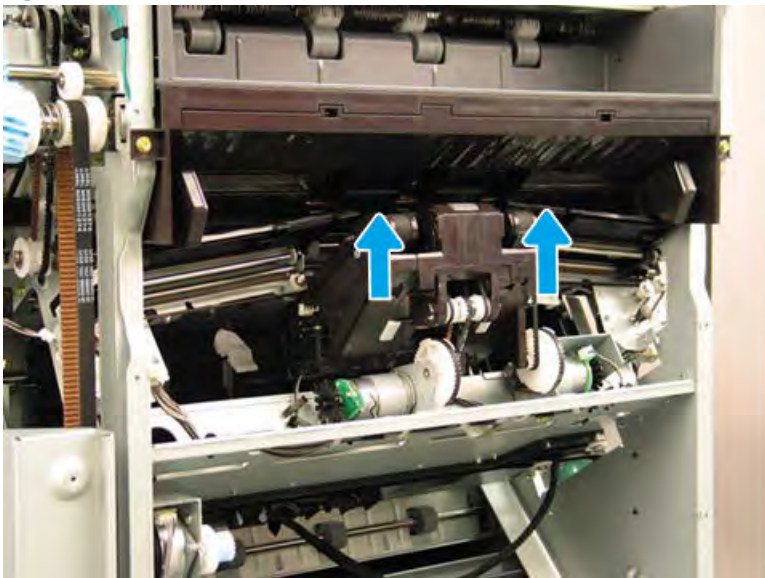
14. At the front of the finisher, remove two screws (callout 1).

Figure 5-751 Remove two screws



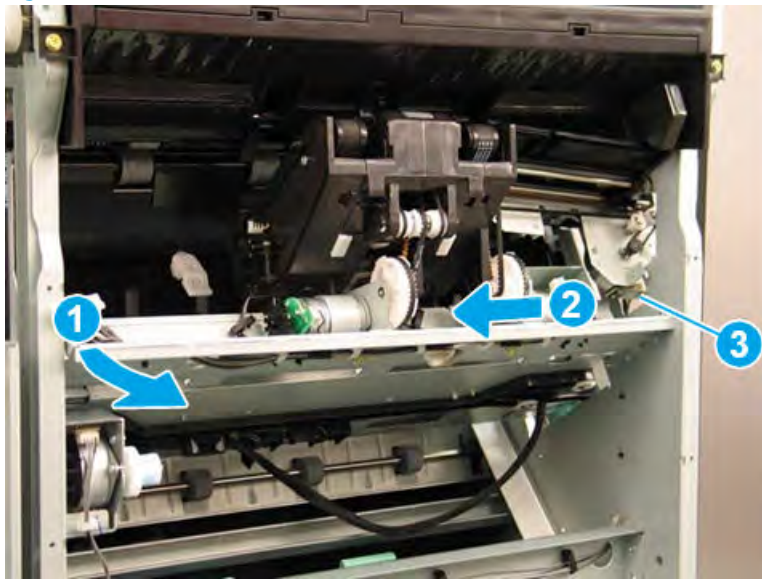
15. Lift the inside edges of the front and rear tampers up.

Figure 5-752 Lift the edges of the tampers



16. Rotate the rear edge of the ejector unit away from the finisher (callout 1), and then slide it toward the rear of the finisher (callout 2) to remove it. Make sure that the PCA (callout 3) stays clear of the sheet metal frame.

**Figure 5-753** Remove the ejector unit

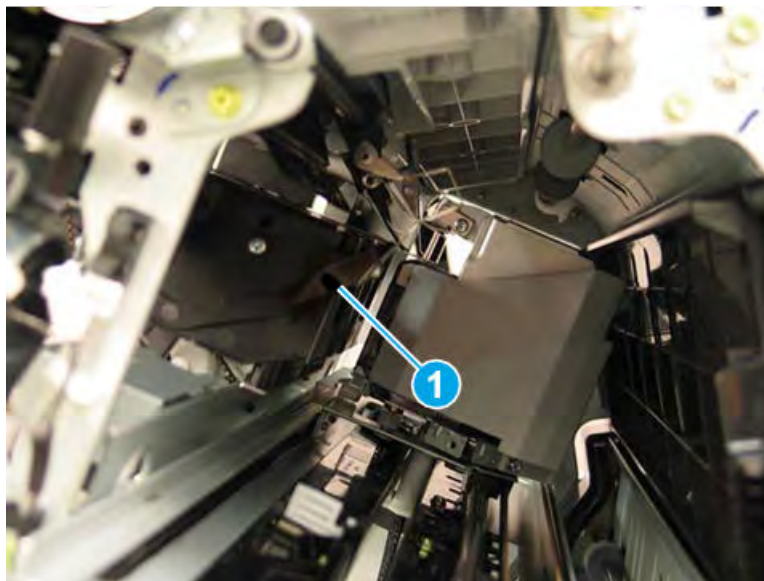


17. Reverse the removal steps to install the assembly. Also use the following special installation instructions.

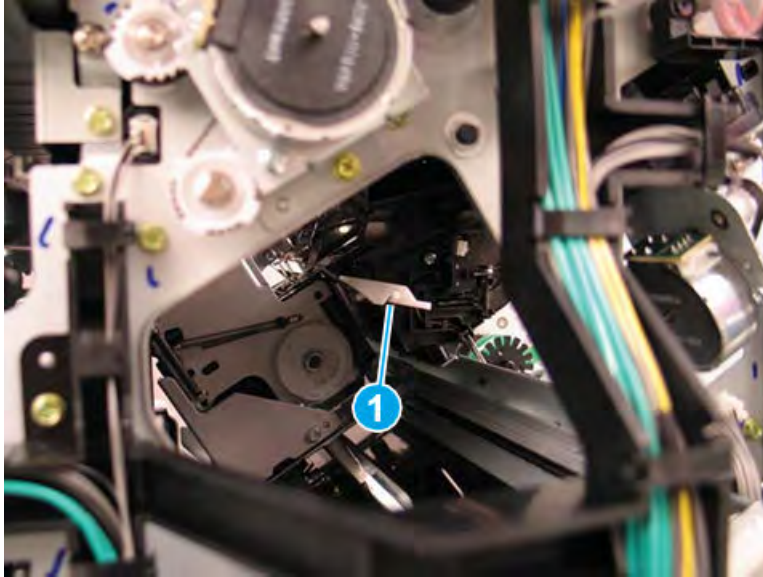
 **NOTE:** Continue to reverse the removal steps to finish installing the assembly.

**Special installation instructions: Ejector unit**

- a. When the front tamper shaft is removed, the retainer arm that held the one end of the shaft will drop down. When reinstalling the shaft, raise the retainer arm and position the end of the shaft in the notch (callout 1).




- b. When the rear tamper shaft is removed, the retainer arm that held the one end of the shaft will drop down. When reinstalling the shaft, raise the retainer arm and position the end of the shaft in the notch (callout 1).



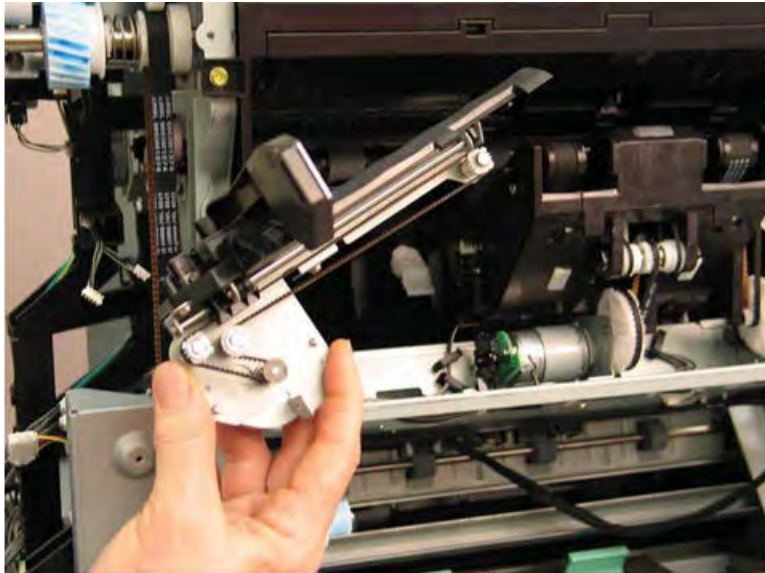
### Remove the rear tamper unit

Follow these steps to remove the rear tamper unit.

- ▲ Lift the rear tamper away from the finisher to remove it

 **NOTE:** Reverse the removal steps to install the assembly.

**Figure 5-754** Remove the rear tamper

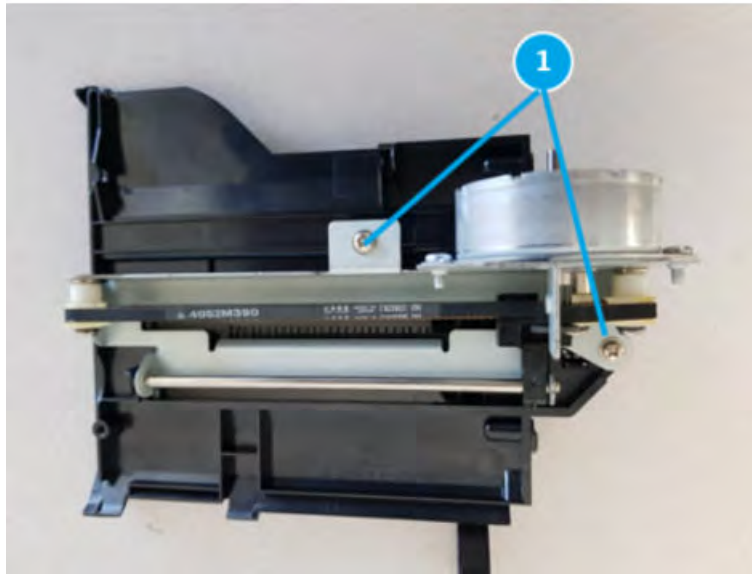


### Remove the rear tamper home sensor(S9)

Follow these steps to remove the rear tamper home sensor(S9).

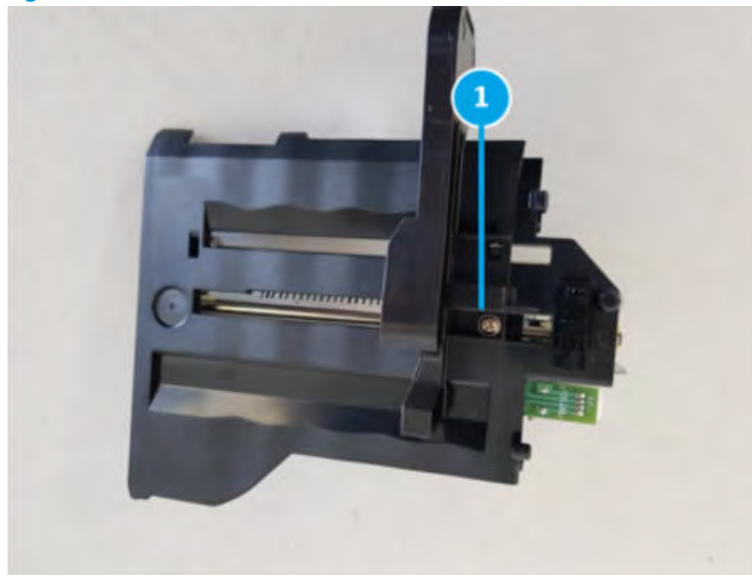
1. Remove two screws(callout 1) at the rear tamper.

Figure 5-755 Remove two screws



2. Remove one screw in front side(callout 1)

Figure 5-756 Remove one screw



3. Remove rear tamper home sensor(S9, callout 1)

**Figure 5-757** Remove rear tamper home sensor




### Unpack the replacement assembly

Follow these steps to unpack the replacement assembly.

1. Dispose of the defective part.

---



 **NOTE:** HP recommends responsible disposal of the defective part.

<http://www8.hp.com/us/en/hp-information/environment/product-recycling.html>


---

2. Unpack the replacement part from the packaging.

---

 **CAUTION:**  Some parts are sensitive to electrostatic discharge (ESD). Always perform service work at an ESD-protected workstation or mat. If an ESD workstation or mat is not available, touch the sheet-metal chassis to provide a static ground before touching an ESD-sensitive assembly. Protect the ESD-sensitive assemblies by placing them in ESD pouches when they are out of the printer.


 **IMPORTANT:** Make sure that all of the shipping materials (for example shipping tape) are removed from the replacement part prior to installation.

 **NOTE:** If the replacement part is a roller or pad, avoid touching the spongy part of it. Skin oils on the roller or pad can cause paper pickup and/or print-quality problems. HP recommends using disposable gloves when handling rollers or pads or washing your hands before touching rollers or pads.

---

3. To install an assembly, reverse the removal steps.

---

 **NOTE:** When applicable, special installation instructions are provided for an assembly at the end of the removal procedure. Always completely read the removal instructions and follow all special installation instructions.


---

## Removal and replacement: Rear tamper motor (M9)


Learn how to remove and replace the rear tamper motor.

### Introduction

This document provides the procedures to remove and replace the rear tamper motor on the finisher.

 **IMPORTANT:** When applicable, special installation instructions are provided for an assembly at the end of the removal procedure. Always completely read the removal instructions and follow all special installation instructions.

### Before performing service

- Turn the printer power off. A shutting-down message appears on the control-panel display.
-  **WARNING!** To avoid damage to the printer, turn the power off and wait until the printer shuts down before removing the power cable.
- Disconnect the printer power cable after the printer has completely shut down (the control-panel display is blank).
- Release the finisher from the printer by pulling out on the release latch inside the finisher door.
- Disconnect the cable from the bridge unit to the finisher.
- Disconnect the cable from the finisher to the printer.

Use the table below to identify the correct part number for your printer. To order the part, go to <https://parts.hp.com>.

**Table 5-118** Part information

Part number	Part description
JC93-01001A	Rear tamper motor

### Required tools

- #2 JIS screwdriver with a magnetic tip

### After performing service

- Connect the cable from the finisher to the printer.
- Connect the cable from the bridge unit to the finisher.
- Attach the finisher to the printer, and then push in on the release latch inside the finisher door.
- Connect the printer power cable.
- Turn the printer power on.

### Post service test

Process a job through the finisher and verify that the finisher works correctly.

### Remove the right upper cover (finisher)

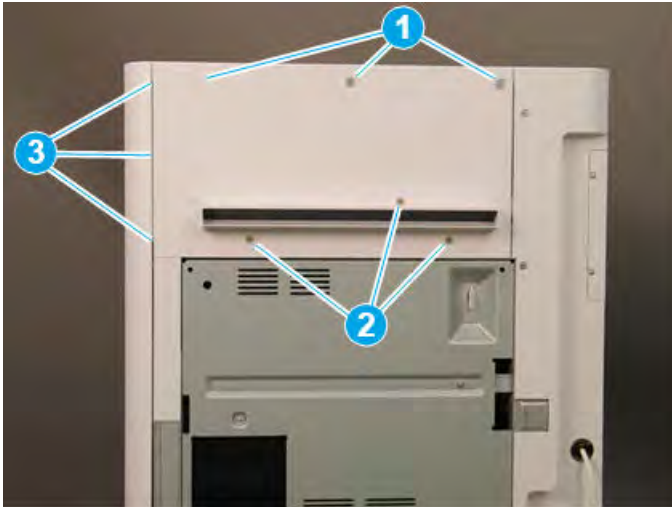
Follow these steps to remove the right upper cover (finisher).

- ▲ Remove one screw cap and three machine screws on the upper edge of the cover (callout 1). Remove three sheet metal screws (callout 2) on the lower portion of the cover. Rotate the right edge of the cover away from the finisher, and then slide the cover right to release three tabs (callout 3).

💡 **TIP:** The lower screws are shorter in length than the upper screws.

**TIP:** Reverse the removal steps to install the assembly.

**Figure 5-758** Remove the right upper cover

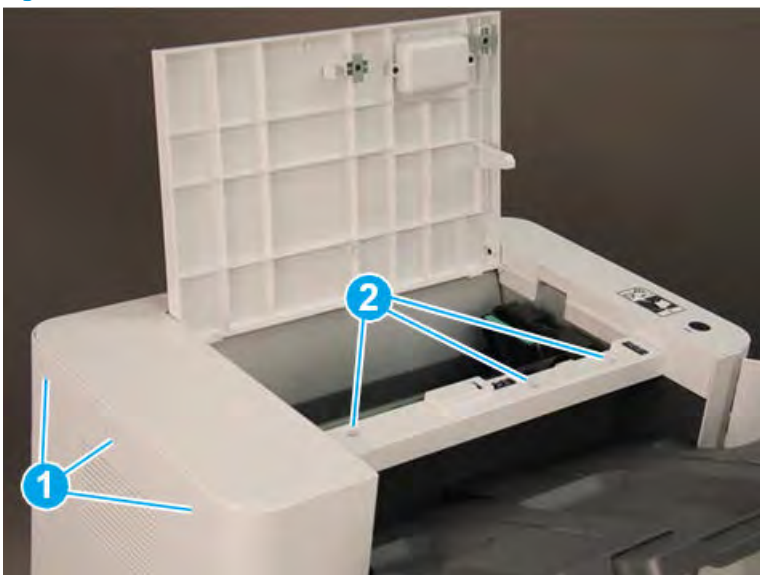


### Remove the top cover (finisher)

Follow these steps to remove the top cover (finisher).

1. Remove three screw caps and three self-tapping screws at the top of the rear cover (callout 1), and then remove three machine screws (callout 2) on top of the cover.

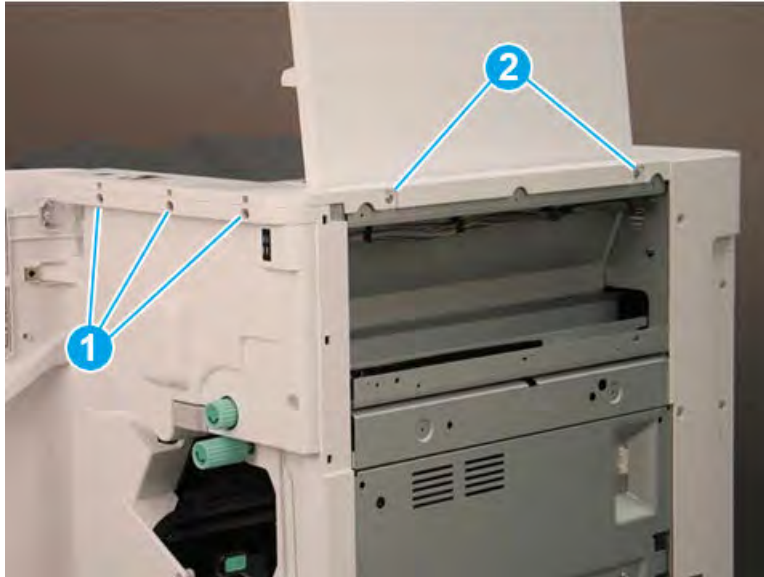
**Figure 5-759** Remove six screws





2. Remove three self-tapping screws at the top of the front cover (callout 1), and then remove two machine screws (callout 2) at the top of the right side.

Figure 5-760 Remove five screws



3. Lift the cover up slightly. Disconnect one in-line connector (callout 1), and then release one retainer (callout 2).


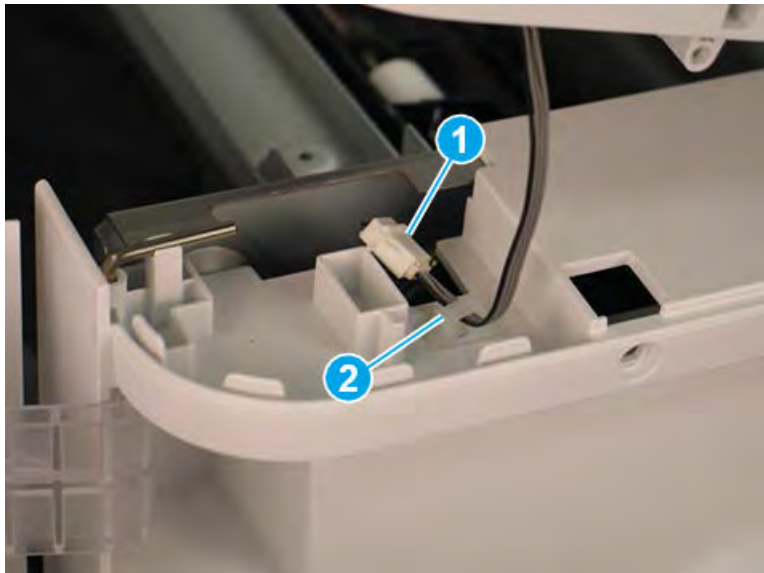
 **TIP:** Reverse the removal steps to install the assembly.

Figure 5-761 Disconnect one connector and release retainer

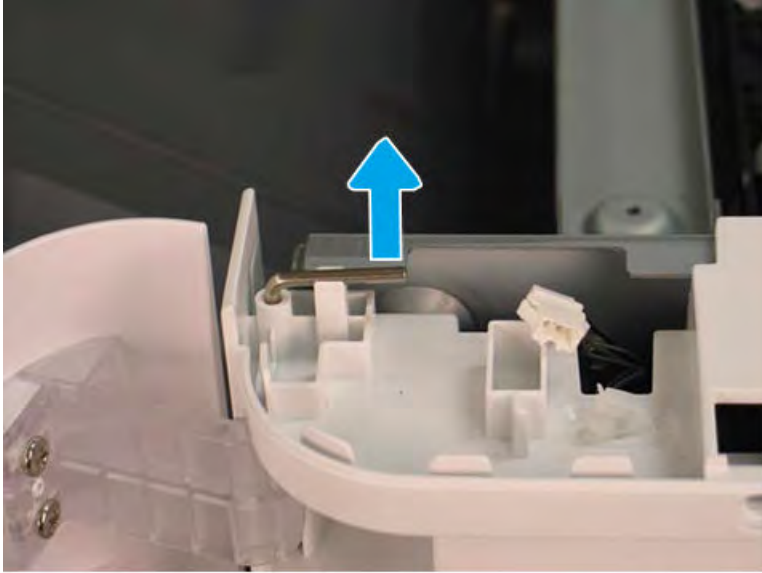


### Remove the front door (finisher)

Follow these steps to remove the front door (finisher).

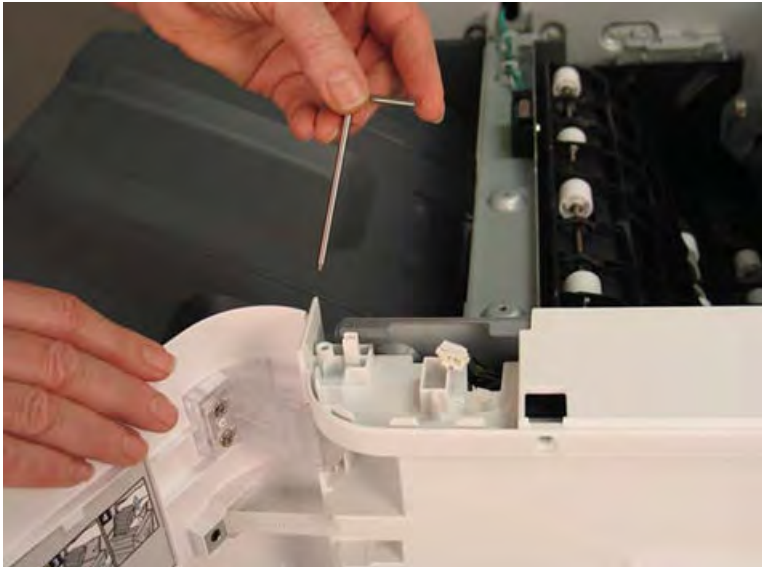
1. Lift the top hinge pin up to release it from the retainer.

Figure 5-762 Lift the top hinge pin



2. Pull the top hinge pin up to remove it.

Figure 5-763 Remove the top hinge pin



3. Use a small, flat-blade screwdriver to release the lower hinge pin from the retainer, and then rotate it away from the finisher.

Figure 5-764 Release the lower hinge pin



4. Support the door with one hand, and then pull the lower hinge pin straight up to remove it.

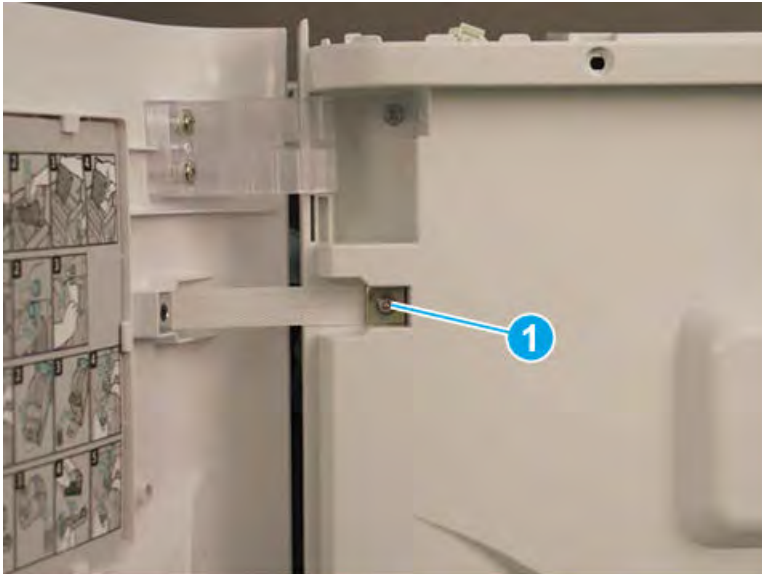
Figure 5-765 Remove the lower hinge pin



5. Support the door with one hand, and then remove one screw (callout 1) to release the strap. Remove the front door.

 **TIP:** Reverse the removal steps to install the assembly.

**Figure 5-766** Remove the front door

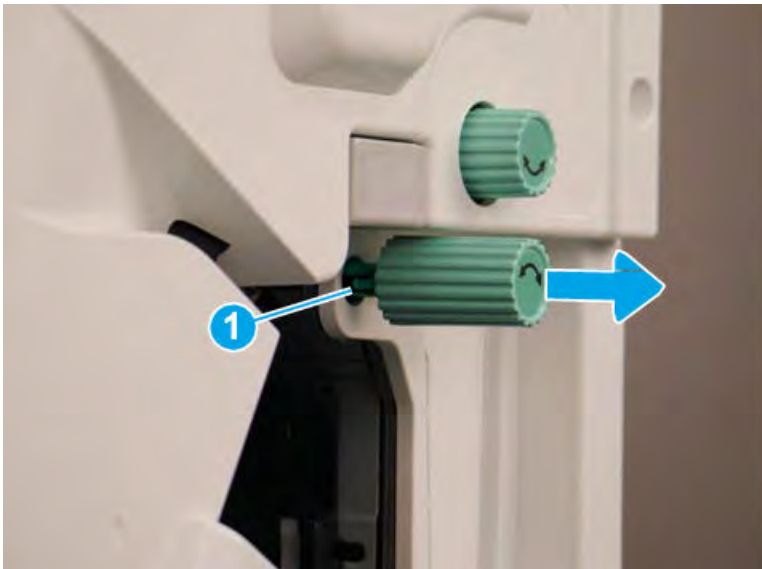


#### Remove the front cover (finisher)

Follow these steps to remove the front cover (finisher).

1. Release one tab (callout 1), and then pull the jam-access knob away from the finisher to remove it.

**Figure 5-767** Remove the jam-access knob



2. If the punch unit is installed, remove the punch waste bin (callout 1).


3. Remove one screw (callout 1) on top of the front cover.

Figure 5-768 Remove one screw



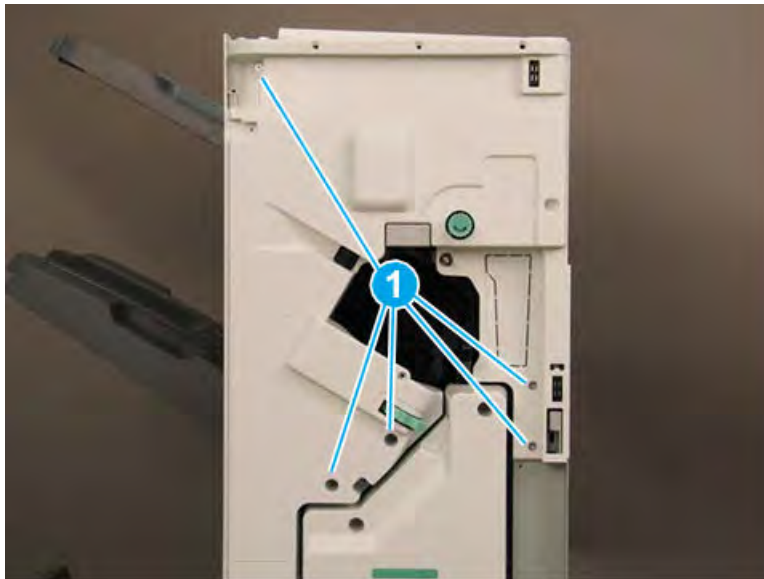
4. Remove five machine screws (callout 1), and then remove the front cover.

---

 **TIP:** Reverse the removal steps to install the assembly.

---

Figure 5-769 Remove the front cover

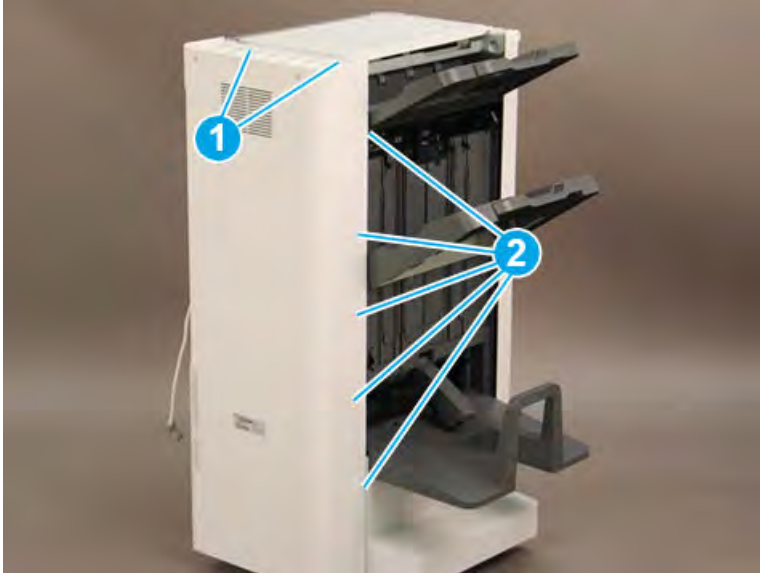


### Remove the rear cover (finisher)

Follow these steps to remove the rear cover (finisher).

1. Remove two self-tapping screws (callout 1) on the top of the rear cover, and then remove five screw caps and five machine screws (callout 2) on the left side of the cover.

Figure 5-770 Remove seven screws

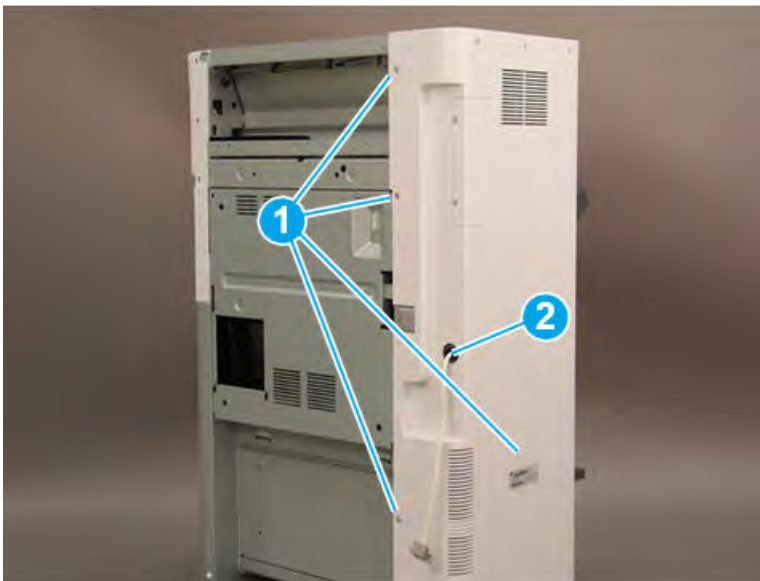


2. Remove one screw cap and four machine screws (callout 1) Remove the rear cover.

 **NOTE:** Make sure to thread the power cable (callout 2) through the opening in the cover.

 **TIP:** Reverse the removal steps to install the assembly

Figure 5-771 Remove the rear cover



### Remove the booklet output tray

Follow these steps to remove the booklet output tray.

1. Raise the booklet output tray up (callout 1), and then pull it away from the finisher (callout 2) to remove it.

Figure 5-772 Remove the booklet output tray



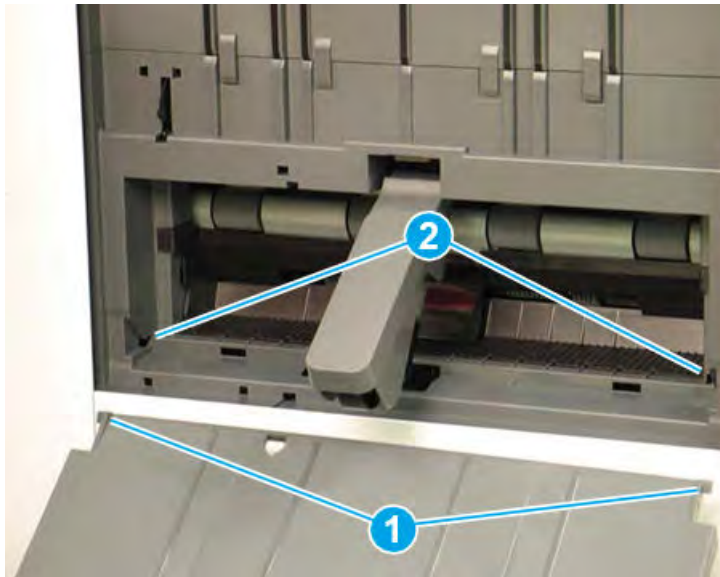
2. Reverse the removal steps to install the assembly. Also use the following special installation instructions.

 **NOTE:** Continue to reverse the removal steps to finish installing the assembly

Special installation instructions: booklet output tray

Position the tabs (callout 1) on the tray into the slots (callout 2) on the finisher.

Figure 5-773 Install the booklet output tray

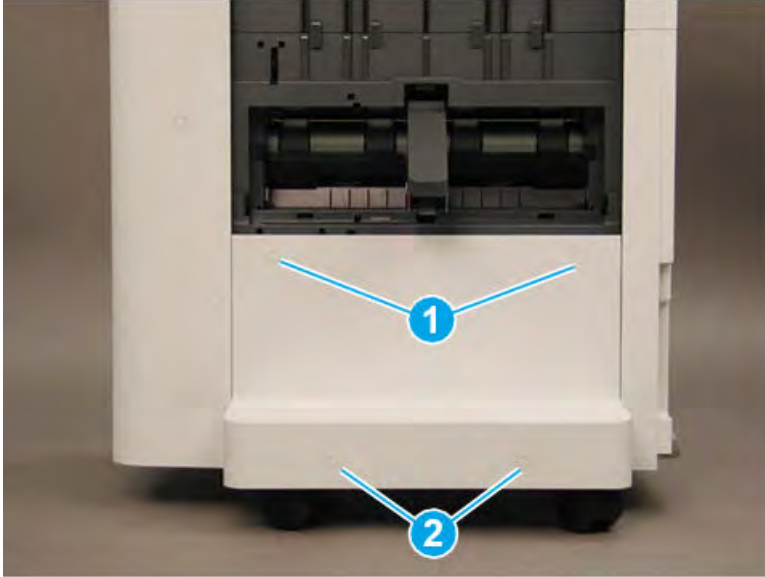


### Remove the caster cover

Follow these steps to remove the caster cover.


1. Remove two screw caps and two self-tapping screws (callout 1). Remove two screw caps and two machine screws (callout 2).

Figure 5-774 Remove four screws



2. Rotate the left edge of the cover away from the finisher (callout 1), and then slide the cover to the left (callout 2) to remove it.

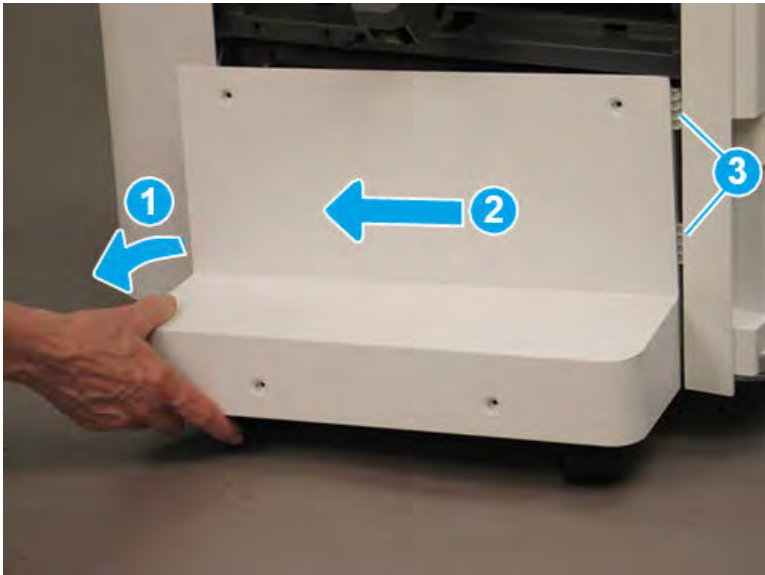
---

 **TIP:** Make sure that two tabs (callout 3) are positioned under the front lower cover when reinstalling the caster cover.

**TIP:** Reverse the removal steps to install the assembly

---

Figure 5-775 Remove the caster cover




### Remove the left lower cover (finisher)

Follow these steps to remove the left lower cover (finisher).

1. Remove four screws (callout 1).

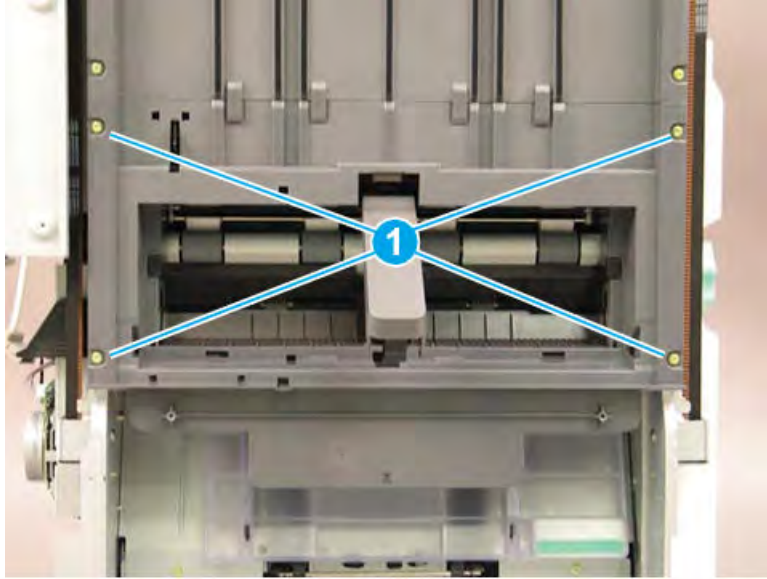
---

 **NOTE:** Raise the lower output tray as needed to access the screws.

---



Figure 5-776 Remove four screws

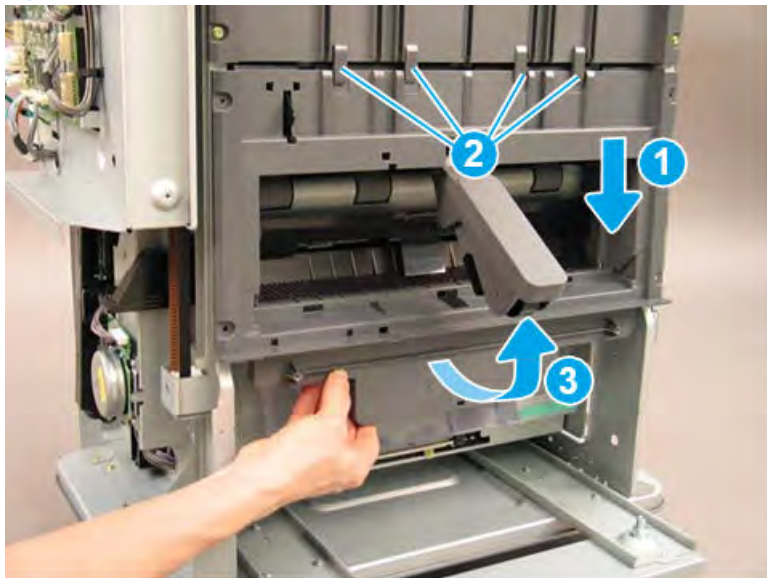


2. Slide the shield down (callout 1) to release it from four tabs (callout 2), and then rotate it away from the finisher (callout 3).


**⚠ CAUTION:** The shield is still attached to the finisher. Do not attempt to completely remove the shield.

**💡 TIP:** Position the shield under the four tabs (callout 2) when reinstalling it.

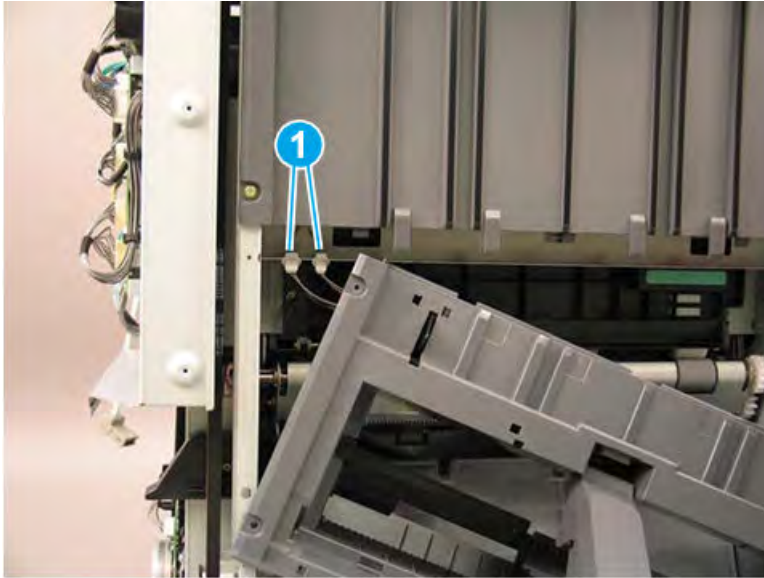
Figure 5-777 Release the lower shield



3. Disconnect two connectors (callout 1), and then remove the shield.

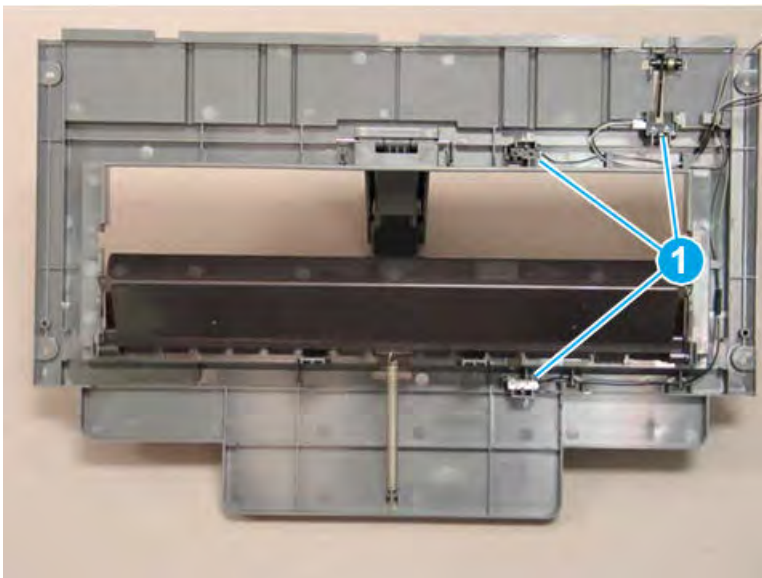
 **TIP:** Reverse the removal steps to install the assembly.

**Figure 5-778** Disconnect two connectors



4. If you are replacing the left lower cover, locate three sensors (callout 1) on the back of the left lower cover. Remove these sensors and transfer them to the replacement part.

**Figure 5-779** Remove the left lower cover

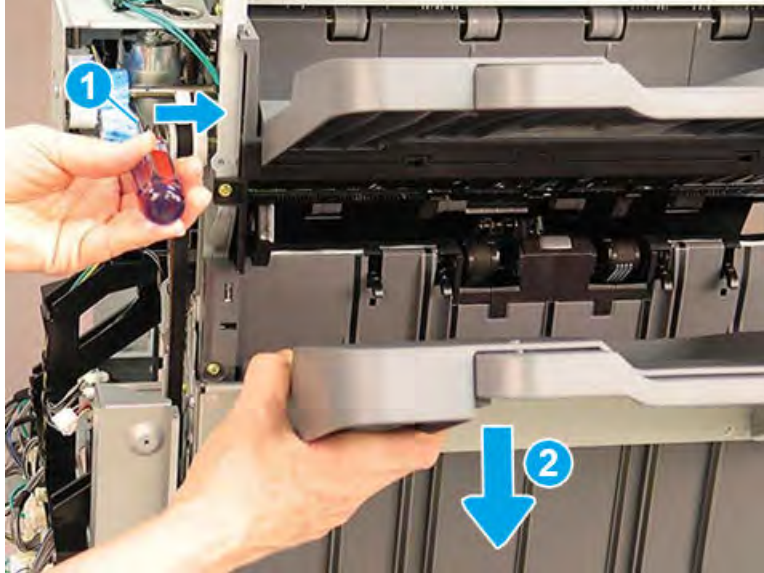


### Remove the left upper cover (finisher)

Follow these steps to remove the left upper cover (finisher).

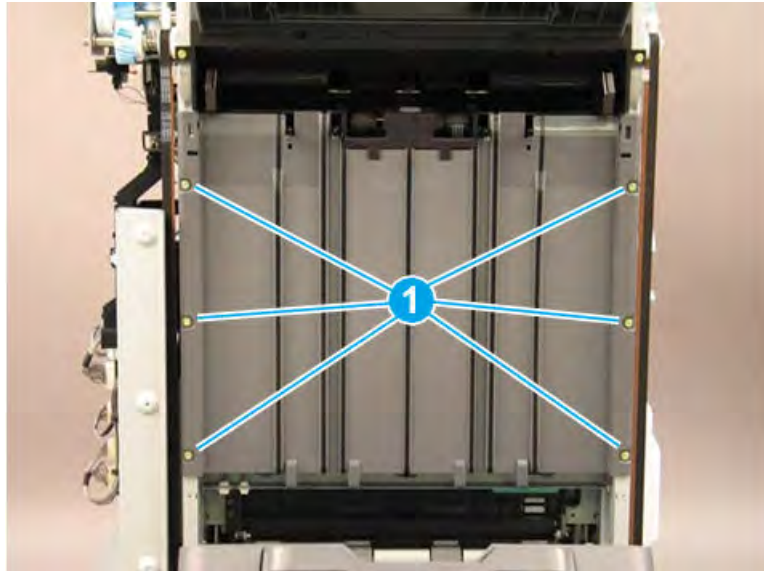
1. Bring the lower output tray down by positioning the shaft of a screwdriver on the clutch (callout 1) and gently pressing to the right to release the clutch. Hold the clutch in the released position and lower the tray (callout 2) to the lowest position.

Figure 5-780 Lower the output tray



2. Remove six machine screws (callout 1).

Figure 5-781 Remove six screws

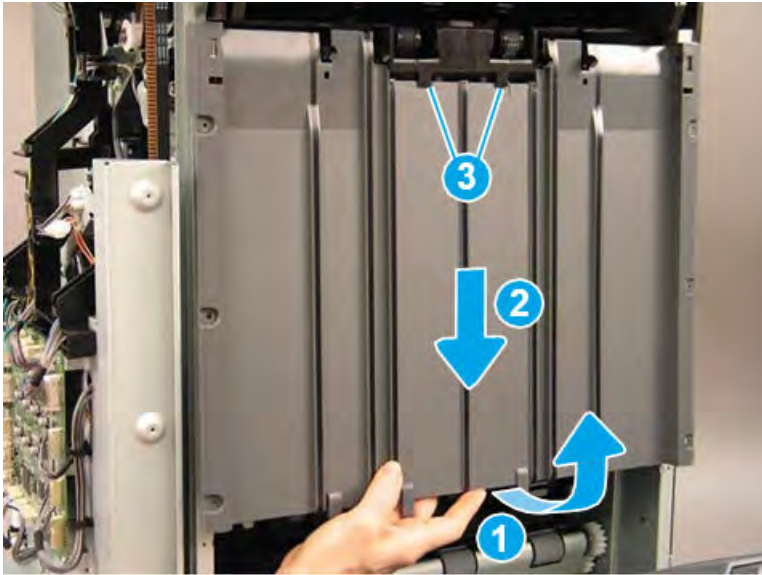


3. Rotate the lower edge of the shield away from the finisher (callout 1), and then slide the shield down (callout 2) to release it from two tabs (callout 3).

**⚠ CAUTION:** The shield is still attached to the finisher. Do not attempt to completely remove the shield.

**💡 TIP:** Position the shield under the two tabs (callout 3) when reinstalling it.

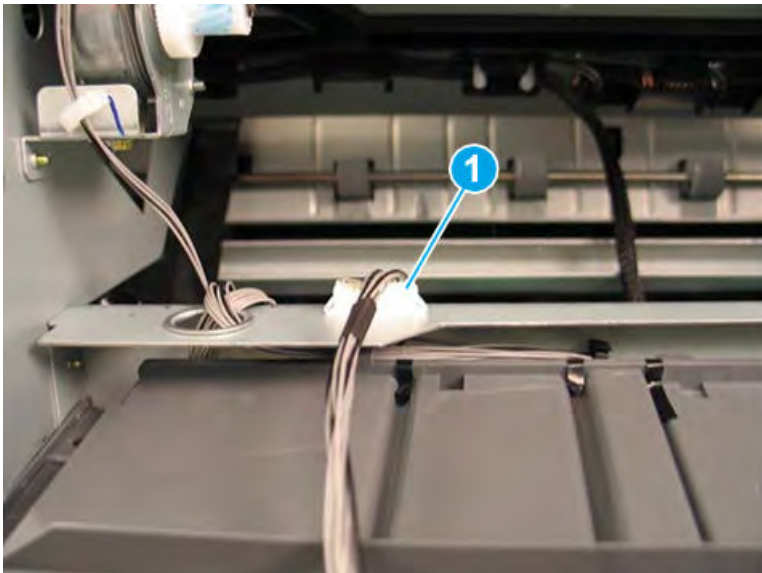
**Figure 5-782** Release the shield



4. Disconnect one connector (callout 1), and then remove the upper shield assembly.

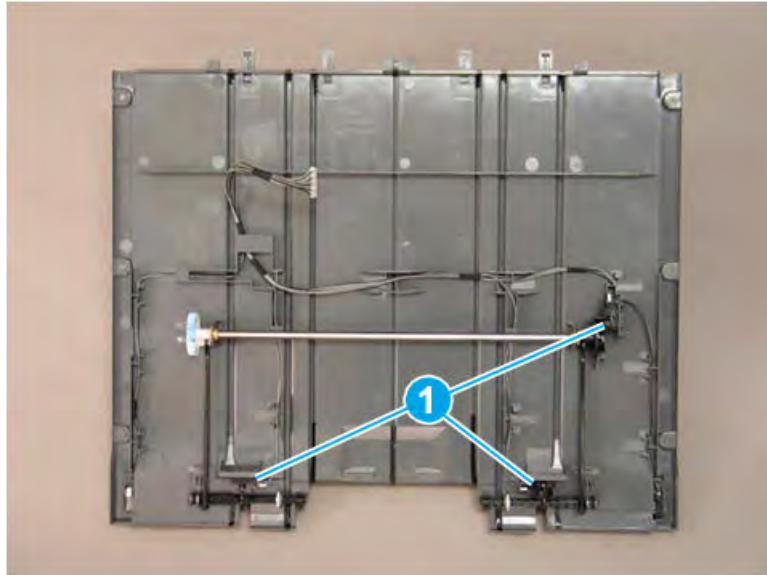
**💡 TIP:** Reverse the removal steps to install the assembly.

**Figure 5-783** Disconnect one connector



5. If you are replacing the left upper cover, locate three sensors (callout 1) on the back of the left upper cover. Remove these sensors and transfer them to the replacement part.

Figure 5-784 Remove the left upper cover

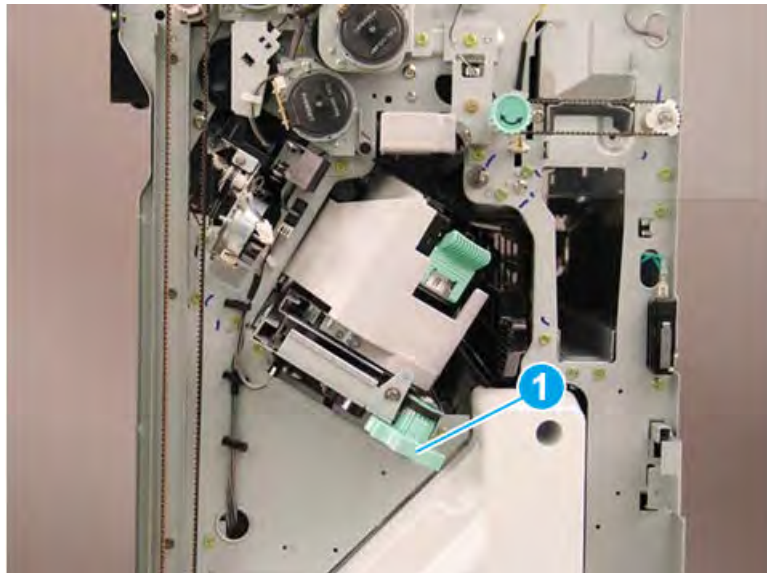


#### Remove the ejector unit (finisher)

Follow these steps to remove the ejector unit (finisher).

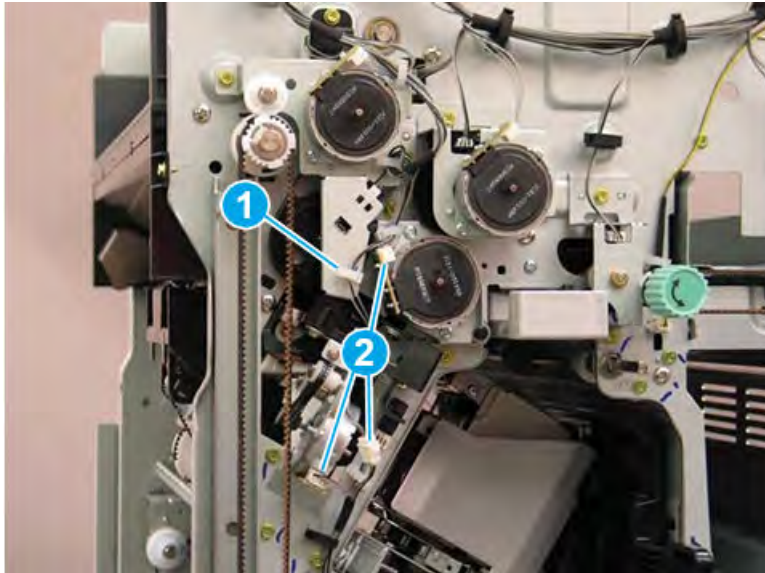
1. Rotate the green wheel to move the staple unit to the center of the finisher.

Figure 5-785 Move the staple unit to the center



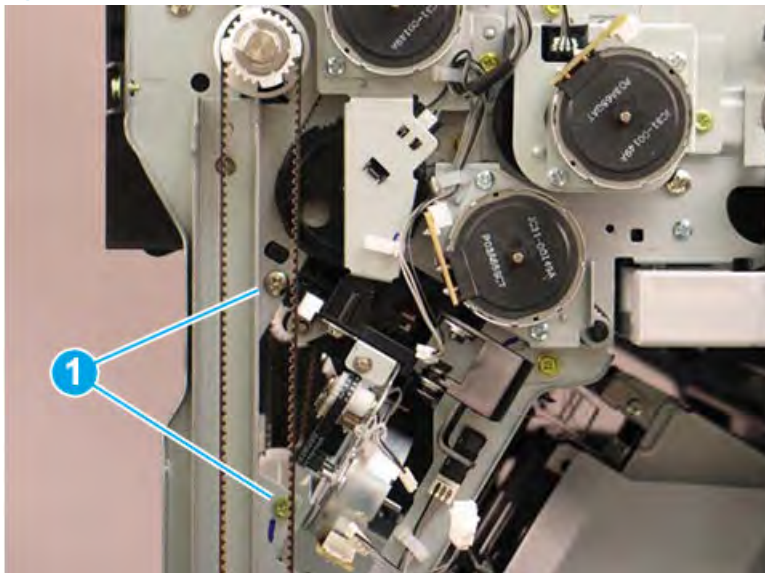
2. Release one retainer (callout 1), and then disconnect three connectors (callout 2).

Figure 5-786 Disconnect three connectors



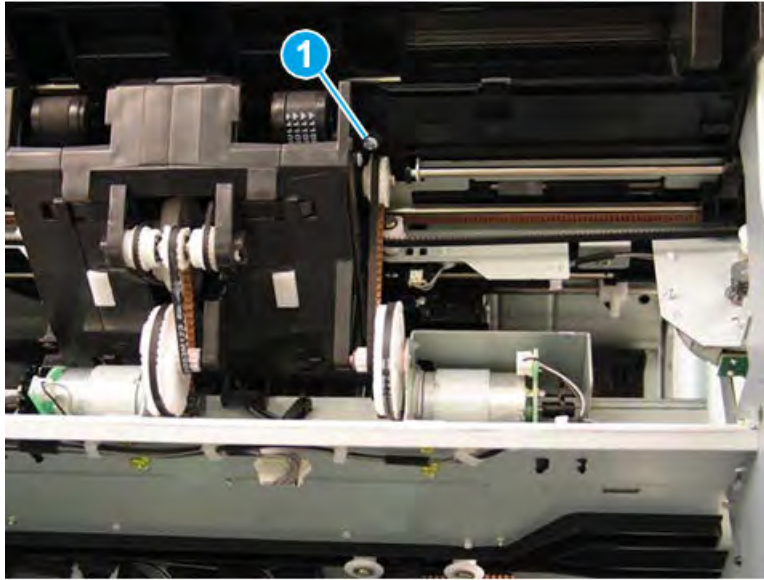
3. Remove two screws (callout 1).

Figure 5-787 Remove two screws



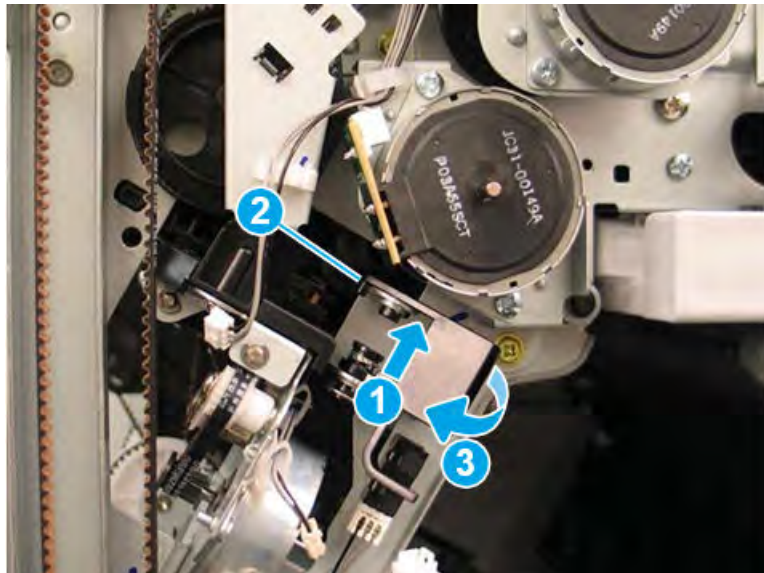
4. At the left side of the finisher, remove one screw (callout 1).

Figure 5-788 Remove one screw



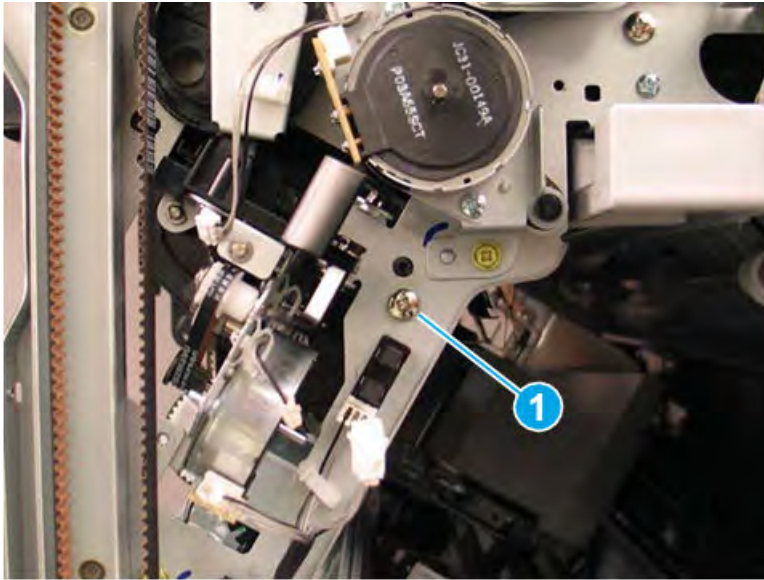
5. Press up on the hinge (callout 1), release one tab (callout 2), and then rotate the sensor away from the finisher (callout 3).

Figure 5-789 Rotate the sensor



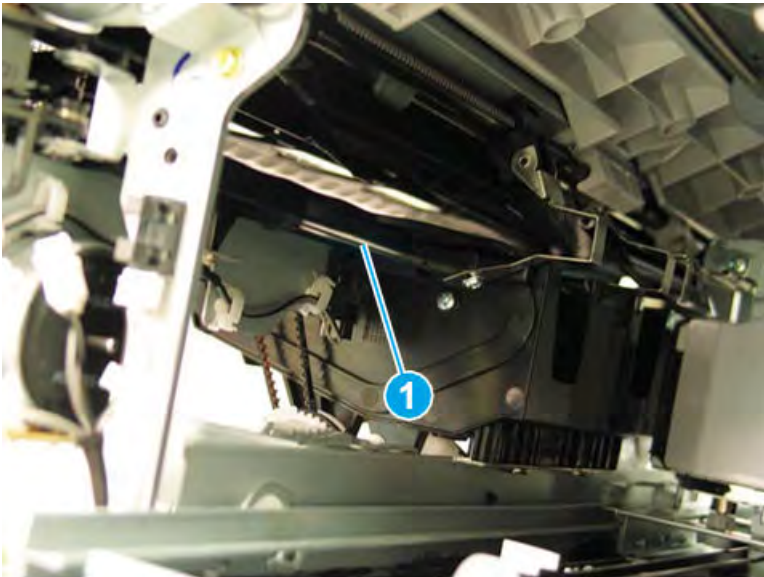
6. Remove one screw (callout 1).

Figure 5-790 Remove one screw



7. Look inside the finisher through the stapler opening in the front and pull down to release and remove one shaft (callout 1) on the front tamper unit.

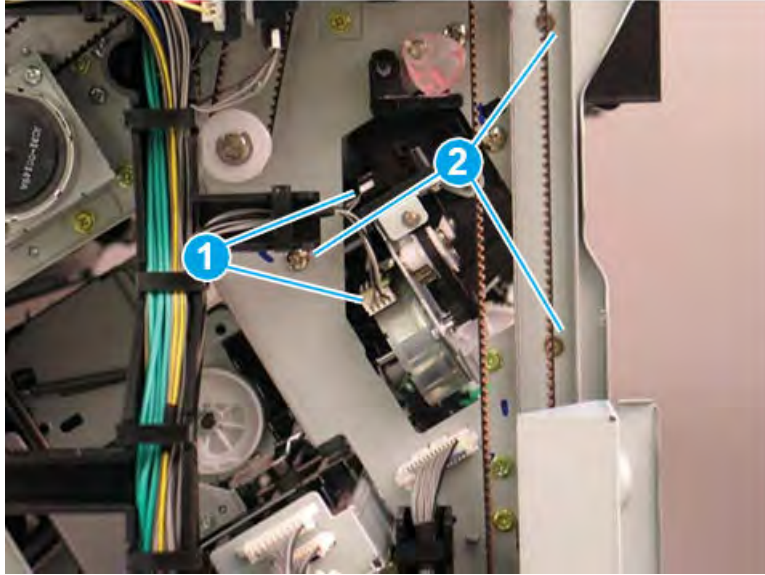
Figure 5-791 Remove the front tamper shaft





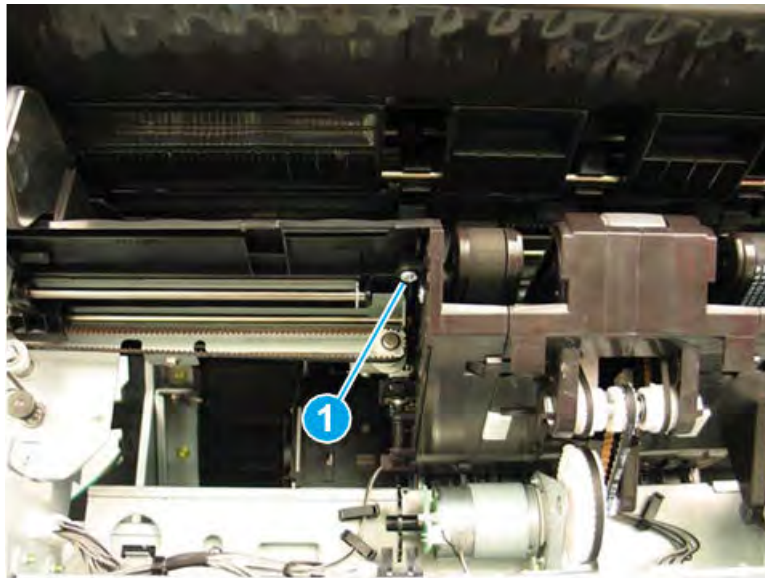
8. At the rear of the finisher, disconnect two connectors (callout 1), and then remove three screws (callout 2).

Figure 5-792 Disconnect two connectors and remove three screws



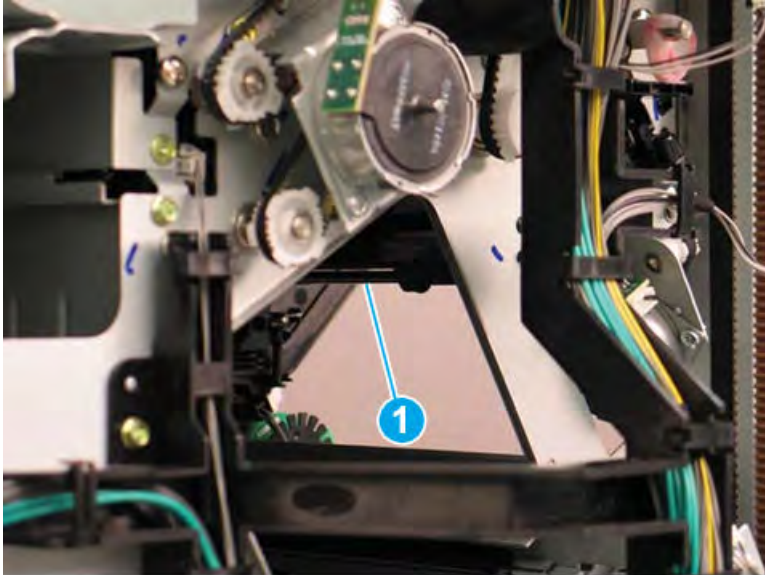
9. At the left side of the finisher, remove one screw (callout 1).

Figure 5-793 Remove one screw



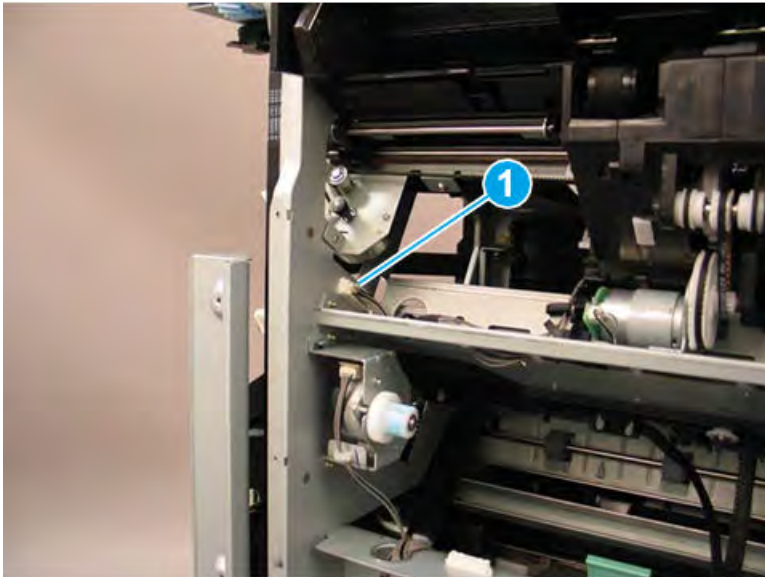
10. Look inside the finisher through the stapler opening in the rear and pull down to release and remove one shaft (callout 1) on the rear tamper unit.

Figure 5-794 Remove the rear tamper shaft



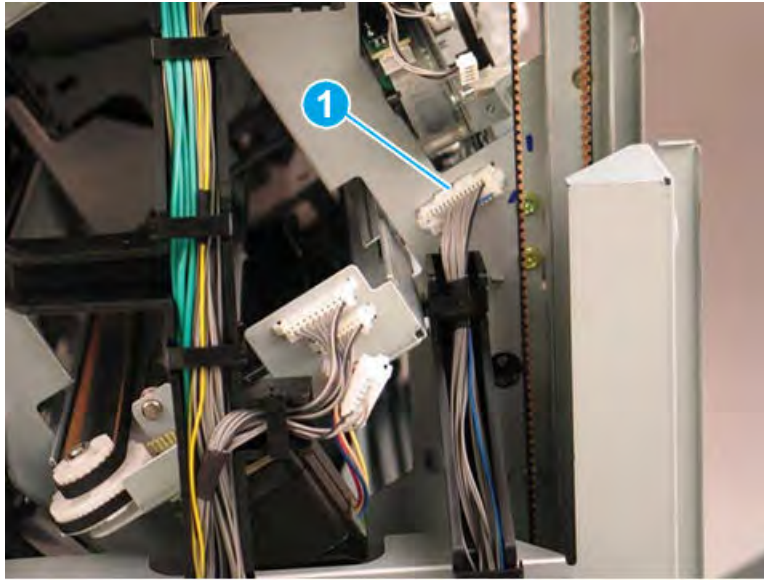
11. At the left side of the finisher, disconnect one connector (callout 1).

Figure 5-795 Disconnect one connector



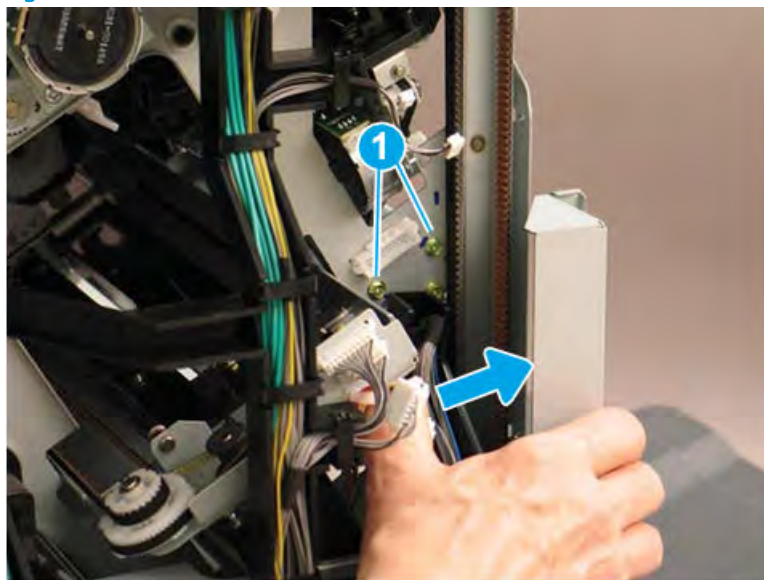
12. At the rear of the finisher, disconnect one connector (callout 1).

Figure 5-796 Disconnect one connector



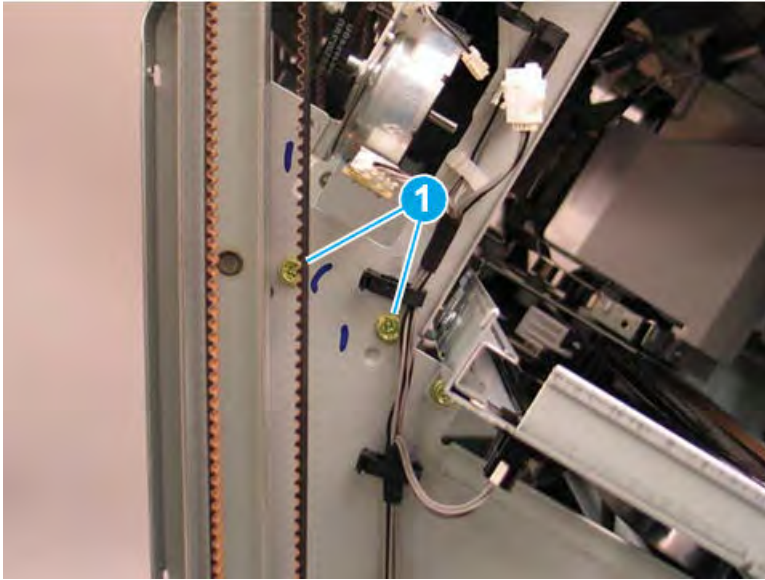
13. At the rear of the finisher, press the wire retainer to the right to access and remove two screws (callout 1).

Figure 5-797 Disconnect one connector



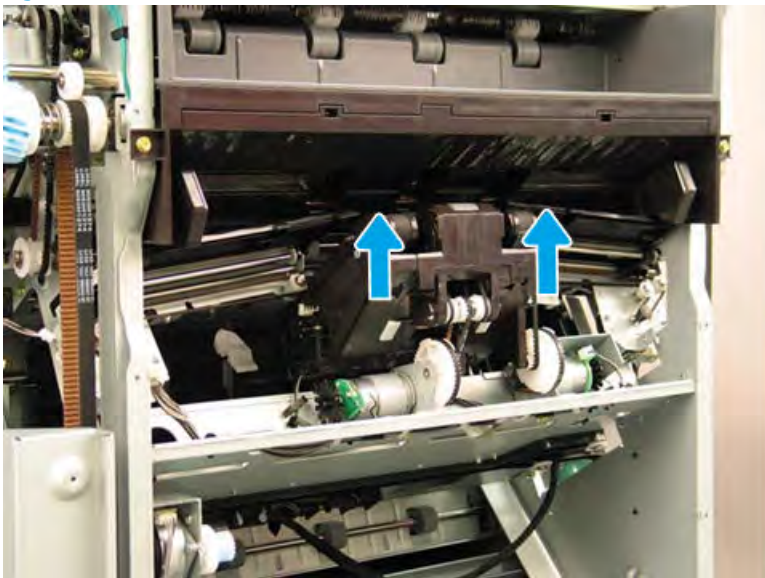
14. At the front of the finisher, remove two screws (callout 1).

Figure 5-798 Remove two screws



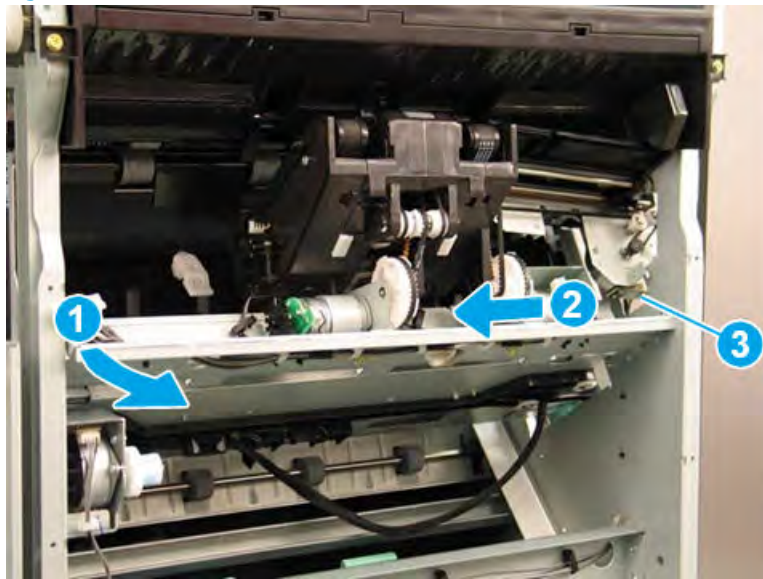
15. Lift the inside edges of the front and rear tampers up.

Figure 5-799 Lift the edges of the tampers



16. Rotate the rear edge of the ejector unit away from the finisher (callout 1), and then slide it toward the rear of the finisher (callout 2) to remove it. Make sure that the PCA (callout 3) stays clear of the sheet metal frame.

Figure 5-800 Remove the ejector unit

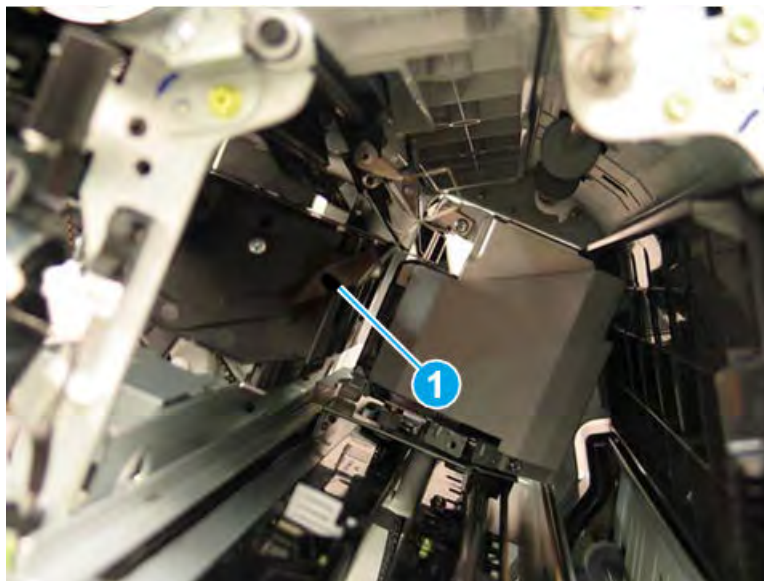


17. Reverse the removal steps to install the assembly. Also use the following special installation instructions.

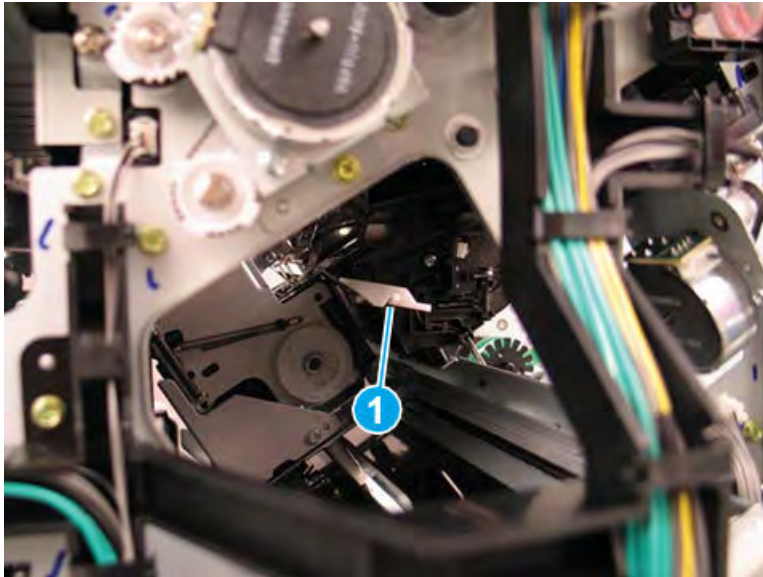
 **NOTE:** Continue to reverse the removal steps to finish installing the assembly.

#### Special installation instructions: Ejector unit

- a. When the front tamper shaft is removed, the retainer arm that held the one end of the shaft will drop down. When reinstalling the shaft, raise the retainer arm and position the end of the shaft in the notch (callout 1).



- b. When the rear tamper shaft is removed, the retainer arm that held the one end of the shaft will drop down. When reinstalling the shaft, raise the retainer arm and position the end of the shaft in the notch (callout 1).



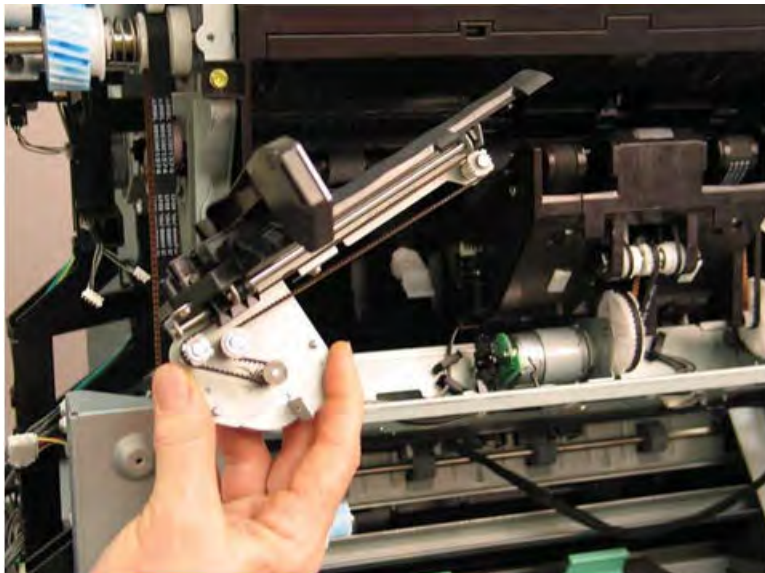
### Remove the rear tamper unit

Follow these steps to remove the rear tamper unit.

- ▲ Lift the rear tamper away from the finisher to remove it

 **NOTE:** Reverse the removal steps to install the assembly.

**Figure 5-801** Remove the rear tamper

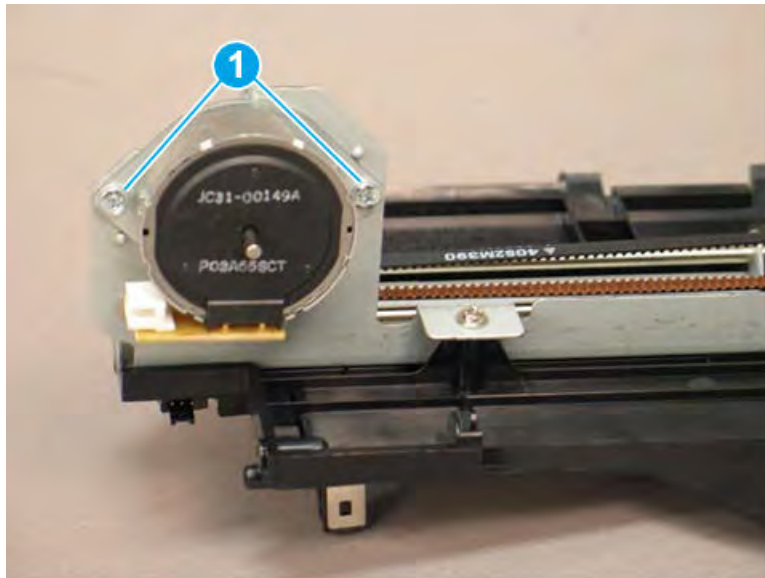


### Remove the rear tamper motor (M9)

Follow these steps to remove the rear tamper motor (M9).

1. Remove two screws (callout 1).

Figure 5-802 Remove two screws



2. Release the belt (callout 1), and then remove the rear tamper motor.

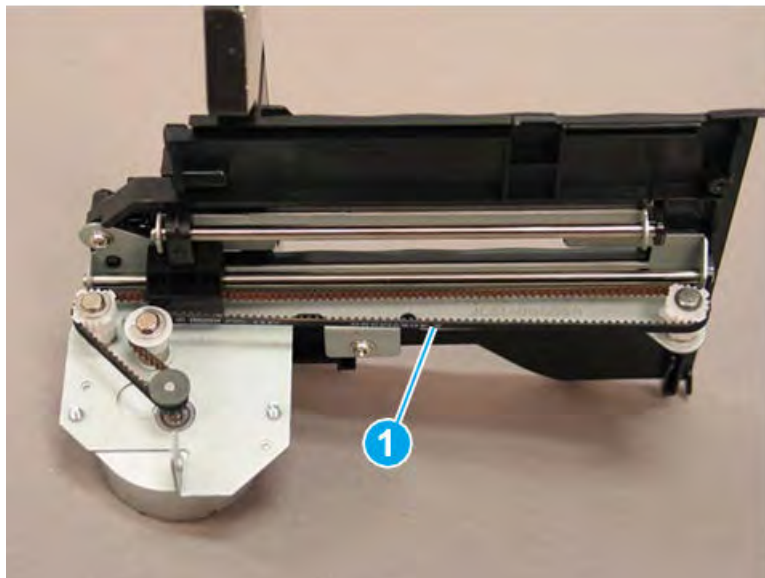
---

 **TIP:** Make sure that the belt is routed correctly when reinstalling the motor.

**TIP:** Reverse the removal steps to install the assembly.

---

Figure 5-803 Release the belt and remove the motor



### Unpack the replacement assembly

Follow these steps to unpack the replacement assembly.

1. Dispose of the defective part.



---


 **NOTE:** HP recommends responsible disposal of the defective part.


<http://www8.hp.com/us/en/hp-information/environment/product-recycling.html>

---

2. Unpack the replacement part from the packaging.


 **CAUTION:**  Some parts are sensitive to electrostatic discharge (ESD). Always perform service work at an ESD-protected workstation or mat. If an ESD workstation or mat is not available, touch the sheet-metal chassis to provide a static ground before touching an ESD-sensitive assembly. Protect the ESD-sensitive assemblies by placing them in ESD pouches when they are out of the printer.

 **IMPORTANT:** Make sure that all of the shipping materials (for example shipping tape) are removed from the replacement part prior to installation.

 **NOTE:** If the replacement part is a roller or pad, avoid touching the spongy part of it. Skin oils on the roller or pad can cause paper pickup and/or print-quality problems. HP recommends using disposable gloves when handling rollers or pads or washing your hands before touching rollers or pads.

---

3. To install an assembly, reverse the removal steps.

 **NOTE:** When applicable, special installation instructions are provided for an assembly at the end of the removal procedure. Always completely read the removal instructions and follow all special installation instructions.

---




## Stapler unit

## Removal and replacement: Stapler unit


Learn how to remove and replace the stapler unit.

### Introduction

This document provides the procedures to remove and replace the stapler unit on the finisher.

 **IMPORTANT:** When applicable, special installation instructions are provided for an assembly at the end of the removal procedure. Always completely read the removal instructions and follow all special installation instructions.

### Before performing service

- Turn the printer power off. A shutting-down message appears on the control-panel display.
-  **WARNING!** To avoid damage to the printer, turn the power off and wait until the printer shuts down before removing the power cable.
- Disconnect the printer power cable after the printer has completely shut down (the control-panel display is blank).
- Release the finisher from the printer by pulling out on the release latch inside the finisher door.
- Disconnect the cable from the bridge unit to the finisher.
- Disconnect the cable from the finisher to the printer.

Use the table below to identify the correct part number for your printer. To order the part, go to <https://parts.hp.com>.

Table 5-119 Part information

Part number	Part description
JC82-00894A	Stapler unit

### Required tools

- #2 JIS screwdriver with a magnetic tip

### After performing service

- Connect the cable from the finisher to the printer.
- Connect the cable from the bridge unit to the finisher.
- Attach the finisher to the printer, and then push in on the release latch inside the finisher door.
- Connect the printer power cable.
- Turn the printer power on.

### Post service test

Process a job through the finisher and verify that the finisher works correctly.

### Remove the right upper cover (finisher)

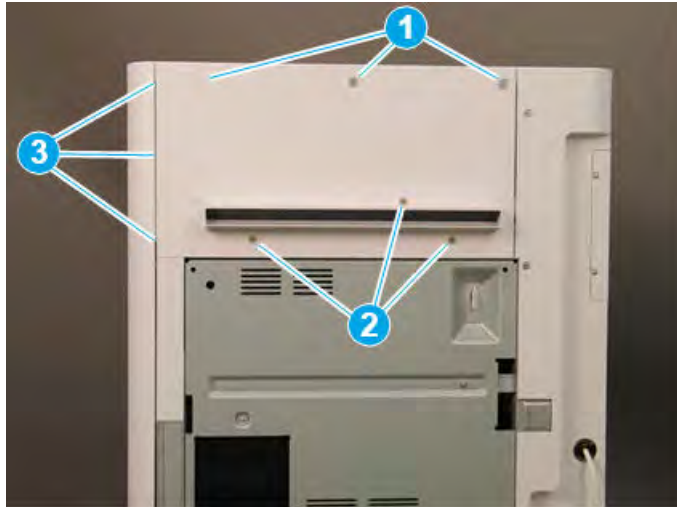
Follow these steps to remove the right upper cover (finisher).

- ▲ Remove one screw cap and three machine screws on the upper edge of the cover (callout 1). Remove three sheet metal screws (callout 2) on the lower portion of the cover. Rotate the right edge of the cover away from the finisher, and then slide the cover right to release three tabs (callout 3).

💡 **TIP:** The lower screws are shorter in length than the upper screws.

**TIP:** Reverse the removal steps to install the assembly.

Figure 5-804 Remove the right upper cover

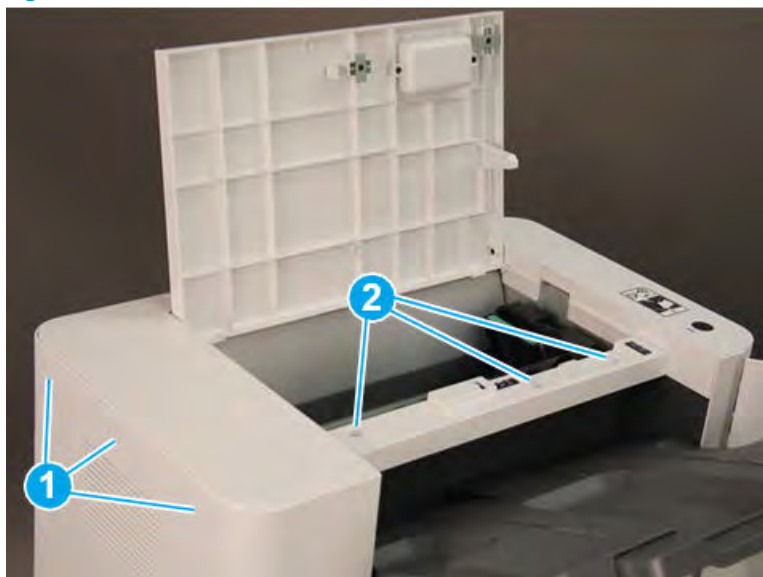


### Remove the top cover (finisher)

Follow these steps to remove the top cover (finisher).

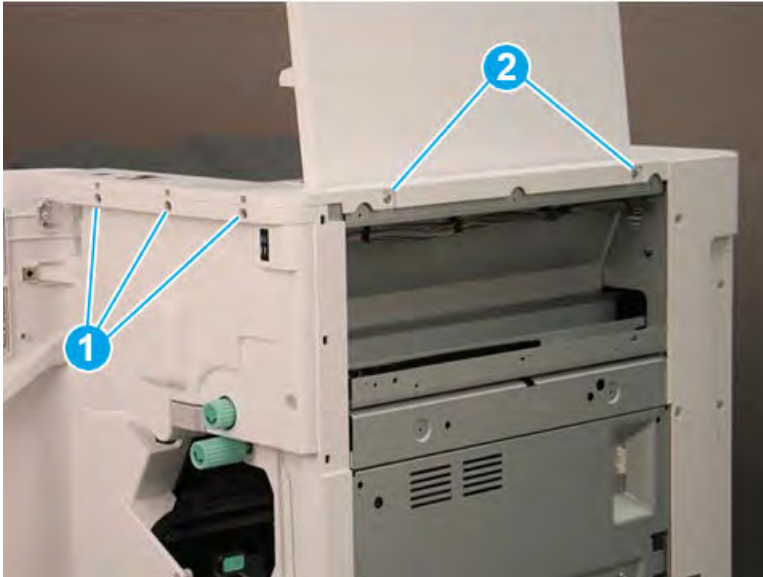
1. Remove three screw caps and three self-tapping screws at the top of the rear cover (callout 1), and then remove three machine screws (callout 2) on top of the cover.

Figure 5-805 Remove six screws




2. Remove three self-tapping screws at the top of the front cover (callout 1), and then remove two machine screws (callout 2) at the top of the right side.

Figure 5-806 Remove five screws



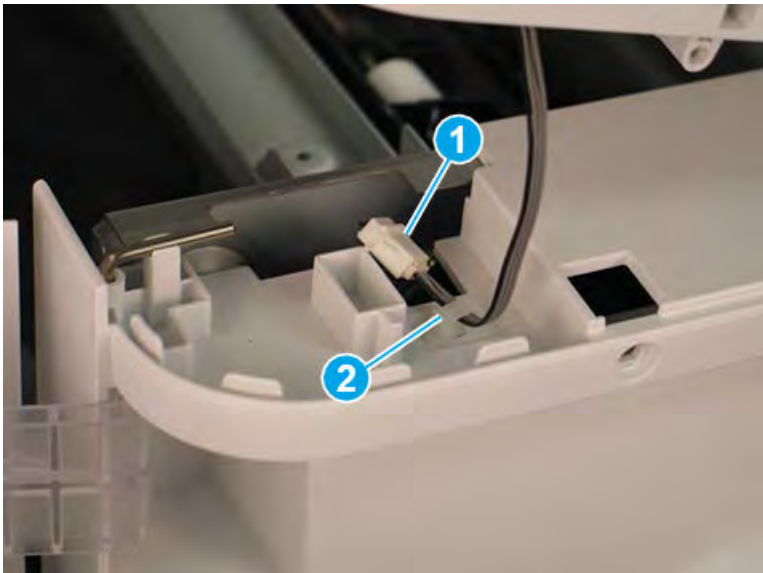
3. Lift the cover up slightly. Disconnect one in-line connector (callout 1), and then release one retainer (callout 2).

---

 **TIP:** Reverse the removal steps to install the assembly.

---

Figure 5-807 Disconnect one connector and release retainer

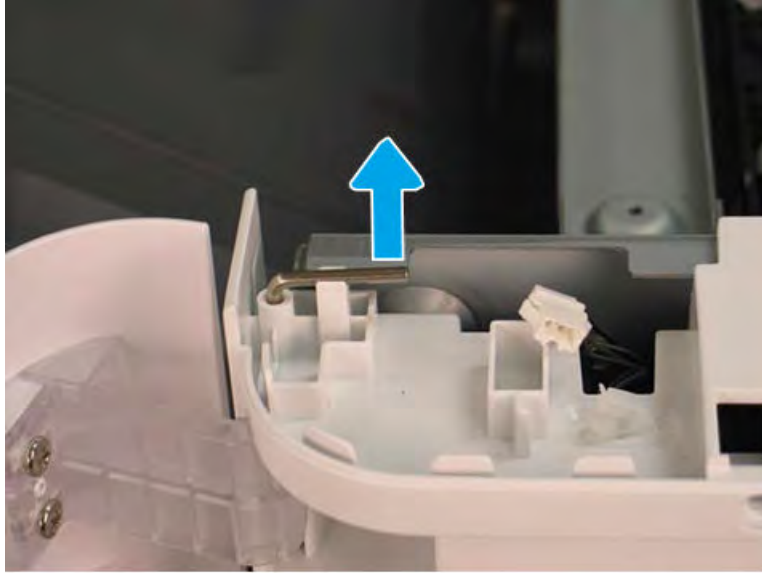


### Remove the front door (finisher)

Follow these steps to remove the front door (finisher).

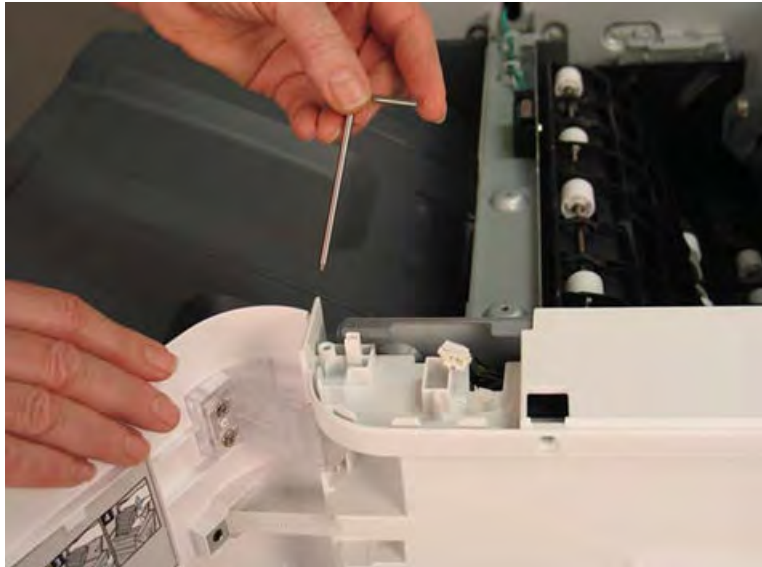
1. Lift the top hinge pin up to release it from the retainer.

Figure 5-808 Lift the top hinge pin



2. Pull the top hinge pin up to remove it.

Figure 5-809 Remove the top hinge pin



3. Use a small, flat-blade screwdriver to release the lower hinge pin from the retainer, and then rotate it away from the finisher.

**Figure 5-810** Release the lower hinge pin




4. Support the door with one hand, and then pull the lower hinge pin straight up to remove it.

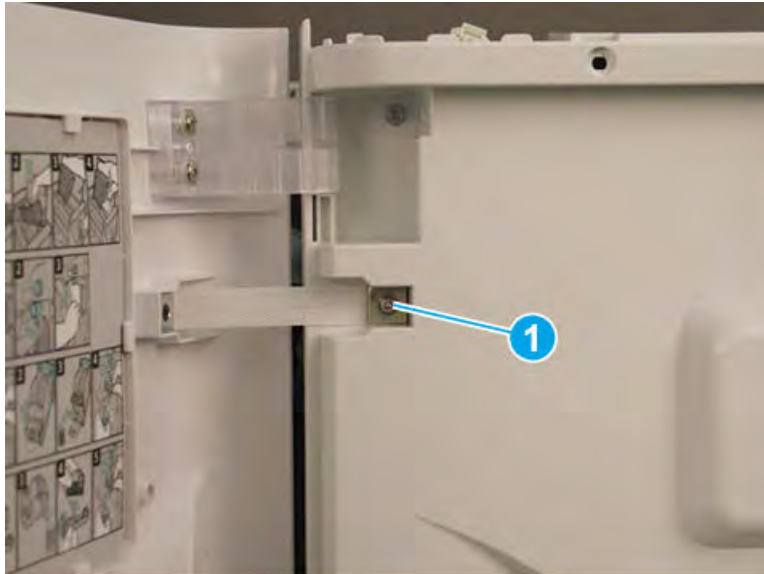
**Figure 5-811** Remove the lower hinge pin



5. Support the door with one hand, and then remove one screw (callout 1) to release the strap. Remove the front door.

 **TIP:** Reverse the removal steps to install the assembly.

**Figure 5-812** Remove the front door

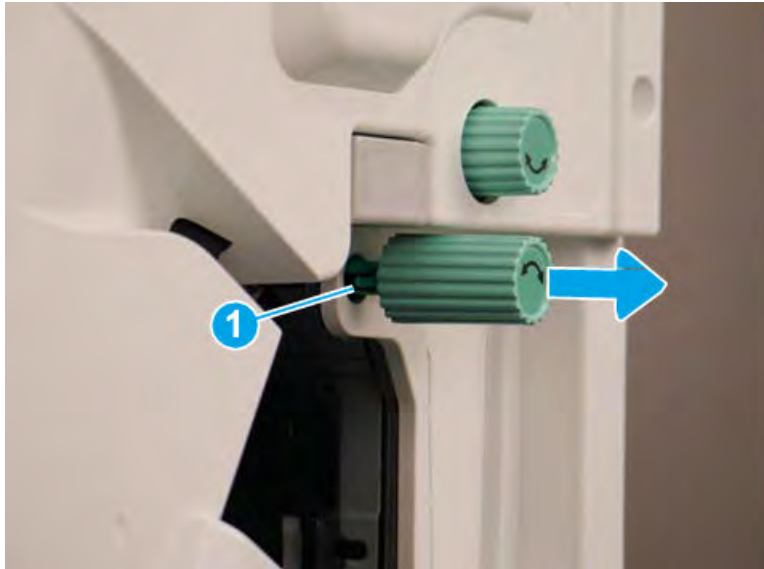


#### Remove the front cover (finisher)

Follow these steps to remove the front cover (finisher).

1. Release one tab (callout 1), and then pull the jam-access knob away from the finisher to remove it.

**Figure 5-813** Remove the jam-access knob



2. If the punch unit is installed, remove the punch waste bin (callout 1).


3. Remove one screw (callout 1) on top of the front cover.

Figure 5-814 Remove one screw



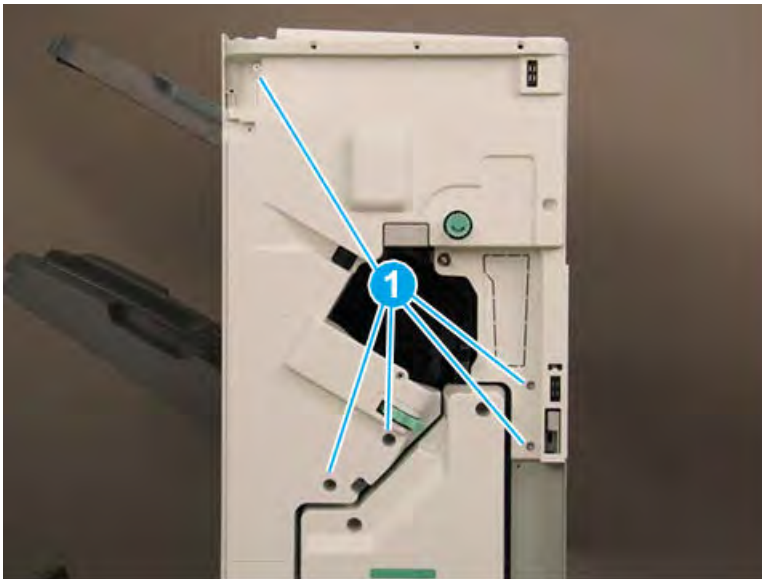
4. Remove five machine screws (callout 1), and then remove the front cover.

---

 **TIP:** Reverse the removal steps to install the assembly.

---

Figure 5-815 Remove the front cover



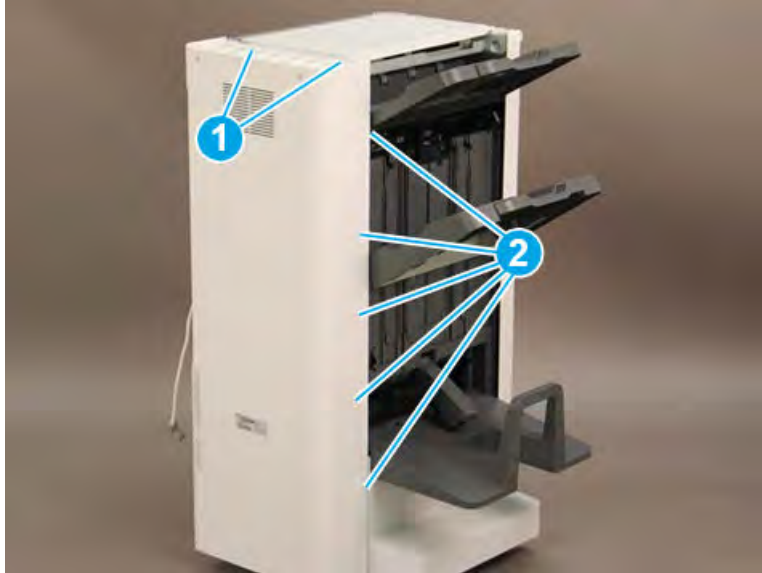
### Remove the rear cover (finisher)

Follow these steps to remove the rear cover (finisher).

1. Remove two self-tapping screws (callout 1) on the top of the rear cover, and then remove five screw caps and five machine screws (callout 2) on the left side of the cover.



Figure 5-816 Remove seven screws

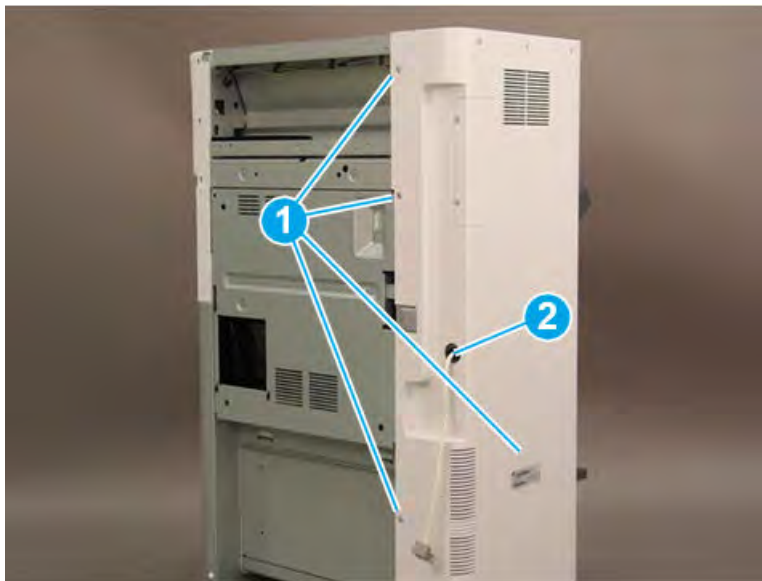


2. Remove one screw cap and four machine screws (callout 1) Remove the rear cover.

 **NOTE:** Make sure to thread the power cable (callout 2) through the opening in the cover.

 **TIP:** Reverse the removal steps to install the assembly

Figure 5-817 Remove the rear cover

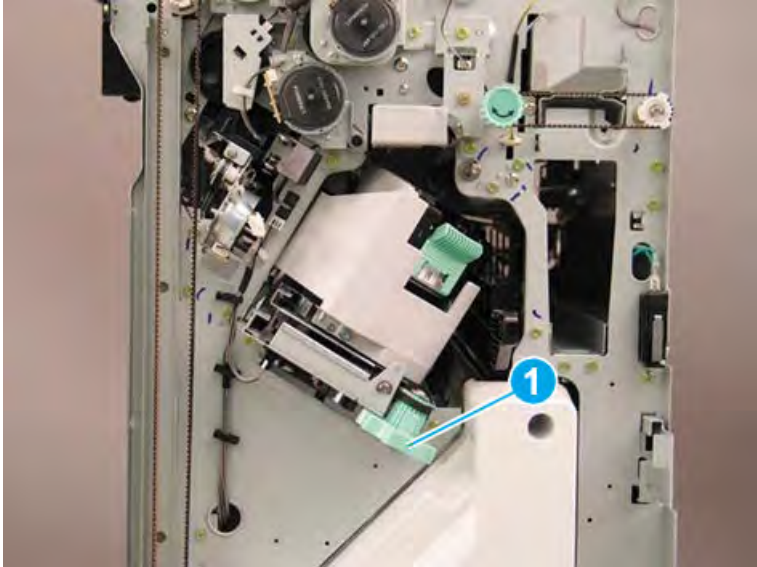


### Remove the stapler unit

Follow these steps to remove the stapler unit.

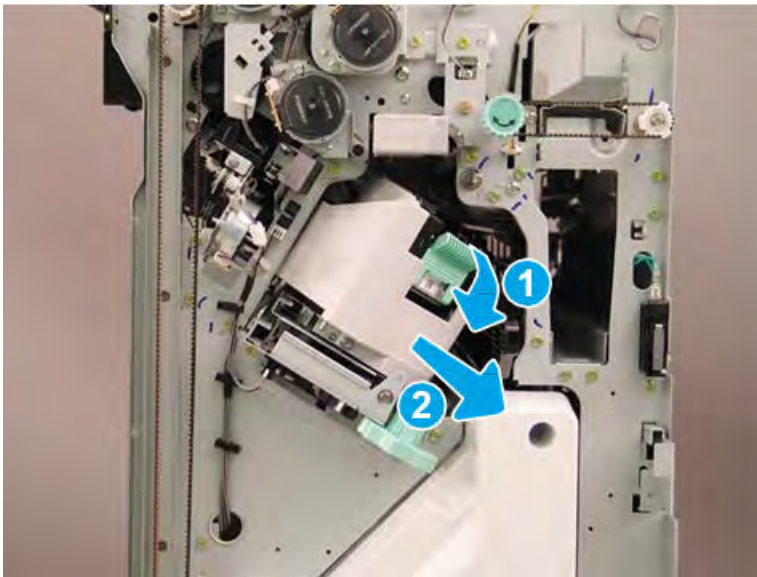
1. Rotate the green wheel to move the staple unit to the front until it stops.

Figure 5-818 Move the staple unit to the front



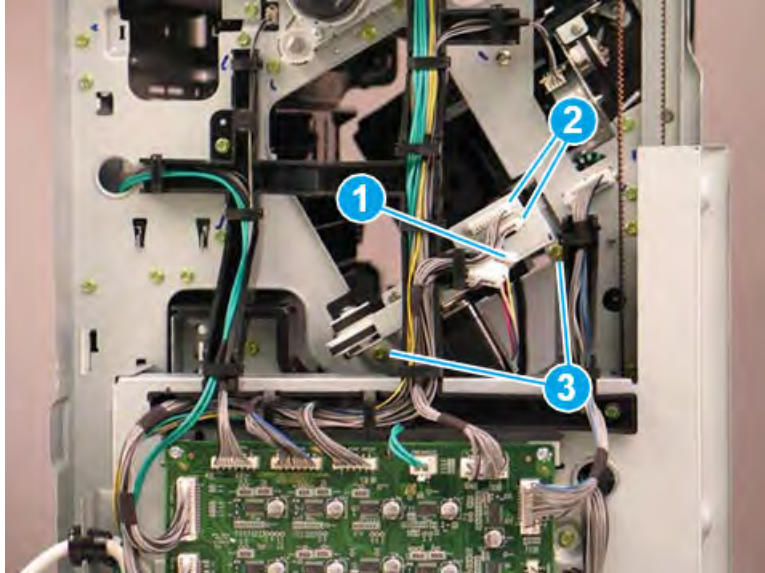
2. Lower the green latch (callout 1), and then slide the staple cartridge away from the finisher to remove it (callout 2).

Figure 5-819 Remove the staple cartridge



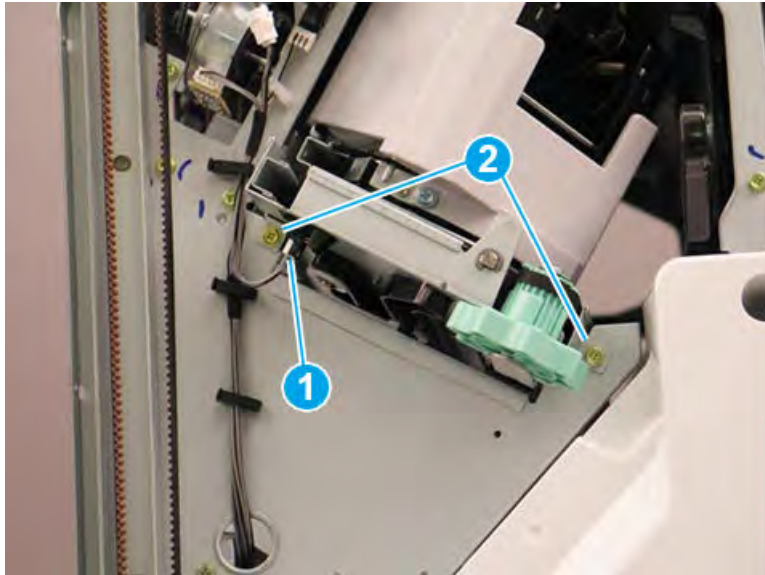
3. At the back of the finisher, release one retainer (callout 1), disconnect two connectors (callout 2), and then remove two screws (callout 3).

Figure 5-820 Disconnect three connectors and remove two screws




4. At the front of the finisher, disconnect one connector (callout 1), and then remove two screws (callout 2).

Figure 5-821 Disconnect one connector and remove two screws



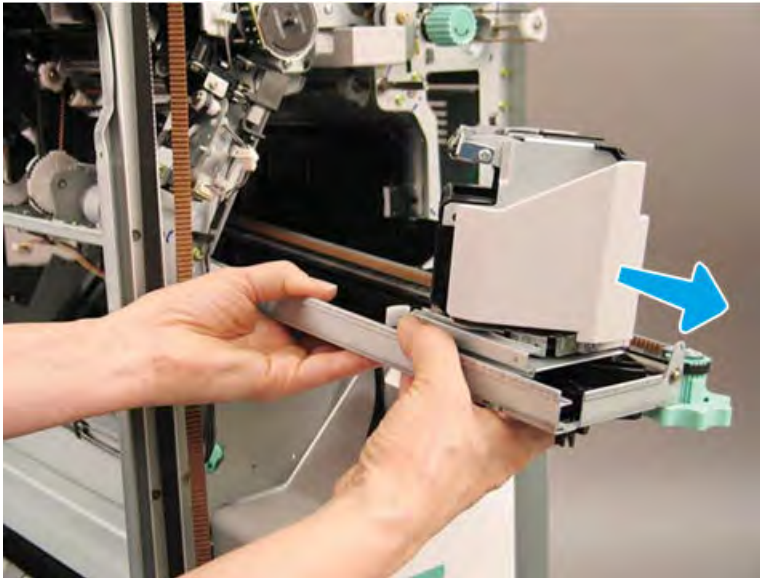
5. Lift up, and then slide the staple unit to the front of the finisher to remove it.

---

 **TIP:** Reverse the removal steps to install the assembly.

---

**Figure 5-822** Remove the staple unit



### Unpack the replacement assembly

Follow these steps to unpack the replacement assembly.

1. Dispose of the defective part.

---



 **NOTE:** HP recommends responsible disposal of the defective part.

<http://www8.hp.com/us/en/hp-information/environment/product-recycling.html>


---

2. Unpack the replacement part from the packaging.

---

 **CAUTION:**  Some parts are sensitive to electrostatic discharge (ESD). Always perform service work at an ESD-protected workstation or mat. If an ESD workstation or mat is not available, touch the sheet-metal chassis to provide a static ground before touching an ESD-sensitive assembly. Protect the ESD-sensitive assemblies by placing them in ESD pouches when they are out of the printer.


 **IMPORTANT:** Make sure that all of the shipping materials (for example shipping tape) are removed from the replacement part prior to installation.

 **NOTE:** If the replacement part is a roller or pad, avoid touching the spongy part of it. Skin oils on the roller or pad can cause paper pickup and/or print-quality problems. HP recommends using disposable gloves when handling rollers or pads or washing your hands before touching rollers or pads.

---

3. To install an assembly, reverse the removal steps.

---

 **NOTE:** When applicable, special installation instructions are provided for an assembly at the end of the removal procedure. Always completely read the removal instructions and follow all special installation instructions.

---

## Removal and replacement: Stapler front sensor (S21)

Learn how to remove and replace the stapler front sensor.

### Introduction

This document provides the procedures to remove and replace the stapler front sensor on the finisher.



**IMPORTANT:** When applicable, special installation instructions are provided for an assembly at the end of the removal procedure. Always completely read the removal instructions and follow all special installation instructions.

### Before performing service

- Turn the printer power off. A shutting-down message appears on the control-panel display.
- ⚠ **WARNING!** To avoid damage to the printer, turn the power off and wait until the printer shuts down before removing the power cable.
- Disconnect the printer power cable after the printer has completely shut down (the control-panel display is blank).
- Release the finisher from the printer by pulling out on the release latch inside the finisher door.
- Disconnect the cable from the bridge unit to the finisher.
- Disconnect the cable from the finisher to the printer.

Use the table below to identify the correct part number for your printer. To order the part, go to <https://parts.hp.com>.

**Table 5-120 Part information**

Part number	Part description
0604-001393	Stapler front sensor

### Required tools

- #2 JIS screwdriver with a magnetic tip

### After performing service

- Connect the cable from the finisher to the printer.
- Connect the cable from the bridge unit to the finisher.
- Attach the finisher to the printer, and then push in on the release latch inside the finisher door.
- Connect the printer power cable.
- Turn the printer power on.

### Post service test

Process a job through the finisher and verify that the finisher works correctly.

### Remove the right upper cover (finisher)

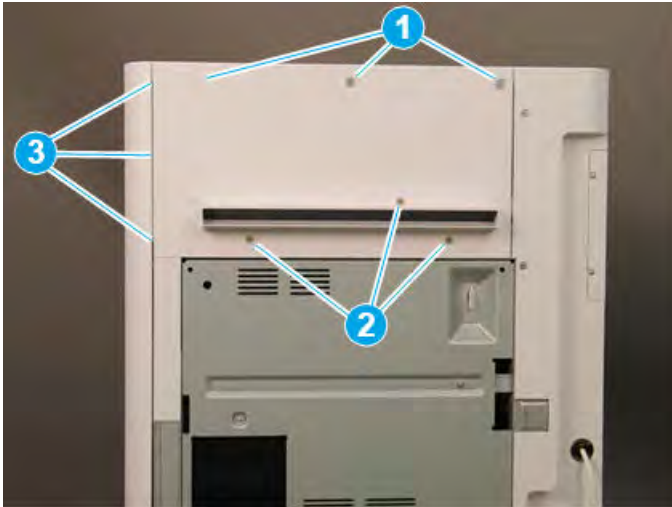
Follow these steps to remove the right upper cover (finisher).

- ▲ Remove one screw cap and three machine screws on the upper edge of the cover (callout 1). Remove three sheet metal screws (callout 2) on the lower portion of the cover. Rotate the right edge of the cover away from the finisher, and then slide the cover right to release three tabs (callout 3).

💡 **TIP:** The lower screws are shorter in length than the upper screws.

**TIP:** Reverse the removal steps to install the assembly.

**Figure 5-823** Remove the right upper cover

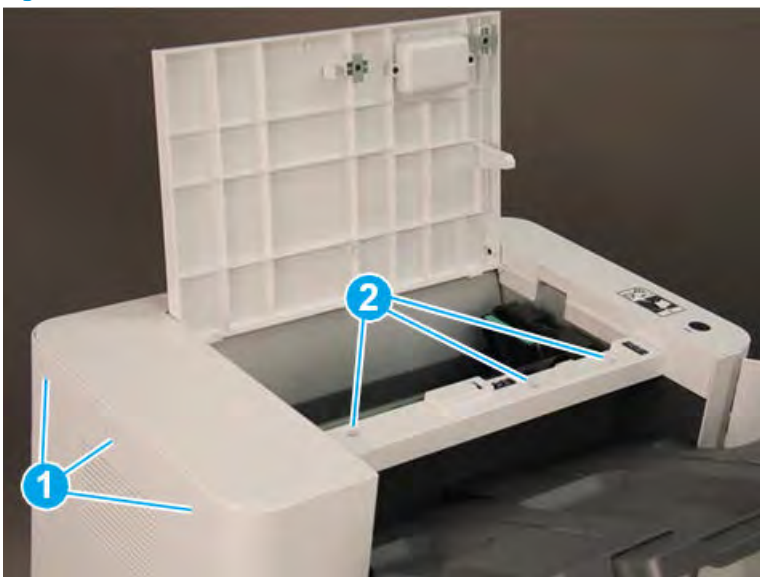


### Remove the top cover (finisher)

Follow these steps to remove the top cover (finisher).

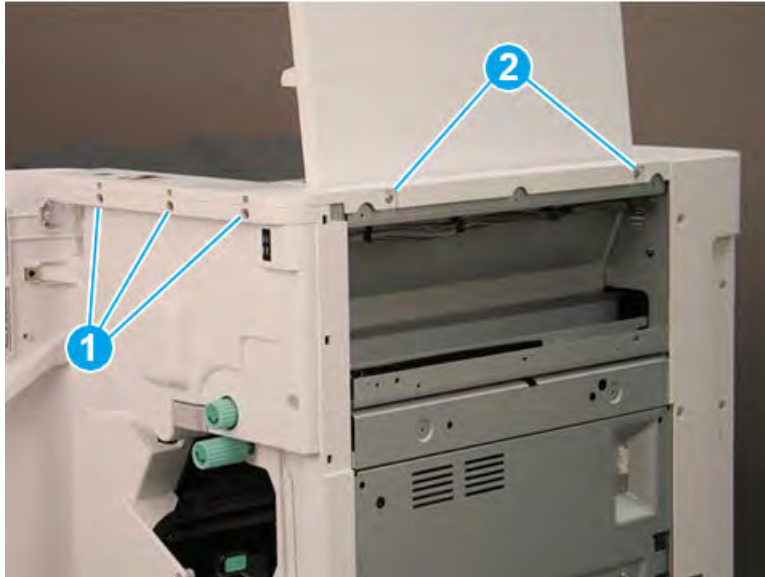
1. Remove three screw caps and three self-tapping screws at the top of the rear cover (callout 1), and then remove three machine screws (callout 2) on top of the cover.

**Figure 5-824** Remove six screws



2. Remove three self-tapping screws at the top of the front cover (callout 1), and then remove two machine screws (callout 2) at the top of the right side.

Figure 5-825 Remove five screws



3. Lift the cover up slightly. Disconnect one in-line connector (callout 1), and then release one retainer (callout 2).


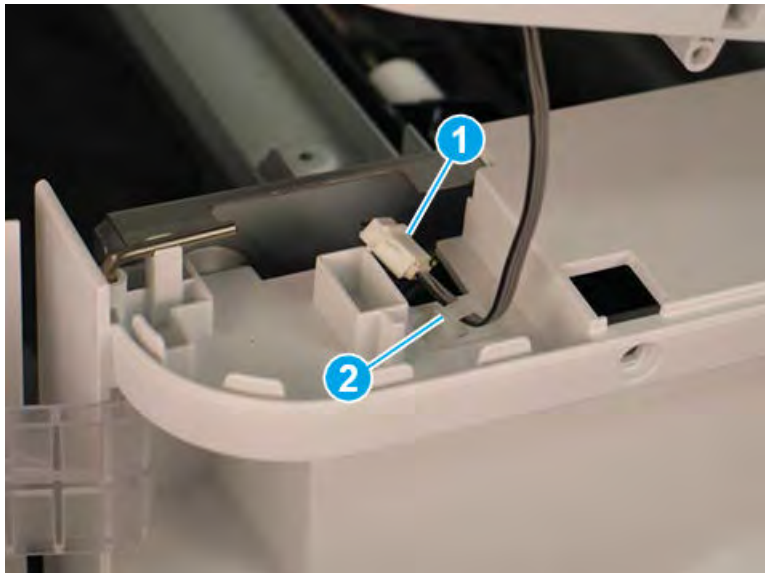
 **TIP:** Reverse the removal steps to install the assembly.

Figure 5-826 Disconnect one connector and release retainer

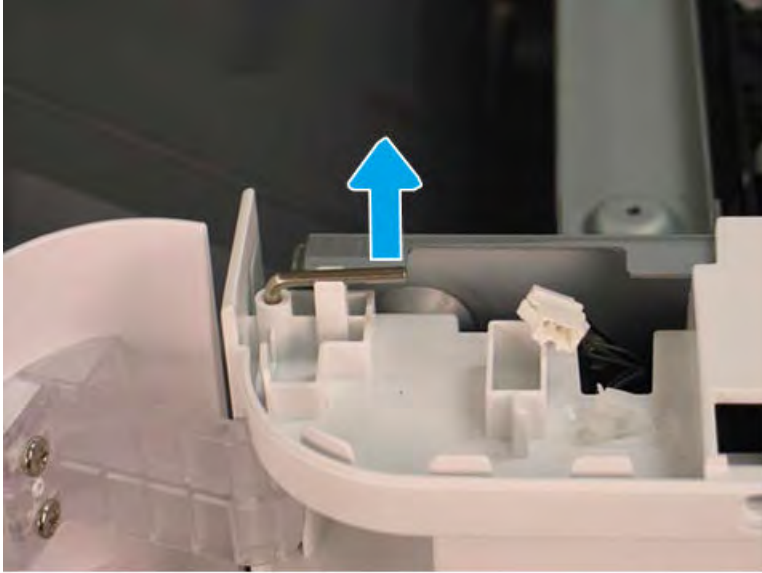


### Remove the front door (finisher)

Follow these steps to remove the front door (finisher).

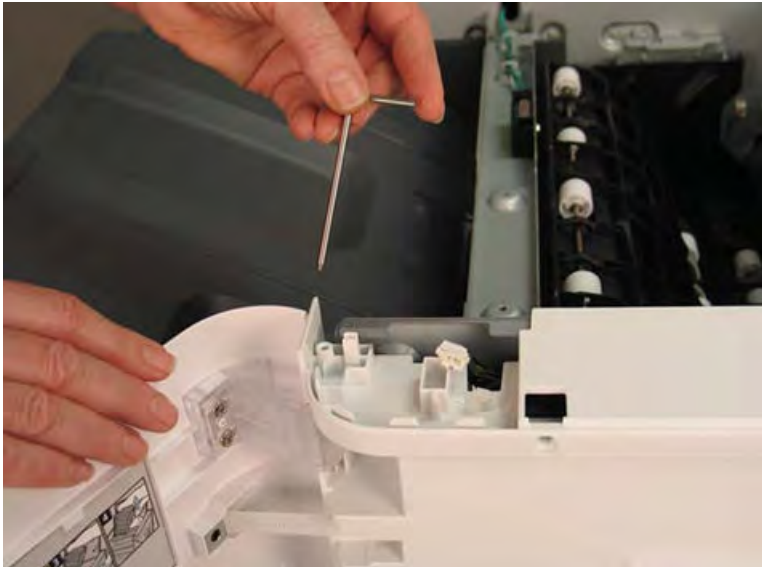
1. Lift the top hinge pin up to release it from the retainer.

Figure 5-827 Lift the top hinge pin



2. Pull the top hinge pin up to remove it.

Figure 5-828 Remove the top hinge pin





3. Use a small, flat-blade screwdriver to release the lower hinge pin from the retainer, and then rotate it away from the finisher.

Figure 5-829 Release the lower hinge pin




4. Support the door with one hand, and then pull the lower hinge pin straight up to remove it.

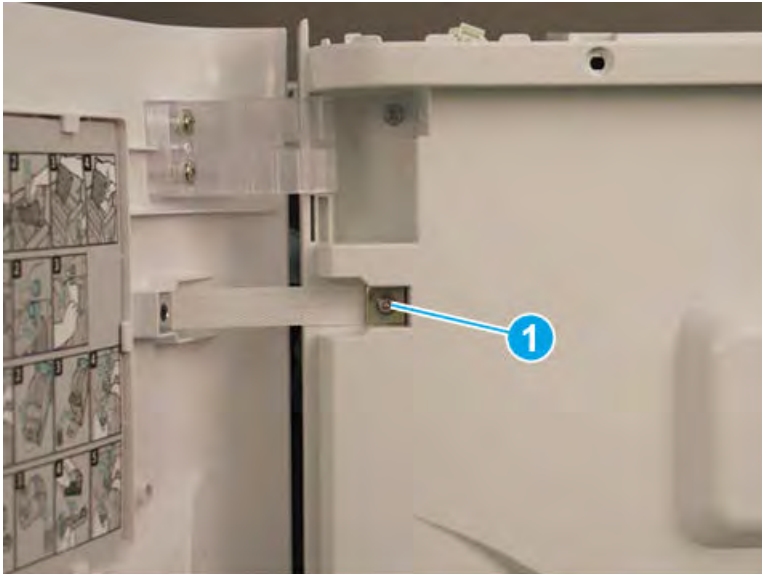
Figure 5-830 Remove the lower hinge pin



5. Support the door with one hand, and then remove one screw (callout 1) to release the strap. Remove the front door.

 **TIP:** Reverse the removal steps to install the assembly.

**Figure 5-831** Remove the front door

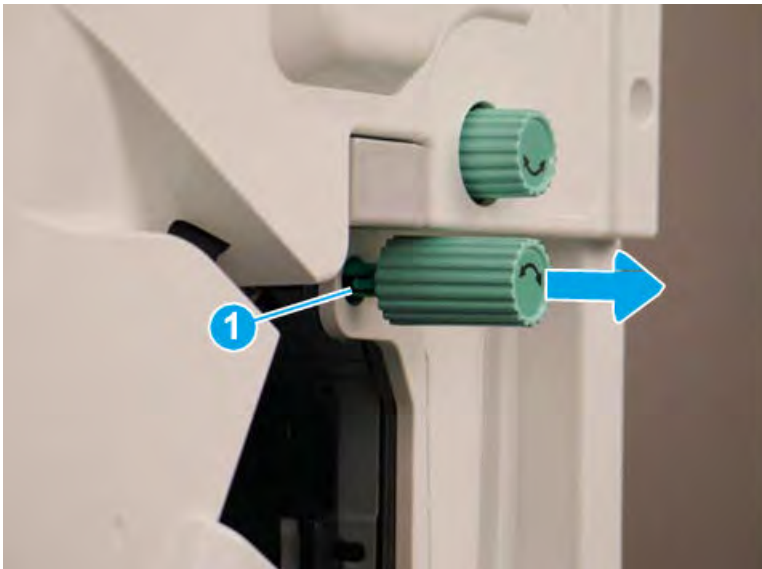


#### Remove the front cover (finisher)

Follow these steps to remove the front cover (finisher).

1. Release one tab (callout 1), and then pull the jam-access knob away from the finisher to remove it.

**Figure 5-832** Remove the jam-access knob



2. If the punch unit is installed, remove the punch waste bin (callout 1).

3. Remove one screw (callout 1) on top of the front cover.

Figure 5-833 Remove one screw



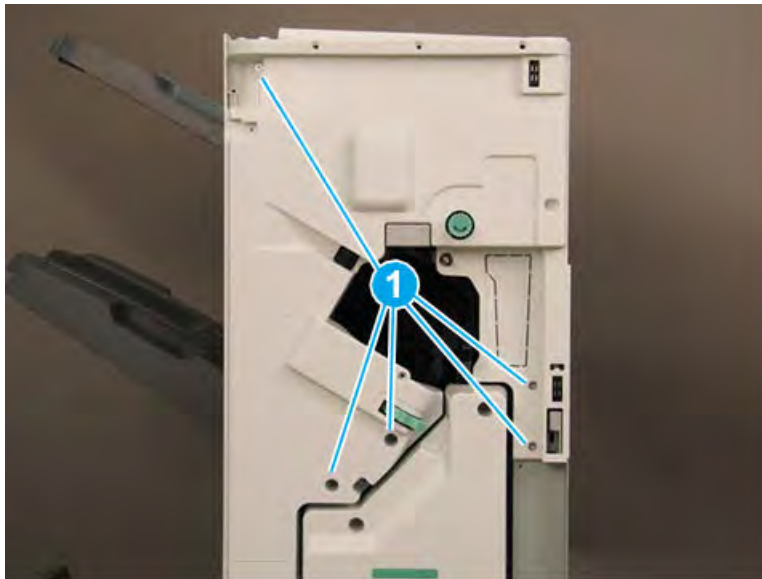
4. Remove five machine screws (callout 1), and then remove the front cover.

---

 **TIP:** Reverse the removal steps to install the assembly.

---

Figure 5-834 Remove the front cover

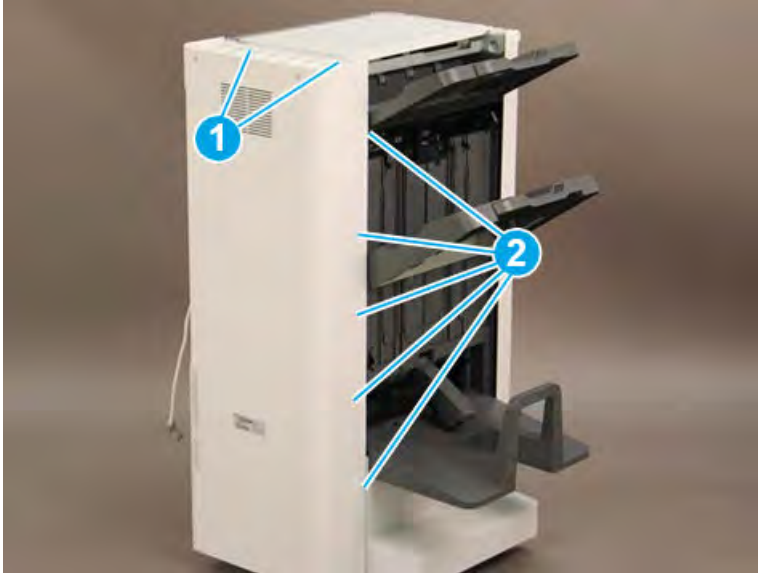


### Remove the rear cover (finisher)

Follow these steps to remove the rear cover (finisher).

1. Remove two self-tapping screws (callout 1) on the top of the rear cover, and then remove five screw caps and five machine screws (callout 2) on the left side of the cover.

Figure 5-835 Remove seven screws

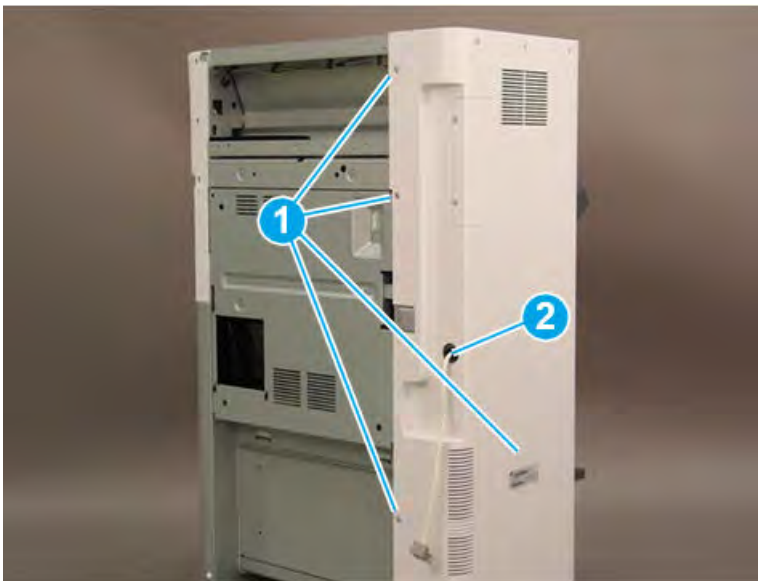


2. Remove one screw cap and four machine screws (callout 1) Remove the rear cover.

 **NOTE:** Make sure to thread the power cable (callout 2) through the opening in the cover.

 **TIP:** Reverse the removal steps to install the assembly

Figure 5-836 Remove the rear cover

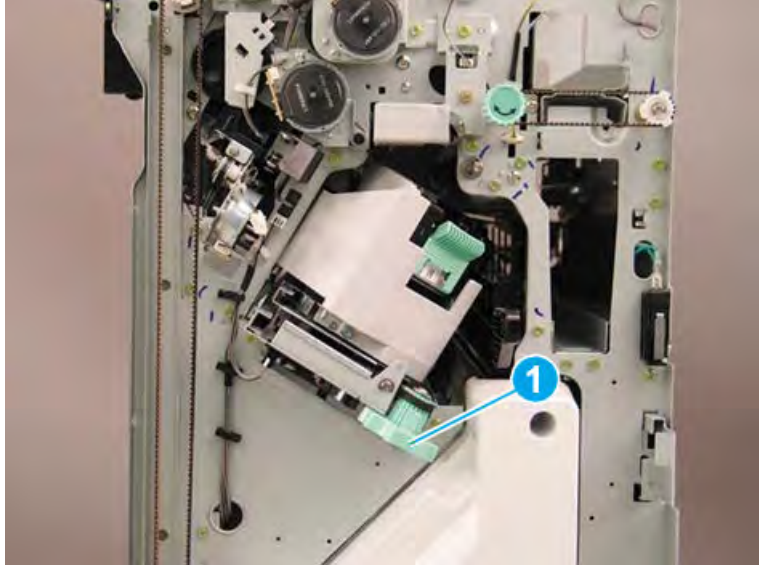


### Remove the stapler unit

Follow these steps to remove the stapler unit.

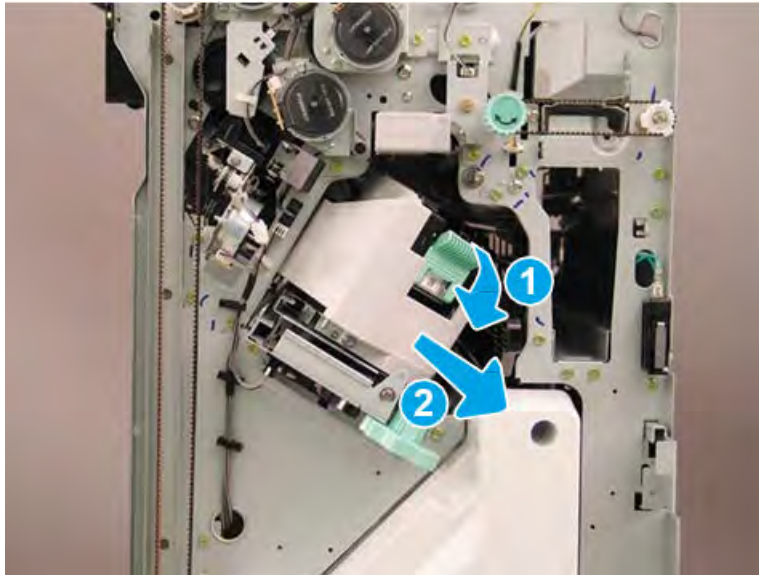
1. Rotate the green wheel to move the staple unit to the front until it stops.

Figure 5-837 Move the staple unit to the front



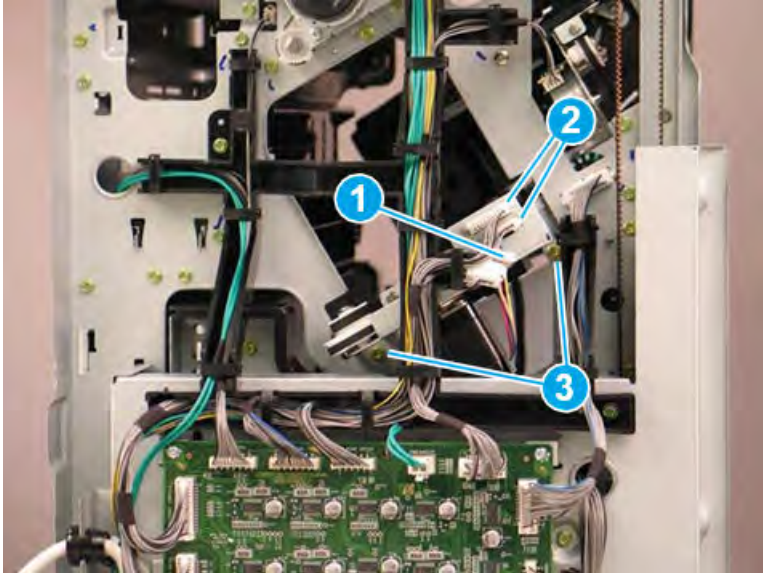
2. Lower the green latch (callout 1), and then slide the staple cartridge away from the finisher to remove it (callout 2).

Figure 5-838 Remove the staple cartridge



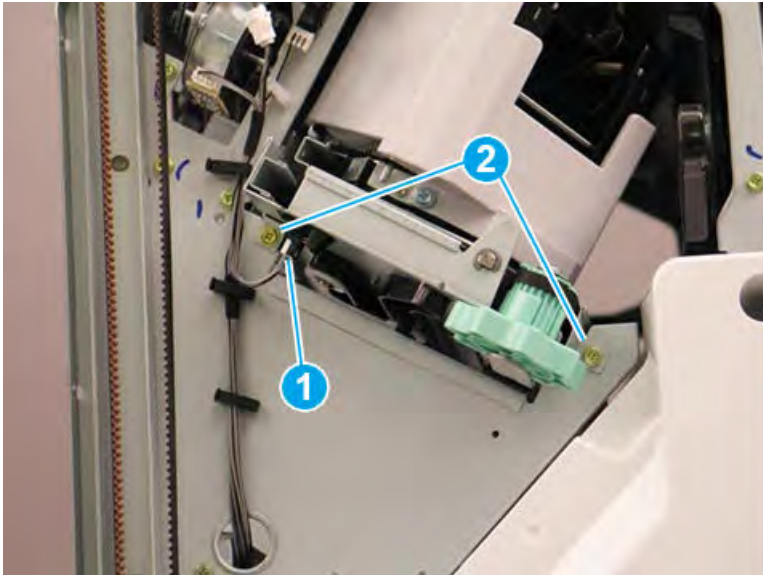
3. At the back of the finisher, release one retainer (callout 1), disconnect two connectors (callout 2), and then remove two screws (callout 3).

**Figure 5-839** Disconnect three connectors and remove two screws




4. At the front of the finisher, disconnect one connector (callout 1), and then remove two screws (callout 2).

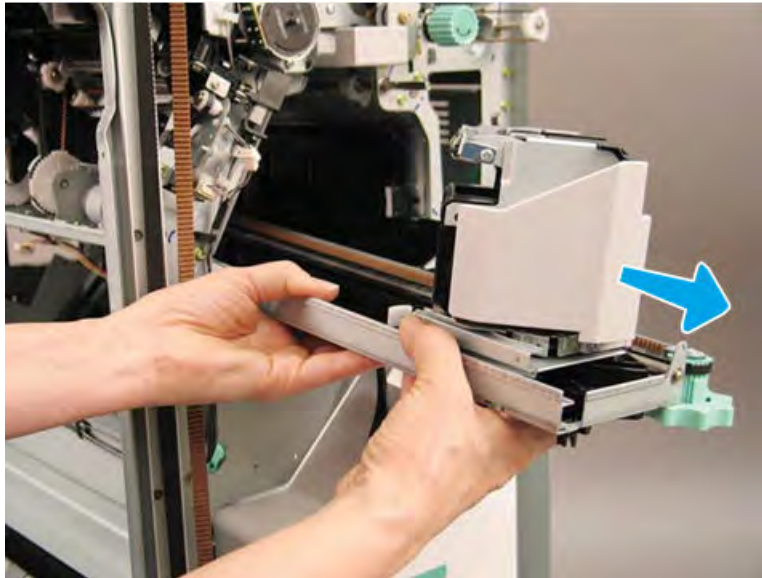
**Figure 5-840** Disconnect one connector and remove two screws



5. Lift up, and then slide the staple unit to the front of the finisher to remove it.

 **TIP:** Reverse the removal steps to install the assembly.

**Figure 5-841** Remove the staple unit

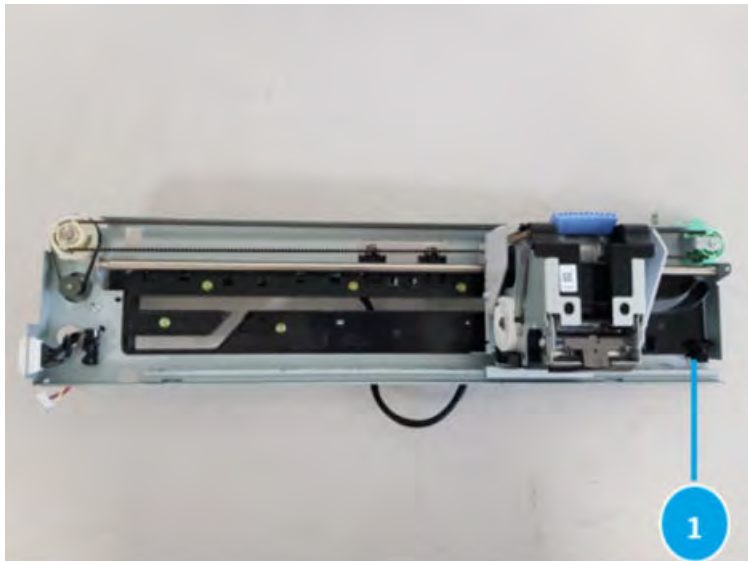


#### Remove the stapler front sensor(S21)

Follow these steps to remove the stapler front sensor(S21).

- ▲ Remove stapler front sensor from staple unit.

**Figure 5-842** Remove the stapler front sensor



#### Unpack the replacement assembly

Follow these steps to unpack the replacement assembly.

1. Dispose of the defective part.



---


 **NOTE:** HP recommends responsible disposal of the defective part.


<http://www8.hp.com/us/en/hp-information/environment/product-recycling.html>

---

2. Unpack the replacement part from the packaging.


 **CAUTION:**  Some parts are sensitive to electrostatic discharge (ESD). Always perform service work at an ESD-protected workstation or mat. If an ESD workstation or mat is not available, touch the sheet-metal chassis to provide a static ground before touching an ESD-sensitive assembly. Protect the ESD-sensitive assemblies by placing them in ESD pouches when they are out of the printer.

 **IMPORTANT:** Make sure that all of the shipping materials (for example shipping tape) are removed from the replacement part prior to installation.

 **NOTE:** If the replacement part is a roller or pad, avoid touching the spongy part of it. Skin oils on the roller or pad can cause paper pickup and/or print-quality problems. HP recommends using disposable gloves when handling rollers or pads or washing your hands before touching rollers or pads.

---

3. To install an assembly, reverse the removal steps.

 **NOTE:** When applicable, special installation instructions are provided for an assembly at the end of the removal procedure. Always completely read the removal instructions and follow all special installation instructions.

---



## Removal and replacement: Stapler mid-front sensor (S24)

Learn how to remove and replace the stapler mid-front sensor.

### Introduction

This document provides the procedures to remove and replace the stapler mid-front sensor on the finisher.



**IMPORTANT:** When applicable, special installation instructions are provided for an assembly at the end of the removal procedure. Always completely read the removal instructions and follow all special installation instructions.

### Before performing service

- Turn the printer power off. A shutting-down message appears on the control-panel display.
- ⚠ **WARNING!** To avoid damage to the printer, turn the power off and wait until the printer shuts down before removing the power cable.
- Disconnect the printer power cable after the printer has completely shut down (the control-panel display is blank).
- Release the finisher from the printer by pulling out on the release latch inside the finisher door.
- Disconnect the cable from the bridge unit to the finisher.
- Disconnect the cable from the finisher to the printer.

Use the table below to identify the correct part number for your printer. To order the part, go to <https://parts.hp.com>.

**Table 5-121 Part information**

Part number	Part description
0604-001393	Stapler mid-front sensor

### Required tools

- #2 JIS screwdriver with a magnetic tip

### After performing service

- Connect the cable from the finisher to the printer.
- Connect the cable from the bridge unit to the finisher.
- Attach the finisher to the printer, and then push in on the release latch inside the finisher door.
- Connect the printer power cable.
- Turn the printer power on.

### Post service test

Process a job through the finisher and verify that the finisher works correctly.

### Remove the right upper cover (finisher)

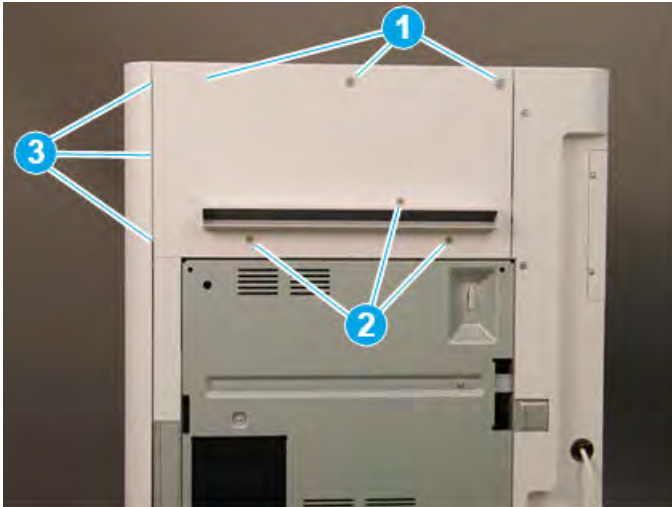
Follow these steps to remove the right upper cover (finisher).

- ▲ Remove one screw cap and three machine screws on the upper edge of the cover (callout 1). Remove three sheet metal screws (callout 2) on the lower portion of the cover. Rotate the right edge of the cover away from the finisher, and then slide the cover right to release three tabs (callout 3).

💡 **TIP:** The lower screws are shorter in length than the upper screws.

**TIP:** Reverse the removal steps to install the assembly.

**Figure 5-843** Remove the right upper cover

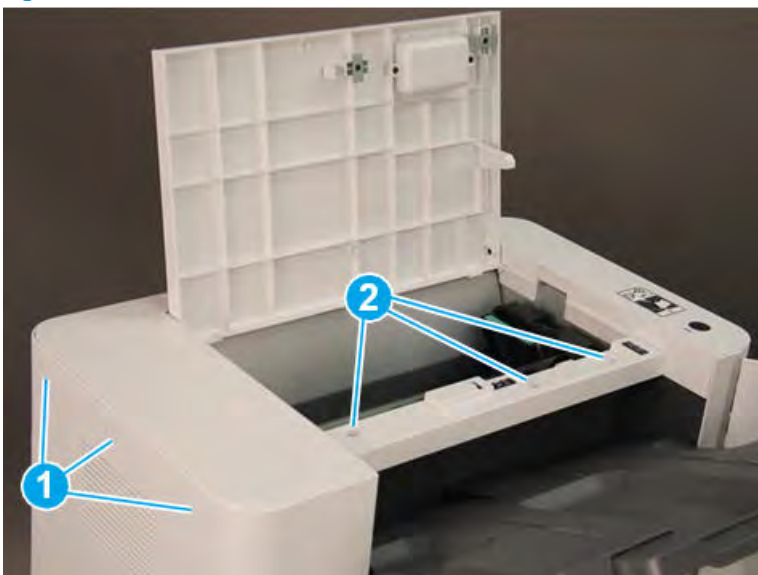


### Remove the top cover (finisher)

Follow these steps to remove the top cover (finisher).

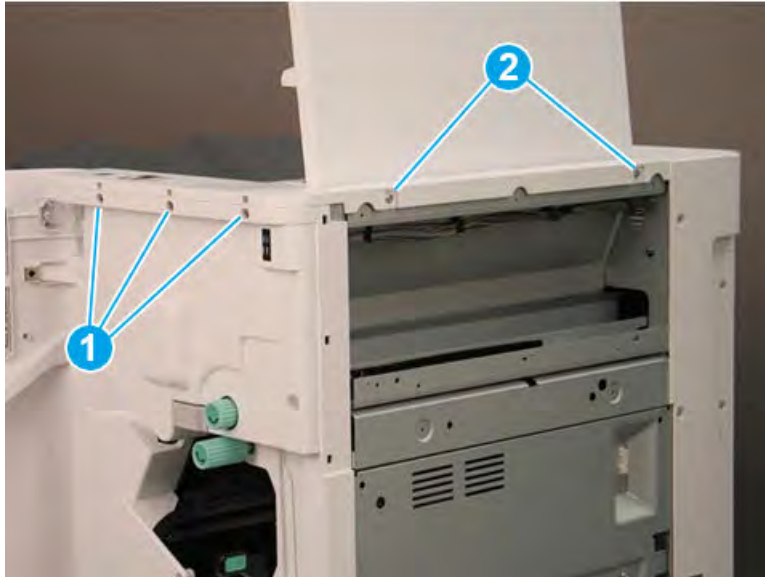
1. Remove three screw caps and three self-tapping screws at the top of the rear cover (callout 1), and then remove three machine screws (callout 2) on top of the cover.

**Figure 5-844** Remove six screws




2. Remove three self-tapping screws at the top of the front cover (callout 1), and then remove two machine screws (callout 2) at the top of the right side.

Figure 5-845 Remove five screws



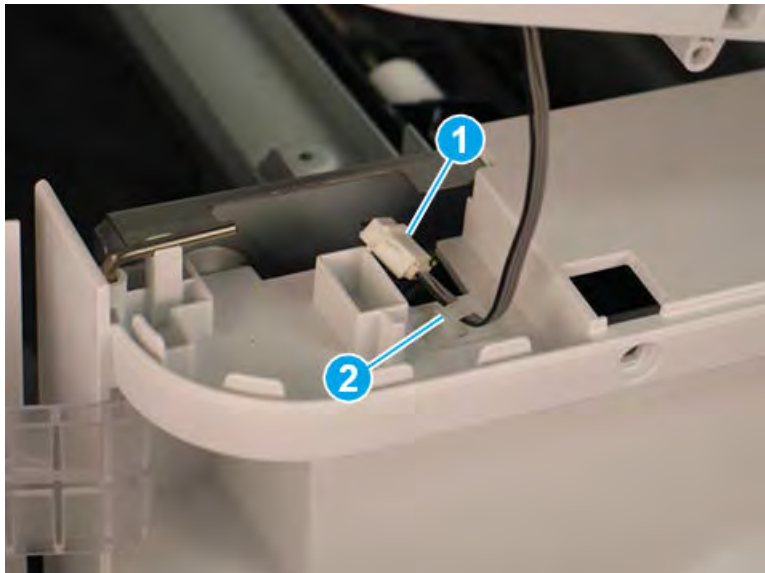
3. Lift the cover up slightly. Disconnect one in-line connector (callout 1), and then release one retainer (callout 2).

---

 **TIP:** Reverse the removal steps to install the assembly.

---

Figure 5-846 Disconnect one connector and release retainer

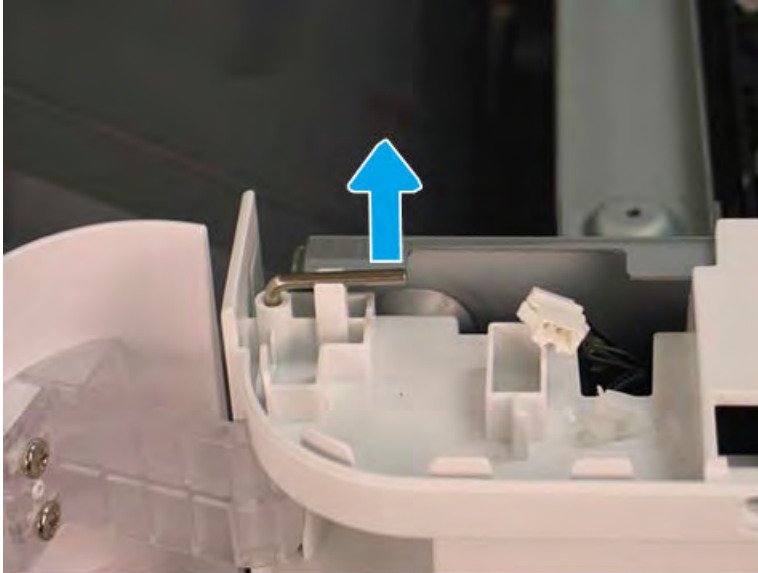


### Remove the front door (finisher)

Follow these steps to remove the front door (finisher).

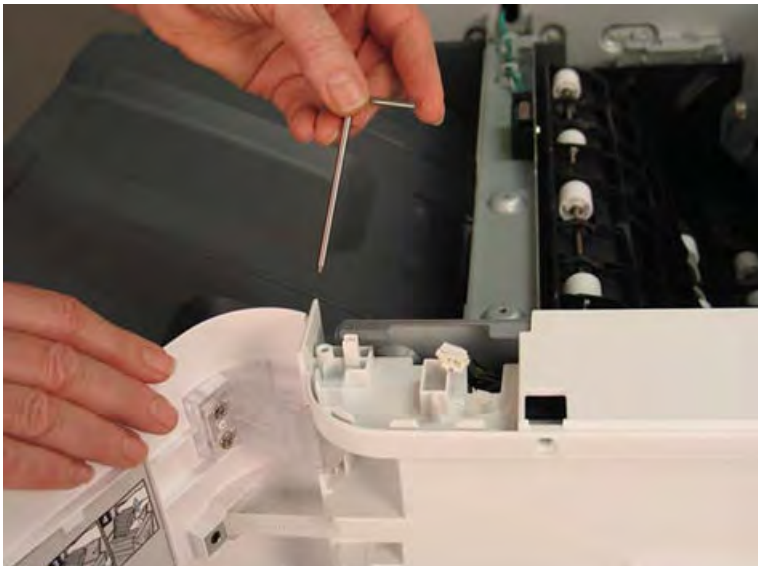
1. Lift the top hinge pin up to release it from the retainer.

Figure 5-847 Lift the top hinge pin



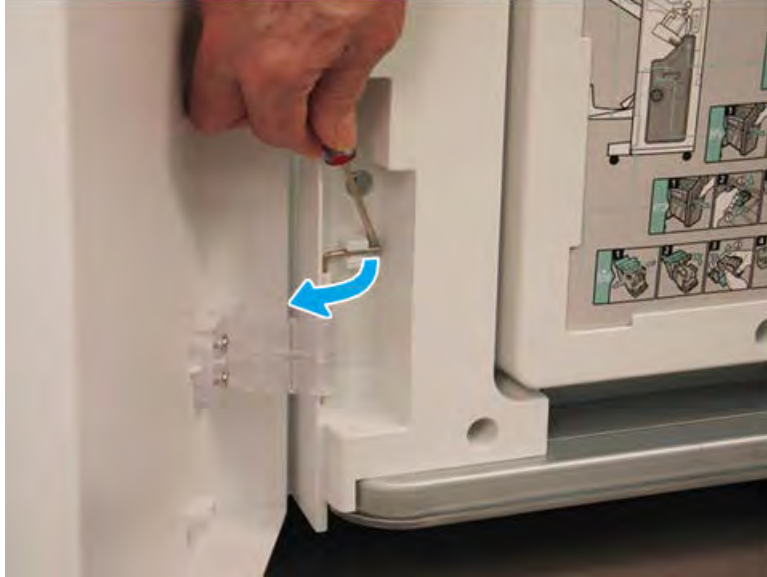
2. Pull the top hinge pin up to remove it.

Figure 5-848 Remove the top hinge pin



3. Use a small, flat-blade screwdriver to release the lower hinge pin from the retainer, and then rotate it away from the finisher.

Figure 5-849 Release the lower hinge pin




4. Support the door with one hand, and then pull the lower hinge pin straight up to remove it.

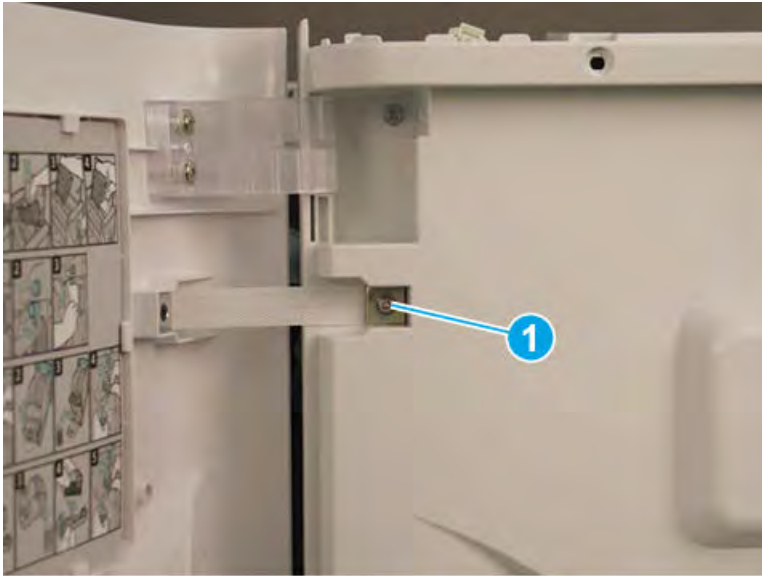
Figure 5-850 Remove the lower hinge pin



5. Support the door with one hand, and then remove one screw (callout 1) to release the strap. Remove the front door.

 **TIP:** Reverse the removal steps to install the assembly.

**Figure 5-851** Remove the front door

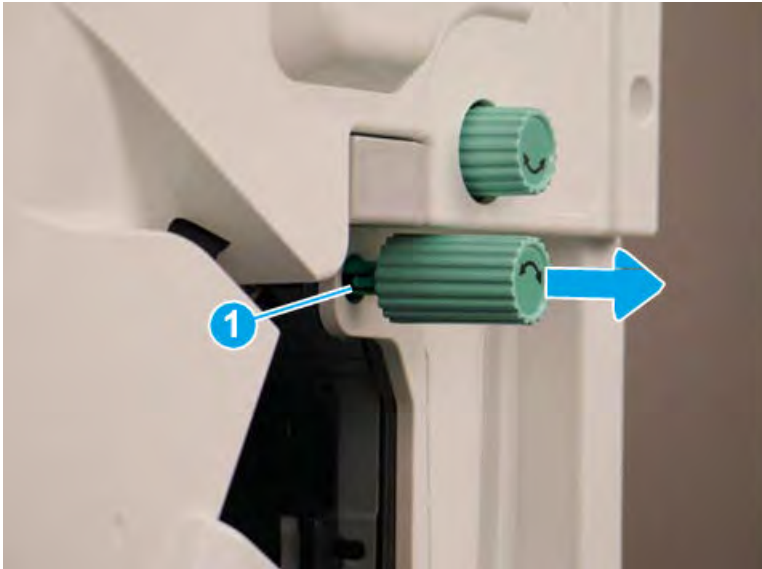


#### Remove the front cover (finisher)

Follow these steps to remove the front cover (finisher).

1. Release one tab (callout 1), and then pull the jam-access knob away from the finisher to remove it.

**Figure 5-852** Remove the jam-access knob



2. If the punch unit is installed, remove the punch waste bin (callout 1).


3. Remove one screw (callout 1) on top of the front cover.

Figure 5-853 Remove one screw



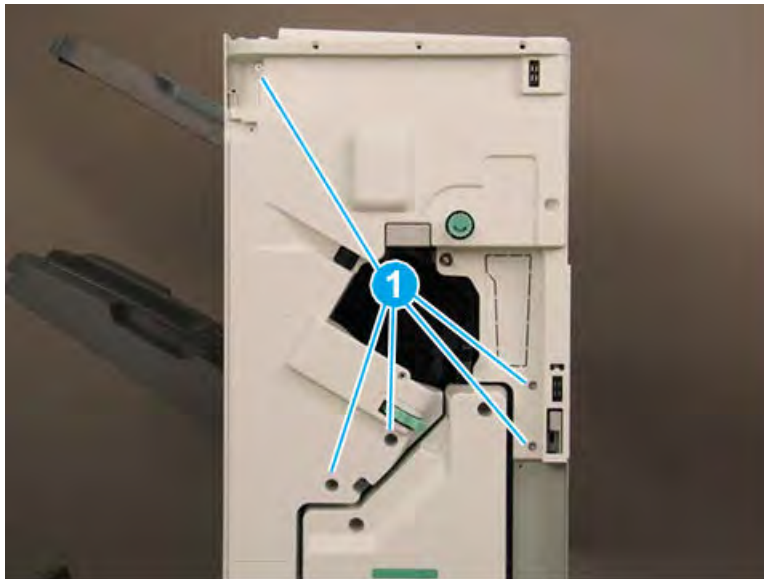
4. Remove five machine screws (callout 1), and then remove the front cover.

---

 **TIP:** Reverse the removal steps to install the assembly.

---

Figure 5-854 Remove the front cover

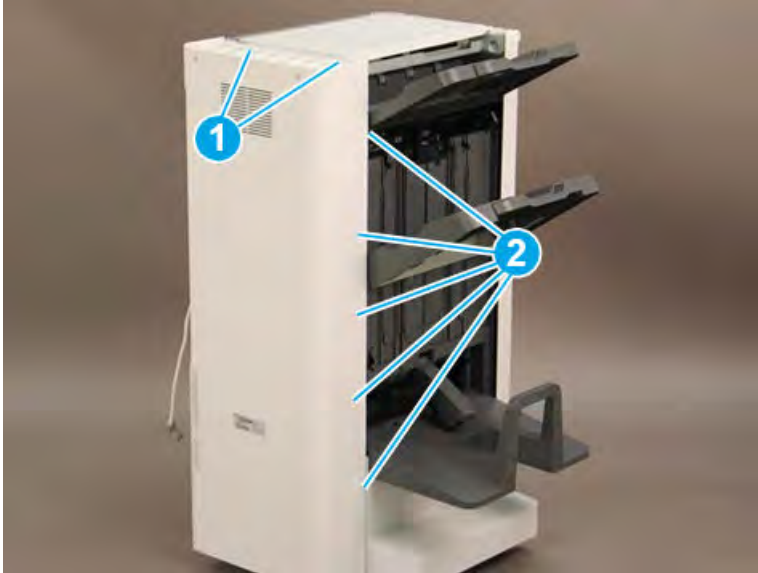


### Remove the rear cover (finisher)

Follow these steps to remove the rear cover (finisher).

1. Remove two self-tapping screws (callout 1) on the top of the rear cover, and then remove five screw caps and five machine screws (callout 2) on the left side of the cover.

Figure 5-855 Remove seven screws

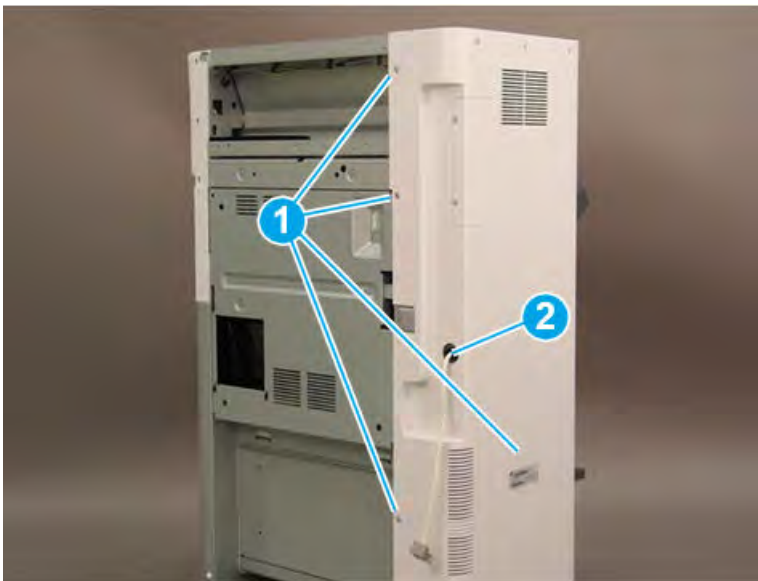


2. Remove one screw cap and four machine screws (callout 1) Remove the rear cover.

 **NOTE:** Make sure to thread the power cable (callout 2) through the opening in the cover.

 **TIP:** Reverse the removal steps to install the assembly

Figure 5-856 Remove the rear cover



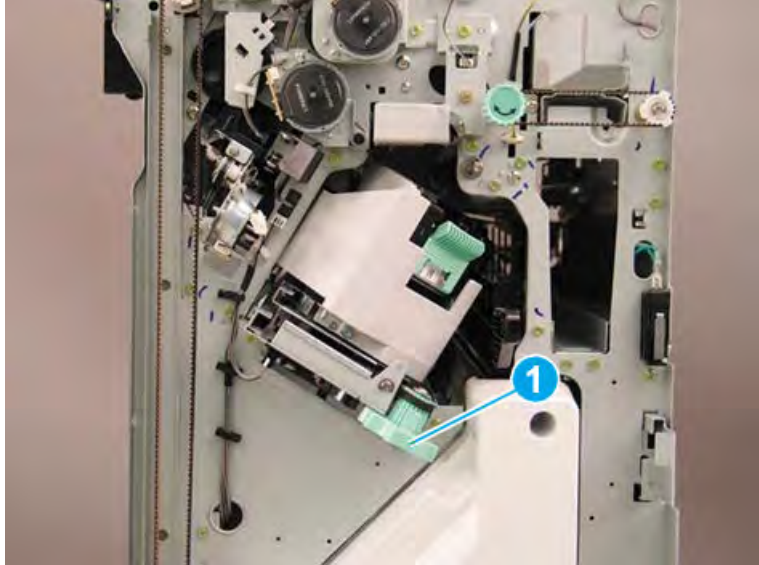
### Remove the stapler unit

Follow these steps to remove the stapler unit.

1. Rotate the green wheel to move the staple unit to the front until it stops.

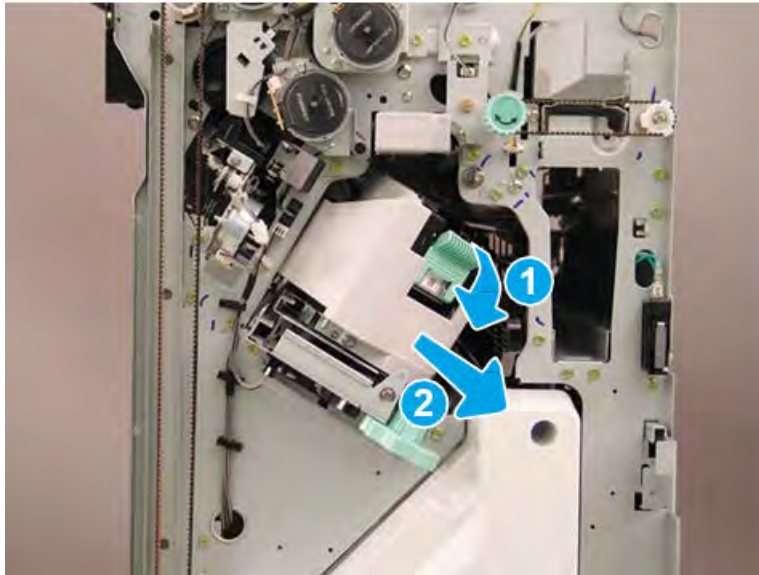


Figure 5-857 Move the staple unit to the front



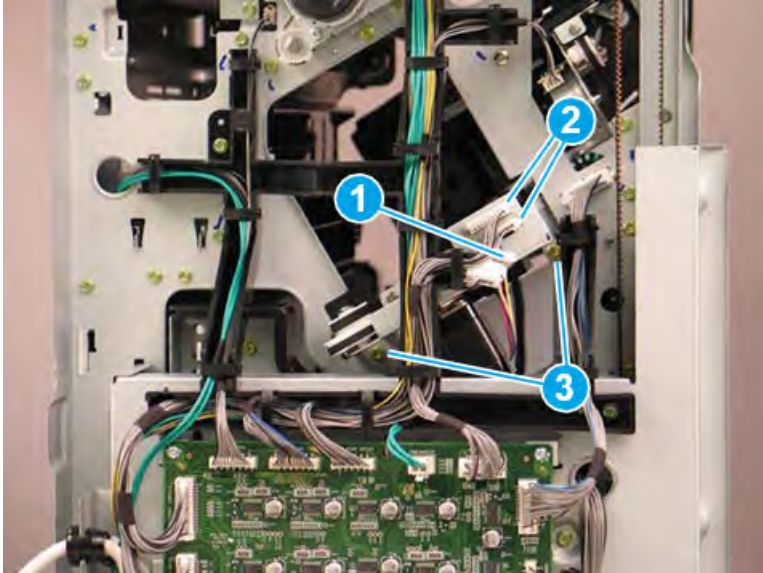
2. Lower the green latch (callout 1), and then slide the staple cartridge away from the finisher to remove it (callout 2).

Figure 5-858 Remove the staple cartridge



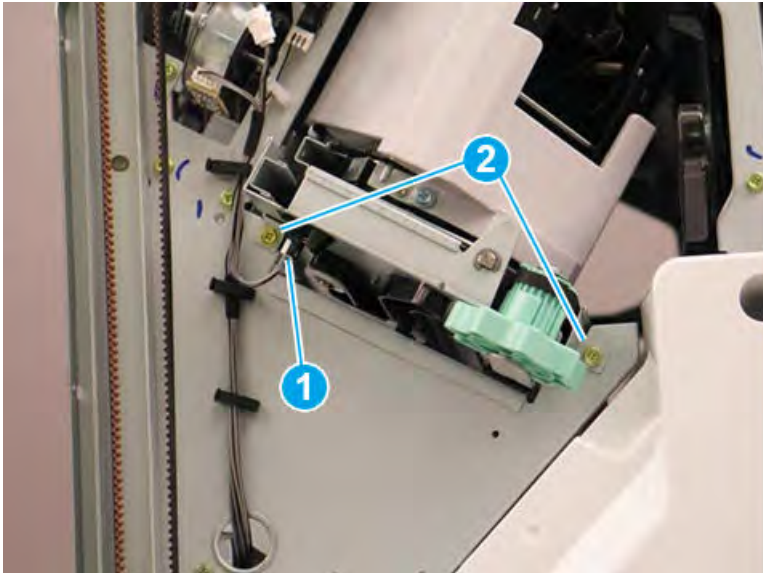
3. At the back of the finisher, release one retainer (callout 1), disconnect two connectors (callout 2), and then remove two screws (callout 3).

**Figure 5-859** Disconnect three connectors and remove two screws




4. At the front of the finisher, disconnect one connector (callout 1), and then remove two screws (callout 2).

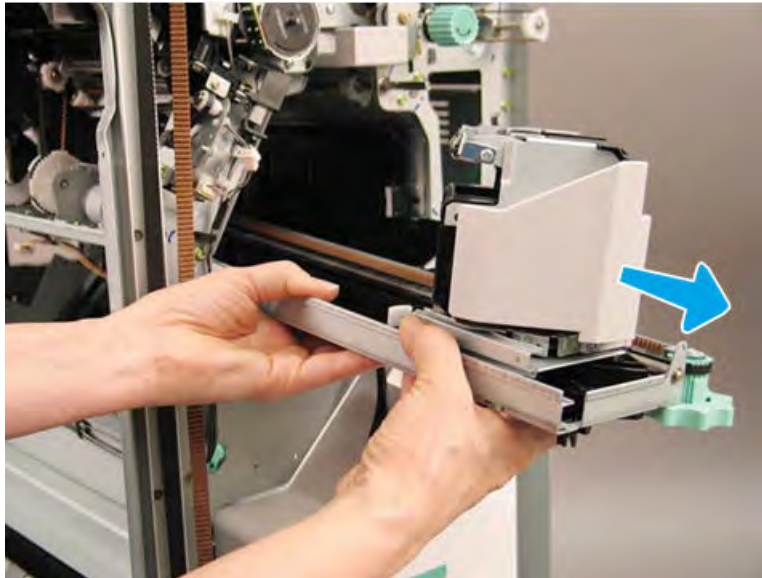
**Figure 5-860** Disconnect one connector and remove two screws



5. Lift up, and then slide the staple unit to the front of the finisher to remove it.

 **TIP:** Reverse the removal steps to install the assembly.

**Figure 5-861** Remove the staple unit

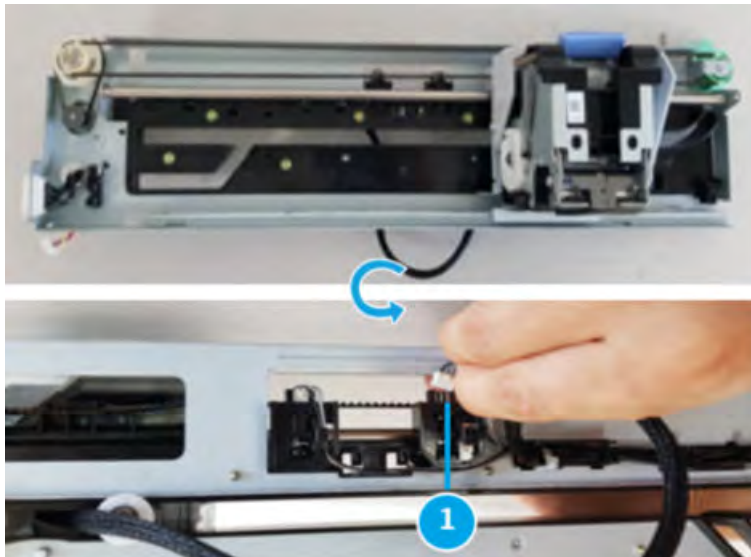


#### Remove the stapler mid-front sensor(S24)

Follow these steps to remove the stapler mid-front sensor(S24).

1. Turn over staple unit and disconnect the connector(callout 1)

**Figure 5-862** Disconnect the connector



2. Remove stapler mid-rear sensor(S24, callout 1) from staple unit.

**Figure 5-863** Remove stapler mid-rear sensor



### Unpack the replacement assembly

Follow these steps to unpack the replacement assembly.

1. Dispose of the defective part.

---



 **NOTE:** HP recommends responsible disposal of the defective part.

<http://www8.hp.com/us/en/hp-information/environment/product-recycling.html>


---

2. Unpack the replacement part from the packaging.

---

 **CAUTION:**  Some parts are sensitive to electrostatic discharge (ESD). Always perform service work at an ESD-protected workstation or mat. If an ESD workstation or mat is not available, touch the sheet-metal chassis to provide a static ground before touching an ESD-sensitive assembly. Protect the ESD-sensitive assemblies by placing them in ESD pouches when they are out of the printer.


 **IMPORTANT:** Make sure that all of the shipping materials (for example shipping tape) are removed from the replacement part prior to installation.

 **NOTE:** If the replacement part is a roller or pad, avoid touching the spongy part of it. Skin oils on the roller or pad can cause paper pickup and/or print-quality problems. HP recommends using disposable gloves when handling rollers or pads or washing your hands before touching rollers or pads.

---

3. To install an assembly, reverse the removal steps.

---

 **NOTE:** When applicable, special installation instructions are provided for an assembly at the end of the removal procedure. Always completely read the removal instructions and follow all special installation instructions.

---

## Removal and replacement: Stapler mid-rear sensor (S25)

Learn how to remove and replace the stapler mid-rear sensor.

### Introduction

This document provides the procedures to remove and replace the stapler mid-rear sensor on the finisher.



**IMPORTANT:** When applicable, special installation instructions are provided for an assembly at the end of the removal procedure. Always completely read the removal instructions and follow all special installation instructions.

### Before performing service

- Turn the printer power off. A shutting-down message appears on the control-panel display.
- ⚠ **WARNING!** To avoid damage to the printer, turn the power off and wait until the printer shuts down before removing the power cable.
- Disconnect the printer power cable after the printer has completely shut down (the control-panel display is blank).
- Release the finisher from the printer by pulling out on the release latch inside the finisher door.
- Disconnect the cable from the bridge unit to the finisher.
- Disconnect the cable from the finisher to the printer.

Use the table below to identify the correct part number for your printer. To order the part, go to <https://parts.hp.com>.

**Table 5-122 Part information**

Part number	Part description
0604-001393	Stapler mid-rear sensor

### Required tools

- #2 JIS screwdriver with a magnetic tip

### After performing service

- Connect the cable from the finisher to the printer.
- Connect the cable from the bridge unit to the finisher.
- Attach the finisher to the printer, and then push in on the release latch inside the finisher door.
- Connect the printer power cable.
- Turn the printer power on.

### Post service test

Process a job through the finisher and verify that the finisher works correctly.

## Remove the right upper cover (finisher)

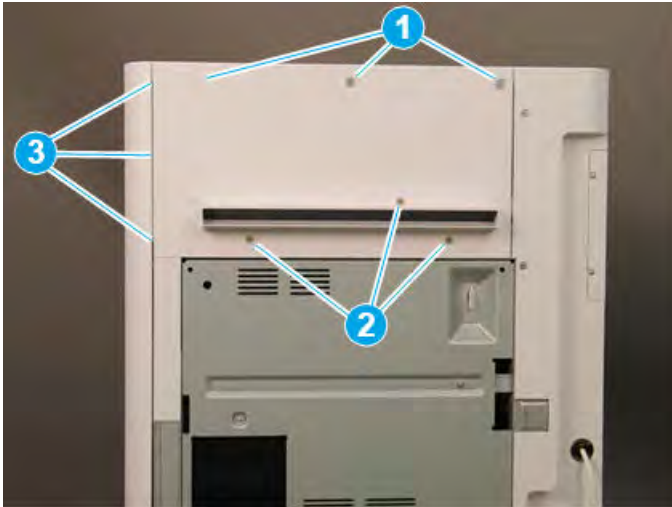
Follow these steps to remove the right upper cover (finisher).

- ▲ Remove one screw cap and three machine screws on the upper edge of the cover (callout 1). Remove three sheet metal screws (callout 2) on the lower portion of the cover. Rotate the right edge of the cover away from the finisher, and then slide the cover right to release three tabs (callout 3).

💡 **TIP:** The lower screws are shorter in length than the upper screws.

**TIP:** Reverse the removal steps to install the assembly.

**Figure 5-864** Remove the right upper cover

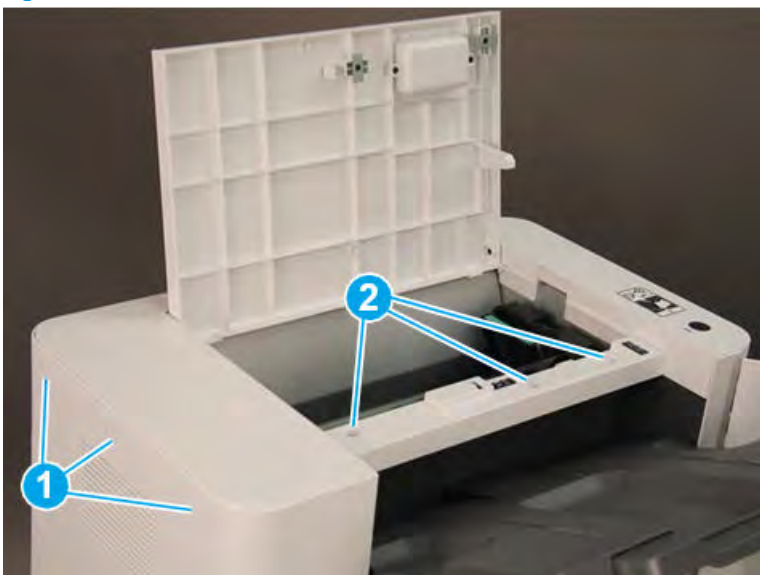


## Remove the top cover (finisher)

Follow these steps to remove the top cover (finisher).

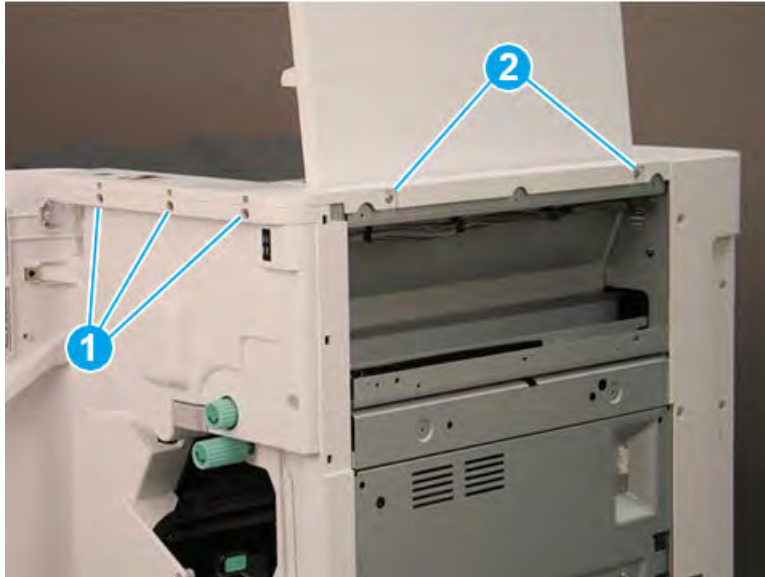
1. Remove three screw caps and three self-tapping screws at the top of the rear cover (callout 1), and then remove three machine screws (callout 2) on top of the cover.

**Figure 5-865** Remove six screws



2. Remove three self-tapping screws at the top of the front cover (callout 1), and then remove two machine screws (callout 2) at the top of the right side.

Figure 5-866 Remove five screws



3. Lift the cover up slightly. Disconnect one in-line connector (callout 1), and then release one retainer (callout 2).


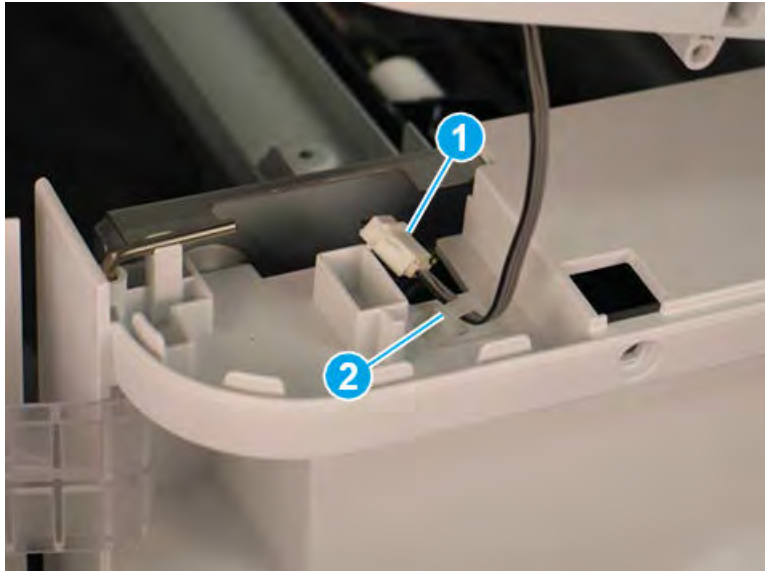
 **TIP:** Reverse the removal steps to install the assembly.

Figure 5-867 Disconnect one connector and release retainer

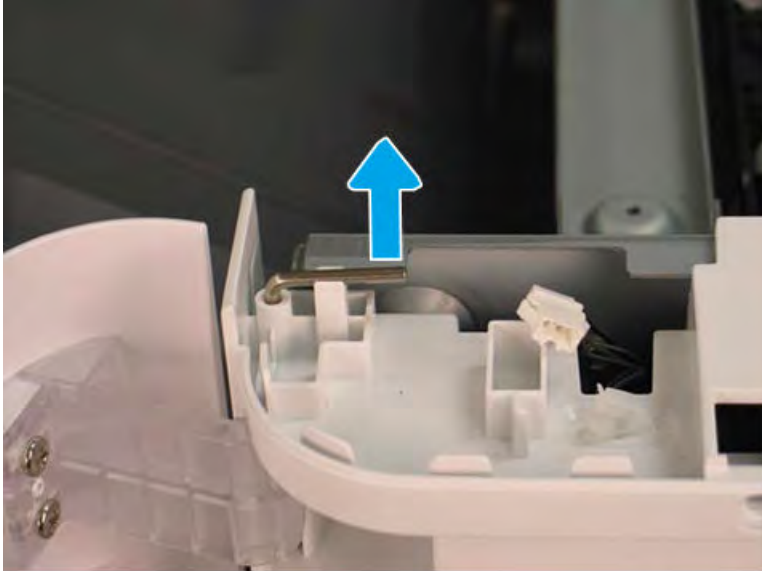


### Remove the front door (finisher)

Follow these steps to remove the front door (finisher).

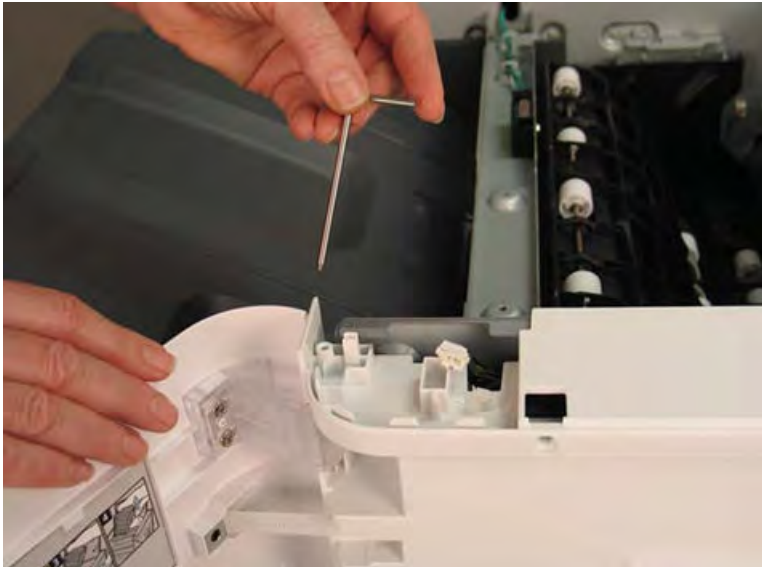
1. Lift the top hinge pin up to release it from the retainer.

Figure 5-868 Lift the top hinge pin



2. Pull the top hinge pin up to remove it.

Figure 5-869 Remove the top hinge pin





3. Use a small, flat-blade screwdriver to release the lower hinge pin from the retainer, and then rotate it away from the finisher.

Figure 5-870 Release the lower hinge pin




4. Support the door with one hand, and then pull the lower hinge pin straight up to remove it.

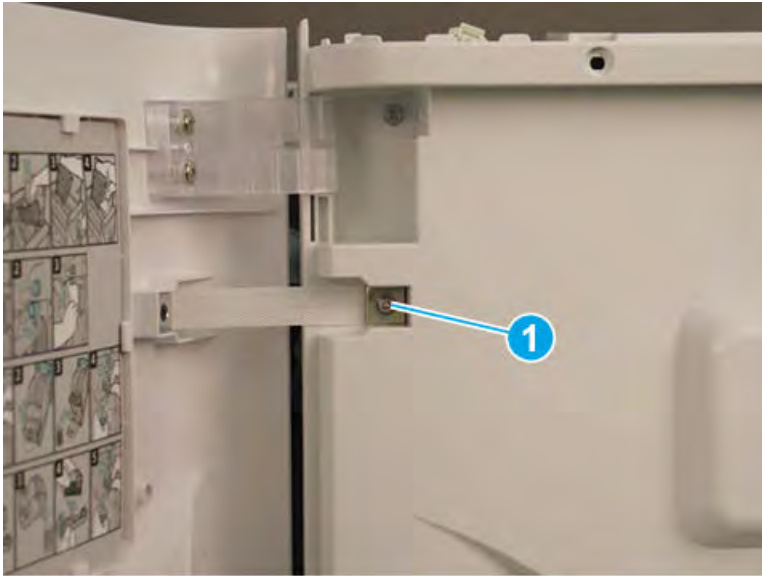
Figure 5-871 Remove the lower hinge pin



5. Support the door with one hand, and then remove one screw (callout 1) to release the strap. Remove the front door.

 **TIP:** Reverse the removal steps to install the assembly.

**Figure 5-872** Remove the front door

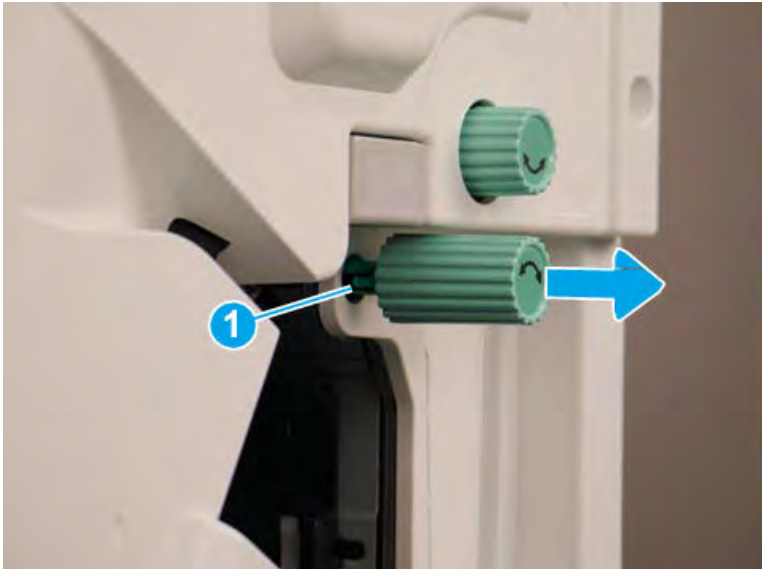


#### Remove the front cover (finisher)

Follow these steps to remove the front cover (finisher).

1. Release one tab (callout 1), and then pull the jam-access knob away from the finisher to remove it.

**Figure 5-873** Remove the jam-access knob



2. If the punch unit is installed, remove the punch waste bin (callout 1).


3. Remove one screw (callout 1) on top of the front cover.

Figure 5-874 Remove one screw



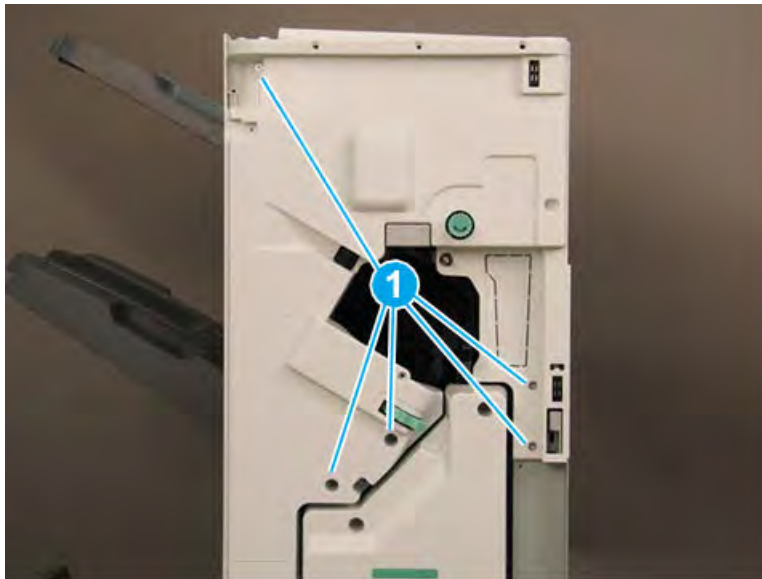
4. Remove five machine screws (callout 1), and then remove the front cover.

---

 **TIP:** Reverse the removal steps to install the assembly.

---

Figure 5-875 Remove the front cover

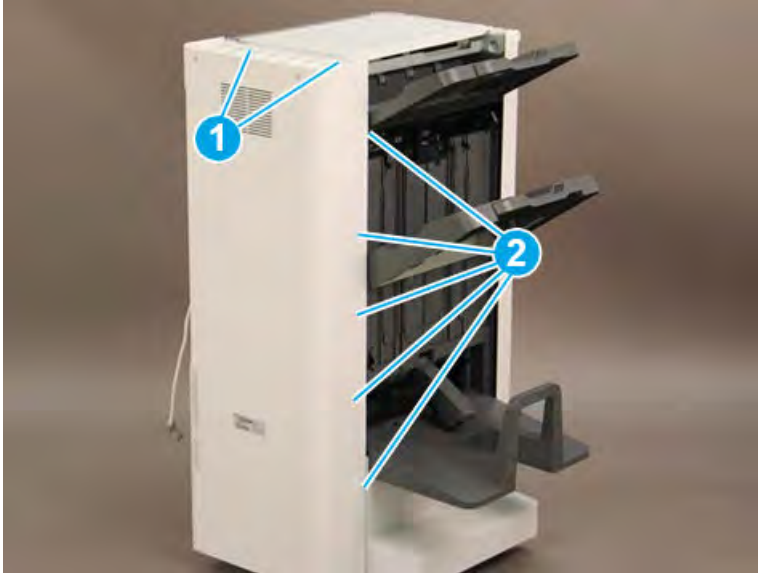


### Remove the rear cover (finisher)

Follow these steps to remove the rear cover (finisher).

1. Remove two self-tapping screws (callout 1) on the top of the rear cover, and then remove five screw caps and five machine screws (callout 2) on the left side of the cover.

Figure 5-876 Remove seven screws

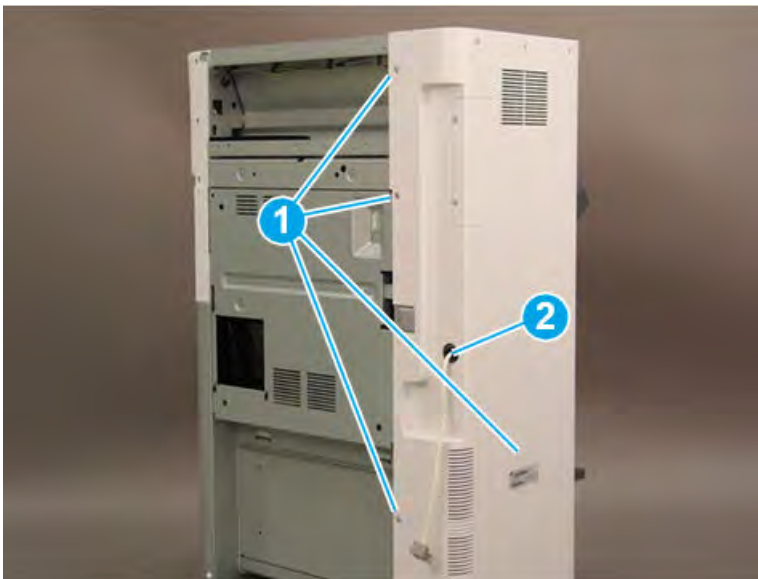


2. Remove one screw cap and four machine screws (callout 1) Remove the rear cover.

 **NOTE:** Make sure to thread the power cable (callout 2) through the opening in the cover.

 **TIP:** Reverse the removal steps to install the assembly

Figure 5-877 Remove the rear cover

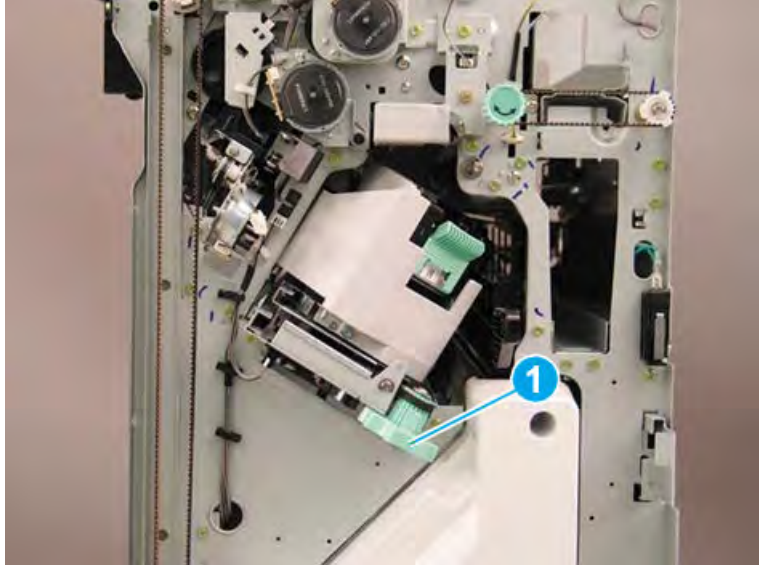


### Remove the stapler unit

Follow these steps to remove the stapler unit.

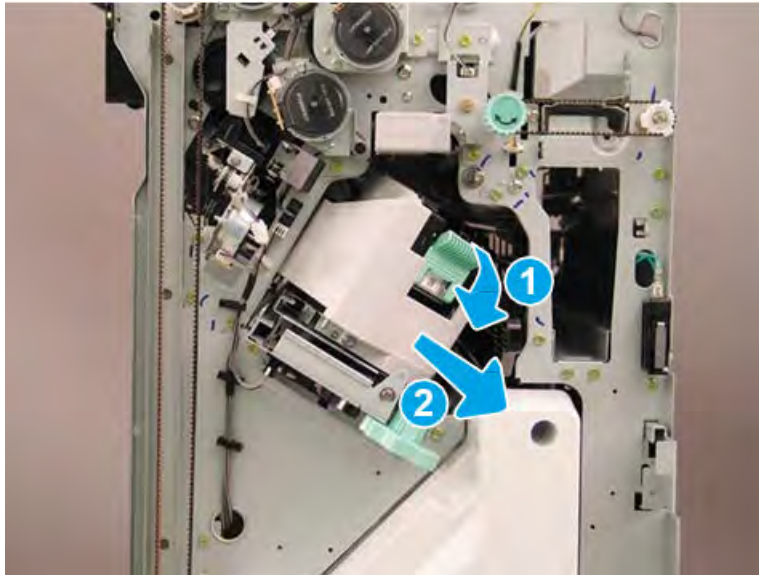
1. Rotate the green wheel to move the staple unit to the front until it stops.

Figure 5-878 Move the staple unit to the front



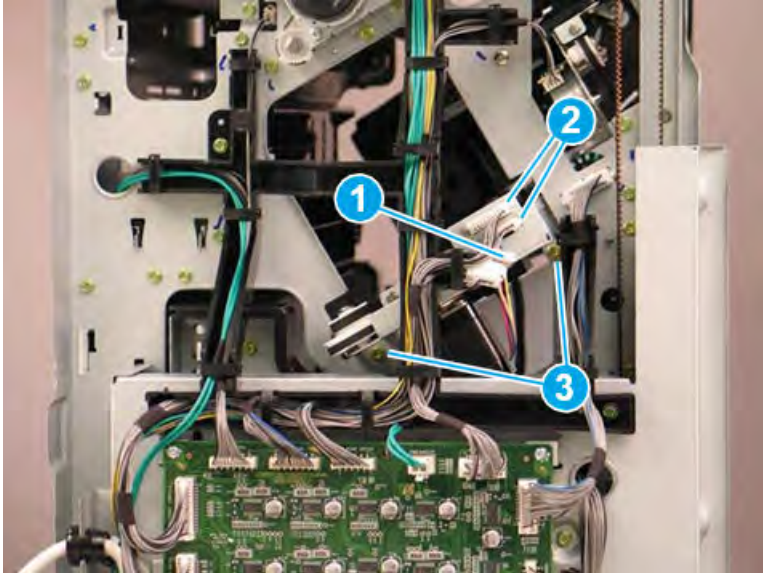
2. Lower the green latch (callout 1), and then slide the staple cartridge away from the finisher to remove it (callout 2).

Figure 5-879 Remove the staple cartridge



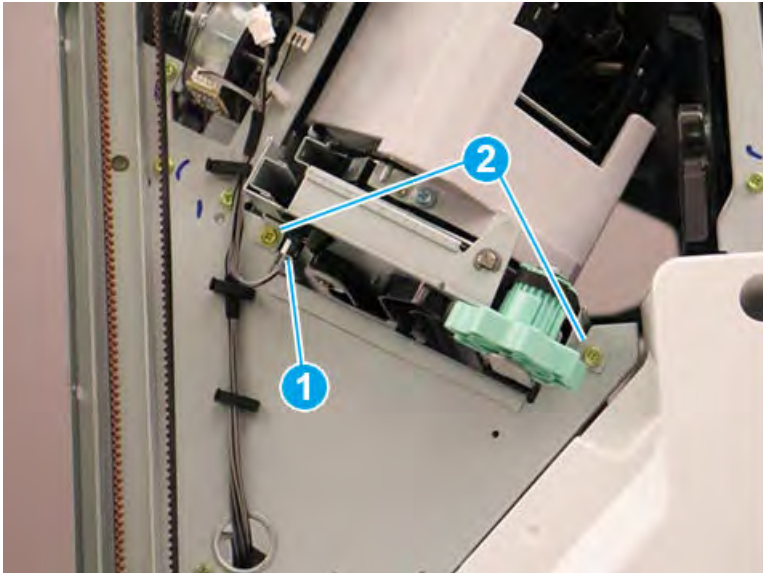
3. At the back of the finisher, release one retainer (callout 1), disconnect two connectors (callout 2), and then remove two screws (callout 3).

Figure 5-880 Disconnect three connectors and remove two screws




4. At the front of the finisher, disconnect one connector (callout 1), and then remove two screws (callout 2).

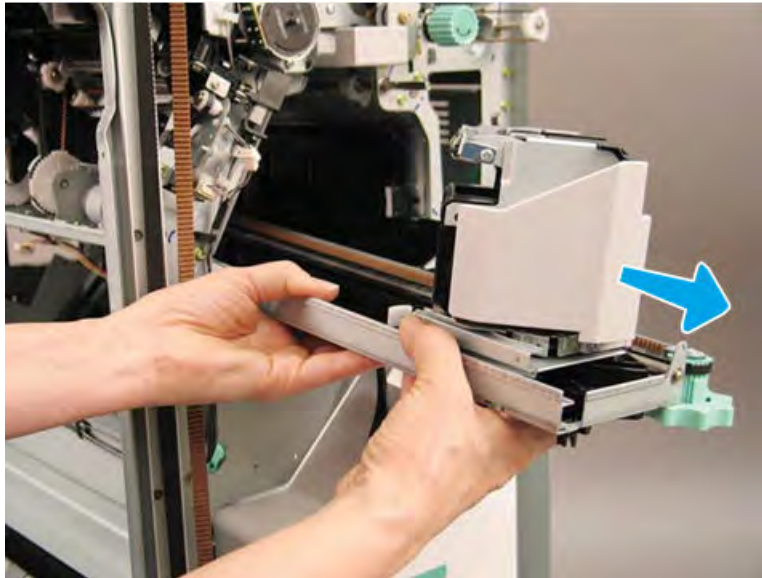
Figure 5-881 Disconnect one connector and remove two screws



5. Lift up, and then slide the staple unit to the front of the finisher to remove it.

 **TIP:** Reverse the removal steps to install the assembly.

**Figure 5-882** Remove the staple unit

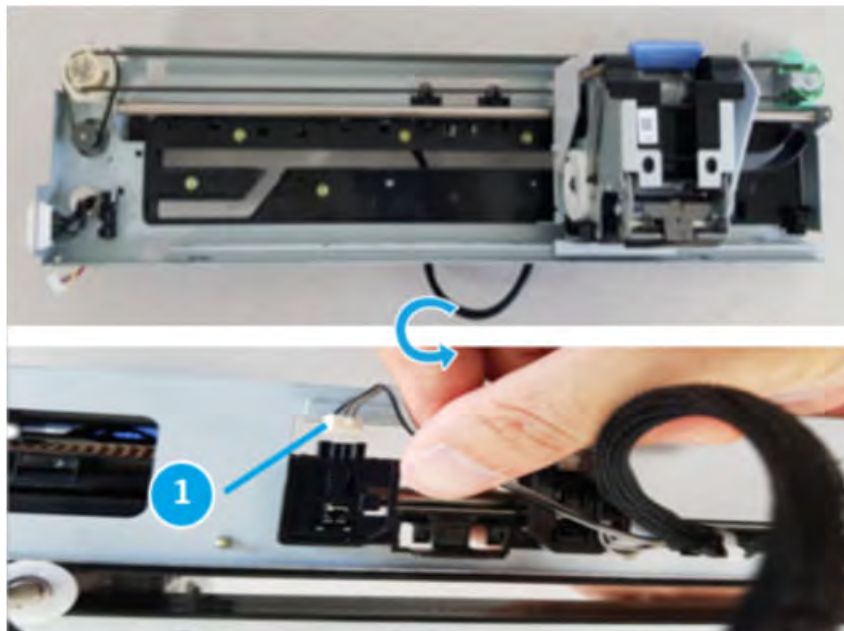


#### Remove the stapler mid-rear sensor(S25)

Follow these steps to remove the stapler mid-rear sensor(S25).

1. Turn over staple unit and disconnect the connector(callout 1)

**Figure 5-883** Disconnect the connector



2. Remove stapler mid-rear sensor(S24, callout 1) from staple unit.

**Figure 5-884** Remove stapler mid-rear sensor



### Unpack the replacement assembly

Follow these steps to unpack the replacement assembly.

1. Dispose of the defective part.

---



 **NOTE:** HP recommends responsible disposal of the defective part.

<http://www8.hp.com/us/en/hp-information/environment/product-recycling.html>


---

2. Unpack the replacement part from the packaging.

---

 **CAUTION:**  Some parts are sensitive to electrostatic discharge (ESD). Always perform service work at an ESD-protected workstation or mat. If an ESD workstation or mat is not available, touch the sheet-metal chassis to provide a static ground before touching an ESD-sensitive assembly. Protect the ESD-sensitive assemblies by placing them in ESD pouches when they are out of the printer.


 **IMPORTANT:** Make sure that all of the shipping materials (for example shipping tape) are removed from the replacement part prior to installation.

 **NOTE:** If the replacement part is a roller or pad, avoid touching the spongy part of it. Skin oils on the roller or pad can cause paper pickup and/or print-quality problems. HP recommends using disposable gloves when handling rollers or pads or washing your hands before touching rollers or pads.

---

3. To install an assembly, reverse the removal steps.

---

 **NOTE:** When applicable, special installation instructions are provided for an assembly at the end of the removal procedure. Always completely read the removal instructions and follow all special installation instructions.

---



## Removal and replacement: Stapler rear sensor (S30)

Learn how to remove and replace the stapler rear sensor.

### Introduction

This document provides the procedures to remove and replace the stapler rear sensor on the finisher.



**IMPORTANT:** When applicable, special installation instructions are provided for an assembly at the end of the removal procedure. Always completely read the removal instructions and follow all special installation instructions.

### Before performing service

- Turn the printer power off. A shutting-down message appears on the control-panel display.
- ⚠ **WARNING!** To avoid damage to the printer, turn the power off and wait until the printer shuts down before removing the power cable.
- Disconnect the printer power cable after the printer has completely shut down (the control-panel display is blank).
- Release the finisher from the printer by pulling out on the release latch inside the finisher door.
- Disconnect the cable from the bridge unit to the finisher.
- Disconnect the cable from the finisher to the printer.

Use the table below to identify the correct part number for your printer. To order the part, go to <https://parts.hp.com>.

**Table 5-123 Part information**

Part number	Part description
0604-001393	Stapler rear sensor

### Required tools

- #2 JIS screwdriver with a magnetic tip

### After performing service

- Connect the cable from the finisher to the printer.
- Connect the cable from the bridge unit to the finisher.
- Attach the finisher to the printer, and then push in on the release latch inside the finisher door.
- Connect the printer power cable.
- Turn the printer power on.

### Post service test

Process a job through the finisher and verify that the finisher works correctly.

### Remove the right upper cover (finisher)

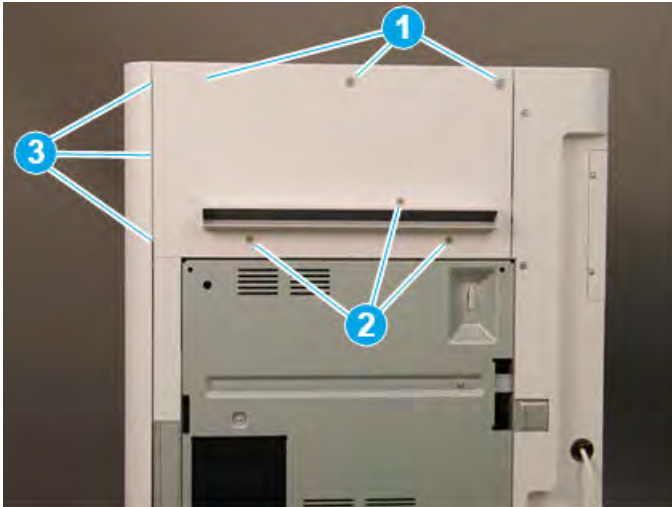
Follow these steps to remove the right upper cover (finisher).

- ▲ Remove one screw cap and three machine screws on the upper edge of the cover (callout 1). Remove three sheet metal screws (callout 2) on the lower portion of the cover. Rotate the right edge of the cover away from the finisher, and then slide the cover right to release three tabs (callout 3).

💡 **TIP:** The lower screws are shorter in length than the upper screws.

**TIP:** Reverse the removal steps to install the assembly.

**Figure 5-885** Remove the right upper cover

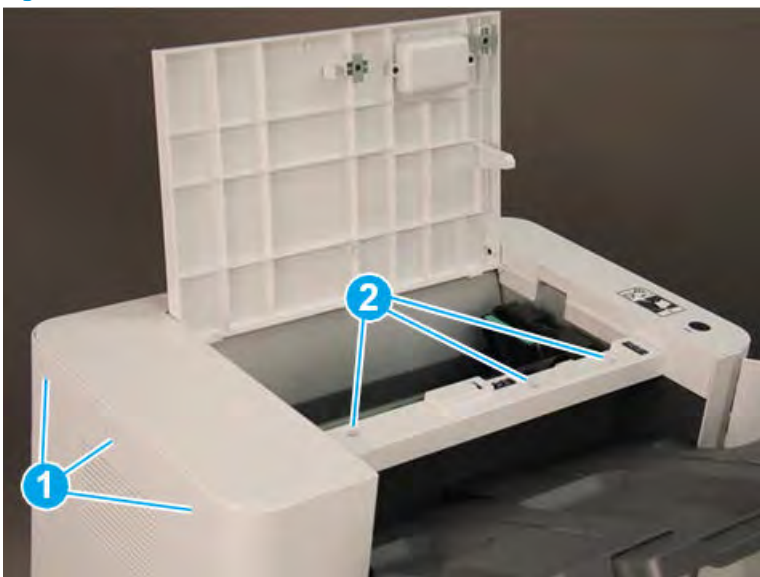


### Remove the top cover (finisher)

Follow these steps to remove the top cover (finisher).

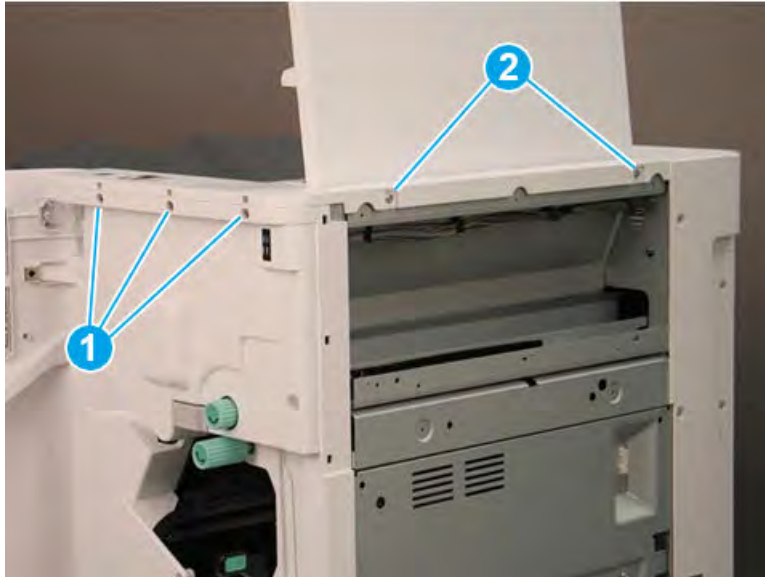
1. Remove three screw caps and three self-tapping screws at the top of the rear cover (callout 1), and then remove three machine screws (callout 2) on top of the cover.

**Figure 5-886** Remove six screws



2. Remove three self-tapping screws at the top of the front cover (callout 1), and then remove two machine screws (callout 2) at the top of the right side.

Figure 5-887 Remove five screws



3. Lift the cover up slightly. Disconnect one in-line connector (callout 1), and then release one retainer (callout 2).


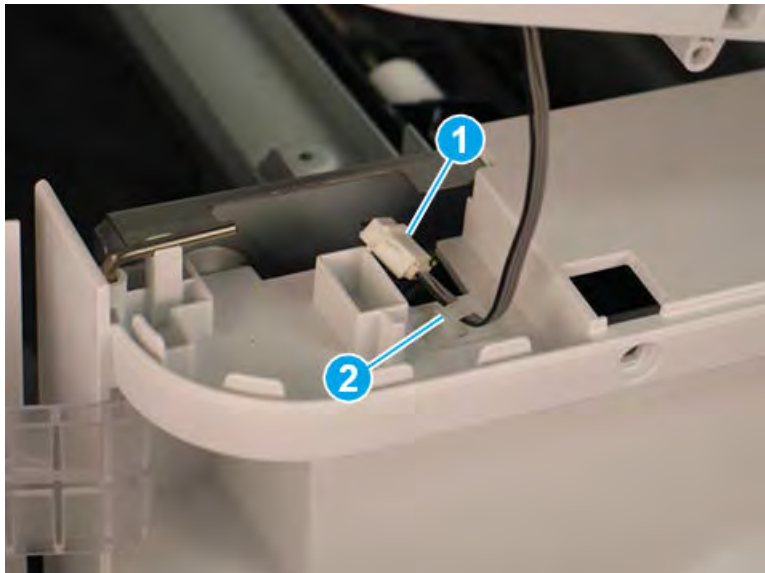
 **TIP:** Reverse the removal steps to install the assembly.

Figure 5-888 Disconnect one connector and release retainer

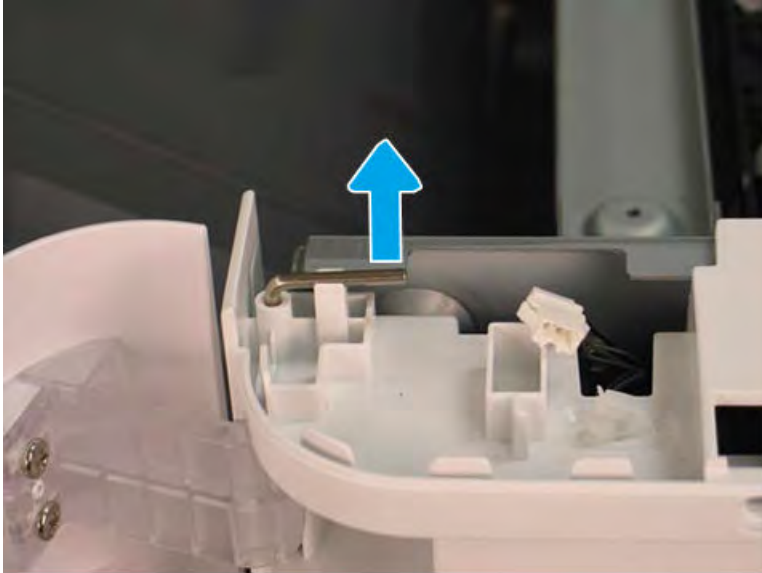


### Remove the front door (finisher)

Follow these steps to remove the front door (finisher).

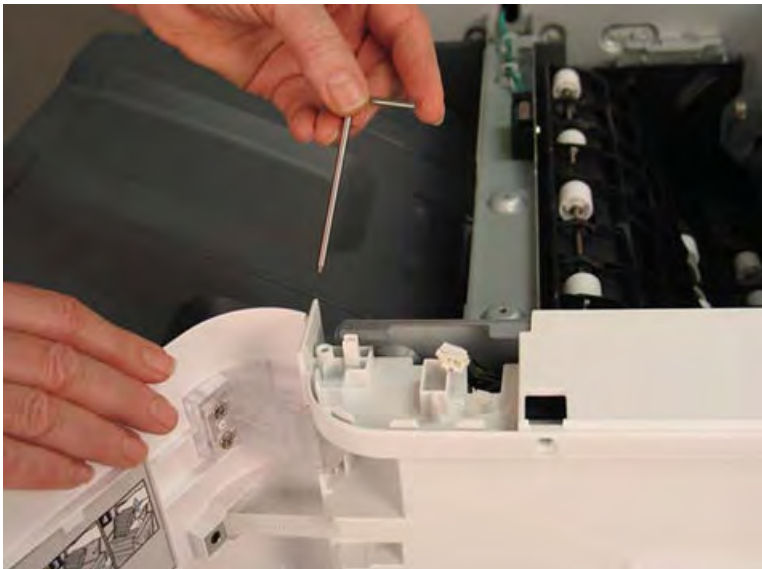
1. Lift the top hinge pin up to release it from the retainer.

Figure 5-889 Lift the top hinge pin



2. Pull the top hinge pin up to remove it.

Figure 5-890 Remove the top hinge pin



3. Use a small, flat-blade screwdriver to release the lower hinge pin from the retainer, and then rotate it away from the finisher.

Figure 5-891 Release the lower hinge pin




4. Support the door with one hand, and then pull the lower hinge pin straight up to remove it.

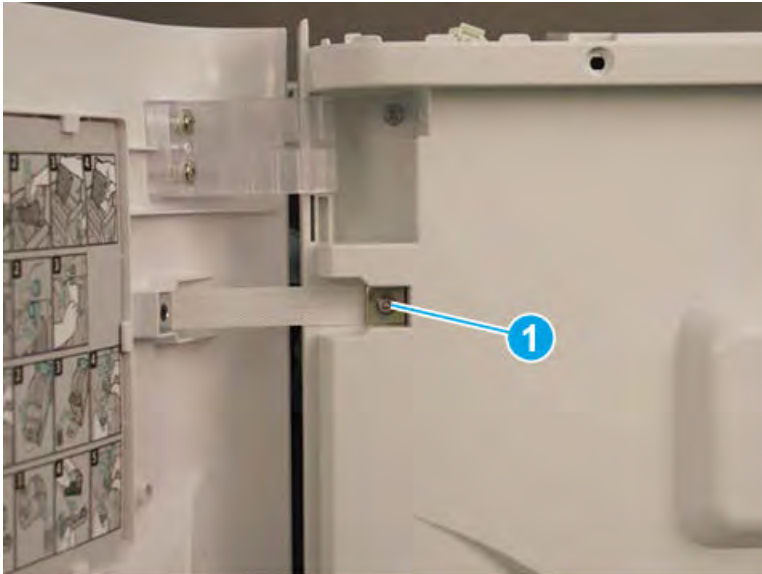
Figure 5-892 Remove the lower hinge pin



5. Support the door with one hand, and then remove one screw (callout 1) to release the strap. Remove the front door.

 **TIP:** Reverse the removal steps to install the assembly.

**Figure 5-893** Remove the front door

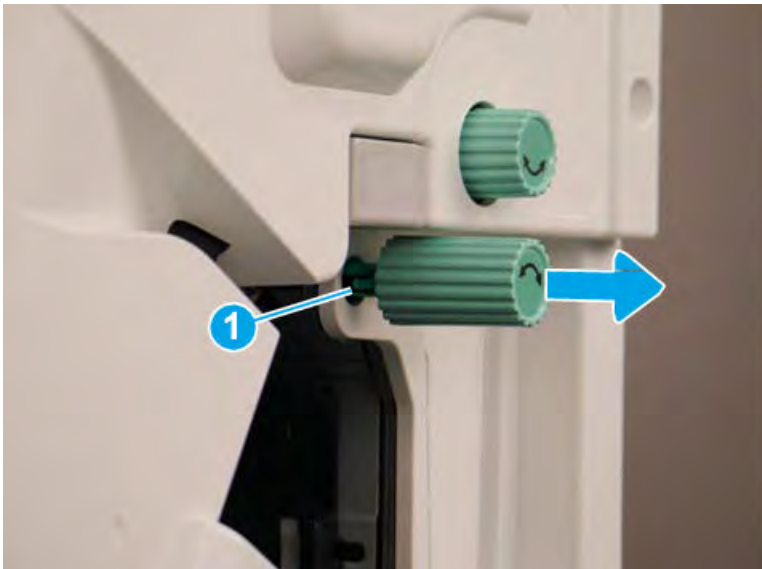


#### Remove the front cover (finisher)

Follow these steps to remove the front cover (finisher).

1. Release one tab (callout 1), and then pull the jam-access knob away from the finisher to remove it.

**Figure 5-894** Remove the jam-access knob



2. If the punch unit is installed, remove the punch waste bin (callout 1).


3. Remove one screw (callout 1) on top of the front cover.

Figure 5-895 Remove one screw



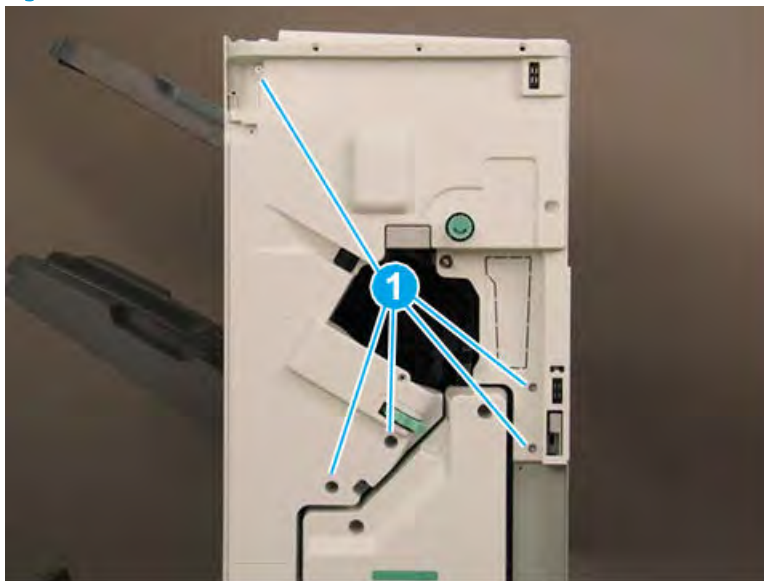
4. Remove five machine screws (callout 1), and then remove the front cover.

---

 **TIP:** Reverse the removal steps to install the assembly.

---

Figure 5-896 Remove the front cover

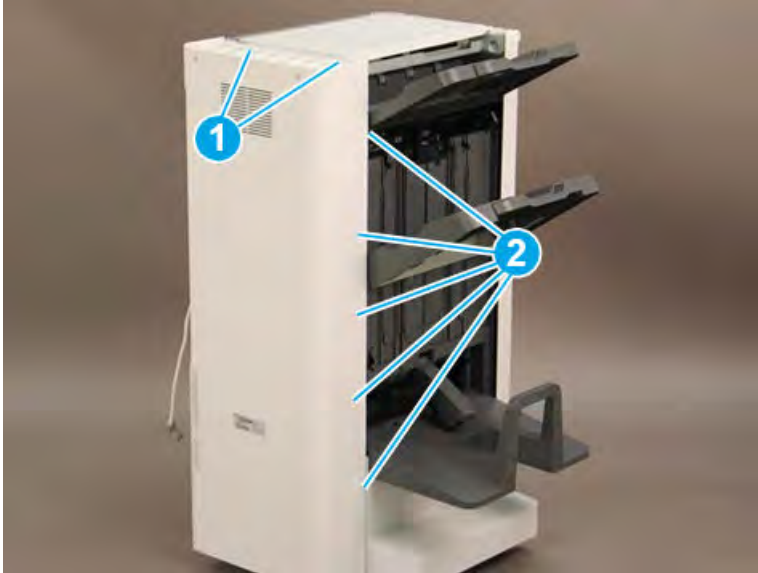


### Remove the rear cover (finisher)

Follow these steps to remove the rear cover (finisher).

1. Remove two self-tapping screws (callout 1) on the top of the rear cover, and then remove five screw caps and five machine screws (callout 2) on the left side of the cover.

Figure 5-897 Remove seven screws

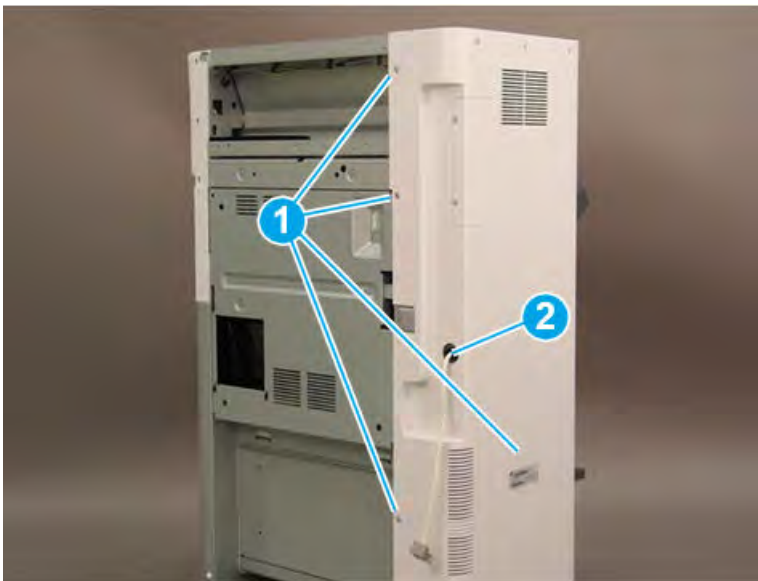


2. Remove one screw cap and four machine screws (callout 1) Remove the rear cover.

 **NOTE:** Make sure to thread the power cable (callout 2) through the opening in the cover.

 **TIP:** Reverse the removal steps to install the assembly

Figure 5-898 Remove the rear cover



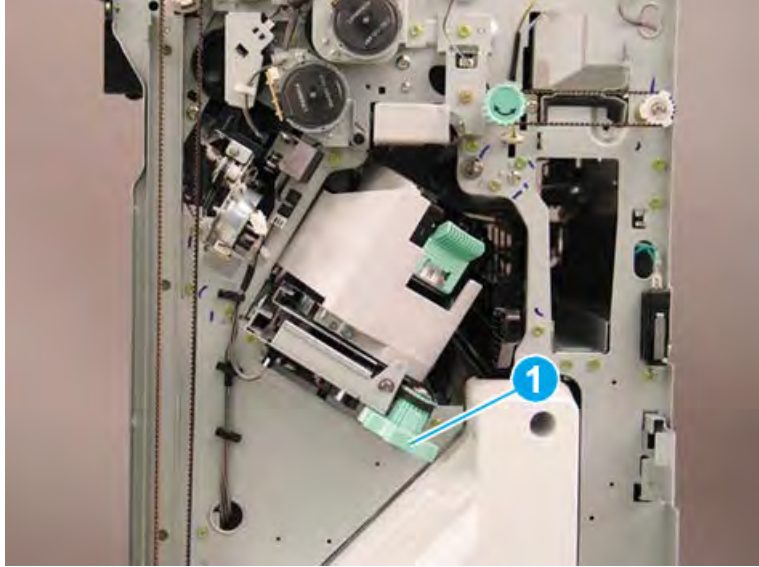
### Remove the stapler unit

Follow these steps to remove the stapler unit.

1. Rotate the green wheel to move the staple unit to the front until it stops.

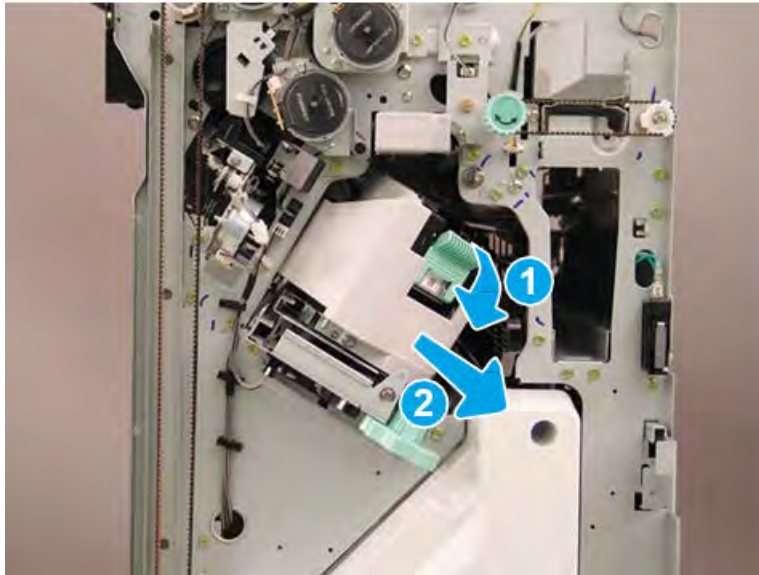


Figure 5-899 Move the staple unit to the front



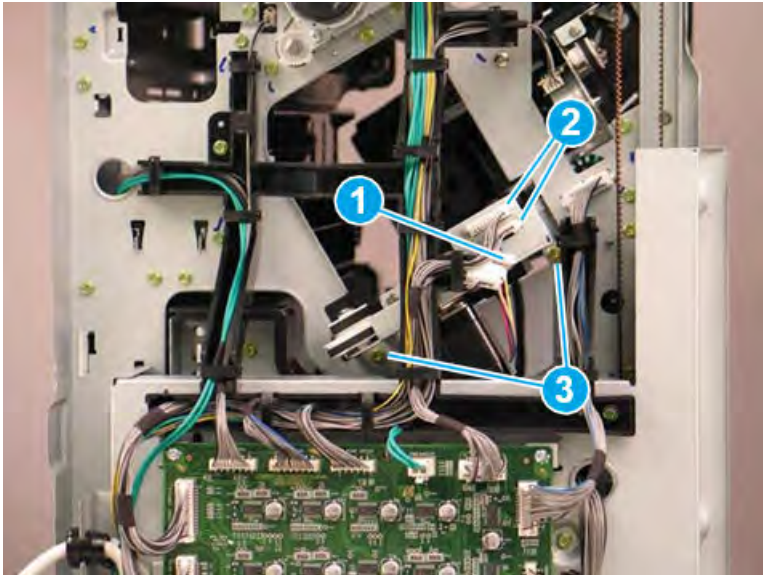
2. Lower the green latch (callout 1), and then slide the staple cartridge away from the finisher to remove it (callout 2).

Figure 5-900 Remove the staple cartridge



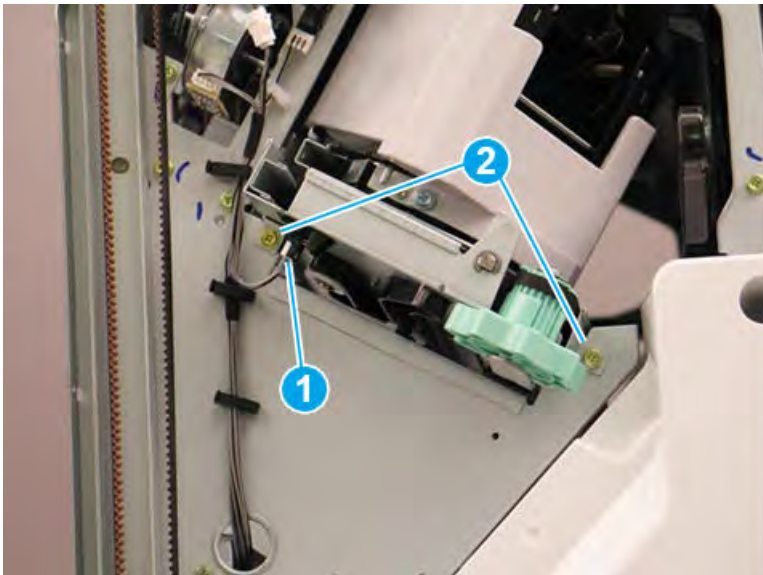
3. At the back of the finisher, release one retainer (callout 1), disconnect two connectors (callout 2), and then remove two screws (callout 3).

Figure 5-901 Disconnect three connectors and remove two screws




4. At the front of the finisher, disconnect one connector (callout 1), and then remove two screws (callout 2).

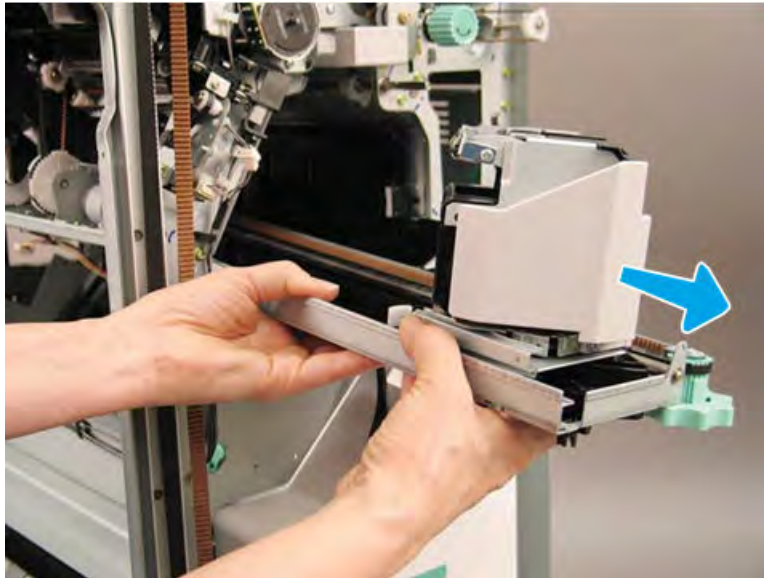
Figure 5-902 Disconnect one connector and remove two screws



5. Lift up, and then slide the staple unit to the front of the finisher to remove it.

 **TIP:** Reverse the removal steps to install the assembly.

**Figure 5-903** Remove the staple unit

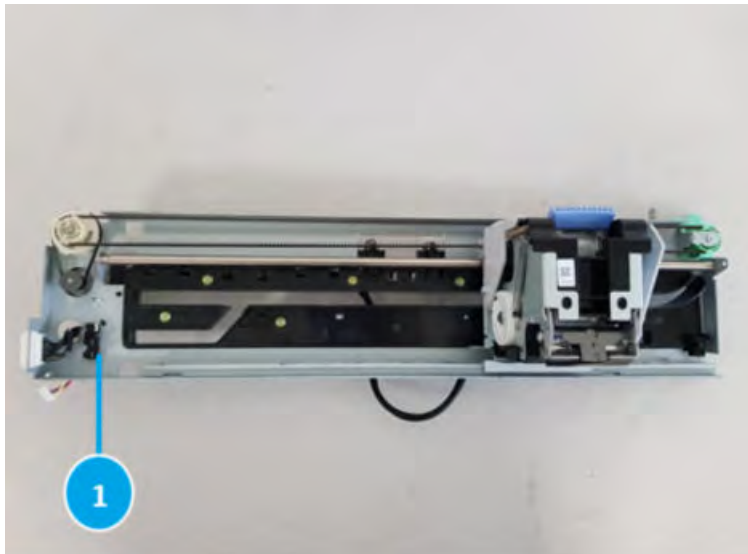


#### Remove the stapler rear sensor(S30)

Follow these steps to remove the stapler rear sensor(S30).

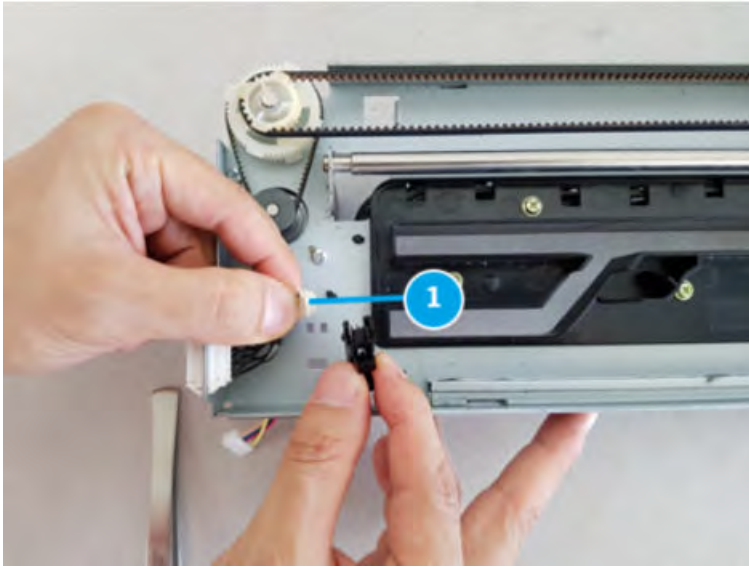
1. Remove stapler rear sensor(callout 1, S30) from staple unit.

**Figure 5-904** Remove stapler rear sensor from staple unit.



2. Disconnect the connector(callout 1) from stapler rear sensor.

**Figure 5-905** Disconnect the connector from stapler rear sensor.



### Unpack the replacement assembly



Follow these steps to unpack the replacement assembly.


1. Dispose of the defective part.


 **NOTE:** HP recommends responsible disposal of the defective part.

<http://www8.hp.com/us/en/hp-information/environment/product-recycling.html>


2. Unpack the replacement part from the packaging.

 **CAUTION:**  Some parts are sensitive to electrostatic discharge (ESD). Always perform service work at an ESD-protected workstation or mat. If an ESD workstation or mat is not available, touch the sheet-metal chassis to provide a static ground before touching an ESD-sensitive assembly. Protect the ESD-sensitive assemblies by placing them in ESD pouches when they are out of the printer.

 **IMPORTANT:** Make sure that all of the shipping materials (for example shipping tape) are removed from the replacement part prior to installation.

 **NOTE:** If the replacement part is a roller or pad, avoid touching the spongy part of it. Skin oils on the roller or pad can cause paper pickup and/or print-quality problems. HP recommends using disposable gloves when handling rollers or pads or washing your hands before touching rollers or pads.

3. To install an assembly, reverse the removal steps.

 **NOTE:** When applicable, special installation instructions are provided for an assembly at the end of the removal procedure. Always completely read the removal instructions and follow all special installation instructions.

## Removal and replacement: Manual staple sensor (S19)

Learn how to remove and replace the manual staple sensor.

### Introduction

This document provides the procedures to remove and replace the manual staple sensor for the finisher.



**IMPORTANT:** When applicable, special installation instructions are provided for an assembly at the end of the removal procedure. Always completely read the removal instructions and follow all special installation instructions.

### Before performing service

- Turn the printer power off. A shutting-down message appears on the control-panel display.
- ⚠ **WARNING!** To avoid damage to the printer, turn the power off and wait until the printer shuts down before removing the power cable.
- Disconnect the printer power cable after the printer has completely shut down (the control-panel display is blank).
- Release the finisher from the printer by pulling out on the release latch inside the finisher door.
- Disconnect the cable from the bridge unit to the finisher.
- Disconnect the cable from the finisher to the printer.

Use the table below to identify the correct part number for your printer. To order the part, go to <https://parts.hp.com>.

**Table 5-124 Part information**

Part number	Part description
0604-001415	Manual staple sensor

### Required tools

- #2 JIS screwdriver with a magnetic tip
- Small, flat-blade screwdriver

### After performing service

- Connect the cable from the finisher to the printer.
- Connect the cable from the bridge unit to the finisher.
- Attach the finisher to the printer, and then push in on the release latch inside the finisher door.
- Connect the printer power cable.
- Turn the printer power on.

### Post service test

Process a job through the finisher and verify that the finisher works correctly.

### Remove the right upper cover (finisher)

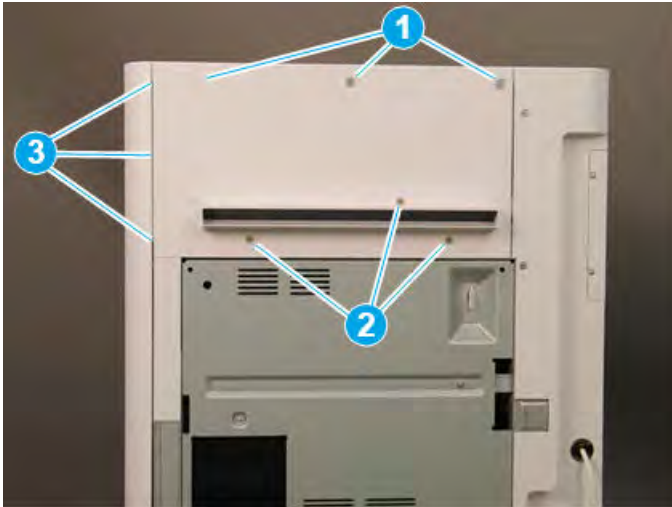
Follow these steps to remove the right upper cover (finisher).

- ▲ Remove one screw cap and three machine screws on the upper edge of the cover (callout 1). Remove three sheet metal screws (callout 2) on the lower portion of the cover. Rotate the right edge of the cover away from the finisher, and then slide the cover right to release three tabs (callout 3).

💡 **TIP:** The lower screws are shorter in length than the upper screws.

**TIP:** Reverse the removal steps to install the assembly.

**Figure 5-906** Remove the right upper cover

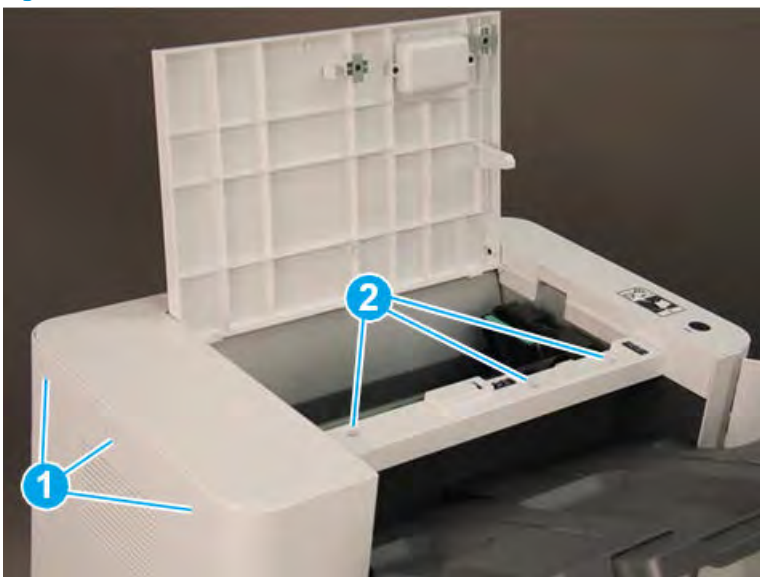


### Remove the top cover (finisher)

Follow these steps to remove the top cover (finisher).

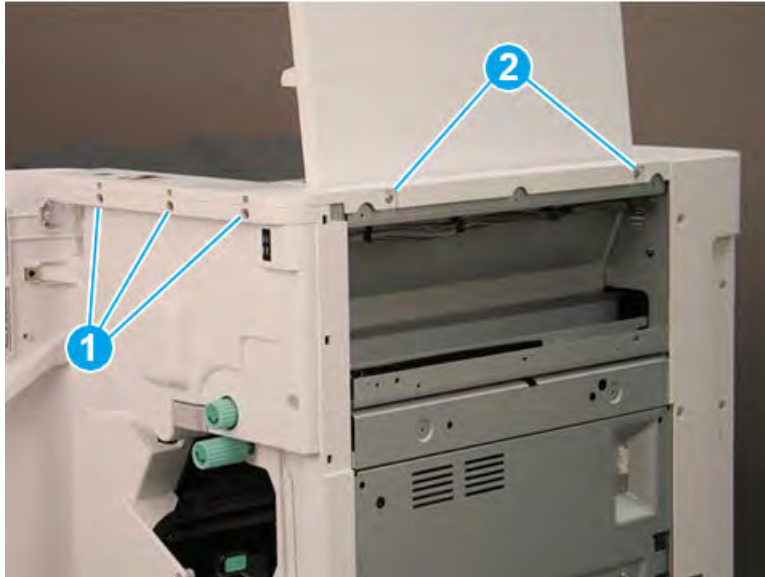
1. Remove three screw caps and three self-tapping screws at the top of the rear cover (callout 1), and then remove three machine screws (callout 2) on top of the cover.

**Figure 5-907** Remove six screws




2. Remove three self-tapping screws at the top of the front cover (callout 1), and then remove two machine screws (callout 2) at the top of the right side.

Figure 5-908 Remove five screws



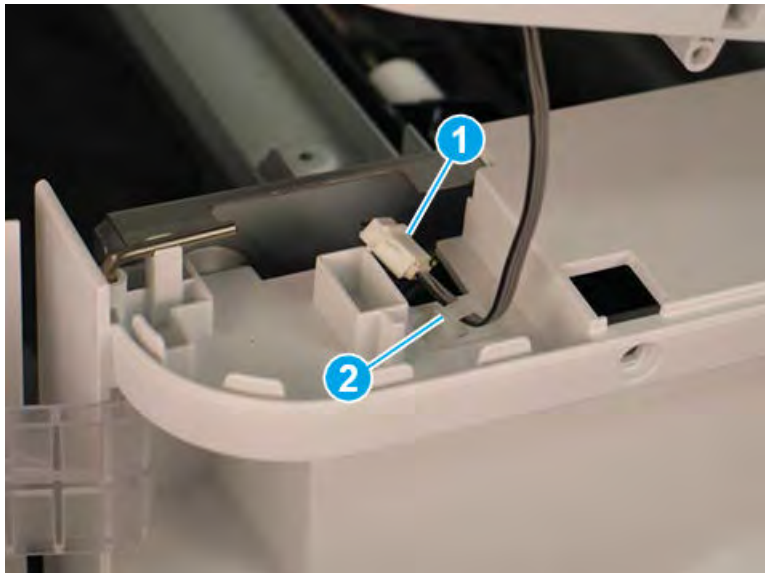
3. Lift the cover up slightly. Disconnect one in-line connector (callout 1), and then release one retainer (callout 2).

---

 **TIP:** Reverse the removal steps to install the assembly.

---

Figure 5-909 Disconnect one connector and release retainer

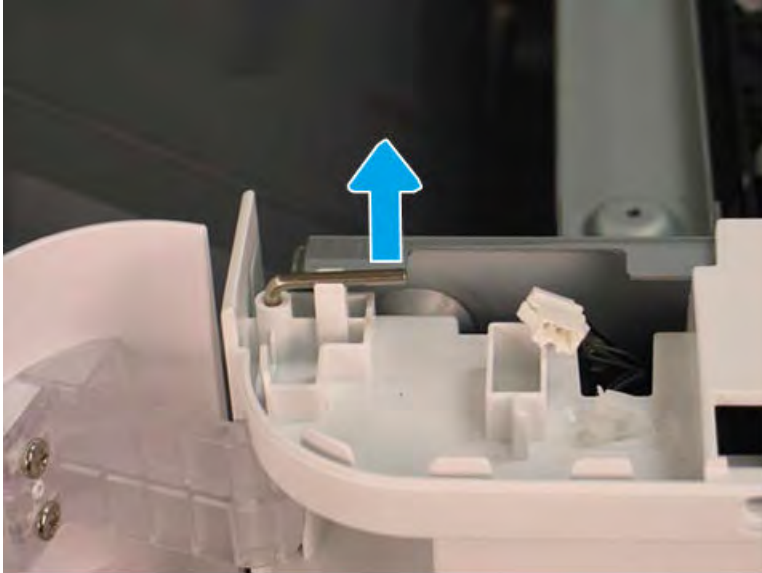


### Remove the front door (finisher)

Follow these steps to remove the front door (finisher).

1. Lift the top hinge pin up to release it from the retainer.

Figure 5-910 Lift the top hinge pin



2. Pull the top hinge pin up to remove it.

Figure 5-911 Remove the top hinge pin





3. Use a small, flat-blade screwdriver to release the lower hinge pin from the retainer, and then rotate it away from the finisher.

Figure 5-912 Release the lower hinge pin




4. Support the door with one hand, and then pull the lower hinge pin straight up to remove it.

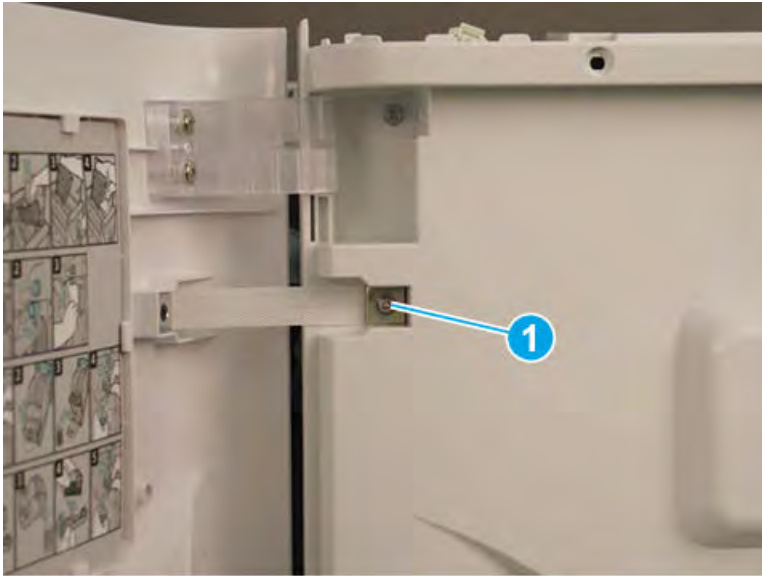
Figure 5-913 Remove the lower hinge pin



5. Support the door with one hand, and then remove one screw (callout 1) to release the strap. Remove the front door.

 **TIP:** Reverse the removal steps to install the assembly.

**Figure 5-914** Remove the front door

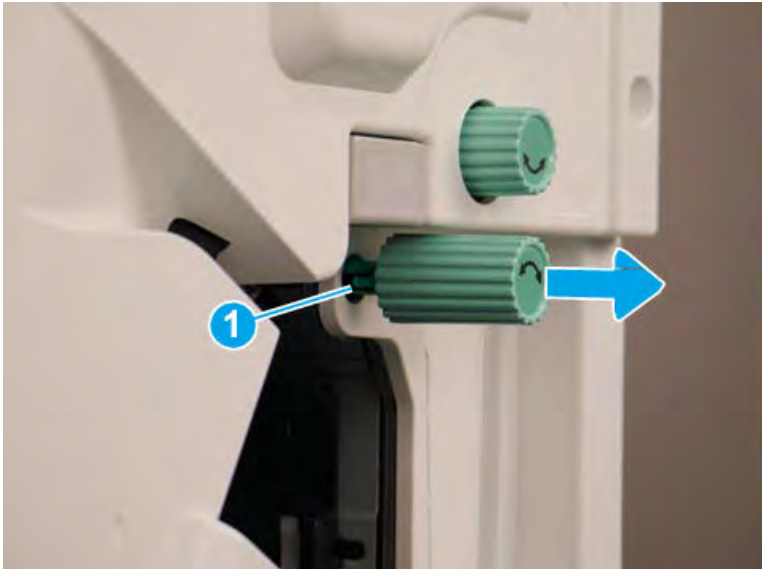


#### Remove the front cover (finisher)

Follow these steps to remove the front cover (finisher).

1. Release one tab (callout 1), and then pull the jam-access knob away from the finisher to remove it.

**Figure 5-915** Remove the jam-access knob



2. If the punch unit is installed, remove the punch waste bin (callout 1).


3. Remove one screw (callout 1) on top of the front cover.

Figure 5-916 Remove one screw



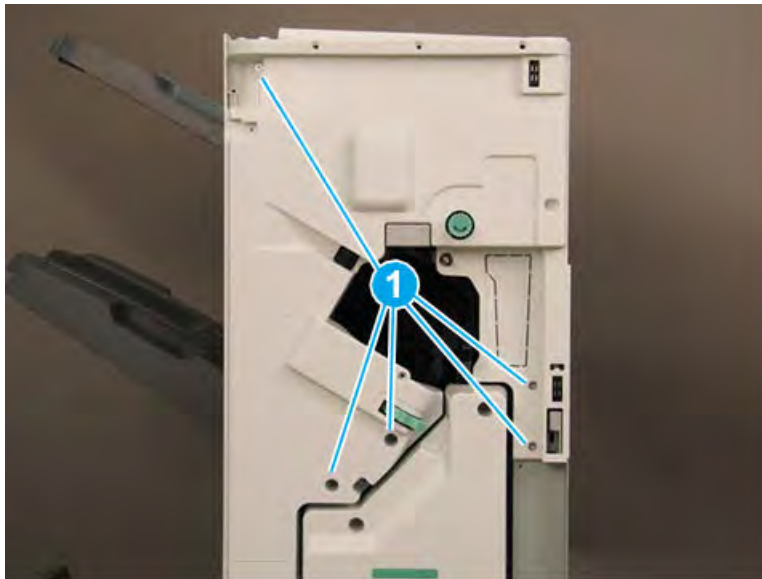
4. Remove five machine screws (callout 1), and then remove the front cover.

---

 **TIP:** Reverse the removal steps to install the assembly.

---

Figure 5-917 Remove the front cover

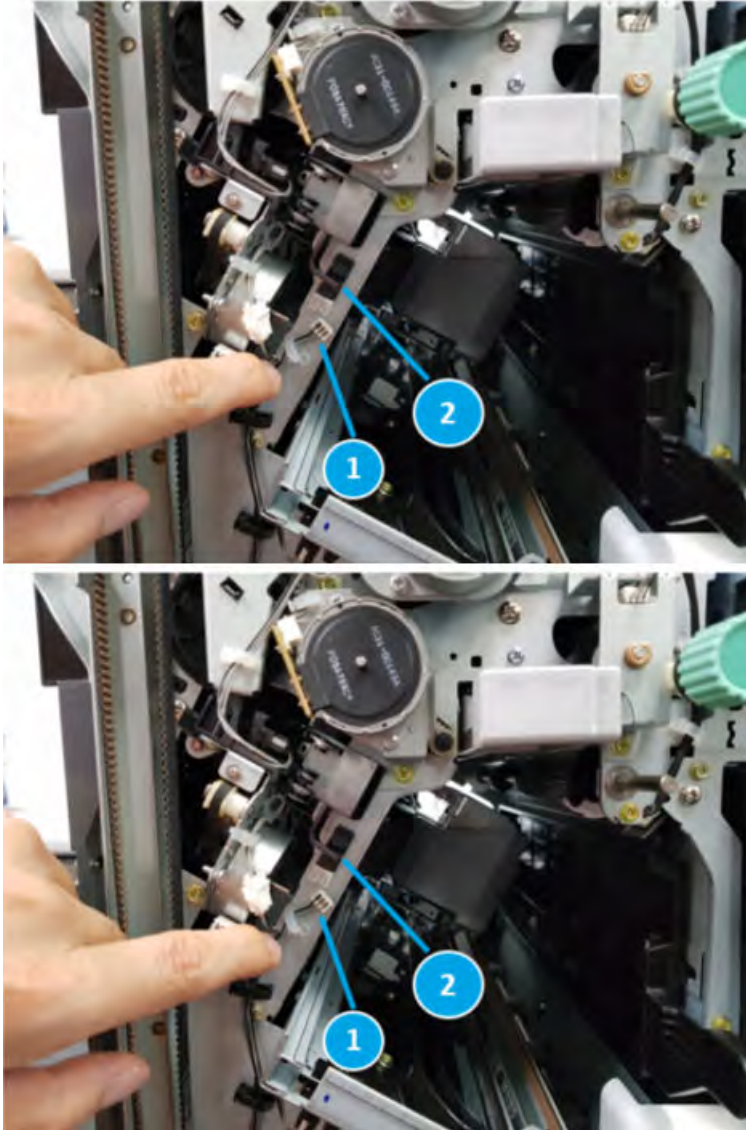


### Remove the manual staple sensor(S19)

Follow these steps to remove the manual staple sensor(S19).

- ▲ At the front of the finisher, disconnect the connector(callout 1) and remove manual staple sensor(S19, callout 2).

Figure 5-918 Remove the manual staple sensor



### Unpack the replacement assembly

Follow these steps to unpack the replacement assembly.

1. Dispose of the defective part.



---

 **NOTE:** HP recommends responsible disposal of the defective part.


<http://www8.hp.com/us/en/hp-information/environment/product-recycling.html>

---

2. Unpack the replacement part from the packaging.


 **CAUTION:**  Some parts are sensitive to electrostatic discharge (ESD). Always perform service work at an ESD-protected workstation or mat. If an ESD workstation or mat is not available, touch the sheet-metal chassis to provide a static ground before touching an ESD-sensitive assembly. Protect the ESD-sensitive assemblies by placing them in ESD pouches when they are out of the printer.

 **IMPORTANT:** Make sure that all of the shipping materials (for example shipping tape) are removed from the replacement part prior to installation.

 **NOTE:** If the replacement part is a roller or pad, avoid touching the spongy part of it. Skin oils on the roller or pad can cause paper pickup and/or print-quality problems. HP recommends using disposable gloves when handling rollers or pads or washing your hands before touching rollers or pads.

---

3. To install an assembly, reverse the removal steps.

 **NOTE:** When applicable, special installation instructions are provided for an assembly at the end of the removal procedure. Always completely read the removal instructions and follow all special installation instructions.


---

## Removal and replacement: Stapler position motor (M8)

Learn how to remove and replace the stapler position motor.

### Introduction

This document provides the procedures to remove and replace the stapler position motor on the finisher.

 **IMPORTANT:** When applicable, special installation instructions are provided for an assembly at the end of the removal procedure. Always completely read the removal instructions and follow all special installation instructions.

### Before performing service

- Turn the printer power off. A shutting-down message appears on the control-panel display.
- ⚠ **WARNING!** To avoid damage to the printer, turn the power off and wait until the printer shuts down before removing the power cable.
- Disconnect the printer power cable after the printer has completely shut down (the control-panel display is blank).
- Release the finisher from the printer by pulling out on the release latch inside the finisher door.
- Disconnect the cable from the bridge unit to the finisher.
- Disconnect the cable from the finisher to the printer.

Use the table below to identify the correct part number for your printer. To order the part, go to <https://parts.hp.com>.

**Table 5-125 Part information**

Part number	Part description
JC31-00163A	Stapler position motor

### Required tools

- #2 JIS screwdriver with a magnetic tip

### After performing service

- Connect the cable from the finisher to the printer.
- Connect the cable from the bridge unit to the finisher.
- Attach the finisher to the printer, and then push in on the release latch inside the finisher door.
- Connect the printer power cable.
- Turn the printer power on.

### Post service test

Process a job through the finisher and verify that the finisher works correctly.

### Remove the right upper cover (finisher)

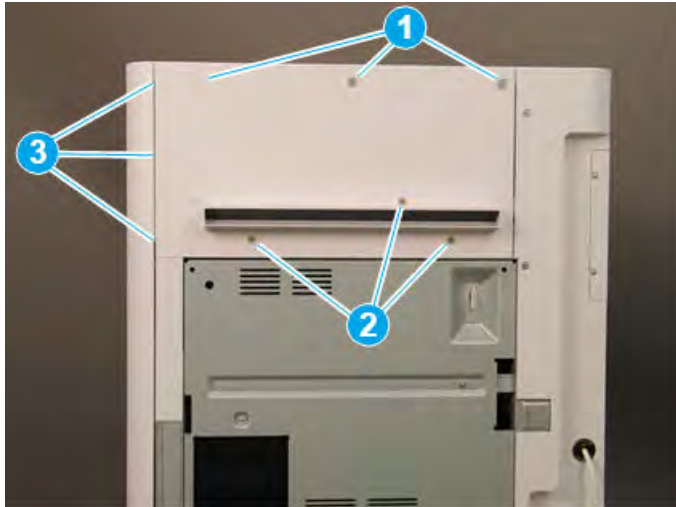
Follow these steps to remove the right upper cover (finisher).

- ▲ Remove one screw cap and three machine screws on the upper edge of the cover (callout 1). Remove three sheet metal screws (callout 2) on the lower portion of the cover. Rotate the right edge of the cover away from the finisher, and then slide the cover right to release three tabs (callout 3).

💡 **TIP:** The lower screws are shorter in length than the upper screws.

**TIP:** Reverse the removal steps to install the assembly.

Figure 5-919 Remove the right upper cover

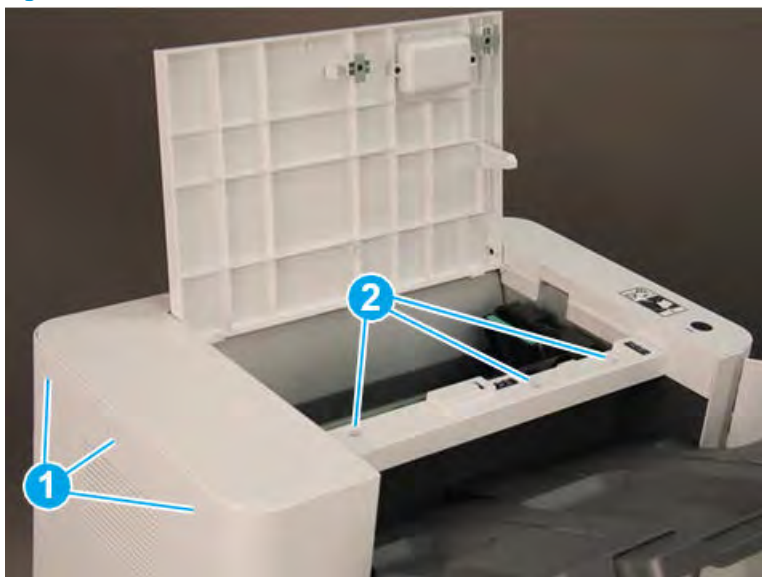


### Remove the top cover (finisher)

Follow these steps to remove the top cover (finisher).

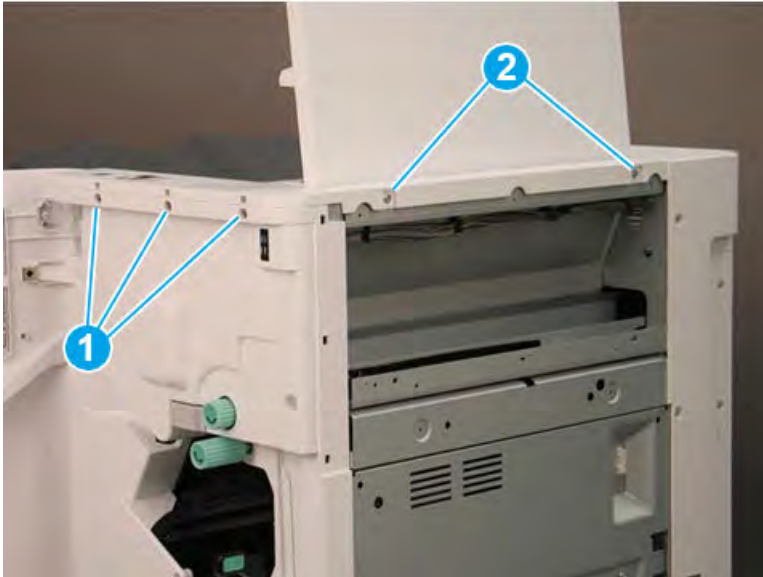
1. Remove three screw caps and three self-tapping screws at the top of the rear cover (callout 1), and then remove three machine screws (callout 2) on top of the cover.

Figure 5-920 Remove six screws




2. Remove three self-tapping screws at the top of the front cover (callout 1), and then remove two machine screws (callout 2) at the top of the right side.

**Figure 5-921** Remove five screws



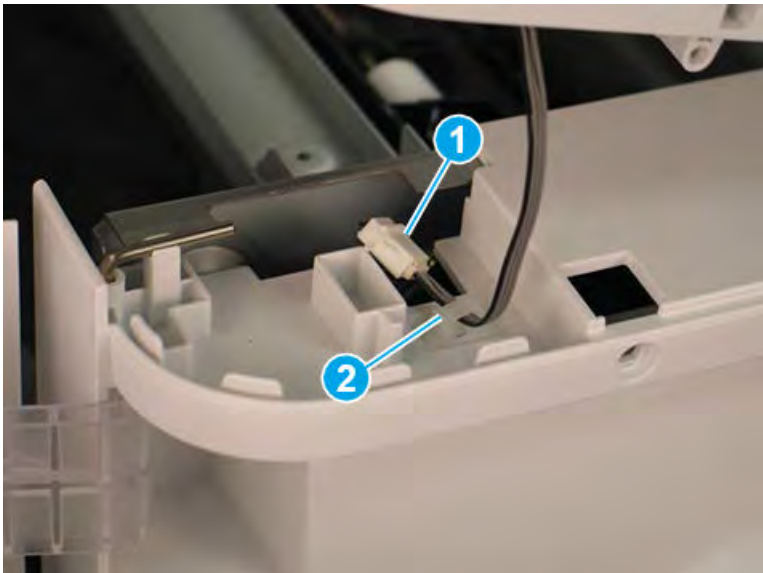
3. Lift the cover up slightly. Disconnect one in-line connector (callout 1), and then release one retainer (callout 2).

---

 **TIP:** Reverse the removal steps to install the assembly.

---

**Figure 5-922** Disconnect one connector and release retainer



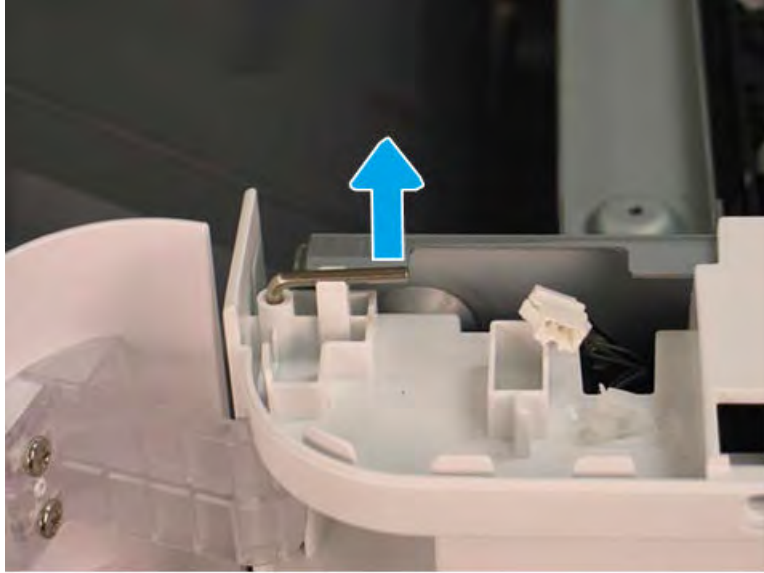
### Remove the front door (finisher)

Follow these steps to remove the front door (finisher).

1. Lift the top hinge pin up to release it from the retainer.

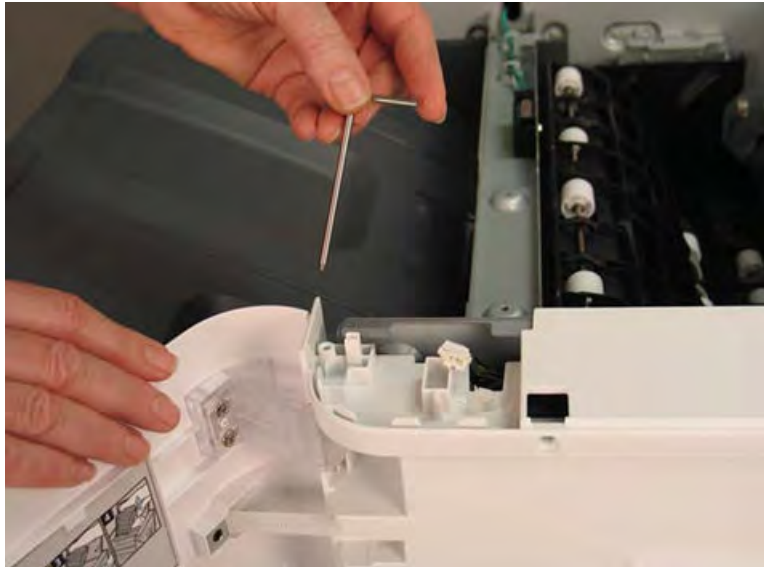


Figure 5-923 Lift the top hinge pin



2. Pull the top hinge pin up to remove it.

Figure 5-924 Remove the top hinge pin



3. Use a small, flat-blade screwdriver to release the lower hinge pin from the retainer, and then rotate it away from the finisher.

**Figure 5-925** Release the lower hinge pin




4. Support the door with one hand, and then pull the lower hinge pin straight up to remove it.

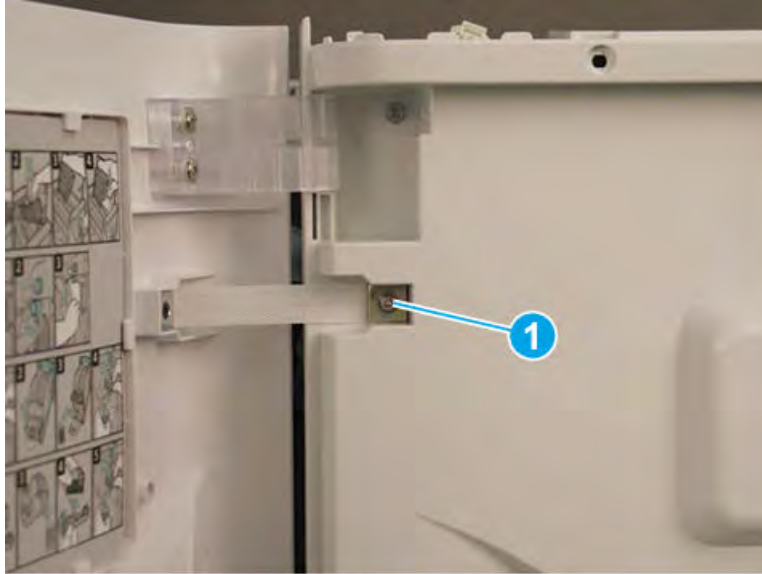
**Figure 5-926** Remove the lower hinge pin



5. Support the door with one hand, and then remove one screw (callout 1) to release the strap. Remove the front door.

 **TIP:** Reverse the removal steps to install the assembly.

**Figure 5-927** Remove the front door

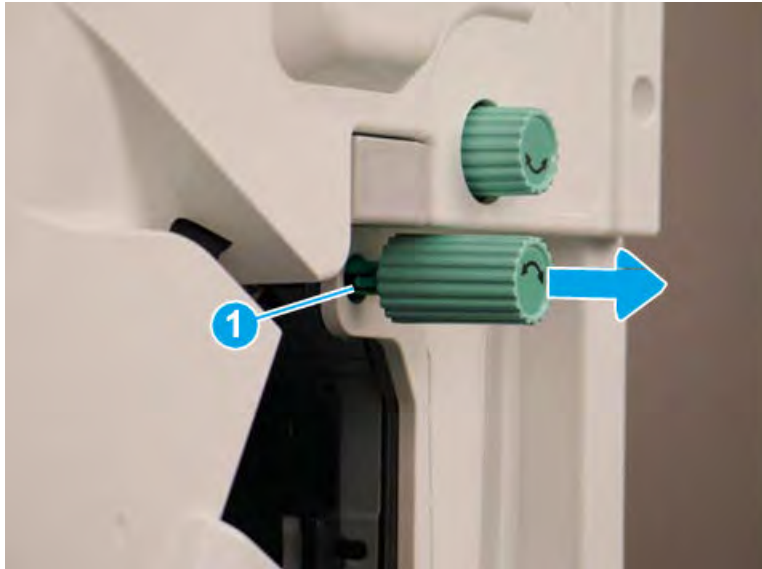


#### Remove the front cover (finisher)

Follow these steps to remove the front cover (finisher).

1. Release one tab (callout 1), and then pull the jam-access knob away from the finisher to remove it.

**Figure 5-928** Remove the jam-access knob



2. If the punch unit is installed, remove the punch waste bin (callout 1).

3. Remove one screw (callout 1) on top of the front cover.

Figure 5-929 Remove one screw



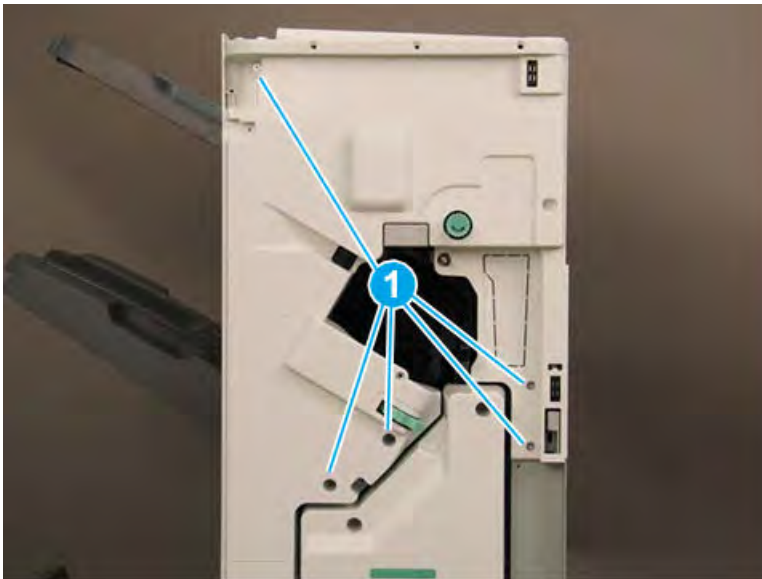
4. Remove five machine screws (callout 1), and then remove the front cover.

---

 **TIP:** Reverse the removal steps to install the assembly.

---

Figure 5-930 Remove the front cover

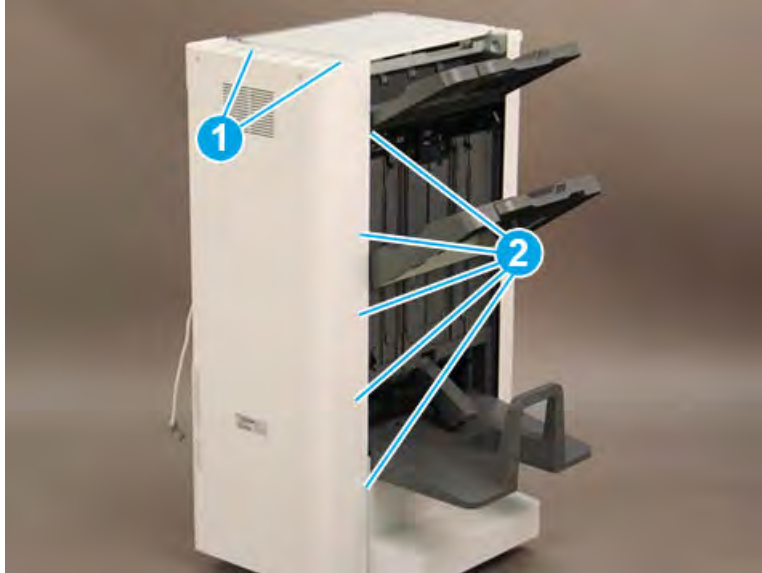


#### Remove the rear cover (finisher)

Follow these steps to remove the rear cover (finisher).


1. Remove two self-tapping screws (callout 1) on the top of the rear cover, and then remove five screw caps and five machine screws (callout 2) on the left side of the cover.

Figure 5-931 Remove seven screws




2. Remove one screw cap and four machine screws (callout 1) Remove the rear cover.

---

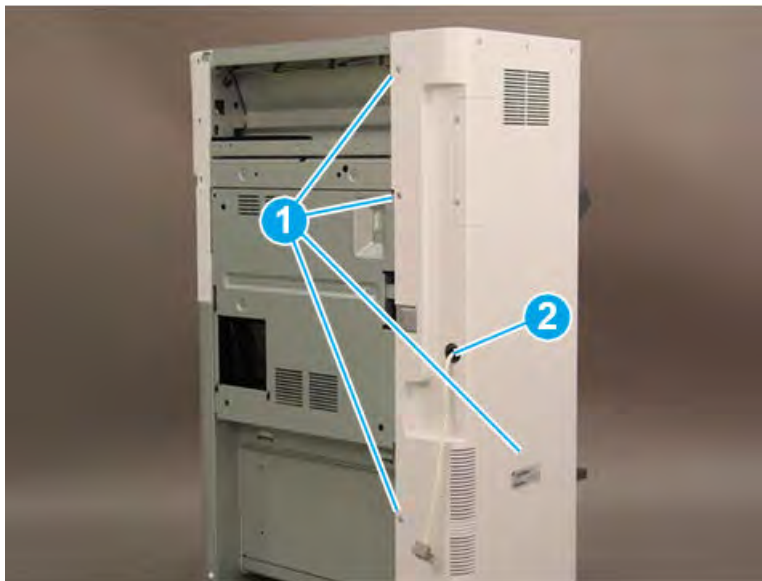
 **NOTE:** Make sure to thread the power cable (callout 2) through the opening in the cover.

---

 **TIP:** Reverse the removal steps to install the assembly

---

Figure 5-932 Remove the rear cover

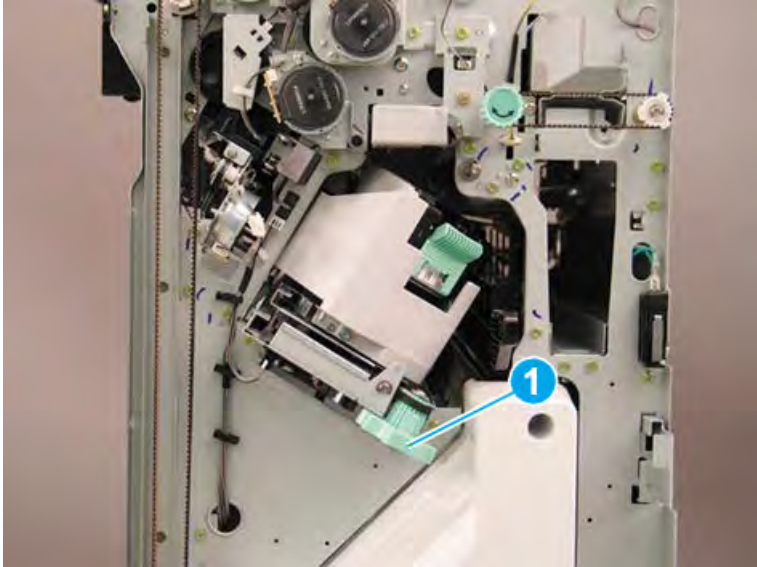


### Remove the stapler unit

Follow these steps to remove the stapler unit.

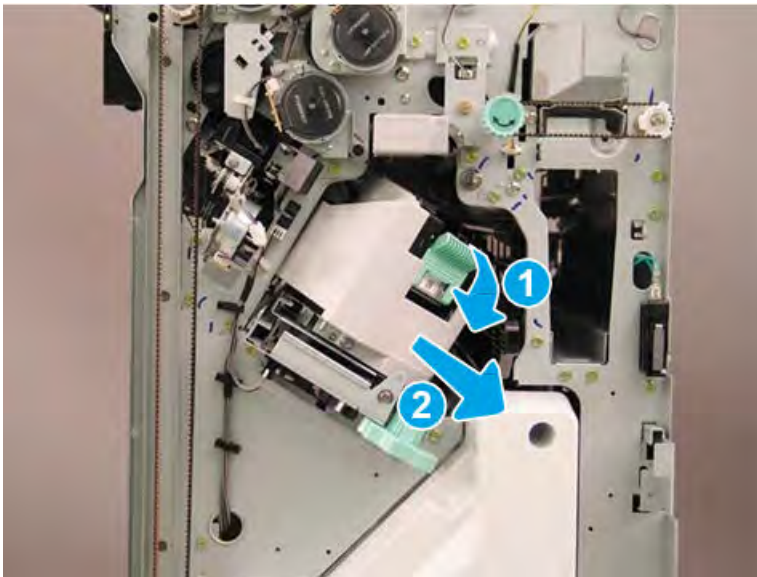
1. Rotate the green wheel to move the staple unit to the front until it stops.

Figure 5-933 Move the staple unit to the front



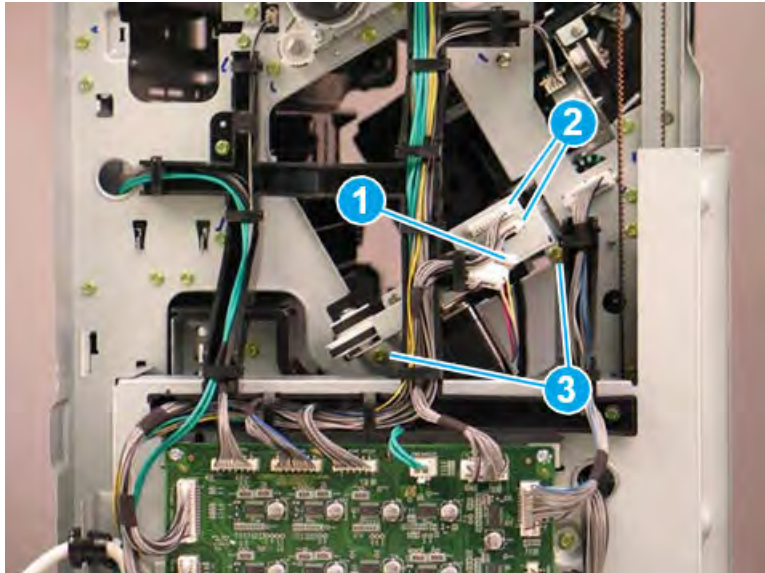
2. Lower the green latch (callout 1), and then slide the staple cartridge away from the finisher to remove it (callout 2).

Figure 5-934 Remove the staple cartridge



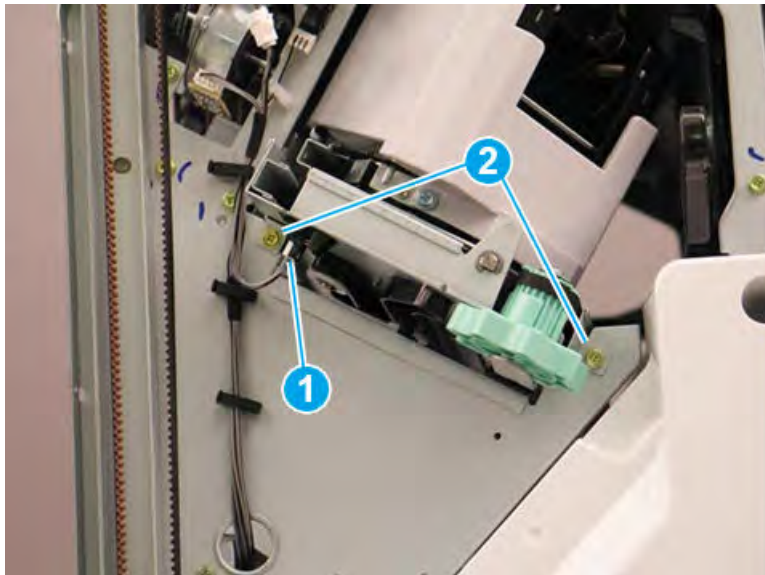
3. At the back of the finisher, release one retainer (callout 1), disconnect two connectors (callout 2), and then remove two screws (callout 3).

Figure 5-935 Disconnect three connectors and remove two screws




4. At the front of the finisher, disconnect one connector (callout 1), and then remove two screws (callout 2).

Figure 5-936 Disconnect one connector and remove two screws

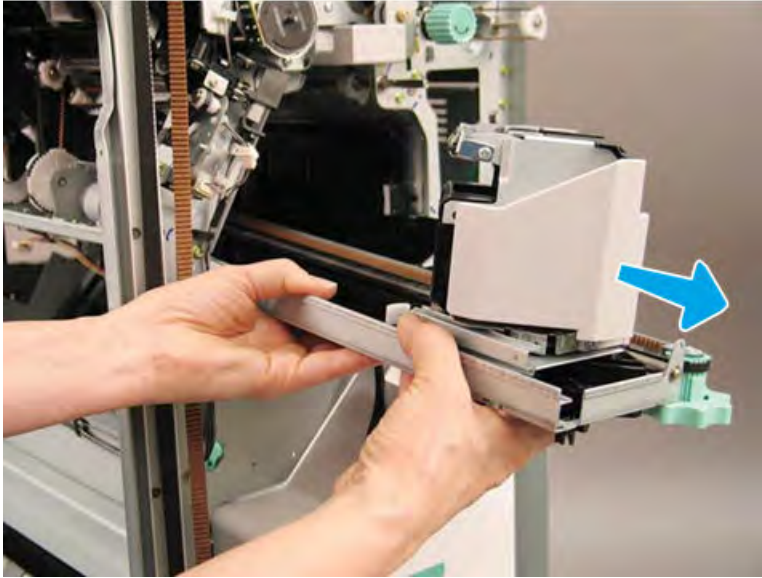


5. Lift up, and then slide the staple unit to the front of the finisher to remove it.

 **TIP:** Reverse the removal steps to install the assembly.

---

**Figure 5-937** Remove the staple unit



#### Remove the stapler position motor(M8)

Follow these steps to remove the stapler position motor(M8).

1. Remove two screws(callout 1)

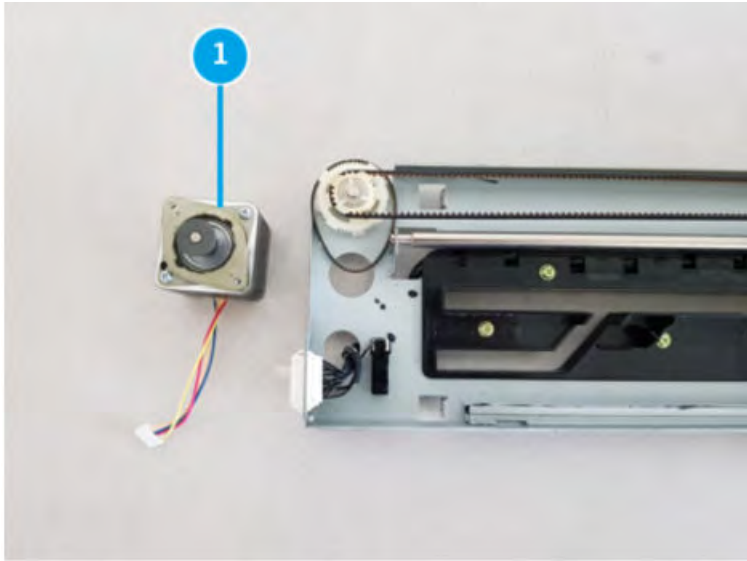
**Figure 5-938** Remove two screws





2. Remove stapler position motor(M8, callout1) from staple unit.

Figure 5-939 Remove stapler position motor



### Unpack the replacement assembly



Follow these steps to unpack the replacement assembly.

1. Dispose of the defective part.


 **NOTE:** HP recommends responsible disposal of the defective part.

<http://www8.hp.com/us/en/hp-information/environment/product-recycling.html>


2. Unpack the replacement part from the packaging.

 **CAUTION:**  Some parts are sensitive to electrostatic discharge (ESD). Always perform service work at an ESD-protected workstation or mat. If an ESD workstation or mat is not available, touch the sheet-metal chassis to provide a static ground before touching an ESD-sensitive assembly. Protect the ESD-sensitive assemblies by placing them in ESD pouches when they are out of the printer.

 **IMPORTANT:** Make sure that all of the shipping materials (for example shipping tape) are removed from the replacement part prior to installation.

 **NOTE:** If the replacement part is a roller or pad, avoid touching the spongy part of it. Skin oils on the roller or pad can cause paper pickup and/or print-quality problems. HP recommends using disposable gloves when handling rollers or pads or washing your hands before touching rollers or pads.

3. To install an assembly, reverse the removal steps.

 **NOTE:** When applicable, special installation instructions are provided for an assembly at the end of the removal procedure. Always completely read the removal instructions and follow all special installation instructions.

## Ejector unit

## Removal and replacement: Ejector unit

Learn how to remove and replace the ejector unit.

### Introduction

This document provides the procedures to remove and replace the ejector unit on the finisher.



**IMPORTANT:** When applicable, special installation instructions are provided for an assembly at the end of the removal procedure. Always completely read the removal instructions and follow all special installation instructions.

### Before performing service

- Turn the printer power off. A shutting-down message appears on the control-panel display.
- ⚠ **WARNING!** To avoid damage to the printer, turn the power off and wait until the printer shuts down before removing the power cable.
- Disconnect the printer power cable after the printer has completely shut down (the control-panel display is blank).
- Release the finisher from the printer by pulling out on the release latch inside the finisher door.
- Disconnect the cable from the bridge unit to the finisher.
- Disconnect the cable from the finisher to the printer.

Use the table below to identify the correct part number for your printer. To order the part, go to <https://parts.hp.com>.

**Table 5-126 Part information**

Part number	Part description
JC90-01409A	Ejector unit

### Required tools

- #2 JIS screwdriver with a magnetic tip
- Small, flat-blade screwdriver

### After performing service

- Connect the cable from the finisher to the printer.
- Connect the cable from the bridge unit to the finisher.
- Attach the finisher to the printer, and then push in on the release latch inside the finisher door.
- Connect the printer power cable.
- Turn the printer power on.

### Post service test

Process a job through the finisher and verify that the finisher works correctly.

## Remove the right upper cover (finisher)

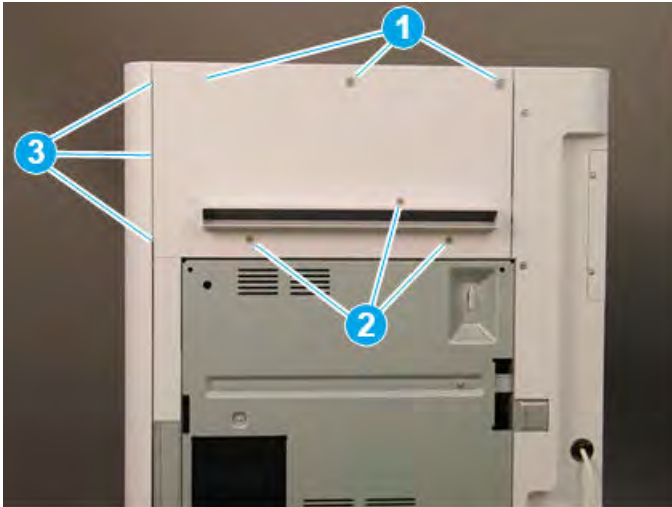
Follow these steps to remove the right upper cover (finisher).

- ▲ Remove one screw cap and three machine screws on the upper edge of the cover (callout 1). Remove three sheet metal screws (callout 2) on the lower portion of the cover. Rotate the right edge of the cover away from the finisher, and then slide the cover right to release three tabs (callout 3).

💡 **TIP:** The lower screws are shorter in length than the upper screws.

**TIP:** Reverse the removal steps to install the assembly.

**Figure 5-940** Remove the right upper cover

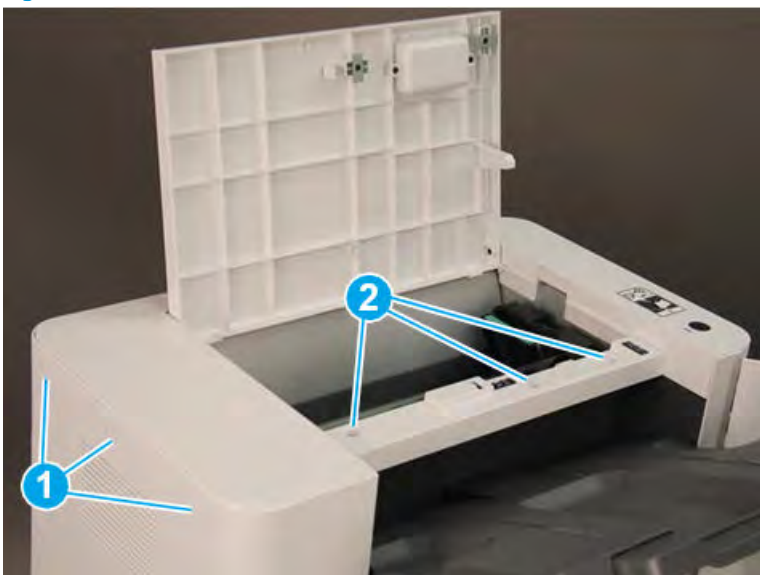


## Remove the top cover (finisher)

Follow these steps to remove the top cover (finisher).

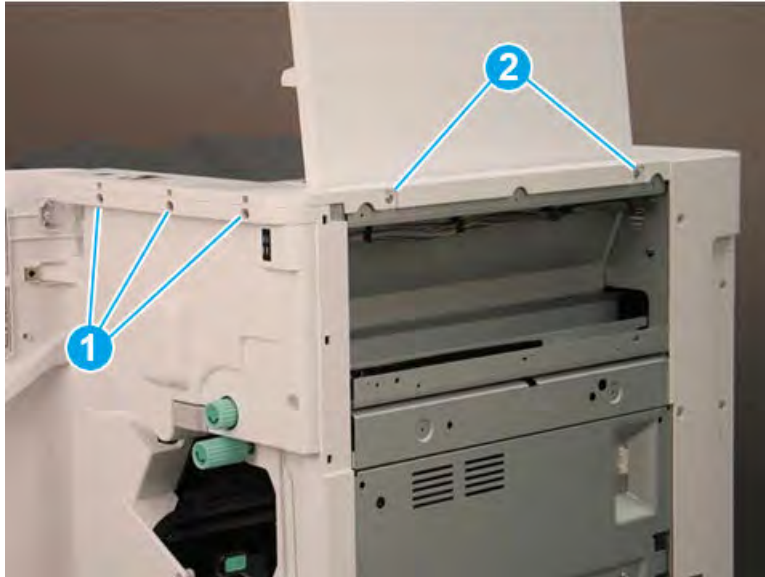
1. Remove three screw caps and three self-tapping screws at the top of the rear cover (callout 1), and then remove three machine screws (callout 2) on top of the cover.

**Figure 5-941** Remove six screws




2. Remove three self-tapping screws at the top of the front cover (callout 1), and then remove two machine screws (callout 2) at the top of the right side.

Figure 5-942 Remove five screws



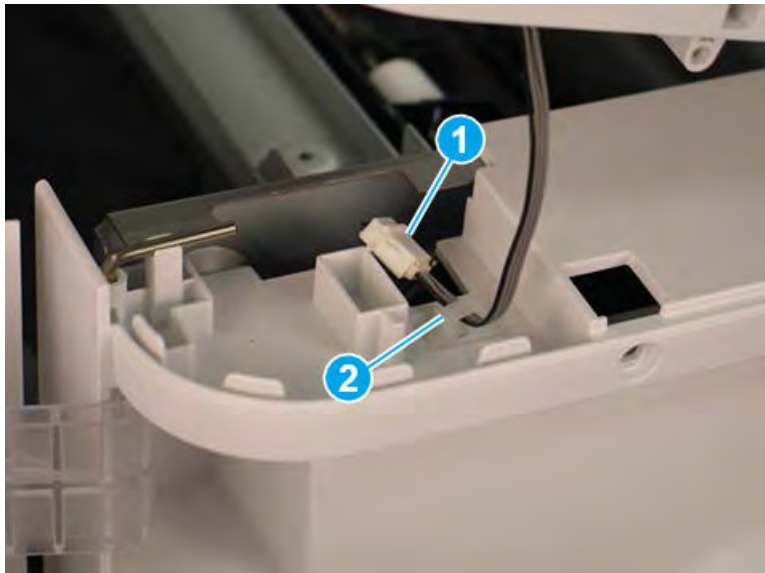
3. Lift the cover up slightly. Disconnect one in-line connector (callout 1), and then release one retainer (callout 2).

---

 **TIP:** Reverse the removal steps to install the assembly.

---

Figure 5-943 Disconnect one connector and release retainer

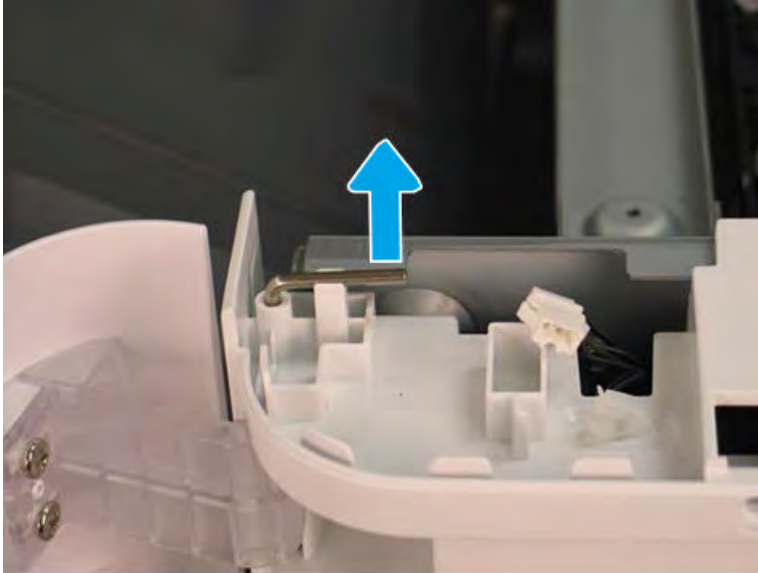


### Remove the front door (finisher)

Follow these steps to remove the front door (finisher).

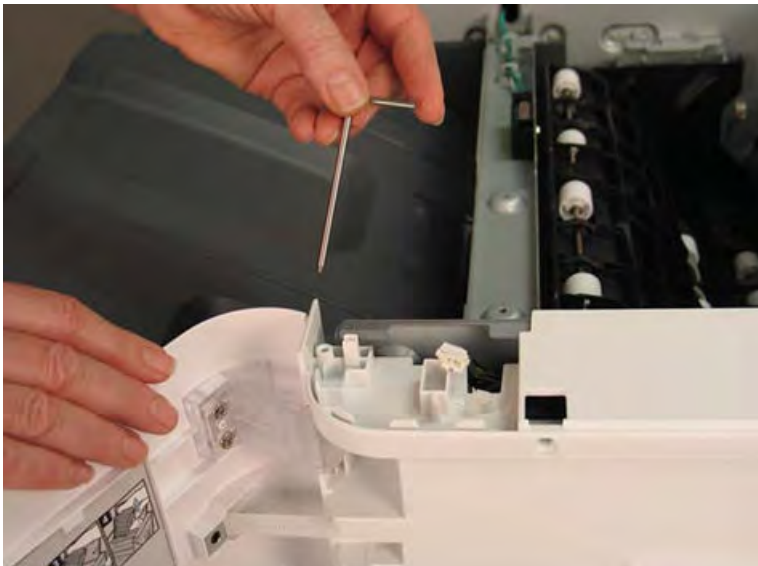
1. Lift the top hinge pin up to release it from the retainer.

Figure 5-944 Lift the top hinge pin



2. Pull the top hinge pin up to remove it.

Figure 5-945 Remove the top hinge pin



3. Use a small, flat-blade screwdriver to release the lower hinge pin from the retainer, and then rotate it away from the finisher.

Figure 5-946 Release the lower hinge pin




4. Support the door with one hand, and then pull the lower hinge pin straight up to remove it.

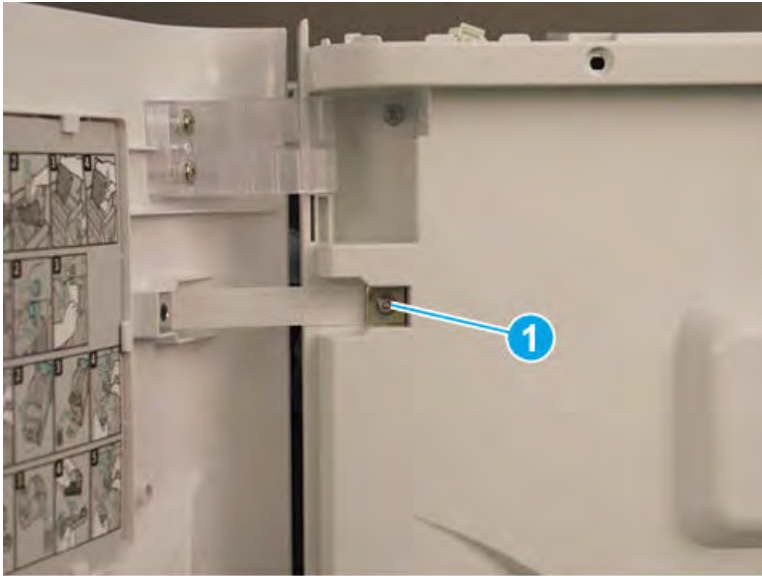
Figure 5-947 Remove the lower hinge pin



5. Support the door with one hand, and then remove one screw (callout 1) to release the strap. Remove the front door.

 **TIP:** Reverse the removal steps to install the assembly.

**Figure 5-948** Remove the front door

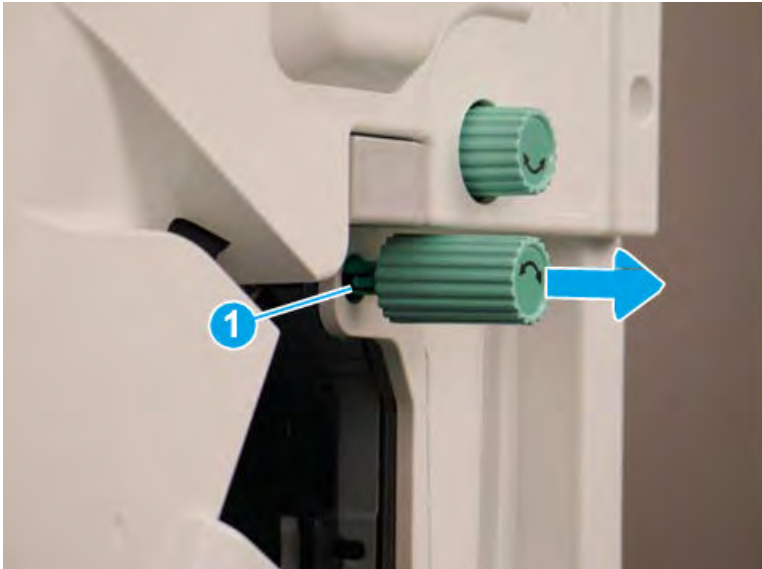


#### Remove the front cover (finisher)

Follow these steps to remove the front cover (finisher).

1. Release one tab (callout 1), and then pull the jam-access knob away from the finisher to remove it.

**Figure 5-949** Remove the jam-access knob



2. If the punch unit is installed, remove the punch waste bin (callout 1).




3. Remove one screw (callout 1) on top of the front cover.

Figure 5-950 Remove one screw



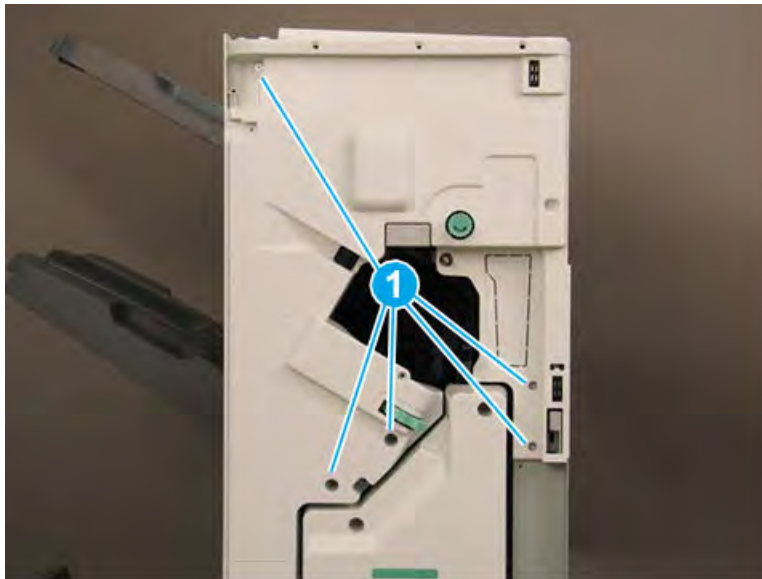
4. Remove five machine screws (callout 1), and then remove the front cover.

---

 **TIP:** Reverse the removal steps to install the assembly.

---

Figure 5-951 Remove the front cover

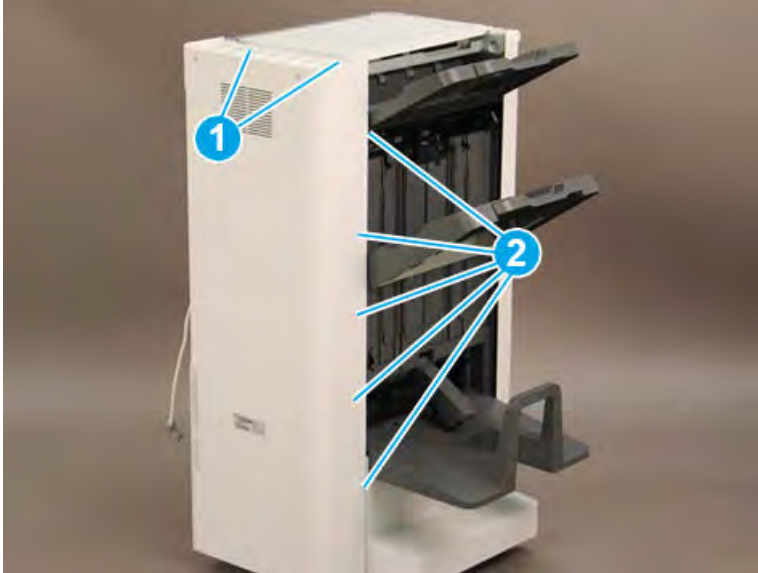


### Remove the rear cover (finisher)

Follow these steps to remove the rear cover (finisher).

1. Remove two self-tapping screws (callout 1) on the top of the rear cover, and then remove five screw caps and five machine screws (callout 2) on the left side of the cover.


Figure 5-952 Remove seven screws



2. Remove one screw cap and four machine screws (callout 1) Remove the rear cover.

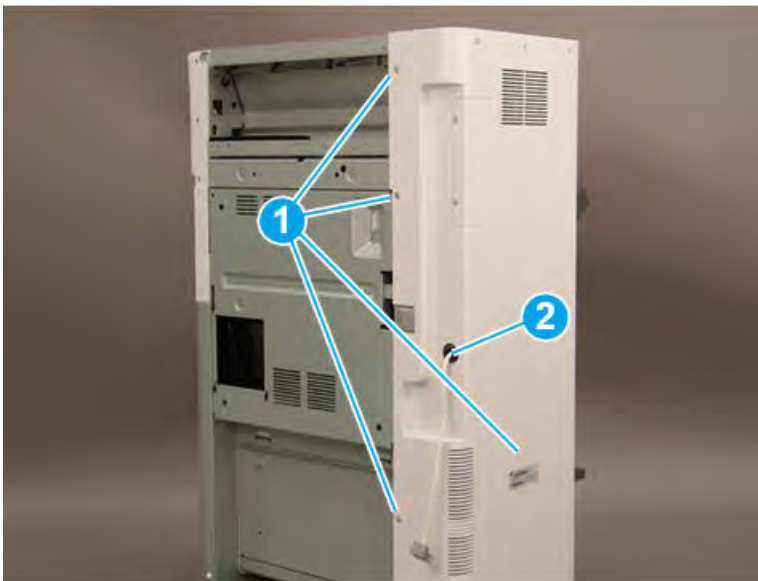
---

 **NOTE:** Make sure to thread the power cable (callout 2) through the opening in the cover.

 **TIP:** Reverse the removal steps to install the assembly

---

Figure 5-953 Remove the rear cover



### Remove the booklet output tray

Follow these steps to remove the booklet output tray.

1. Raise the booklet output tray up (callout 1), and then pull it away from the finisher (callout 2) to remove it.

Figure 5-954 Remove the booklet output tray



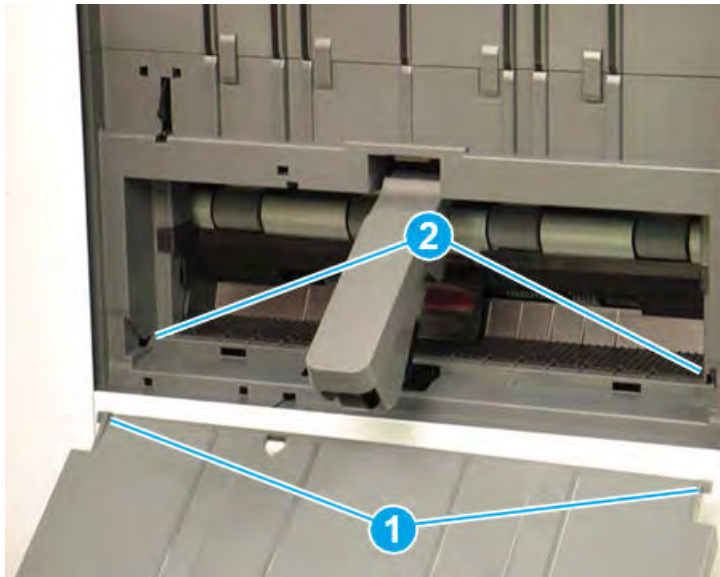
2. Reverse the removal steps to install the assembly. Also use the following special installation instructions.

 **NOTE:** Continue to reverse the removal steps to finish installing the assembly

Special installation instructions: booklet output tray

Position the tabs (callout 1) on the tray into the slots (callout 2) on the finisher.

Figure 5-955 Install the booklet output tray

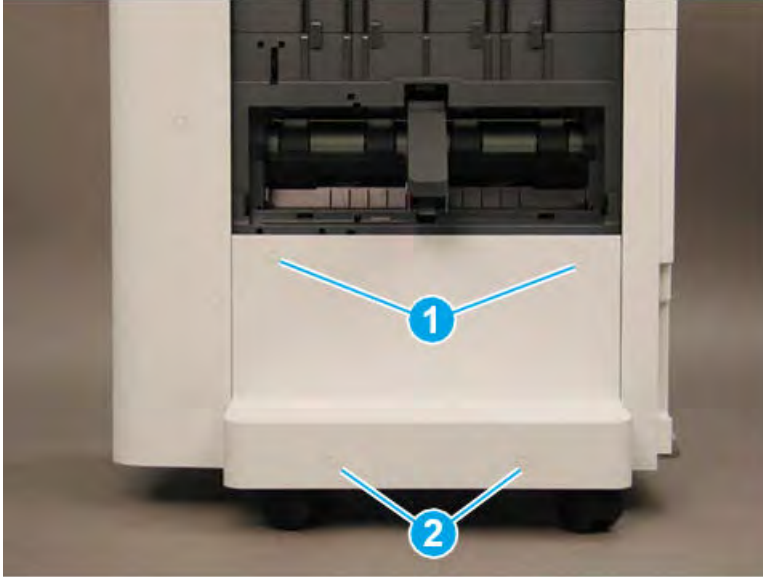


### Remove the caster cover

Follow these steps to remove the caster cover.


1. Remove two screw caps and two self-tapping screws (callout 1). Remove two screw caps and two machine screws (callout 2).

Figure 5-956 Remove four screws



2. Rotate the left edge of the cover away from the finisher (callout 1), and then slide the cover to the left (callout 2) to remove it.

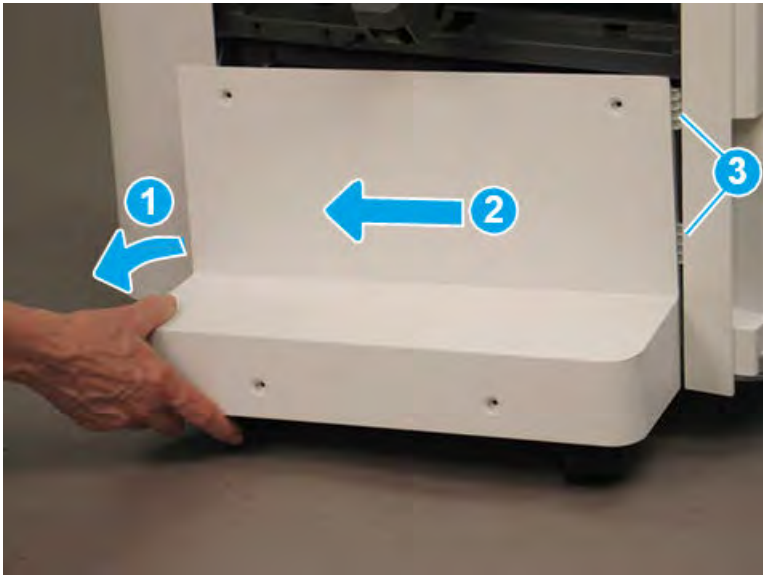
---

 **TIP:** Make sure that two tabs (callout 3) are positioned under the front lower cover when reinstalling the caster cover.

**TIP:** Reverse the removal steps to install the assembly

---

Figure 5-957 Remove the caster cover




### Remove the left lower cover (finisher)

Follow these steps to remove the left lower cover (finisher).

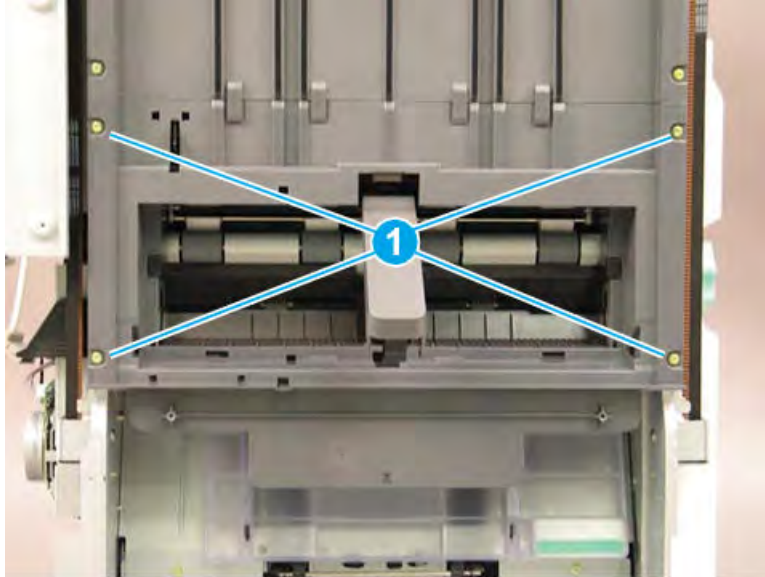
1. Remove four screws (callout 1).

---

 **NOTE:** Raise the lower output tray as needed to access the screws.

---

Figure 5-958 Remove four screws

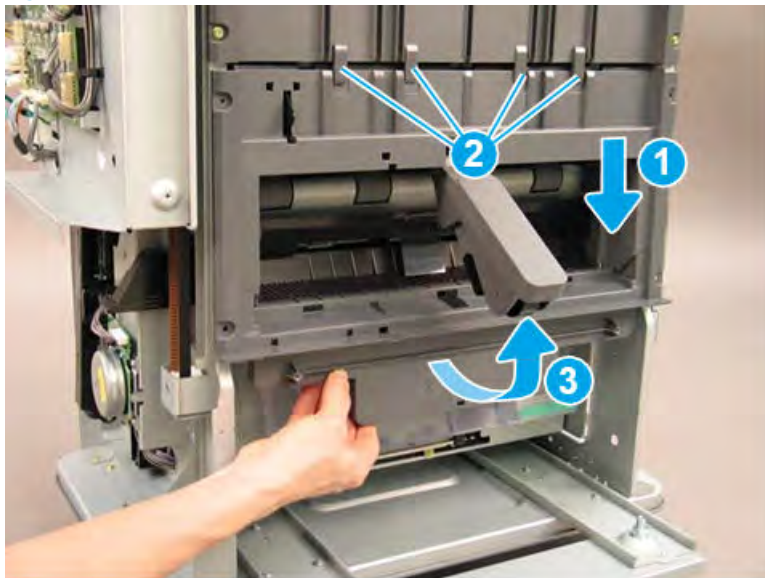


2. Slide the shield down (callout 1) to release it from four tabs (callout 2), and then rotate it away from the finisher (callout 3).

**⚠ CAUTION:** The shield is still attached to the finisher. Do not attempt to completely remove the shield.

**💡 TIP:** Position the shield under the four tabs (callout 2) when reinstalling it.

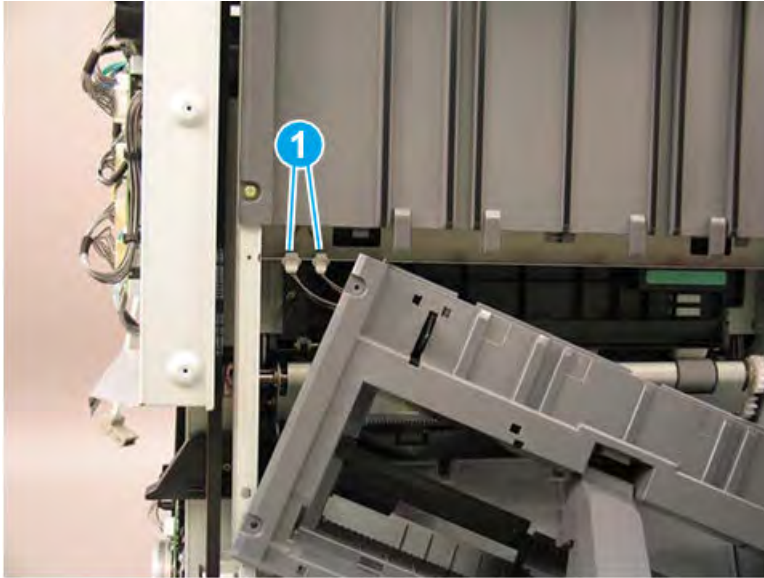
Figure 5-959 Release the lower shield



3. Disconnect two connectors (callout 1), and then remove the shield.

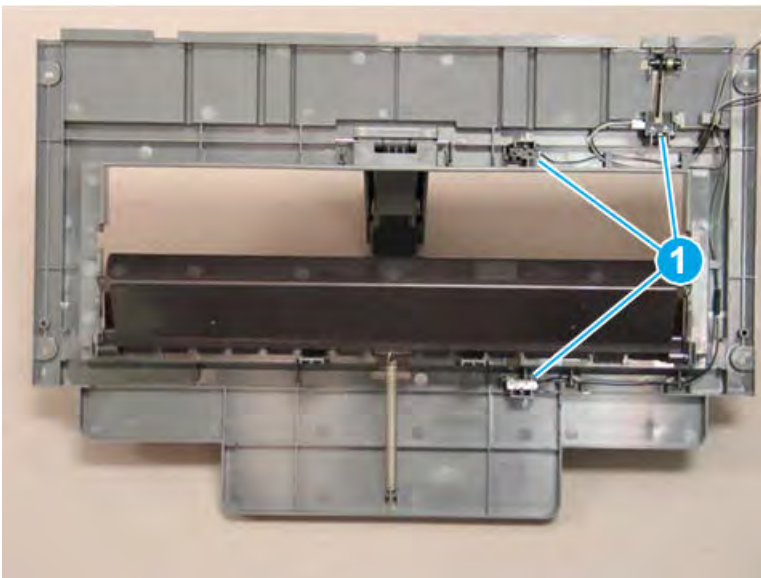
 **TIP:** Reverse the removal steps to install the assembly.

**Figure 5-960** Disconnect two connectors



4. If you are replacing the left lower cover, locate three sensors (callout 1) on the back of the left lower cover. Remove these sensors and transfer them to the replacement part.

**Figure 5-961** Remove the left lower cover

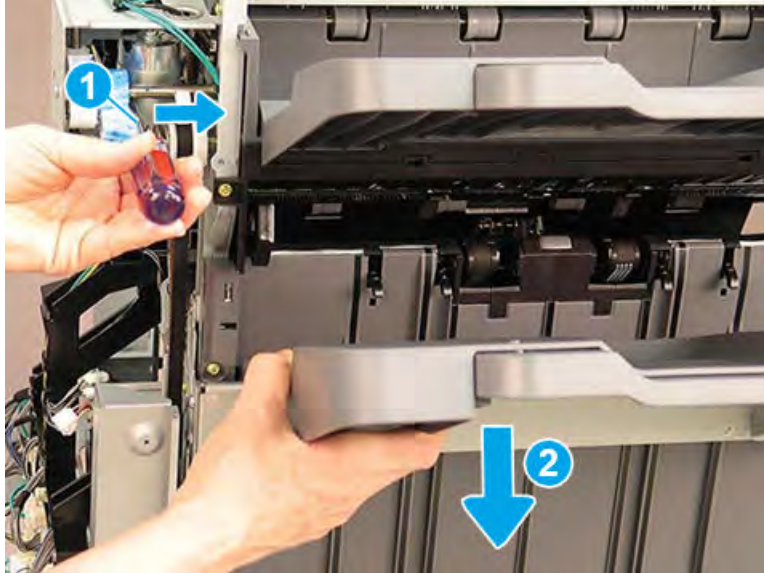


### Remove the left upper cover (finisher)

Follow these steps to remove the left upper cover (finisher).

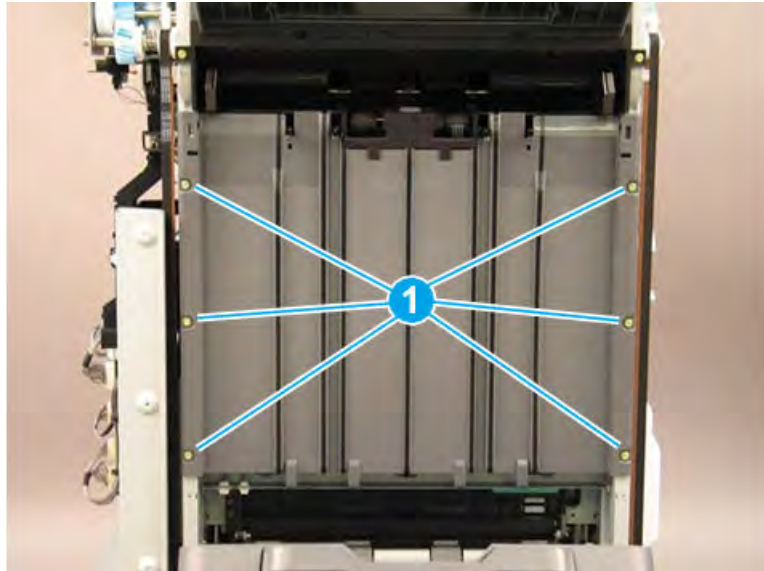
1. Bring the lower output tray down by positioning the shaft of a screwdriver on the clutch (callout 1) and gently pressing to the right to release the clutch. Hold the clutch in the released position and lower the tray (callout 2) to the lowest position.

Figure 5-962 Lower the output tray



2. Remove six machine screws (callout 1).

Figure 5-963 Remove six screws

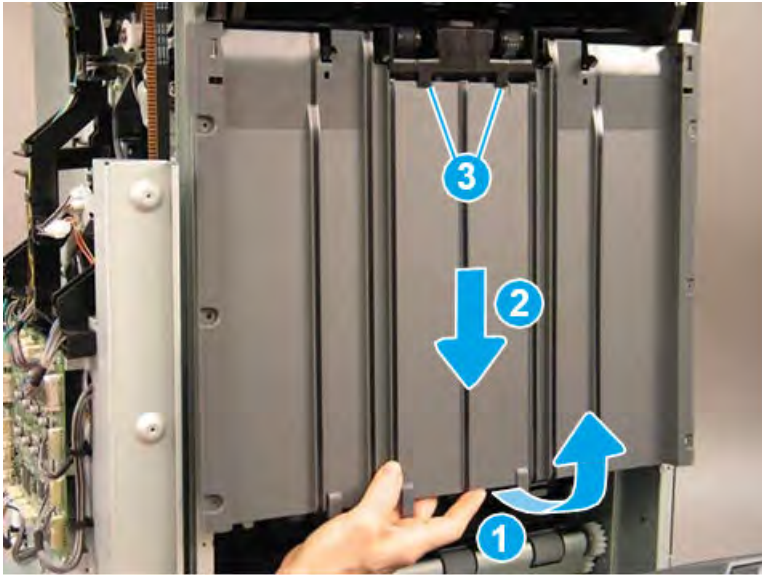


3. Rotate the lower edge of the shield away from the finisher (callout 1), and then slide the shield down (callout 2) to release it from two tabs (callout 3).

**⚠ CAUTION:** The shield is still attached to the finisher. Do not attempt to completely remove the shield.

**💡 TIP:** Position the shield under the two tabs (callout 3) when reinstalling it.

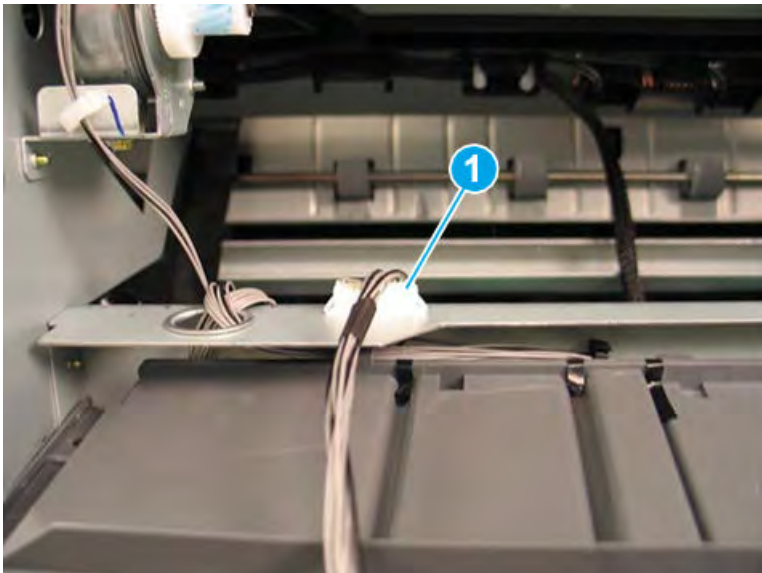
**Figure 5-964** Release the shield



4. Disconnect one connector (callout 1), and then remove the upper shield assembly.

**💡 TIP:** Reverse the removal steps to install the assembly.

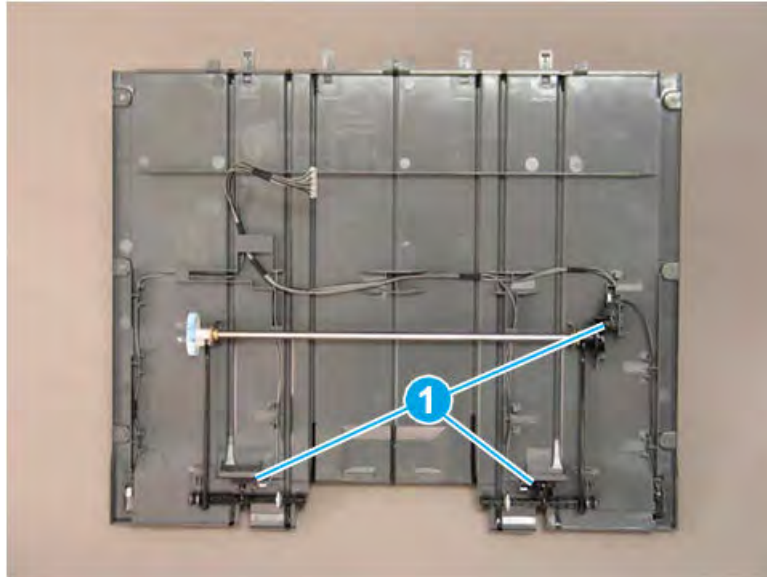
**Figure 5-965** Disconnect one connector





5. If you are replacing the left upper cover, locate three sensors (callout 1) on the back of the left upper cover. Remove these sensors and transfer them to the replacement part.

Figure 5-966 Remove the left upper cover

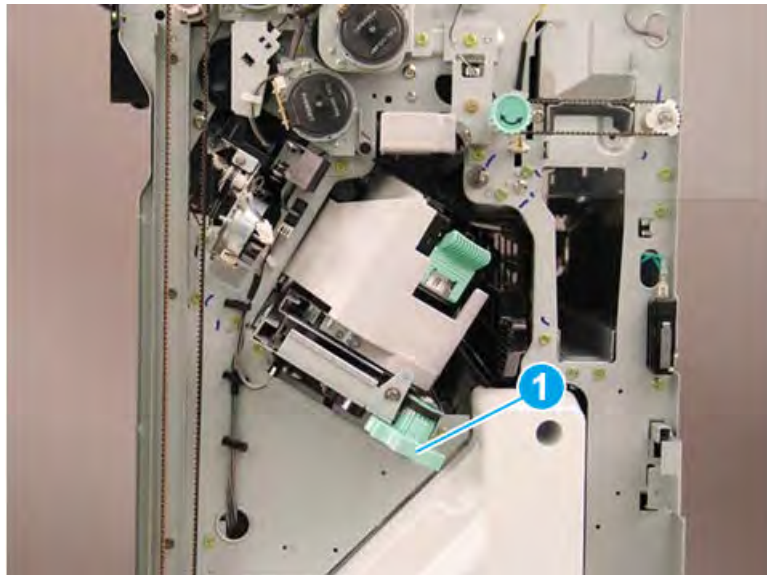


#### Remove the ejector unit (finisher)

Follow these steps to remove the ejector unit (finisher).

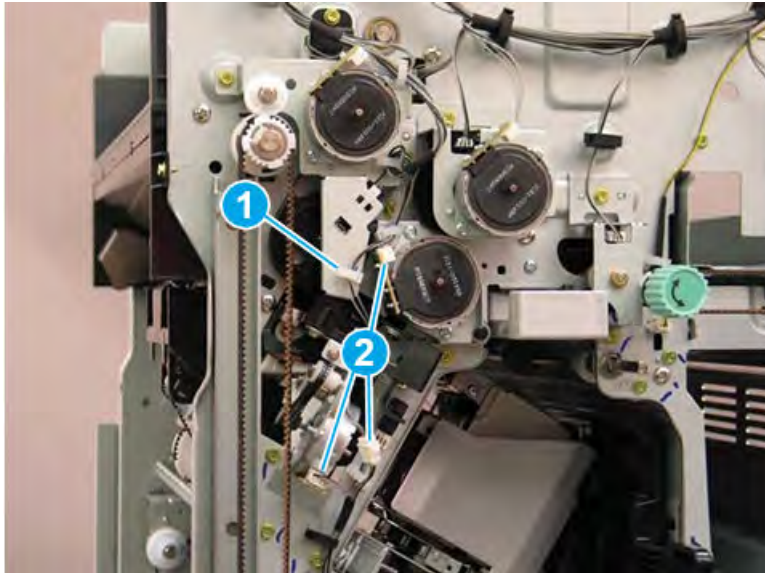
1. Rotate the green wheel to move the staple unit to the center of the finisher.

Figure 5-967 Move the staple unit to the center



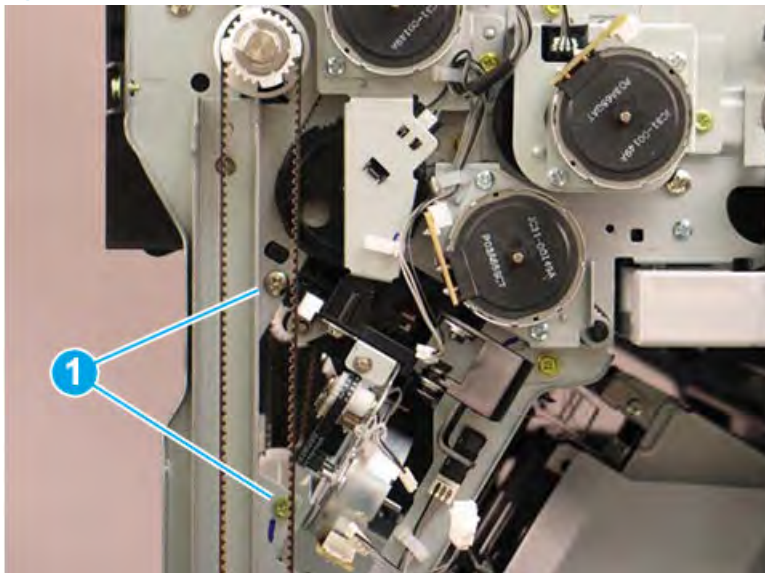
2. Release one retainer (callout 1), and then disconnect three connectors (callout 2).

Figure 5-968 Disconnect three connectors



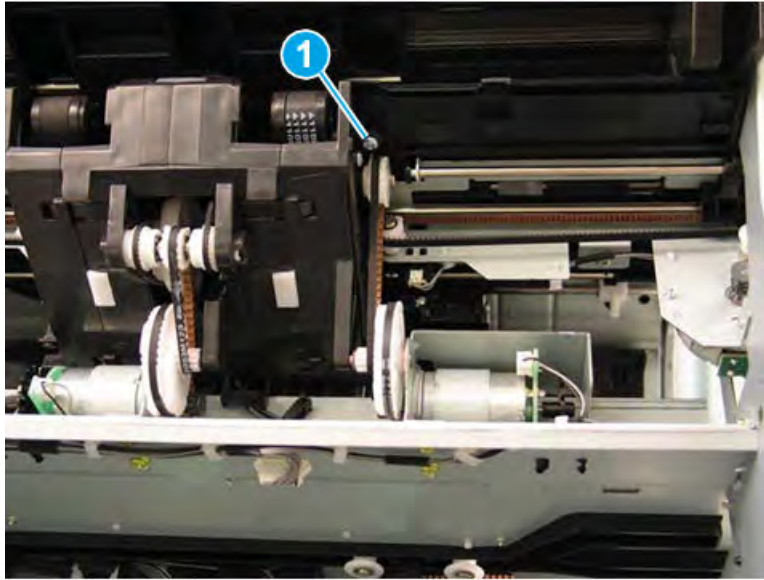
3. Remove two screws (callout 1).

Figure 5-969 Remove two screws



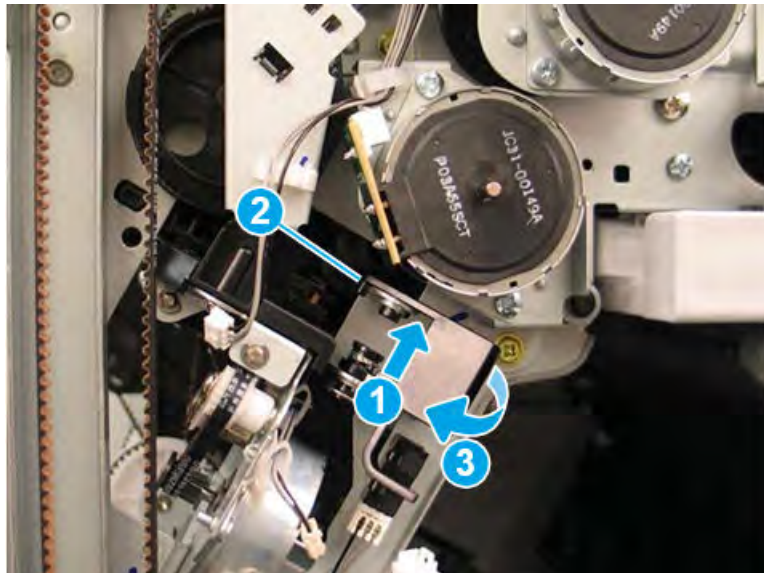
4. At the left side of the finisher, remove one screw (callout 1).

Figure 5-970 Remove one screw



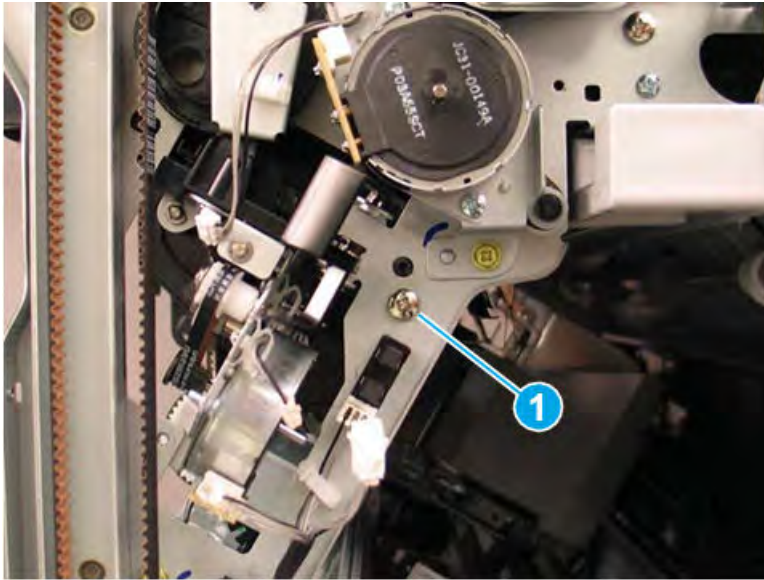
5. Press up on the hinge (callout 1), release one tab (callout 2), and then rotate the sensor away from the finisher (callout 3).

Figure 5-971 Rotate the sensor



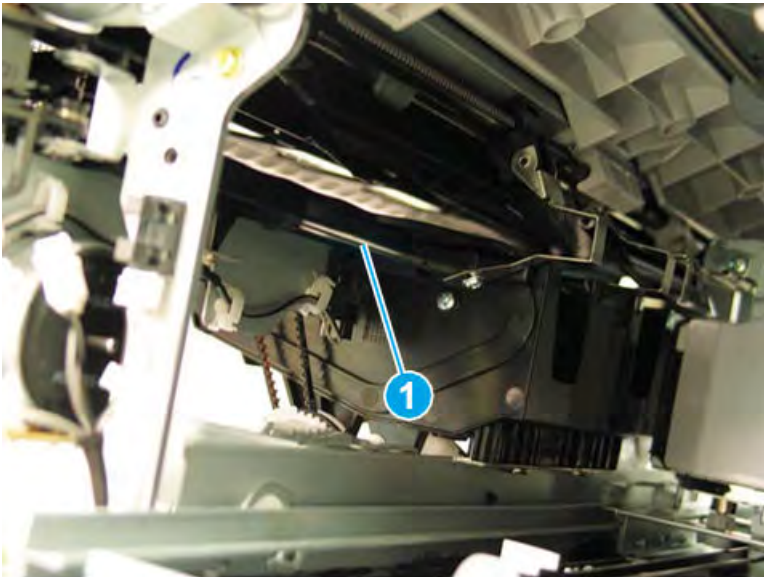
6. Remove one screw (callout 1).

Figure 5-972 Remove one screw



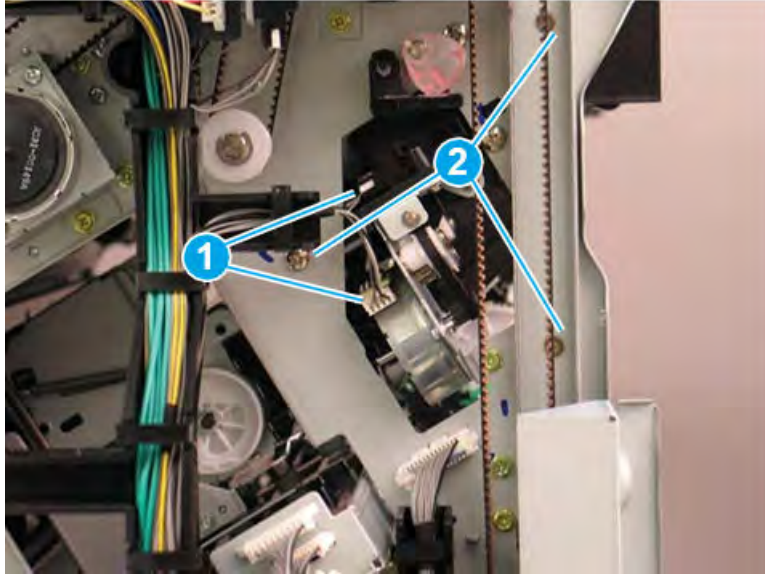
7. Look inside the finisher through the stapler opening in the front and pull down to release and remove one shaft (callout 1) on the front tamper unit.

Figure 5-973 Remove the front tamper shaft



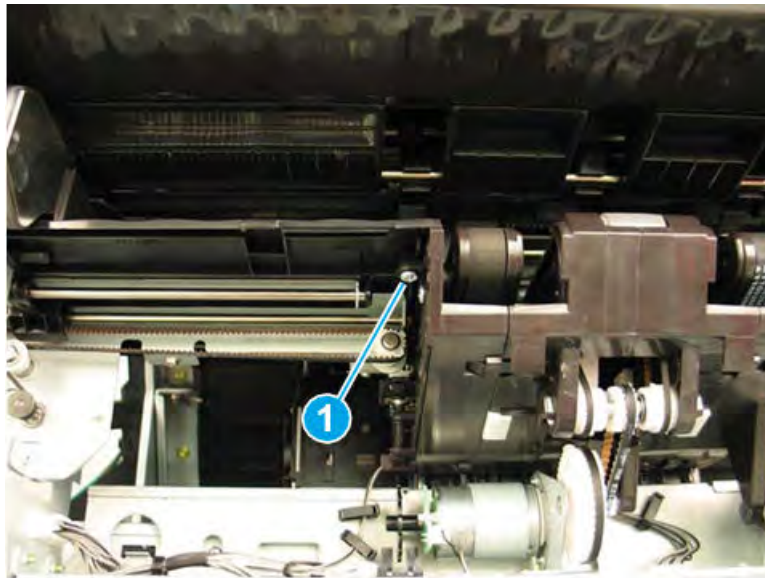
8. At the rear of the finisher, disconnect two connectors (callout 1), and then remove three screws (callout 2).

Figure 5-974 Disconnect two connectors and remove three screws



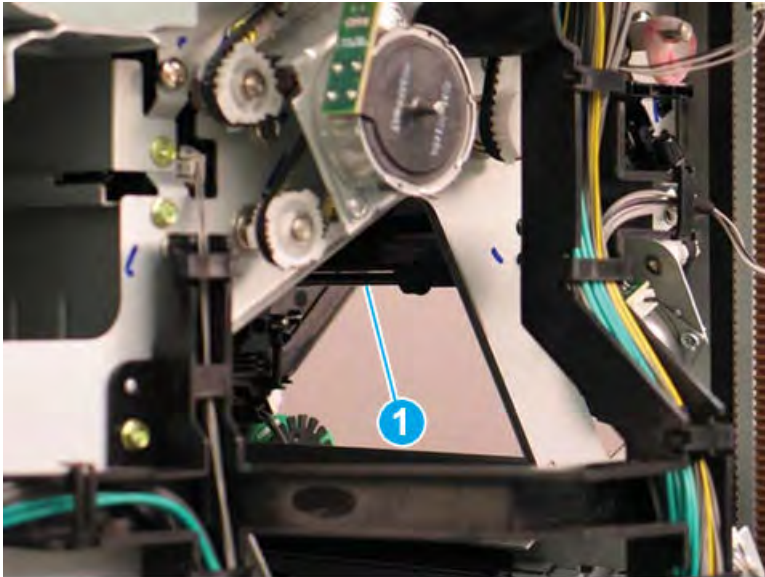
9. At the left side of the finisher, remove one screw (callout 1).

Figure 5-975 Remove one screw



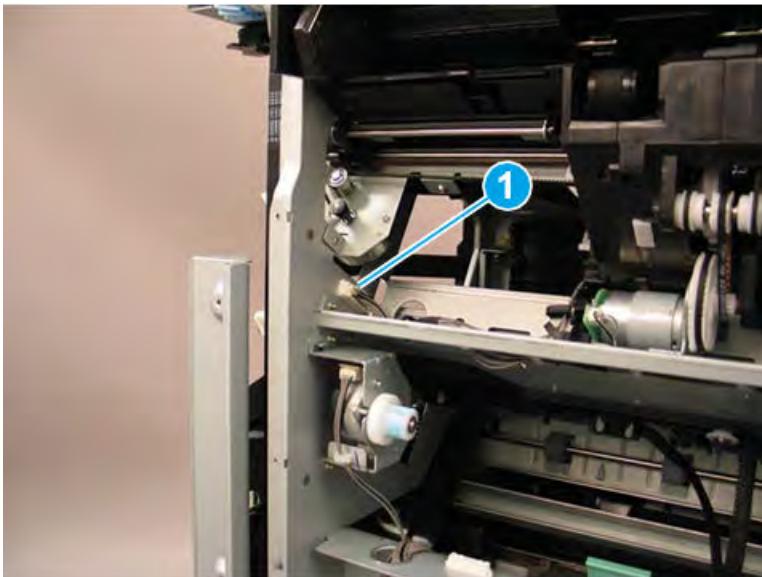
10. Look inside the finisher through the stapler opening in the rear and pull down to release and remove one shaft (callout 1) on the rear tamper unit.

Figure 5-976 Remove the rear tamper shaft



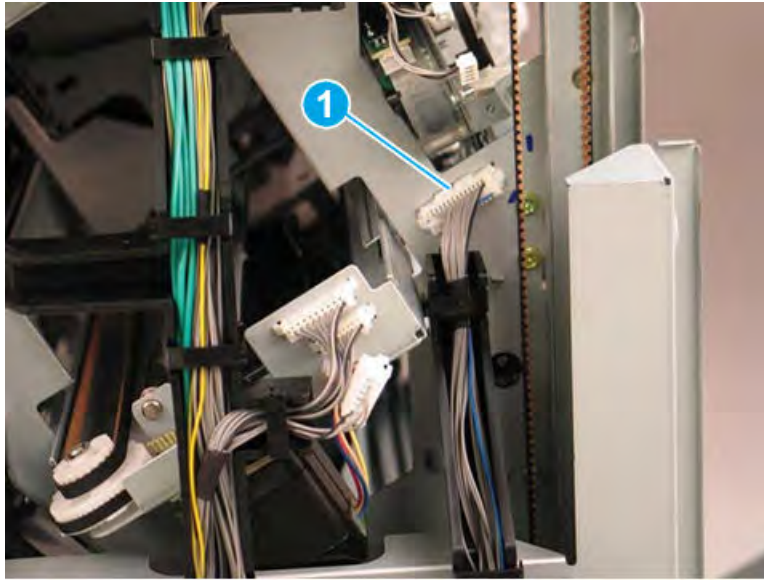
11. At the left side of the finisher, disconnect one connector (callout 1).

Figure 5-977 Disconnect one connector



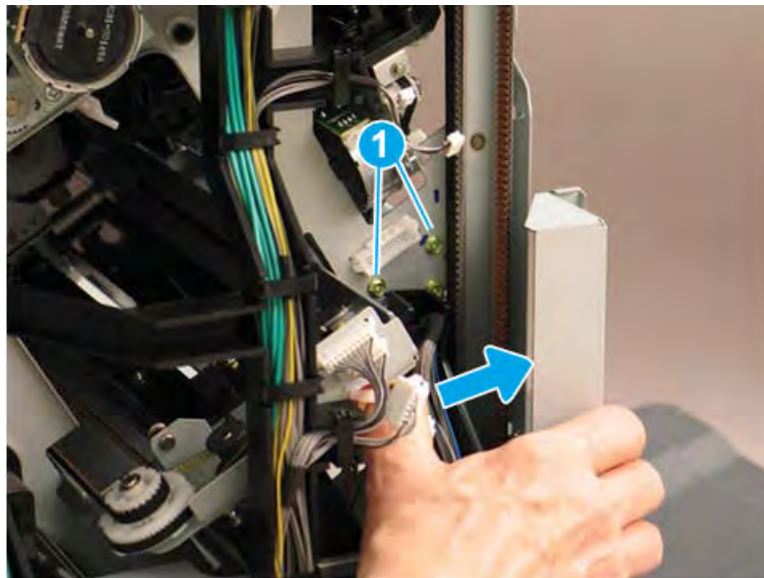
12. At the rear of the finisher, disconnect one connector (callout 1).

Figure 5-978 Disconnect one connector



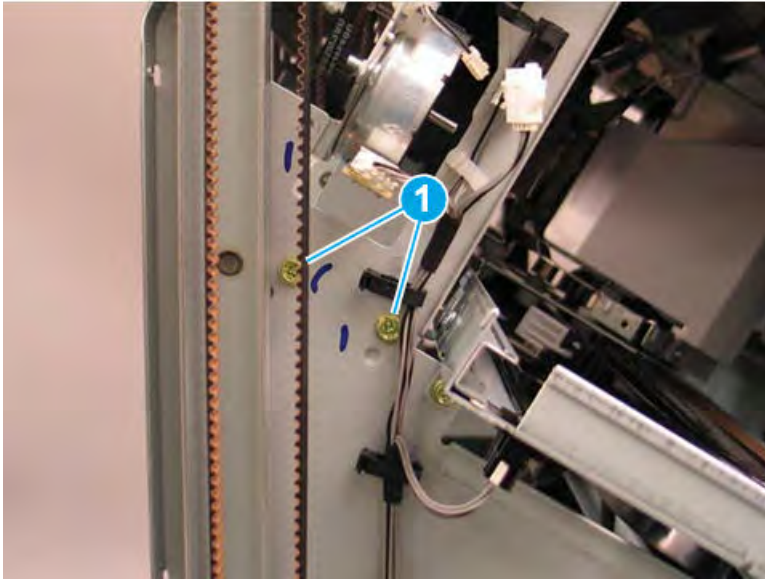
13. At the rear of the finisher, press the wire retainer to the right to access and remove two screws (callout 1).

Figure 5-979 Disconnect one connector



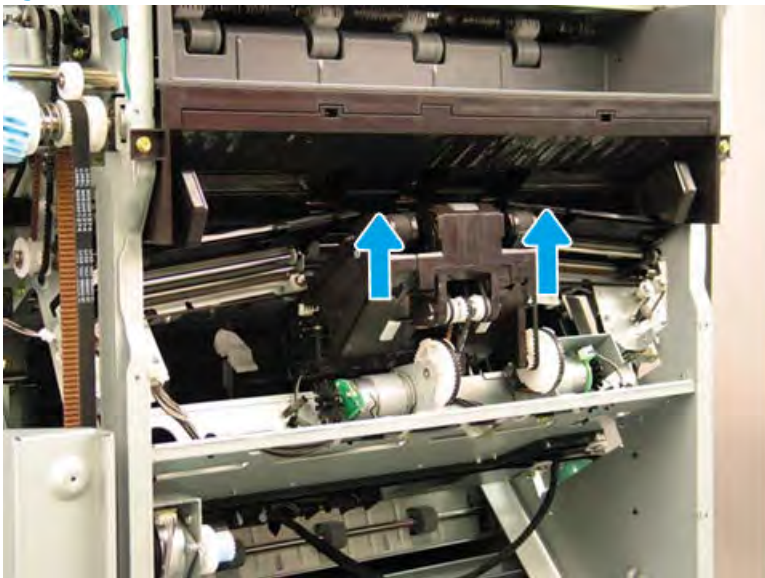
14. At the front of the finisher, remove two screws (callout 1).

Figure 5-980 Remove two screws



15. Lift the inside edges of the front and rear tampers up.

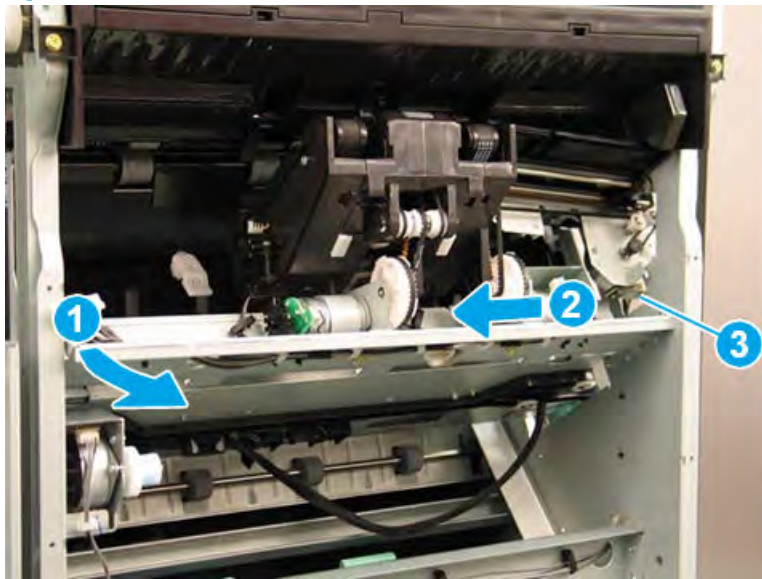
Figure 5-981 Lift the edges of the tampers





16. Rotate the rear edge of the ejector unit away from the finisher (callout 1), and then slide it toward the rear of the finisher (callout 2) to remove it. Make sure that the PCA (callout 3) stays clear of the sheet metal frame.

Figure 5-982 Remove the ejector unit

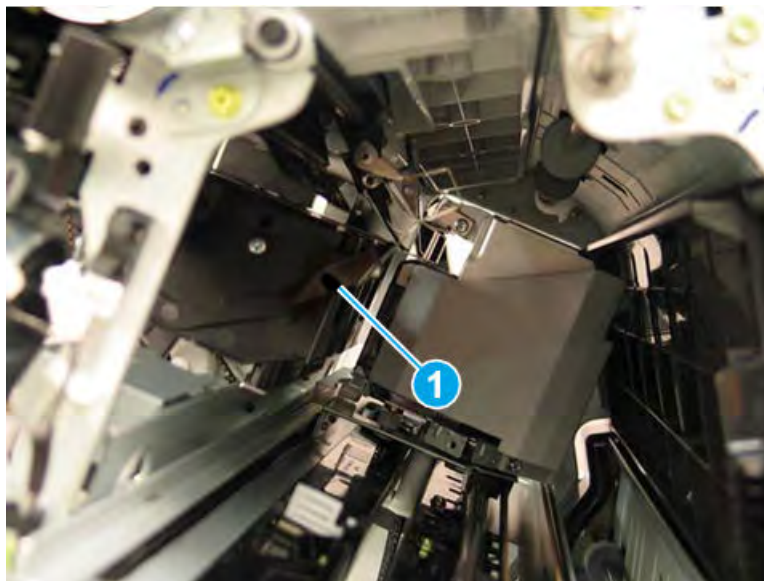


17. Reverse the removal steps to install the assembly. Also use the following special installation instructions.

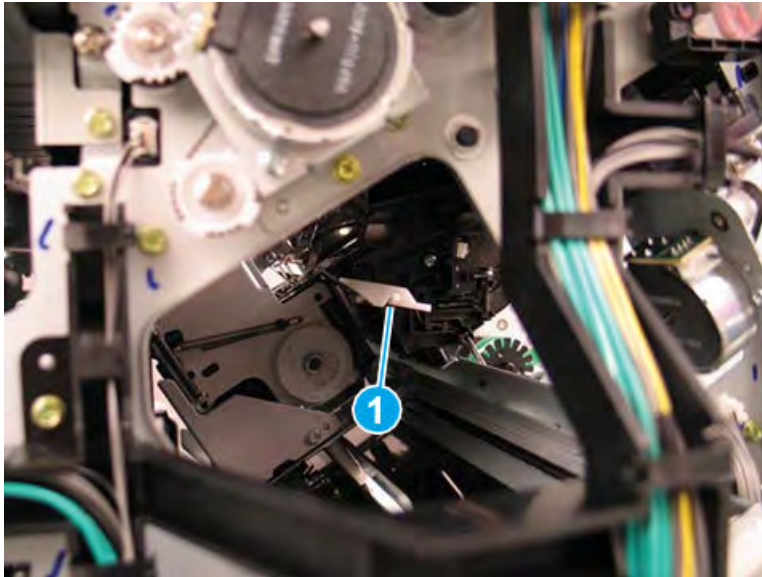
 **NOTE:** Continue to reverse the removal steps to finish installing the assembly.

#### Special installation instructions: Ejector unit

- a. When the front tamper shaft is removed, the retainer arm that held the one end of the shaft will drop down. When reinstalling the shaft, raise the retainer arm and position the end of the shaft in the notch (callout 1).



- b. When the rear tamper shaft is removed, the retainer arm that held the one end of the shaft will drop down. When reinstalling the shaft, raise the retainer arm and position the end of the shaft in the notch (callout 1).



### Unpack the replacement assembly

Follow these steps to unpack the replacement assembly.

1. Dispose of the defective part.

---



 **NOTE:** HP recommends responsible disposal of the defective part.

<http://www8.hp.com/us/en/hp-information/environment/product-recycling.html>


---

2. Unpack the replacement part from the packaging.

---

 **CAUTION:**  Some parts are sensitive to electrostatic discharge (ESD). Always perform service work at an ESD-protected workstation or mat. If an ESD workstation or mat is not available, touch the sheet-metal chassis to provide a static ground before touching an ESD-sensitive assembly. Protect the ESD-sensitive assemblies by placing them in ESD pouches when they are out of the printer.


 **IMPORTANT:** Make sure that all of the shipping materials (for example shipping tape) are removed from the replacement part prior to installation.

 **NOTE:** If the replacement part is a roller or pad, avoid touching the spongy part of it. Skin oils on the roller or pad can cause paper pickup and/or print-quality problems. HP recommends using disposable gloves when handling rollers or pads or washing your hands before touching rollers or pads.

---

3. To install an assembly, reverse the removal steps.

---

 **NOTE:** When applicable, special installation instructions are provided for an assembly at the end of the removal procedure. Always completely read the removal instructions and follow all special installation instructions.

---


Ejector1

## Removal and replacement: Ejector1 motor sensor (S27)


Learn how to remove and replace the ejector1 motor sensor.

### Introduction

This document provides the procedures to remove and replace the ejector1 motor sensor on the finisher.

 **IMPORTANT:** When applicable, special installation instructions are provided for an assembly at the end of the removal procedure. Always completely read the removal instructions and follow all special installation instructions.

### Before performing service

- Turn the printer power off. A shutting-down message appears on the control-panel display.
-  **WARNING!** To avoid damage to the printer, turn the power off and wait until the printer shuts down before removing the power cable.
- Disconnect the printer power cable after the printer has completely shut down (the control-panel display is blank).
- Release the finisher from the printer by pulling out on the release latch inside the finisher door.
- Disconnect the cable from the bridge unit to the finisher.
- Disconnect the cable from the finisher to the printer.

Use the table below to identify the correct part number for your printer. To order the part, go to <https://parts.hp.com>.

Table 5-127 Part information

Part number	Part description
0604-001415	Ejector1 motor enor

### Required tools

- #2 JIS screwdriver with a magnetic tip
- Small, flat-blade screwdriver

### After performing service

- Connect the cable from the finisher to the printer.
- Connect the cable from the bridge unit to the finisher.
- Attach the finisher to the printer, and then push in on the release latch inside the finisher door.
- Connect the printer power cable.
- Turn the printer power on.

### Post service test

Process a job through the finisher and verify that the finisher works correctly.

### Remove the right upper cover (finisher)

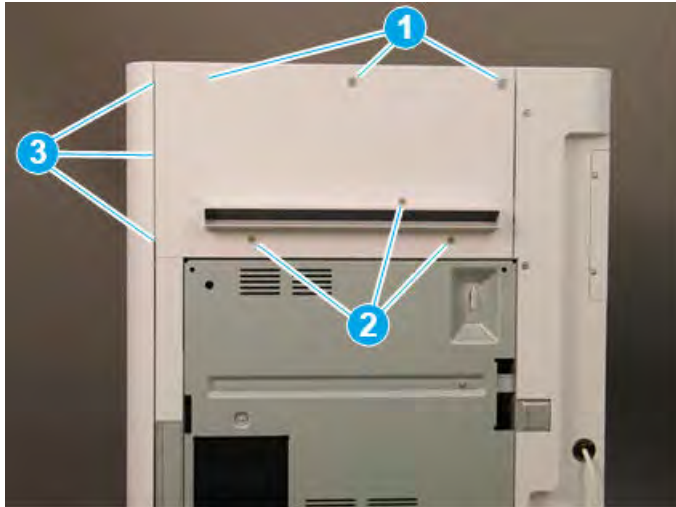
Follow these steps to remove the right upper cover (finisher).

- ▲ Remove one screw cap and three machine screws on the upper edge of the cover (callout 1). Remove three sheet metal screws (callout 2) on the lower portion of the cover. Rotate the right edge of the cover away from the finisher, and then slide the cover right to release three tabs (callout 3).

💡 **TIP:** The lower screws are shorter in length than the upper screws.

**TIP:** Reverse the removal steps to install the assembly.

**Figure 5-983** Remove the right upper cover

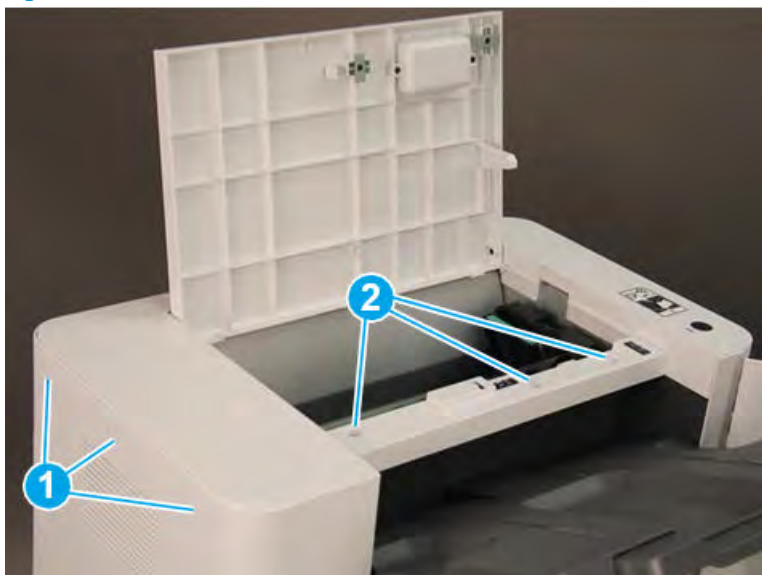


### Remove the top cover (finisher)

Follow these steps to remove the top cover (finisher).

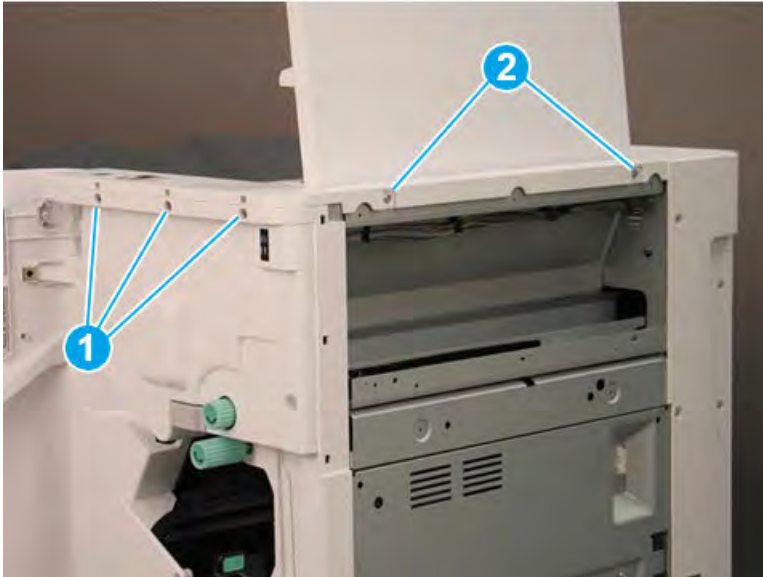
1. Remove three screw caps and three self-tapping screws at the top of the rear cover (callout 1), and then remove three machine screws (callout 2) on top of the cover.

**Figure 5-984** Remove six screws




2. Remove three self-tapping screws at the top of the front cover (callout 1), and then remove two machine screws (callout 2) at the top of the right side.

Figure 5-985 Remove five screws



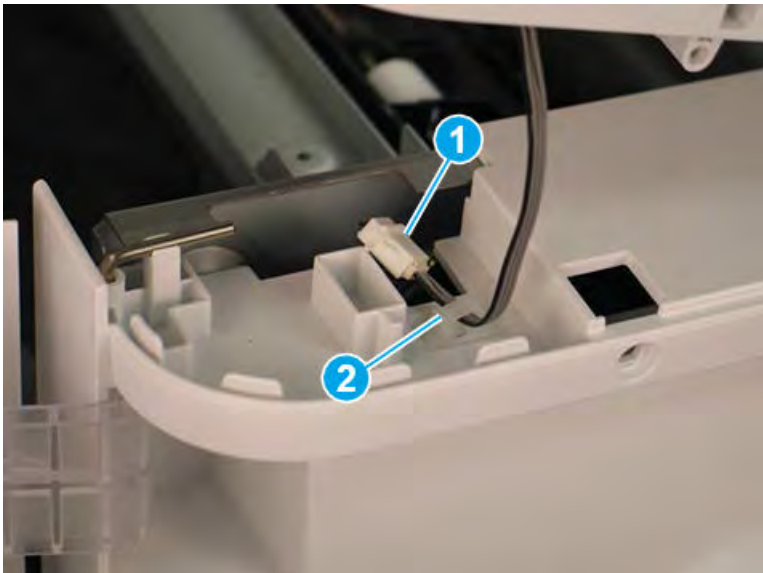
3. Lift the cover up slightly. Disconnect one in-line connector (callout 1), and then release one retainer (callout 2).

---

 **TIP:** Reverse the removal steps to install the assembly.

---

Figure 5-986 Disconnect one connector and release retainer

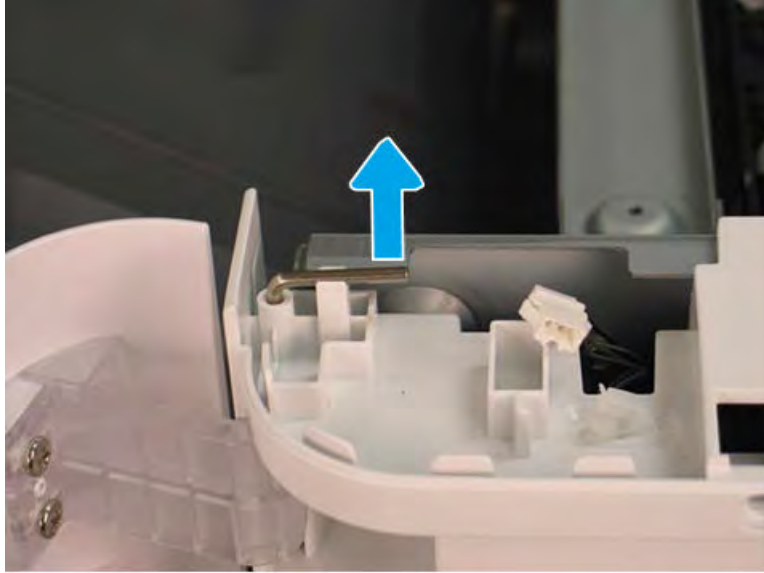


### Remove the front door (finisher)

Follow these steps to remove the front door (finisher).

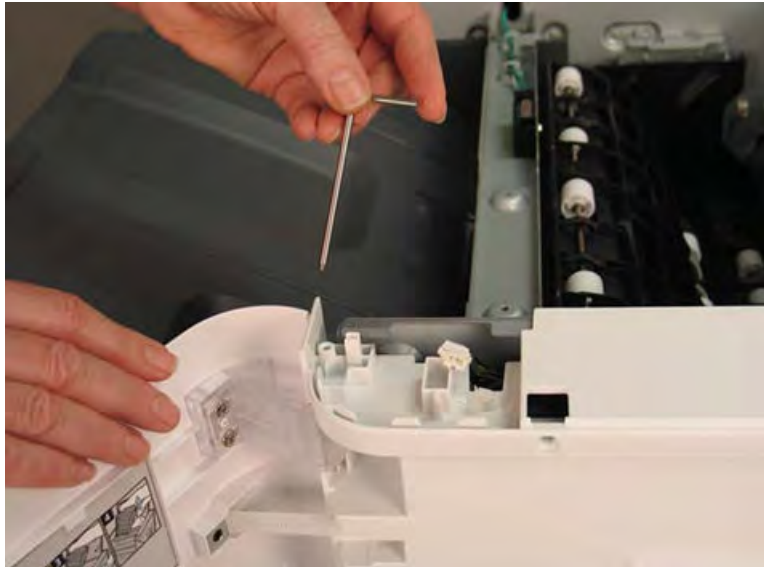
1. Lift the top hinge pin up to release it from the retainer.

Figure 5-987 Lift the top hinge pin



2. Pull the top hinge pin up to remove it.

Figure 5-988 Remove the top hinge pin



3. Use a small, flat-blade screwdriver to release the lower hinge pin from the retainer, and then rotate it away from the finisher.

**Figure 5-989** Release the lower hinge pin




4. Support the door with one hand, and then pull the lower hinge pin straight up to remove it.

**Figure 5-990** Remove the lower hinge pin

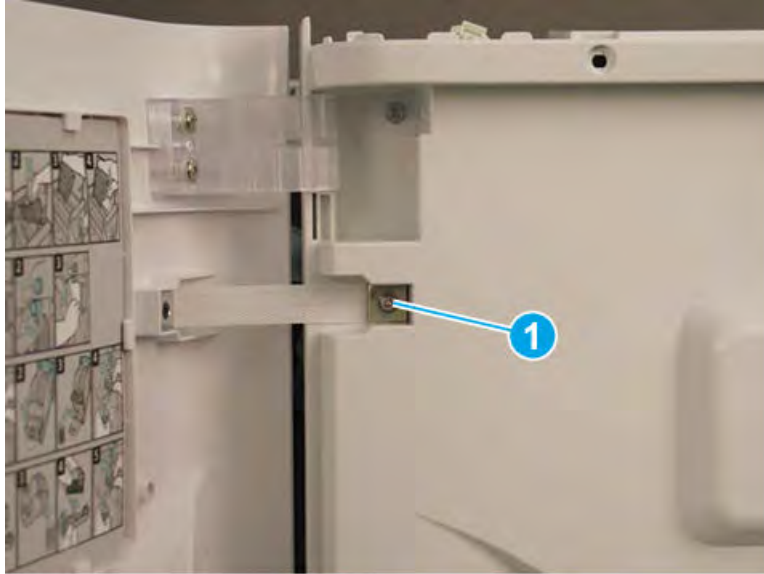




5. Support the door with one hand, and then remove one screw (callout 1) to release the strap. Remove the front door.

 **TIP:** Reverse the removal steps to install the assembly.

**Figure 5-991** Remove the front door

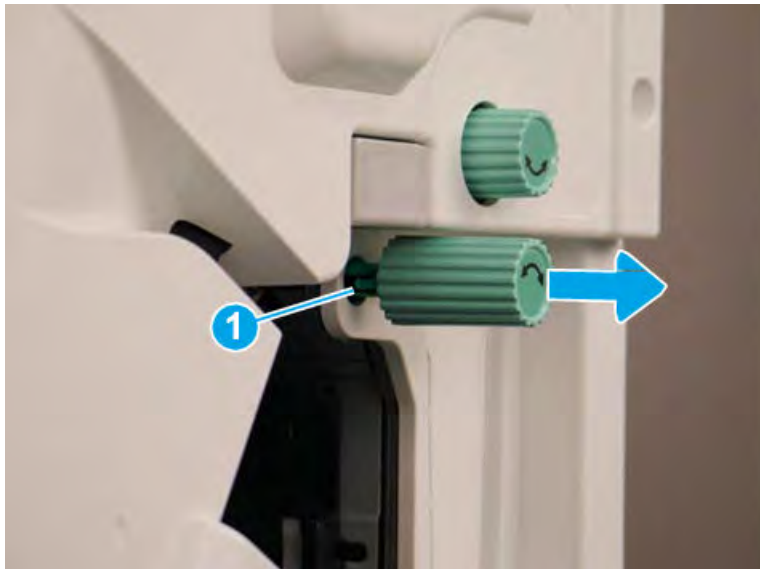


#### Remove the front cover (finisher)

Follow these steps to remove the front cover (finisher).

1. Release one tab (callout 1), and then pull the jam-access knob away from the finisher to remove it.

**Figure 5-992** Remove the jam-access knob



2. If the punch unit is installed, remove the punch waste bin (callout 1).


3. Remove one screw (callout 1) on top of the front cover.

Figure 5-993 Remove one screw



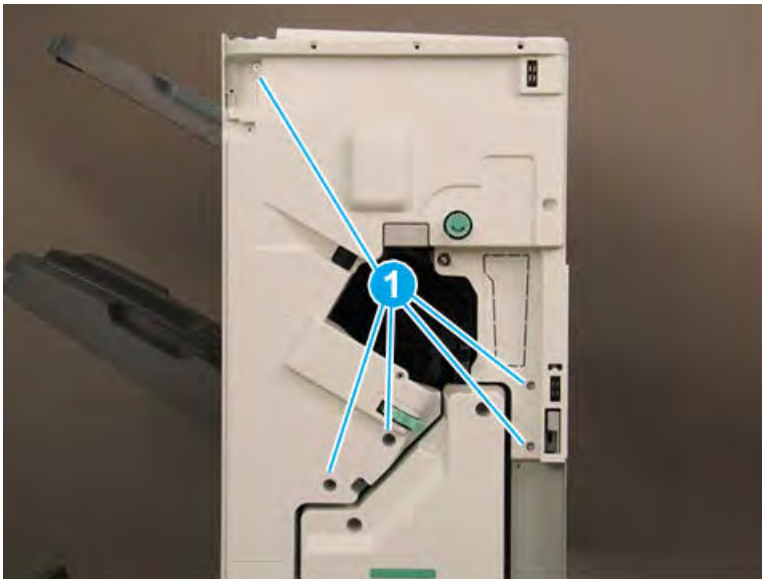
4. Remove five machine screws (callout 1), and then remove the front cover.

---

 **TIP:** Reverse the removal steps to install the assembly.

---

Figure 5-994 Remove the front cover

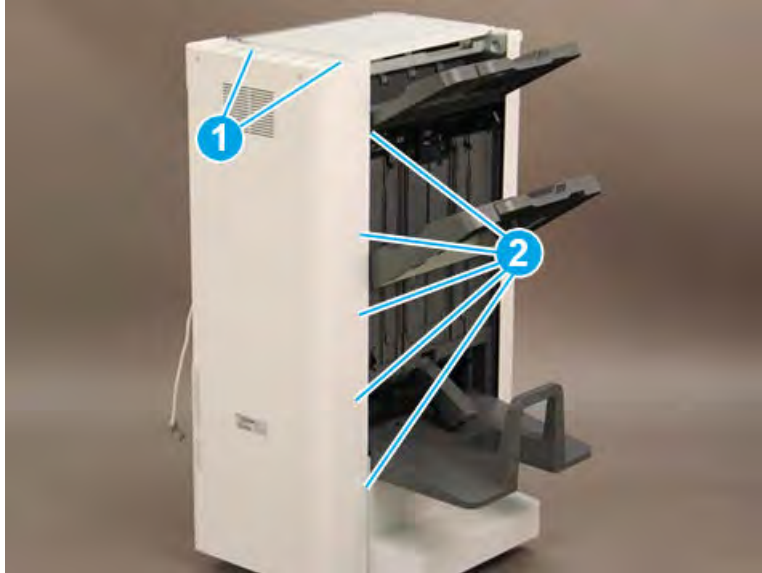


### Remove the rear cover (finisher)

Follow these steps to remove the rear cover (finisher).

1. Remove two self-tapping screws (callout 1) on the top of the rear cover, and then remove five screw caps and five machine screws (callout 2) on the left side of the cover.


Figure 5-995 Remove seven screws



2. Remove one screw cap and four machine screws (callout 1) Remove the rear cover.

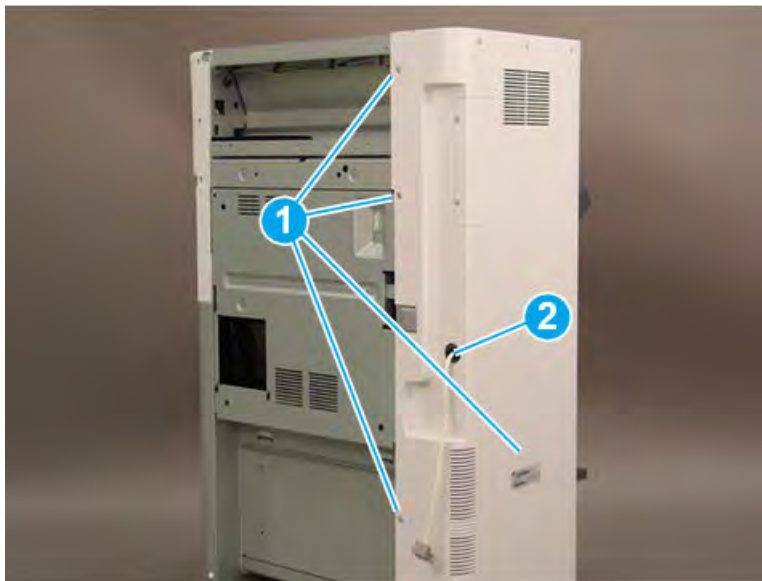
---

 **NOTE:** Make sure to thread the power cable (callout 2) through the opening in the cover.

 **TIP:** Reverse the removal steps to install the assembly

---

Figure 5-996 Remove the rear cover



### Remove the booklet output tray

Follow these steps to remove the booklet output tray.

1. Raise the booklet output tray up (callout 1), and then pull it away from the finisher (callout 2) to remove it.

Figure 5-997 Remove the booklet output tray



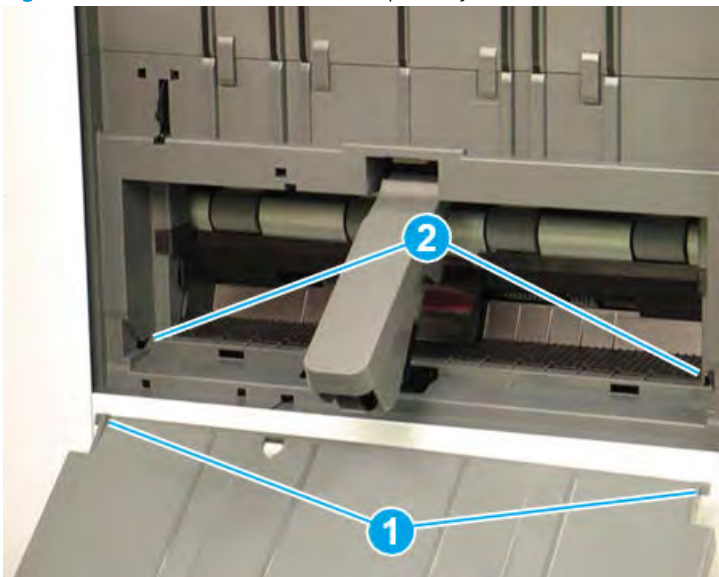
2. Reverse the removal steps to install the assembly. Also use the following special installation instructions.

 **NOTE:** Continue to reverse the removal steps to finish installing the assembly

Special installation instructions: booklet output tray

Position the tabs (callout 1) on the tray into the slots (callout 2) on the finisher.

Figure 5-998 Install the booklet output tray

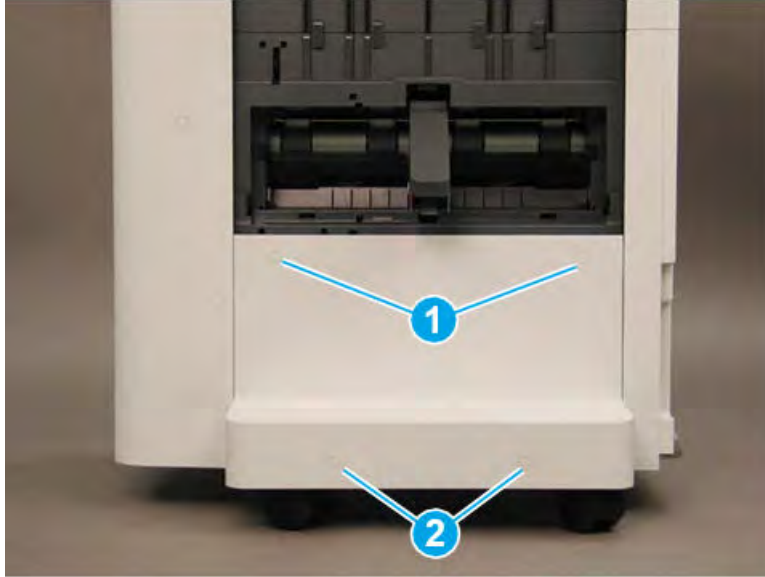


### Remove the caster cover

Follow these steps to remove the caster cover.

1. Remove two screw caps and two self-tapping screws (callout 1). Remove two screw caps and two machine screws (callout 2).

Figure 5-999 Remove four screws



2. Rotate the left edge of the cover away from the finisher (callout 1), and then slide the cover to the left (callout 2) to remove it.

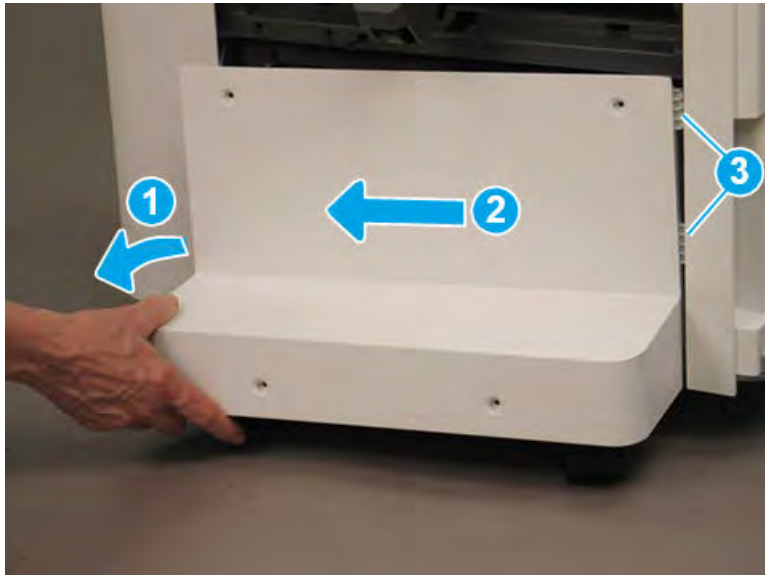
---

 **TIP:** Make sure that two tabs (callout 3) are positioned under the front lower cover when reinstalling the caster cover.

**TIP:** Reverse the removal steps to install the assembly

---

Figure 5-1000 Remove the caster cover




### Remove the left lower cover (finisher)

Follow these steps to remove the left lower cover (finisher).

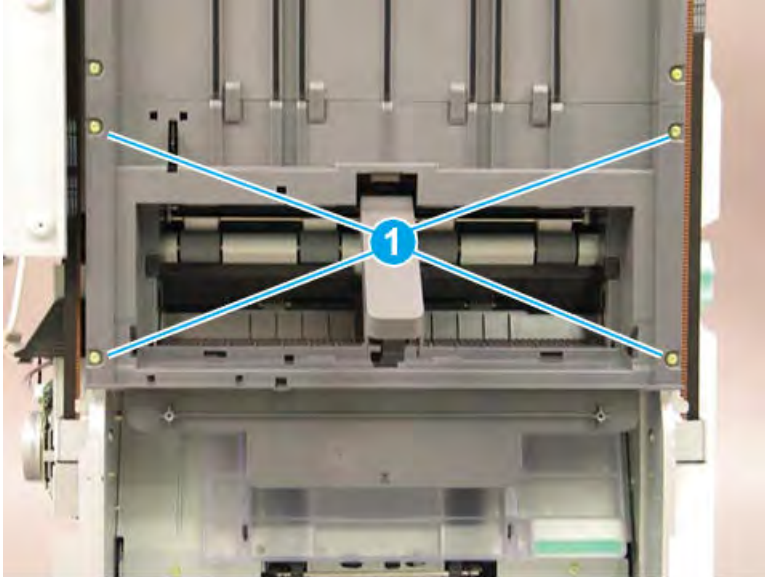
1. Remove four screws (callout 1).

---

 **NOTE:** Raise the lower output tray as needed to access the screws.

---

Figure 5-1001 Remove four screws



2. Slide the shield down (callout 1) to release it from four tabs (callout 2), and then rotate it away from the finisher (callout 3).

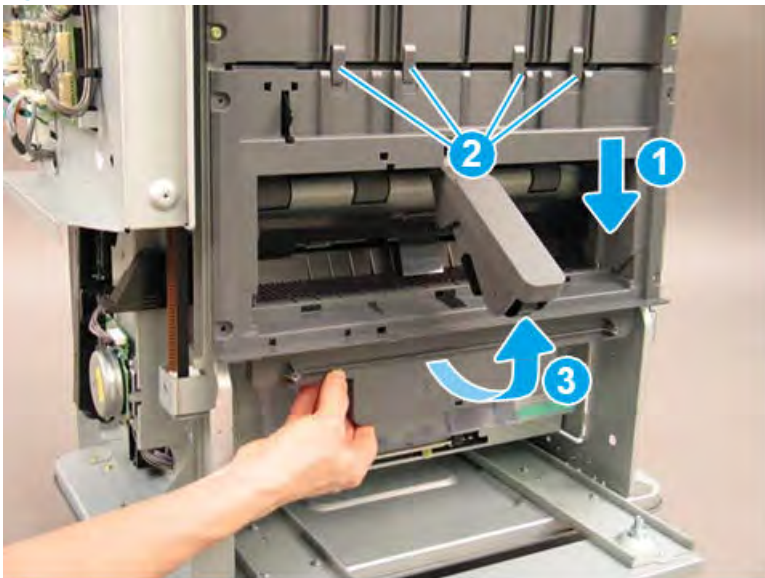
---

**⚠ CAUTION:** The shield is still attached to the finisher. Do not attempt to completely remove the shield.


**💡 TIP:** Position the shield under the four tabs (callout 2) when reinstalling it.

---

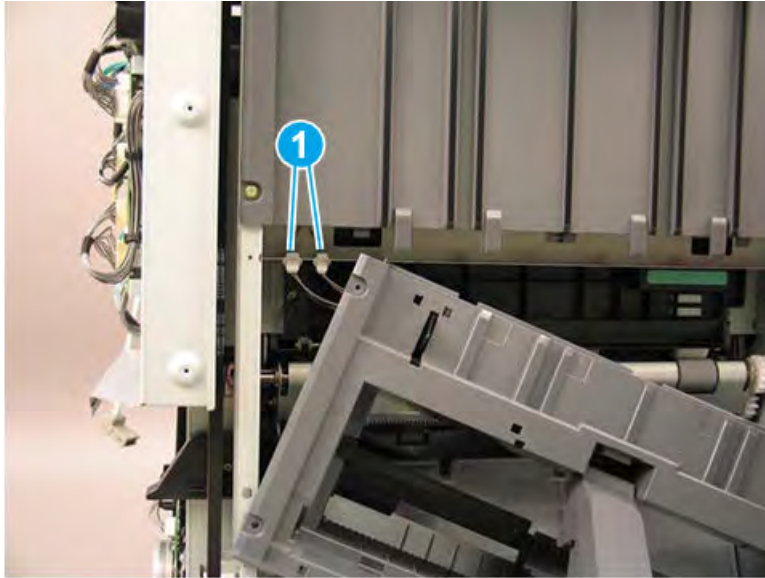
Figure 5-1002 Release the lower shield



3. Disconnect two connectors (callout 1), and then remove the shield.

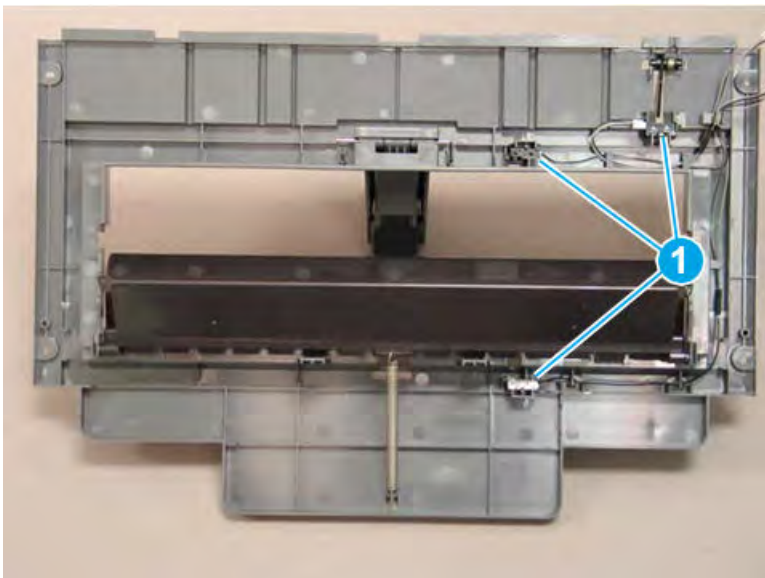
 **TIP:** Reverse the removal steps to install the assembly.

**Figure 5-1003** Disconnect two connectors



4. If you are replacing the left lower cover, locate three sensors (callout 1) on the back of the left lower cover. Remove these sensors and transfer them to the replacement part.

**Figure 5-1004** Remove the left lower cover

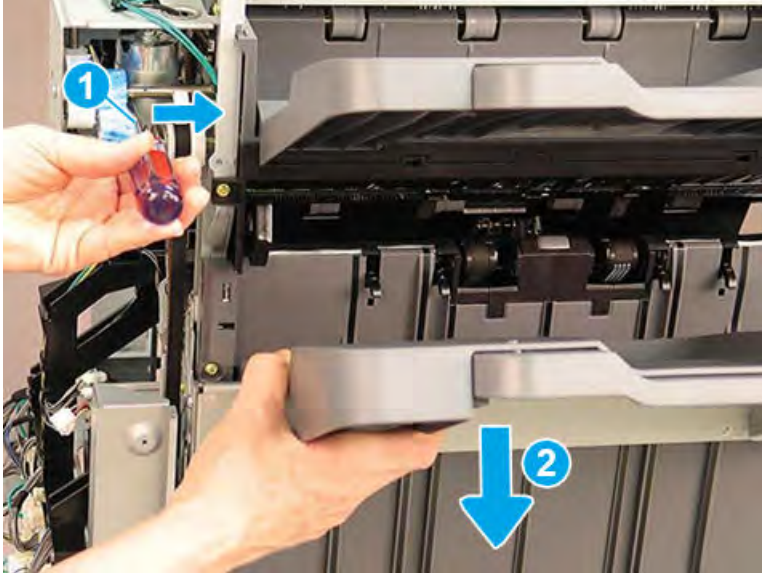


### Remove the left upper cover (finisher)

Follow these steps to remove the left upper cover (finisher).

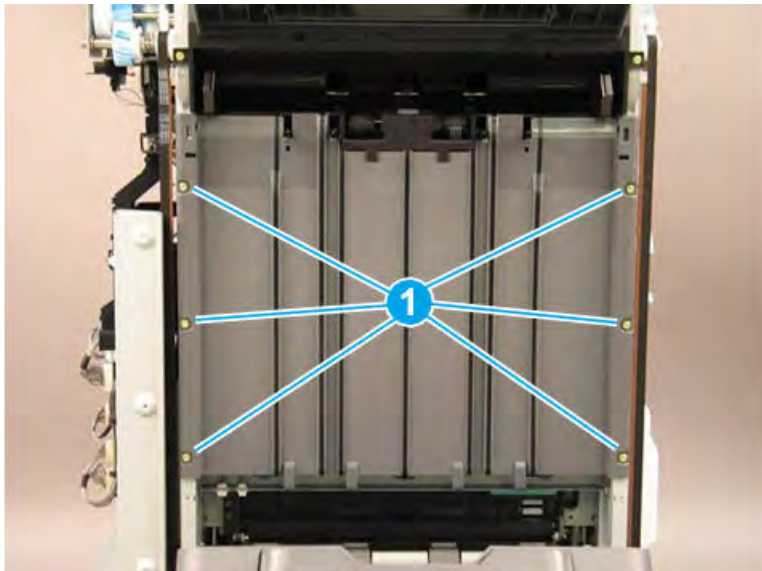
1. Bring the lower output tray down by positioning the shaft of a screwdriver on the clutch (callout 1) and gently pressing to the right to release the clutch. Hold the clutch in the released position and lower the tray (callout 2) to the lowest position.

Figure 5-1005 Lower the output tray



2. Remove six machine screws (callout 1).

Figure 5-1006 Remove six screws



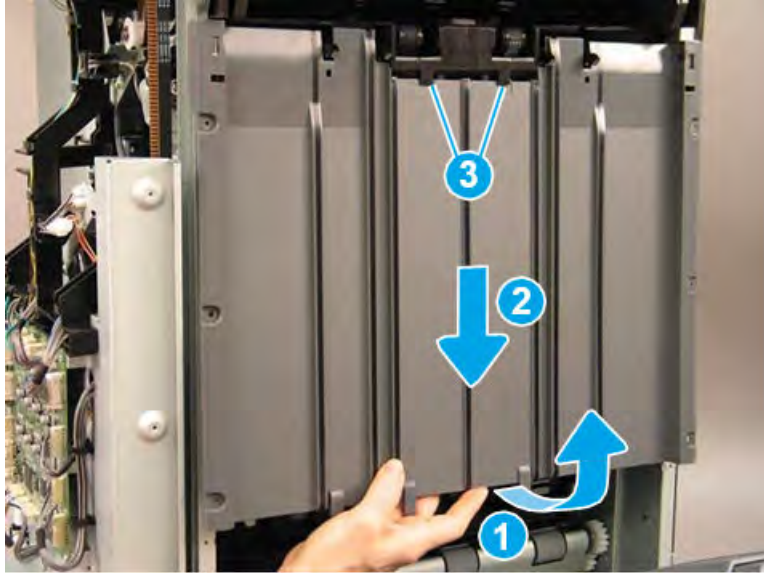


3. Rotate the lower edge of the shield away from the finisher (callout 1), and then slide the shield down (callout 2) to release it from two tabs (callout 3).

**CAUTION:** The shield is still attached to the finisher. Do not attempt to completely remove the shield.

**TIP:** Position the shield under the two tabs (callout 3) when reinstalling it.

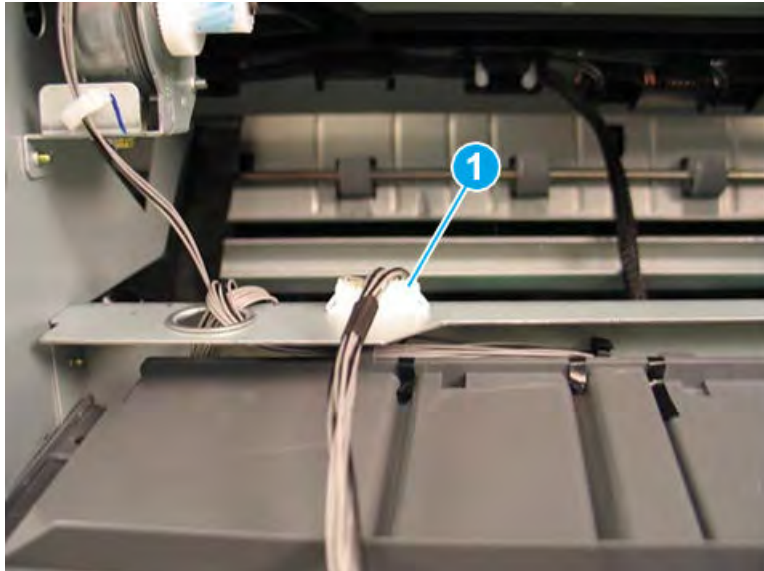
Figure 5-1007 Release the shield



4. Disconnect one connector (callout 1), and then remove the upper shield assembly.

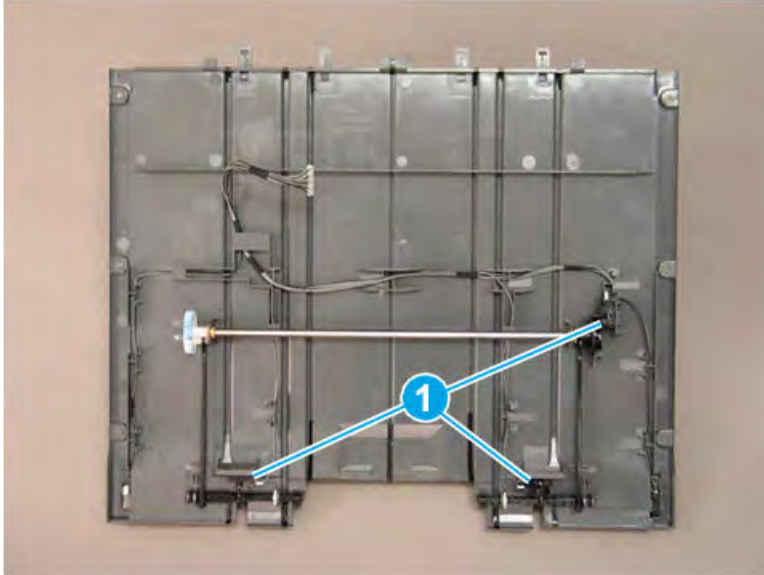
**TIP:** Reverse the removal steps to install the assembly.

Figure 5-1008 Disconnect one connector



5. If you are replacing the left upper cover, locate three sensors (callout 1) on the back of the left upper cover. Remove these sensors and transfer them to the replacement part.

Figure 5-1009 Remove the left upper cover

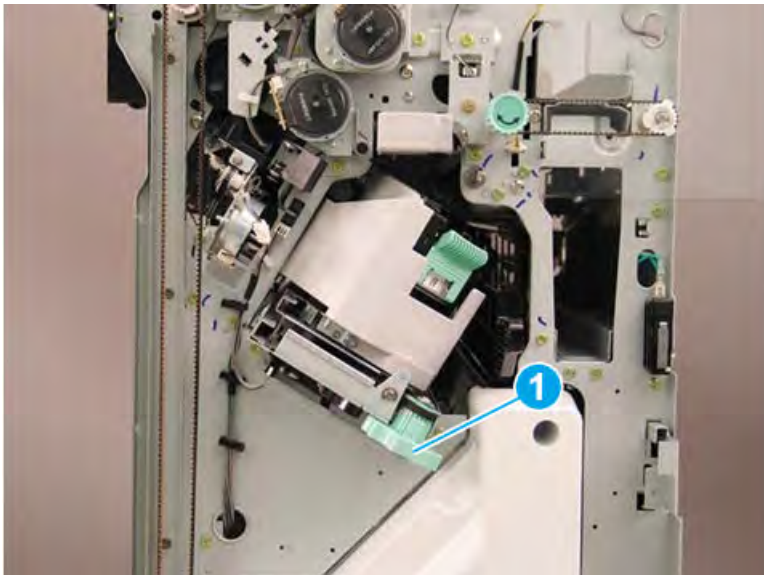


#### Remove the ejector unit (finisher)

Follow these steps to remove the ejector unit (finisher).

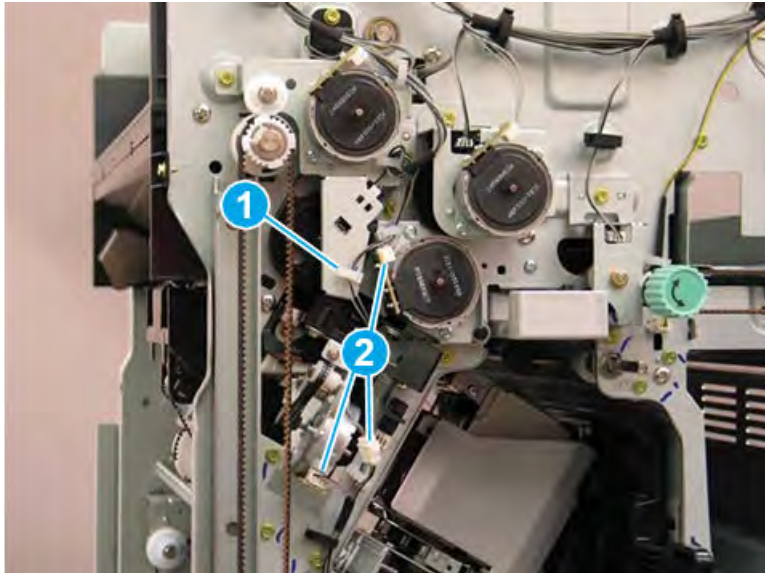
1. Rotate the green wheel to move the staple unit to the center of the finisher.

Figure 5-1010 Move the staple unit to the center



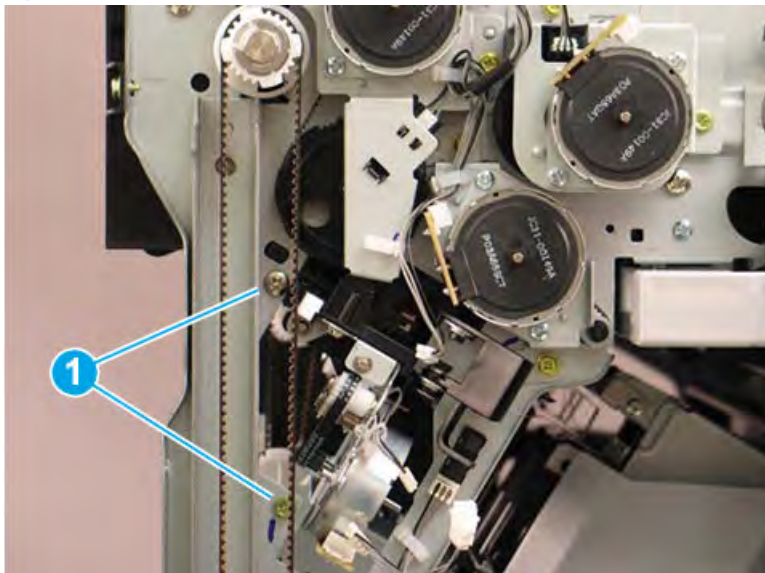
2. Release one retainer (callout 1), and then disconnect three connectors (callout 2).

Figure 5-1011 Disconnect three connectors



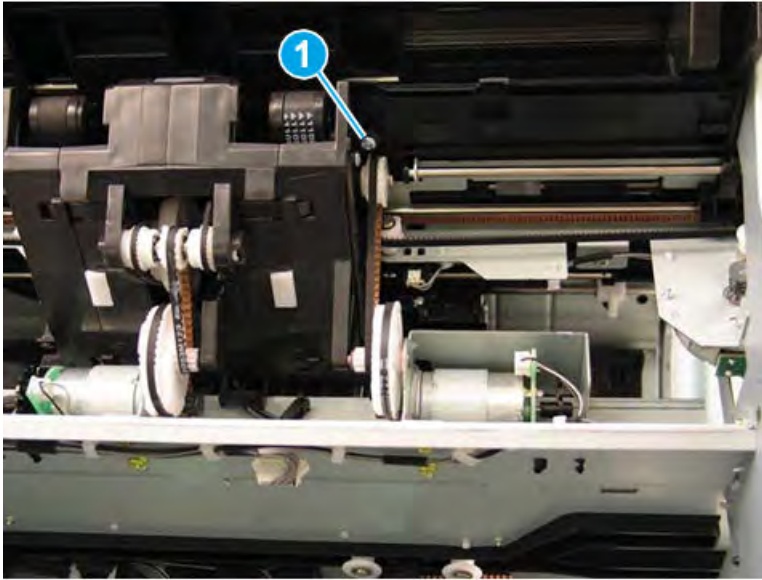
3. Remove two screws (callout 1).

Figure 5-1012 Remove two screws



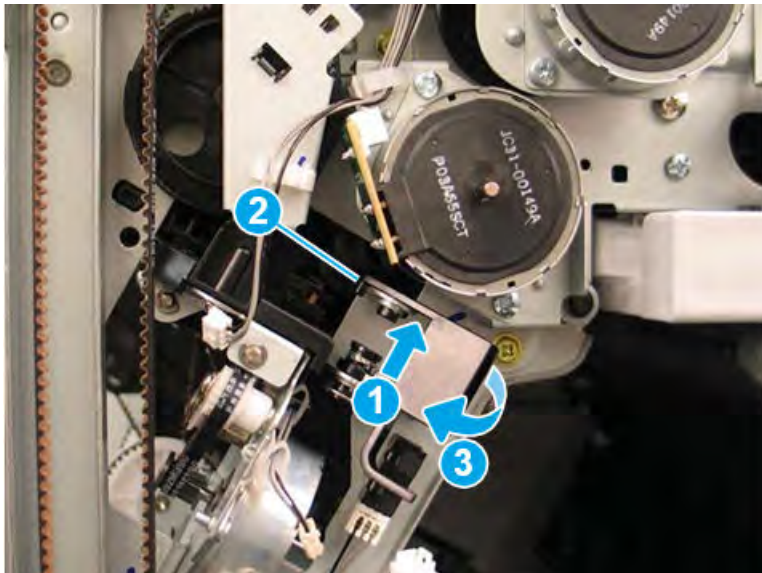
4. At the left side of the finisher, remove one screw (callout 1).

Figure 5-1013 Remove one screw



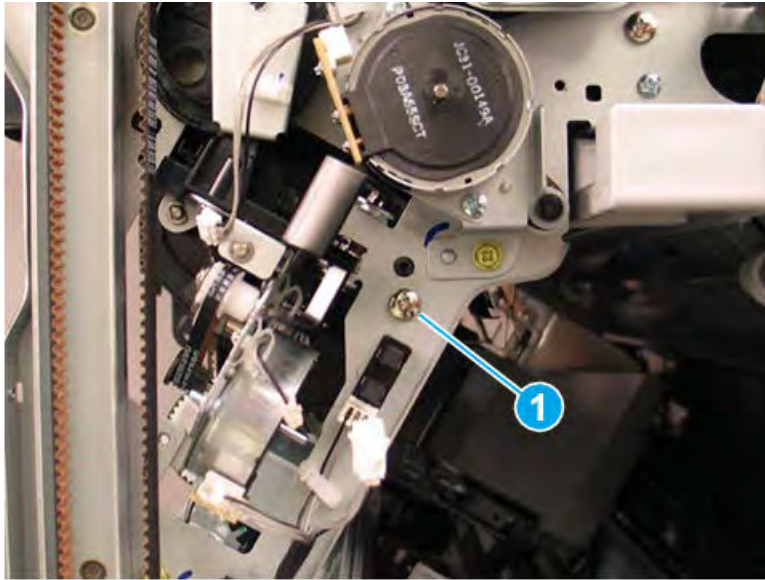
5. Press up on the hinge (callout 1), release one tab (callout 2), and then rotate the sensor away from the finisher (callout 3).

Figure 5-1014 Rotate the sensor



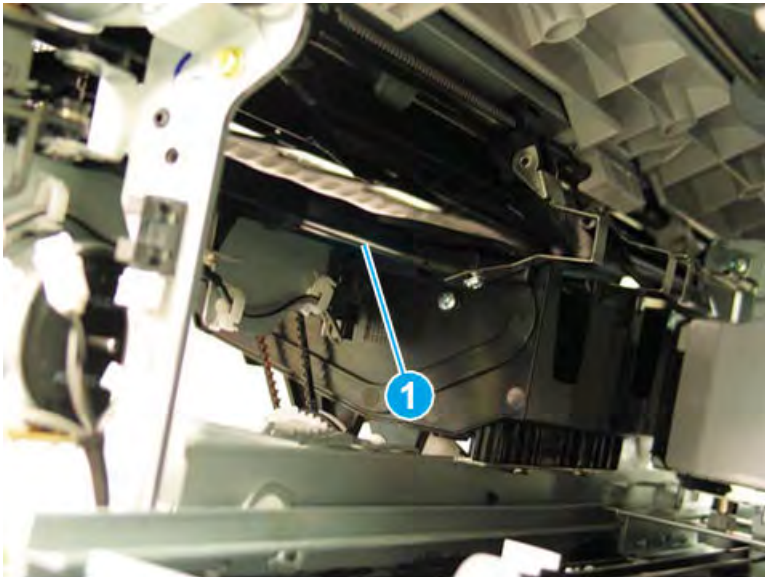
6. Remove one screw (callout 1).

Figure 5-1015 Remove one screw



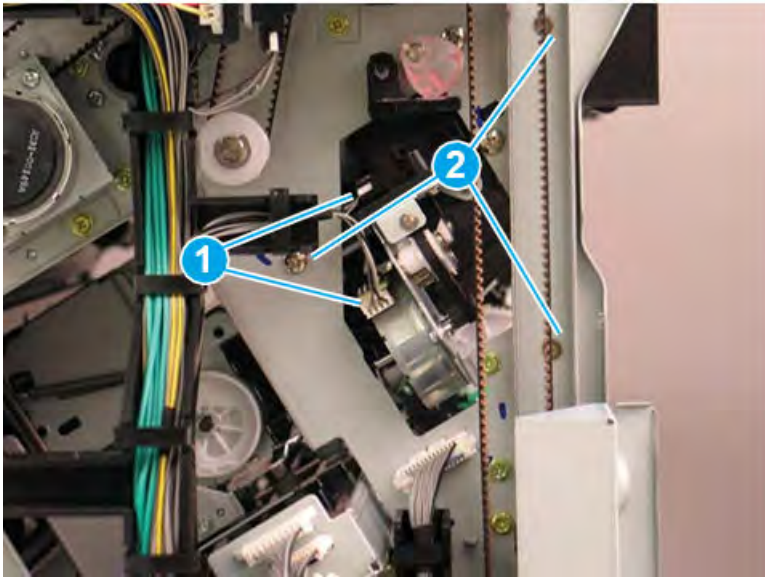
7. Look inside the finisher through the stapler opening in the front and pull down to release and remove one shaft (callout 1) on the front tamper unit.

Figure 5-1016 Remove the front tamper shaft



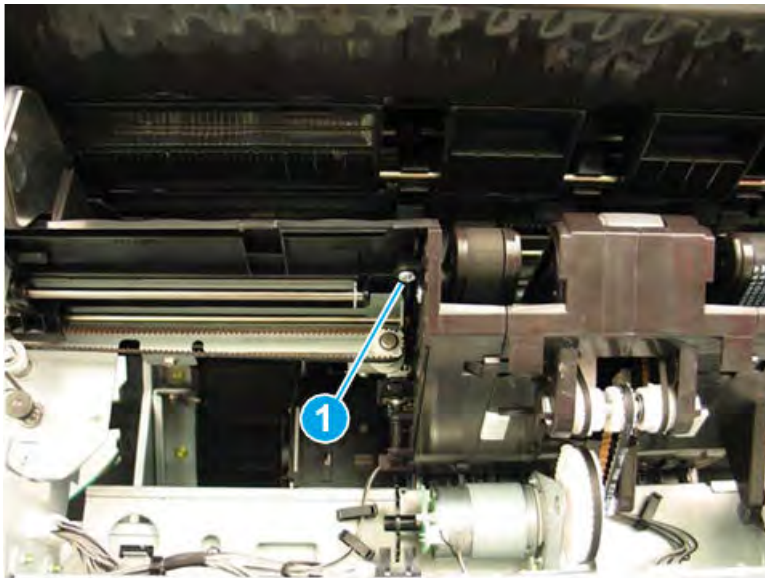
8. At the rear of the finisher, disconnect two connectors (callout 1), and then remove three screws (callout 2).

Figure 5-1017 Disconnect two connectors and remove three screws



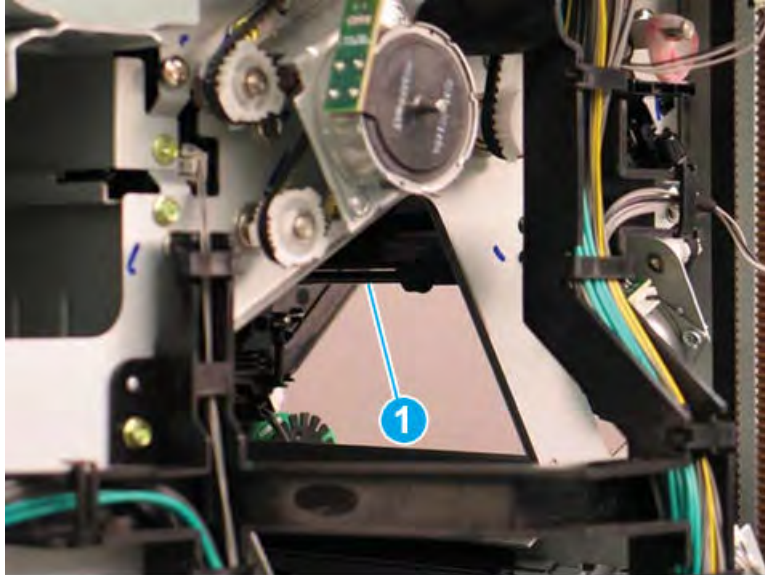
9. At the left side of the finisher, remove one screw (callout 1).

Figure 5-1018 Remove one screw



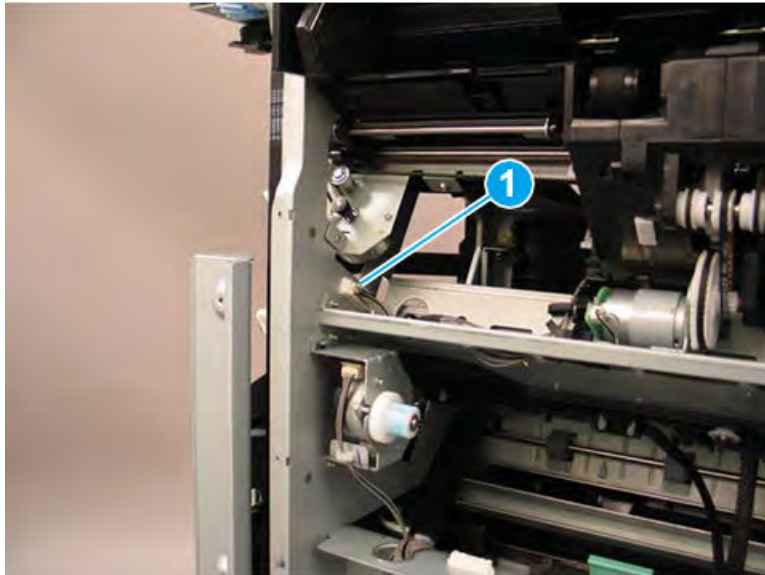
10. Look inside the finisher through the stapler opening in the rear and pull down to release and remove one shaft (callout 1) on the rear tamper unit.

Figure 5-1019 Remove the rear tamper shaft



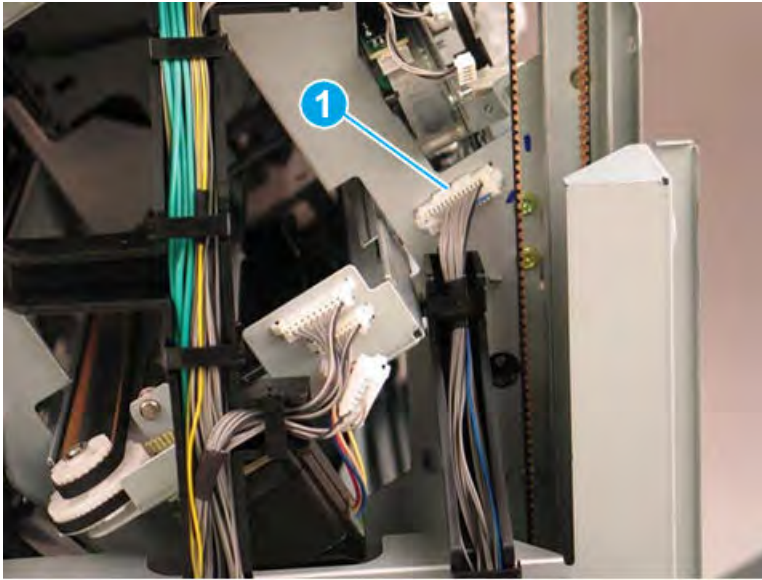
11. At the left side of the finisher, disconnect one connector (callout 1).

Figure 5-1020 Disconnect one connector



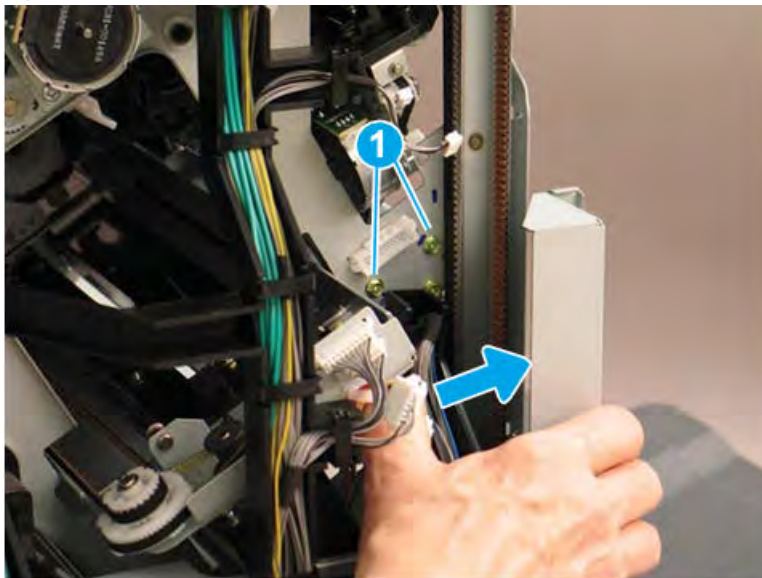
12. At the rear of the finisher, disconnect one connector (callout 1).

Figure 5-1021 Disconnect one connector



13. At the rear of the finisher, press the wire retainer to the right to access and remove two screws (callout 1).

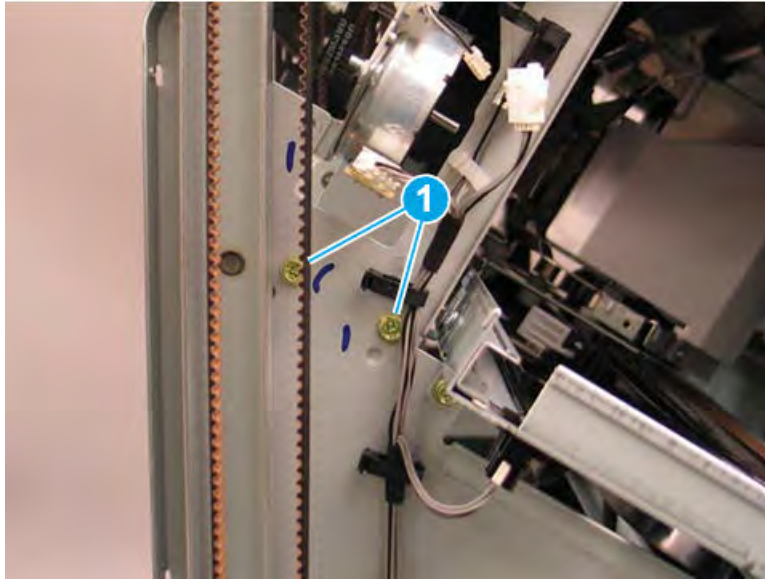
Figure 5-1022 Disconnect one connector





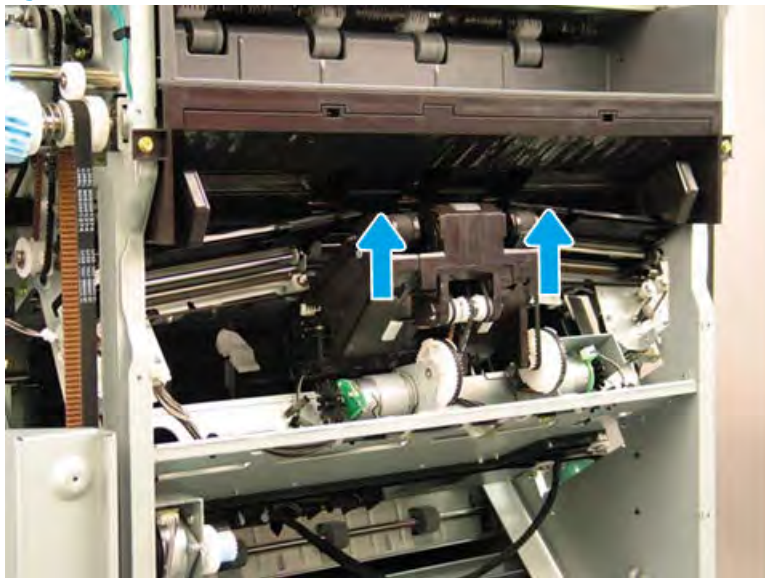
14. At the front of the finisher, remove two screws (callout 1).

Figure 5-1023 Remove two screws



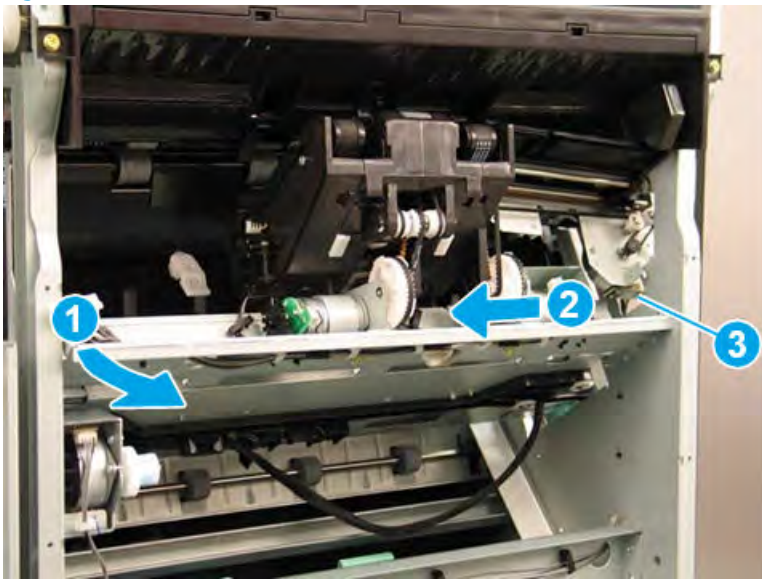
15. Lift the inside edges of the front and rear tampers up.

Figure 5-1024 Lift the edges of the tampers



16. Rotate the rear edge of the ejector unit away from the finisher (callout 1), and then slide it toward the rear of the finisher (callout 2) to remove it. Make sure that the PCA (callout 3) stays clear of the sheet metal frame.

Figure 5-1025 Remove the ejector unit



17. Reverse the removal steps to install the assembly. Also use the following special installation instructions.

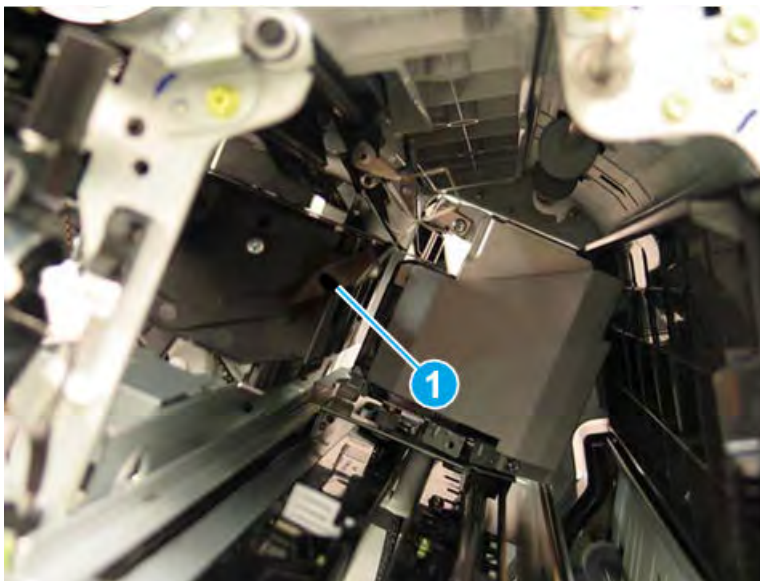
---

 **NOTE:** Continue to reverse the removal steps to finish installing the assembly.

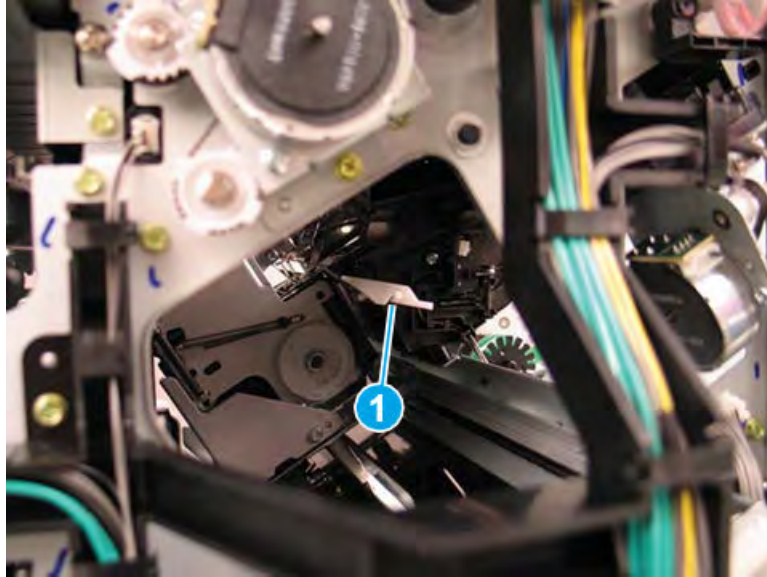
---

**Special installation instructions: Ejector unit**

- a. When the front tamper shaft is removed, the retainer arm that held the one end of the shaft will drop down. When reinstalling the shaft, raise the retainer arm and position the end of the shaft in the notch (callout 1).



- b. When the rear tamper shaft is removed, the retainer arm that held the one end of the shaft will drop down. When reinstalling the shaft, raise the retainer arm and position the end of the shaft in the notch (callout 1).

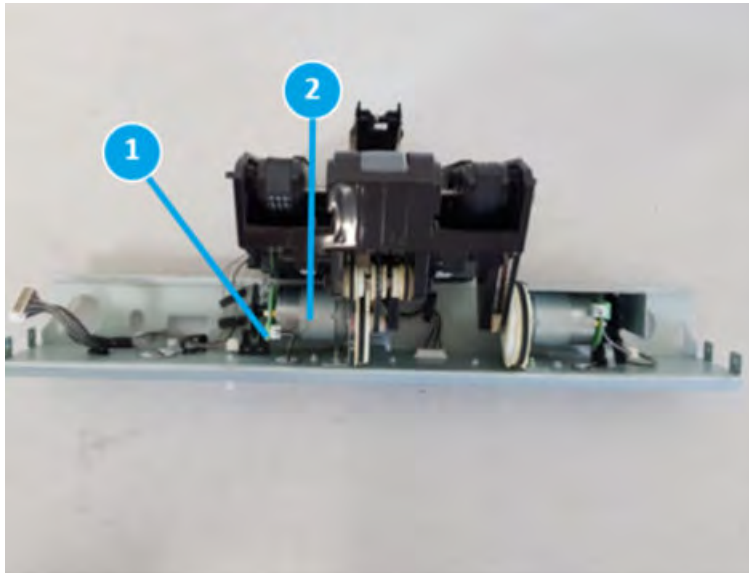


#### Remove the ejector1 motor sensor(S27)

Follow these steps to remove the ejector1 motor sensor(S27).

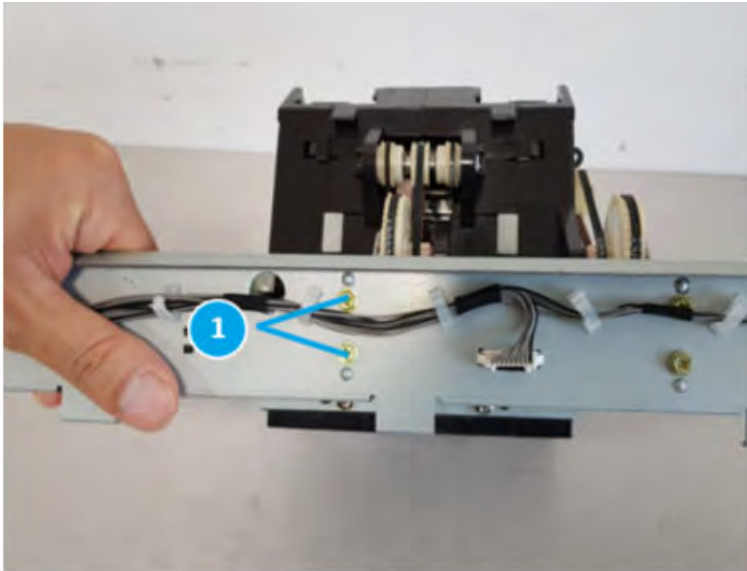
1. Disconnect the connector(callout 1) from ejector1 motor(callout 2, M6) of ejector unit.

Figure 5-1026 Disconnect the connector



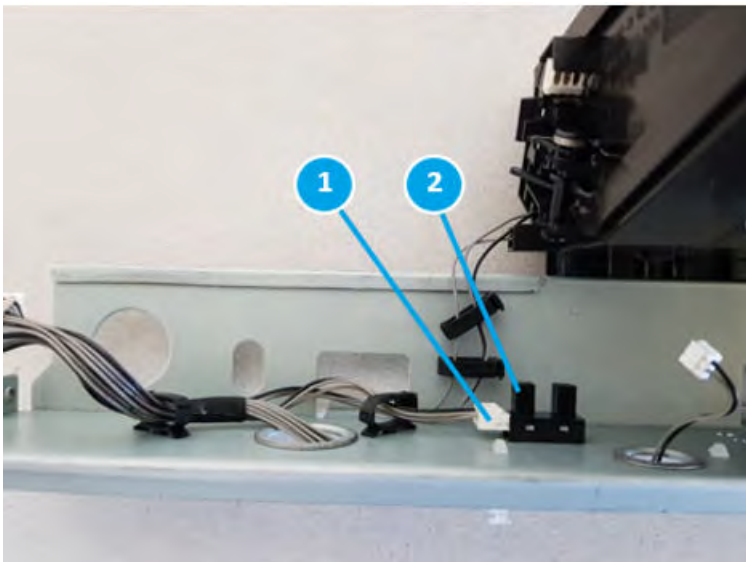
2. Remove two screws(callout 1).

Figure 5-1027 Remove two screws



3. Remove the ejector1 motor from ejector unit, disconnect the connector(callout 1), and then remove the ejector1 motor sensor(S27, callout 2)

Figure 5-1028 Remove the ejector1 motor sensor



### Unpack the replacement assembly

Follow these steps to unpack the replacement assembly.

1. Dispose of the defective part.



---

 **NOTE:** HP recommends responsible disposal of the defective part.


<http://www8.hp.com/us/en/hp-information/environment/product-recycling.html>

---

2. Unpack the replacement part from the packaging.


 **CAUTION:**  Some parts are sensitive to electrostatic discharge (ESD). Always perform service work at an ESD-protected workstation or mat. If an ESD workstation or mat is not available, touch the sheet-metal chassis to provide a static ground before touching an ESD-sensitive assembly. Protect the ESD-sensitive assemblies by placing them in ESD pouches when they are out of the printer.

 **IMPORTANT:** Make sure that all of the shipping materials (for example shipping tape) are removed from the replacement part prior to installation.

 **NOTE:** If the replacement part is a roller or pad, avoid touching the spongy part of it. Skin oils on the roller or pad can cause paper pickup and/or print-quality problems. HP recommends using disposable gloves when handling rollers or pads or washing your hands before touching rollers or pads.

---

3. To install an assembly, reverse the removal steps.

 **NOTE:** When applicable, special installation instructions are provided for an assembly at the end of the removal procedure. Always completely read the removal instructions and follow all special installation instructions.


---

## Removal and replacement: Ejector1 motor (M6)


Learn how to remove and replace the ejector1 motor.

### Introduction

This document provides the procedures to remove and replace the ejector1 motor on the finisher.

 **IMPORTANT:** When applicable, special installation instructions are provided for an assembly at the end of the removal procedure. Always completely read the removal instructions and follow all special installation instructions.

### Before performing service

- Turn the printer power off. A shutting-down message appears on the control-panel display.
-  **WARNING!** To avoid damage to the printer, turn the power off and wait until the printer shuts down before removing the power cable.
- Disconnect the printer power cable after the printer has completely shut down (the control-panel display is blank).
- Release the finisher from the printer by pulling out on the release latch inside the finisher door.
- Disconnect the cable from the bridge unit to the finisher.
- Disconnect the cable from the finisher to the printer.

Use the table below to identify the correct part number for your printer. To order the part, go to <https://parts.hp.com>.

Table 5-128 Part information

Part number	Part description
JC93-01168A	Ejector1 motor

### Required tools

- #2 JIS screwdriver with a magnetic tip
- Small, flat-blade screwdriver

### After performing service

- Connect the cable from the finisher to the printer.
- Connect the cable from the bridge unit to the finisher.
- Attach the finisher to the printer, and then push in on the release latch inside the finisher door.
- Connect the printer power cable.
- Turn the printer power on.

### Post service test

Process a job through the finisher and verify that the finisher works correctly.

### Remove the right upper cover (finisher)

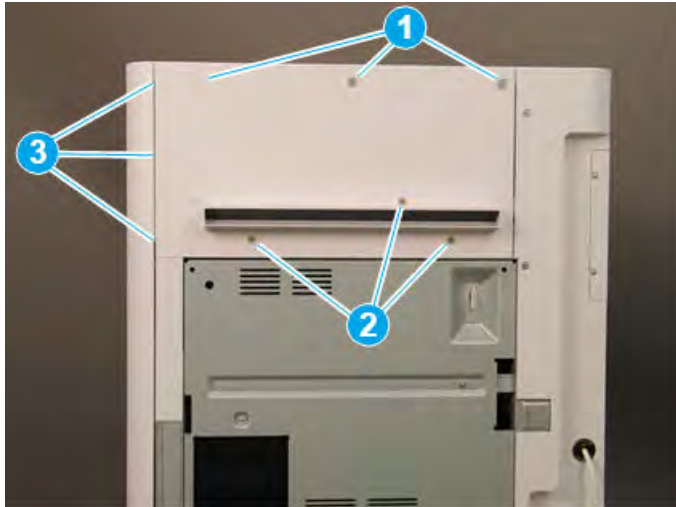
Follow these steps to remove the right upper cover (finisher).

- ▲ Remove one screw cap and three machine screws on the upper edge of the cover (callout 1). Remove three sheet metal screws (callout 2) on the lower portion of the cover. Rotate the right edge of the cover away from the finisher, and then slide the cover right to release three tabs (callout 3).

💡 **TIP:** The lower screws are shorter in length than the upper screws.

**TIP:** Reverse the removal steps to install the assembly.

Figure 5-1029 Remove the right upper cover

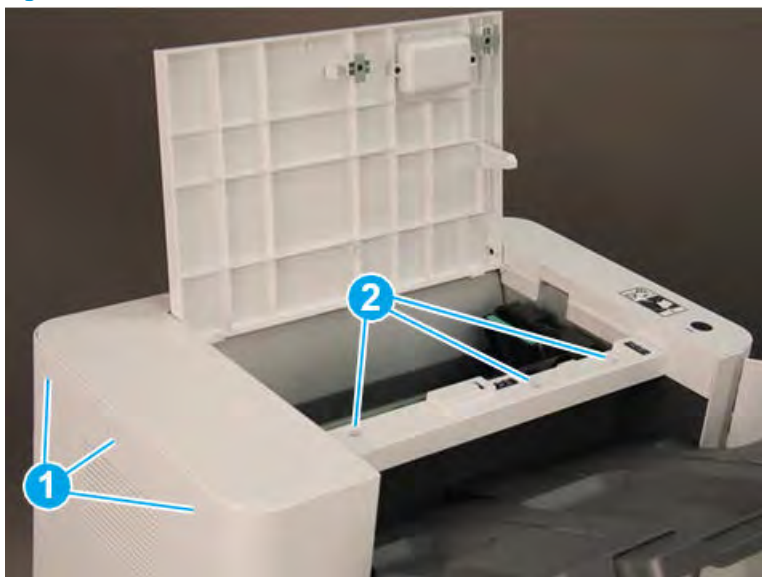


### Remove the top cover (finisher)

Follow these steps to remove the top cover (finisher).

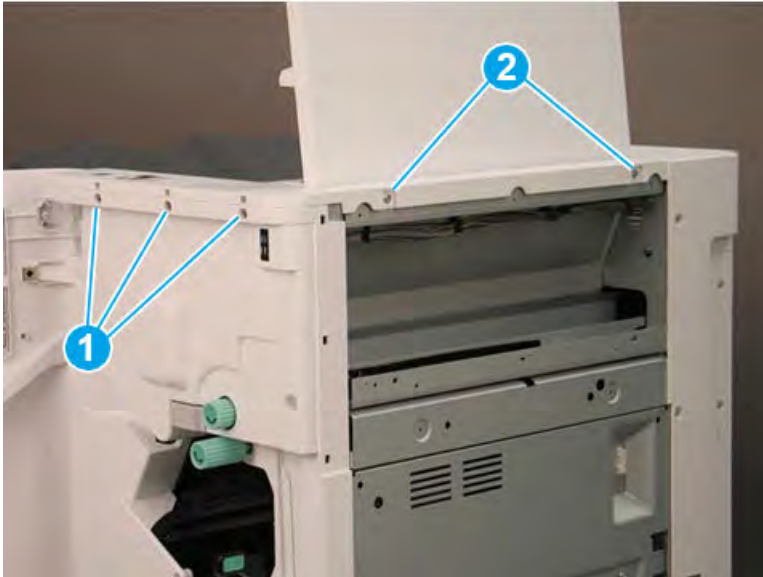
1. Remove three screw caps and three self-tapping screws at the top of the rear cover (callout 1), and then remove three machine screws (callout 2) on top of the cover.

Figure 5-1030 Remove six screws




2. Remove three self-tapping screws at the top of the front cover (callout 1), and then remove two machine screws (callout 2) at the top of the right side.

Figure 5-1031 Remove five screws



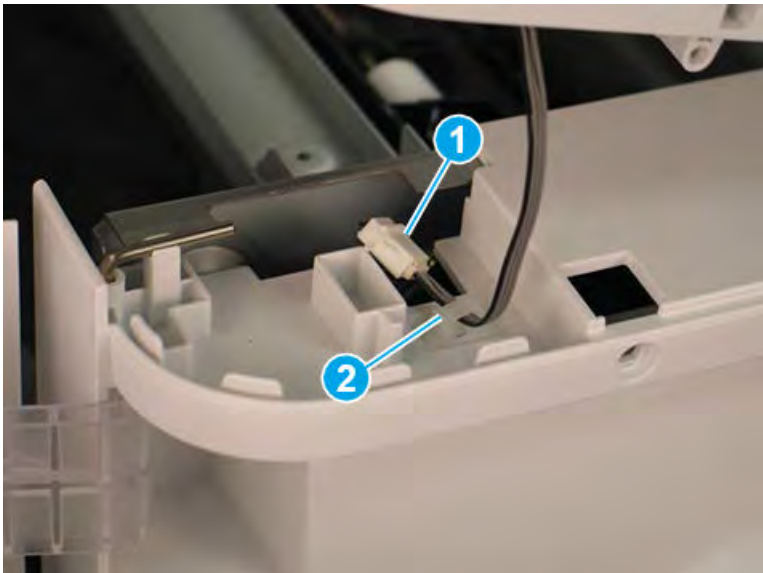
3. Lift the cover up slightly. Disconnect one in-line connector (callout 1), and then release one retainer (callout 2).

---

 **TIP:** Reverse the removal steps to install the assembly.

---

Figure 5-1032 Disconnect one connector and release retainer



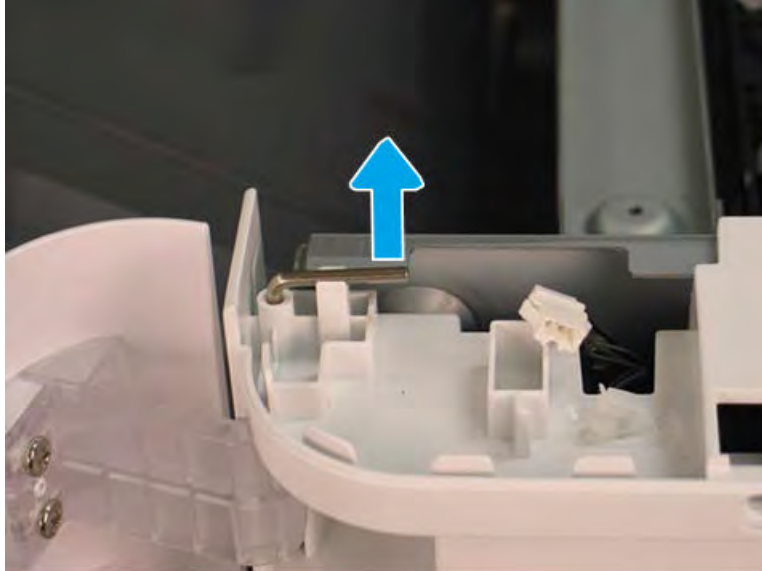
### Remove the front door (finisher)

Follow these steps to remove the front door (finisher).

1. Lift the top hinge pin up to release it from the retainer.

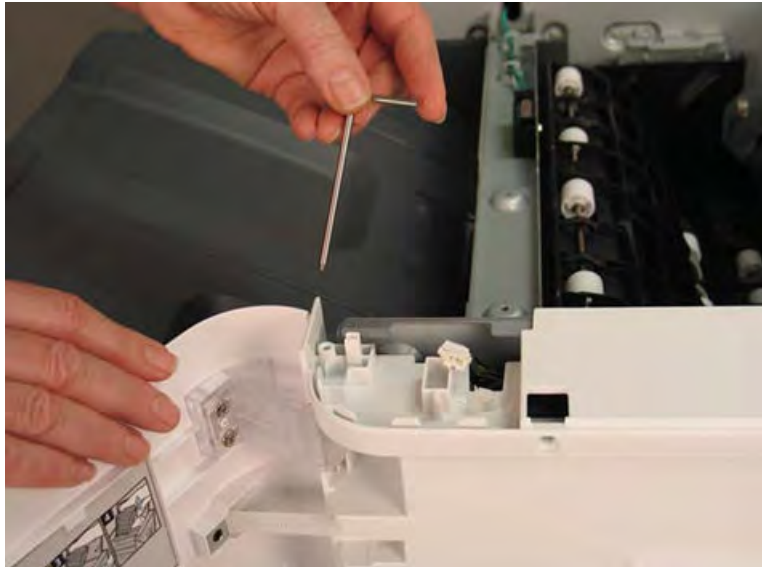


Figure 5-1033 Lift the top hinge pin



2. Pull the top hinge pin up to remove it.

Figure 5-1034 Remove the top hinge pin



3. Use a small, flat-blade screwdriver to release the lower hinge pin from the retainer, and then rotate it away from the finisher.

**Figure 5-1035** Release the lower hinge pin




4. Support the door with one hand, and then pull the lower hinge pin straight up to remove it.

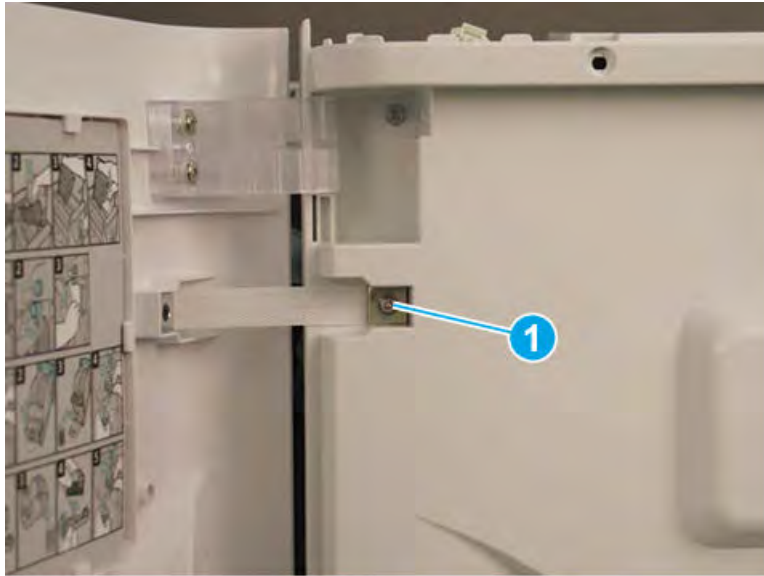
**Figure 5-1036** Remove the lower hinge pin



- Support the door with one hand, and then remove one screw (callout 1) to release the strap. Remove the front door.

 **TIP:** Reverse the removal steps to install the assembly.

**Figure 5-1037** Remove the front door

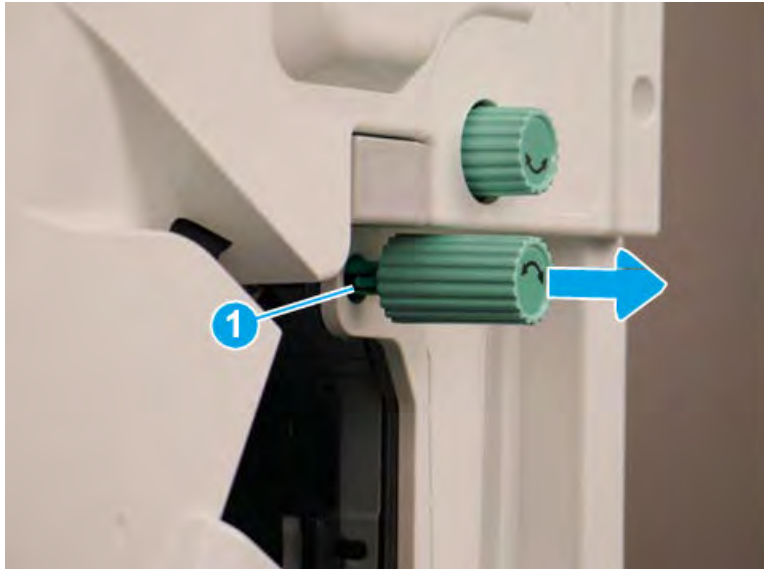


#### Remove the front cover (finisher)

Follow these steps to remove the front cover (finisher).

- Release one tab (callout 1), and then pull the jam-access knob away from the finisher to remove it.

**Figure 5-1038** Remove the jam-access knob



- If the punch unit is installed, remove the punch waste bin (callout 1).

3. Remove one screw (callout 1) on top of the front cover.

Figure 5-1039 Remove one screw



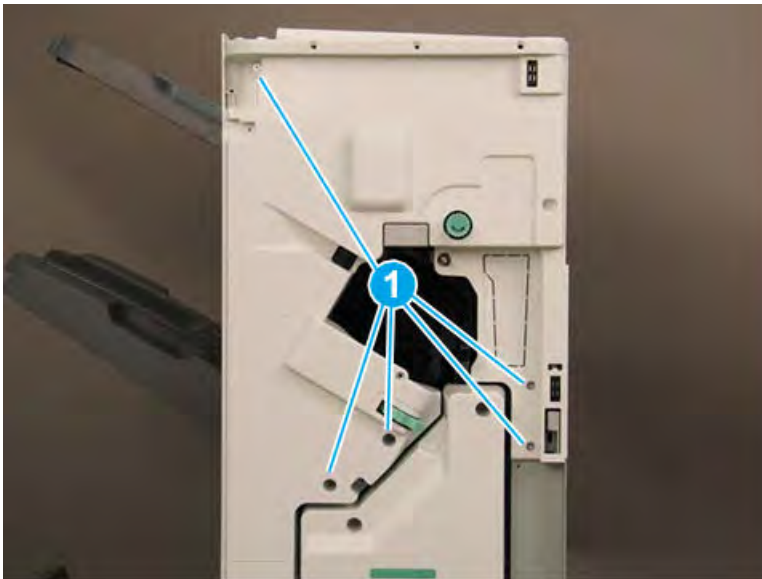
4. Remove five machine screws (callout 1), and then remove the front cover.

---

 **TIP:** Reverse the removal steps to install the assembly.

---

Figure 5-1040 Remove the front cover

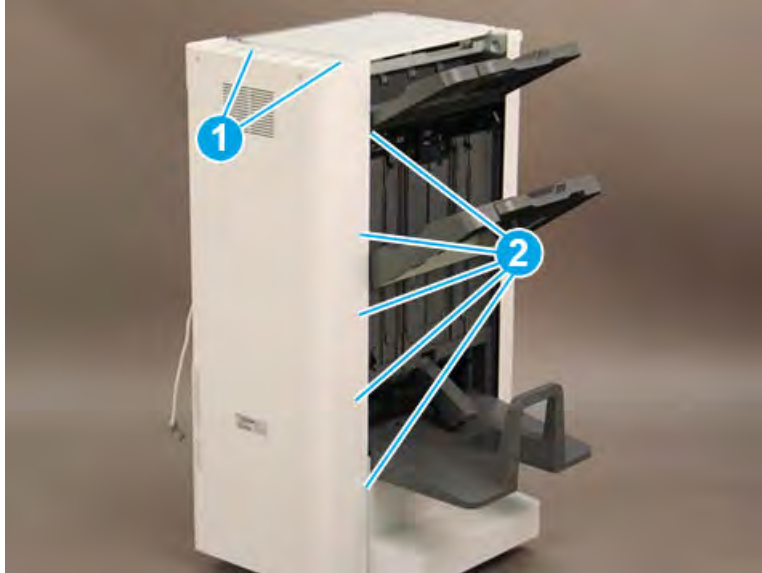


#### Remove the rear cover (finisher)

Follow these steps to remove the rear cover (finisher).

1. Remove two self-tapping screws (callout 1) on the top of the rear cover, and then remove five screw caps and five machine screws (callout 2) on the left side of the cover.

Figure 5-1041 Remove seven screws



2. Remove one screw cap and four machine screws (callout 1) Remove the rear cover.

 **NOTE:** Make sure to thread the power cable (callout 2) through the opening in the cover.


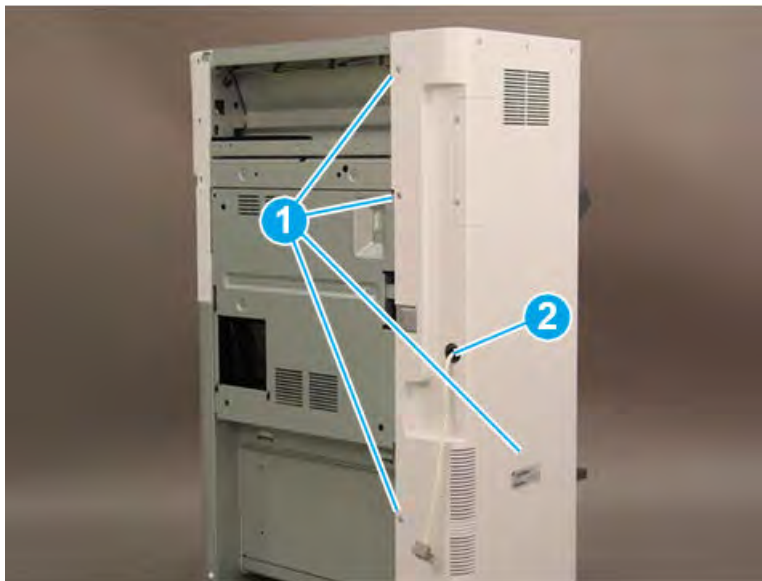
 **TIP:** Reverse the removal steps to install the assembly

Figure 5-1042 Remove the rear cover



### Remove the booklet output tray

Follow these steps to remove the booklet output tray.

1. Raise the booklet output tray up (callout 1), and then pull it away from the finisher (callout 2) to remove it.

Figure 5-1043 Remove the booklet output tray



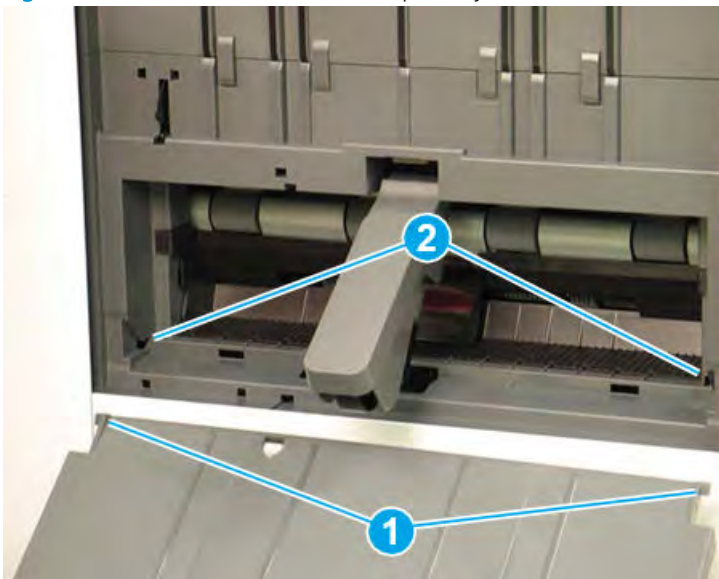
2. Reverse the removal steps to install the assembly. Also use the following special installation instructions.

 **NOTE:** Continue to reverse the removal steps to finish installing the assembly

Special installation instructions: booklet output tray

Position the tabs (callout 1) on the tray into the slots (callout 2) on the finisher.

Figure 5-1044 Install the booklet output tray

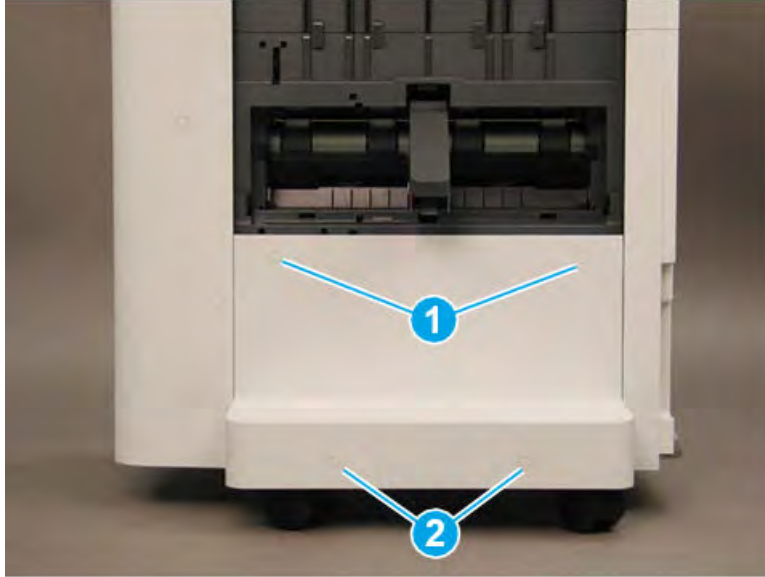


### Remove the caster cover

Follow these steps to remove the caster cover.

1. Remove two screw caps and two self-tapping screws (callout 1). Remove two screw caps and two machine screws (callout 2).

Figure 5-1045 Remove four screws



2. Rotate the left edge of the cover away from the finisher (callout 1), and then slide the cover to the left (callout 2) to remove it.

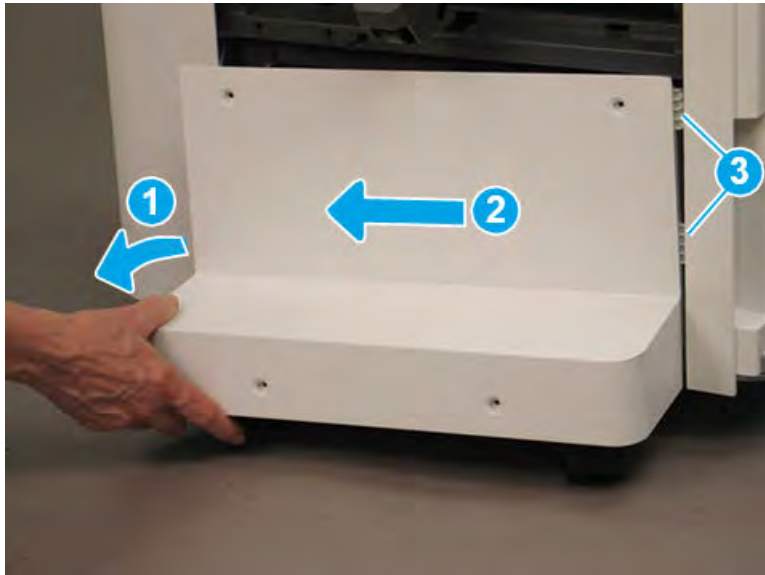
---

 **TIP:** Make sure that two tabs (callout 3) are positioned under the front lower cover when reinstalling the caster cover.

**TIP:** Reverse the removal steps to install the assembly

---

Figure 5-1046 Remove the caster cover




### Remove the left lower cover (finisher)

Follow these steps to remove the left lower cover (finisher).

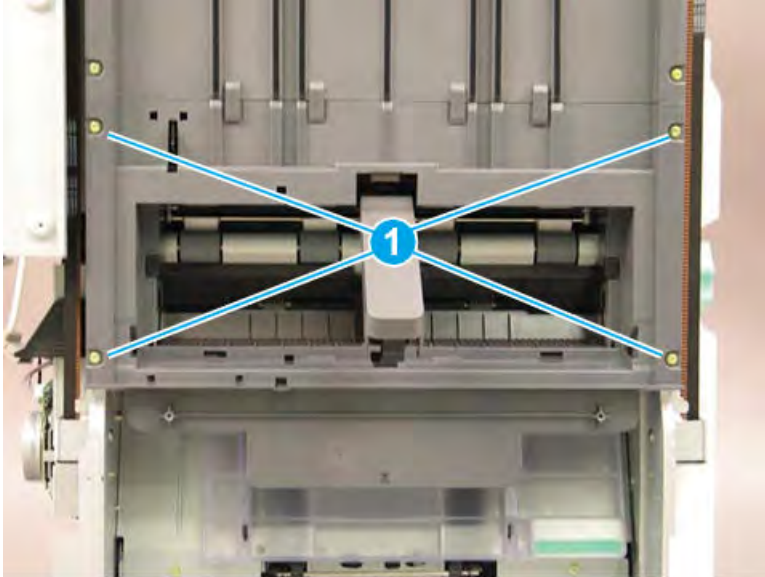
1. Remove four screws (callout 1).

---

 **NOTE:** Raise the lower output tray as needed to access the screws.

---

Figure 5-1047 Remove four screws



2. Slide the shield down (callout 1) to release it from four tabs (callout 2), and then rotate it away from the finisher (callout 3).

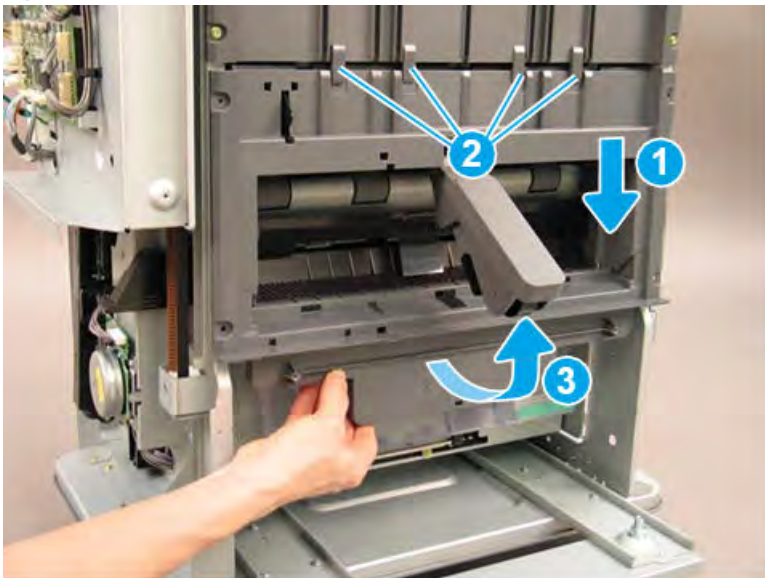
---

**⚠ CAUTION:** The shield is still attached to the finisher. Do not attempt to completely remove the shield.

**💡 TIP:** Position the shield under the four tabs (callout 2) when reinstalling it.


---

Figure 5-1048 Release the lower shield

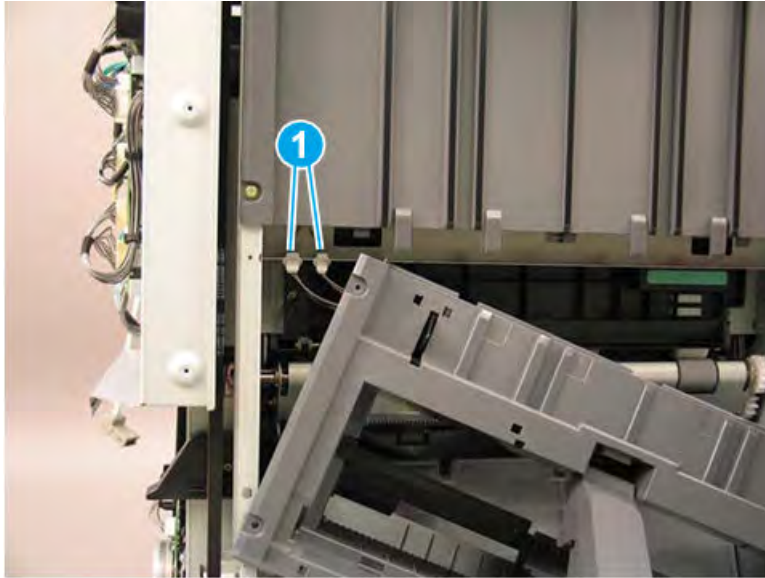




3. Disconnect two connectors (callout 1), and then remove the shield.

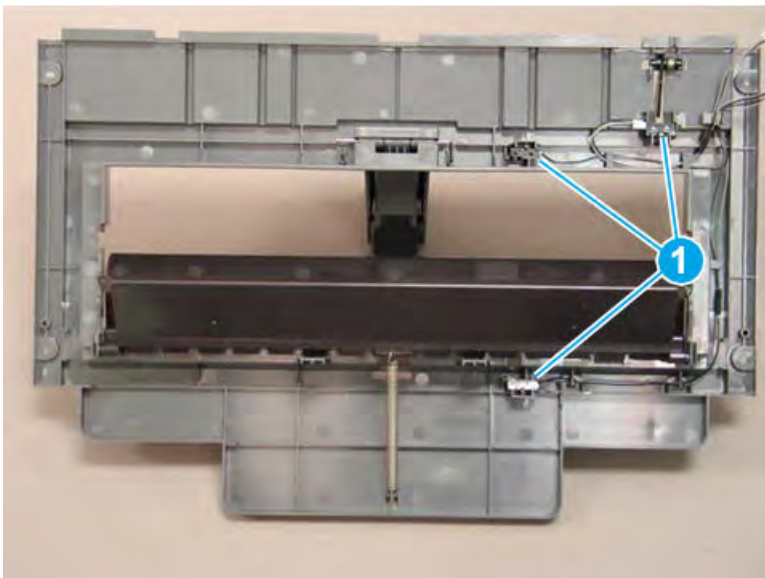
 **TIP:** Reverse the removal steps to install the assembly.

**Figure 5-1049** Disconnect two connectors



4. If you are replacing the left lower cover, locate three sensors (callout 1) on the back of the left lower cover. Remove these sensors and transfer them to the replacement part.

**Figure 5-1050** Remove the left lower cover

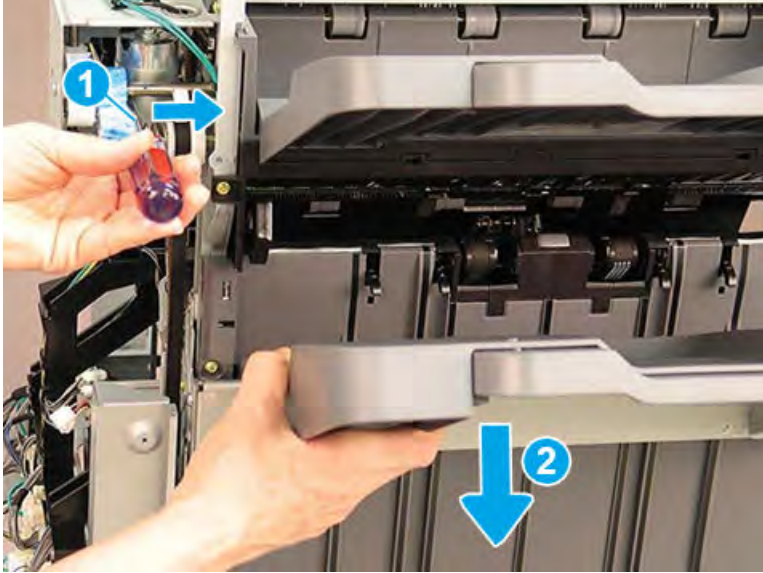


### Remove the left upper cover (finisher)

Follow these steps to remove the left upper cover (finisher).

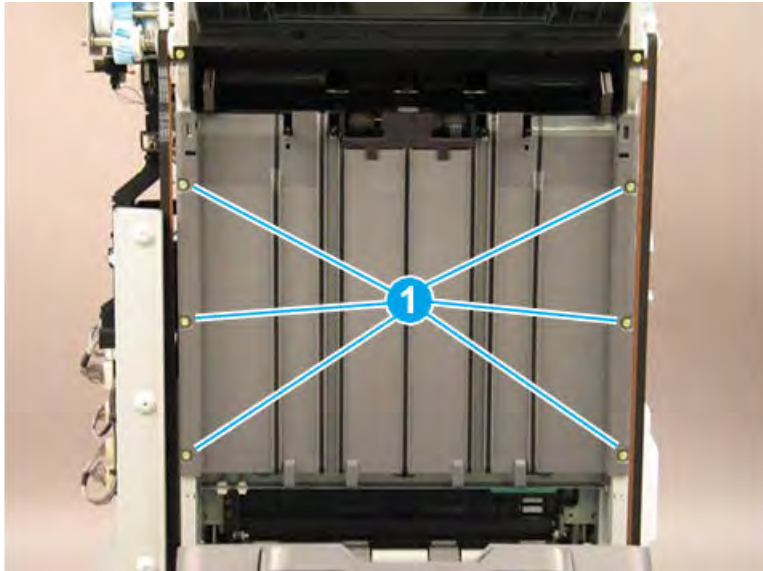
1. Bring the lower output tray down by positioning the shaft of a screwdriver on the clutch (callout 1) and gently pressing to the right to release the clutch. Hold the clutch in the released position and lower the tray (callout 2) to the lowest position.

Figure 5-1051 Lower the output tray



2. Remove six machine screws (callout 1).

Figure 5-1052 Remove six screws

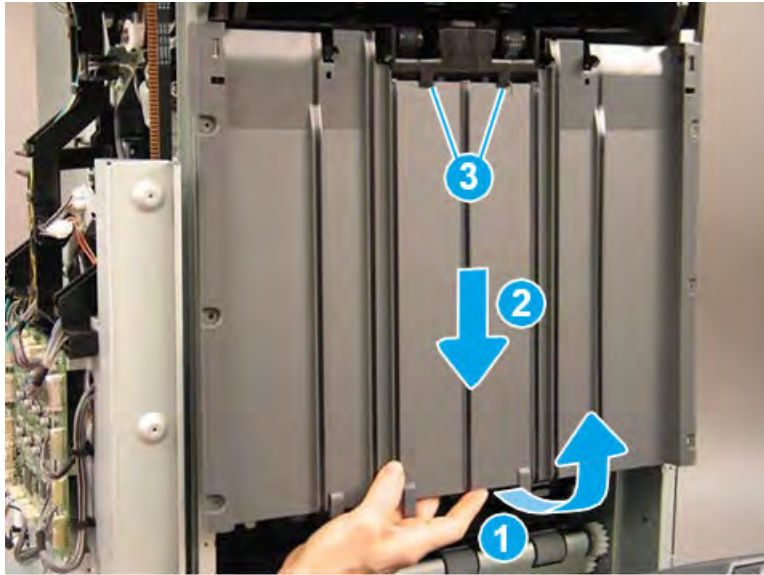


3. Rotate the lower edge of the shield away from the finisher (callout 1), and then slide the shield down (callout 2) to release it from two tabs (callout 3).

**CAUTION:** The shield is still attached to the finisher. Do not attempt to completely remove the shield.

**TIP:** Position the shield under the two tabs (callout 3) when reinstalling it.

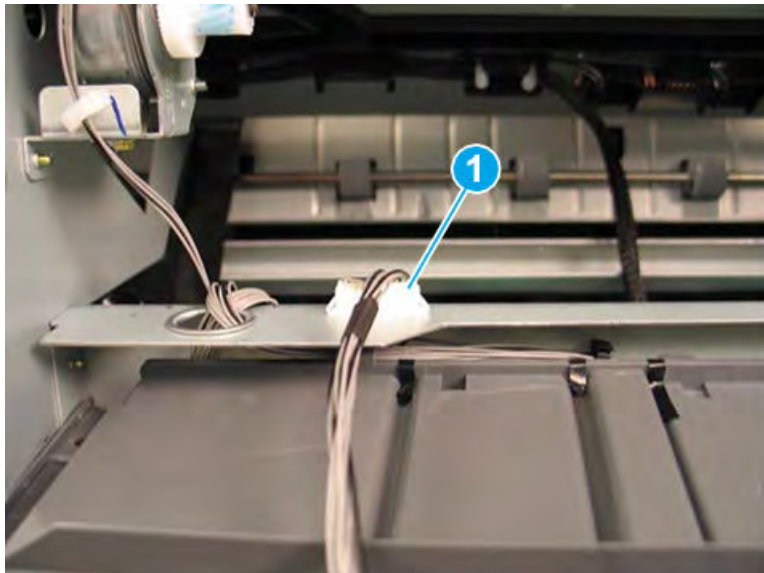
**Figure 5-1053** Release the shield



4. Disconnect one connector (callout 1), and then remove the upper shield assembly.

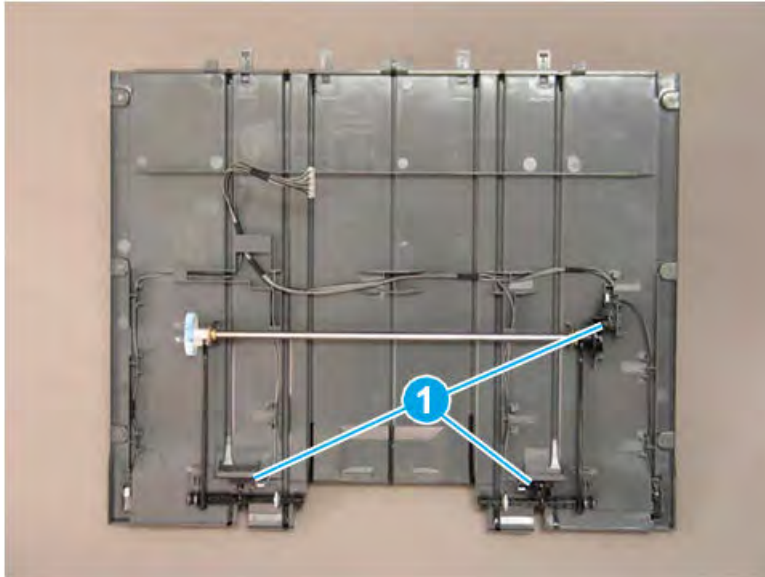
**TIP:** Reverse the removal steps to install the assembly.

**Figure 5-1054** Disconnect one connector



5. If you are replacing the left upper cover, locate three sensors (callout 1) on the back of the left upper cover. Remove these sensors and transfer them to the replacement part.

Figure 5-1055 Remove the left upper cover

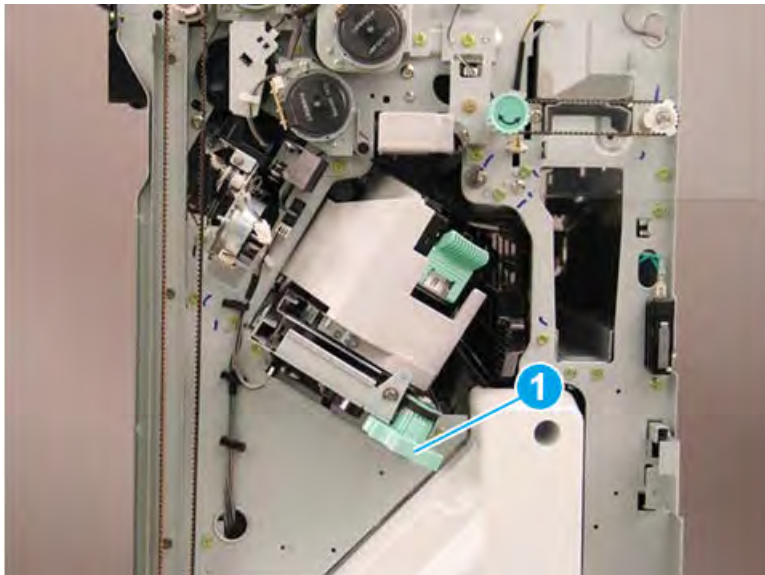


#### Remove the ejector unit (finisher)

Follow these steps to remove the ejector unit (finisher).

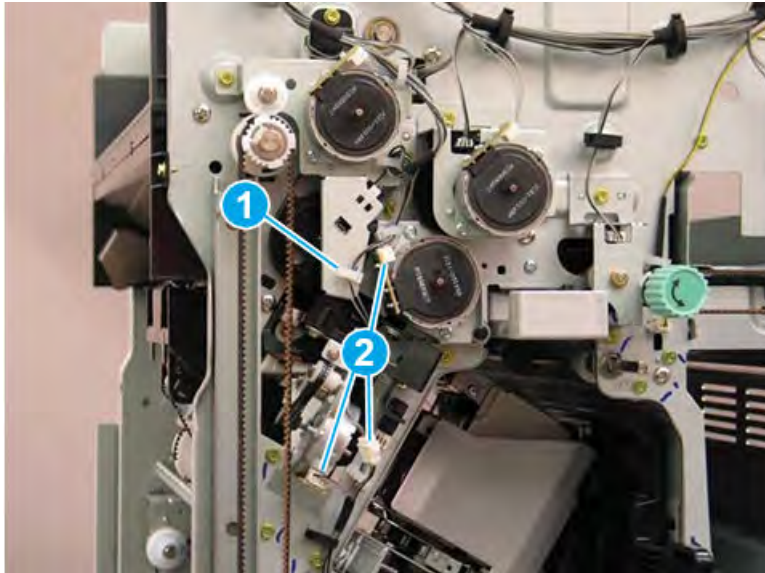
1. Rotate the green wheel to move the staple unit to the center of the finisher.

Figure 5-1056 Move the staple unit to the center



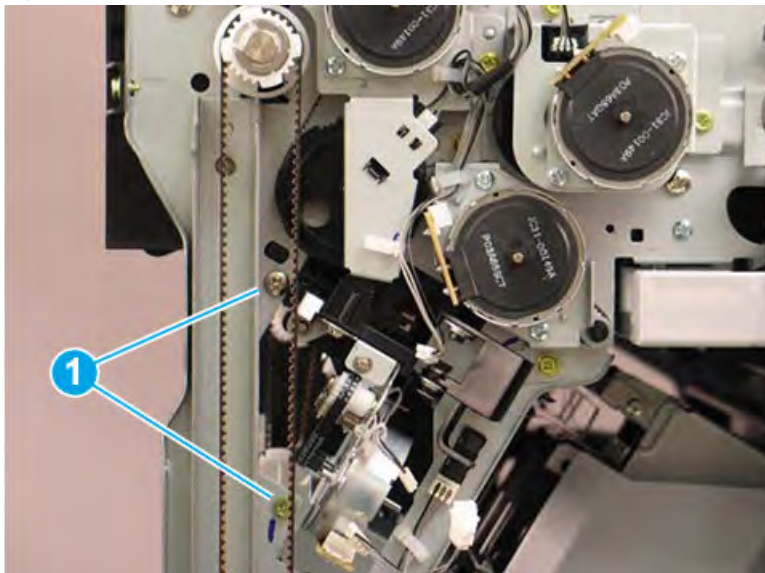
2. Release one retainer (callout 1), and then disconnect three connectors (callout 2).

Figure 5-1057 Disconnect three connectors



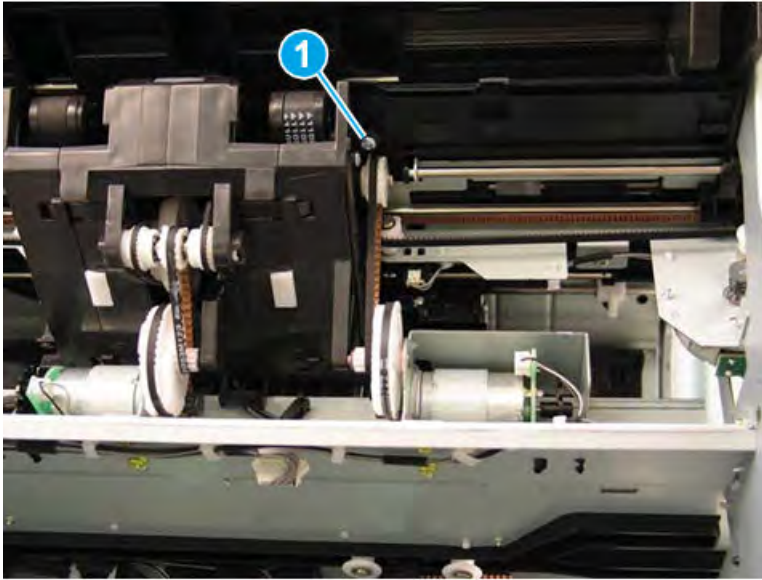
3. Remove two screws (callout 1).

Figure 5-1058 Remove two screws



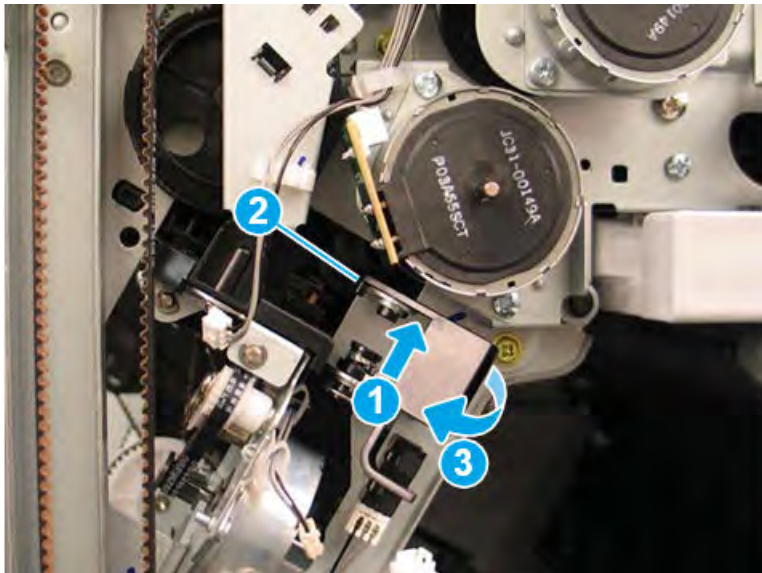
4. At the left side of the finisher, remove one screw (callout 1).

Figure 5-1059 Remove one screw



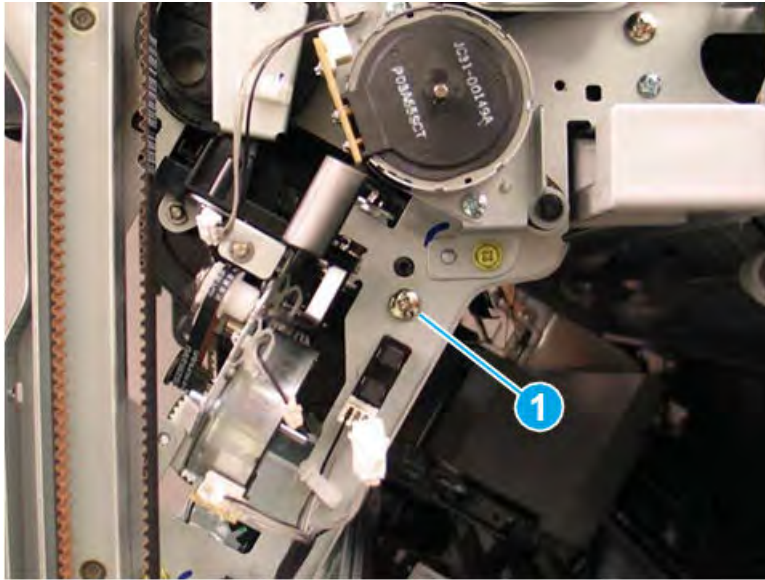
5. Press up on the hinge (callout 1), release one tab (callout 2), and then rotate the sensor away from the finisher (callout 3).

Figure 5-1060 Rotate the sensor



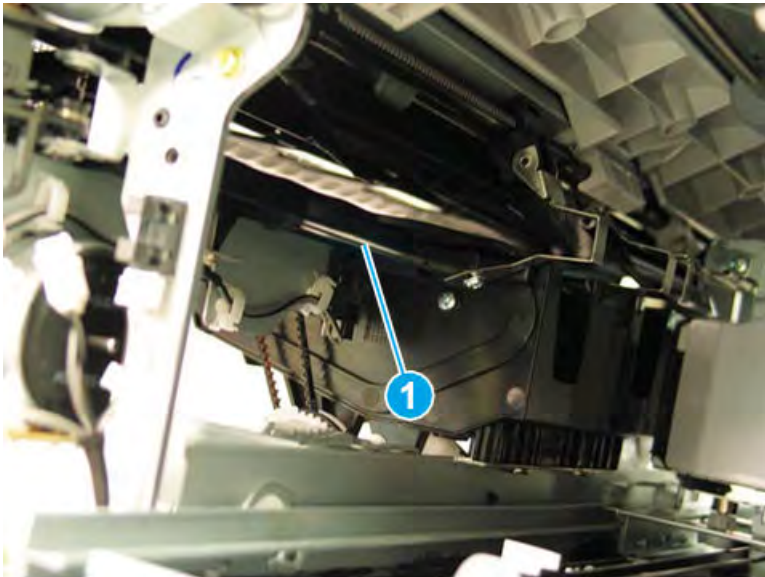
6. Remove one screw (callout 1).

Figure 5-1061 Remove one screw



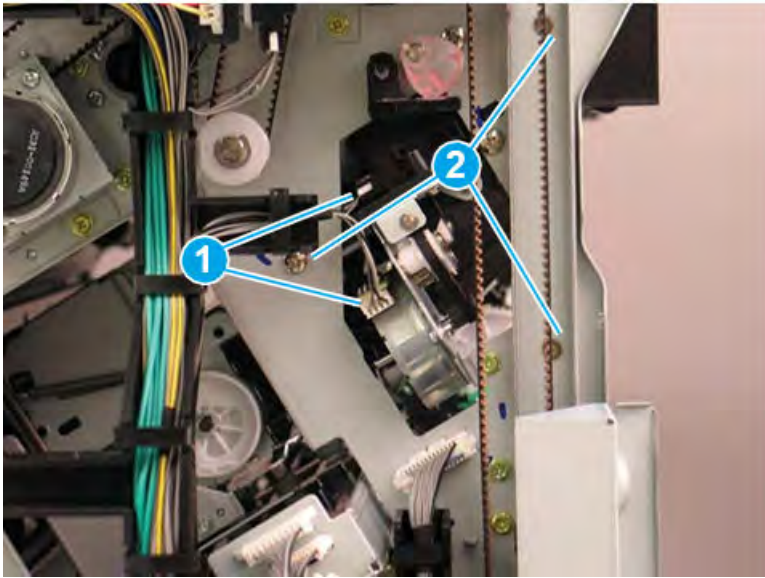
7. Look inside the finisher through the stapler opening in the front and pull down to release and remove one shaft (callout 1) on the front tamper unit.

Figure 5-1062 Remove the front tamper shaft



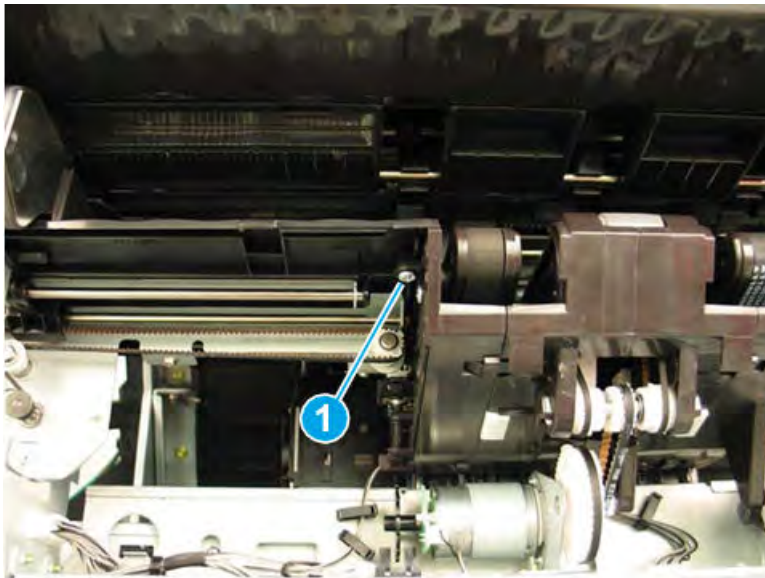
8. At the rear of the finisher, disconnect two connectors (callout 1), and then remove three screws (callout 2).

Figure 5-1063 Disconnect two connectors and remove three screws



9. At the left side of the finisher, remove one screw (callout 1).

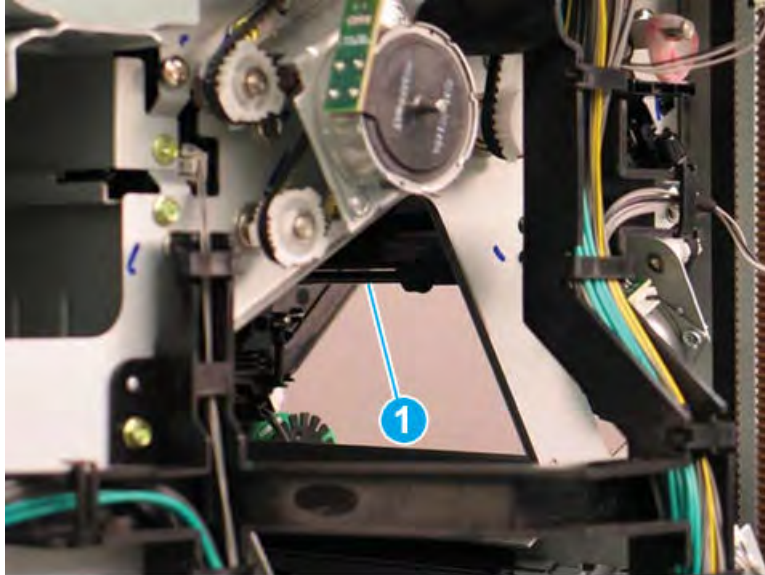
Figure 5-1064 Remove one screw





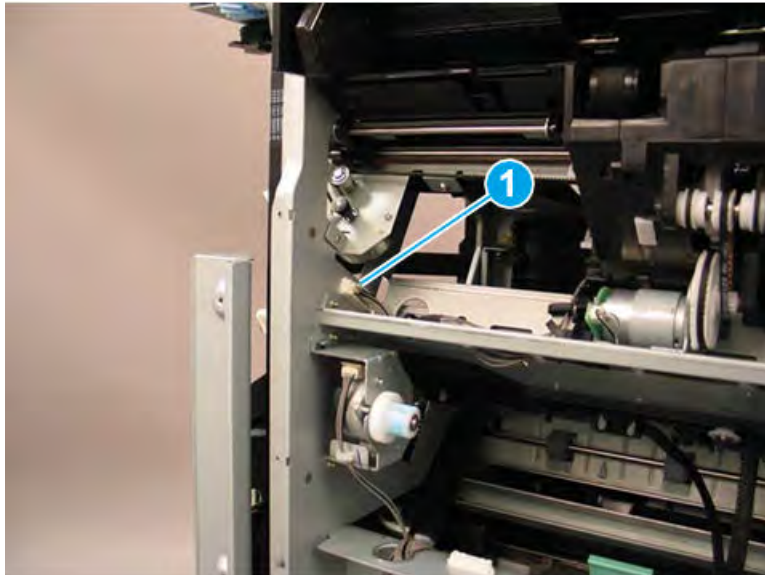
10. Look inside the finisher through the stapler opening in the rear and pull down to release and remove one shaft (callout 1) on the rear tamper unit.

Figure 5-1065 Remove the rear tamper shaft



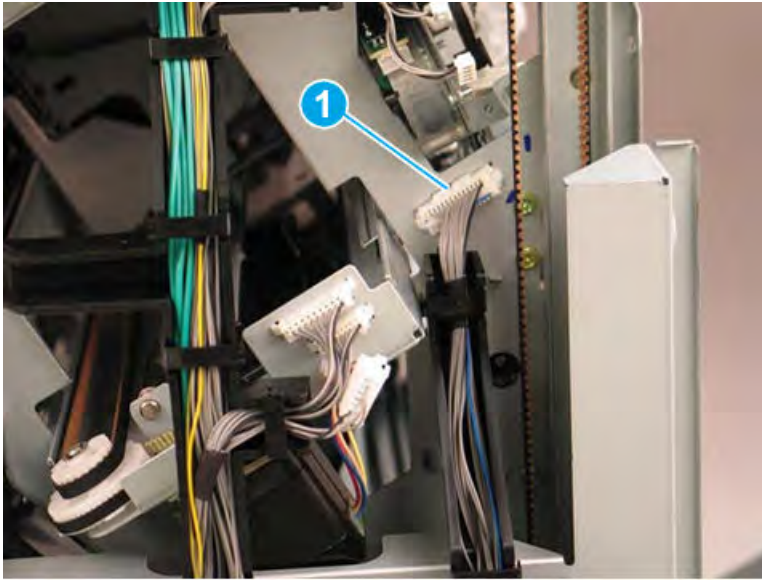
11. At the left side of the finisher, disconnect one connector (callout 1).

Figure 5-1066 Disconnect one connector



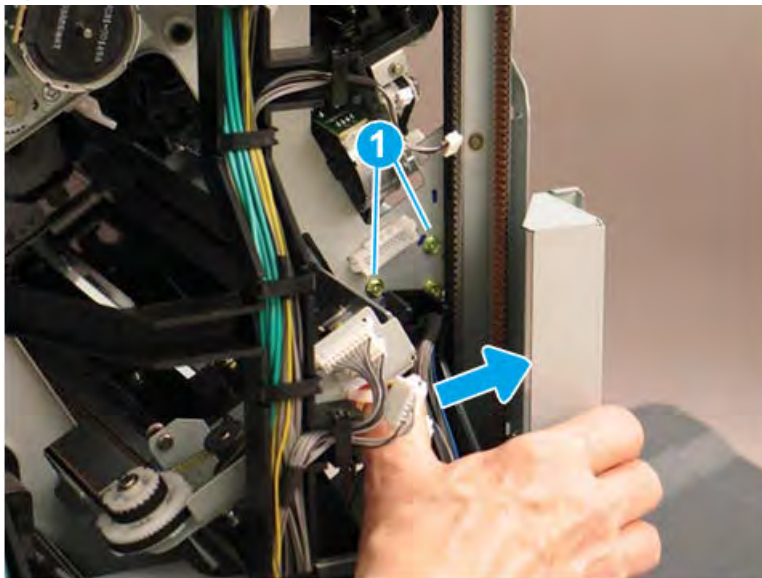
12. At the rear of the finisher, disconnect one connector (callout 1).

Figure 5-1067 Disconnect one connector



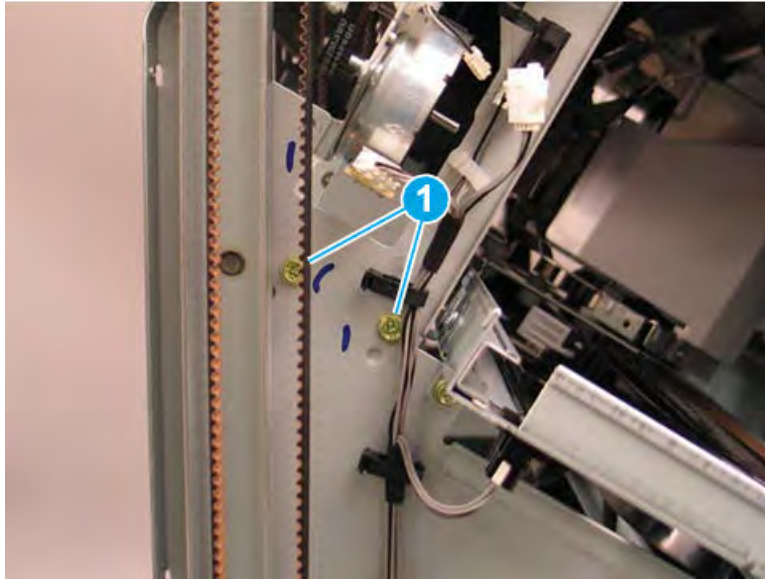
13. At the rear of the finisher, press the wire retainer to the right to access and remove two screws (callout 1).

Figure 5-1068 Disconnect one connector



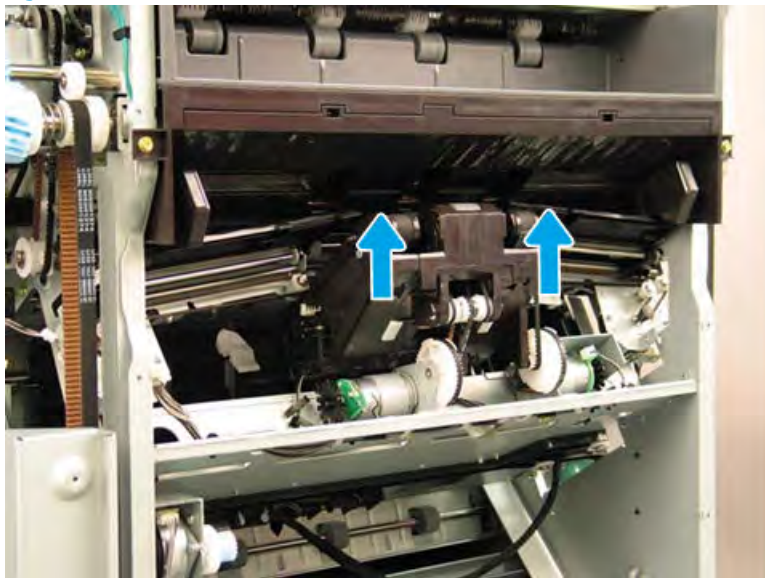
14. At the front of the finisher, remove two screws (callout 1).

Figure 5-1069 Remove two screws



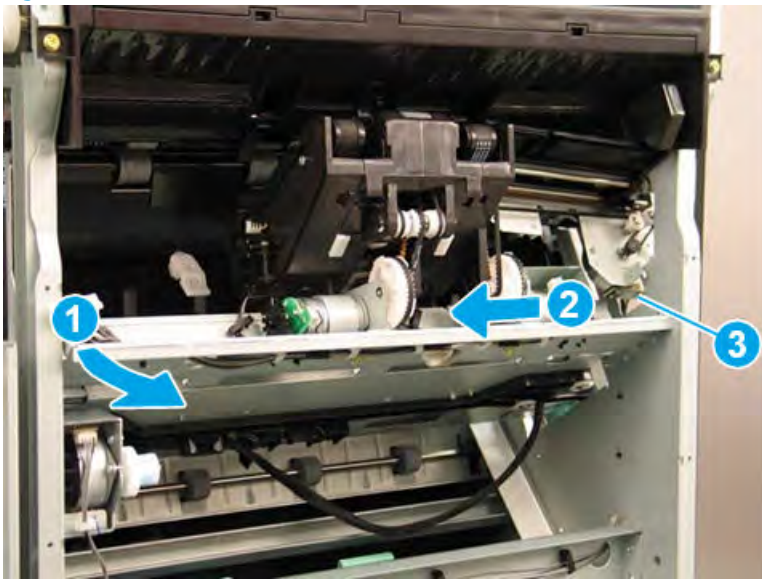
15. Lift the inside edges of the front and rear tampers up.

Figure 5-1070 Lift the edges of the tampers



16. Rotate the rear edge of the ejector unit away from the finisher (callout 1), and then slide it toward the rear of the finisher (callout 2) to remove it. Make sure that the PCA (callout 3) stays clear of the sheet metal frame.

Figure 5-1071 Remove the ejector unit

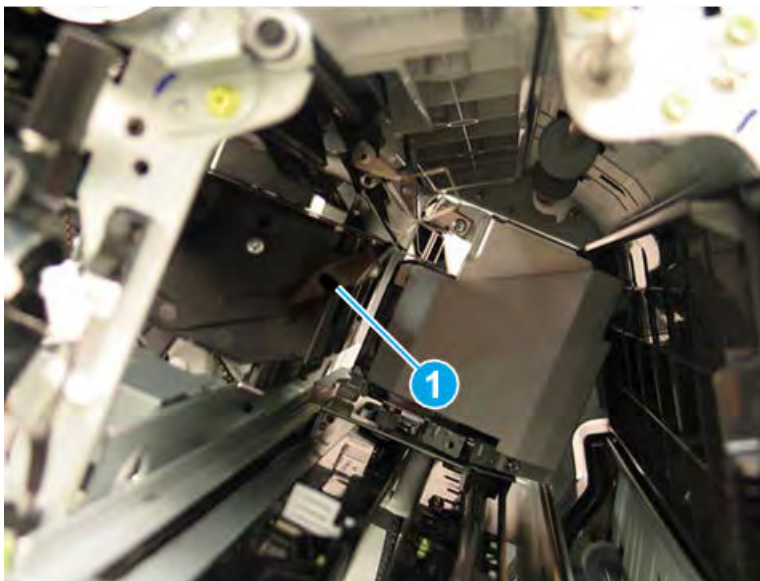


17. Reverse the removal steps to install the assembly. Also use the following special installation instructions.

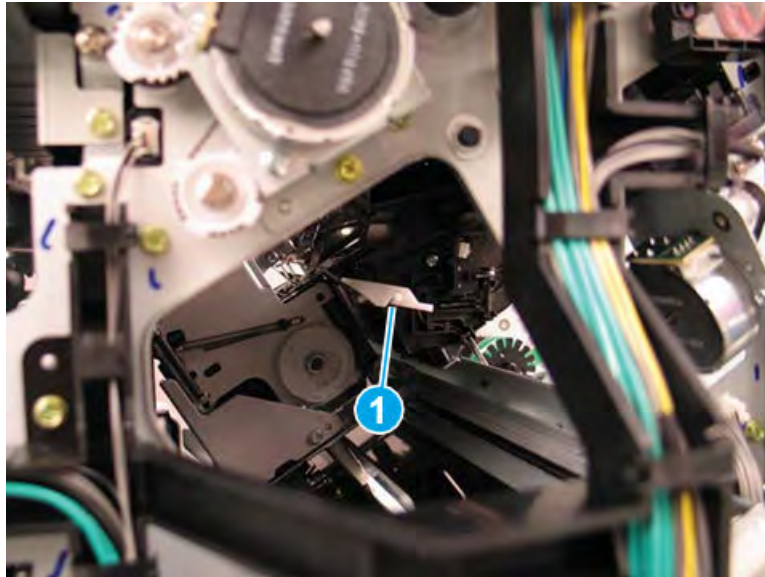
 **NOTE:** Continue to reverse the removal steps to finish installing the assembly.

#### Special installation instructions: Ejector unit

- a. When the front tamper shaft is removed, the retainer arm that held the one end of the shaft will drop down. When reinstalling the shaft, raise the retainer arm and position the end of the shaft in the notch (callout 1).



- b. When the rear tamper shaft is removed, the retainer arm that held the one end of the shaft will drop down. When reinstalling the shaft, raise the retainer arm and position the end of the shaft in the notch (callout 1).

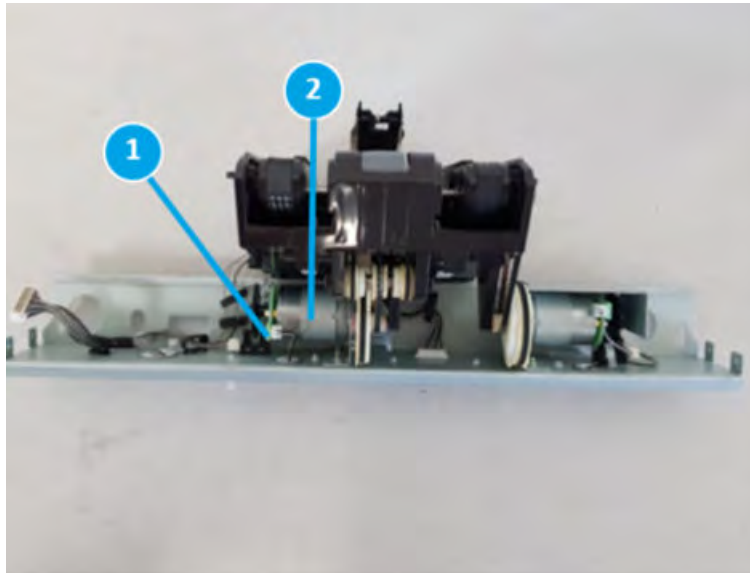


#### Remove the ejector1 motor(M6)

Follow these steps to remove the ejector1 motor(M6).

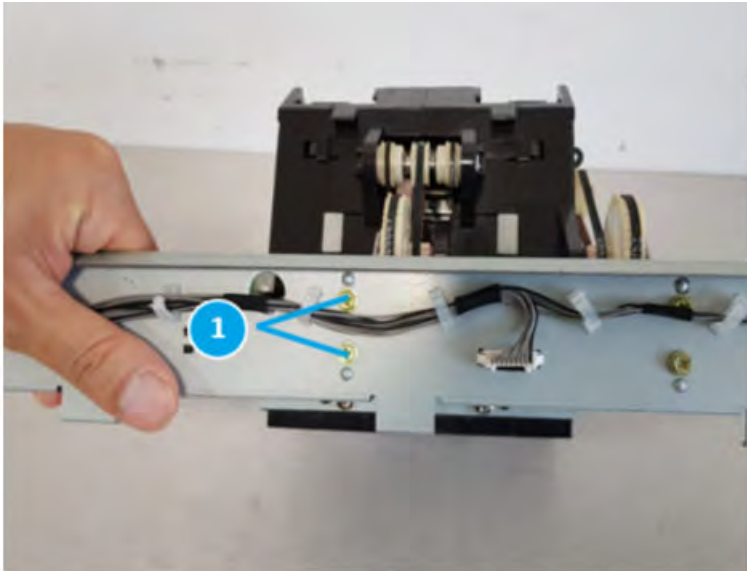
1. Disconnect the connector(callout 1) from ejector1 motor(M6, callout 2) of ejector unit.

Figure 5-1072 Disconnect the connector



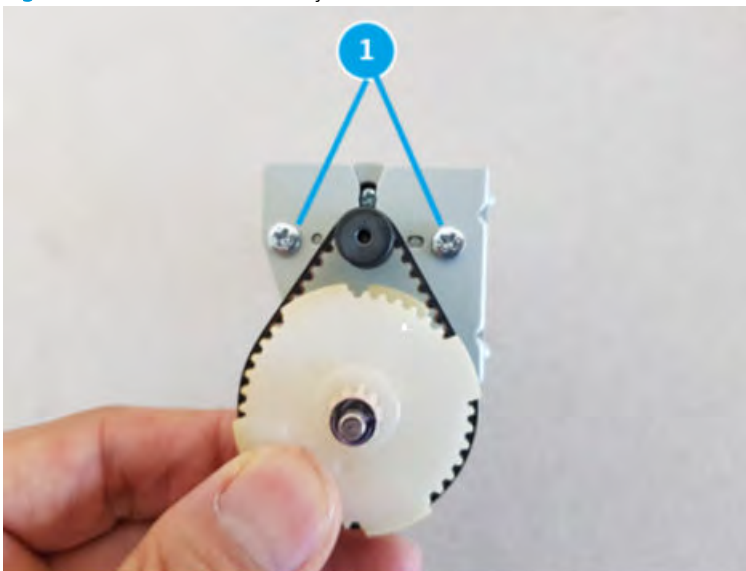
2. Remove two screws(callout 1).

Figure 5-1073 Remove two screws



3. Remove the ejector1 motor from ejector unit and remove two screws(callout 1)

Figure 5-1074 Remove the ejector1 motor



### Unpack the replacement assembly

Follow these steps to unpack the replacement assembly.

1. Dispose of the defective part.



---


 **NOTE:** HP recommends responsible disposal of the defective part.


<http://www8.hp.com/us/en/hp-information/environment/product-recycling.html>

---

2. Unpack the replacement part from the packaging.


 **CAUTION:**  Some parts are sensitive to electrostatic discharge (ESD). Always perform service work at an ESD-protected workstation or mat. If an ESD workstation or mat is not available, touch the sheet-metal chassis to provide a static ground before touching an ESD-sensitive assembly. Protect the ESD-sensitive assemblies by placing them in ESD pouches when they are out of the printer.

 **IMPORTANT:** Make sure that all of the shipping materials (for example shipping tape) are removed from the replacement part prior to installation.

 **NOTE:** If the replacement part is a roller or pad, avoid touching the spongy part of it. Skin oils on the roller or pad can cause paper pickup and/or print-quality problems. HP recommends using disposable gloves when handling rollers or pads or washing your hands before touching rollers or pads.

---

3. To install an assembly, reverse the removal steps.

 **NOTE:** When applicable, special installation instructions are provided for an assembly at the end of the removal procedure. Always completely read the removal instructions and follow all special installation instructions.

---

## Ejector2 unit




## Removal and replacement: Ejector2 home sensor (S32)

Learn how to remove and replace the ejector2 home sensor.

### Introduction

This document provides the procedures to remove and replace the ejector2 home sensor on the finisher.

 **IMPORTANT:** When applicable, special installation instructions are provided for an assembly at the end of the removal procedure. Always completely read the removal instructions and follow all special installation instructions.

### Before performing service

- Turn the printer power off. A shutting-down message appears on the control-panel display.
- ⚠ **WARNING!** To avoid damage to the printer, turn the power off and wait until the printer shuts down before removing the power cable.
- Disconnect the printer power cable after the printer has completely shut down (the control-panel display is blank).
- Release the finisher from the printer by pulling out on the release latch inside the finisher door.
- Disconnect the cable from the bridge unit to the finisher.
- Disconnect the cable from the finisher to the printer.

Use the table below to identify the correct part number for your printer. To order the part, go to <https://parts.hp.com>.

**Table 5-129** Part information

Part number	Part description
0604-001415	Ejector2 home sensor

### Required tools

- #2 JIS screwdriver with a magnetic tip
- Small, flat-blade screwdriver

### After performing service

- Connect the cable from the finisher to the printer.
- Connect the cable from the bridge unit to the finisher.
- Attach the finisher to the printer, and then push in on the release latch inside the finisher door.
- Connect the printer power cable.
- Turn the printer power on.

### Post service test

Process a job through the finisher and verify that the finisher works correctly.

## Remove the right upper cover (finisher)

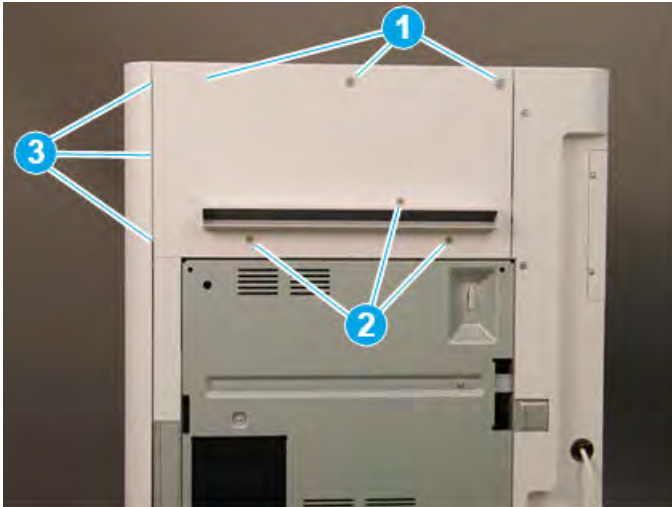
Follow these steps to remove the right upper cover (finisher).

- ▲ Remove one screw cap and three machine screws on the upper edge of the cover (callout 1). Remove three sheet metal screws (callout 2) on the lower portion of the cover. Rotate the right edge of the cover away from the finisher, and then slide the cover right to release three tabs (callout 3).

💡 **TIP:** The lower screws are shorter in length than the upper screws.

**TIP:** Reverse the removal steps to install the assembly.

**Figure 5-1075** Remove the right upper cover

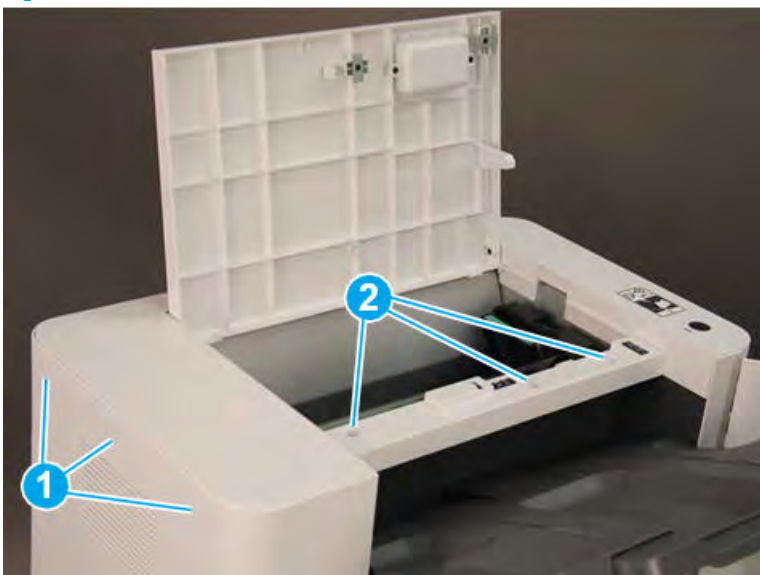


## Remove the top cover (finisher)

Follow these steps to remove the top cover (finisher).

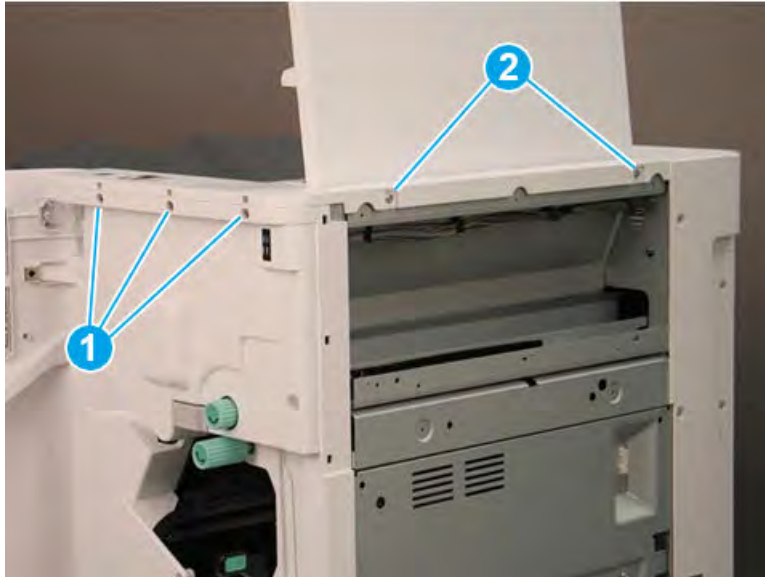
1. Remove three screw caps and three self-tapping screws at the top of the rear cover (callout 1), and then remove three machine screws (callout 2) on top of the cover.

**Figure 5-1076** Remove six screws




2. Remove three self-tapping screws at the top of the front cover (callout 1), and then remove two machine screws (callout 2) at the top of the right side.

Figure 5-1077 Remove five screws



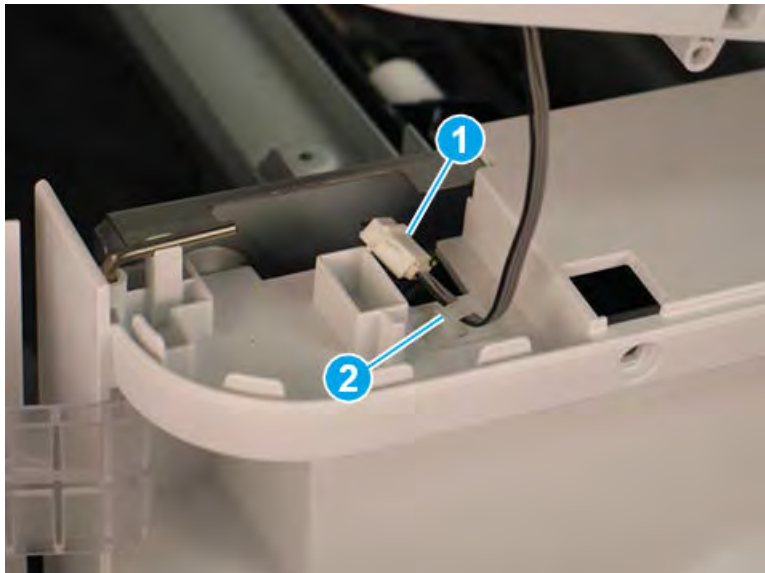
3. Lift the cover up slightly. Disconnect one in-line connector (callout 1), and then release one retainer (callout 2).

---

 **TIP:** Reverse the removal steps to install the assembly.

---

Figure 5-1078 Disconnect one connector and release retainer

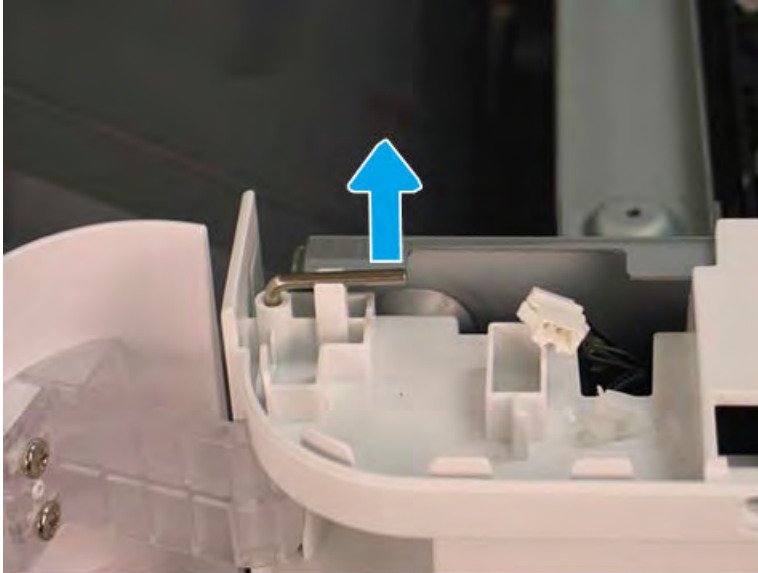


### Remove the front door (finisher)

Follow these steps to remove the front door (finisher).

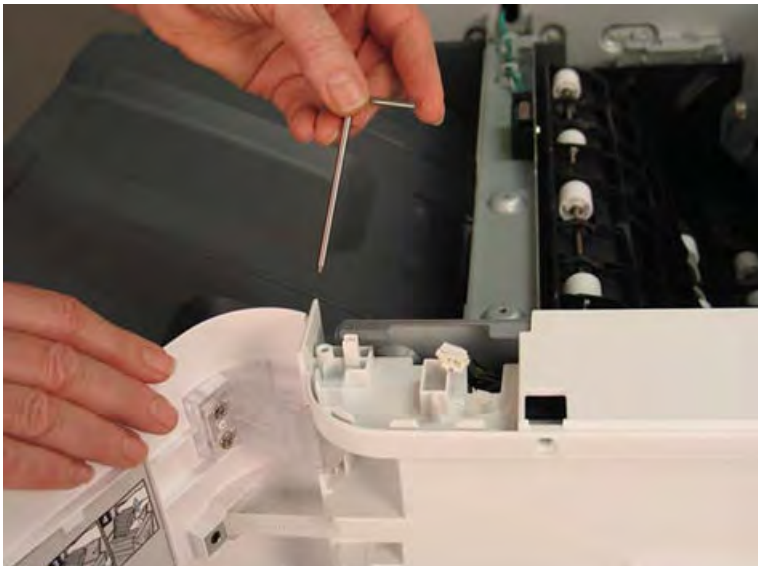
1. Lift the top hinge pin up to release it from the retainer.

Figure 5-1079 Lift the top hinge pin



2. Pull the top hinge pin up to remove it.

Figure 5-1080 Remove the top hinge pin



3. Use a small, flat-blade screwdriver to release the lower hinge pin from the retainer, and then rotate it away from the finisher.

Figure 5-1081 Release the lower hinge pin




4. Support the door with one hand, and then pull the lower hinge pin straight up to remove it.

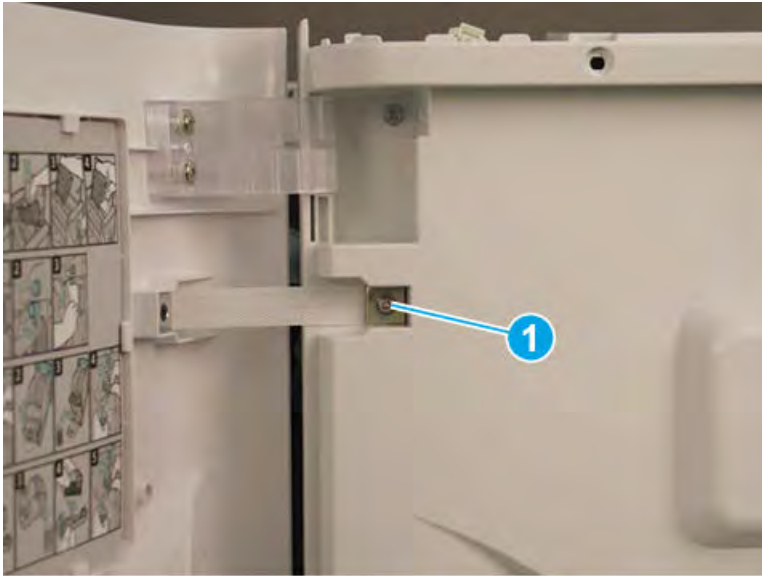
Figure 5-1082 Remove the lower hinge pin



5. Support the door with one hand, and then remove one screw (callout 1) to release the strap. Remove the front door.

 **TIP:** Reverse the removal steps to install the assembly.

**Figure 5-1083** Remove the front door

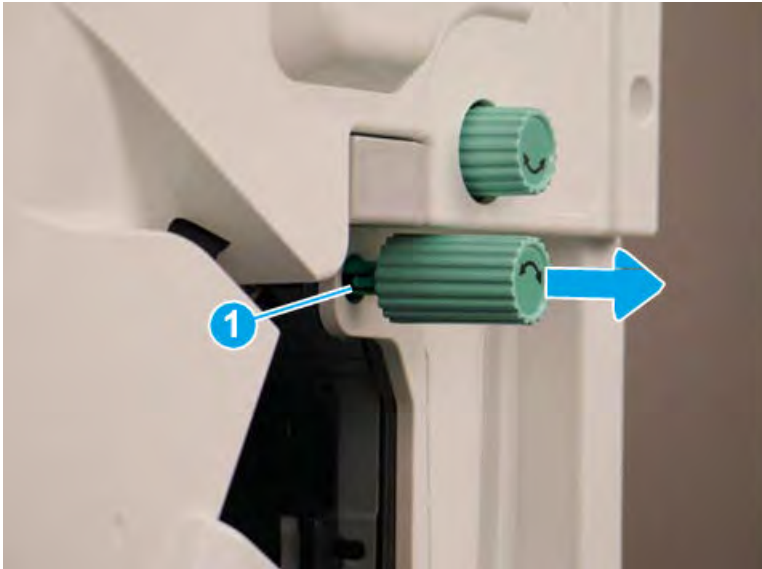


#### Remove the front cover (finisher)

Follow these steps to remove the front cover (finisher).

1. Release one tab (callout 1), and then pull the jam-access knob away from the finisher to remove it.

**Figure 5-1084** Remove the jam-access knob



2. If the punch unit is installed, remove the punch waste bin (callout 1).


3. Remove one screw (callout 1) on top of the front cover.

Figure 5-1085 Remove one screw



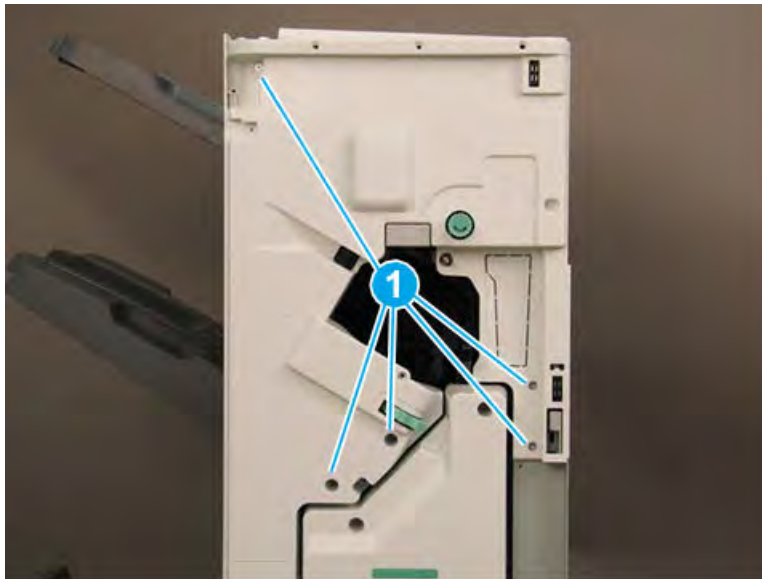
4. Remove five machine screws (callout 1), and then remove the front cover.

---

 **TIP:** Reverse the removal steps to install the assembly.

---

Figure 5-1086 Remove the front cover



### Remove the rear cover (finisher)

Follow these steps to remove the rear cover (finisher).

1. Remove two self-tapping screws (callout 1) on the top of the rear cover, and then remove five screw caps and five machine screws (callout 2) on the left side of the cover.

Figure 5-1087 Remove seven screws

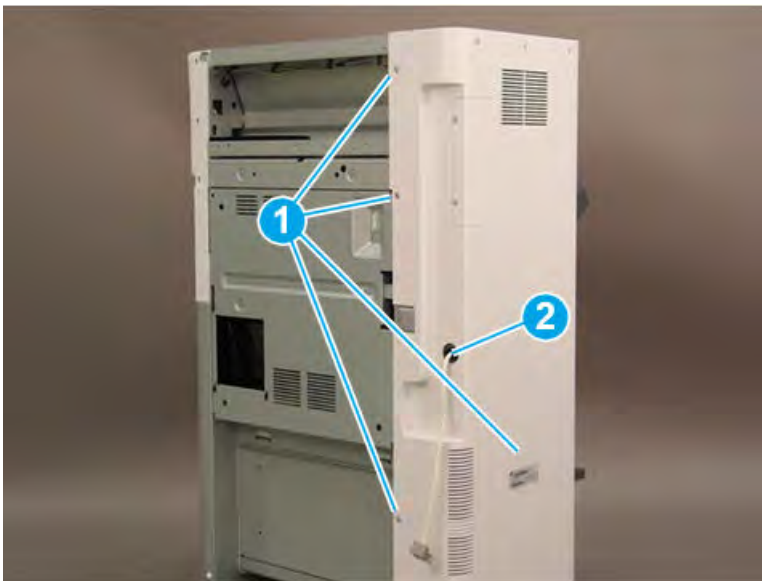


2. Remove one screw cap and four machine screws (callout 1) Remove the rear cover.

 **NOTE:** Make sure to thread the power cable (callout 2) through the opening in the cover.

 **TIP:** Reverse the removal steps to install the assembly

Figure 5-1088 Remove the rear cover



### Remove the booklet output tray

Follow these steps to remove the booklet output tray.

1. Raise the booklet output tray up (callout 1), and then pull it away from the finisher (callout 2) to remove it.



Figure 5-1089 Remove the booklet output tray



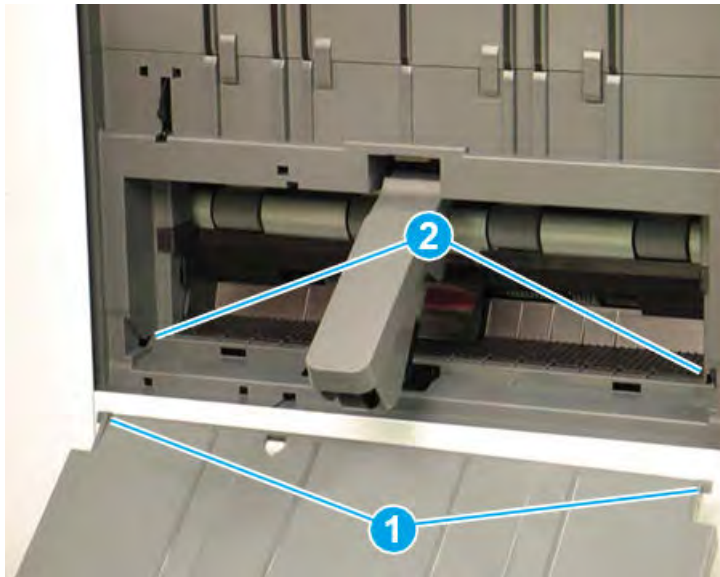
2. Reverse the removal steps to install the assembly. Also use the following special installation instructions.

 **NOTE:** Continue to reverse the removal steps to finish installing the assembly

Special installation instructions: booklet output tray

Position the tabs (callout 1) on the tray into the slots (callout 2) on the finisher.

Figure 5-1090 Install the booklet output tray

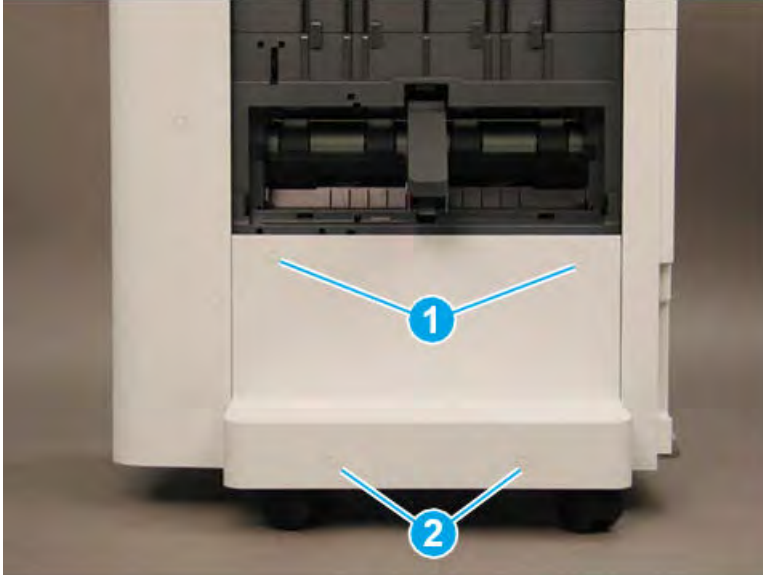


### Remove the caster cover

Follow these steps to remove the caster cover.


1. Remove two screw caps and two self-tapping screws (callout 1). Remove two screw caps and two machine screws (callout 2).

Figure 5-1091 Remove four screws



2. Rotate the left edge of the cover away from the finisher (callout 1), and then slide the cover to the left (callout 2) to remove it.

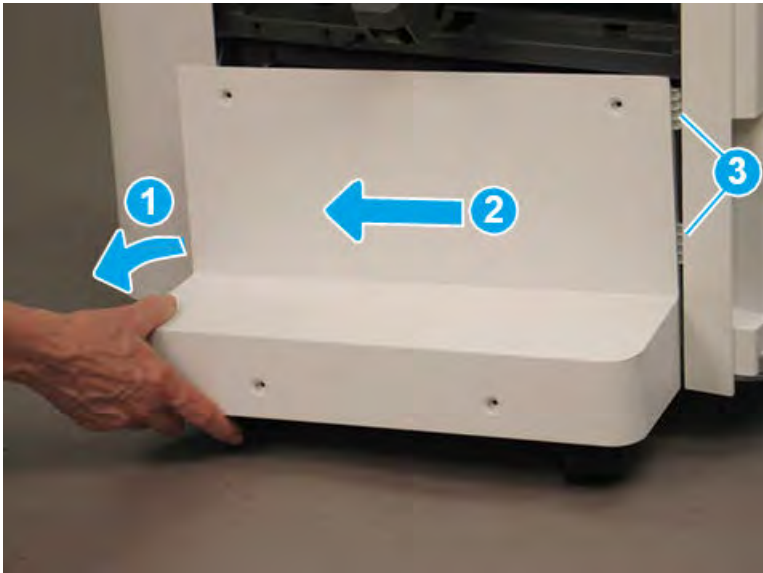
---

 **TIP:** Make sure that two tabs (callout 3) are positioned under the front lower cover when reinstalling the caster cover.

**TIP:** Reverse the removal steps to install the assembly

---

Figure 5-1092 Remove the caster cover




### Remove the left lower cover (finisher)

Follow these steps to remove the left lower cover (finisher).

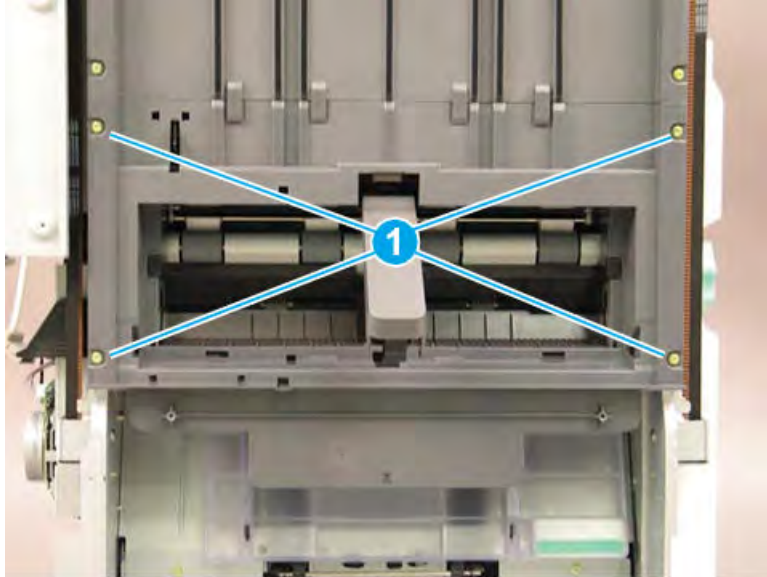
1. Remove four screws (callout 1).

---

 **NOTE:** Raise the lower output tray as needed to access the screws.

---

Figure 5-1093 Remove four screws

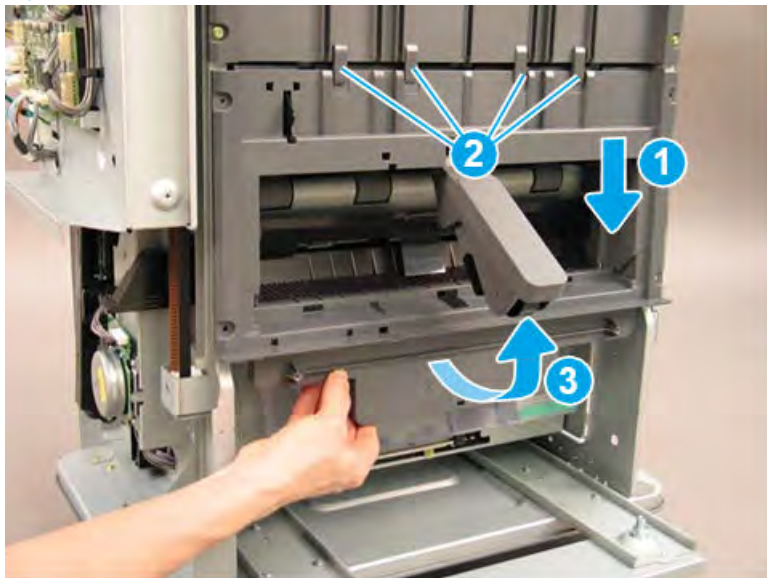


2. Slide the shield down (callout 1) to release it from four tabs (callout 2), and then rotate it away from the finisher (callout 3).


**⚠ CAUTION:** The shield is still attached to the finisher. Do not attempt to completely remove the shield.

**💡 TIP:** Position the shield under the four tabs (callout 2) when reinstalling it.

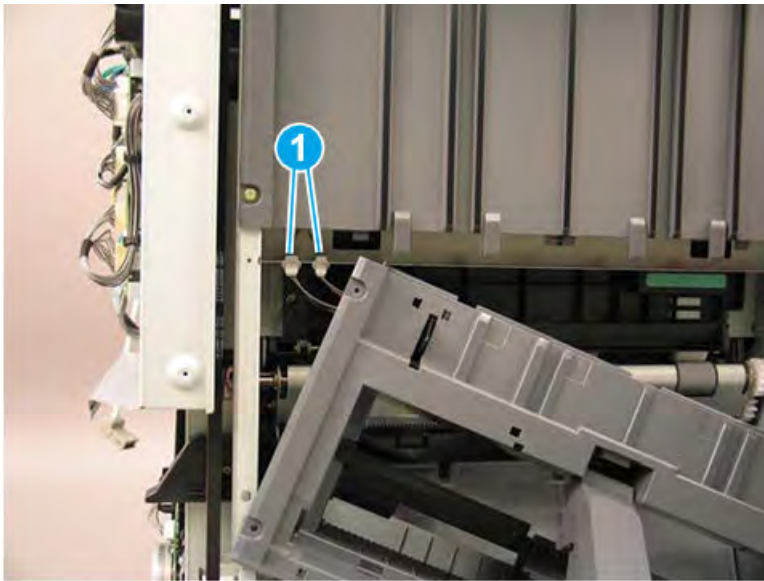
Figure 5-1094 Release the lower shield



3. Disconnect two connectors (callout 1), and then remove the shield.

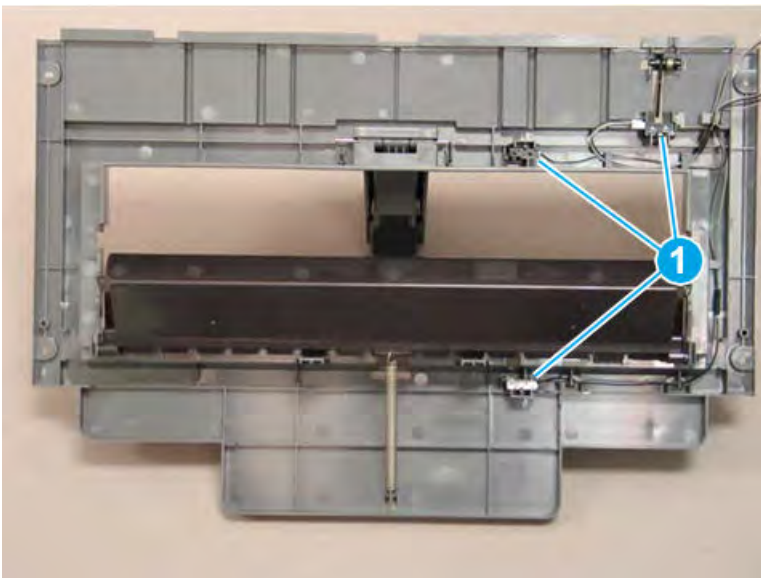
 **TIP:** Reverse the removal steps to install the assembly.

**Figure 5-1095** Disconnect two connectors



4. If you are replacing the left lower cover, locate three sensors (callout 1) on the back of the left lower cover. Remove these sensors and transfer them to the replacement part.

**Figure 5-1096** Remove the left lower cover

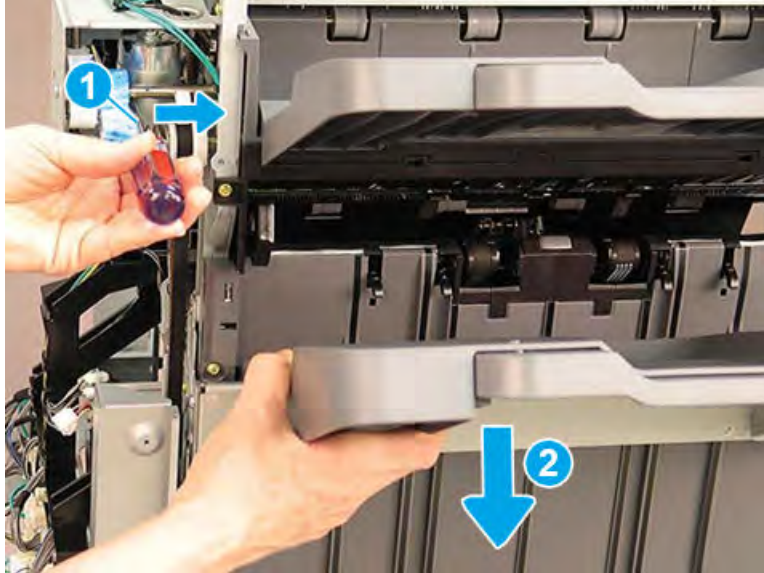


### Remove the left upper cover (finisher)

Follow these steps to remove the left upper cover (finisher).

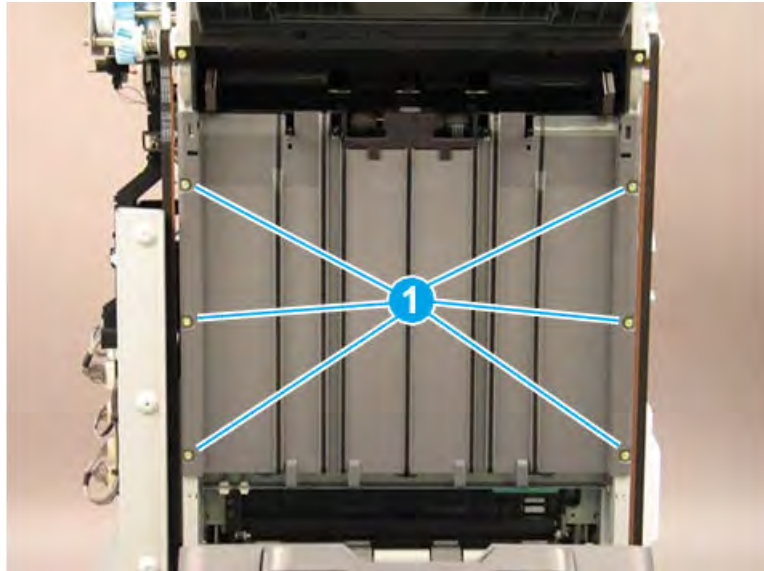
1. Bring the lower output tray down by positioning the shaft of a screwdriver on the clutch (callout 1) and gently pressing to the right to release the clutch. Hold the clutch in the released position and lower the tray (callout 2) to the lowest position.

Figure 5-1097 Lower the output tray



2. Remove six machine screws (callout 1).

Figure 5-1098 Remove six screws

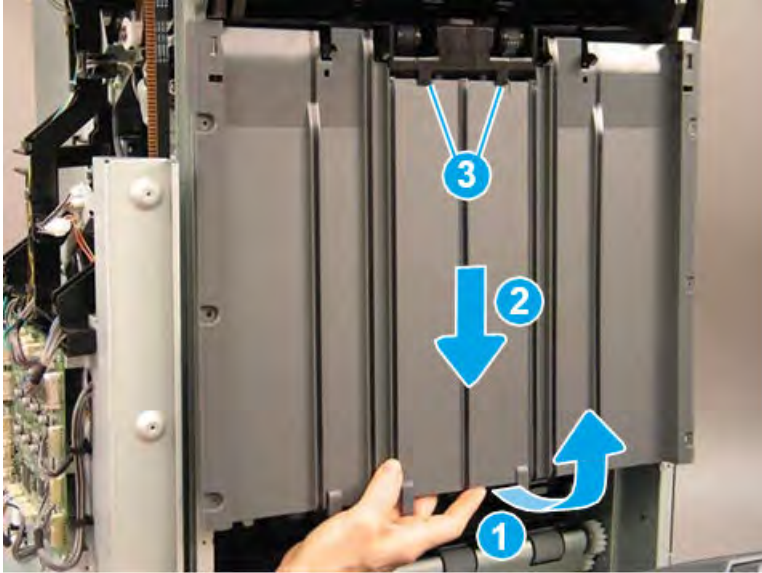


3. Rotate the lower edge of the shield away from the finisher (callout 1), and then slide the shield down (callout 2) to release it from two tabs (callout 3).

**CAUTION:** The shield is still attached to the finisher. Do not attempt to completely remove the shield.

**TIP:** Position the shield under the two tabs (callout 3) when reinstalling it.

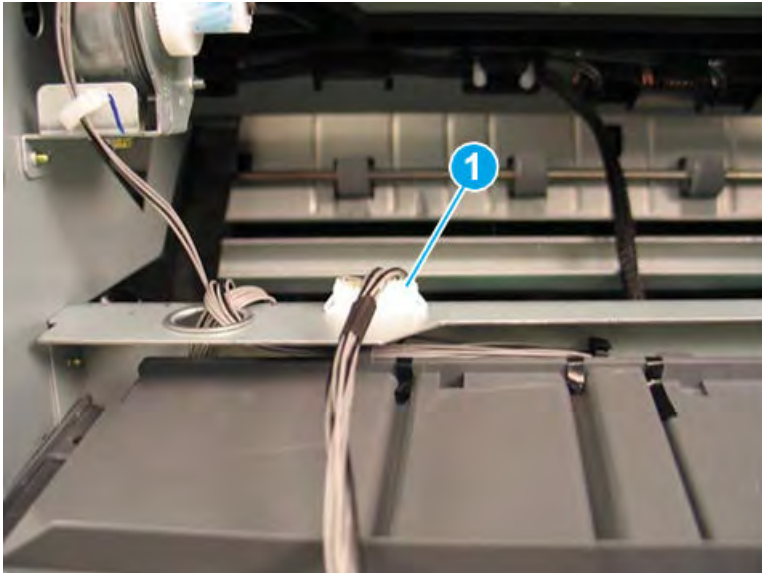
**Figure 5-1099** Release the shield



4. Disconnect one connector (callout 1), and then remove the upper shield assembly.

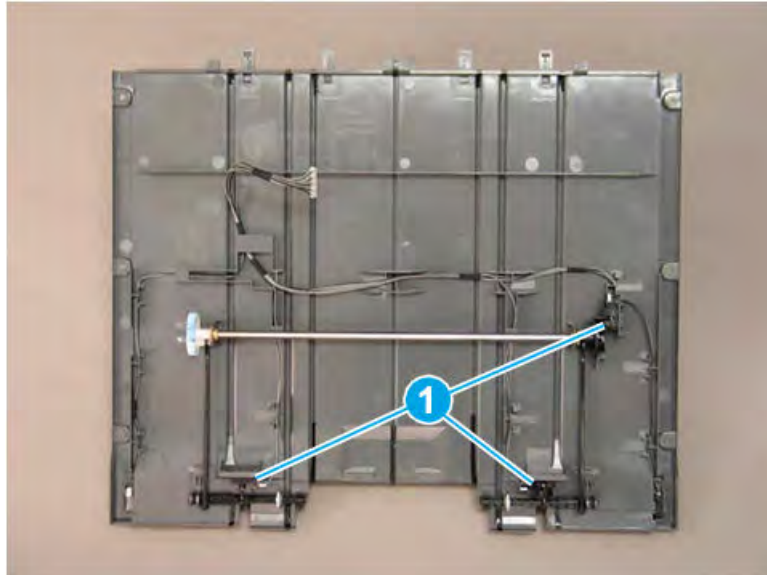
**TIP:** Reverse the removal steps to install the assembly.

**Figure 5-1100** Disconnect one connector



5. If you are replacing the left upper cover, locate three sensors (callout 1) on the back of the left upper cover. Remove these sensors and transfer them to the replacement part.

Figure 5-1101 Remove the left upper cover

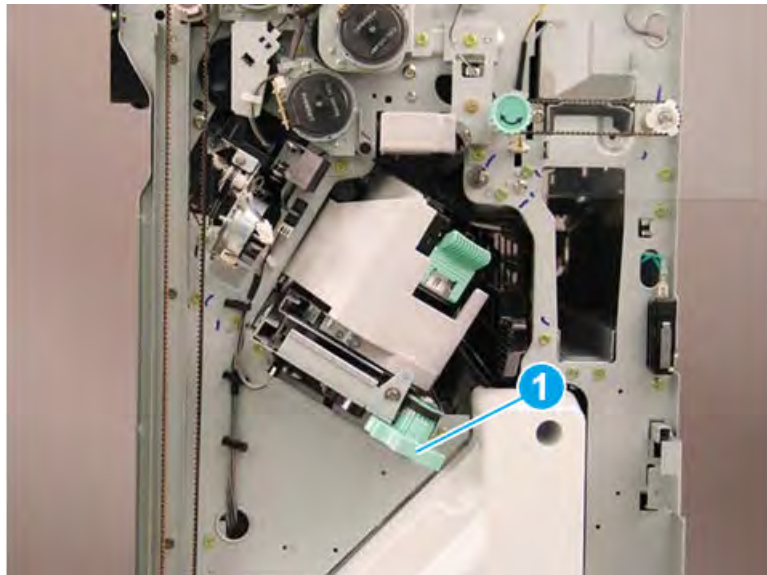


#### Remove the ejector unit (finisher)

Follow these steps to remove the ejector unit (finisher).

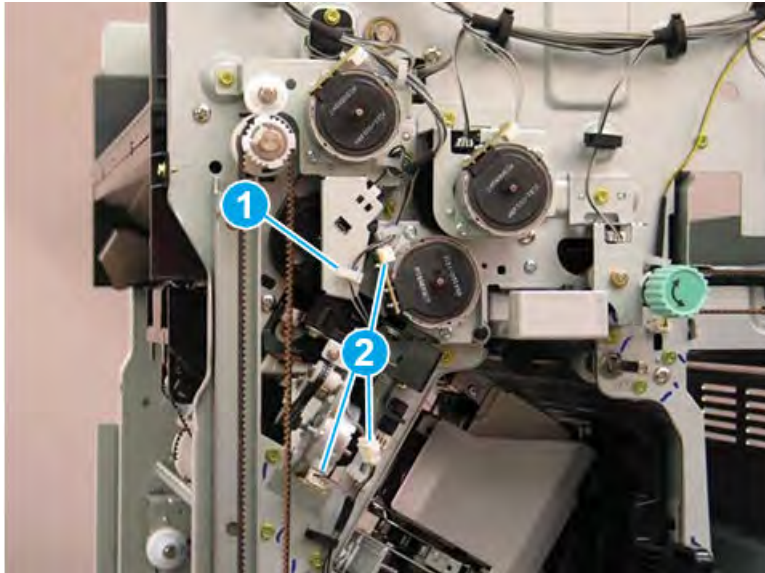
1. Rotate the green wheel to move the staple unit to the center of the finisher.

Figure 5-1102 Move the staple unit to the center



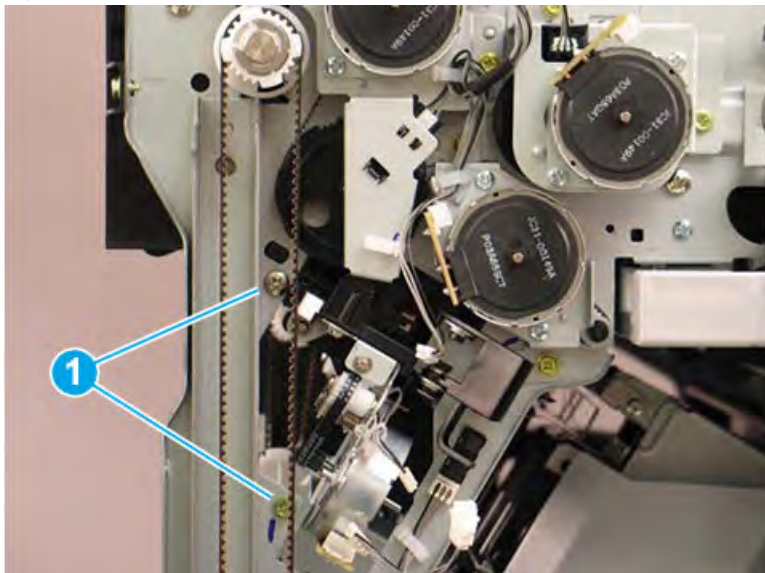
2. Release one retainer (callout 1), and then disconnect three connectors (callout 2).

Figure 5-1103 Disconnect three connectors



3. Remove two screws (callout 1).

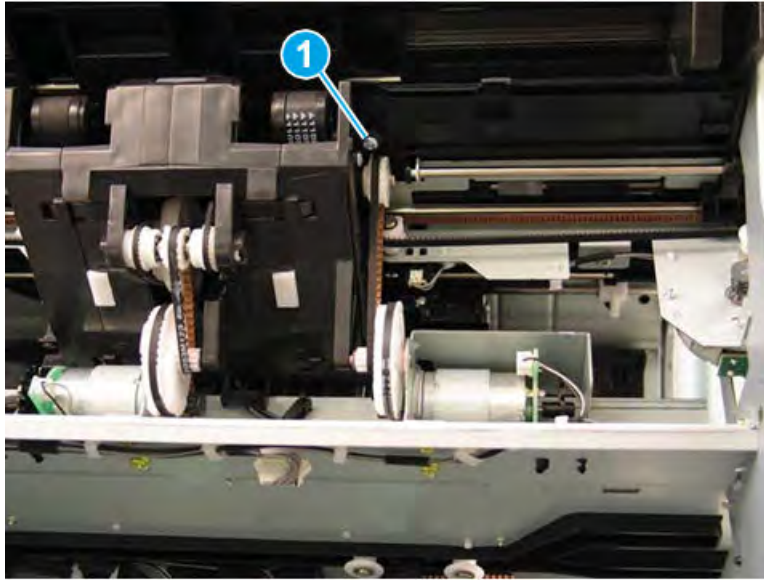
Figure 5-1104 Remove two screws





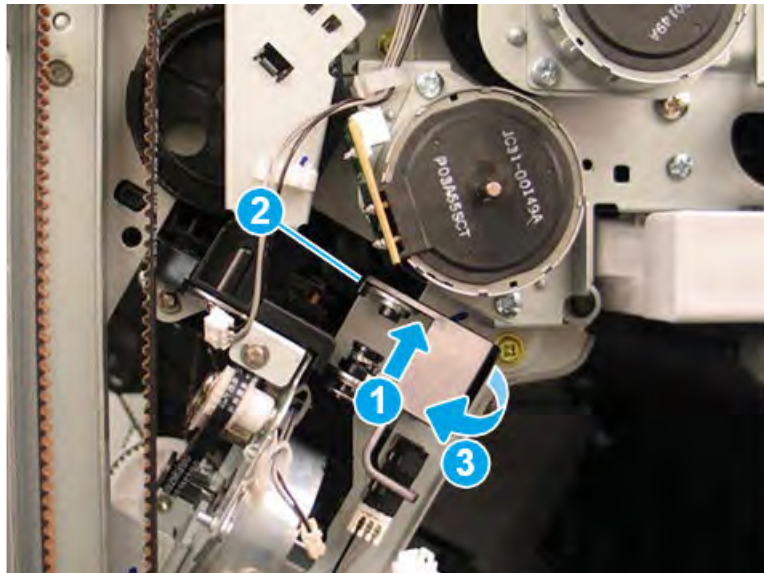
4. At the left side of the finisher, remove one screw (callout 1).

Figure 5-1105 Remove one screw



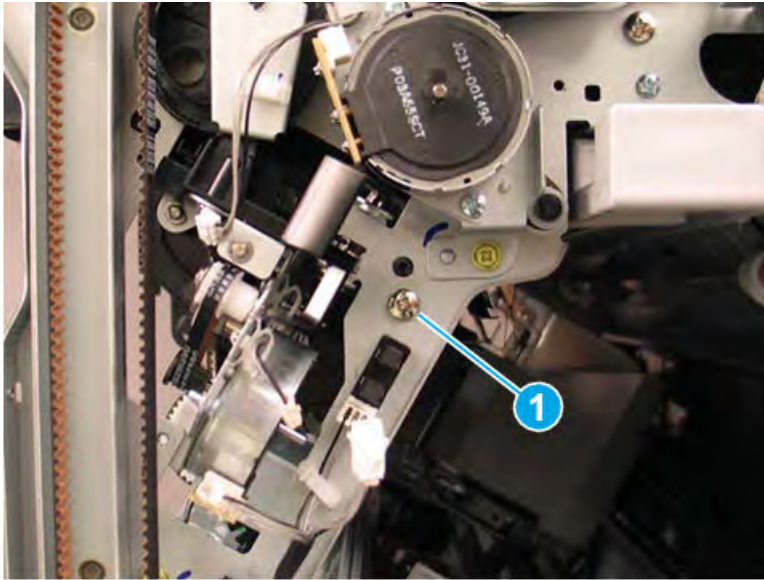
5. Press up on the hinge (callout 1), release one tab (callout 2), and then rotate the sensor away from the finisher (callout 3).

Figure 5-1106 Rotate the sensor



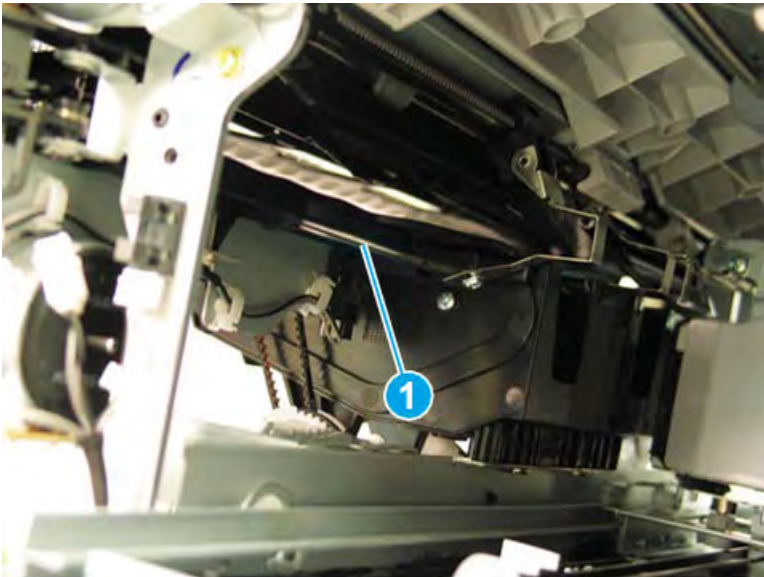
6. Remove one screw (callout 1).

Figure 5-1107 Remove one screw



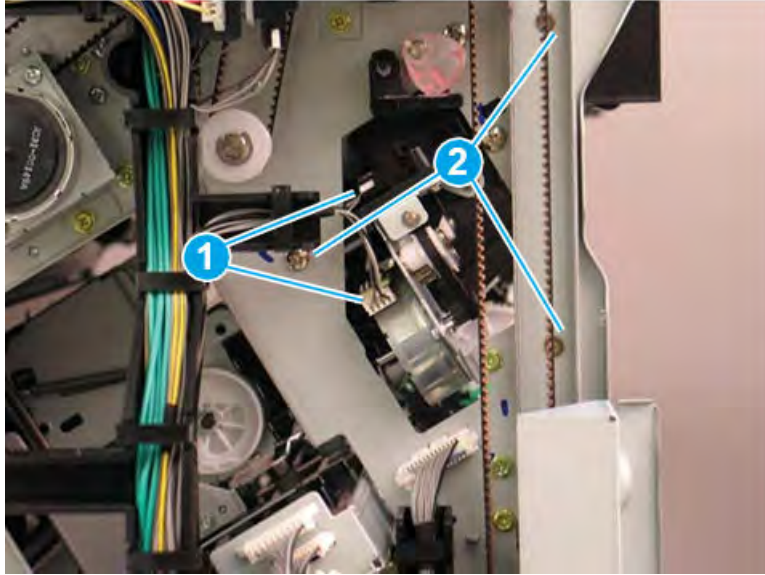
7. Look inside the finisher through the stapler opening in the front and pull down to release and remove one shaft (callout 1) on the front tamper unit.

Figure 5-1108 Remove the front tamper shaft



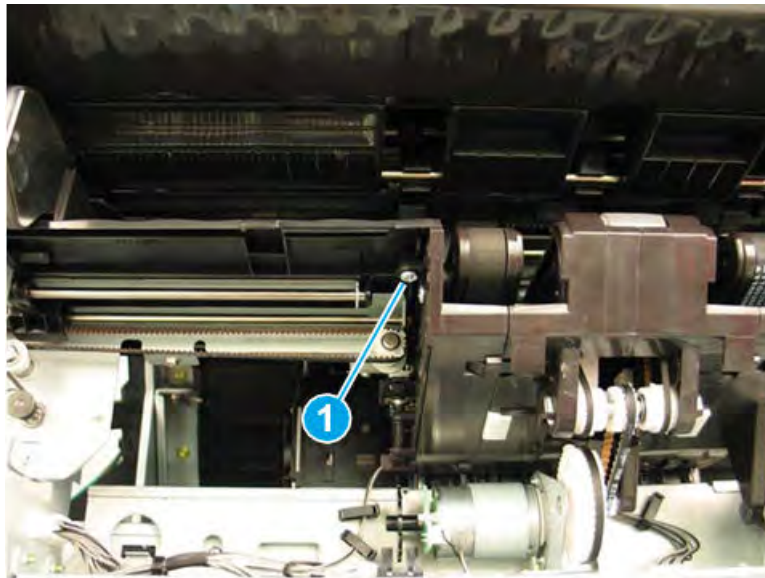
8. At the rear of the finisher, disconnect two connectors (callout 1), and then remove three screws (callout 2).

Figure 5-1109 Disconnect two connectors and remove three screws



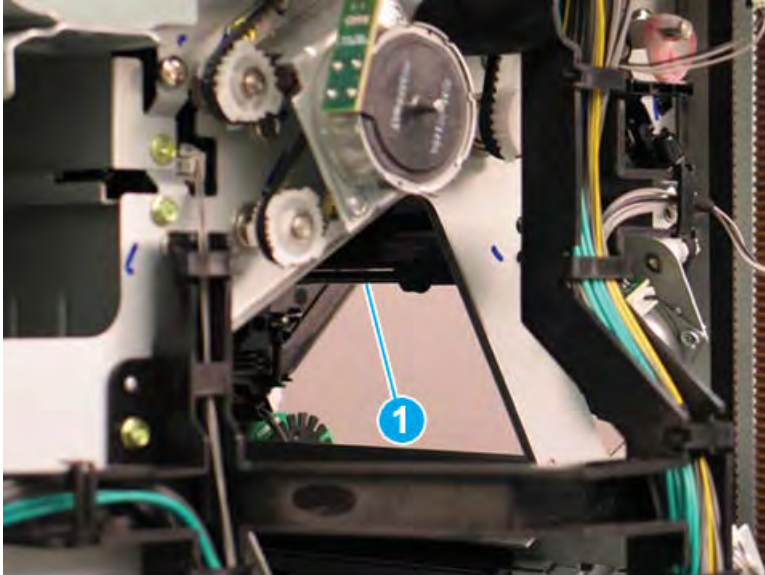
9. At the left side of the finisher, remove one screw (callout 1).

Figure 5-1110 Remove one screw



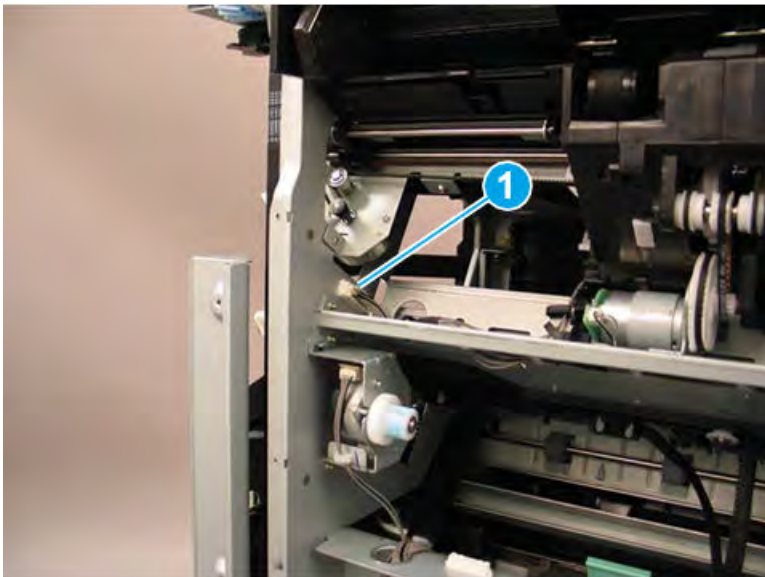
10. Look inside the finisher through the stapler opening in the rear and pull down to release and remove one shaft (callout 1) on the rear tamper unit.

Figure 5-1111 Remove the rear tamper shaft



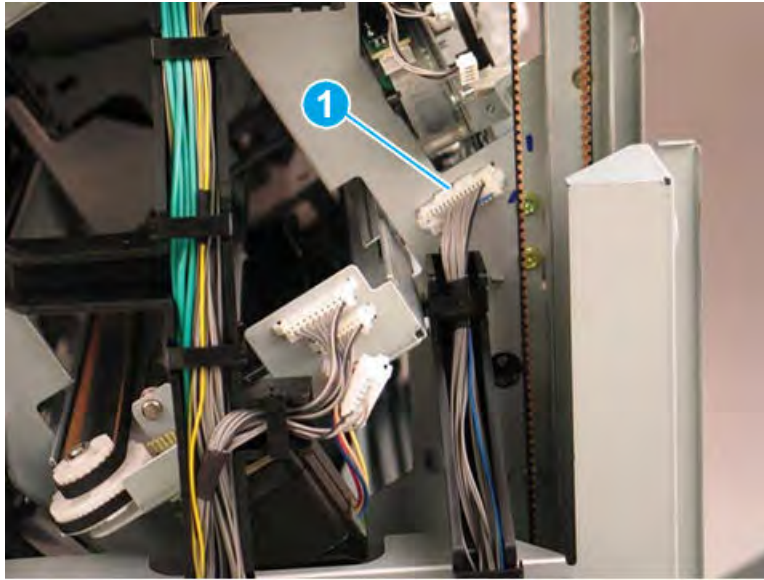
11. At the left side of the finisher, disconnect one connector (callout 1).

Figure 5-1112 Disconnect one connector



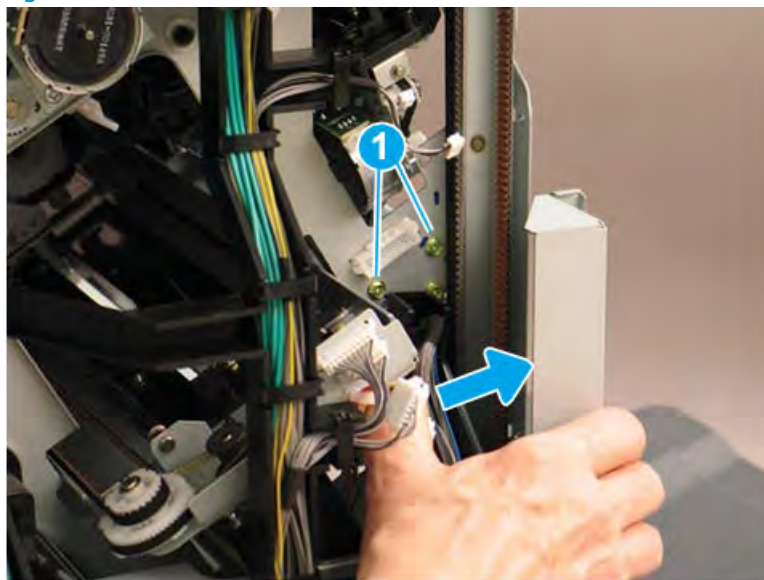
12. At the rear of the finisher, disconnect one connector (callout 1).

Figure 5-1113 Disconnect one connector



13. At the rear of the finisher, press the wire retainer to the right to access and remove two screws (callout 1).

Figure 5-1114 Disconnect one connector



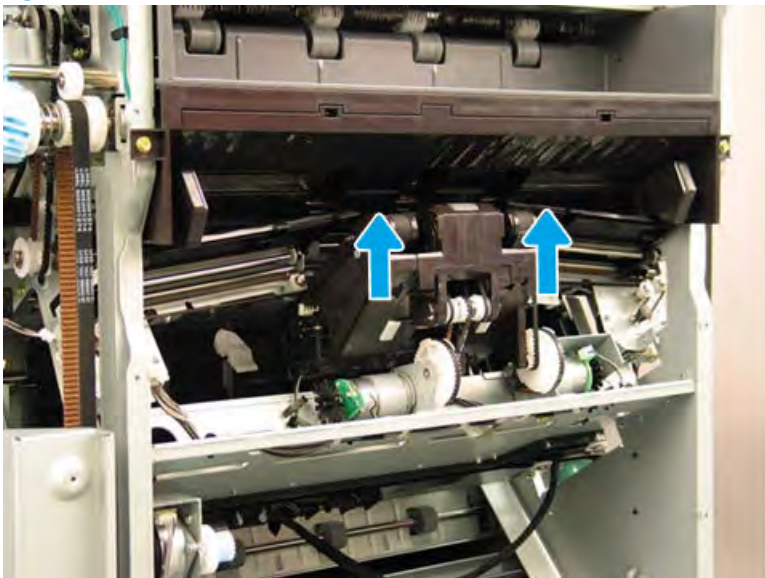
14. At the front of the finisher, remove two screws (callout 1).

Figure 5-1115 Remove two screws



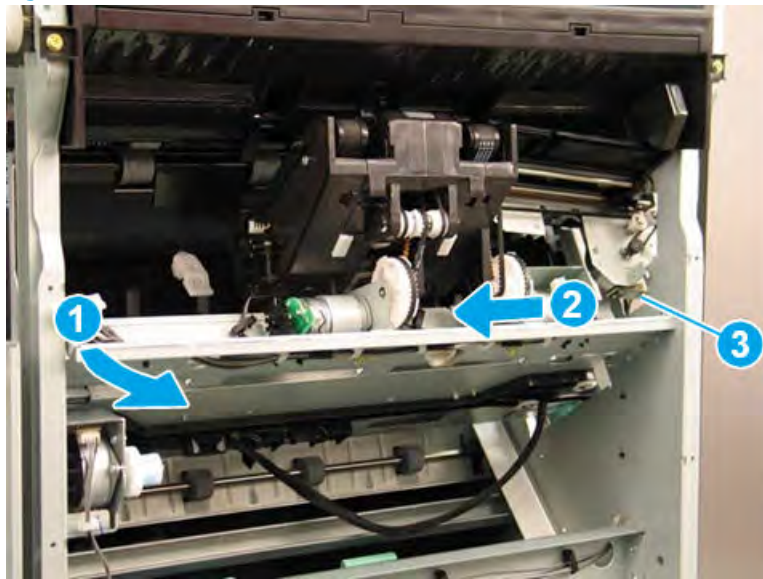
15. Lift the inside edges of the front and rear tampers up.

Figure 5-1116 Lift the edges of the tampers



16. Rotate the rear edge of the ejector unit away from the finisher (callout 1), and then slide it toward the rear of the finisher (callout 2) to remove it. Make sure that the PCA (callout 3) stays clear of the sheet metal frame.

Figure 5-1117 Remove the ejector unit

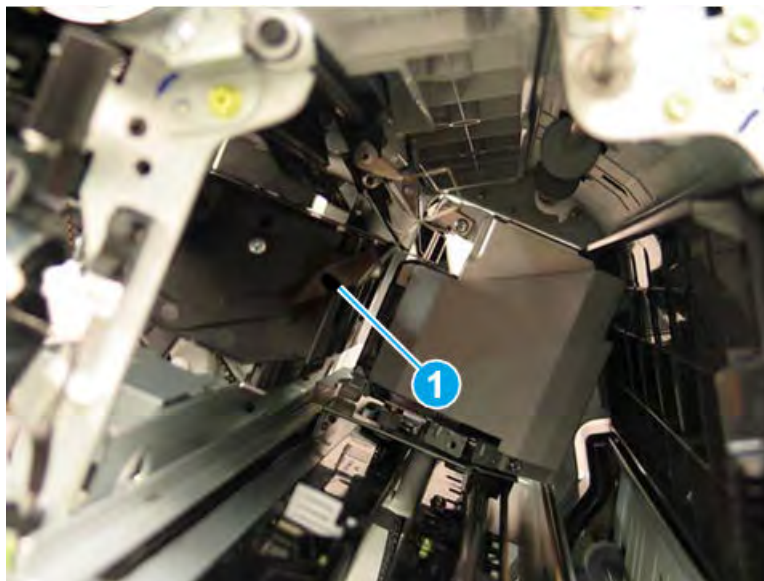


17. Reverse the removal steps to install the assembly. Also use the following special installation instructions.

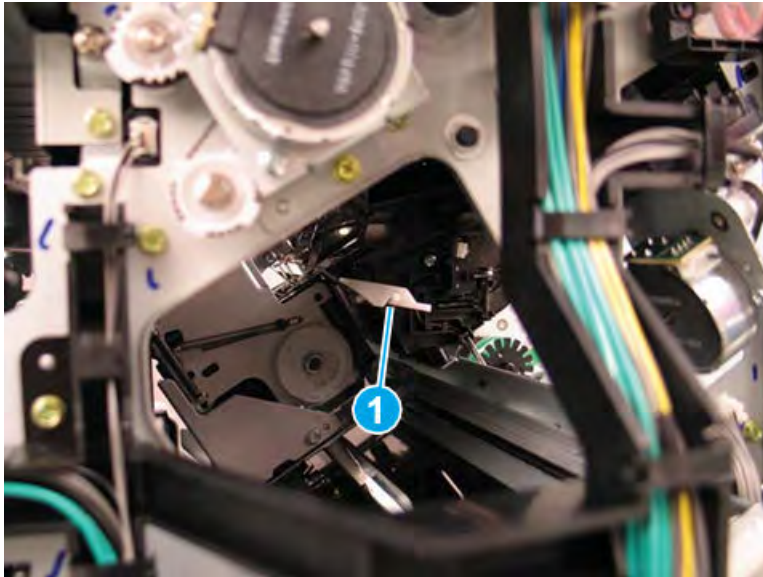
 **NOTE:** Continue to reverse the removal steps to finish installing the assembly.

#### Special installation instructions: Ejector unit

- a. When the front tamper shaft is removed, the retainer arm that held the one end of the shaft will drop down. When reinstalling the shaft, raise the retainer arm and position the end of the shaft in the notch (callout 1).



- b. When the rear tamper shaft is removed, the retainer arm that held the one end of the shaft will drop down. When reinstalling the shaft, raise the retainer arm and position the end of the shaft in the notch (callout 1).

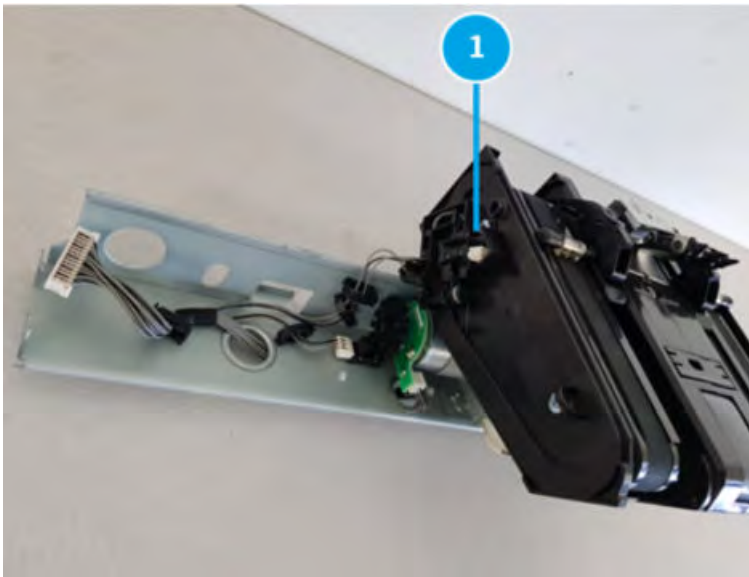


#### Remove the ejector2 home sensor(S32)

Follow these steps to remove the ejector2 home sensor(S32).

1. Remove sensor(callout 1, S32) using tweezers from the ejector unit.

Figure 5-1118 Remove sensor





2. Disconnect the connector(callout 1) from ejector2 home sensor.

**Figure 5-1119** Disconnect the connector from ejector2 home sensor



### Unpack the replacement assembly

Follow these steps to unpack the replacement assembly.

1. Dispose of the defective part.



---

 **NOTE:** HP recommends responsible disposal of the defective part.


<http://www8.hp.com/us/en/hp-information/environment/product-recycling.html>

---

2. Unpack the replacement part from the packaging.

 **CAUTION:**  Some parts are sensitive to electrostatic discharge (ESD). Always perform service work at an ESD-protected workstation or mat. If an ESD workstation or mat is not available, touch the sheet-metal chassis to provide a static ground before touching an ESD-sensitive assembly. Protect the ESD-sensitive assemblies by placing them in ESD pouches when they are out of the printer.


 **IMPORTANT:** Make sure that all of the shipping materials (for example shipping tape) are removed from the replacement part prior to installation.

 **NOTE:** If the replacement part is a roller or pad, avoid touching the spongy part of it. Skin oils on the roller or pad can cause paper pickup and/or print-quality problems. HP recommends using disposable gloves when handling rollers or pads or washing your hands before touching rollers or pads.

---

3. To install an assembly, reverse the removal steps.

---

 **NOTE:** When applicable, special installation instructions are provided for an assembly at the end of the removal procedure. Always completely read the removal instructions and follow all special installation instructions.


---

## Removal and replacement: Ejector2 motor sensor (S23)


Learn how to remove and replace the ejector2 motor sensor.

### Introduction

This document provides the procedures to remove and replace the ejector2 motor sensor on the finisher.

 **IMPORTANT:** When applicable, special installation instructions are provided for an assembly at the end of the removal procedure. Always completely read the removal instructions and follow all special installation instructions.

### Before performing service

- Turn the printer power off. A shutting-down message appears on the control-panel display.
-  **WARNING!** To avoid damage to the printer, turn the power off and wait until the printer shuts down before removing the power cable.
- Disconnect the printer power cable after the printer has completely shut down (the control-panel display is blank).
- Release the finisher from the printer by pulling out on the release latch inside the finisher door.
- Disconnect the cable from the bridge unit to the finisher.
- Disconnect the cable from the finisher to the printer.

Use the table below to identify the correct part number for your printer. To order the part, go to <https://parts.hp.com>.

Table 5-130 Part information

Part number	Part description
0604-001415	Ejector2 motor sensor

### Required tools

- #2 JIS screwdriver with a magnetic tip
- Small, flat-blade screwdriver

### After performing service

- Connect the cable from the finisher to the printer.
- Connect the cable from the bridge unit to the finisher.
- Attach the finisher to the printer, and then push in on the release latch inside the finisher door.
- Connect the printer power cable.
- Turn the printer power on.

### Post service test

Process a job through the finisher and verify that the finisher works correctly.

### Remove the right upper cover (finisher)

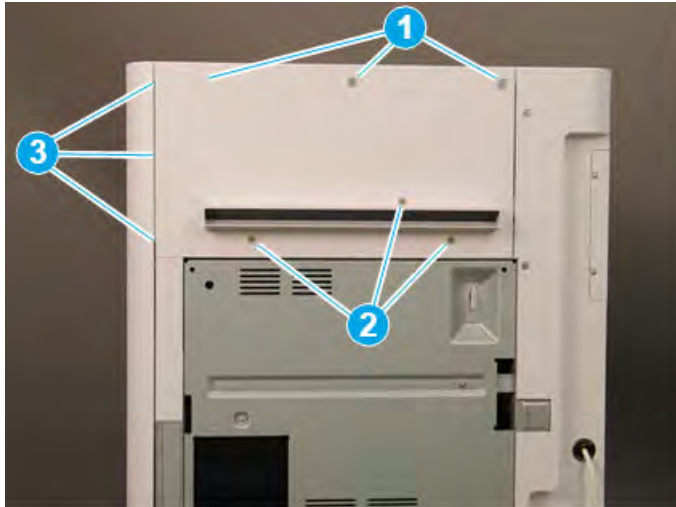
Follow these steps to remove the right upper cover (finisher).

- ▲ Remove one screw cap and three machine screws on the upper edge of the cover (callout 1). Remove three sheet metal screws (callout 2) on the lower portion of the cover. Rotate the right edge of the cover away from the finisher, and then slide the cover right to release three tabs (callout 3).

💡 **TIP:** The lower screws are shorter in length than the upper screws.

**TIP:** Reverse the removal steps to install the assembly.

Figure 5-1120 Remove the right upper cover

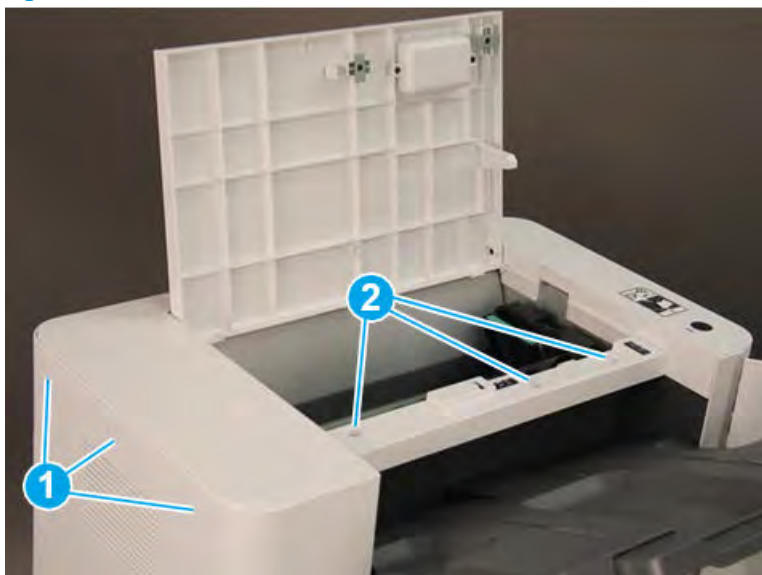


### Remove the top cover (finisher)

Follow these steps to remove the top cover (finisher).

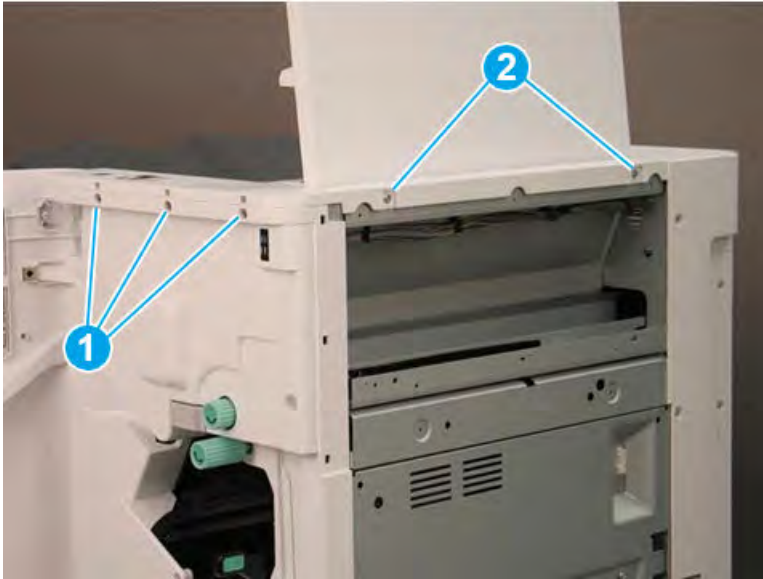
1. Remove three screw caps and three self-tapping screws at the top of the rear cover (callout 1), and then remove three machine screws (callout 2) on top of the cover.

Figure 5-1121 Remove six screws




2. Remove three self-tapping screws at the top of the front cover (callout 1), and then remove two machine screws (callout 2) at the top of the right side.

Figure 5-1122 Remove five screws



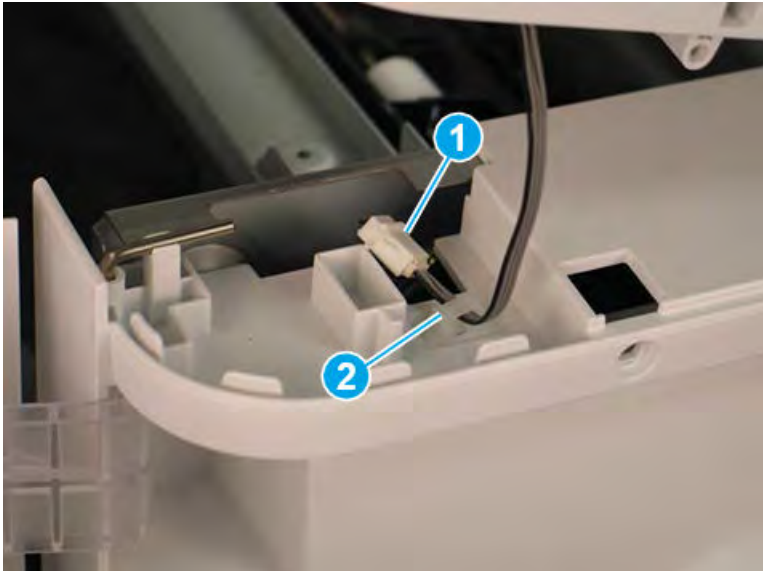
3. Lift the cover up slightly. Disconnect one in-line connector (callout 1), and then release one retainer (callout 2).

---

 **TIP:** Reverse the removal steps to install the assembly.

---

Figure 5-1123 Disconnect one connector and release retainer

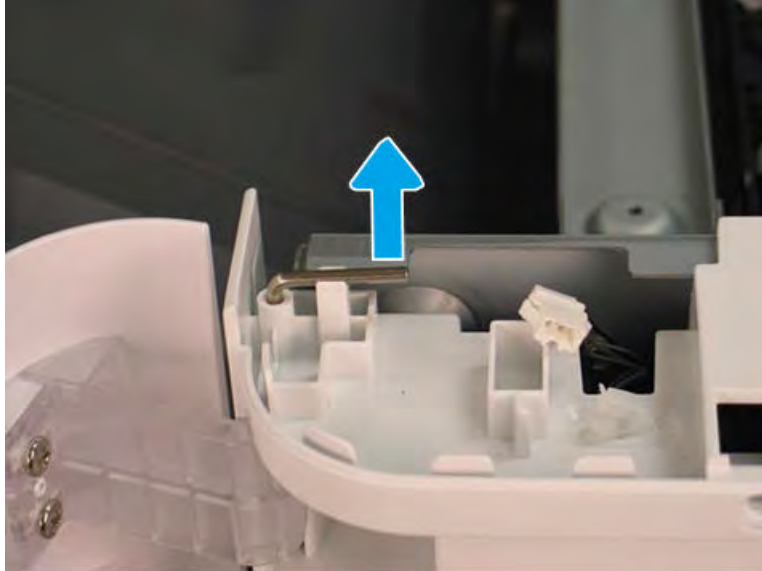


### Remove the front door (finisher)

Follow these steps to remove the front door (finisher).

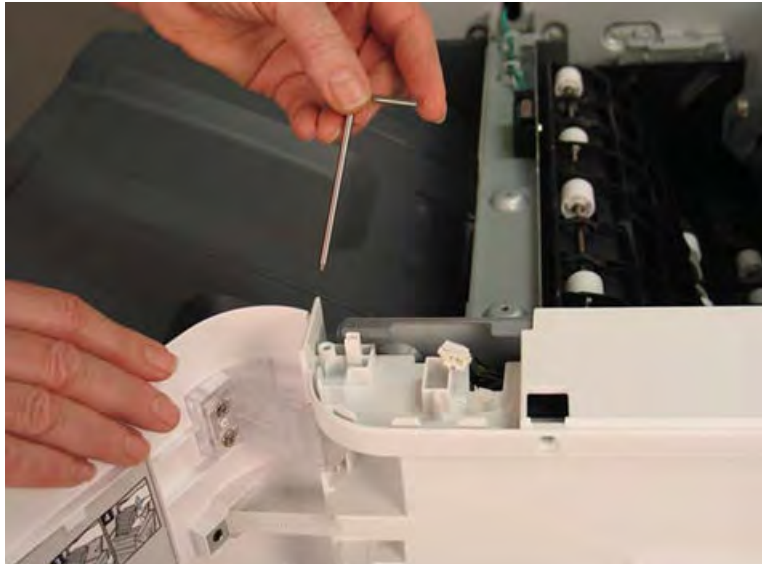
1. Lift the top hinge pin up to release it from the retainer.

Figure 5-1124 Lift the top hinge pin



2. Pull the top hinge pin up to remove it.

Figure 5-1125 Remove the top hinge pin



3. Use a small, flat-blade screwdriver to release the lower hinge pin from the retainer, and then rotate it away from the finisher.

**Figure 5-1126** Release the lower hinge pin




4. Support the door with one hand, and then pull the lower hinge pin straight up to remove it.

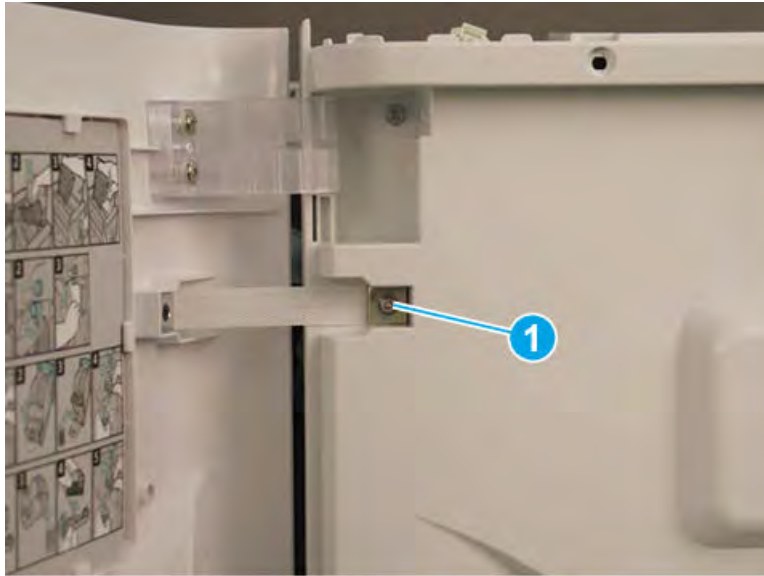
**Figure 5-1127** Remove the lower hinge pin



5. Support the door with one hand, and then remove one screw (callout 1) to release the strap. Remove the front door.

 **TIP:** Reverse the removal steps to install the assembly.

**Figure 5-1128** Remove the front door

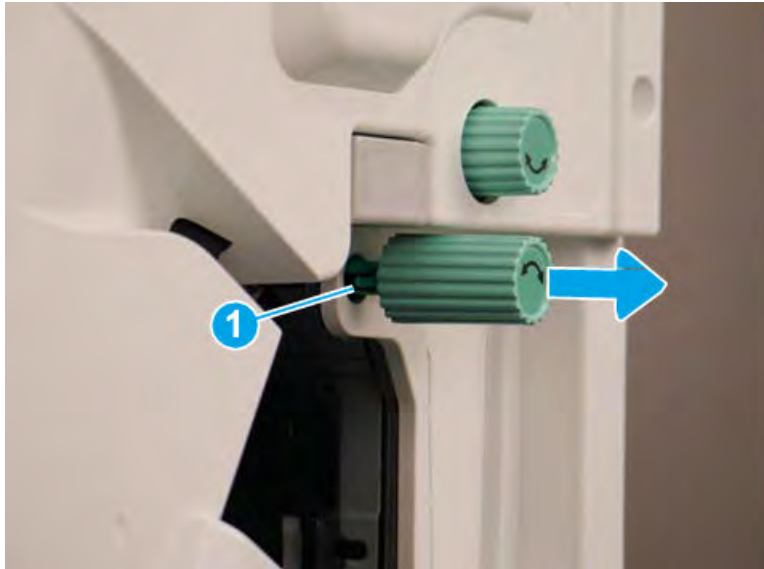


#### Remove the front cover (finisher)

Follow these steps to remove the front cover (finisher).

1. Release one tab (callout 1), and then pull the jam-access knob away from the finisher to remove it.

**Figure 5-1129** Remove the jam-access knob



2. If the punch unit is installed, remove the punch waste bin (callout 1).


3. Remove one screw (callout 1) on top of the front cover.

Figure 5-1130 Remove one screw



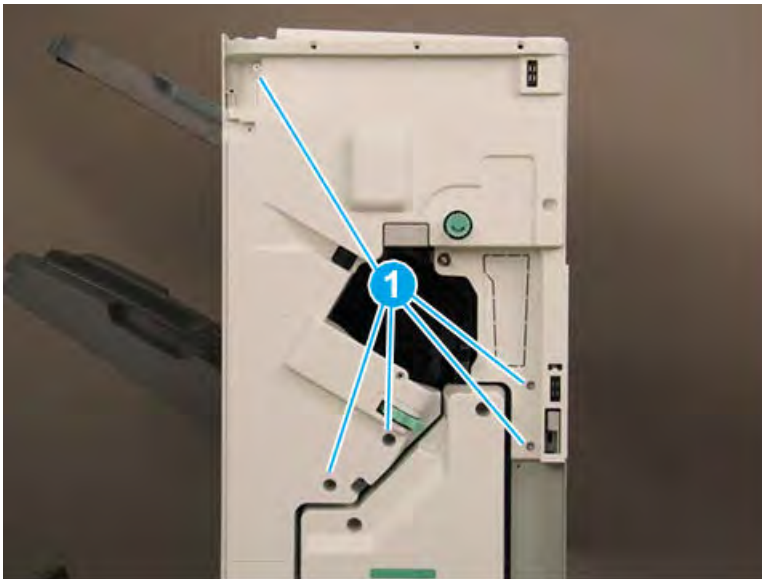
4. Remove five machine screws (callout 1), and then remove the front cover.

---

 **TIP:** Reverse the removal steps to install the assembly.

---

Figure 5-1131 Remove the front cover



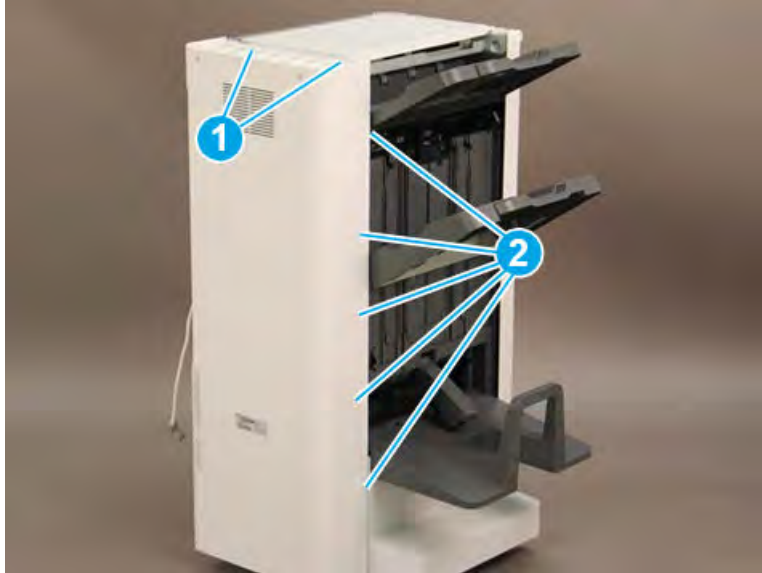
### Remove the rear cover (finisher)

Follow these steps to remove the rear cover (finisher).

1. Remove two self-tapping screws (callout 1) on the top of the rear cover, and then remove five screw caps and five machine screws (callout 2) on the left side of the cover.



Figure 5-1132 Remove seven screws



2. Remove one screw cap and four machine screws (callout 1) Remove the rear cover.

 **NOTE:** Make sure to thread the power cable (callout 2) through the opening in the cover.


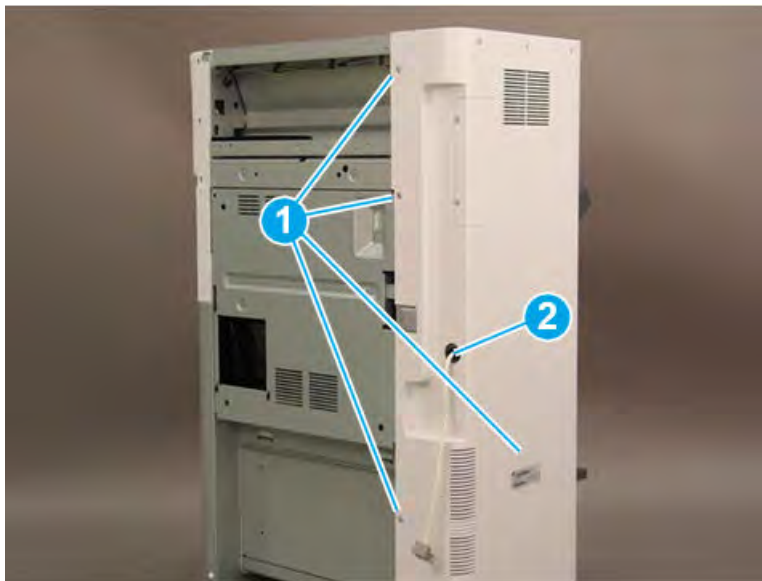
 **TIP:** Reverse the removal steps to install the assembly

Figure 5-1133 Remove the rear cover



### Remove the booklet output tray

Follow these steps to remove the booklet output tray.

1. Raise the booklet output tray up (callout 1), and then pull it away from the finisher (callout 2) to remove it.

Figure 5-1134 Remove the booklet output tray



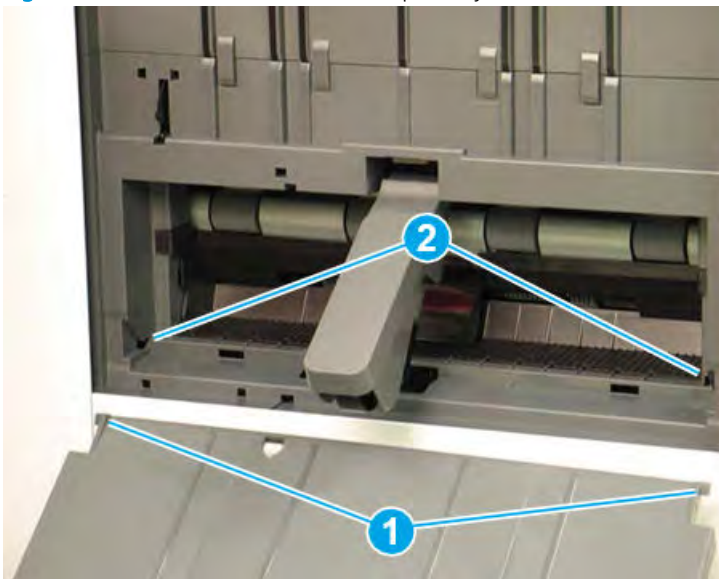
2. Reverse the removal steps to install the assembly. Also use the following special installation instructions.

 **NOTE:** Continue to reverse the removal steps to finish installing the assembly

Special installation instructions: booklet output tray

Position the tabs (callout 1) on the tray into the slots (callout 2) on the finisher.

Figure 5-1135 Install the booklet output tray

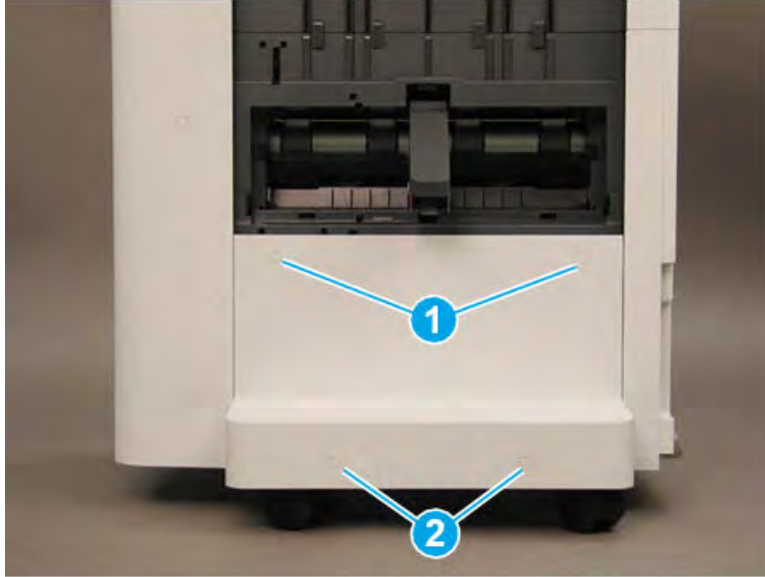


### Remove the caster cover

Follow these steps to remove the caster cover.

1. Remove two screw caps and two self-tapping screws (callout 1). Remove two screw caps and two machine screws (callout 2).

Figure 5-1136 Remove four screws



2. Rotate the left edge of the cover away from the finisher (callout 1), and then slide the cover to the left (callout 2) to remove it.

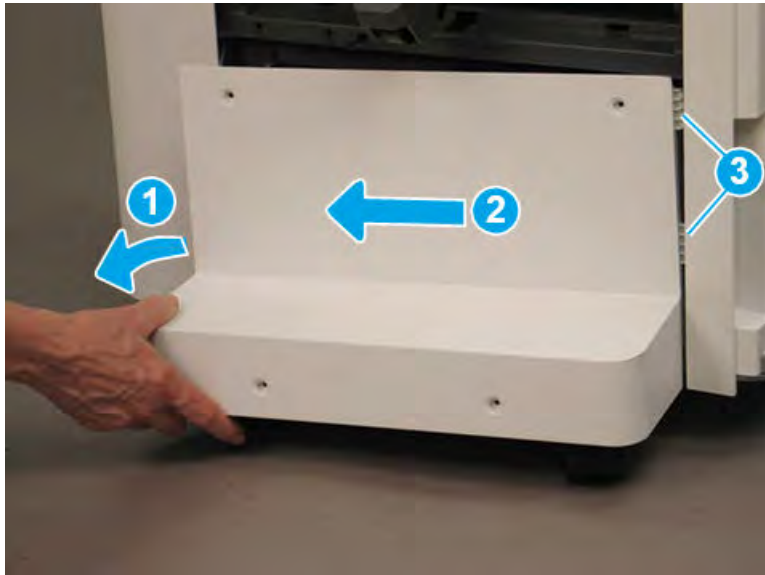
---

 **TIP:** Make sure that two tabs (callout 3) are positioned under the front lower cover when reinstalling the caster cover.

**TIP:** Reverse the removal steps to install the assembly

---

Figure 5-1137 Remove the caster cover




### Remove the left lower cover (finisher)

Follow these steps to remove the left lower cover (finisher).

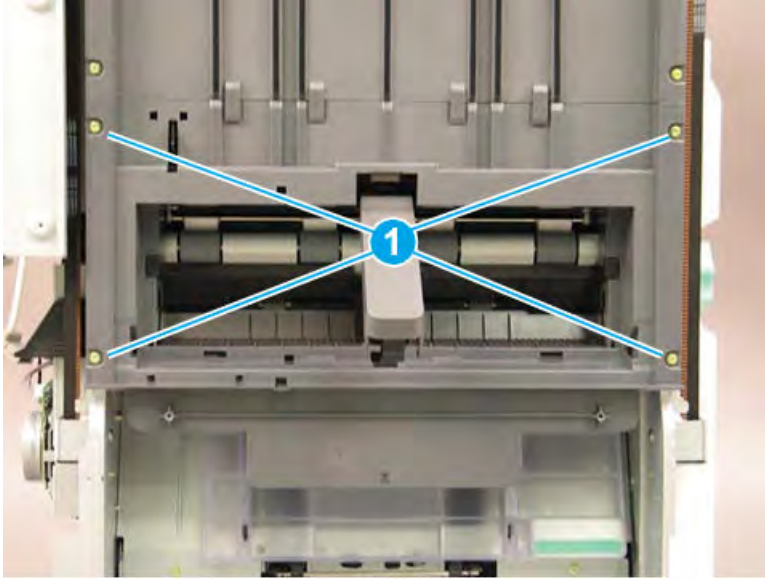
1. Remove four screws (callout 1).

---

 **NOTE:** Raise the lower output tray as needed to access the screws.

---

Figure 5-1138 Remove four screws



2. Slide the shield down (callout 1) to release it from four tabs (callout 2), and then rotate it away from the finisher (callout 3).

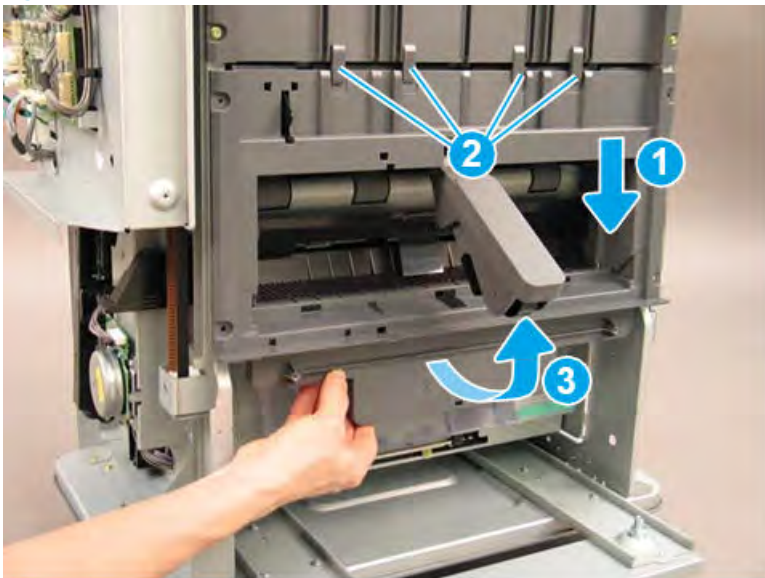
---

**⚠ CAUTION:** The shield is still attached to the finisher. Do not attempt to completely remove the shield.


**💡 TIP:** Position the shield under the four tabs (callout 2) when reinstalling it.

---

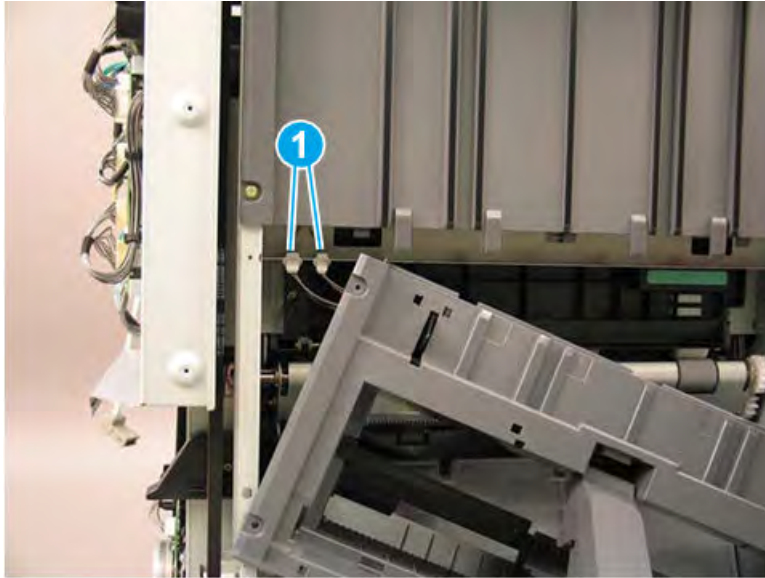
Figure 5-1139 Release the lower shield



3. Disconnect two connectors (callout 1), and then remove the shield.

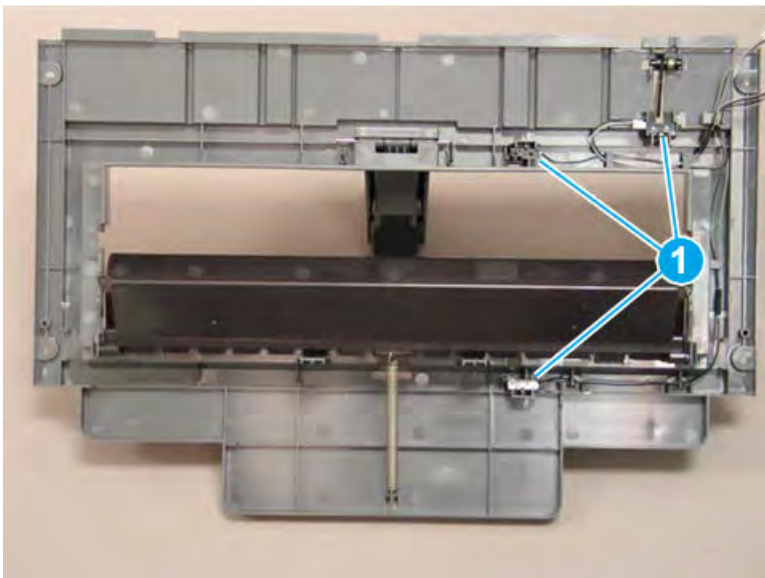
 **TIP:** Reverse the removal steps to install the assembly.

**Figure 5-1140** Disconnect two connectors



4. If you are replacing the left lower cover, locate three sensors (callout 1) on the back of the left lower cover. Remove these sensors and transfer them to the replacement part.

**Figure 5-1141** Remove the left lower cover

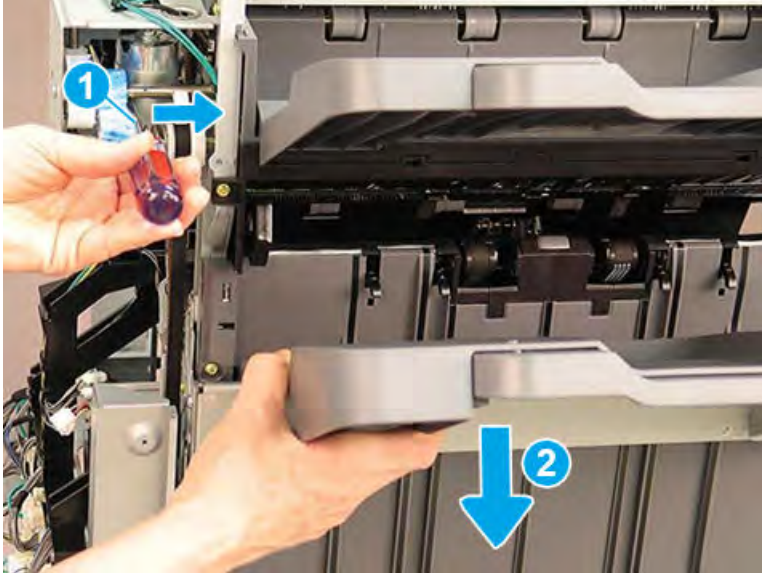


### Remove the left upper cover (finisher)

Follow these steps to remove the left upper cover (finisher).

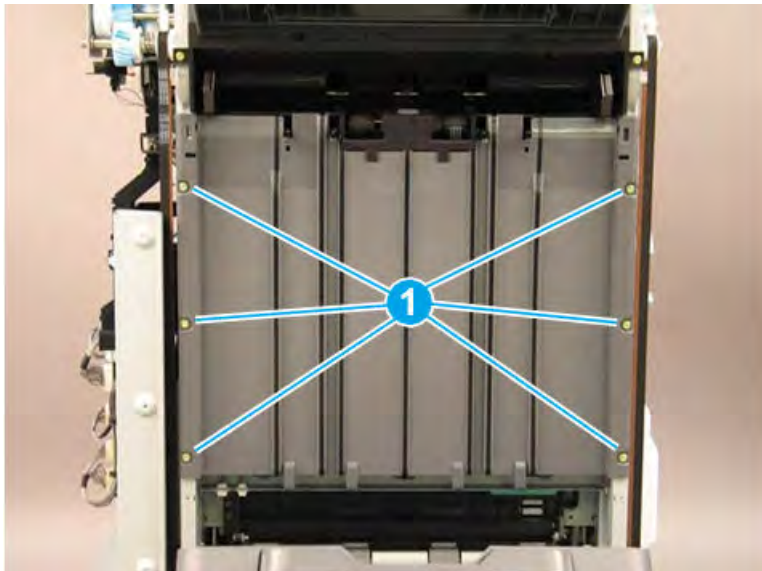
1. Bring the lower output tray down by positioning the shaft of a screwdriver on the clutch (callout 1) and gently pressing to the right to release the clutch. Hold the clutch in the released position and lower the tray (callout 2) to the lowest position.

Figure 5-1142 Lower the output tray



2. Remove six machine screws (callout 1).

Figure 5-1143 Remove six screws

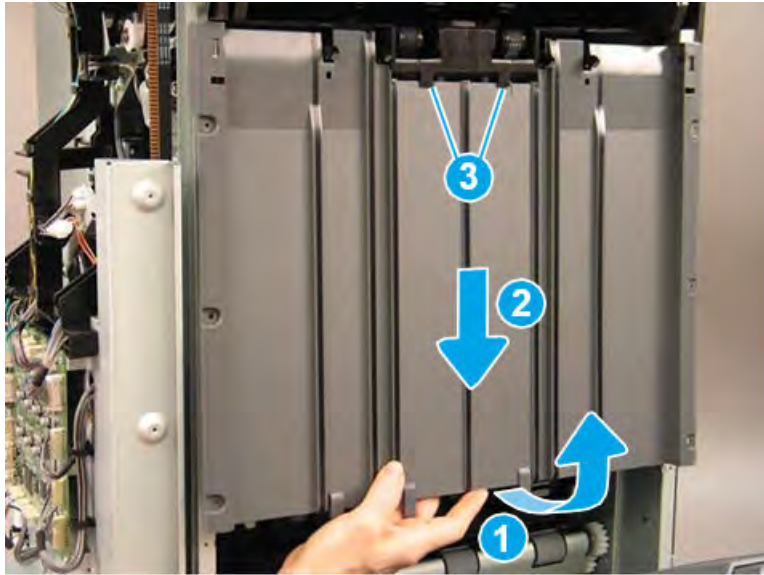


3. Rotate the lower edge of the shield away from the finisher (callout 1), and then slide the shield down (callout 2) to release it from two tabs (callout 3).

**CAUTION:** The shield is still attached to the finisher. Do not attempt to completely remove the shield.

**TIP:** Position the shield under the two tabs (callout 3) when reinstalling it.

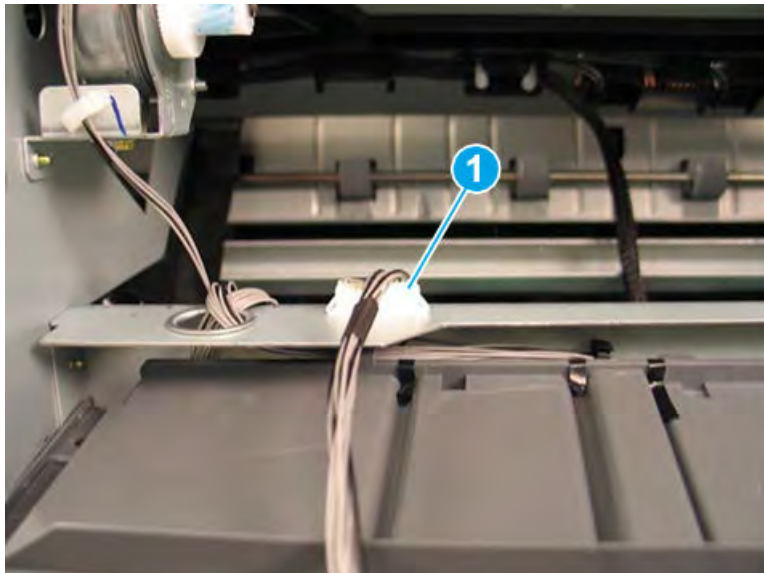
Figure 5-1144 Release the shield



4. Disconnect one connector (callout 1), and then remove the upper shield assembly.

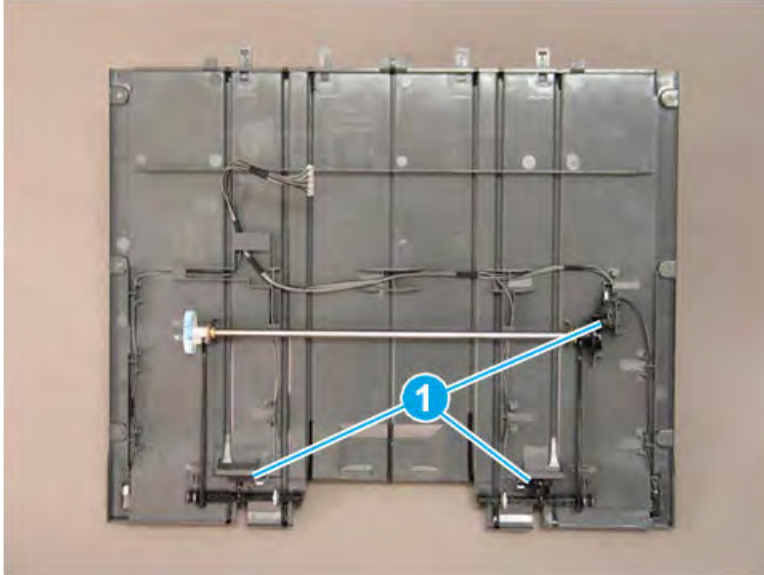
**TIP:** Reverse the removal steps to install the assembly.

Figure 5-1145 Disconnect one connector



5. If you are replacing the left upper cover, locate three sensors (callout 1) on the back of the left upper cover. Remove these sensors and transfer them to the replacement part.

Figure 5-1146 Remove the left upper cover

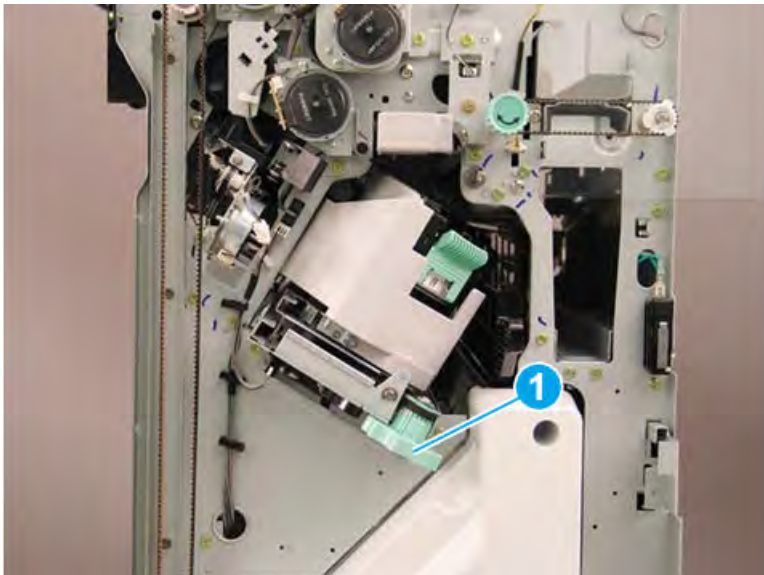


#### Remove the ejector unit (finisher)

Follow these steps to remove the ejector unit (finisher).

1. Rotate the green wheel to move the staple unit to the center of the finisher.

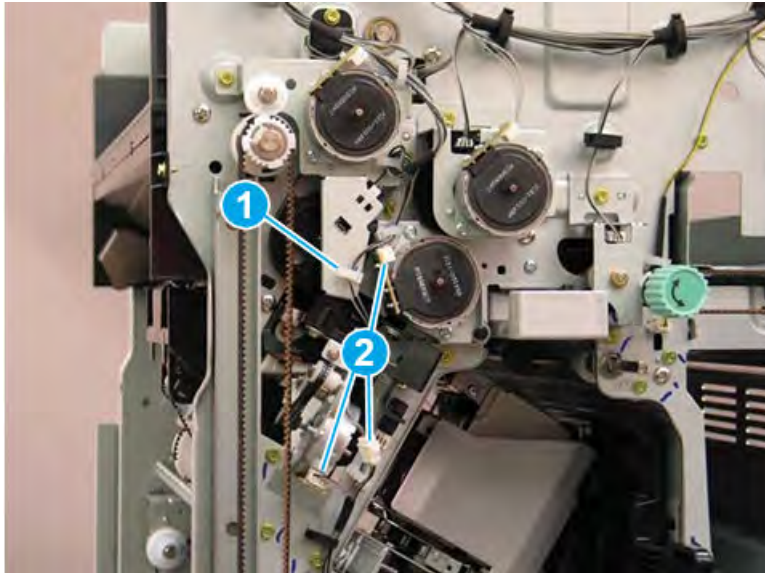
Figure 5-1147 Move the staple unit to the center





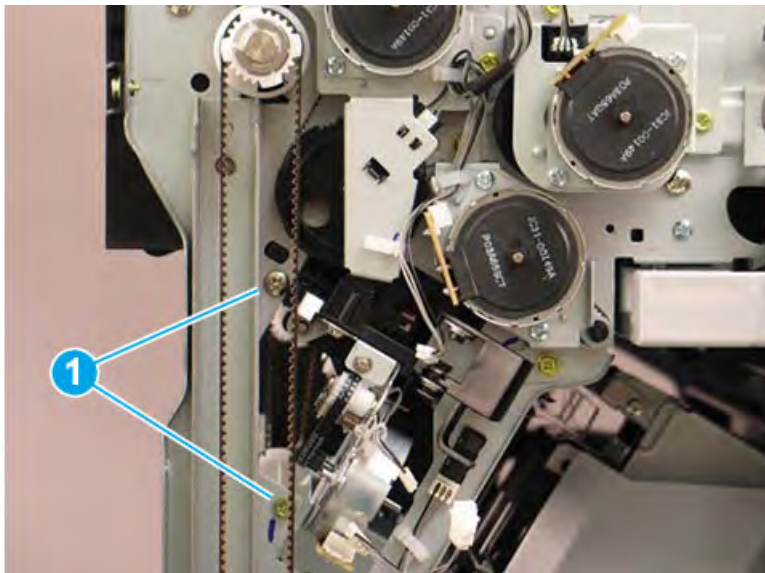
2. Release one retainer (callout 1), and then disconnect three connectors (callout 2).

Figure 5-1148 Disconnect three connectors



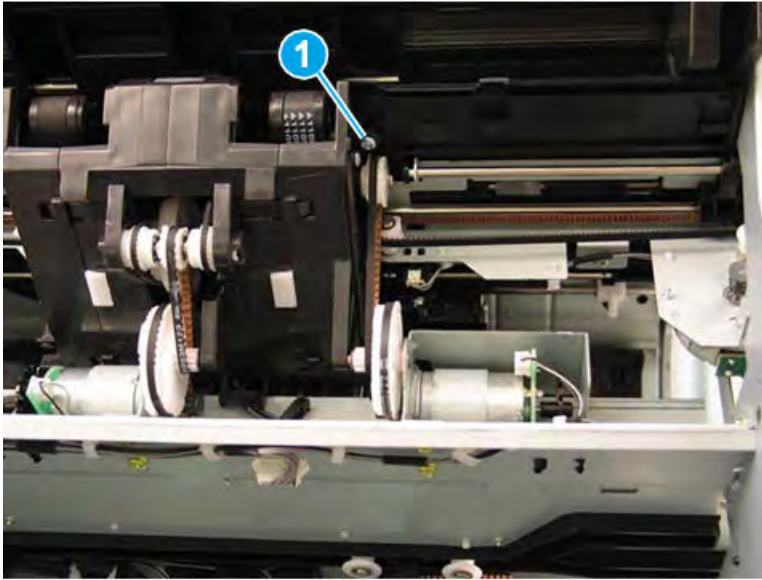
3. Remove two screws (callout 1).

Figure 5-1149 Remove two screws



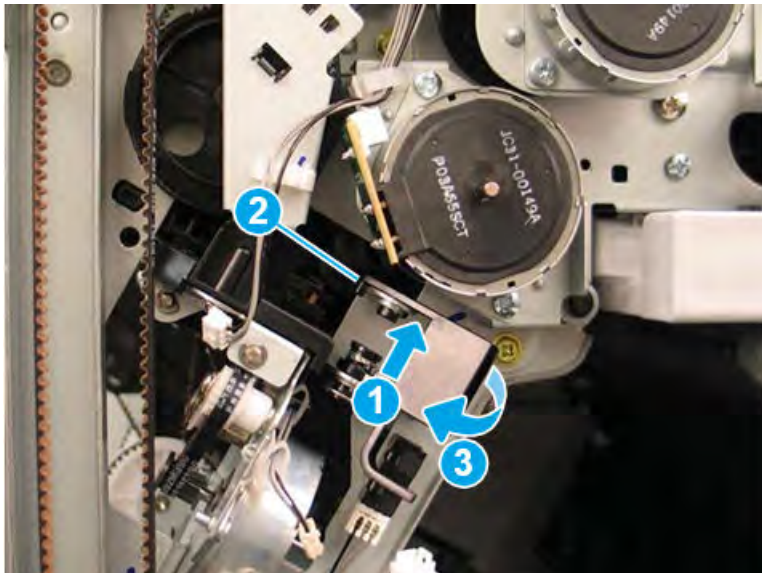
4. At the left side of the finisher, remove one screw (callout 1).

Figure 5-1150 Remove one screw



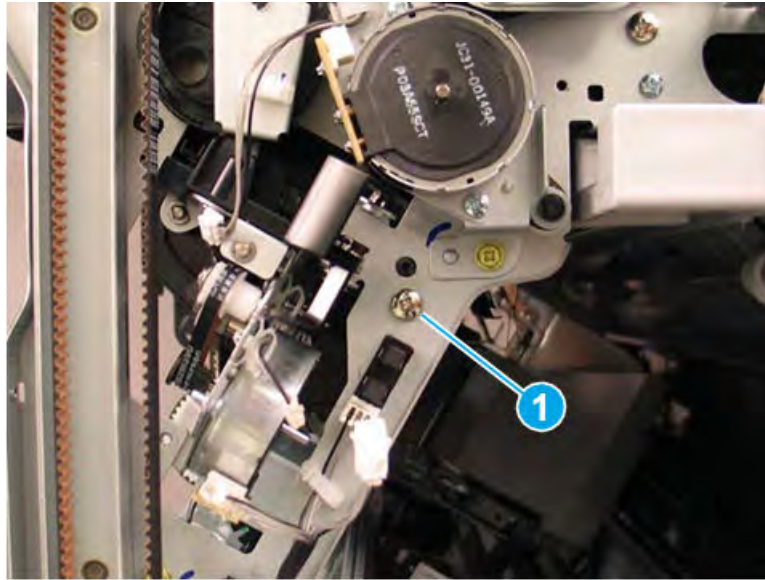
5. Press up on the hinge (callout 1), release one tab (callout 2), and then rotate the sensor away from the finisher (callout 3).

Figure 5-1151 Rotate the sensor



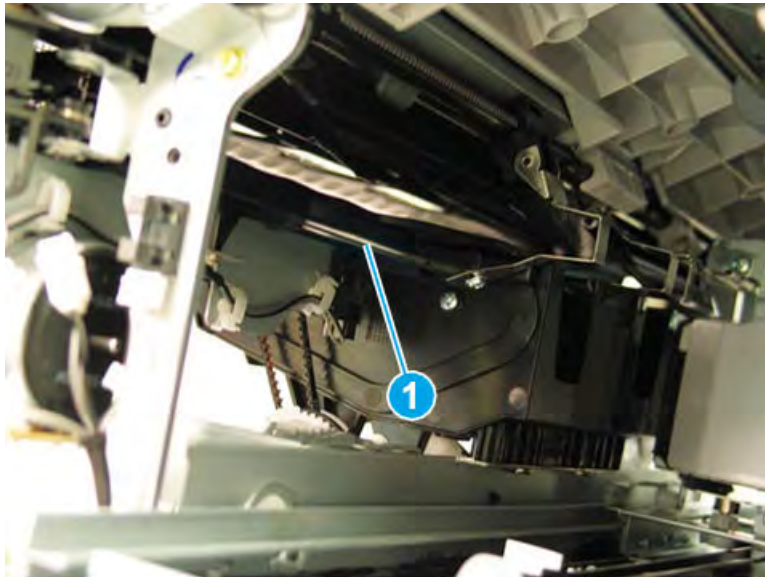
6. Remove one screw (callout 1).

Figure 5-1152 Remove one screw



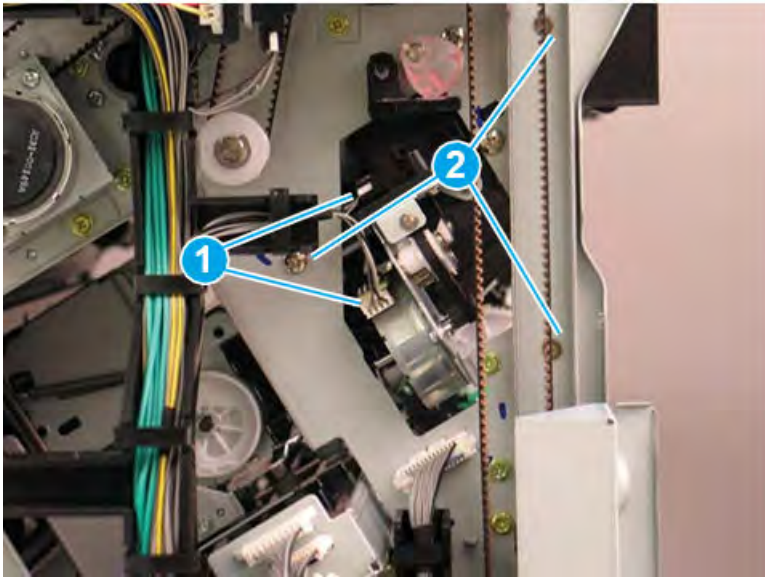
7. Look inside the finisher through the stapler opening in the front and pull down to release and remove one shaft (callout 1) on the front tamper unit.

Figure 5-1153 Remove the front tamper shaft



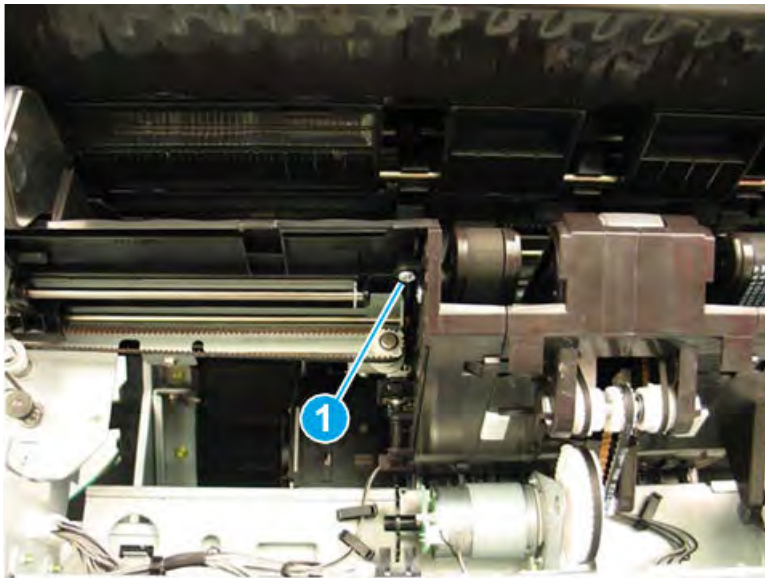
8. At the rear of the finisher, disconnect two connectors (callout 1), and then remove three screws (callout 2).

Figure 5-1154 Disconnect two connectors and remove three screws



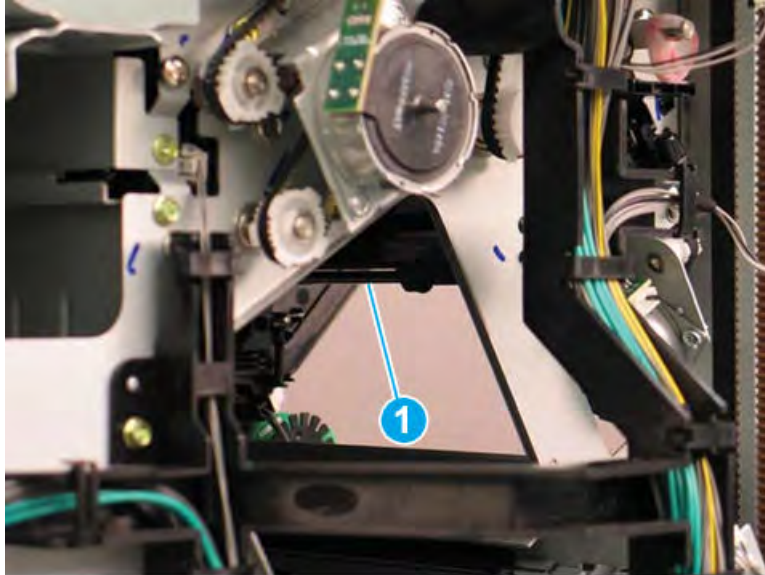
9. At the left side of the finisher, remove one screw (callout 1).

Figure 5-1155 Remove one screw



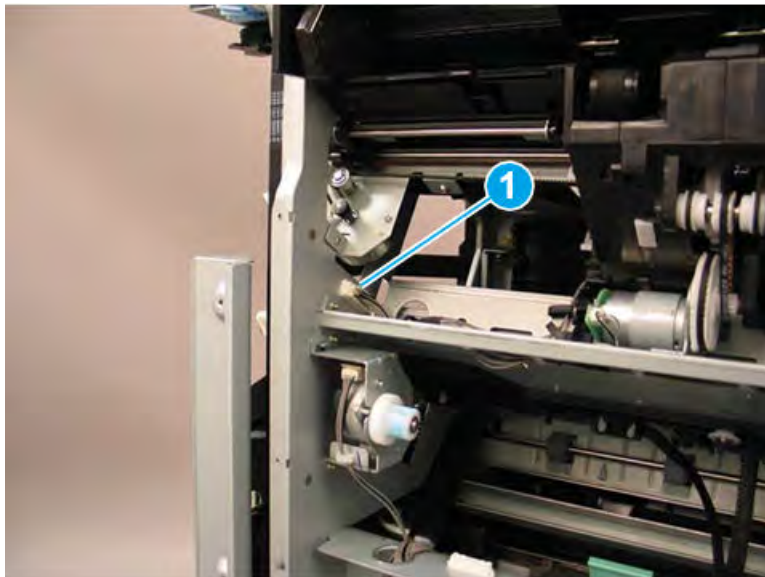
10. Look inside the finisher through the stapler opening in the rear and pull down to release and remove one shaft (callout 1) on the rear tamper unit.

Figure 5-1156 Remove the rear tamper shaft



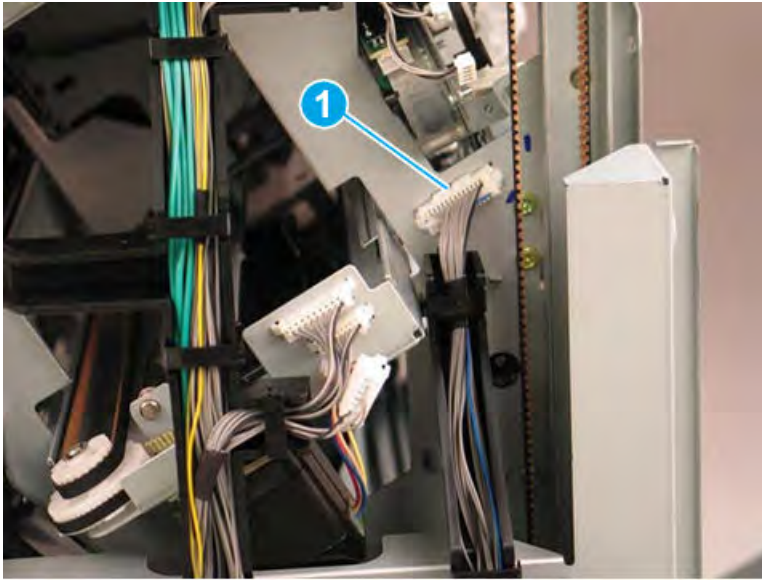
11. At the left side of the finisher, disconnect one connector (callout 1).

Figure 5-1157 Disconnect one connector



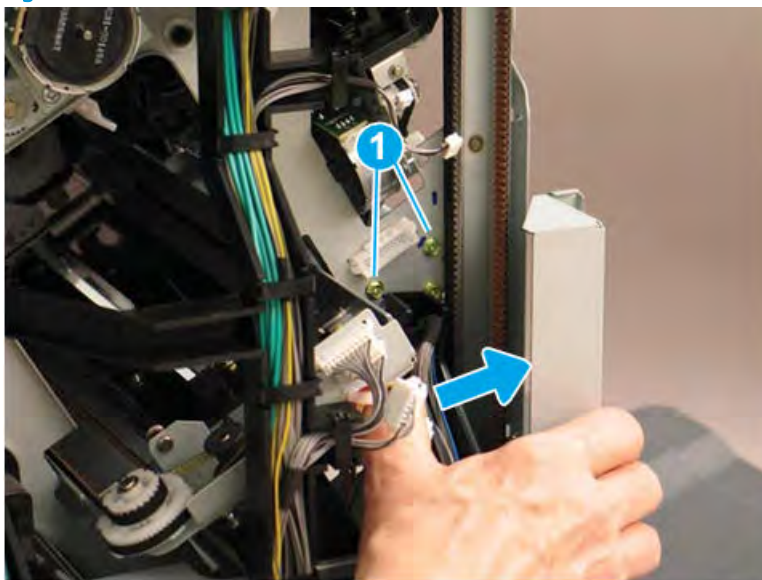
12. At the rear of the finisher, disconnect one connector (callout 1).

Figure 5-1158 Disconnect one connector



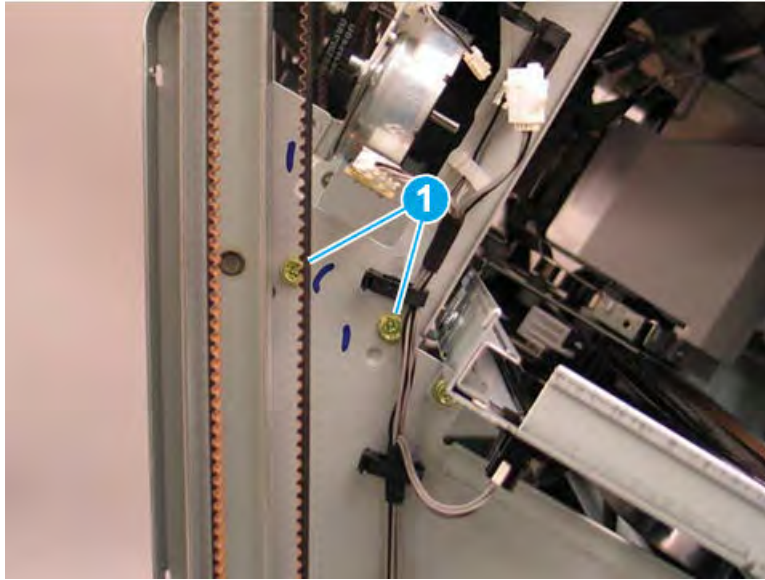
13. At the rear of the finisher, press the wire retainer to the right to access and remove two screws (callout 1).

Figure 5-1159 Disconnect one connector



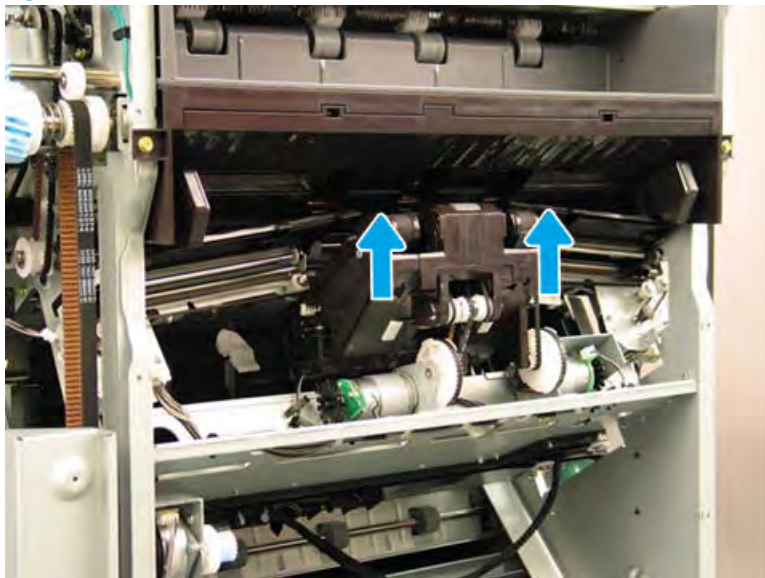
14. At the front of the finisher, remove two screws (callout 1).

Figure 5-1160 Remove two screws



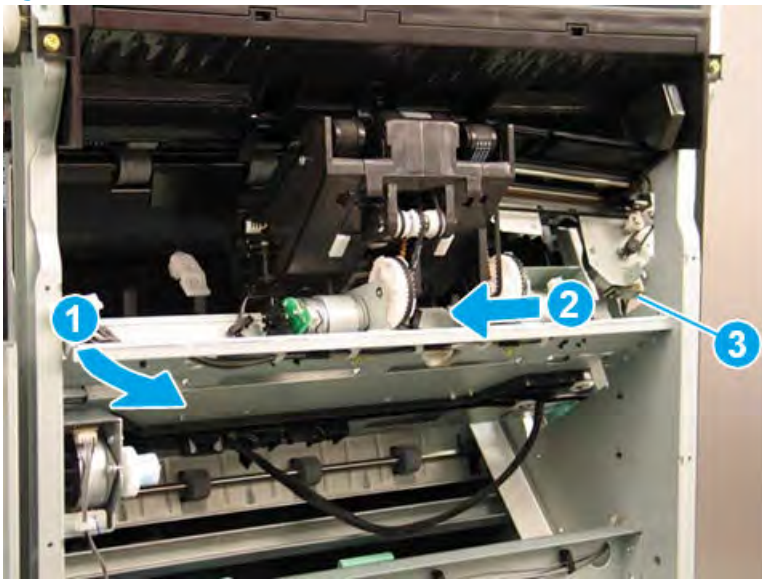
15. Lift the inside edges of the front and rear tampers up.

Figure 5-1161 Lift the edges of the tampers



16. Rotate the rear edge of the ejector unit away from the finisher (callout 1), and then slide it toward the rear of the finisher (callout 2) to remove it. Make sure that the PCA (callout 3) stays clear of the sheet metal frame.

Figure 5-1162 Remove the ejector unit



17. Reverse the removal steps to install the assembly. Also use the following special installation instructions.

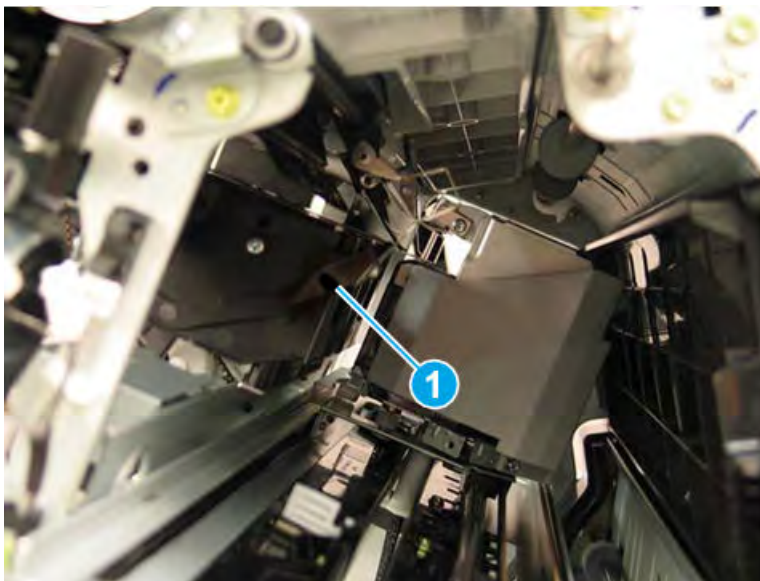
---

 **NOTE:** Continue to reverse the removal steps to finish installing the assembly.

---

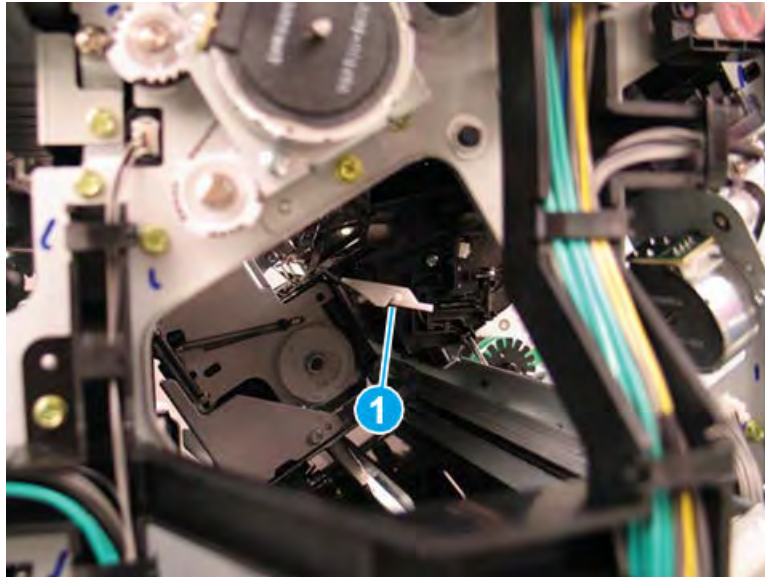
**Special installation instructions: Ejector unit**

- a. When the front tamper shaft is removed, the retainer arm that held the one end of the shaft will drop down. When reinstalling the shaft, raise the retainer arm and position the end of the shaft in the notch (callout 1).





- b. When the rear tamper shaft is removed, the retainer arm that held the one end of the shaft will drop down. When reinstalling the shaft, raise the retainer arm and position the end of the shaft in the notch (callout 1).

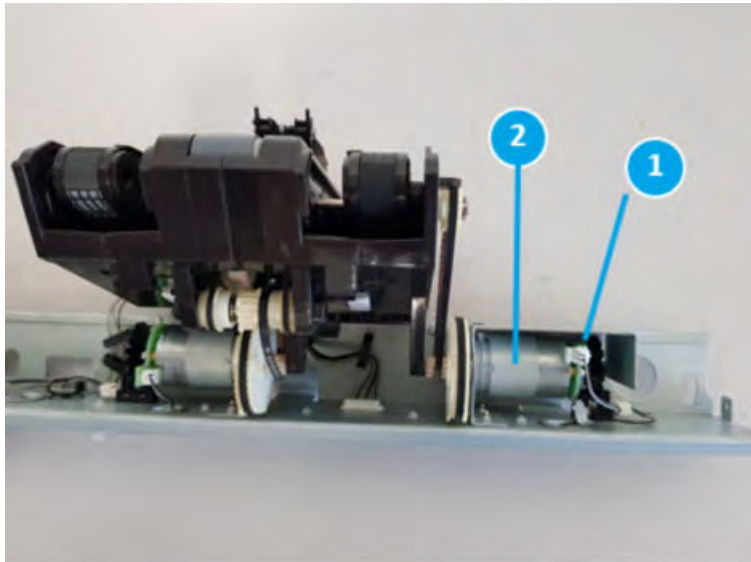


#### Remove the ejector2 motor sensor(S23)

Follow these steps to remove the ejector2 motor sensor(S23).

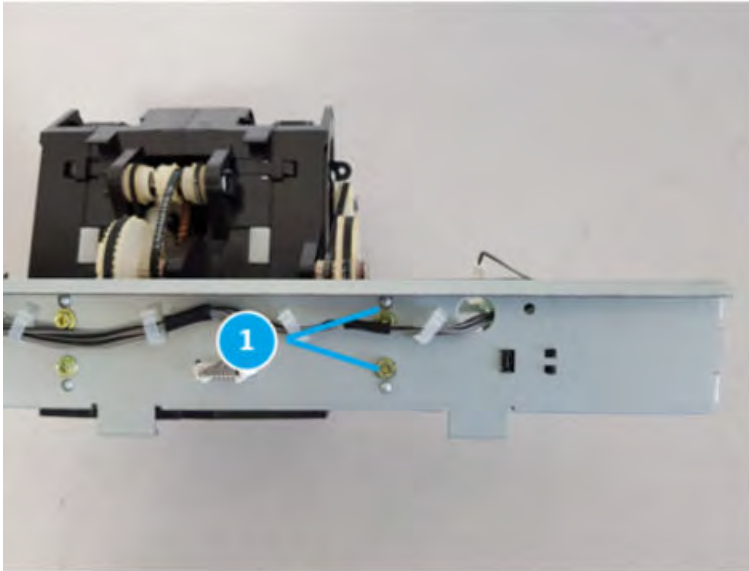
1. Disconnect the connector(callout 1) from ejector2 motor(M5, callout 2) of ejector unit.

Figure 5-1163 Disconnect the connector



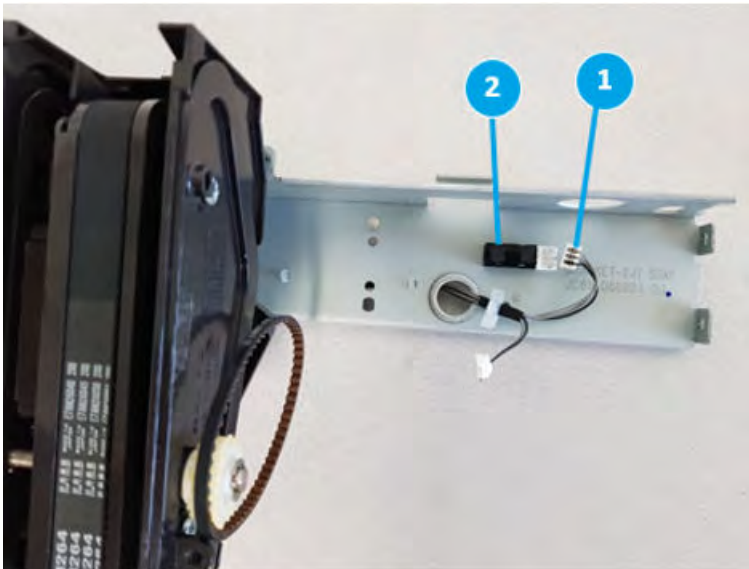
2. Remove two screws(callout 1).

Figure 5-1164 Remove two screws



3. Remove the ejector2 motor from ejector unit, disconnect the connector(callout 1), and then remove the ejector2 motor sensor(S23, callout 2)

Figure 5-1165 Remove the ejector2 motor sensor



### Unpack the replacement assembly

Follow these steps to unpack the replacement assembly.

1. Dispose of the defective part.



---

 **NOTE:** HP recommends responsible disposal of the defective part.


<http://www8.hp.com/us/en/hp-information/environment/product-recycling.html>

---

2. Unpack the replacement part from the packaging.


 **CAUTION:**  Some parts are sensitive to electrostatic discharge (ESD). Always perform service work at an ESD-protected workstation or mat. If an ESD workstation or mat is not available, touch the sheet-metal chassis to provide a static ground before touching an ESD-sensitive assembly. Protect the ESD-sensitive assemblies by placing them in ESD pouches when they are out of the printer.

 **IMPORTANT:** Make sure that all of the shipping materials (for example shipping tape) are removed from the replacement part prior to installation.

 **NOTE:** If the replacement part is a roller or pad, avoid touching the spongy part of it. Skin oils on the roller or pad can cause paper pickup and/or print-quality problems. HP recommends using disposable gloves when handling rollers or pads or washing your hands before touching rollers or pads.

---

3. To install an assembly, reverse the removal steps.

 **NOTE:** When applicable, special installation instructions are provided for an assembly at the end of the removal procedure. Always completely read the removal instructions and follow all special installation instructions.


---

## Removal and replacement: Ejector2 motor (M5)

Learn how to remove and replace the ejector2 motor.

### Introduction

This document provides the procedures to remove and replace the ejector2 motor on the finisher.

 **IMPORTANT:** When applicable, special installation instructions are provided for an assembly at the end of the removal procedure. Always completely read the removal instructions and follow all special installation instructions.

### Before performing service

- Turn the printer power off. A shutting-down message appears on the control-panel display.
- ⚠ **WARNING!** To avoid damage to the printer, turn the power off and wait until the printer shuts down before removing the power cable.
- Disconnect the printer power cable after the printer has completely shut down (the control-panel display is blank).
- Release the finisher from the printer by pulling out on the release latch inside the finisher door.
- Disconnect the cable from the bridge unit to the finisher.
- Disconnect the cable from the finisher to the printer.

Use the table below to identify the correct part number for your printer. To order the part, go to <https://parts.hp.com>.

**Table 5-131** Part information

Part number	Part description
JC93-01168A	Ejector2 motor

### Required tools

- #2 JIS screwdriver with a magnetic tip
- Small, flat-blade screwdriver

### After performing service

- Connect the cable from the finisher to the printer.
- Connect the cable from the bridge unit to the finisher.
- Attach the finisher to the printer, and then push in on the release latch inside the finisher door.
- Connect the printer power cable.
- Turn the printer power on.

### Post service test

Process a job through the finisher and verify that the finisher works correctly.

### Remove the right upper cover (finisher)

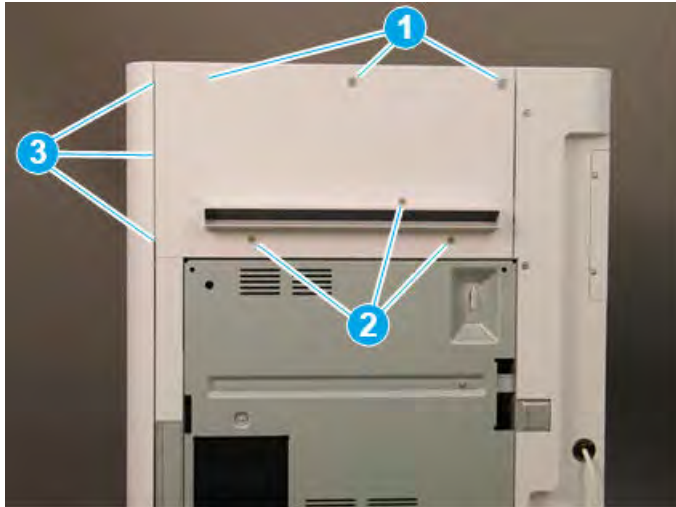
Follow these steps to remove the right upper cover (finisher).

- ▲ Remove one screw cap and three machine screws on the upper edge of the cover (callout 1). Remove three sheet metal screws (callout 2) on the lower portion of the cover. Rotate the right edge of the cover away from the finisher, and then slide the cover right to release three tabs (callout 3).

💡 **TIP:** The lower screws are shorter in length than the upper screws.

**TIP:** Reverse the removal steps to install the assembly.

Figure 5-1166 Remove the right upper cover

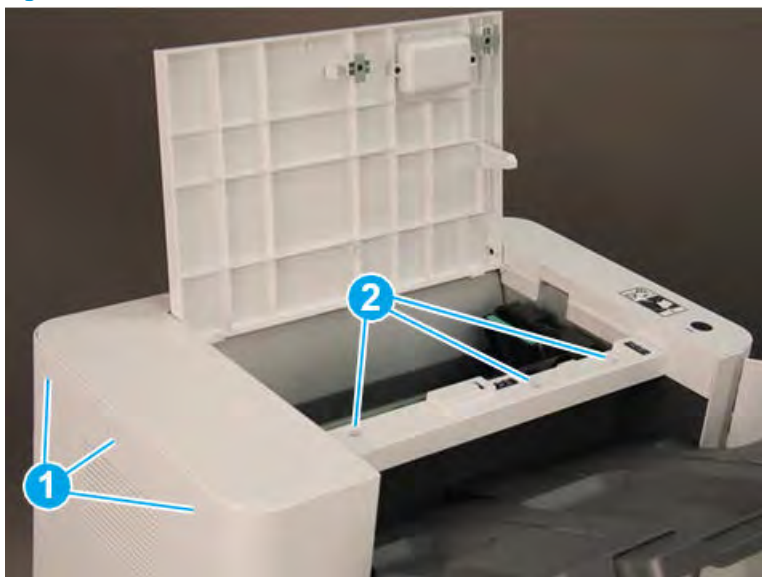


### Remove the top cover (finisher)

Follow these steps to remove the top cover (finisher).

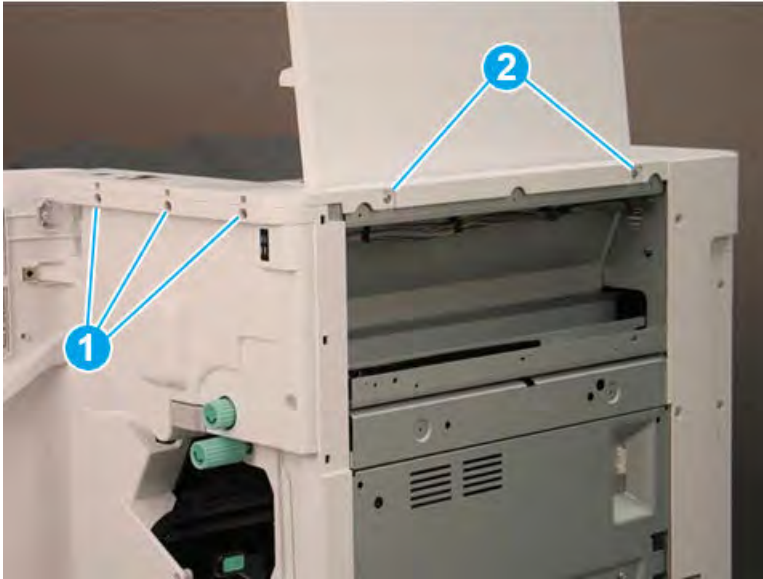
1. Remove three screw caps and three self-tapping screws at the top of the rear cover (callout 1), and then remove three machine screws (callout 2) on top of the cover.

Figure 5-1167 Remove six screws




2. Remove three self-tapping screws at the top of the front cover (callout 1), and then remove two machine screws (callout 2) at the top of the right side.

Figure 5-1168 Remove five screws



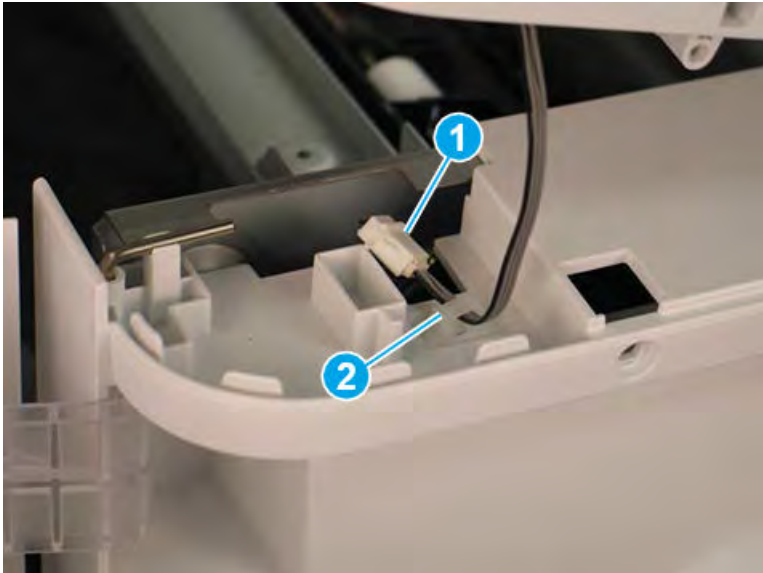
3. Lift the cover up slightly. Disconnect one in-line connector (callout 1), and then release one retainer (callout 2).

---

 **TIP:** Reverse the removal steps to install the assembly.

---

Figure 5-1169 Disconnect one connector and release retainer

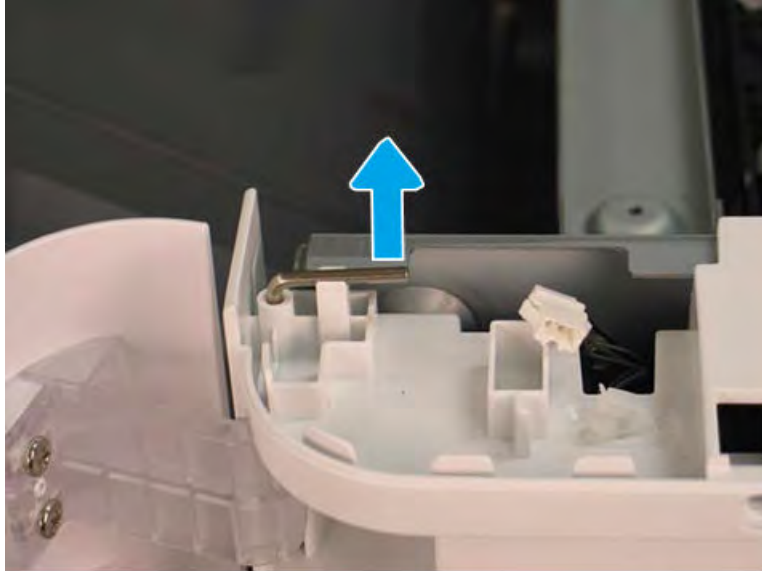


### Remove the front door (finisher)

Follow these steps to remove the front door (finisher).

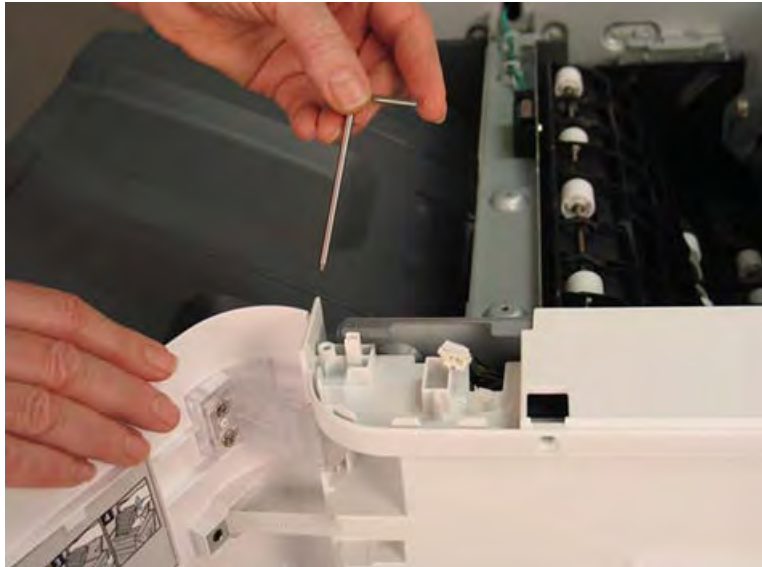
1. Lift the top hinge pin up to release it from the retainer.

Figure 5-1170 Lift the top hinge pin



2. Pull the top hinge pin up to remove it.

Figure 5-1171 Remove the top hinge pin



3. Use a small, flat-blade screwdriver to release the lower hinge pin from the retainer, and then rotate it away from the finisher.

**Figure 5-1172** Release the lower hinge pin




4. Support the door with one hand, and then pull the lower hinge pin straight up to remove it.

**Figure 5-1173** Remove the lower hinge pin

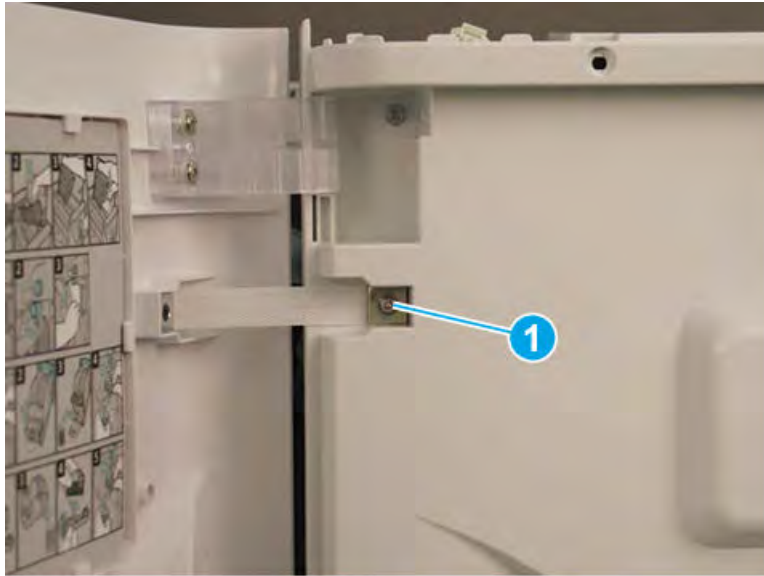




5. Support the door with one hand, and then remove one screw (callout 1) to release the strap. Remove the front door.

 **TIP:** Reverse the removal steps to install the assembly.

**Figure 5-1174** Remove the front door

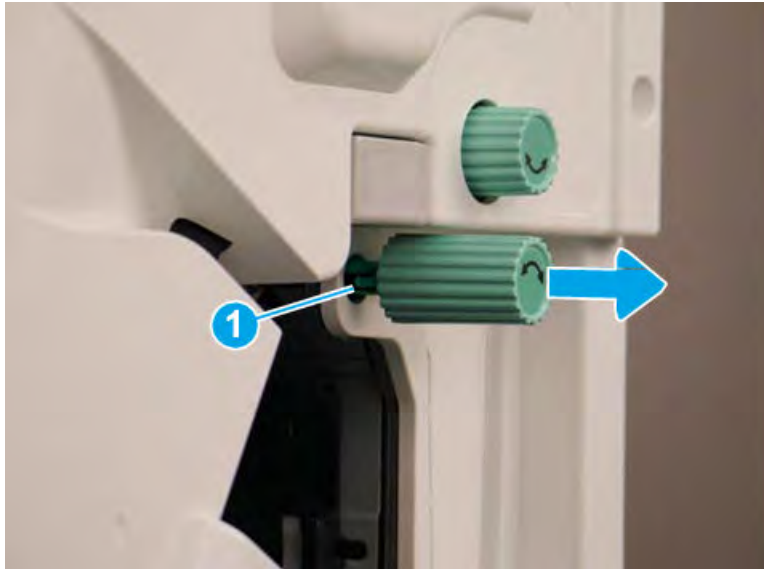


#### Remove the front cover (finisher)

Follow these steps to remove the front cover (finisher).

1. Release one tab (callout 1), and then pull the jam-access knob away from the finisher to remove it.

**Figure 5-1175** Remove the jam-access knob



2. If the punch unit is installed, remove the punch waste bin (callout 1).


3. Remove one screw (callout 1) on top of the front cover.

Figure 5-1176 Remove one screw



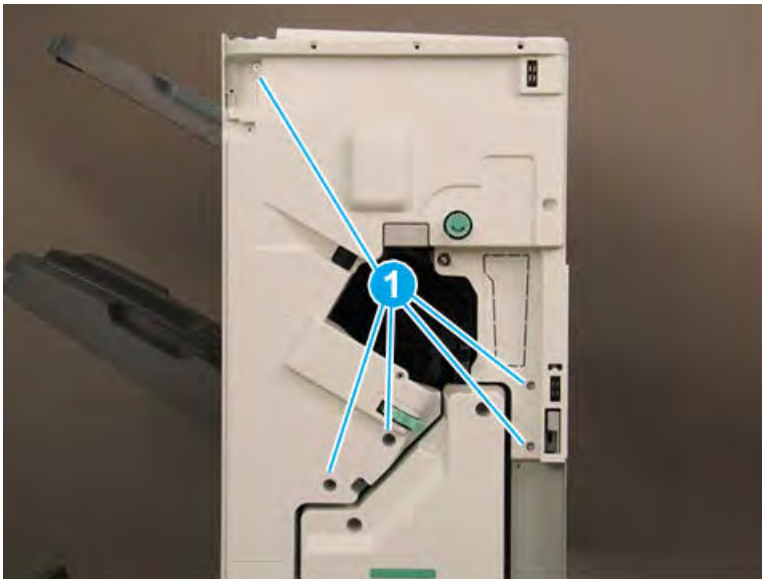
4. Remove five machine screws (callout 1), and then remove the front cover.

---

 **TIP:** Reverse the removal steps to install the assembly.

---

Figure 5-1177 Remove the front cover

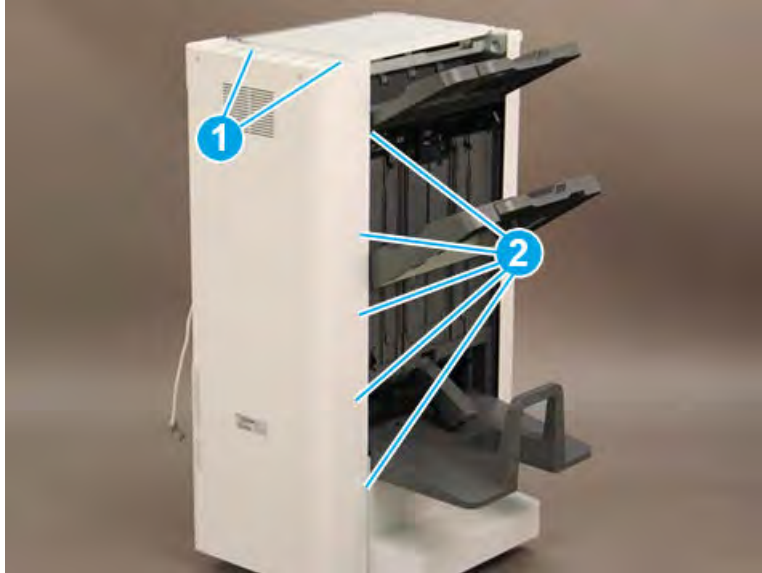


### Remove the rear cover (finisher)

Follow these steps to remove the rear cover (finisher).

1. Remove two self-tapping screws (callout 1) on the top of the rear cover, and then remove five screw caps and five machine screws (callout 2) on the left side of the cover.

Figure 5-1178 Remove seven screws



2. Remove one screw cap and four machine screws (callout 1) Remove the rear cover.

 **NOTE:** Make sure to thread the power cable (callout 2) through the opening in the cover.


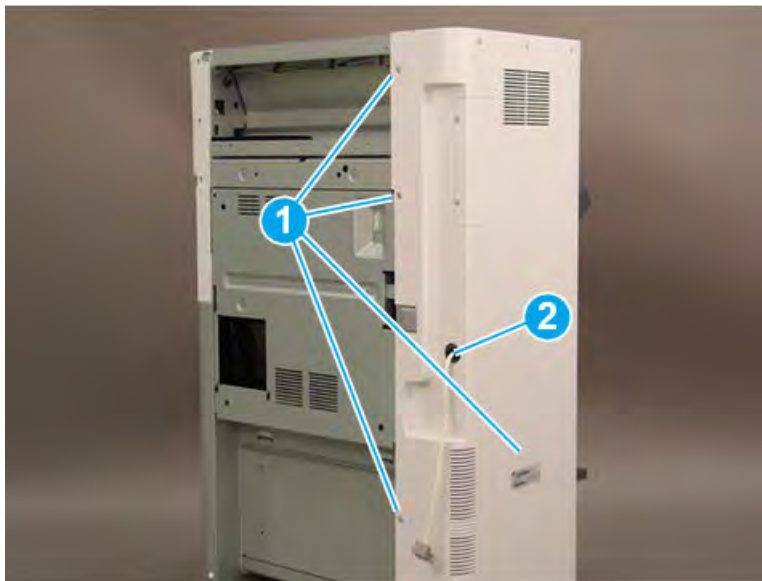
 **TIP:** Reverse the removal steps to install the assembly

Figure 5-1179 Remove the rear cover



### Remove the booklet output tray

Follow these steps to remove the booklet output tray.

1. Raise the booklet output tray up (callout 1), and then pull it away from the finisher (callout 2) to remove it.

Figure 5-1180 Remove the booklet output tray



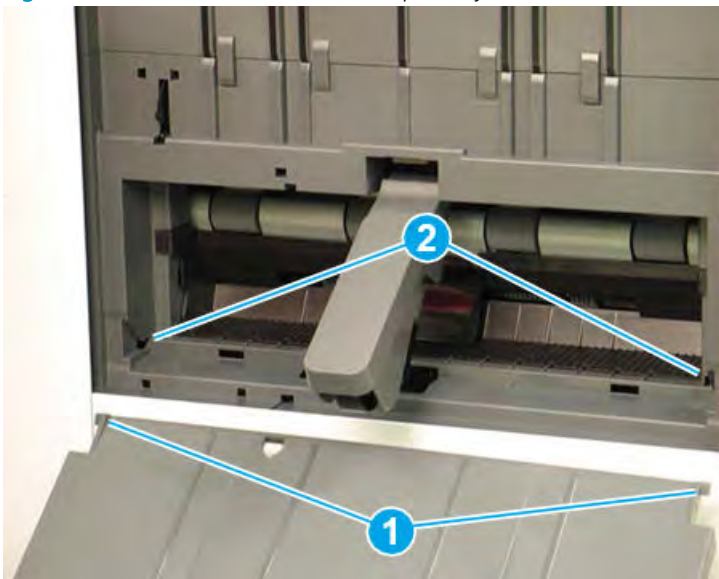
2. Reverse the removal steps to install the assembly. Also use the following special installation instructions.

 **NOTE:** Continue to reverse the removal steps to finish installing the assembly

Special installation instructions: booklet output tray

Position the tabs (callout 1) on the tray into the slots (callout 2) on the finisher.

Figure 5-1181 Install the booklet output tray

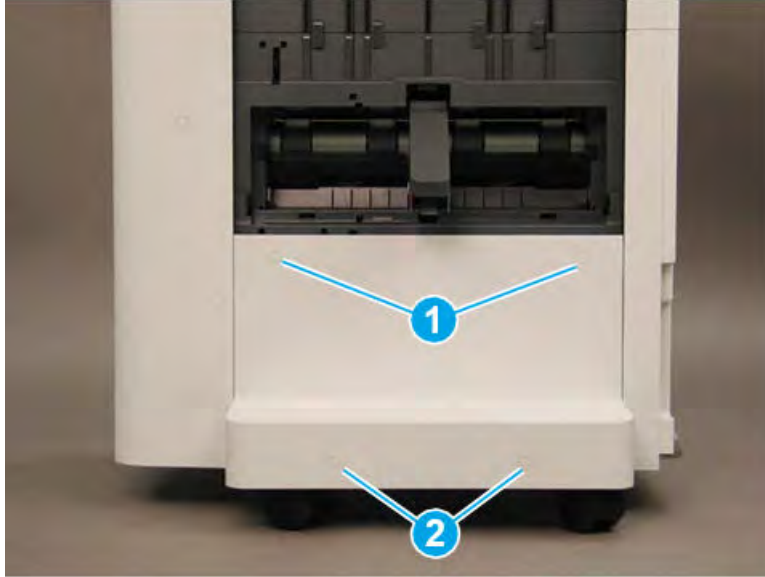


### Remove the caster cover

Follow these steps to remove the caster cover.

1. Remove two screw caps and two self-tapping screws (callout 1). Remove two screw caps and two machine screws (callout 2).

Figure 5-1182 Remove four screws



2. Rotate the left edge of the cover away from the finisher (callout 1), and then slide the cover to the left (callout 2) to remove it.

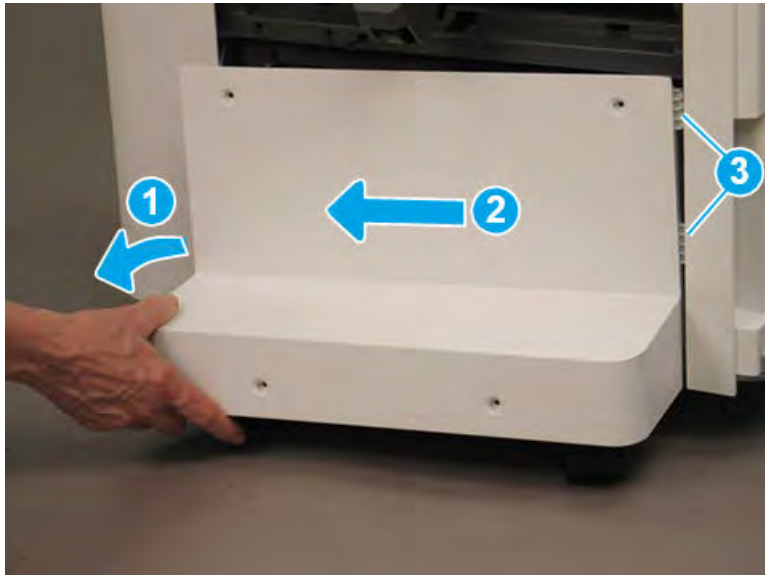
---

 **TIP:** Make sure that two tabs (callout 3) are positioned under the front lower cover when reinstalling the caster cover.

**TIP:** Reverse the removal steps to install the assembly

---

Figure 5-1183 Remove the caster cover




### Remove the left lower cover (finisher)

Follow these steps to remove the left lower cover (finisher).

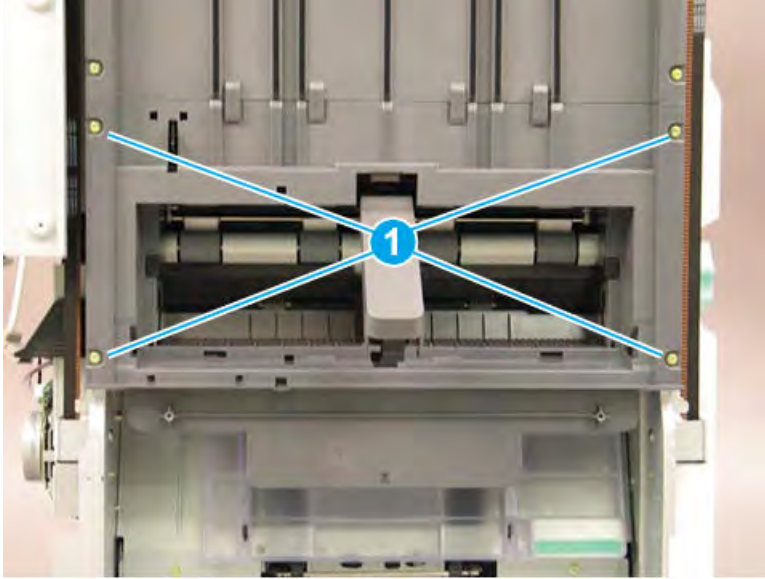
1. Remove four screws (callout 1).

---

 **NOTE:** Raise the lower output tray as needed to access the screws.

---

Figure 5-1184 Remove four screws



2. Slide the shield down (callout 1) to release it from four tabs (callout 2), and then rotate it away from the finisher (callout 3).

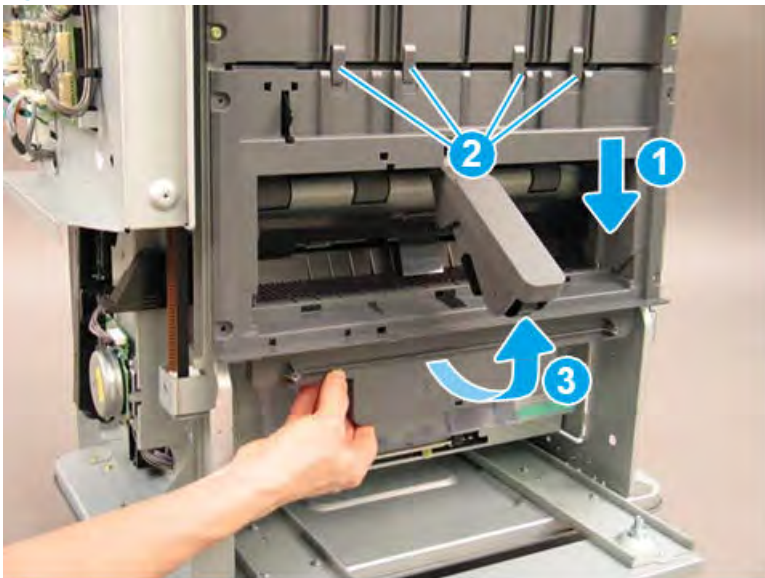
---

**⚠ CAUTION:** The shield is still attached to the finisher. Do not attempt to completely remove the shield.


**💡 TIP:** Position the shield under the four tabs (callout 2) when reinstalling it.

---

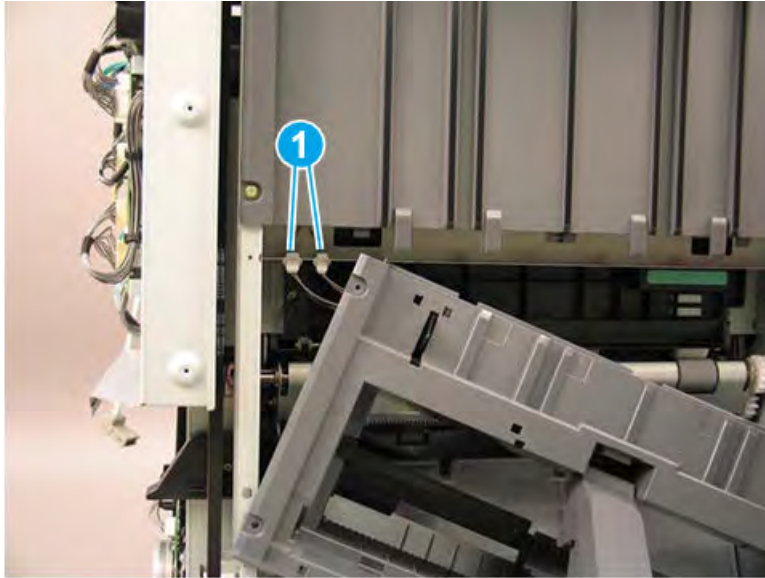
Figure 5-1185 Release the lower shield



3. Disconnect two connectors (callout 1), and then remove the shield.

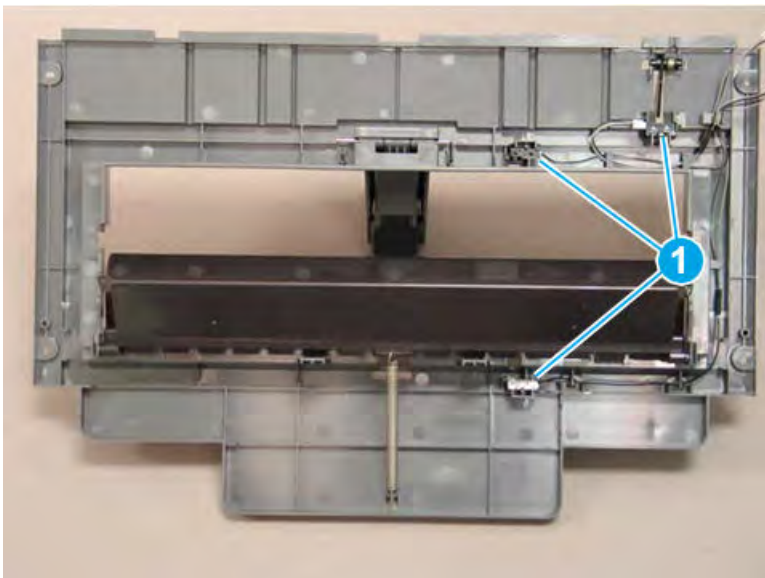
 **TIP:** Reverse the removal steps to install the assembly.

**Figure 5-1186** Disconnect two connectors



4. If you are replacing the left lower cover, locate three sensors (callout 1) on the back of the left lower cover. Remove these sensors and transfer them to the replacement part.

**Figure 5-1187** Remove the left lower cover

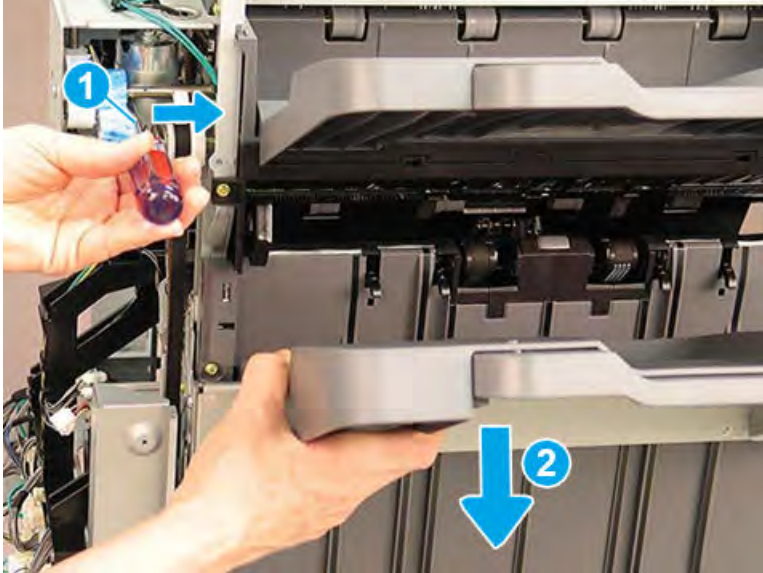


### Remove the left upper cover (finisher)

Follow these steps to remove the left upper cover (finisher).

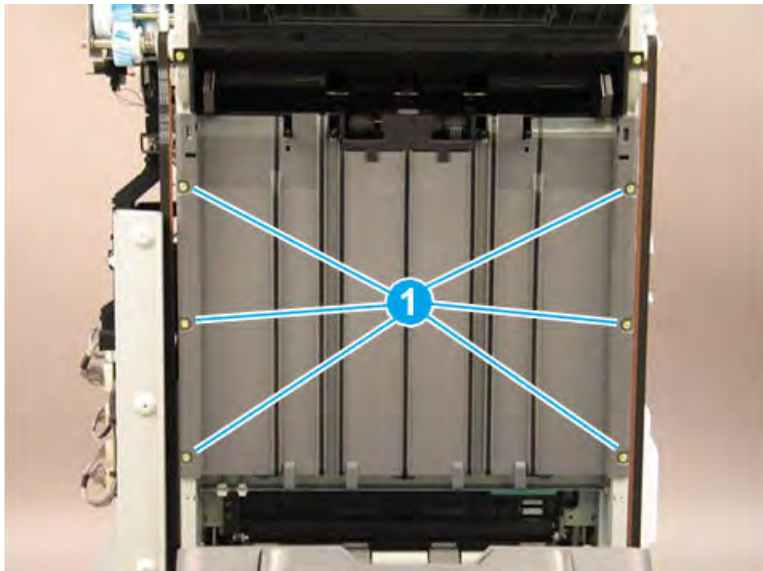
1. Bring the lower output tray down by positioning the shaft of a screwdriver on the clutch (callout 1) and gently pressing to the right to release the clutch. Hold the clutch in the released position and lower the tray (callout 2) to the lowest position.

Figure 5-1188 Lower the output tray



2. Remove six machine screws (callout 1).

Figure 5-1189 Remove six screws



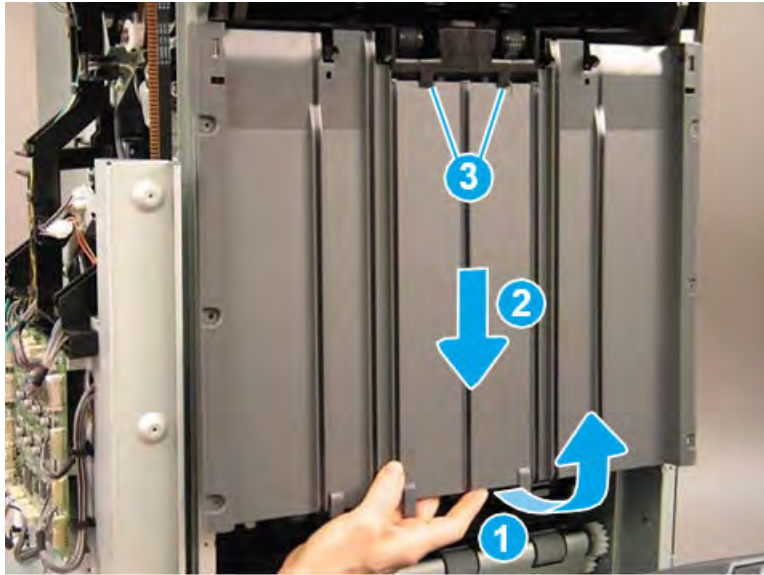


3. Rotate the lower edge of the shield away from the finisher (callout 1), and then slide the shield down (callout 2) to release it from two tabs (callout 3).

**CAUTION:** The shield is still attached to the finisher. Do not attempt to completely remove the shield.

**TIP:** Position the shield under the two tabs (callout 3) when reinstalling it.

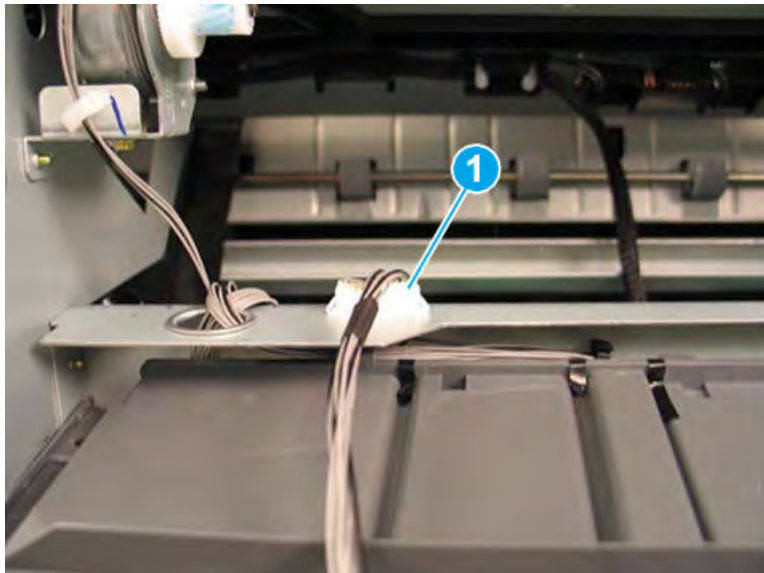
Figure 5-1190 Release the shield



4. Disconnect one connector (callout 1), and then remove the upper shield assembly.

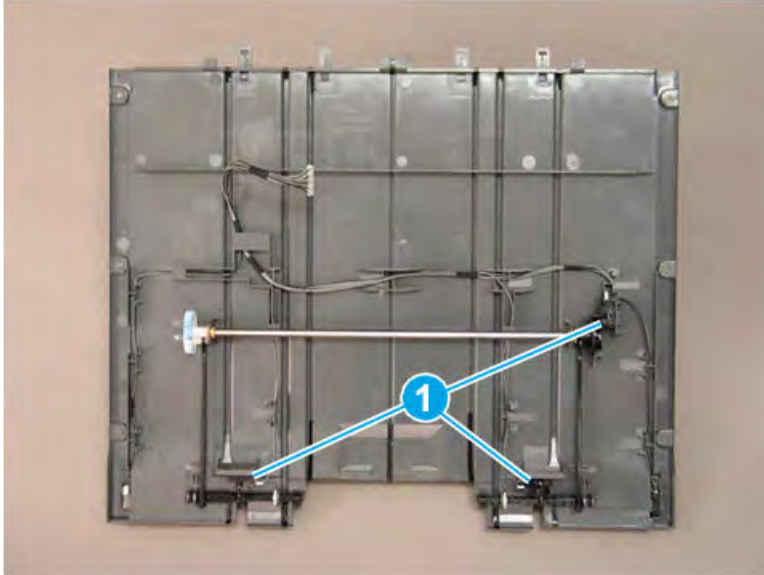
**TIP:** Reverse the removal steps to install the assembly.

Figure 5-1191 Disconnect one connector



5. If you are replacing the left upper cover, locate three sensors (callout 1) on the back of the left upper cover. Remove these sensors and transfer them to the replacement part.

Figure 5-1192 Remove the left upper cover

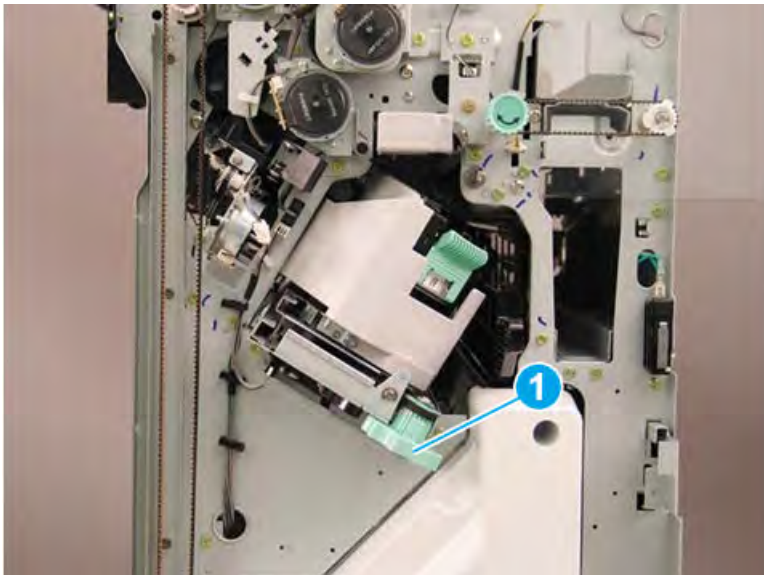


#### Remove the ejector unit (finisher)

Follow these steps to remove the ejector unit (finisher).

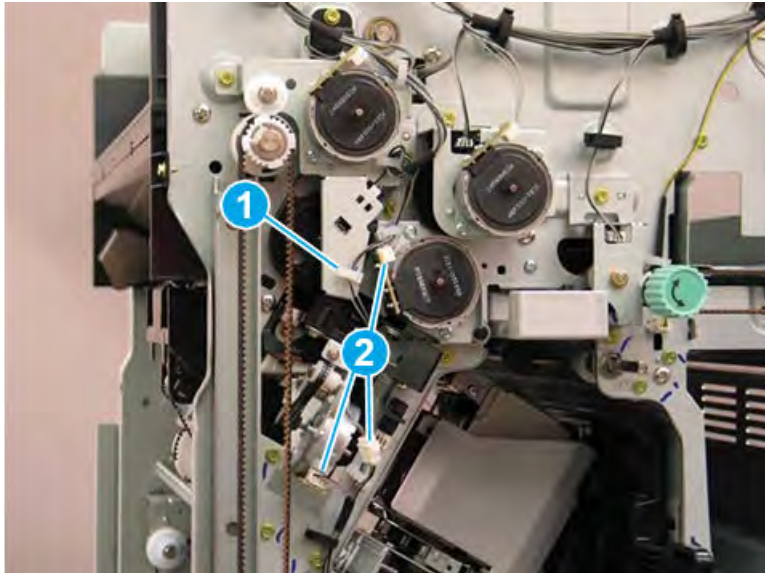
1. Rotate the green wheel to move the staple unit to the center of the finisher.

Figure 5-1193 Move the staple unit to the center



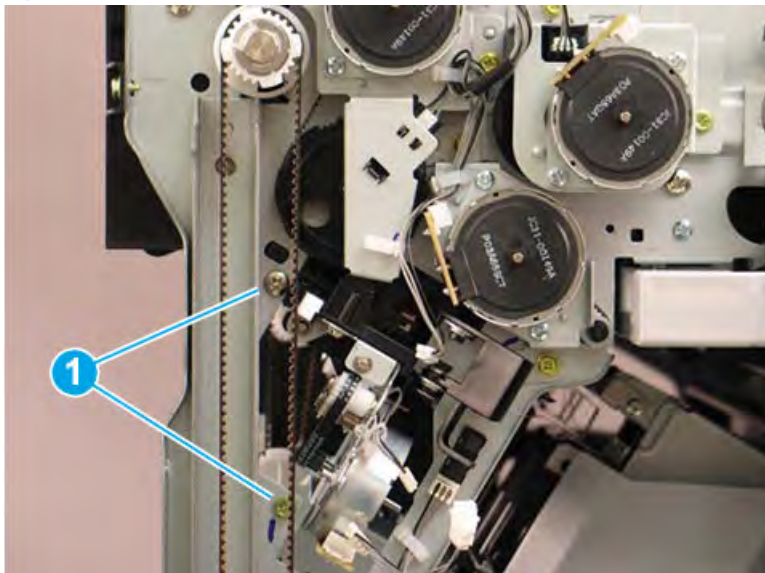
2. Release one retainer (callout 1), and then disconnect three connectors (callout 2).

Figure 5-1194 Disconnect three connectors



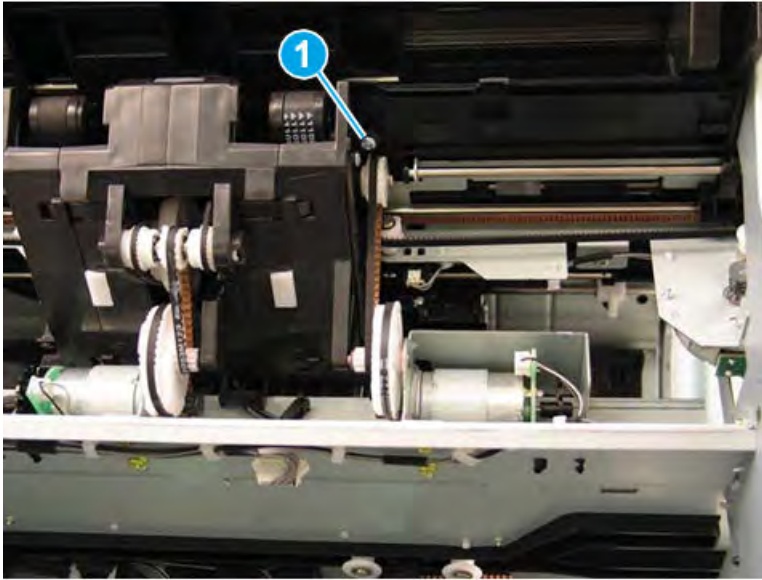
3. Remove two screws (callout 1).

Figure 5-1195 Remove two screws



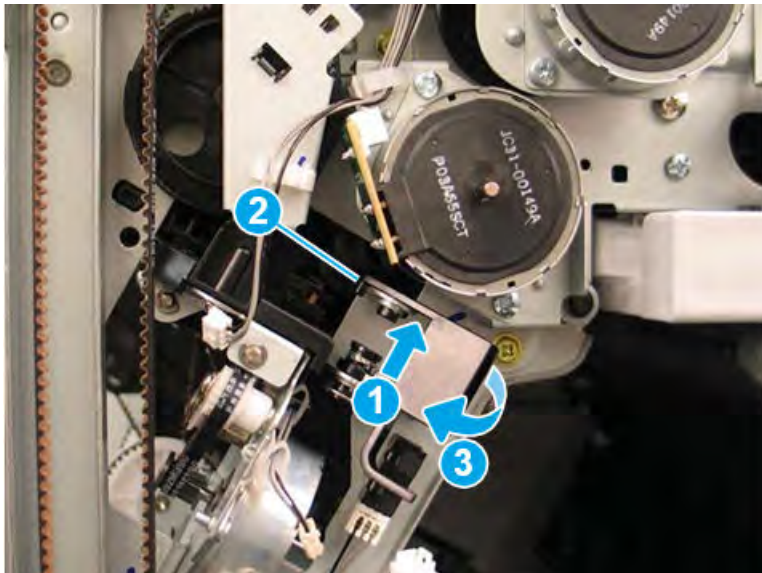
4. At the left side of the finisher, remove one screw (callout 1).

Figure 5-1196 Remove one screw



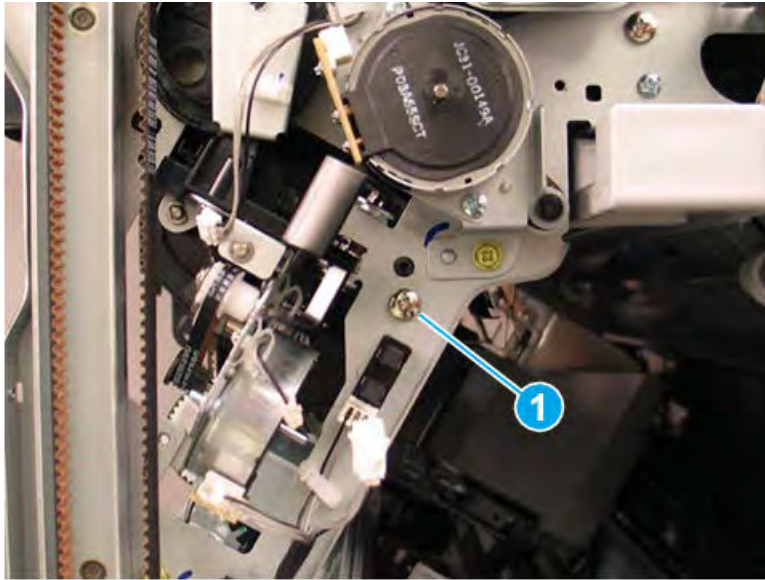
5. Press up on the hinge (callout 1), release one tab (callout 2), and then rotate the sensor away from the finisher (callout 3).

Figure 5-1197 Rotate the sensor



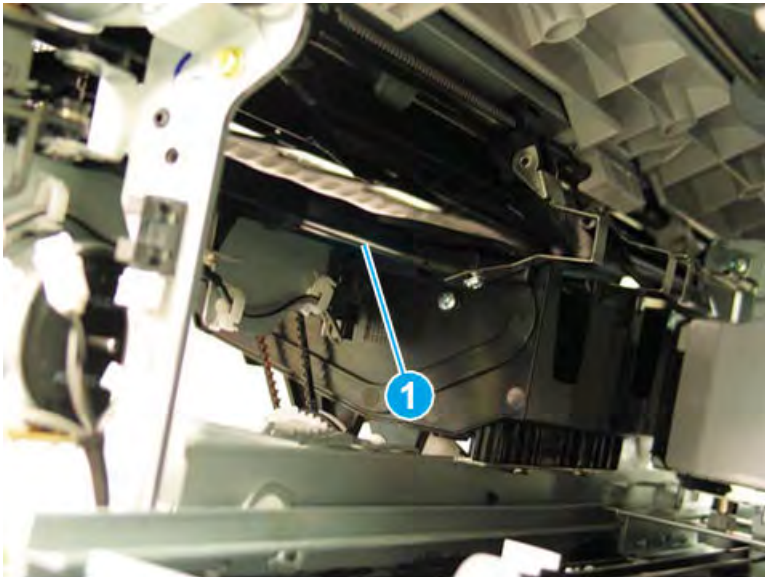
6. Remove one screw (callout 1).

Figure 5-1198 Remove one screw



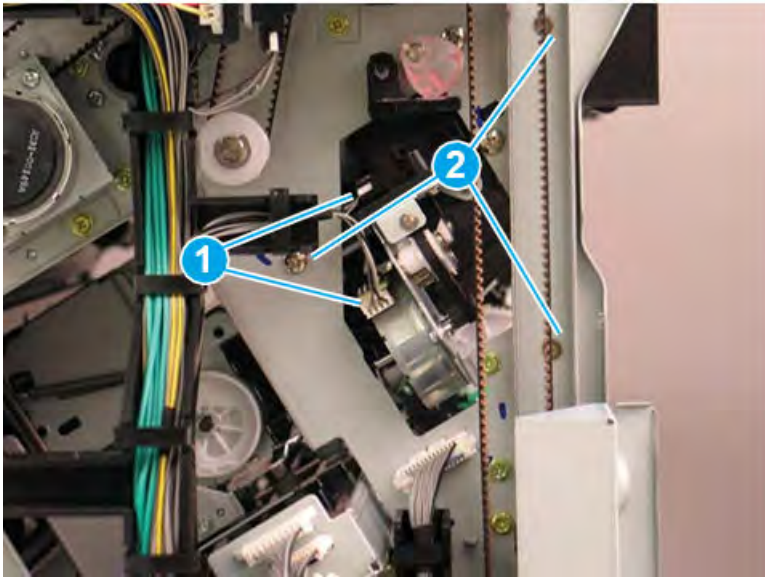
7. Look inside the finisher through the stapler opening in the front and pull down to release and remove one shaft (callout 1) on the front tamper unit.

Figure 5-1199 Remove the front tamper shaft



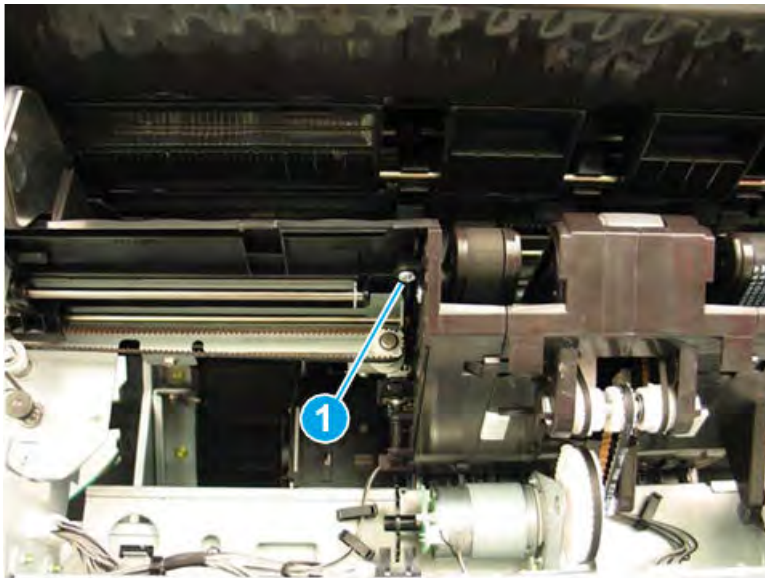
8. At the rear of the finisher, disconnect two connectors (callout 1), and then remove three screws (callout 2).

Figure 5-1200 Disconnect two connectors and remove three screws



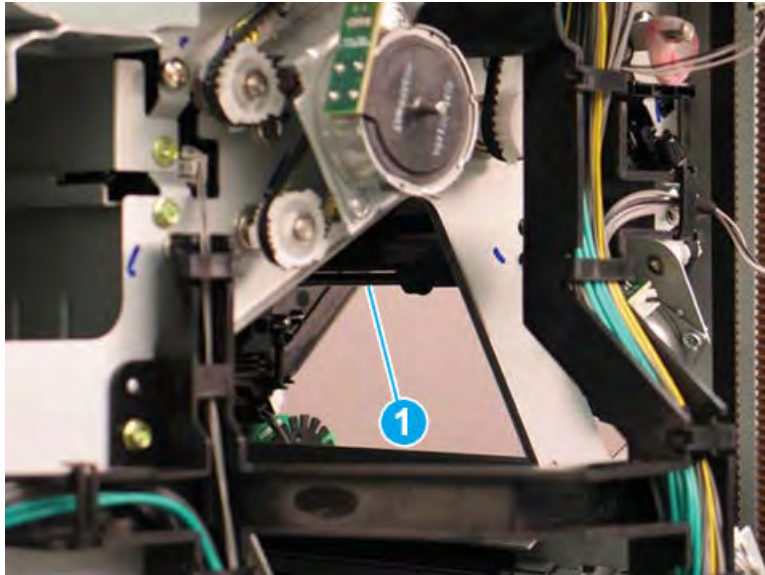
9. At the left side of the finisher, remove one screw (callout 1).

Figure 5-1201 Remove one screw



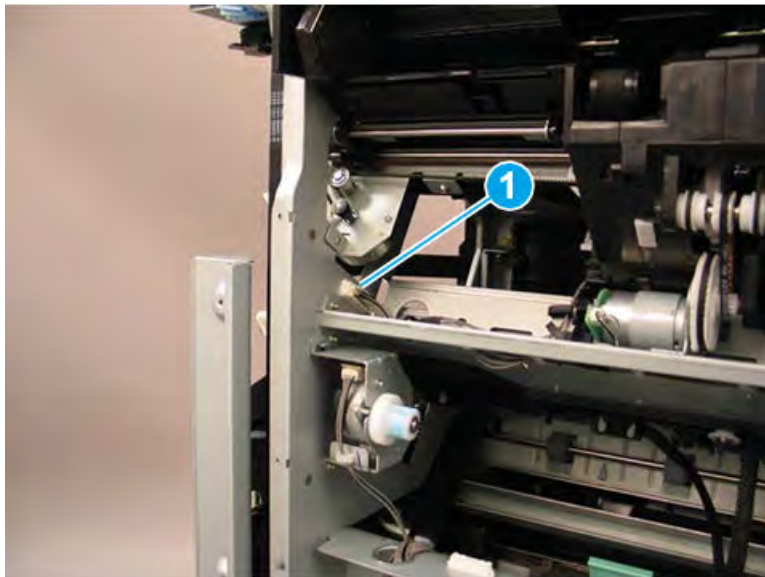
10. Look inside the finisher through the stapler opening in the rear and pull down to release and remove one shaft (callout 1) on the rear tamper unit.

Figure 5-1202 Remove the rear tamper shaft



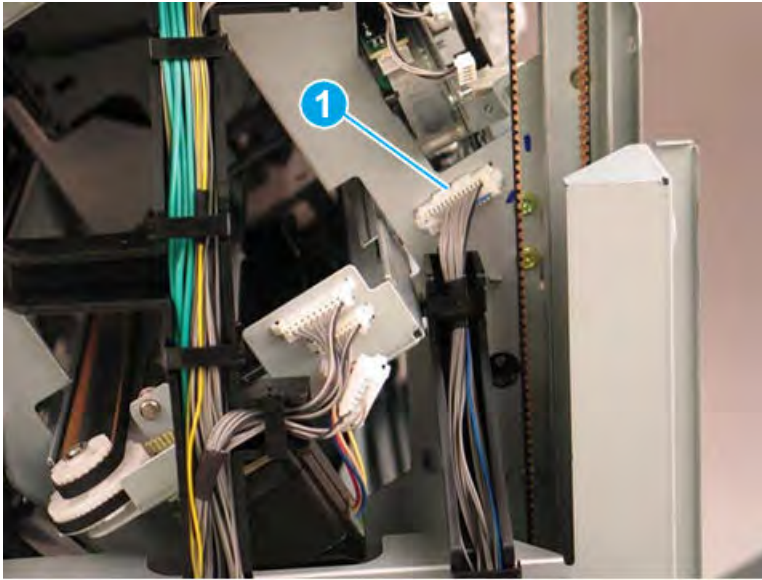
11. At the left side of the finisher, disconnect one connector (callout 1).

Figure 5-1203 Disconnect one connector



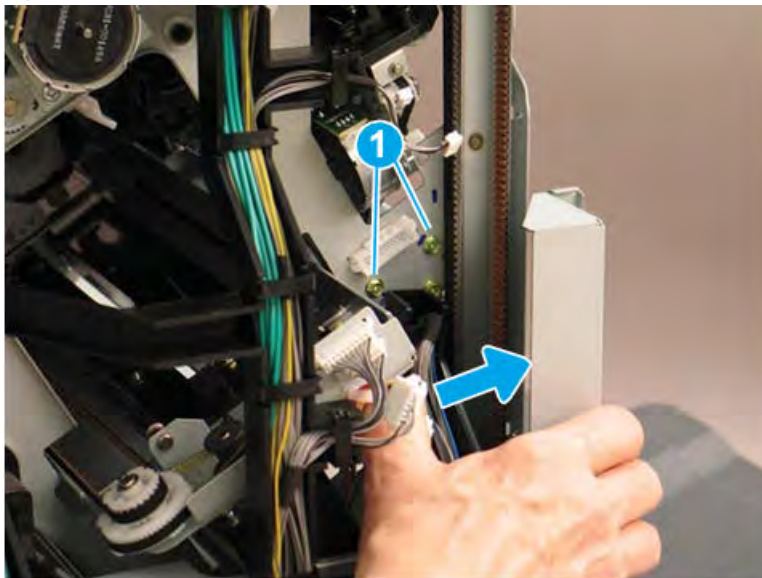
12. At the rear of the finisher, disconnect one connector (callout 1).

Figure 5-1204 Disconnect one connector



13. At the rear of the finisher, press the wire retainer to the right to access and remove two screws (callout 1).

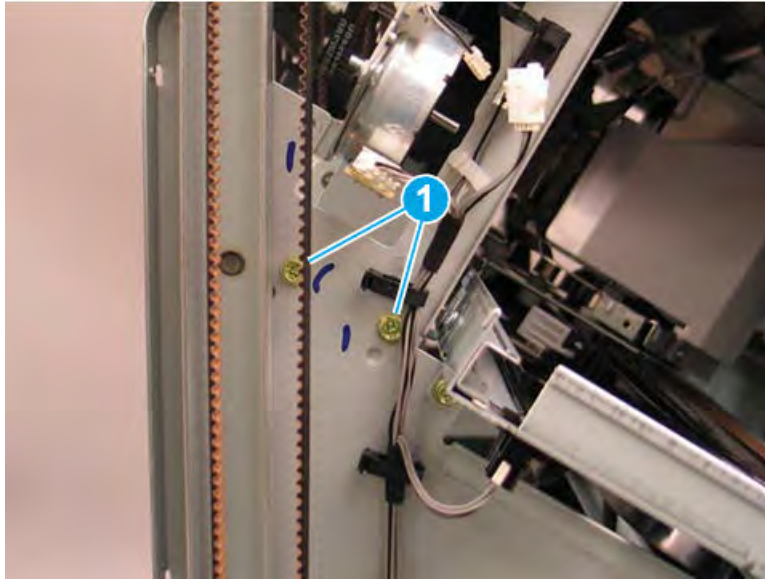
Figure 5-1205 Disconnect one connector





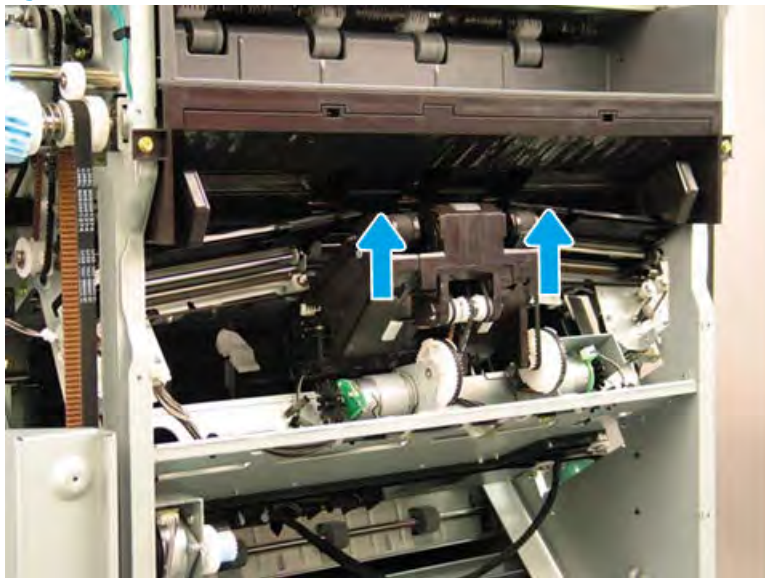
14. At the front of the finisher, remove two screws (callout 1).

Figure 5-1206 Remove two screws



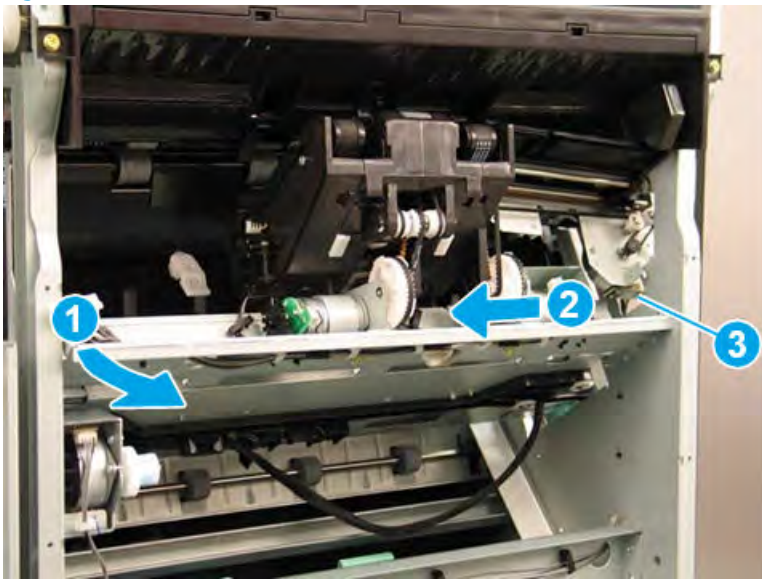
15. Lift the inside edges of the front and rear tampers up.

Figure 5-1207 Lift the edges of the tampers



16. Rotate the rear edge of the ejector unit away from the finisher (callout 1), and then slide it toward the rear of the finisher (callout 2) to remove it. Make sure that the PCA (callout 3) stays clear of the sheet metal frame.

Figure 5-1208 Remove the ejector unit



17. Reverse the removal steps to install the assembly. Also use the following special installation instructions.

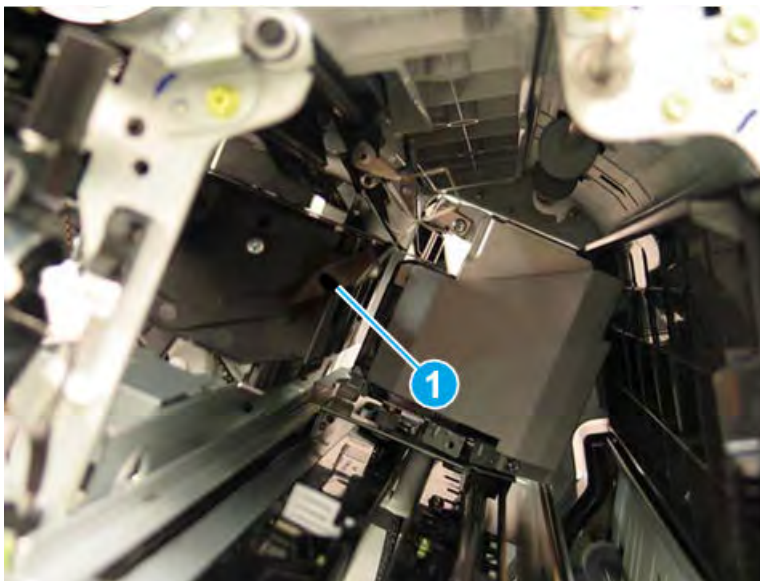
---

 **NOTE:** Continue to reverse the removal steps to finish installing the assembly.

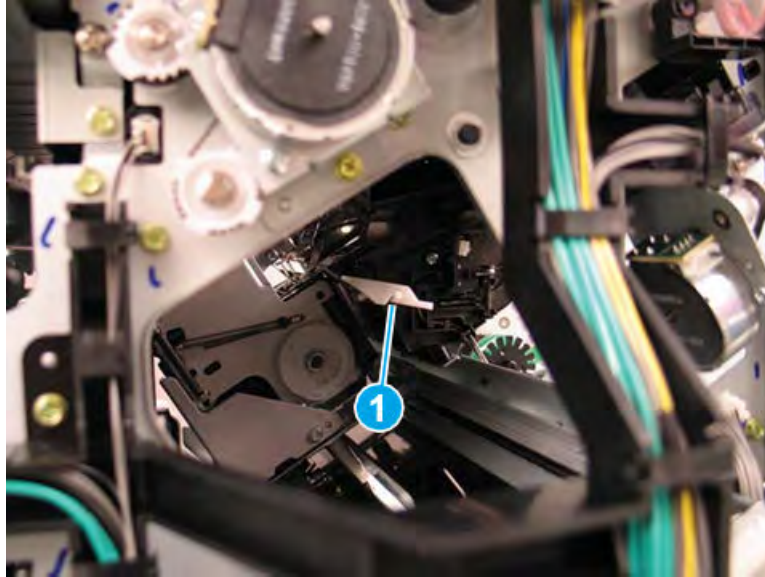
---

**Special installation instructions: Ejector unit**

- a. When the front tamper shaft is removed, the retainer arm that held the one end of the shaft will drop down. When reinstalling the shaft, raise the retainer arm and position the end of the shaft in the notch (callout 1).



- b. When the rear tamper shaft is removed, the retainer arm that held the one end of the shaft will drop down. When reinstalling the shaft, raise the retainer arm and position the end of the shaft in the notch (callout 1).

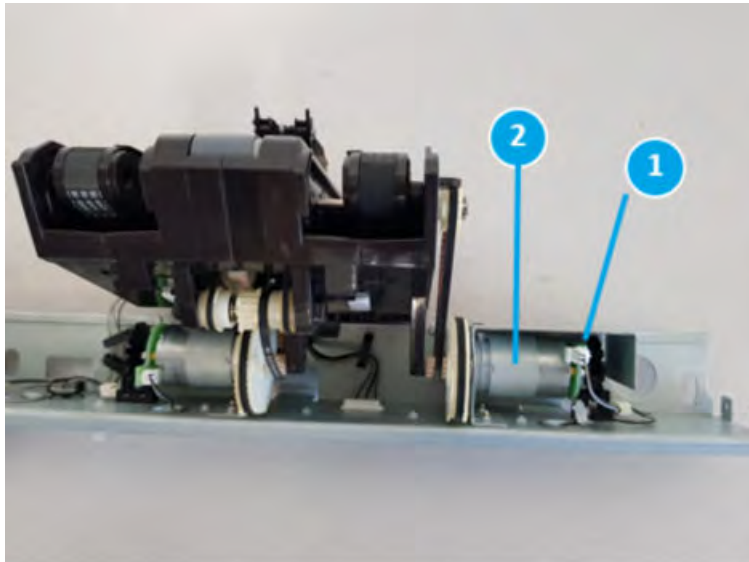


#### Remove the ejector2 motor(M5)

Follow these steps to remove the ejector2 motor(M5).

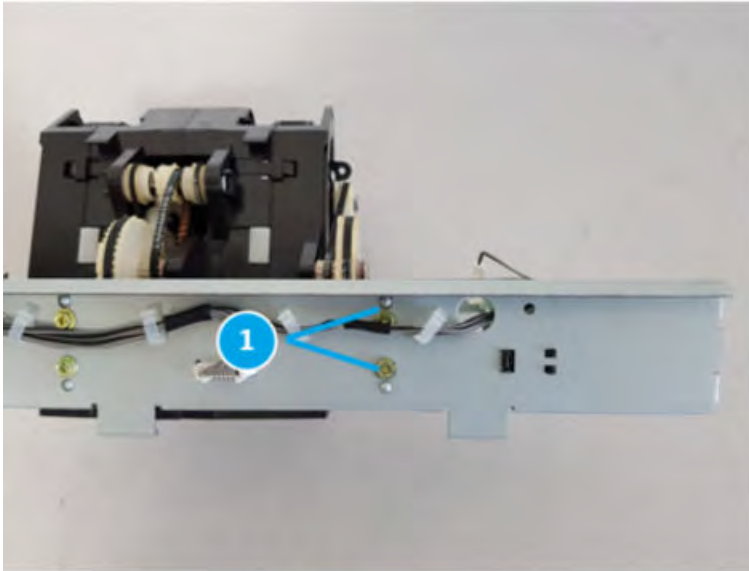
1. Disconnect the connector(callout 1) from ejector2 motor(M5, callout 2) of ejector unit.

Figure 5-1209 Disconnect the connector



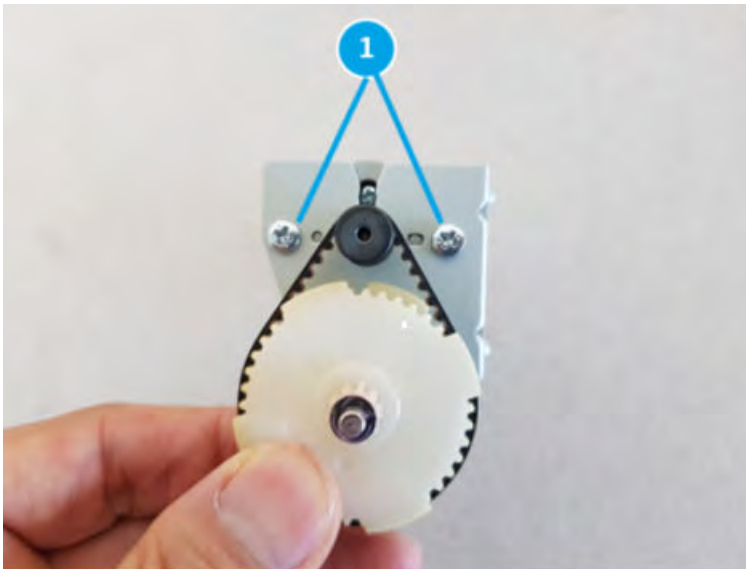
2. Remove two screws(callout 1).

Figure 5-1210 Remove two screws



3. Remove the ejector2 motor from ejector unit and remove two screws(callout 1)

Figure 5-1211 Remove the ejector2 motor



### Unpack the replacement assembly

Follow these steps to unpack the replacement assembly.

1. Dispose of the defective part.



---

 **NOTE:** HP recommends responsible disposal of the defective part.


<http://www8.hp.com/us/en/hp-information/environment/product-recycling.html>

---

2. Unpack the replacement part from the packaging.


 **CAUTION:**  Some parts are sensitive to electrostatic discharge (ESD). Always perform service work at an ESD-protected workstation or mat. If an ESD workstation or mat is not available, touch the sheet-metal chassis to provide a static ground before touching an ESD-sensitive assembly. Protect the ESD-sensitive assemblies by placing them in ESD pouches when they are out of the printer.

 **IMPORTANT:** Make sure that all of the shipping materials (for example shipping tape) are removed from the replacement part prior to installation.

 **NOTE:** If the replacement part is a roller or pad, avoid touching the spongy part of it. Skin oils on the roller or pad can cause paper pickup and/or print-quality problems. HP recommends using disposable gloves when handling rollers or pads or washing your hands before touching rollers or pads.

---

3. To install an assembly, reverse the removal steps.

 **NOTE:** When applicable, special installation instructions are provided for an assembly at the end of the removal procedure. Always completely read the removal instructions and follow all special installation instructions.

---


## Main output tray unit

## Removal and replacement: Main output tray top of stack sensor (S20)

Learn how to remove and replace the main output tray top of stack sensor.

### Introduction

This document provides the procedures to remove and replace the main output tray top of stack sensor on the finisher.

 **IMPORTANT:** When applicable, special installation instructions are provided for an assembly at the end of the removal procedure. Always completely read the removal instructions and follow all special installation instructions.

### Before performing service

- Turn the printer power off. A shutting-down message appears on the control-panel display.
- ⚠ **WARNING!** To avoid damage to the printer, turn the power off and wait until the printer shuts down before removing the power cable.
- Disconnect the printer power cable after the printer has completely shut down (the control-panel display is blank).
- Release the finisher from the printer by pulling out on the release latch inside the finisher door.
- Disconnect the cable from the bridge unit to the finisher.
- Disconnect the cable from the finisher to the printer.

Use the table below to identify the correct part number for your printer. To order the part, go to <https://parts.hp.com>.

**Table 5-132 Part information**

Part number	Part description
JC82-01039A	Main output tray top of stack sensor

### Required tools

- #2 JIS screwdriver with a magnetic tip

### After performing service

- Connect the cable from the finisher to the printer.
- Connect the cable from the bridge unit to the finisher.
- Attach the finisher to the printer, and then push in on the release latch inside the finisher door.
- Connect the printer power cable.
- Turn the printer power on.

### Post service test

Process a job through the finisher and verify that the finisher works correctly.

## Remove the right upper cover (finisher)

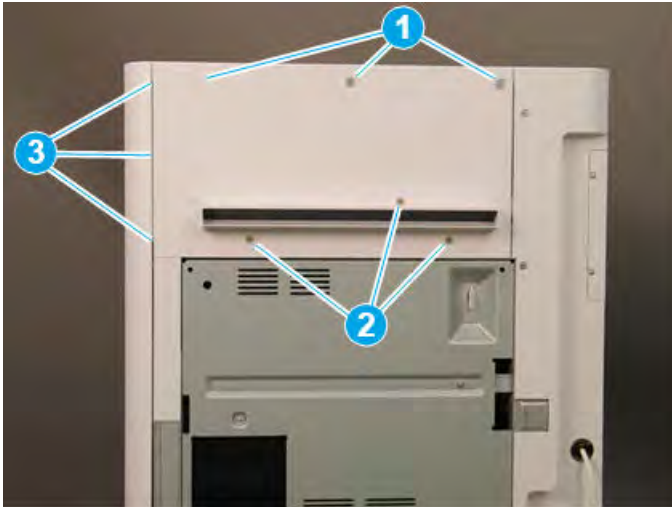
Follow these steps to remove the right upper cover (finisher).

- ▲ Remove one screw cap and three machine screws on the upper edge of the cover (callout 1). Remove three sheet metal screws (callout 2) on the lower portion of the cover. Rotate the right edge of the cover away from the finisher, and then slide the cover right to release three tabs (callout 3).

💡 **TIP:** The lower screws are shorter in length than the upper screws.

**TIP:** Reverse the removal steps to install the assembly.

**Figure 5-1212** Remove the right upper cover

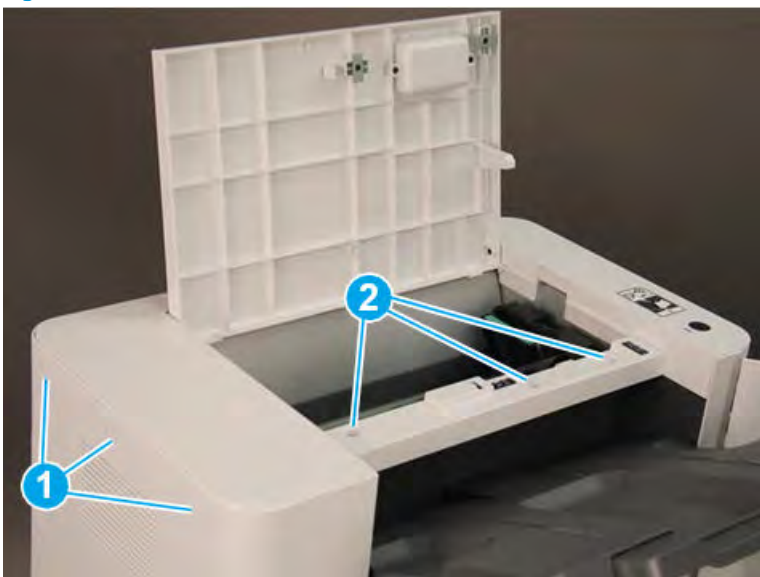


## Remove the top cover (finisher)

Follow these steps to remove the top cover (finisher).

1. Remove three screw caps and three self-tapping screws at the top of the rear cover (callout 1), and then remove three machine screws (callout 2) on top of the cover.

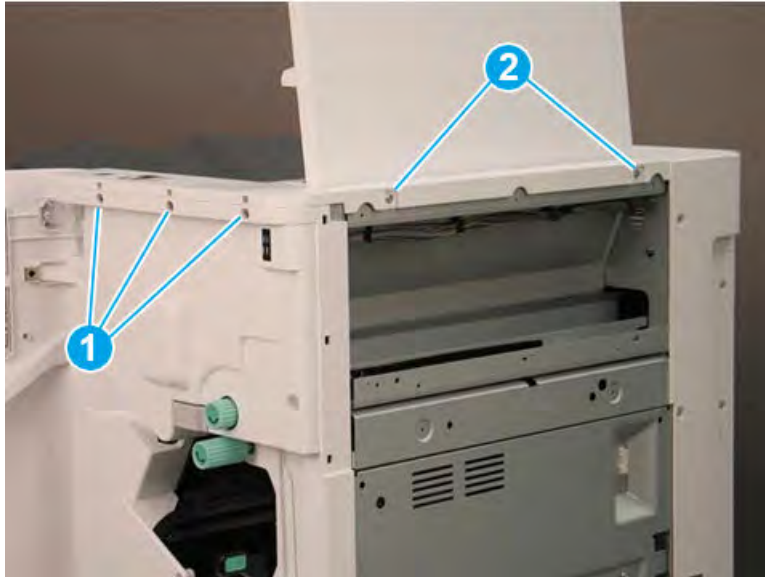
**Figure 5-1213** Remove six screws






2. Remove three self-tapping screws at the top of the front cover (callout 1), and then remove two machine screws (callout 2) at the top of the right side.

Figure 5-1214 Remove five screws



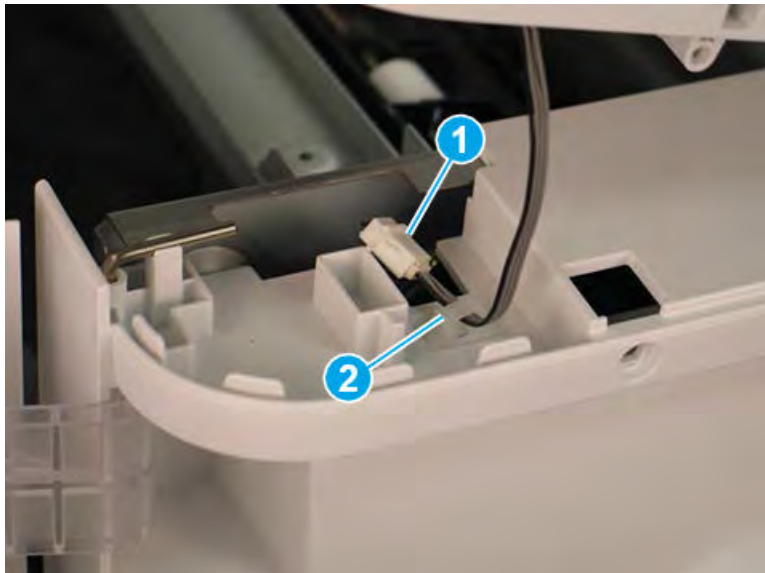
3. Lift the cover up slightly. Disconnect one in-line connector (callout 1), and then release one retainer (callout 2).

---

 **TIP:** Reverse the removal steps to install the assembly.

---

Figure 5-1215 Disconnect one connector and release retainer

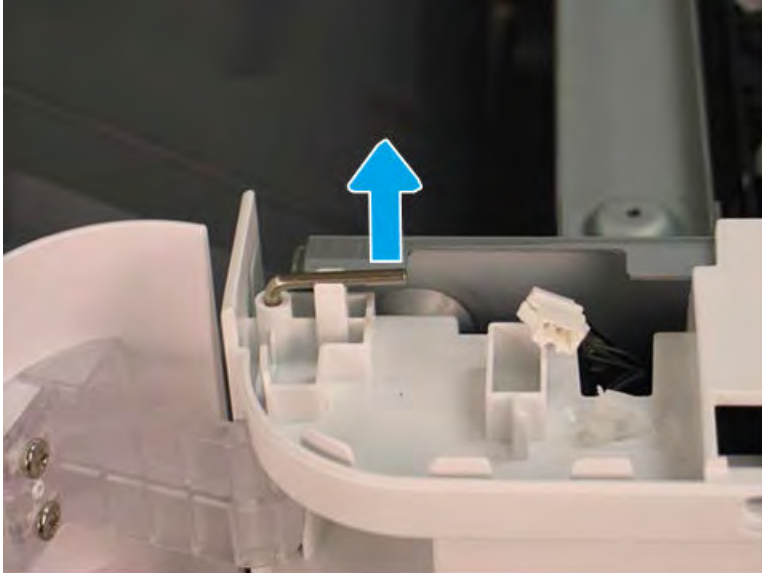


### Remove the front door (finisher)

Follow these steps to remove the front door (finisher).

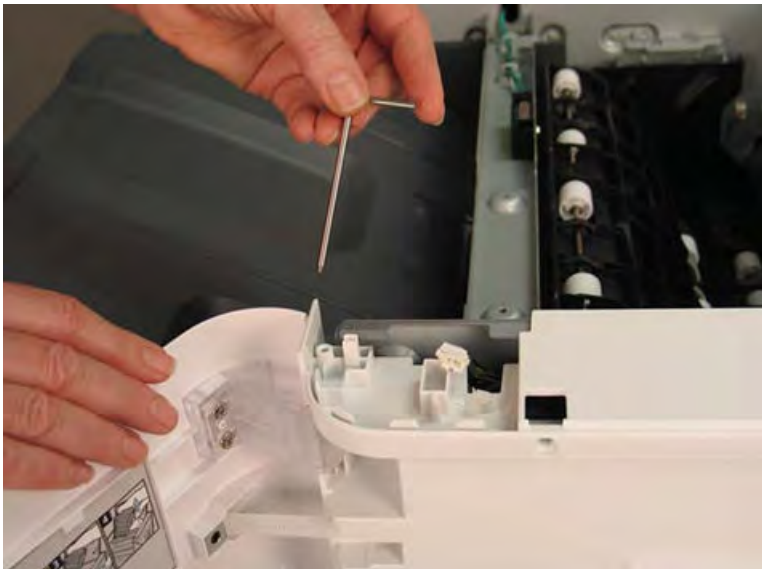
1. Lift the top hinge pin up to release it from the retainer.

Figure 5-1216 Lift the top hinge pin



2. Pull the top hinge pin up to remove it.

Figure 5-1217 Remove the top hinge pin



3. Use a small, flat-blade screwdriver to release the lower hinge pin from the retainer, and then rotate it away from the finisher.

Figure 5-1218 Release the lower hinge pin



4. Support the door with one hand, and then pull the lower hinge pin straight up to remove it.

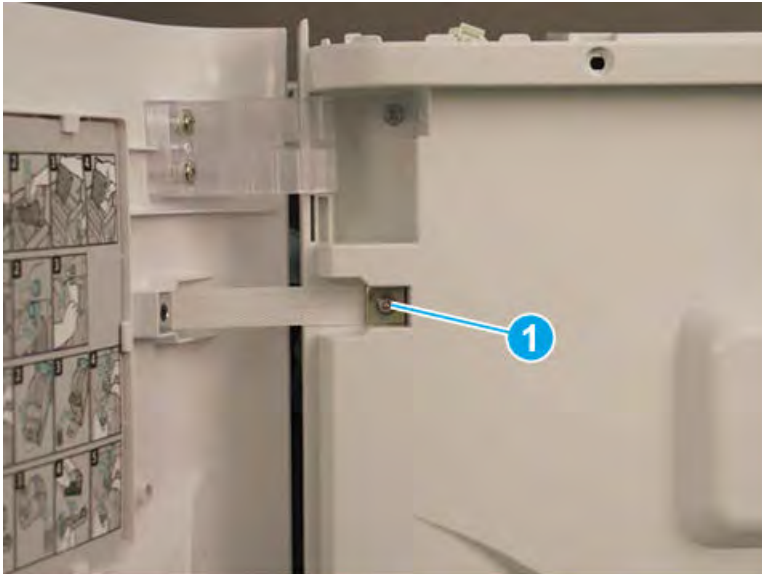
Figure 5-1219 Remove the lower hinge pin



5. Support the door with one hand, and then remove one screw (callout 1) to release the strap. Remove the front door.

 **TIP:** Reverse the removal steps to install the assembly.

**Figure 5-1220** Remove the front door

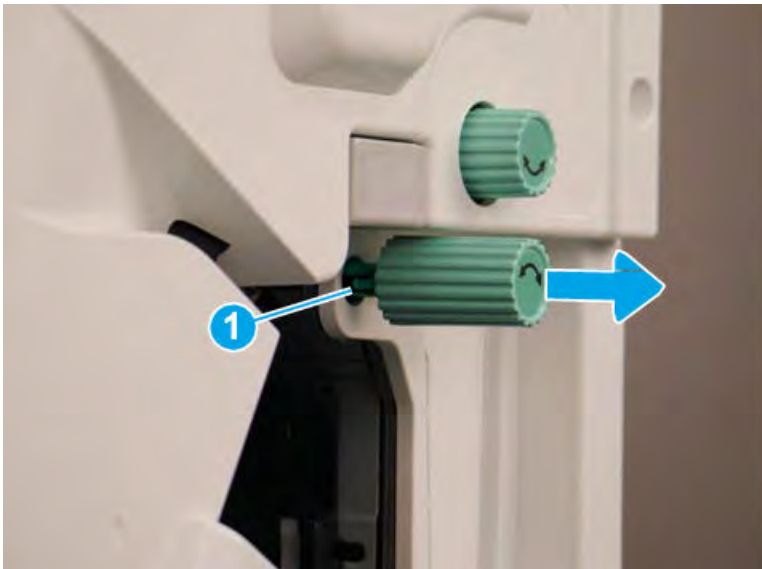


#### Remove the front cover (finisher)

Follow these steps to remove the front cover (finisher).

1. Release one tab (callout 1), and then pull the jam-access knob away from the finisher to remove it.

**Figure 5-1221** Remove the jam-access knob



2. If the punch unit is installed, remove the punch waste bin (callout 1).

3. Remove one screw (callout 1) on top of the front cover.

Figure 5-1222 Remove one screw



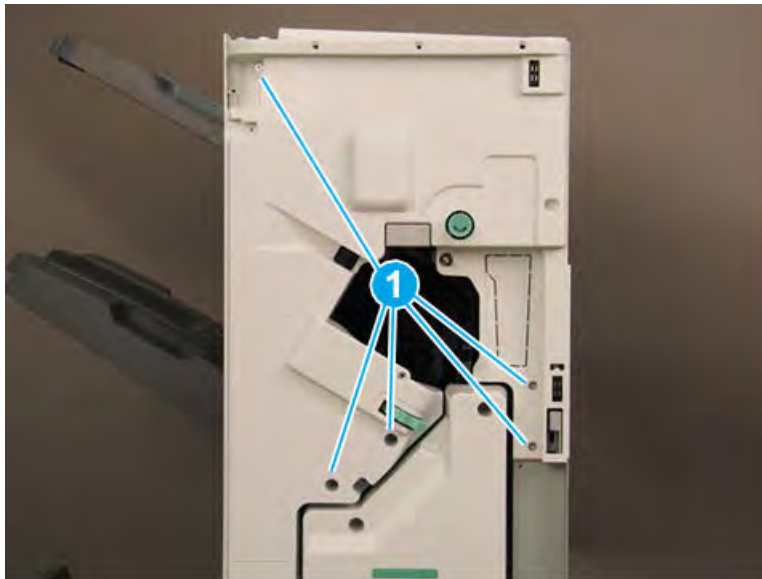
4. Remove five machine screws (callout 1), and then remove the front cover.

---

 **TIP:** Reverse the removal steps to install the assembly.

---

Figure 5-1223 Remove the front cover



### Remove the rear cover (finisher)

Follow these steps to remove the rear cover (finisher).

1. Remove two self-tapping screws (callout 1) on the top of the rear cover, and then remove five screw caps and five machine screws (callout 2) on the left side of the cover.

Figure 5-1224 Remove seven screws

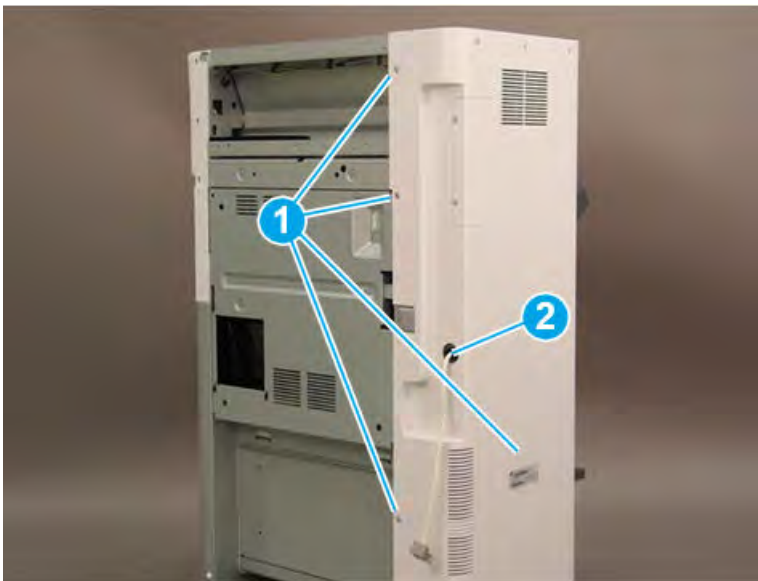


2. Remove one screw cap and four machine screws (callout 1) Remove the rear cover.

 **NOTE:** Make sure to thread the power cable (callout 2) through the opening in the cover.

 **TIP:** Reverse the removal steps to install the assembly

Figure 5-1225 Remove the rear cover



### Remove the booklet output tray

Follow these steps to remove the booklet output tray.

1. Raise the booklet output tray up (callout 1), and then pull it away from the finisher (callout 2) to remove it.

Figure 5-1226 Remove the booklet output tray



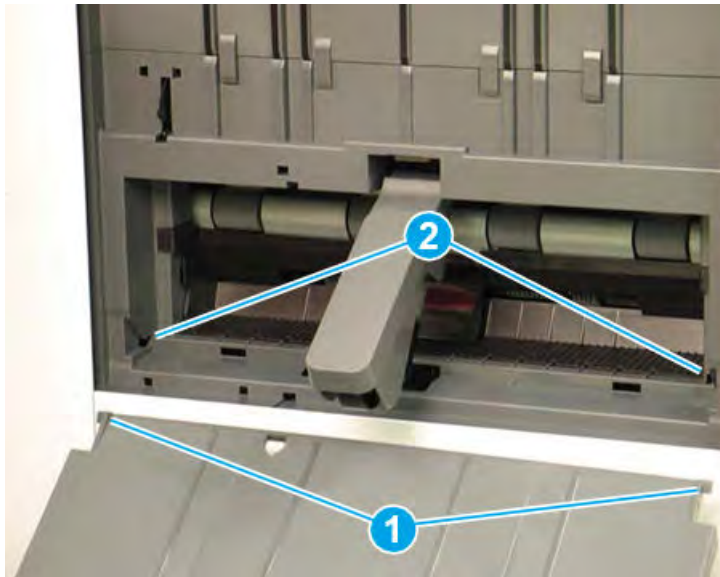
2. Reverse the removal steps to install the assembly. Also use the following special installation instructions.

 **NOTE:** Continue to reverse the removal steps to finish installing the assembly

Special installation instructions: booklet output tray

Position the tabs (callout 1) on the tray into the slots (callout 2) on the finisher.

Figure 5-1227 Install the booklet output tray

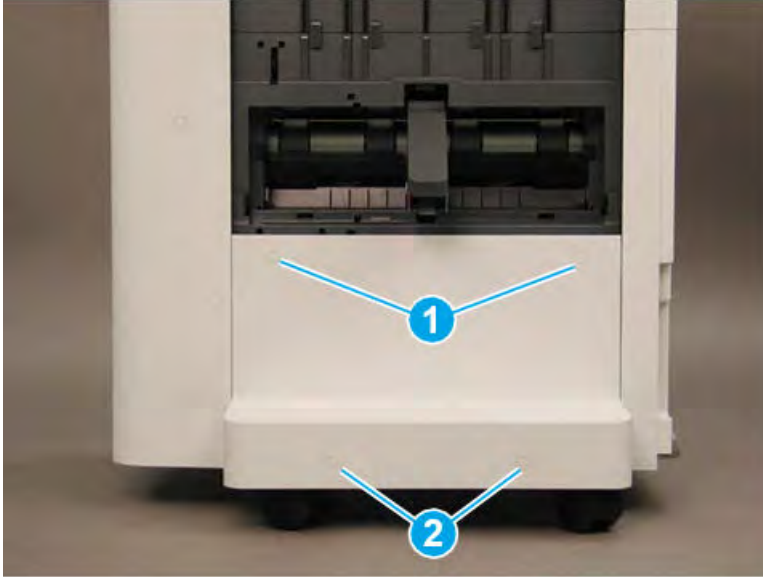


### Remove the caster cover

Follow these steps to remove the caster cover.


1. Remove two screw caps and two self-tapping screws (callout 1). Remove two screw caps and two machine screws (callout 2).

Figure 5-1228 Remove four screws



2. Rotate the left edge of the cover away from the finisher (callout 1), and then slide the cover to the left (callout 2) to remove it.

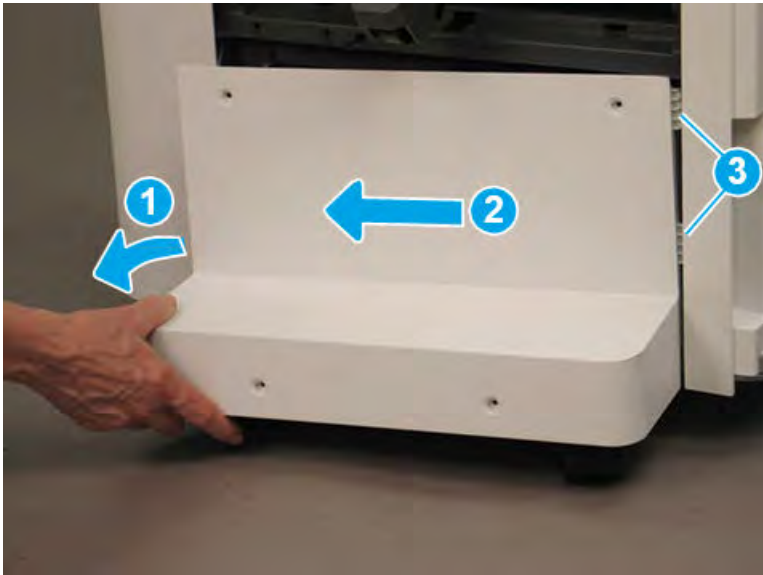
---

 **TIP:** Make sure that two tabs (callout 3) are positioned under the front lower cover when reinstalling the caster cover.

**TIP:** Reverse the removal steps to install the assembly

---

Figure 5-1229 Remove the caster cover




### Remove the left lower cover (finisher)

Follow these steps to remove the left lower cover (finisher).

1. Remove four screws (callout 1).

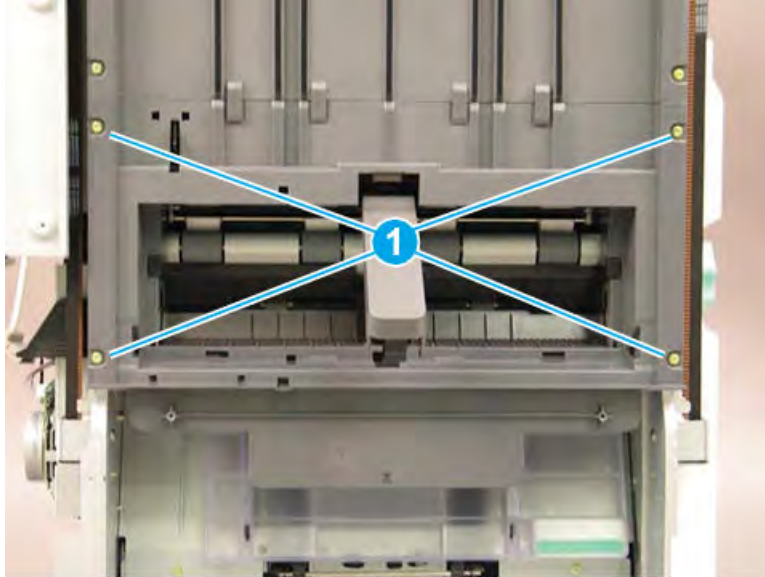
---

 **NOTE:** Raise the lower output tray as needed to access the screws.

---



Figure 5-1230 Remove four screws

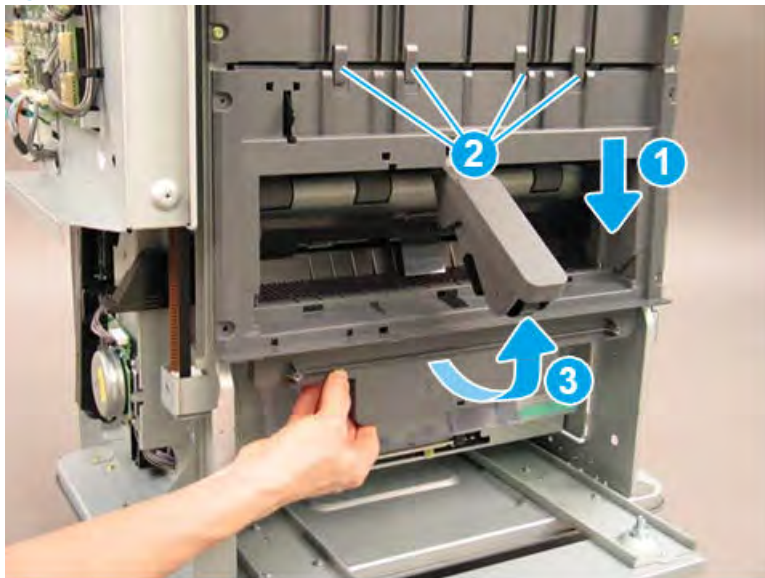


2. Slide the shield down (callout 1) to release it from four tabs (callout 2), and then rotate it away from the finisher (callout 3).


**⚠ CAUTION:** The shield is still attached to the finisher. Do not attempt to completely remove the shield.

**💡 TIP:** Position the shield under the four tabs (callout 2) when reinstalling it.

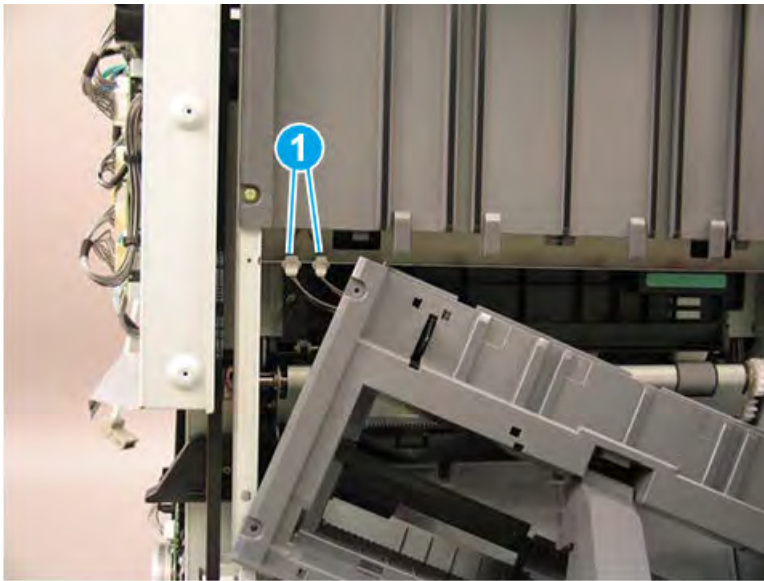
Figure 5-1231 Release the lower shield



3. Disconnect two connectors (callout 1), and then remove the shield.

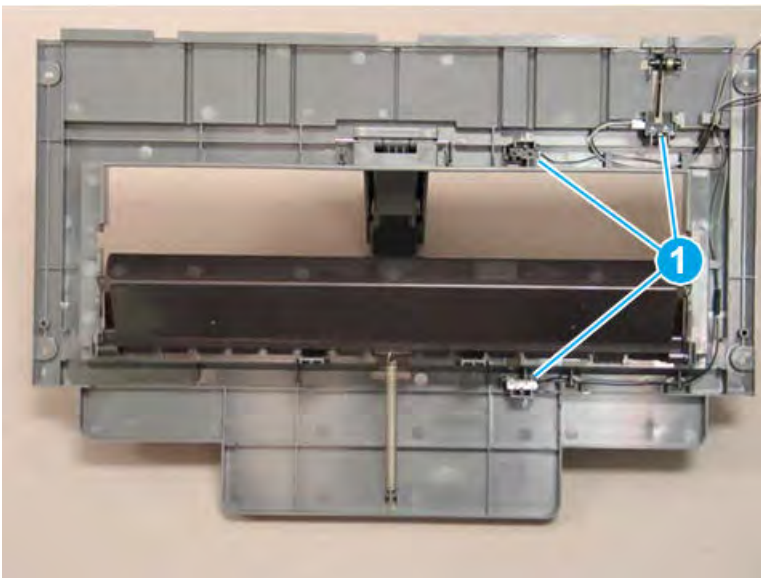
 **TIP:** Reverse the removal steps to install the assembly.

**Figure 5-1232** Disconnect two connectors



4. If you are replacing the left lower cover, locate three sensors (callout 1) on the back of the left lower cover. Remove these sensors and transfer them to the replacement part.

**Figure 5-1233** Remove the left lower cover

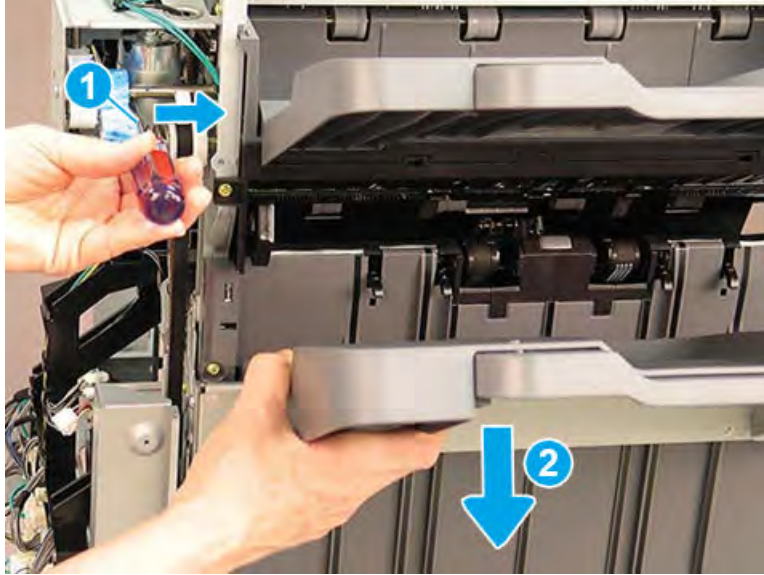


### Remove the left upper cover (finisher)

Follow these steps to remove the left upper cover (finisher).

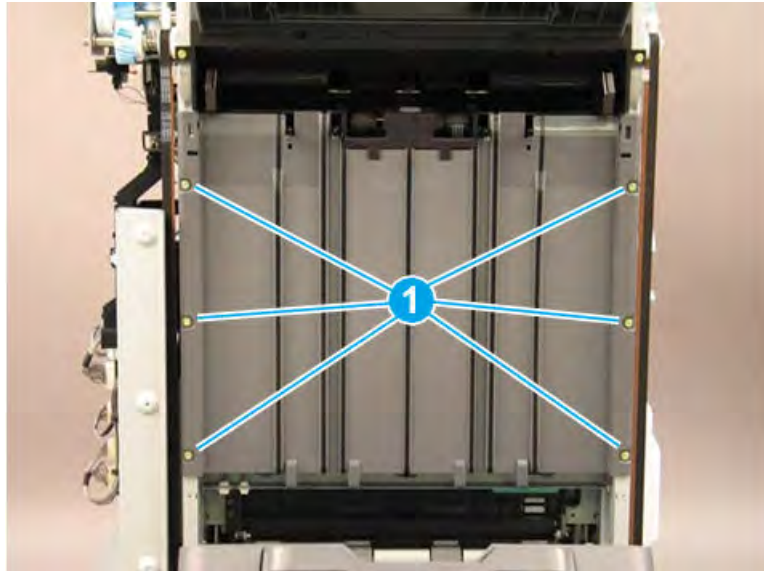
1. Bring the lower output tray down by positioning the shaft of a screwdriver on the clutch (callout 1) and gently pressing to the right to release the clutch. Hold the clutch in the released position and lower the tray (callout 2) to the lowest position.

Figure 5-1234 Lower the output tray



2. Remove six machine screws (callout 1).

Figure 5-1235 Remove six screws

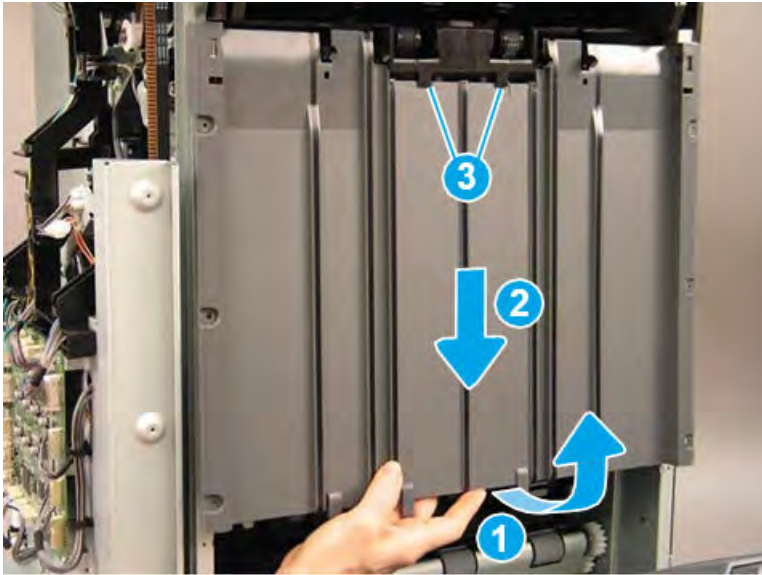


3. Rotate the lower edge of the shield away from the finisher (callout 1), and then slide the shield down (callout 2) to release it from two tabs (callout 3).

**CAUTION:** The shield is still attached to the finisher. Do not attempt to completely remove the shield.

**TIP:** Position the shield under the two tabs (callout 3) when reinstalling it.

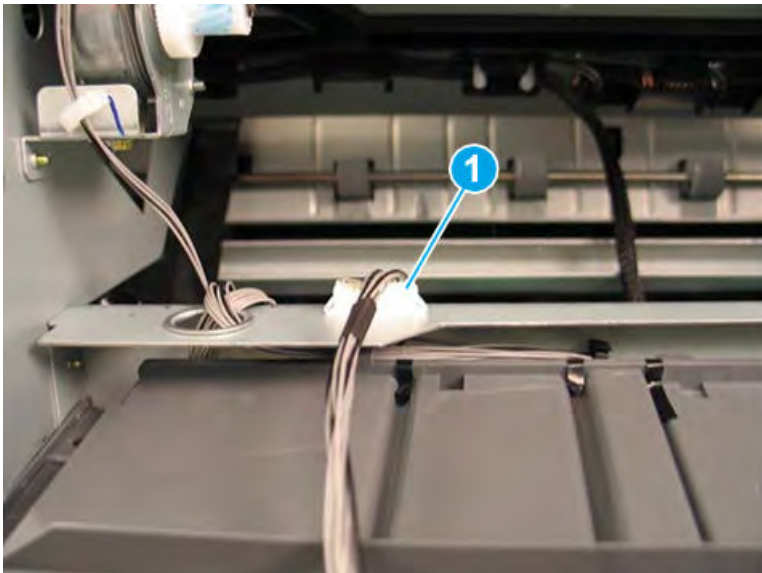
**Figure 5-1236** Release the shield



4. Disconnect one connector (callout 1), and then remove the upper shield assembly.

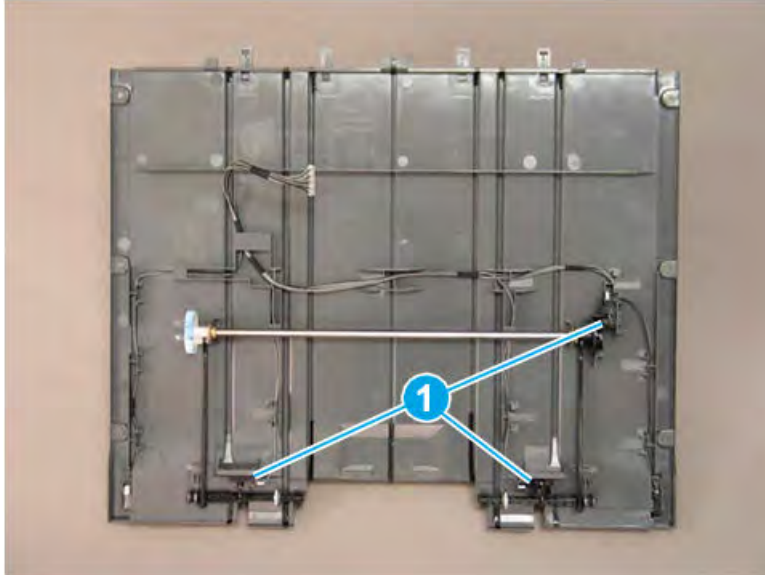
**TIP:** Reverse the removal steps to install the assembly.

**Figure 5-1237** Disconnect one connector



5. If you are replacing the left upper cover, locate three sensors (callout 1) on the back of the left upper cover. Remove these sensors and transfer them to the replacement part.

Figure 5-1238 Remove the left upper cover

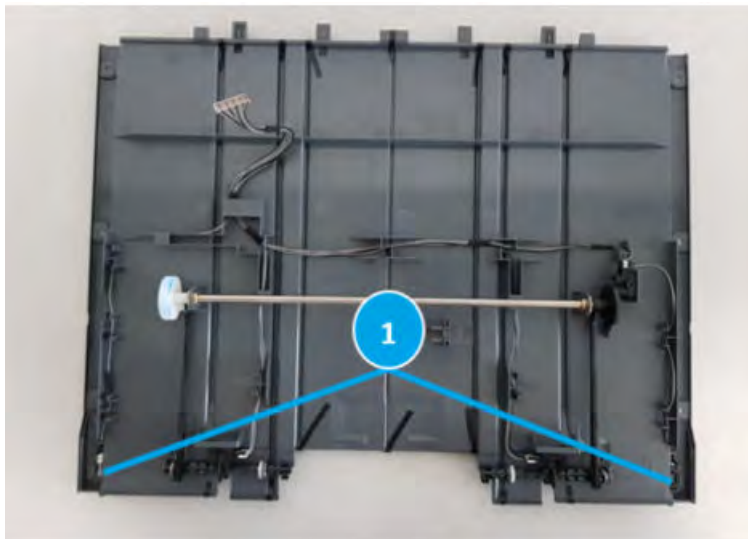


#### Remove the main output tray top of stack sensor(S20)

Follow these steps to remove the main output tray top of stack sensor(S20).

- ▲ Remove detector and emitter sensor(S20, callout 1)

Figure 5-1239 Remove detector and emitter sensor



## Unpack the replacement assembly

Follow these steps to unpack the replacement assembly.

1. Dispose of the defective part.




**NOTE:** HP recommends responsible disposal of the defective part.

<http://www8.hp.com/us/en/hp-information/environment/product-recycling.html>

---

2. Unpack the replacement part from the packaging.



**CAUTION:**  Some parts are sensitive to electrostatic discharge (ESD). Always perform service work at an ESD-protected workstation or mat. If an ESD workstation or mat is not available, touch the sheet-metal chassis to provide a static ground before touching an ESD-sensitive assembly. Protect the ESD-sensitive assemblies by placing them in ESD pouches when they are out of the printer.



**IMPORTANT:** Make sure that all of the shipping materials (for example shipping tape) are removed from the replacement part prior to installation.



**NOTE:** If the replacement part is a roller or pad, avoid touching the spongy part of it. Skin oils on the roller or pad can cause paper pickup and/or print-quality problems. HP recommends using disposable gloves when handling rollers or pads or washing your hands before touching rollers or pads.

---

3. To install an assembly, reverse the removal steps.



**NOTE:** When applicable, special installation instructions are provided for an assembly at the end of the removal procedure. Always completely read the removal instructions and follow all special installation instructions.


---

## Removal and replacement: Main output tray top of stack switch (S34)

Learn how to remove and replace the main output tray top of stack switch.

### Introduction

This document provides the procedures to remove and replace the main output tray top of stack switch on the finisher.

 **IMPORTANT:** When applicable, special installation instructions are provided for an assembly at the end of the removal procedure. Always completely read the removal instructions and follow all special installation instructions.

### Before performing service

- Turn the printer power off. A shutting-down message appears on the control-panel display.
- ⚠ **WARNING!** To avoid damage to the printer, turn the power off and wait until the printer shuts down before removing the power cable.
- Disconnect the printer power cable after the printer has completely shut down (the control-panel display is blank).
- Release the finisher from the printer by pulling out on the release latch inside the finisher door.
- Disconnect the cable from the bridge unit to the finisher.
- Disconnect the cable from the finisher to the printer.

Use the table below to identify the correct part number for your printer. To order the part, go to <https://parts.hp.com>.

**Table 5-133 Part information**

Part number	Part description
JC39-02316A	Main output tray top of stack switch

### Required tools

- #2 JIS screwdriver with a magnetic tip
- Small, flat-blade screwdriver

### After performing service

- Connect the cable from the finisher to the printer.
- Connect the cable from the bridge unit to the finisher.
- Attach the finisher to the printer, and then push in on the release latch inside the finisher door.
- Connect the printer power cable.
- Turn the printer power on.

## Post service test

Process a job through the finisher and verify that the finisher works correctly.

## Remove the right upper cover (finisher)

Follow these steps to remove the right upper cover (finisher).

- ▲ Remove one screw cap and three machine screws on the upper edge of the cover (callout 1). Remove three sheet metal screws (callout 2) on the lower portion of the cover. Rotate the right edge of the cover away from the finisher, and then slide the cover right to release three tabs (callout 3).

---

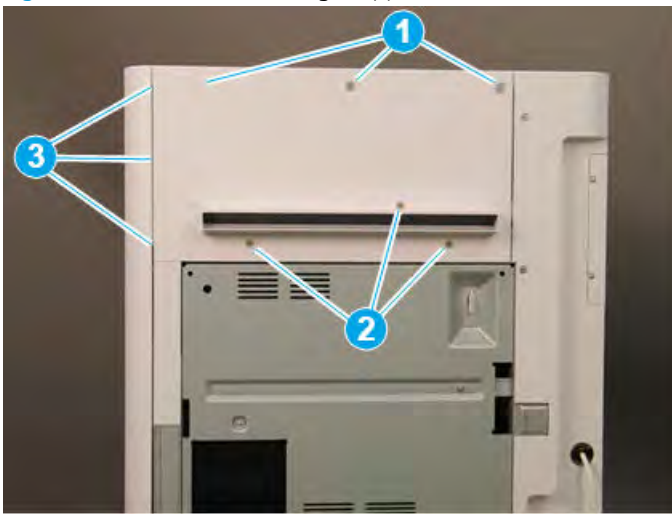
💡 **TIP:** The lower screws are shorter in length than the upper screws.

---

**TIP:** Reverse the removal steps to install the assembly.

---

**Figure 5-1240** Remove the right upper cover



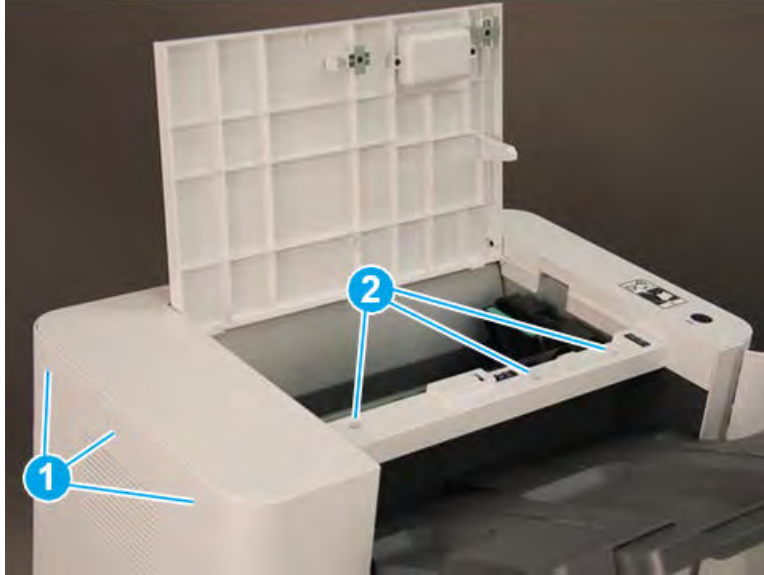
## Remove the top cover (finisher)

Follow these steps to remove the top cover (finisher).

1. Remove three screw caps and three self-tapping screws at the top of the rear cover (callout 1), and then remove three machine screws (callout 2) on top of the cover.

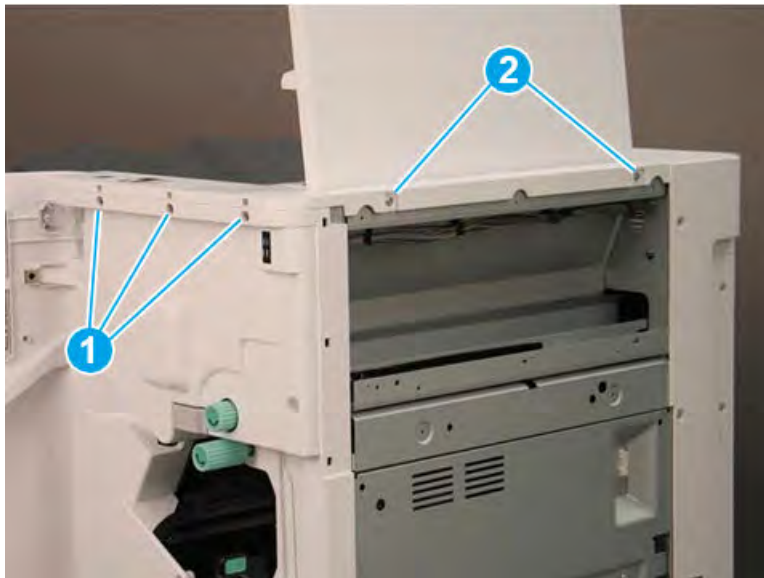


Figure 5-1241 Remove six screws




2. Remove three self-tapping screws at the top of the front cover (callout 1), and then remove two machine screws (callout 2) at the top of the right side.

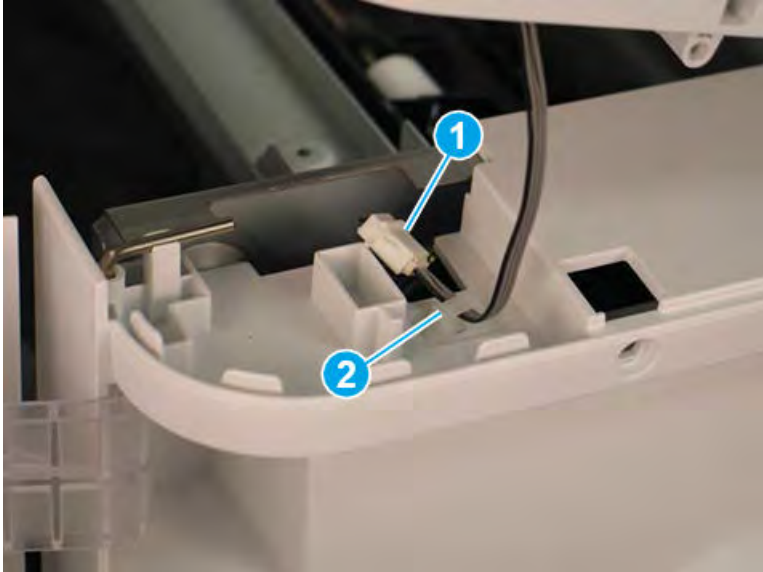
Figure 5-1242 Remove five screws



3. Lift the cover up slightly. Disconnect one in-line connector (callout 1), and then release one retainer (callout 2).

 **TIP:** Reverse the removal steps to install the assembly.

**Figure 5-1243** Disconnect one connector and release retainer

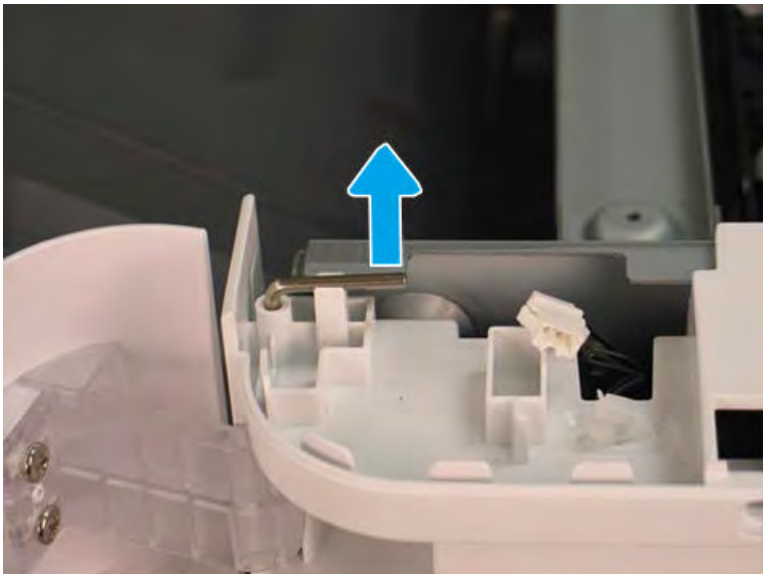


#### Remove the front door (finisher)

Follow these steps to remove the front door (finisher).

1. Lift the top hinge pin up to release it from the retainer.

**Figure 5-1244** Lift the top hinge pin



2. Pull the top hinge pin up to remove it.

Figure 5-1245 Remove the top hinge pin



3. Use a small, flat-blade screwdriver to release the lower hinge pin from the retainer, and then rotate it away from the finisher.

Figure 5-1246 Release the lower hinge pin




4. Support the door with one hand, and then pull the lower hinge pin straight up to remove it.

Figure 5-1247 Remove the lower hinge pin



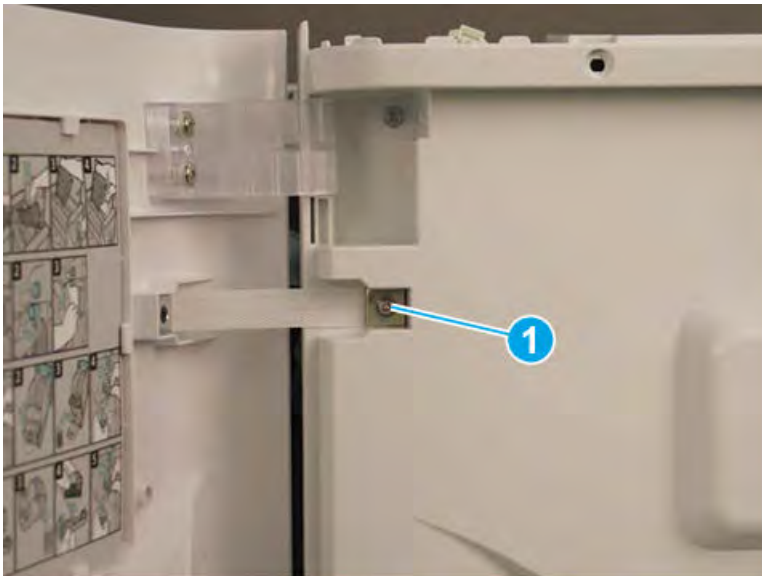
5. Support the door with one hand, and then remove one screw (callout 1) to release the strap. Remove the front door.

---

 **TIP:** Reverse the removal steps to install the assembly.

---

Figure 5-1248 Remove the front door

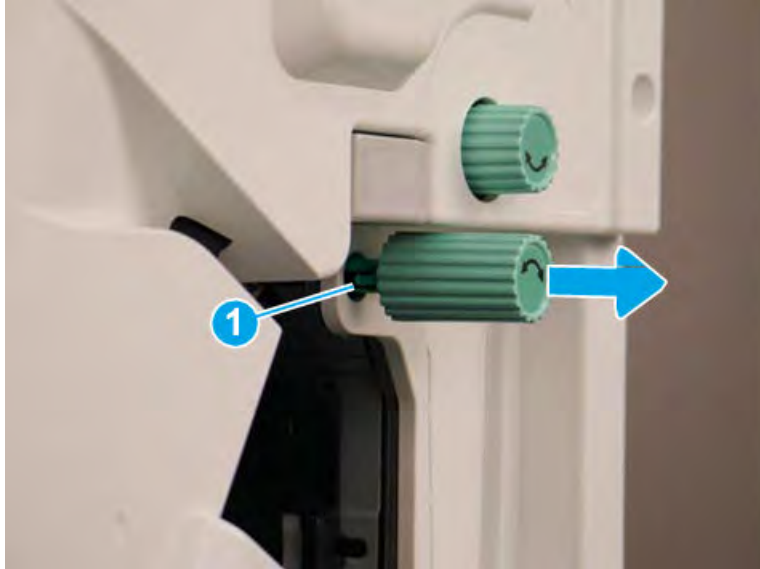


### Remove the front cover (finisher)

Follow these steps to remove the front cover (finisher).

1. Release one tab (callout 1), and then pull the jam-access knob away from the finisher to remove it.

Figure 5-1249 Remove the jam-access knob



2. If the punch unit is installed, remove the punch waste bin (callout 1).
3. Remove one screw (callout 1) on top of the front cover.

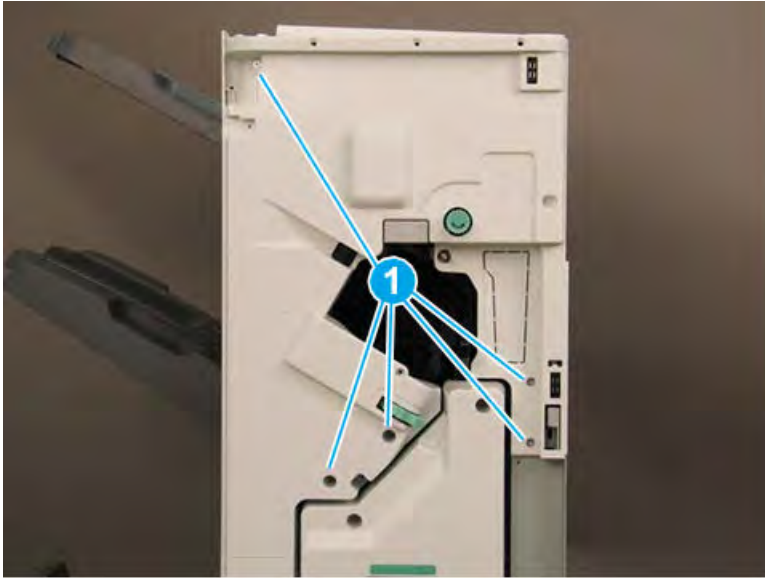
Figure 5-1250 Remove one screw



4. Remove five machine screws (callout 1), and then remove the front cover.

 **TIP:** Reverse the removal steps to install the assembly.

**Figure 5-1251** Remove the front cover

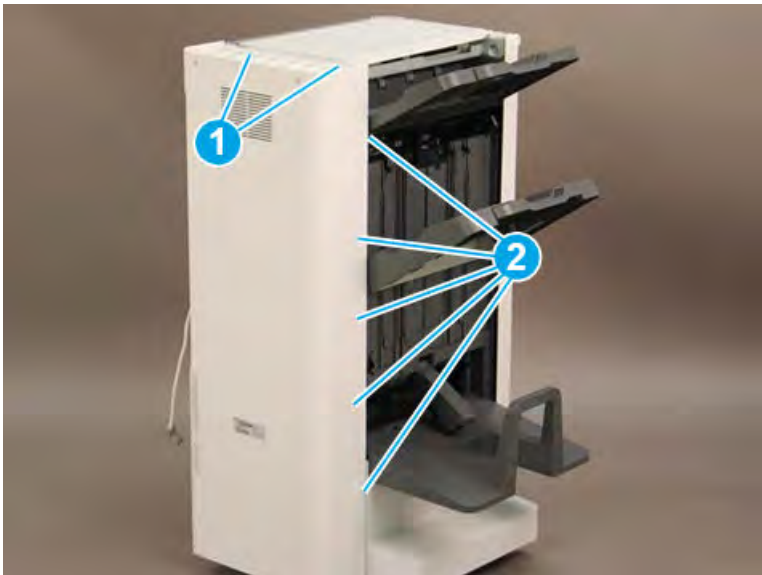


#### Remove the rear cover (finisher)

Follow these steps to remove the rear cover (finisher).


1. Remove two self-tapping screws (callout 1) on the top of the rear cover, and then remove five screw caps and five machine screws (callout 2) on the left side of the cover.

**Figure 5-1252** Remove seven screws

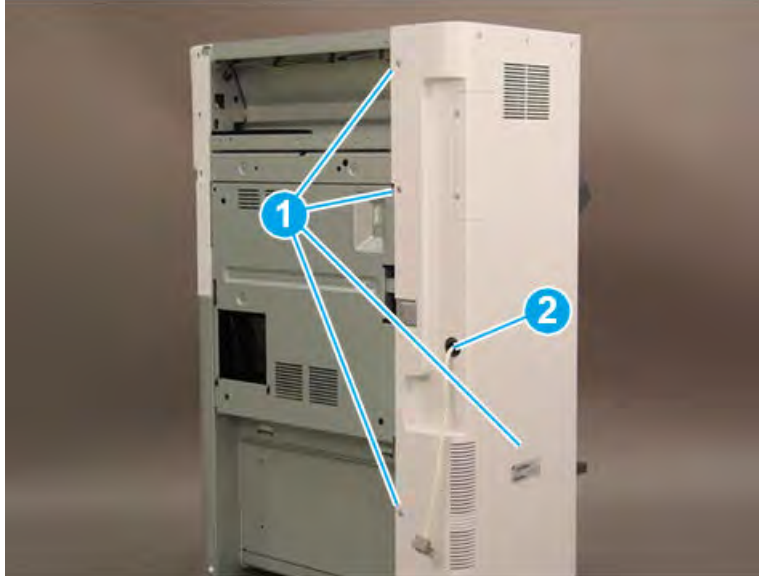


2. Remove one screw cap and four machine screws (callout 1) Remove the rear cover.

 **NOTE:** Make sure to thread the power cable (callout 2) through the opening in the cover.

 **TIP:** Reverse the removal steps to install the assembly

**Figure 5-1253** Remove the rear cover

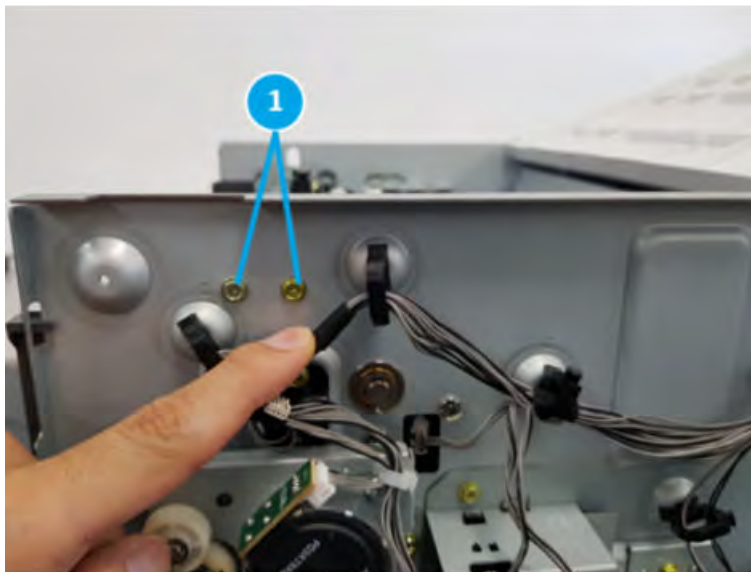


#### Remove the main output tray of stack switch(S34)

Follow these steps to remove the main output tray of stack switch(S34).

1. At the front of the finisher, remove two screws(callout 1).

**Figure 5-1254** Remove two screws



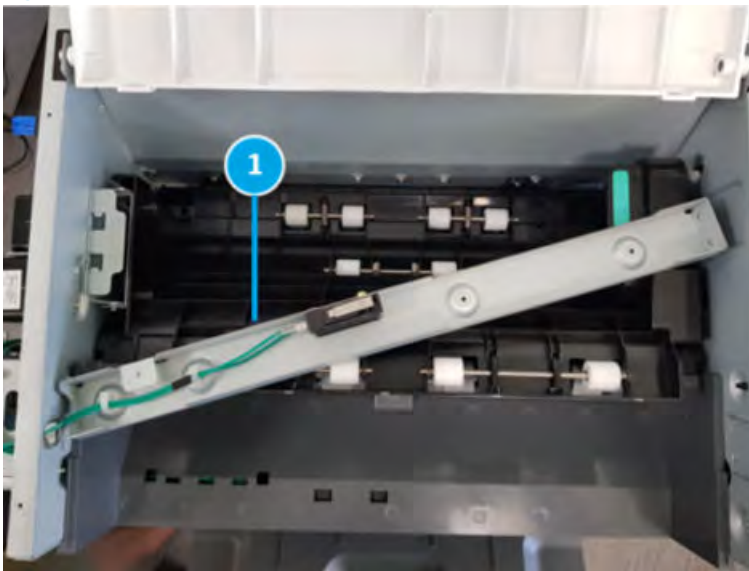
2. At the rear of the finisher, remove two screws(callout 1).

Figure 5-1255 Remove two screws



3. Do not remove the frame(callout 1) but pull it one side.

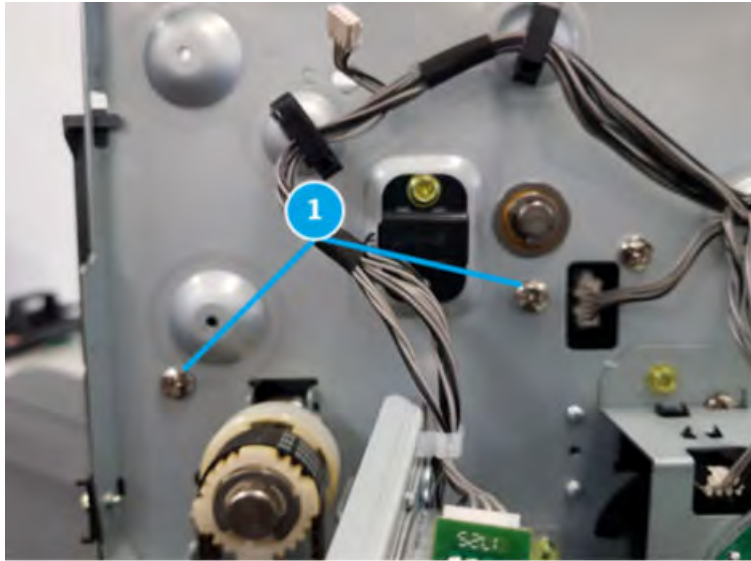
Figure 5-1256 Pull it one side





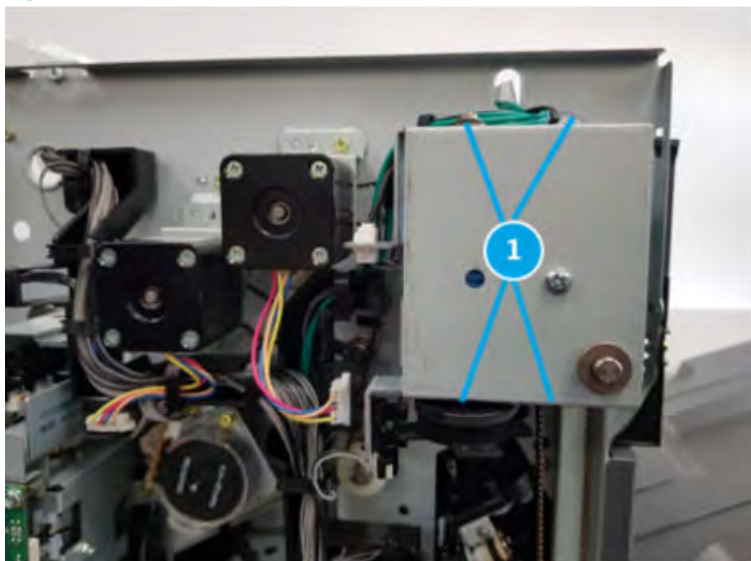
4. At the front of the finisher, remove two screws(callout 1)

Figure 5-1257 Remove two screws



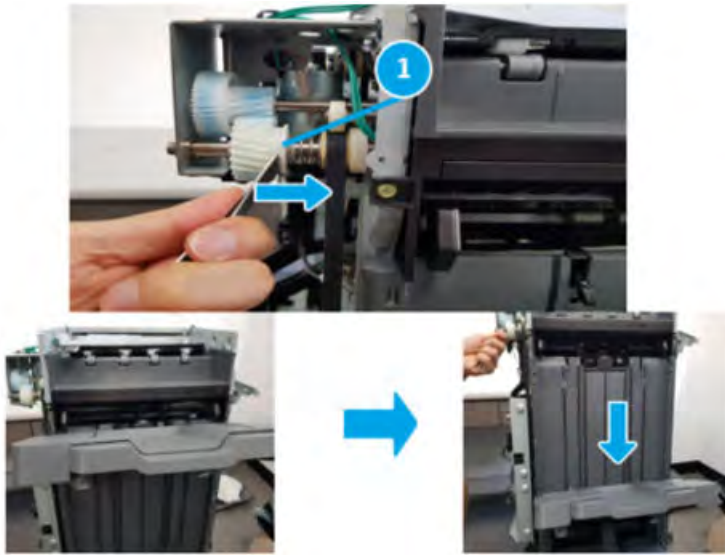
5. At the rear of the finisher, remove four screws(callout 1).

Figure 5-1258 Remove four screws



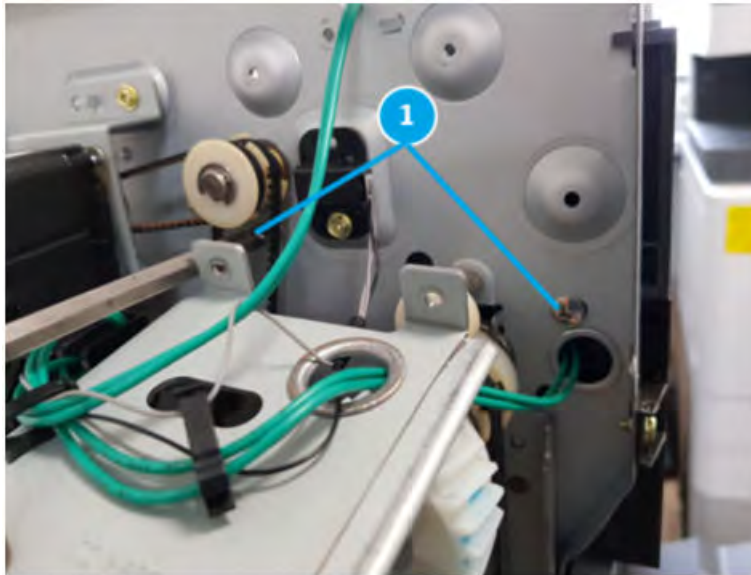
6. Bring the lower output tray down by positioning the shaft of a screwdriver or tweezers on the clutch (callout 1) and gently pressing to the right to release the clutch. Hold the clutch in the released position and lower the tray (callout 2) to the lowest position

Figure 5-1259 Pressing to the right to release the clutch



7. At the rear of the finisher, remove two screws (callout 1).

Figure 5-1260 Remove two screws



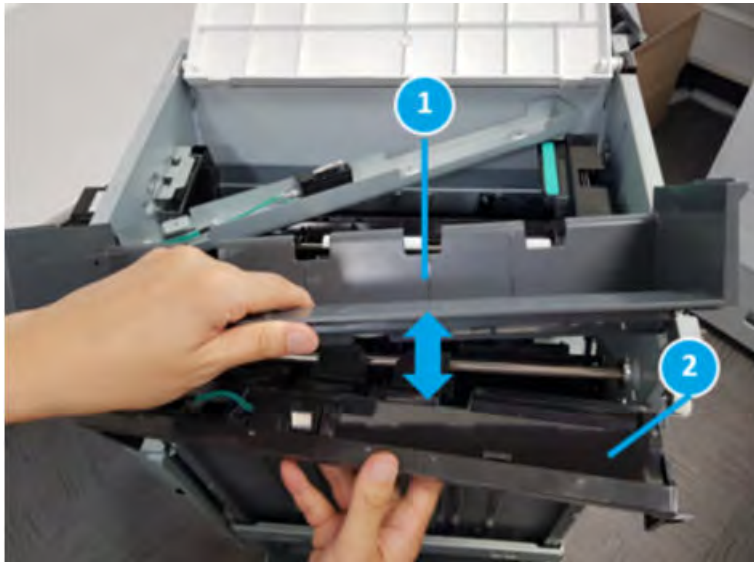
8. Remove two screws(callout 1)

Figure 5-1261 Remove two screws



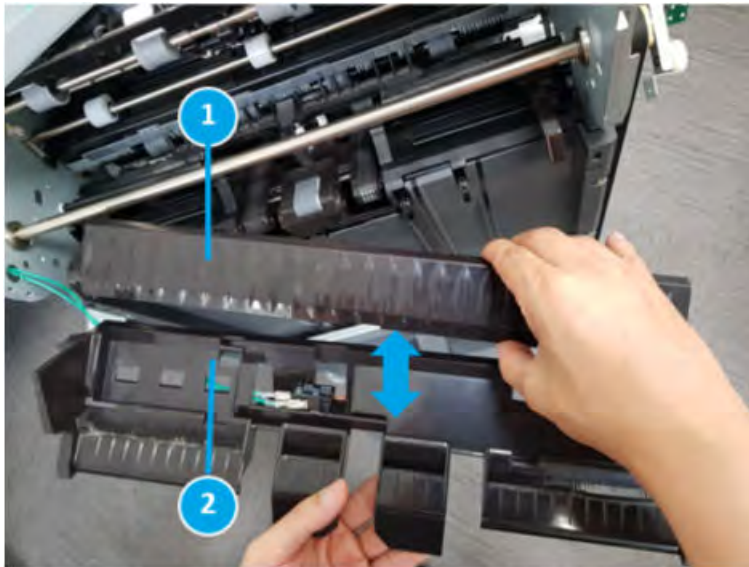
9. Separate two parts (callout 1,callout 2)

Figure 5-1262 Separate two parts



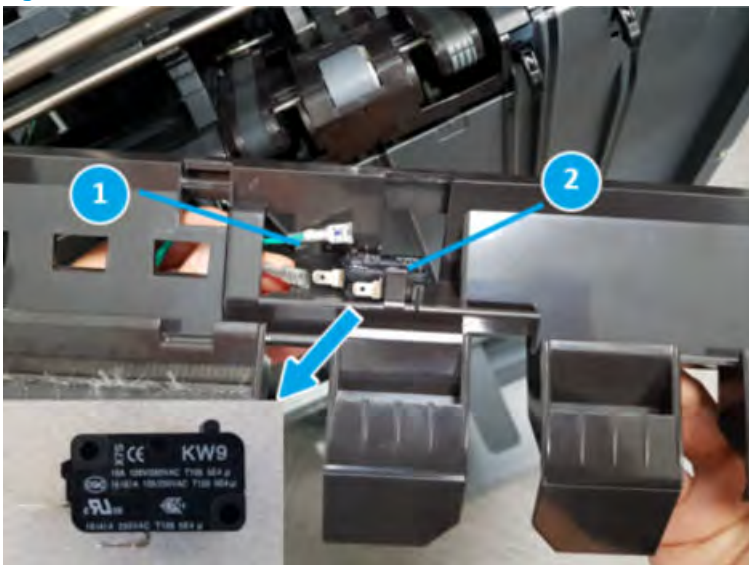
10. Separate two parts (callout 1, callout 2)

Figure 5-1263 Separate two parts



11. Disconnect the connector (callout 1) and switch (callout 2, S34)

Figure 5-1264 Disconnect the connector



### Unpack the replacement assembly

Follow these steps to unpack the replacement assembly.

1. Dispose of the defective part.



---

 **NOTE:** HP recommends responsible disposal of the defective part.


<http://www8.hp.com/us/en/hp-information/environment/product-recycling.html>

---

2. Unpack the replacement part from the packaging.


 **CAUTION:**  Some parts are sensitive to electrostatic discharge (ESD). Always perform service work at an ESD-protected workstation or mat. If an ESD workstation or mat is not available, touch the sheet-metal chassis to provide a static ground before touching an ESD-sensitive assembly. Protect the ESD-sensitive assemblies by placing them in ESD pouches when they are out of the printer.

 **IMPORTANT:** Make sure that all of the shipping materials (for example shipping tape) are removed from the replacement part prior to installation.

 **NOTE:** If the replacement part is a roller or pad, avoid touching the spongy part of it. Skin oils on the roller or pad can cause paper pickup and/or print-quality problems. HP recommends using disposable gloves when handling rollers or pads or washing your hands before touching rollers or pads.

---

3. To install an assembly, reverse the removal steps.

 **NOTE:** When applicable, special installation instructions are provided for an assembly at the end of the removal procedure. Always completely read the removal instructions and follow all special installation instructions.


---

## Removal and replacement: Main output tray lower limit sensor (S26)

Learn how to remove and replace the main output tray lower limit sensor.

### Introduction

This document provides the procedures to remove and replace the main output tray lower limit sensor on the finisher.

 **IMPORTANT:** When applicable, special installation instructions are provided for an assembly at the end of the removal procedure. Always completely read the removal instructions and follow all special installation instructions.

### Before performing service

- Turn the printer power off. A shutting-down message appears on the control-panel display.
- ⚠ **WARNING!** To avoid damage to the printer, turn the power off and wait until the printer shuts down before removing the power cable.
- Disconnect the printer power cable after the printer has completely shut down (the control-panel display is blank).
- Release the finisher from the printer by pulling out on the release latch inside the finisher door.
- Disconnect the cable from the bridge unit to the finisher.
- Disconnect the cable from the finisher to the printer.

Use the table below to identify the correct part number for your printer. To order the part, go to <https://parts.hp.com>.

**Table 5-134** Part information

Part number	Part description
0604-001415	Main output tray lower limit sensor

### Required tools

- #2 JIS screwdriver with a magnetic tip
- Small, flat-blade screwdriver

### After performing service

- Connect the cable from the finisher to the printer.
- Connect the cable from the bridge unit to the finisher.
- Attach the finisher to the printer, and then push in on the release latch inside the finisher door.
- Connect the printer power cable.
- Turn the printer power on.

## Post service test

Process a job through the finisher and verify that the finisher works correctly.

## Remove the right upper cover (finisher)

Follow these steps to remove the right upper cover (finisher).

- ▲ Remove one screw cap and three machine screws on the upper edge of the cover (callout 1). Remove three sheet metal screws (callout 2) on the lower portion of the cover. Rotate the right edge of the cover away from the finisher, and then slide the cover right to release three tabs (callout 3).

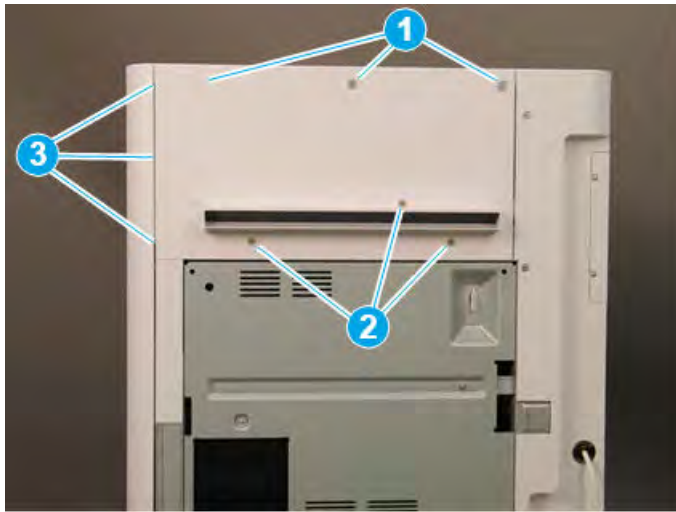
---

💡 **TIP:** The lower screws are shorter in length than the upper screws.

**TIP:** Reverse the removal steps to install the assembly.

---

**Figure 5-1265** Remove the right upper cover

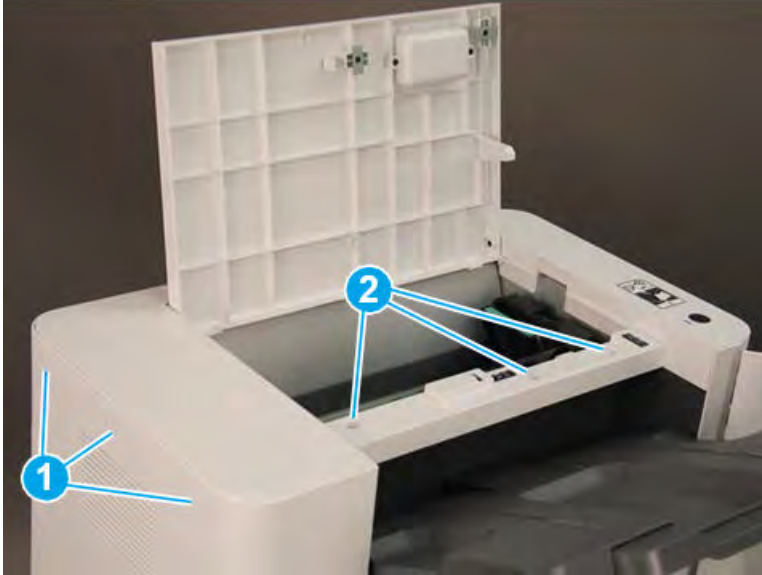


## Remove the top cover (finisher)

Follow these steps to remove the top cover (finisher).

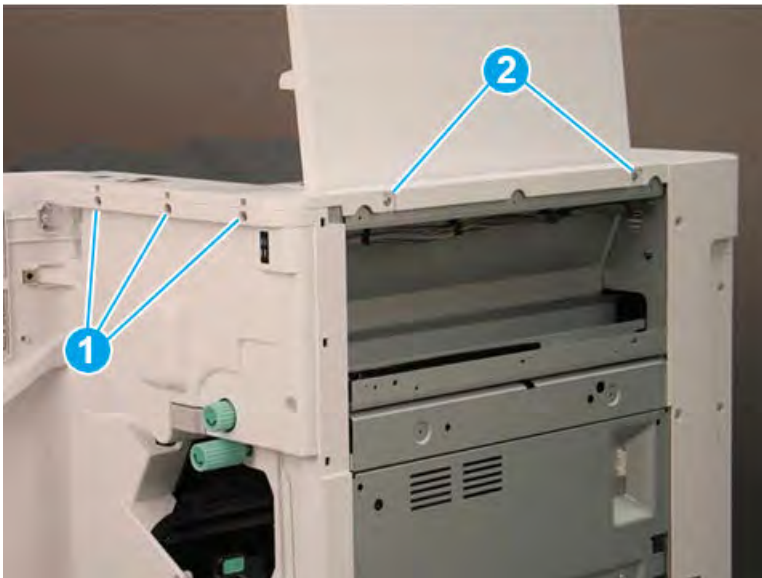
1. Remove three screw caps and three self-tapping screws at the top of the rear cover (callout 1), and then remove three machine screws (callout 2) on top of the cover.

Figure 5-1266 Remove six screws




2. Remove three self-tapping screws at the top of the front cover (callout 1), and then remove two machine screws (callout 2) at the top of the right side.

Figure 5-1267 Remove five screws

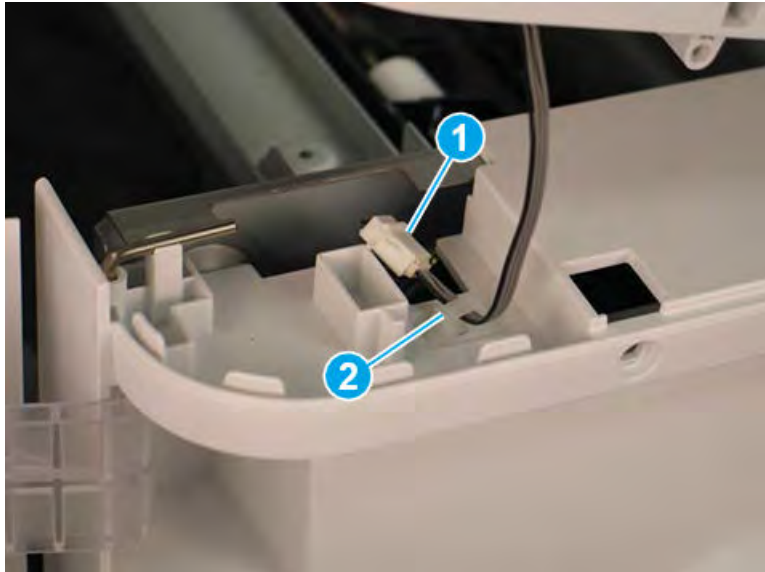




3. Lift the cover up slightly. Disconnect one in-line connector (callout 1), and then release one retainer (callout 2).

 **TIP:** Reverse the removal steps to install the assembly.

**Figure 5-1268** Disconnect one connector and release retainer

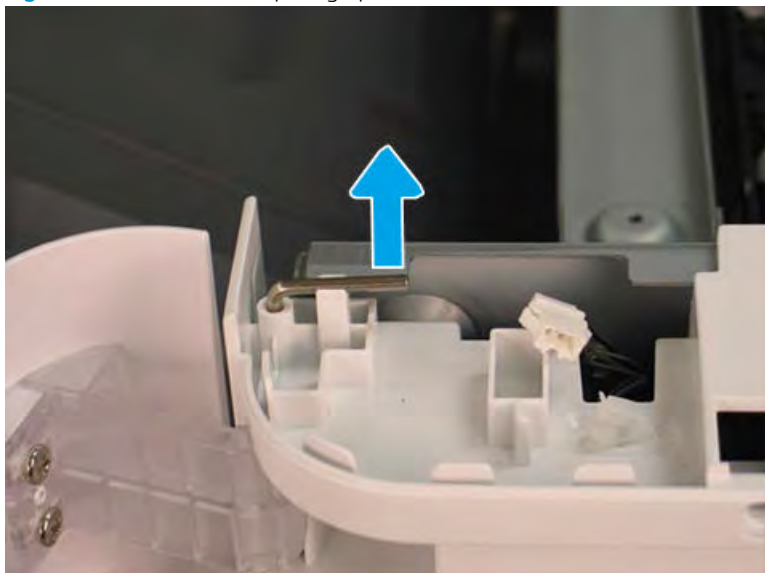


#### Remove the front door (finisher)

Follow these steps to remove the front door (finisher).

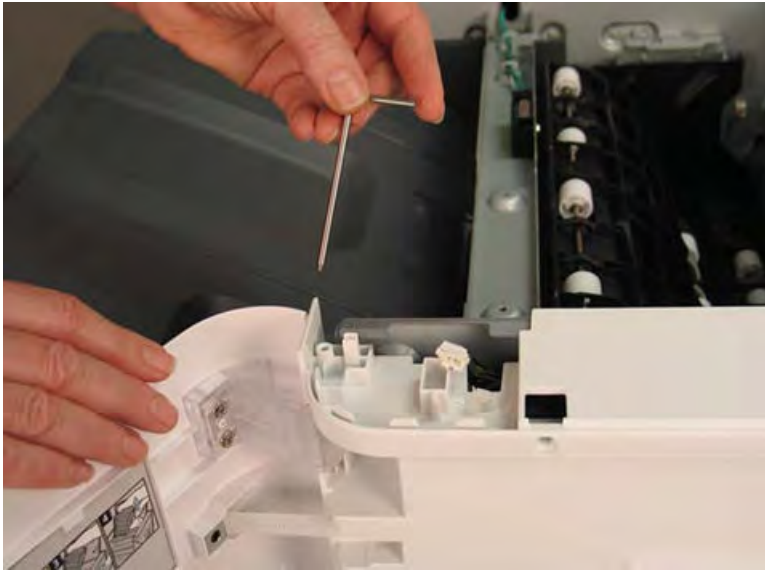
1. Lift the top hinge pin up to release it from the retainer.

**Figure 5-1269** Lift the top hinge pin



2. Pull the top hinge pin up to remove it.

Figure 5-1270 Remove the top hinge pin



3. Use a small, flat-blade screwdriver to release the lower hinge pin from the retainer, and then rotate it away from the finisher.

Figure 5-1271 Release the lower hinge pin




4. Support the door with one hand, and then pull the lower hinge pin straight up to remove it.

Figure 5-1272 Remove the lower hinge pin



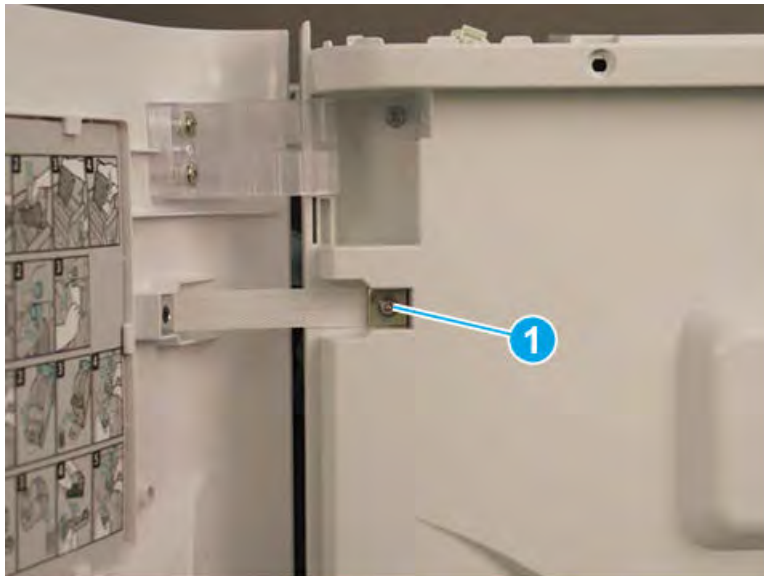
5. Support the door with one hand, and then remove one screw (callout 1) to release the strap. Remove the front door.

---

 **TIP:** Reverse the removal steps to install the assembly.

---

Figure 5-1273 Remove the front door

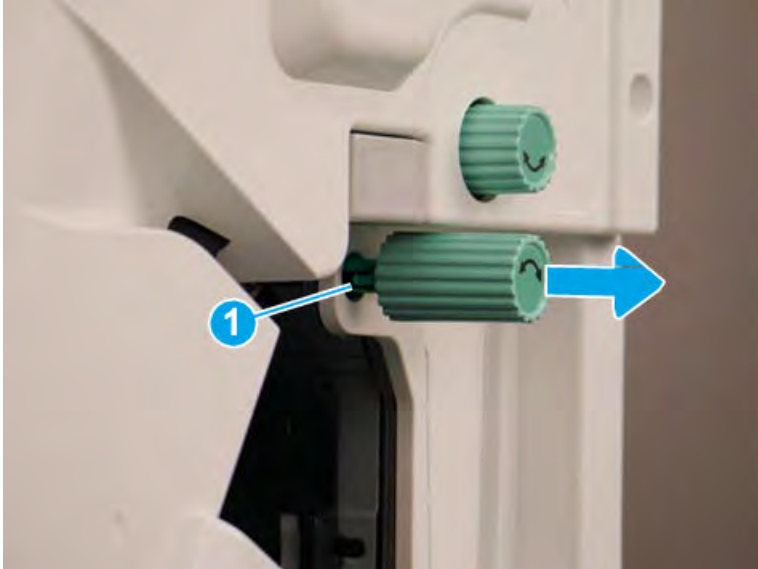


### Remove the front cover (finisher)

Follow these steps to remove the front cover (finisher).

1. Release one tab (callout 1), and then pull the jam-access knob away from the finisher to remove it.

Figure 5-1274 Remove the jam-access knob




2. If the punch unit is installed, remove the punch waste bin (callout 1).
3. Remove one screw (callout 1) on top of the front cover.

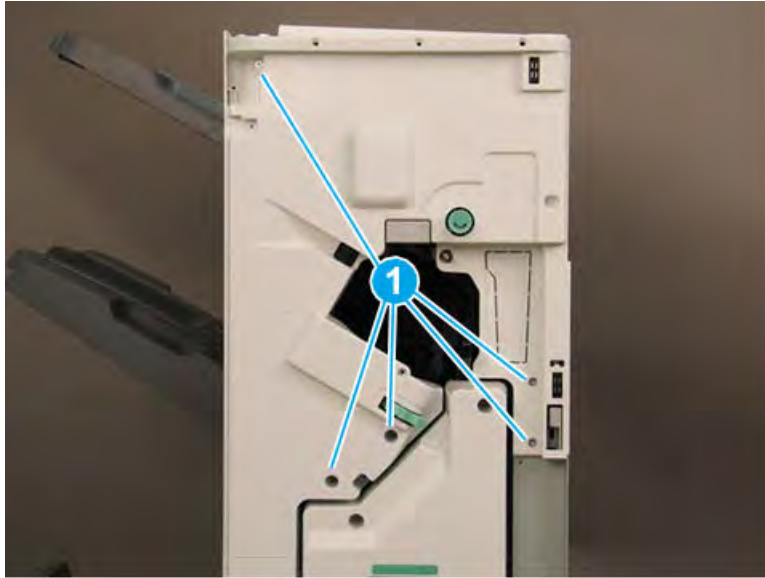
Figure 5-1275 Remove one screw



4. Remove five machine screws (callout 1), and then remove the front cover.

 **TIP:** Reverse the removal steps to install the assembly.

**Figure 5-1276** Remove the front cover

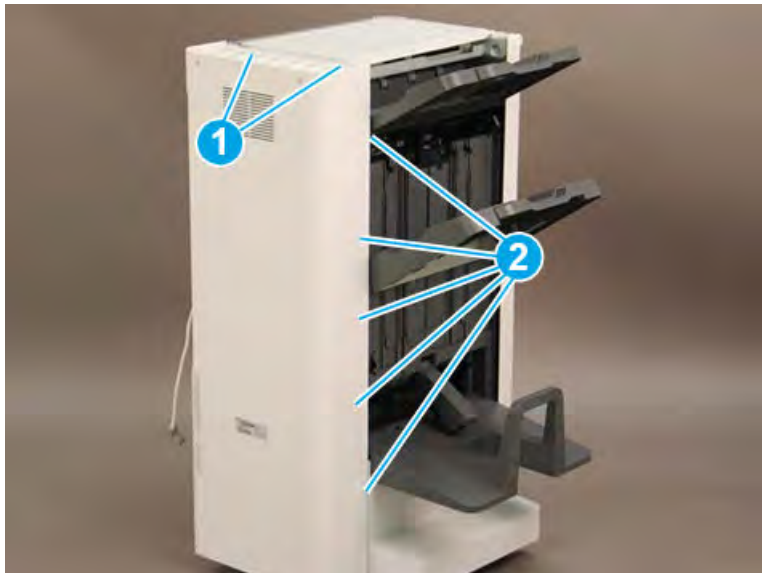


#### Remove the rear cover (finisher)

Follow these steps to remove the rear cover (finisher).


1. Remove two self-tapping screws (callout 1) on the top of the rear cover, and then remove five screw caps and five machine screws (callout 2) on the left side of the cover.

**Figure 5-1277** Remove seven screws

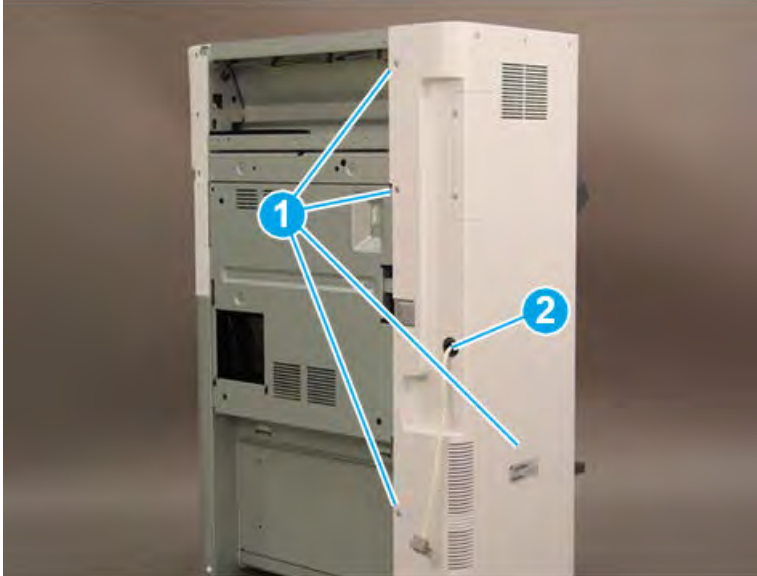


2. Remove one screw cap and four machine screws (callout 1) Remove the rear cover.

 **NOTE:** Make sure to thread the power cable (callout 2) through the opening in the cover.

 **TIP:** Reverse the removal steps to install the assembly

**Figure 5-1278** Remove the rear cover

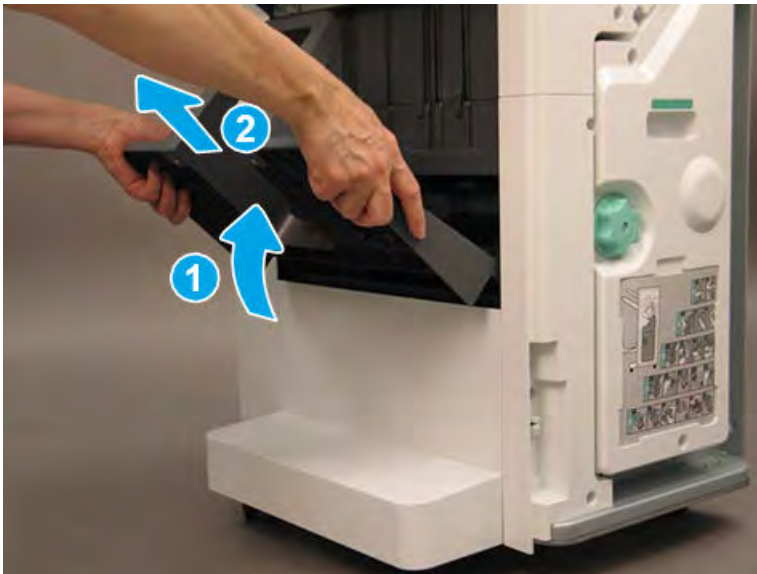


### Remove the booklet output tray

Follow these steps to remove the booklet output tray.

1. Raise the booklet output tray up (callout 1), and then pull it away from the finisher (callout 2) to remove it.

**Figure 5-1279** Remove the booklet output tray



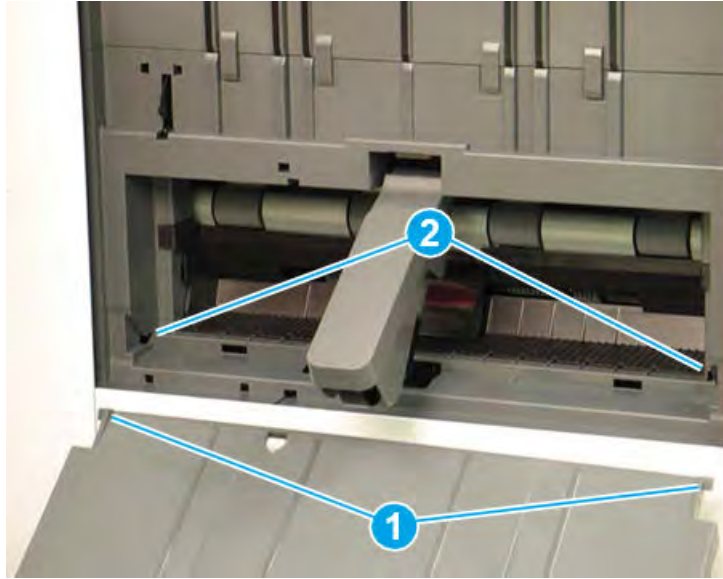
- Reverse the removal steps to install the assembly. Also use the following special installation instructions.

 **NOTE:** Continue to reverse the removal steps to finish installing the assembly

Special installation instructions: booklet output tray

Position the tabs (callout 1) on the tray into the slots (callout 2) on the finisher.

**Figure 5-1280** Install the booklet output tray

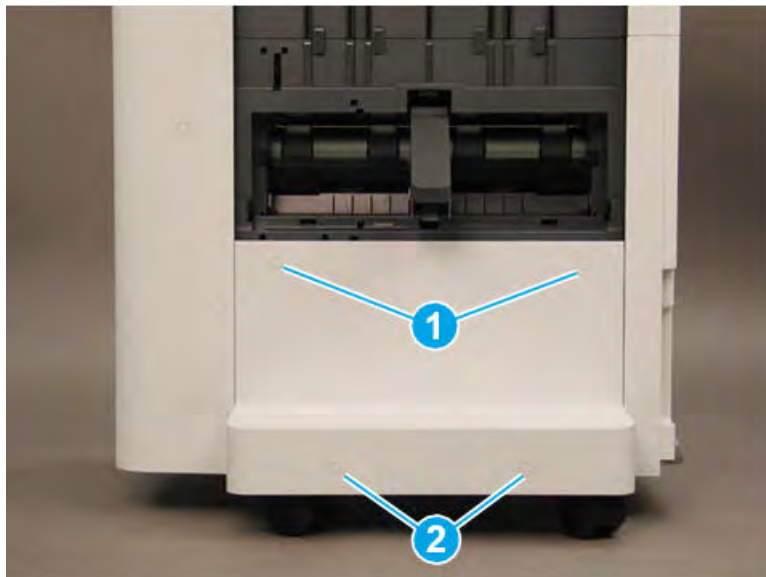


### Remove the caster cover

Follow these steps to remove the caster cover.


- Remove two screw caps and two self-tapping screws (callout 1). Remove two screw caps and two machine screws (callout 2).

**Figure 5-1281** Remove four screws



2. Rotate the left edge of the cover away from the finisher (callout 1), and then slide the cover to the left (callout 2) to remove it.

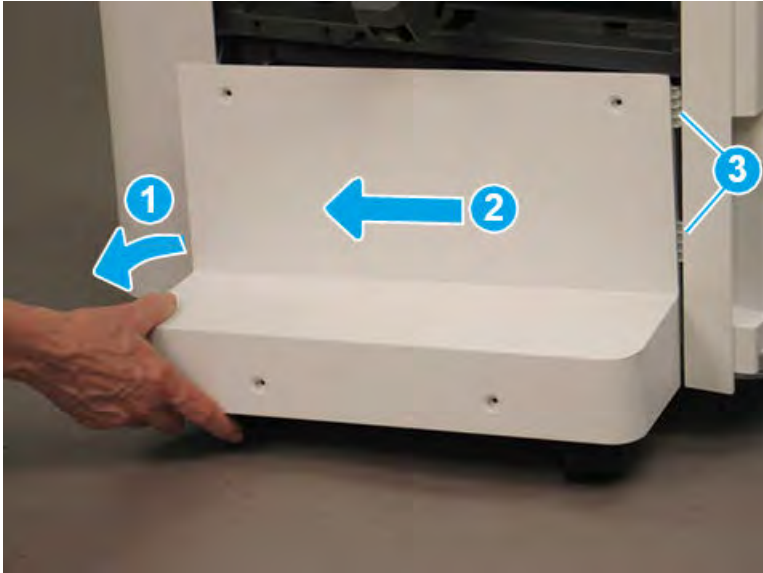
---

 **TIP:** Make sure that two tabs (callout 3) are positioned under the front lower cover when reinstalling the caster cover.

**TIP:** Reverse the removal steps to install the assembly

---

**Figure 5-1282** Remove the caster cover




#### Remove the left lower cover (finisher)

Follow these steps to remove the left lower cover (finisher).

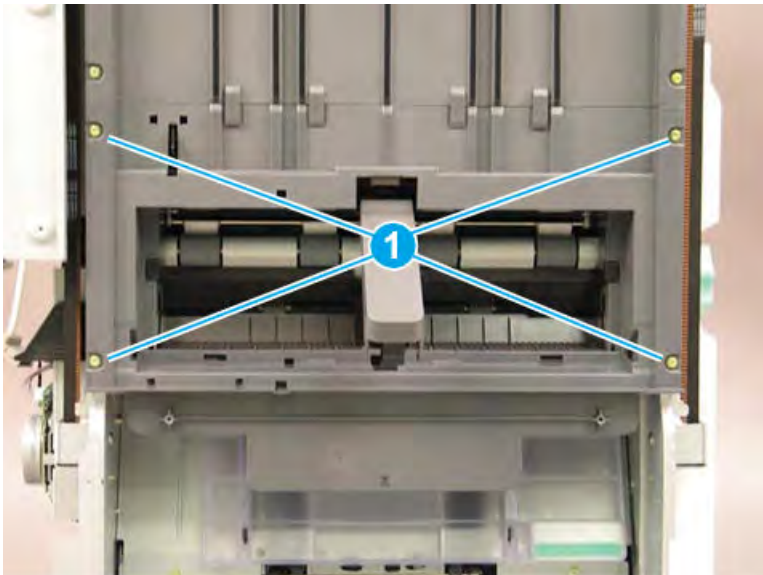
1. Remove four screws (callout 1).

---

 **NOTE:** Raise the lower output tray as needed to access the screws.

---

**Figure 5-1283** Remove four screws



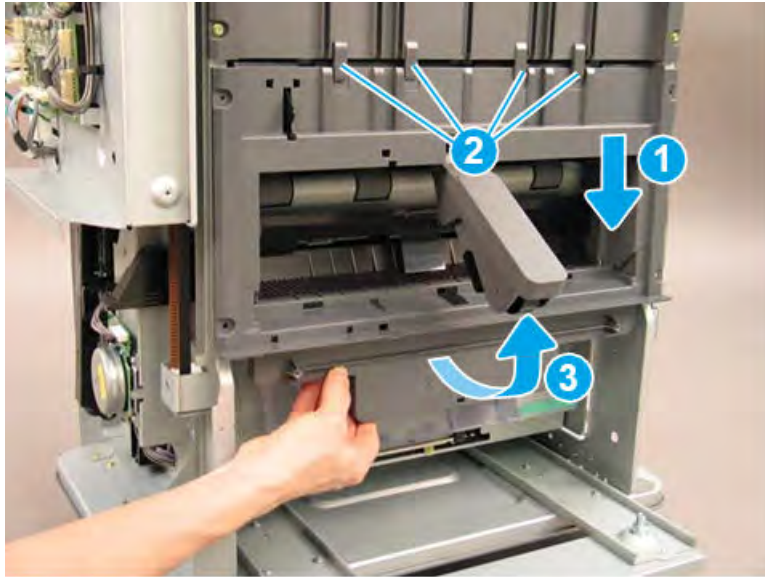


- Slide the shield down (callout 1) to release it from four tabs (callout 2), and then rotate it away from the finisher (callout 3).

**CAUTION:** The shield is still attached to the finisher. Do not attempt to completely remove the shield.

**TIP:** Position the shield under the four tabs (callout 2) when reinstalling it.

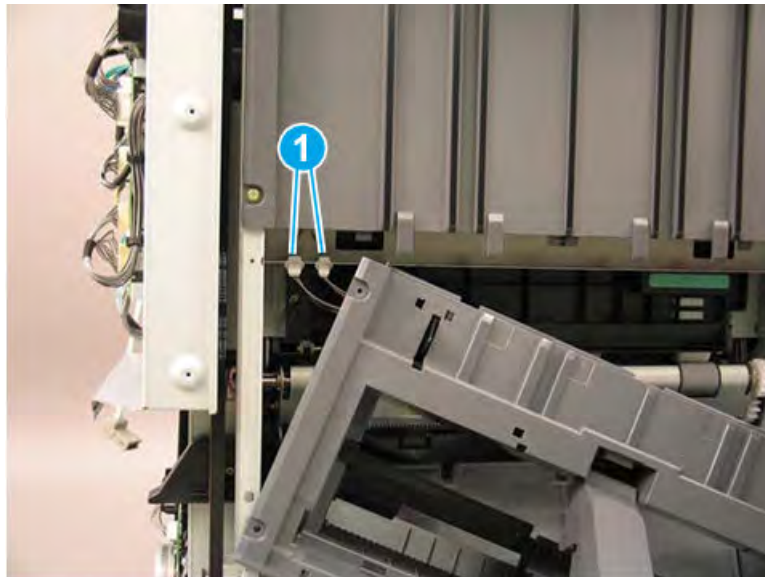
Figure 5-1284 Release the lower shield



- Disconnect two connectors (callout 1), and then remove the shield.

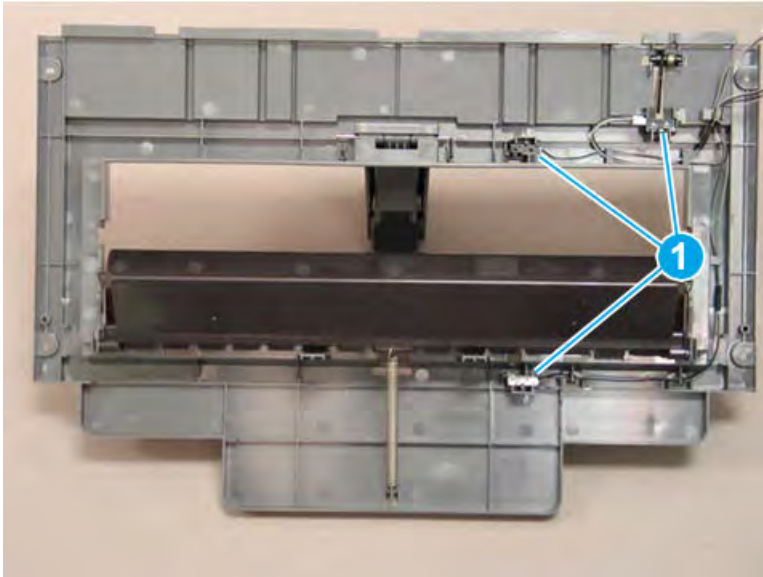
**TIP:** Reverse the removal steps to install the assembly.

Figure 5-1285 Disconnect two connectors



4. If you are replacing the left lower cover, locate three sensors (callout 1) on the back of the left lower cover. Remove these sensors and transfer them to the replacement part.

**Figure 5-1286** Remove the left lower cover



#### Remove the main output tray lower limit sensor(S26)

Follow these steps to remove the main output tray lower limit sensor(S26).

- ▲ Disconnect the connector(callout 1) and remove the sensor(S26, callout 2) from the lower shield assembly.

**Figure 5-1287** Remove the main output tray lower limit sensor



#### Unpack the replacement assembly

Follow these steps to unpack the replacement assembly.

1. Dispose of the defective part.



---

 **NOTE:** HP recommends responsible disposal of the defective part.


<http://www8.hp.com/us/en/hp-information/environment/product-recycling.html>

---

2. Unpack the replacement part from the packaging.


 **CAUTION:**  Some parts are sensitive to electrostatic discharge (ESD). Always perform service work at an ESD-protected workstation or mat. If an ESD workstation or mat is not available, touch the sheet-metal chassis to provide a static ground before touching an ESD-sensitive assembly. Protect the ESD-sensitive assemblies by placing them in ESD pouches when they are out of the printer.

 **IMPORTANT:** Make sure that all of the shipping materials (for example shipping tape) are removed from the replacement part prior to installation.

 **NOTE:** If the replacement part is a roller or pad, avoid touching the spongy part of it. Skin oils on the roller or pad can cause paper pickup and/or print-quality problems. HP recommends using disposable gloves when handling rollers or pads or washing your hands before touching rollers or pads.

---

3. To install an assembly, reverse the removal steps.

 **NOTE:** When applicable, special installation instructions are provided for an assembly at the end of the removal procedure. Always completely read the removal instructions and follow all special installation instructions.


---

## Removal and replacement: Main output tray motor sensor (S33)


Learn how to remove and replace the main output tray motor sensor.

### Introduction

This document provides the procedures to remove and replace the main output tray motor sensor on the finisher.

 **IMPORTANT:** When applicable, special installation instructions are provided for an assembly at the end of the removal procedure. Always completely read the removal instructions and follow all special installation instructions.

### Before performing service

- Turn the printer power off. A shutting-down message appears on the control-panel display.
-  **WARNING!** To avoid damage to the printer, turn the power off and wait until the printer shuts down before removing the power cable.
- Disconnect the printer power cable after the printer has completely shut down (the control-panel display is blank).
- Release the finisher from the printer by pulling out on the release latch inside the finisher door.
- Disconnect the cable from the bridge unit to the finisher.
- Disconnect the cable from the finisher to the printer.

Use the table below to identify the correct part number for your printer. To order the part, go to <https://parts.hp.com>.

**Table 5-135 Part information**

Part number	Part description
0604-001393	Main output tray motor sensor

### Required tools

- #2 JIS screwdriver with a magnetic tip

### After performing service

- Connect the cable from the finisher to the printer.
- Connect the cable from the bridge unit to the finisher.
- Attach the finisher to the printer, and then push in on the release latch inside the finisher door.
- Connect the printer power cable.
- Turn the printer power on.

### Post service test

Process a job through the finisher and verify that the finisher works correctly.

### Remove the right upper cover (finisher)

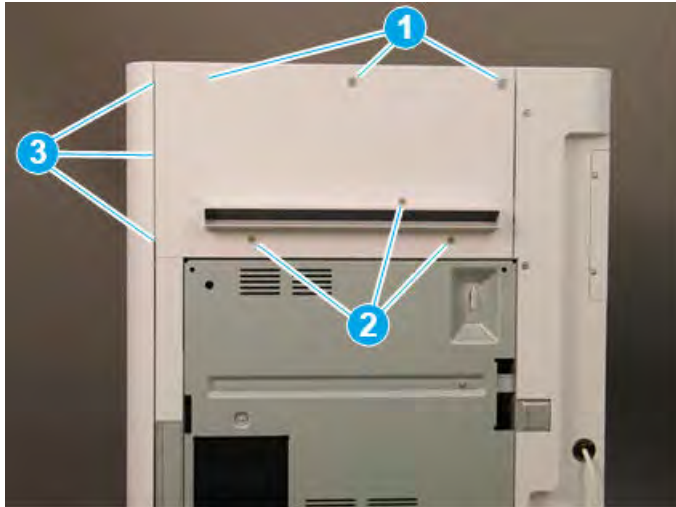
Follow these steps to remove the right upper cover (finisher).

- ▲ Remove one screw cap and three machine screws on the upper edge of the cover (callout 1). Remove three sheet metal screws (callout 2) on the lower portion of the cover. Rotate the right edge of the cover away from the finisher, and then slide the cover right to release three tabs (callout 3).

💡 **TIP:** The lower screws are shorter in length than the upper screws.

**TIP:** Reverse the removal steps to install the assembly.

Figure 5-1288 Remove the right upper cover

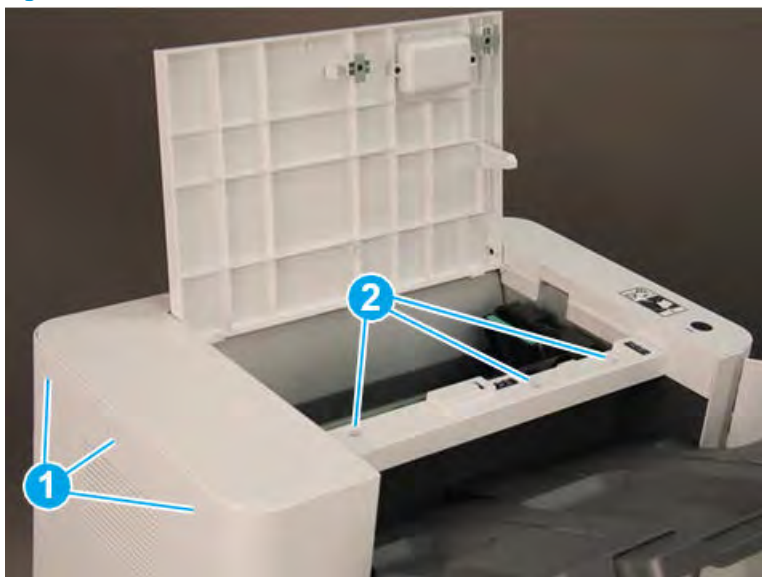


### Remove the top cover (finisher)

Follow these steps to remove the top cover (finisher).

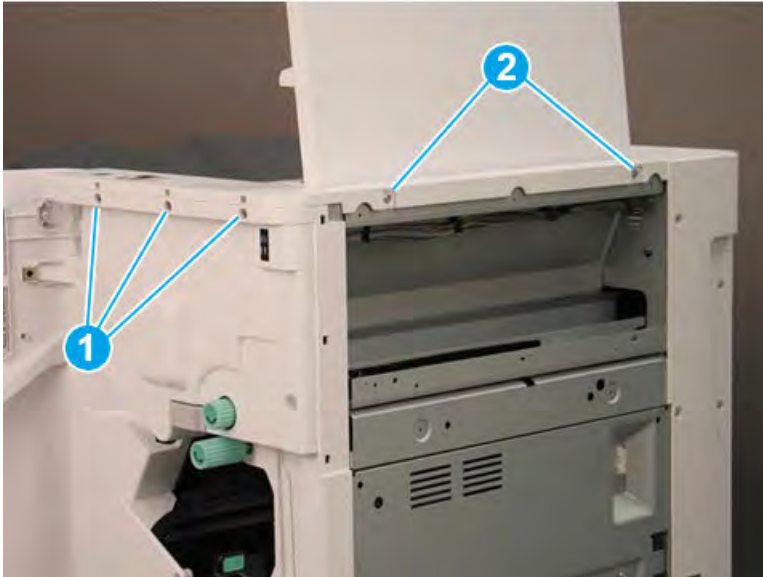
1. Remove three screw caps and three self-tapping screws at the top of the rear cover (callout 1), and then remove three machine screws (callout 2) on top of the cover.

Figure 5-1289 Remove six screws



2. Remove three self-tapping screws at the top of the front cover (callout 1), and then remove two machine screws (callout 2) at the top of the right side.

Figure 5-1290 Remove five screws



3. Lift the cover up slightly. Disconnect one in-line connector (callout 1), and then release one retainer (callout 2).


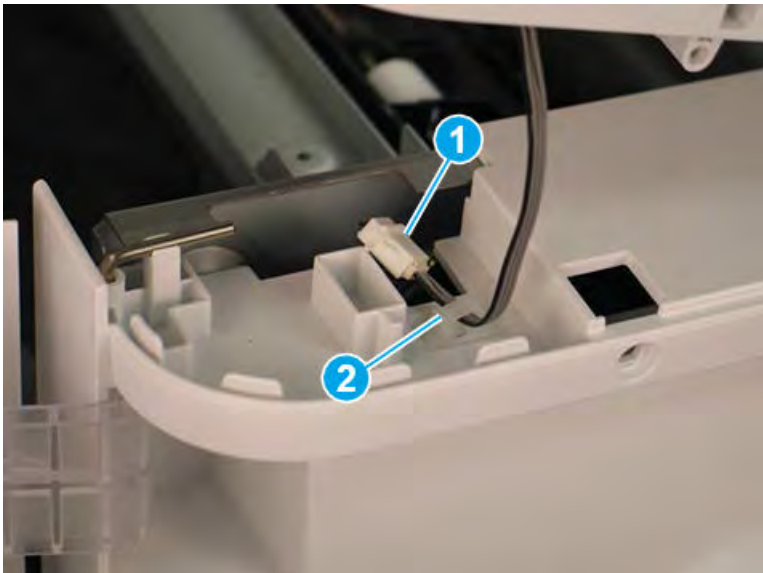
 **TIP:** Reverse the removal steps to install the assembly.

Figure 5-1291 Disconnect one connector and release retainer



### Remove the rear cover (finisher)

Follow these steps to remove the rear cover (finisher).

1. Remove two self-tapping screws (callout 1) on the top of the rear cover, and then remove five screw caps and five machine screws (callout 2) on the left side of the cover.

Figure 5-1292 Remove seven screws



2. Remove one screw cap and four machine screws (callout 1) Remove the rear cover.

 **NOTE:** Make sure to thread the power cable (callout 2) through the opening in the cover.


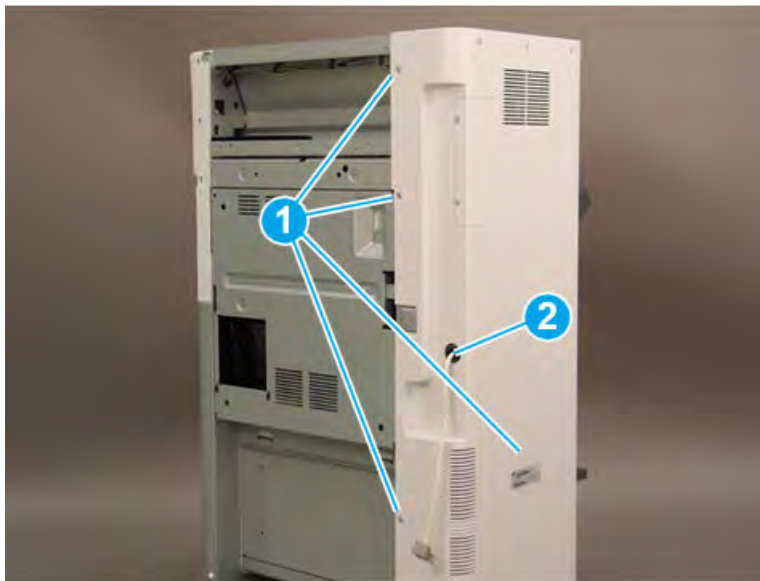
 **TIP:** Reverse the removal steps to install the assembly

Figure 5-1293 Remove the rear cover

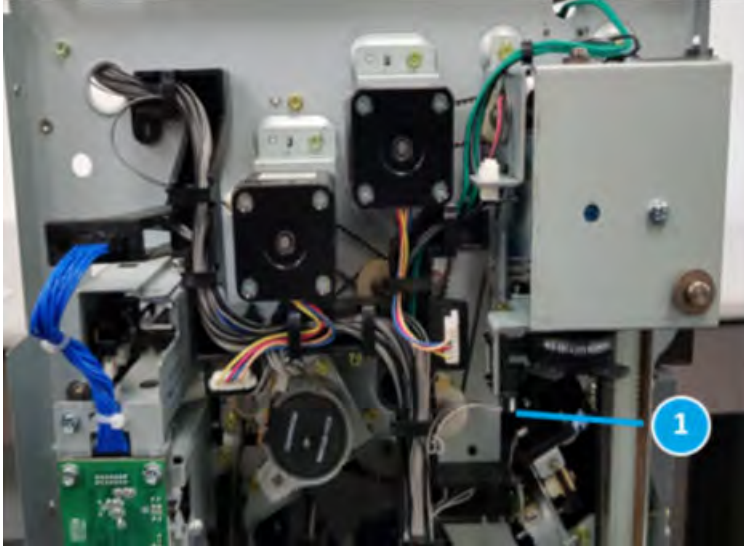


### Remove the main output tray motor sensor (S33)

Follow these steps to remove the main output tray motor sensor (S33).

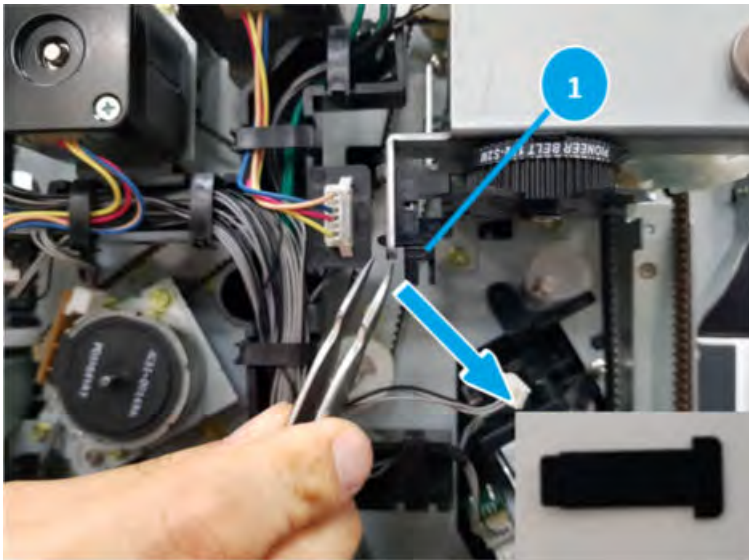
1. Disconnect the connector (callout 1)

Figure 5-1294 Disconnect the connector



2. Remove the tape using tweezers and remove the sensor (S33, callout 1).

Figure 5-1295 Remove the sensor



### Unpack the replacement assembly

Follow these steps to unpack the replacement assembly.

1. Dispose of the defective part.





---

 **NOTE:** HP recommends responsible disposal of the defective part.


<http://www8.hp.com/us/en/hp-information/environment/product-recycling.html>

---

2. Unpack the replacement part from the packaging.


 **CAUTION:**  Some parts are sensitive to electrostatic discharge (ESD). Always perform service work at an ESD-protected workstation or mat. If an ESD workstation or mat is not available, touch the sheet-metal chassis to provide a static ground before touching an ESD-sensitive assembly. Protect the ESD-sensitive assemblies by placing them in ESD pouches when they are out of the printer.

 **IMPORTANT:** Make sure that all of the shipping materials (for example shipping tape) are removed from the replacement part prior to installation.

 **NOTE:** If the replacement part is a roller or pad, avoid touching the spongy part of it. Skin oils on the roller or pad can cause paper pickup and/or print-quality problems. HP recommends using disposable gloves when handling rollers or pads or washing your hands before touching rollers or pads.

---

3. To install an assembly, reverse the removal steps.

 **NOTE:** When applicable, special installation instructions are provided for an assembly at the end of the removal procedure. Always completely read the removal instructions and follow all special installation instructions.

---

# HP LaserJet Managed MFP E82540-E82560, E87640-E87660, E82540du-E82560du, E87640du-E87660du, E72525-E72535, E77822-E77830 - Removal and replacement: Main output tray motor (M11)

Learn how to remove and replace the main output tray motor.

## Introduction

This document provides the procedures to remove and replace the main output tray motor on the finisher.



**IMPORTANT:** When applicable, special installation instructions are provided for an assembly at the end of the removal procedure. Always completely read the removal instructions and follow all special installation instructions.

## Before performing service

- Turn the printer power off. A shutting-down message appears on the control-panel display.
- ⚠ **WARNING!** To avoid damage to the printer, turn the power off and wait until the printer shuts down before removing the power cable.
- Disconnect the printer power cable after the printer has completely shut down (the control-panel display is blank).
- Release the finisher from the printer by pulling out on the release latch inside the finisher door.
- Disconnect the cable from the bridge unit to the finisher.
- Disconnect the cable from the finisher to the printer.

Use the table below to identify the correct part number for your printer. To order the part, go to <https://parts.hp.com>.

**Table 5-136 Part information**

Part number	Part description
JC90-01415B	Main output tray motor assembly

## Required tools

- #2 JIS screwdriver with a magnetic tip

## After performing service

- Connect the cable from the finisher to the printer.
- Connect the cable from the bridge unit to the finisher.
- Attach the finisher to the printer, and then push in on the release latch inside the finisher door.
- Connect the printer power cable.
- Turn the printer power on.

## Post service test

Process a job through the finisher and verify that the finisher works correctly.

### Remove the right upper cover (finisher)

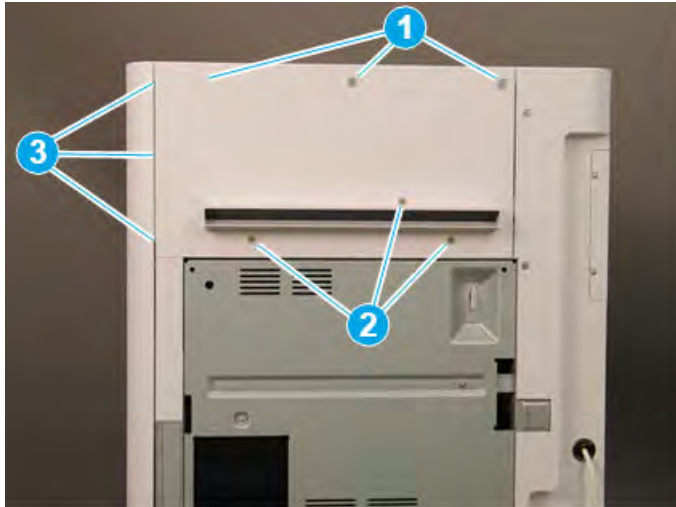
Follow these steps to remove the right upper cover (finisher).

- ▲ Remove one screw cap and three machine screws on the upper edge of the cover (callout 1). Remove three sheet metal screws (callout 2) on the lower portion of the cover. Rotate the right edge of the cover away from the finisher, and then slide the cover right to release three tabs (callout 3).

💡 **TIP:** The lower screws are shorter in length than the upper screws.

**TIP:** Reverse the removal steps to install the assembly.

Figure 5-1296 Remove the right upper cover

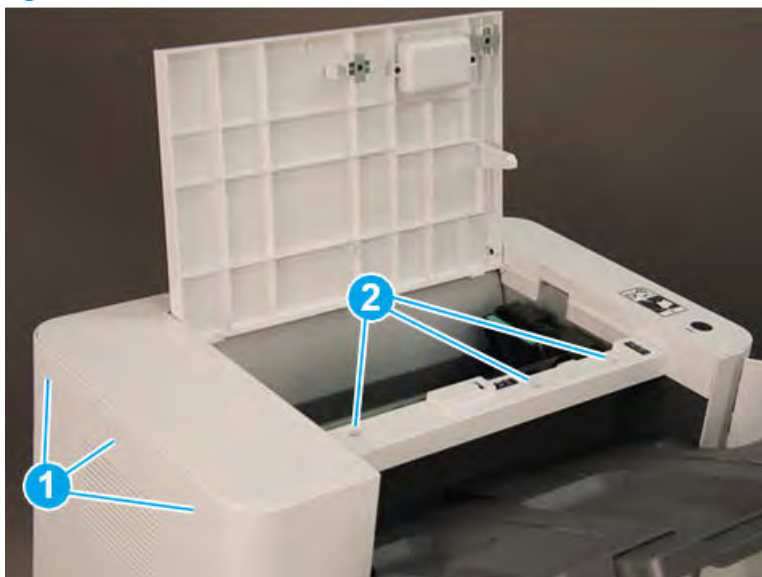


### Remove the top cover (finisher)

Follow these steps to remove the top cover (finisher).

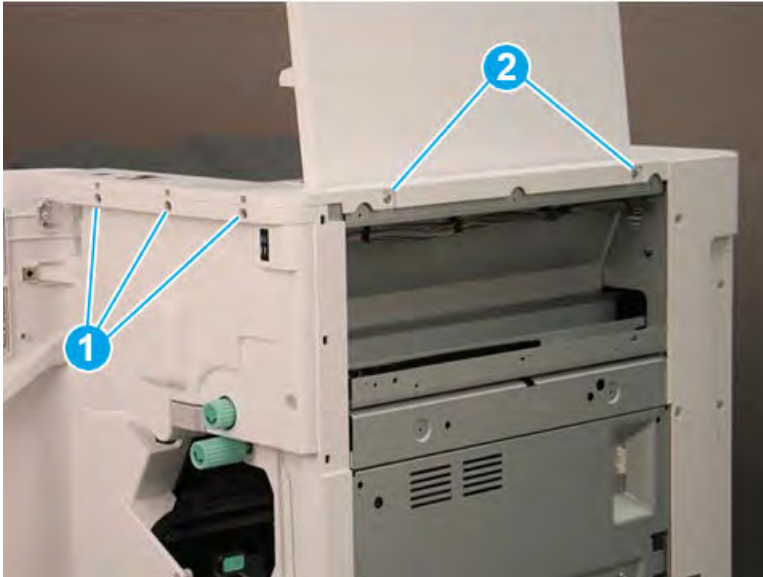
1. Remove three screw caps and three self-tapping screws at the top of the rear cover (callout 1), and then remove three machine screws (callout 2) on top of the cover.

Figure 5-1297 Remove six screws




2. Remove three self-tapping screws at the top of the front cover (callout 1), and then remove two machine screws (callout 2) at the top of the right side.

Figure 5-1298 Remove five screws



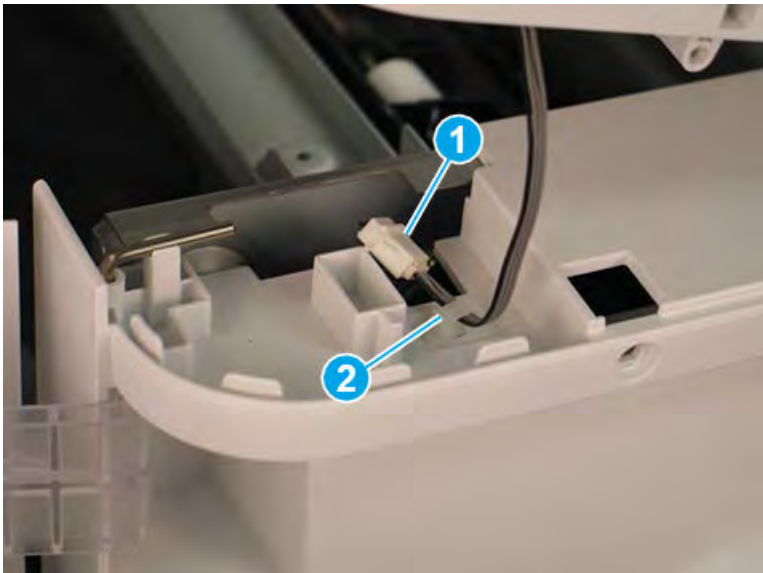
3. Lift the cover up slightly. Disconnect one in-line connector (callout 1), and then release one retainer (callout 2).

---

 **TIP:** Reverse the removal steps to install the assembly.

---

Figure 5-1299 Disconnect one connector and release retainer



### Remove the rear cover (finisher)

Follow these steps to remove the rear cover (finisher).


1. Remove two self-tapping screws (callout 1) on the top of the rear cover, and then remove five screw caps and five machine screws (callout 2) on the left side of the cover.

Figure 5-1300 Remove seven screws



2. Remove one screw cap and four machine screws (callout 1) Remove the rear cover.

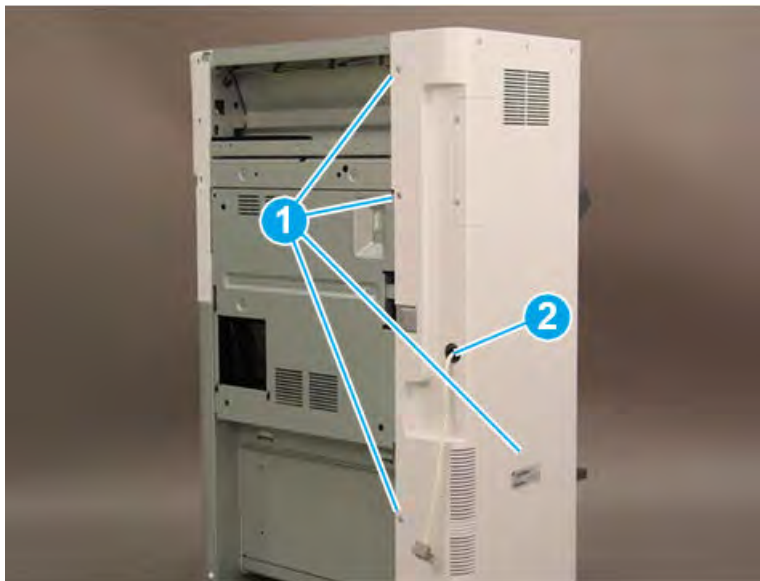
---

 **NOTE:** Make sure to thread the power cable (callout 2) through the opening in the cover.

 **TIP:** Reverse the removal steps to install the assembly

---

Figure 5-1301 Remove the rear cover

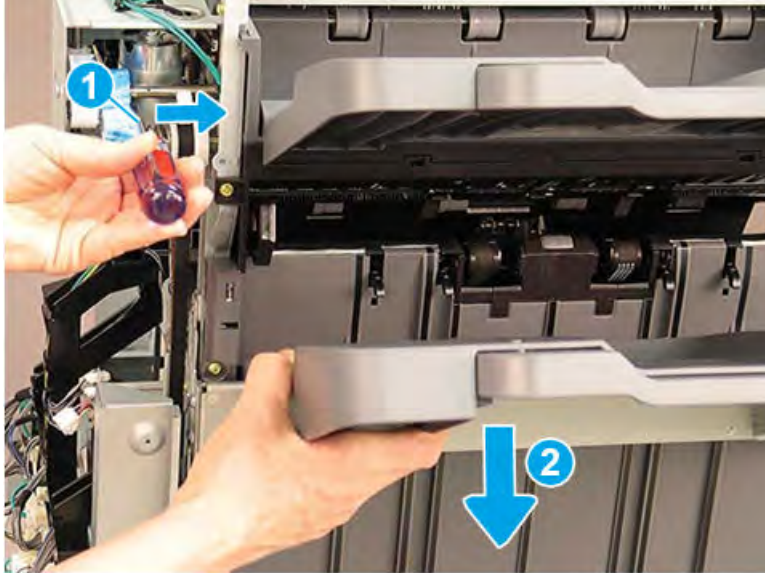


### Remove the main output tray motor (M11)

Follow these steps to remove the main output tray motor (M11).

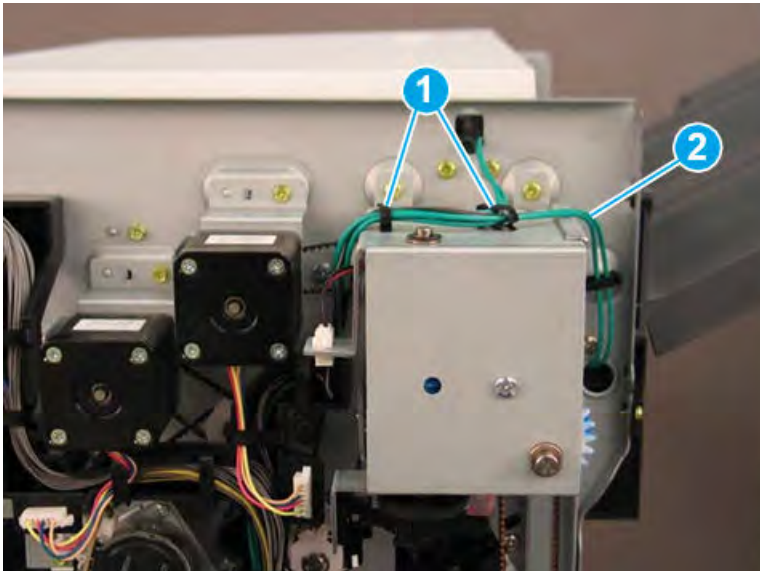
1. Bring the lower output tray down by positioning the shaft of a screwdriver on the clutch (callout 1) and gently pressing to the right to release the clutch. Hold the clutch in the released position and lower the tray (callout 2) to the lowest position

Figure 5-1302 Lower the output tray



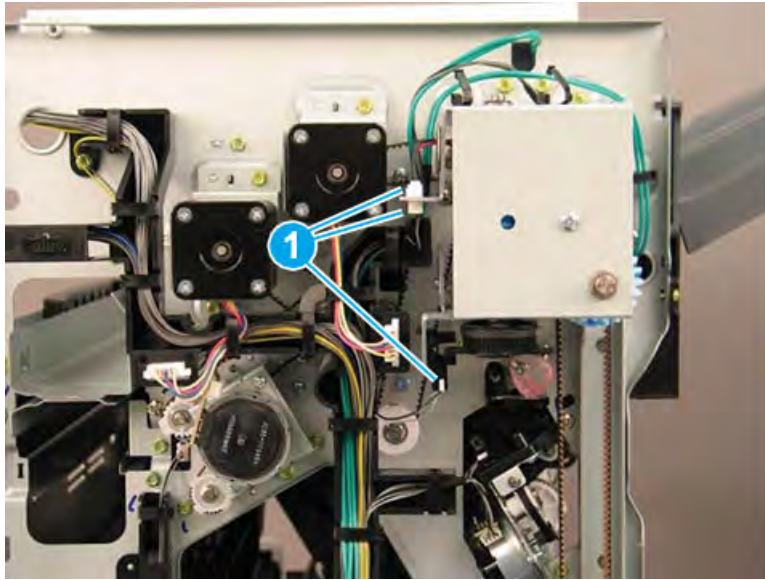
2. Open two retainers (callout 1), and then release the green wires (callout 2).

Figure 5-1303 Open two retainers



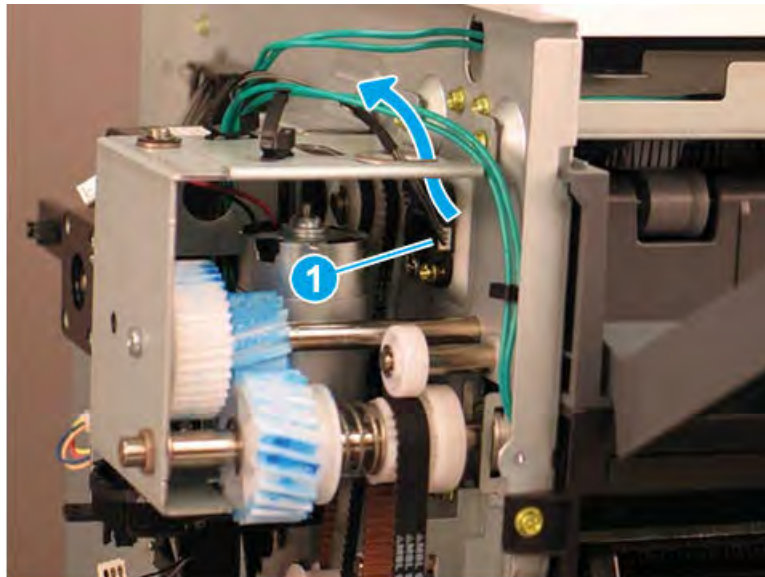
3. Disconnect three connectors (callout 1).

Figure 5-1304 Disconnect three connectors



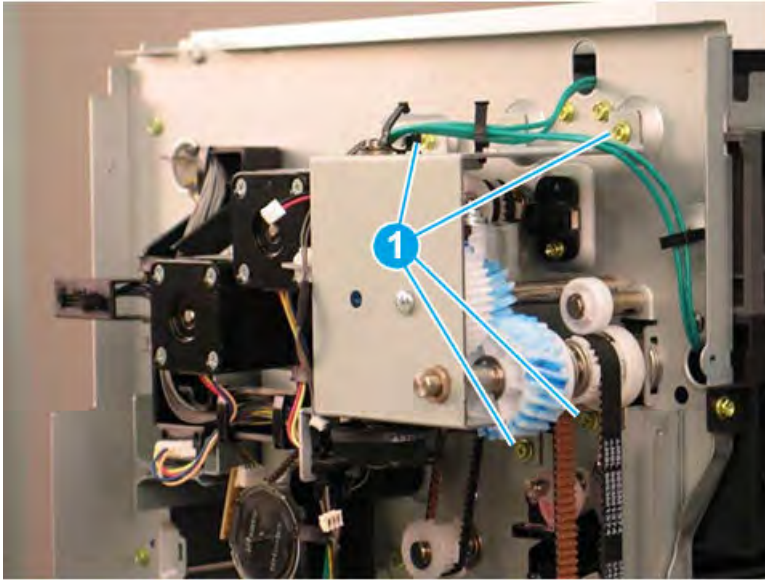
4. Disconnect one connector (callout 1), and then thread the cable up through the opening in the top of the bracket.

Figure 5-1305 Disconnect one connector



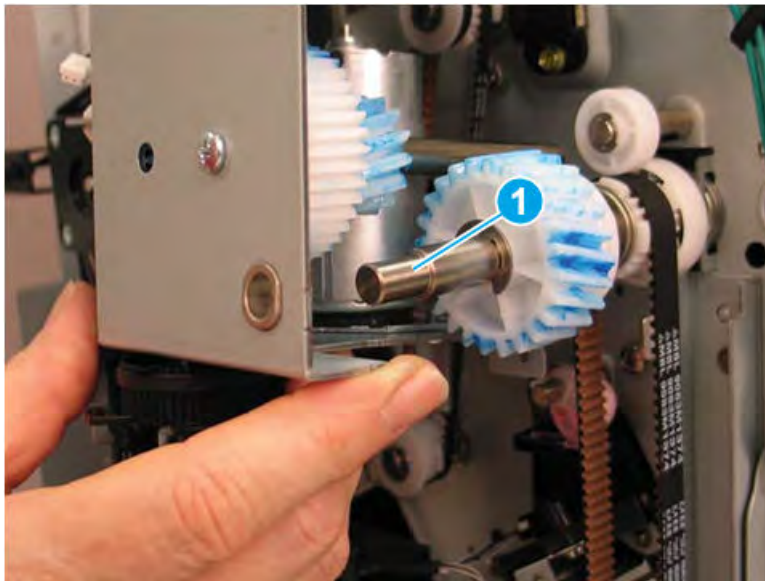
5. Remove four screws (callout 1), and then remove the motor assembly.

Figure 5-1306 Remove four screws and the motor assembly



6. Carefully pull the motor assembly away from the printer to remove it.

Figure 5-1307 Remove the motor assembly



7. Reverse the removal steps to install the assembly. Also use the following special installation instructions.

---

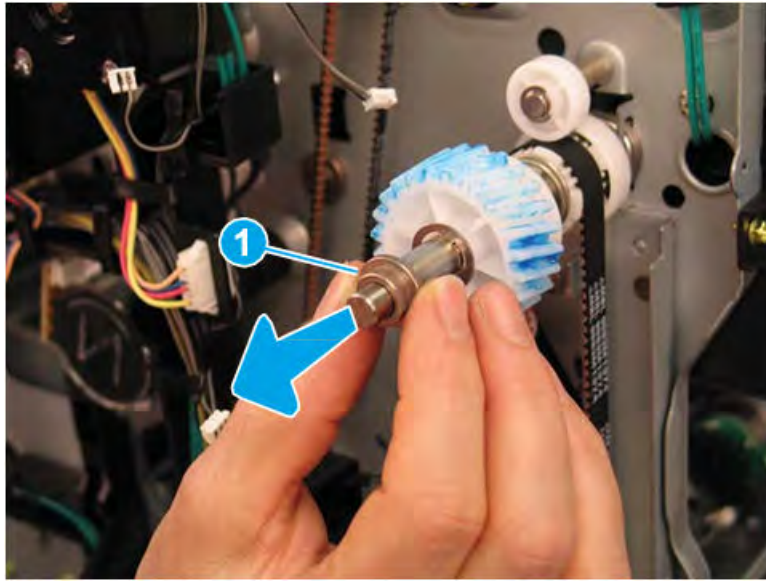
 **NOTE:** Continue to reverse the removal steps to finish installing the assembly.

---

**Special installation instructions: Main tray moving motor (M11)**

- a. Before installing the motor assembly, slide the bushing (callout 1) off of the shaft.

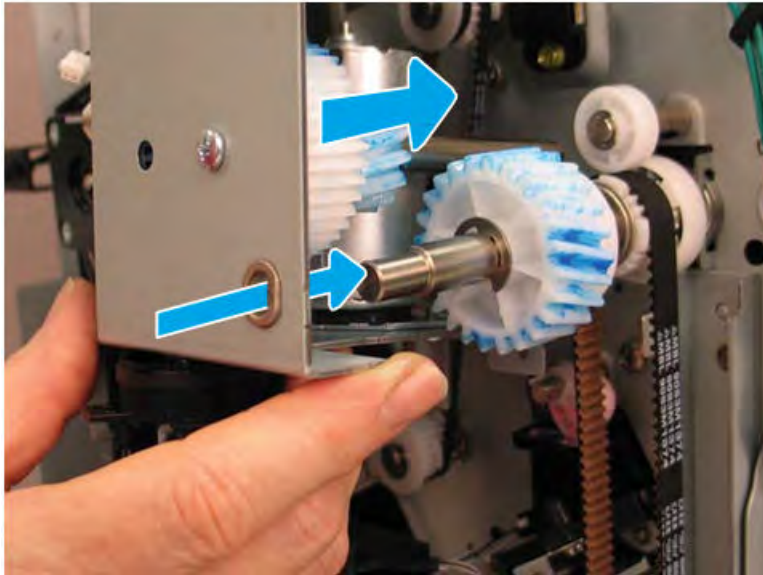




- b. Align the flat edges on the bushing with the flat edges on the opening in the motor assembly bracket, and then install the bushing.



- c. Position the bushing over the shaft, and then install the motor assembly.



### Unpack the replacement assembly

Follow these steps to unpack the replacement assembly.

1. Dispose of the defective part.

---



 **NOTE:** HP recommends responsible disposal of the defective part.

<http://www8.hp.com/us/en/hp-information/environment/product-recycling.html>


---

2. Unpack the replacement part from the packaging.

---

 **CAUTION:**  Some parts are sensitive to electrostatic discharge (ESD). Always perform service work at an ESD-protected workstation or mat. If an ESD workstation or mat is not available, touch the sheet-metal chassis to provide a static ground before touching an ESD-sensitive assembly. Protect the ESD-sensitive assemblies by placing them in ESD pouches when they are out of the printer.

 **IMPORTANT:** Make sure that all of the shipping materials (for example shipping tape) are removed from the replacement part prior to installation.

 **NOTE:** If the replacement part is a roller or pad, avoid touching the spongy part of it. Skin oils on the roller or pad can cause paper pickup and/or print-quality problems. HP recommends using disposable gloves when handling rollers or pads or washing your hands before touching rollers or pads.

---

3. To install an assembly, reverse the removal steps.

---

 **NOTE:** When applicable, special installation instructions are provided for an assembly at the end of the removal procedure. Always completely read the removal instructions and follow all special installation instructions.

---


## Paper holding unit

## Removal and replacement: Paper holding home sensor (S22)


Learn how to remove and replace the paper holding home sensor.

### Introduction

This document provides the procedures to remove and replace the paper holding home sensor on the finisher.

 **IMPORTANT:** When applicable, special installation instructions are provided for an assembly at the end of the removal procedure. Always completely read the removal instructions and follow all special installation instructions.

### Before performing service

- Turn the printer power off. A shutting-down message appears on the control-panel display.
-  **WARNING!** To avoid damage to the printer, turn the power off and wait until the printer shuts down before removing the power cable.
- Disconnect the printer power cable after the printer has completely shut down (the control-panel display is blank).
- Release the finisher from the printer by pulling out on the release latch inside the finisher door.
- Disconnect the cable from the bridge unit to the finisher.
- Disconnect the cable from the finisher to the printer.

Use the table below to identify the correct part number for your printer. To order the part, go to <https://parts.hp.com>.

Table 5-137 Part information

Part number	Part description
0604-001393	Paper holding home sensor

### Required tools

- #2 JIS screwdriver with a magnetic tip

### After performing service

- Connect the cable from the finisher to the printer.
- Connect the cable from the bridge unit to the finisher.
- Attach the finisher to the printer, and then push in on the release latch inside the finisher door.
- Connect the printer power cable.
- Turn the printer power on.

### Post service test

Process a job through the finisher and verify that the finisher works correctly.

### Remove the right upper cover (finisher)

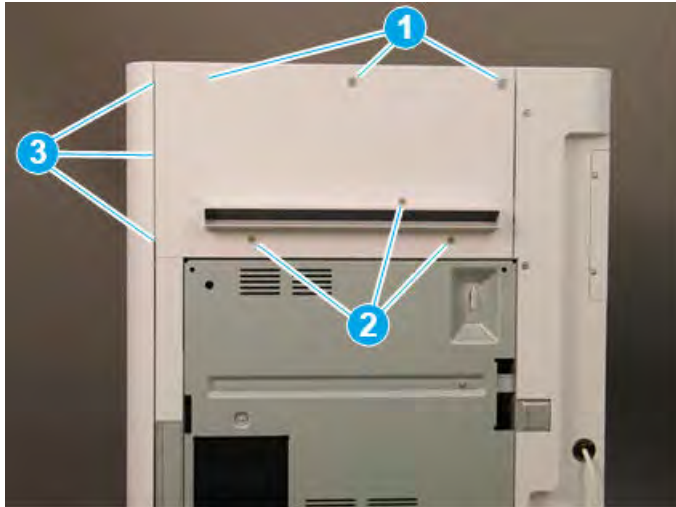
Follow these steps to remove the right upper cover (finisher).

- ▲ Remove one screw cap and three machine screws on the upper edge of the cover (callout 1). Remove three sheet metal screws (callout 2) on the lower portion of the cover. Rotate the right edge of the cover away from the finisher, and then slide the cover right to release three tabs (callout 3).

💡 **TIP:** The lower screws are shorter in length than the upper screws.

**TIP:** Reverse the removal steps to install the assembly.

Figure 5-1308 Remove the right upper cover

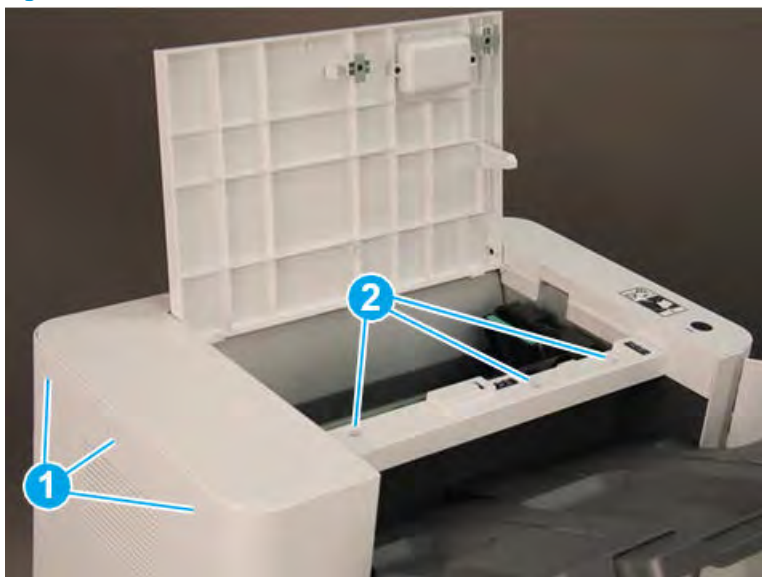


### Remove the top cover (finisher)

Follow these steps to remove the top cover (finisher).

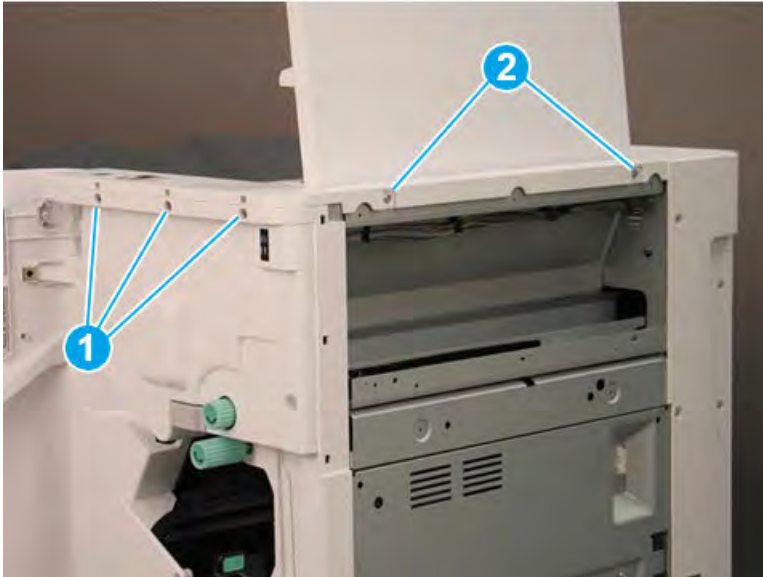
1. Remove three screw caps and three self-tapping screws at the top of the rear cover (callout 1), and then remove three machine screws (callout 2) on top of the cover.

Figure 5-1309 Remove six screws




2. Remove three self-tapping screws at the top of the front cover (callout 1), and then remove two machine screws (callout 2) at the top of the right side.

Figure 5-1310 Remove five screws



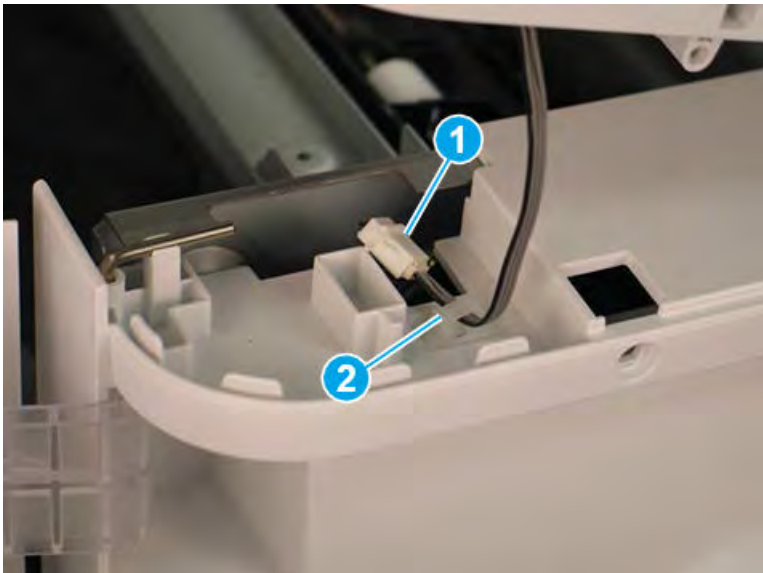
3. Lift the cover up slightly. Disconnect one in-line connector (callout 1), and then release one retainer (callout 2).

---

 **TIP:** Reverse the removal steps to install the assembly.

---

Figure 5-1311 Disconnect one connector and release retainer

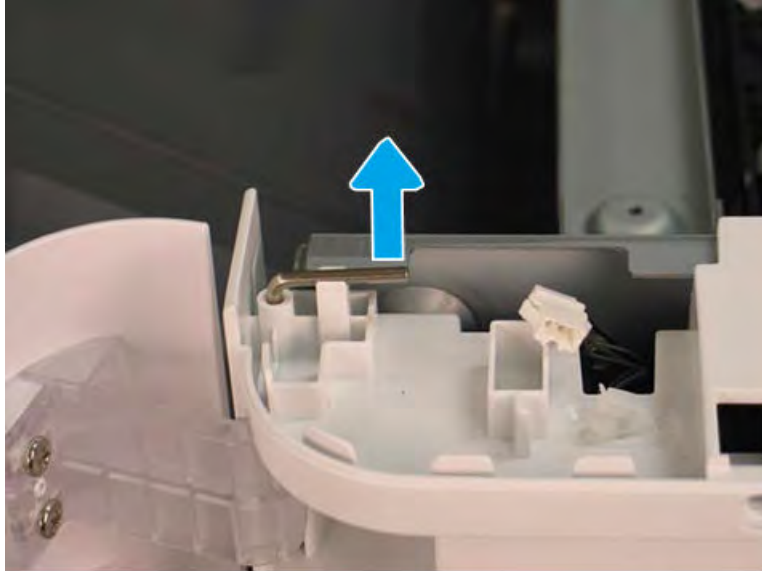


### Remove the front door (finisher)

Follow these steps to remove the front door (finisher).

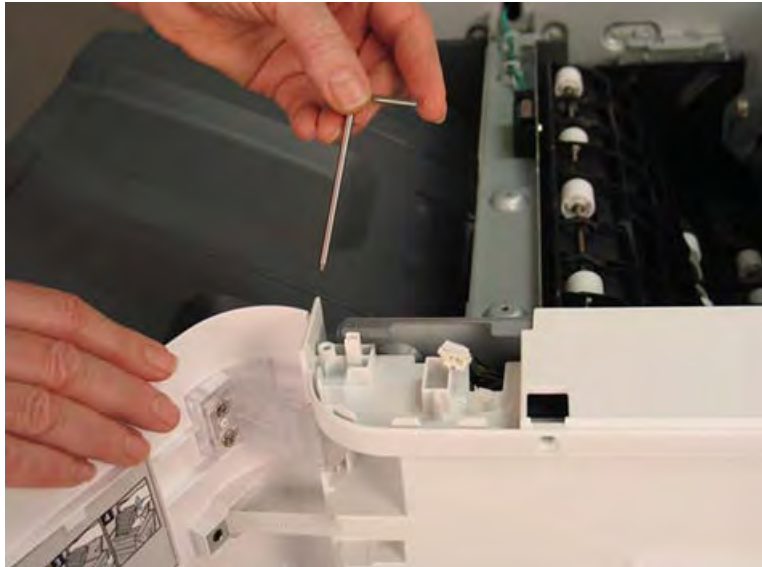
1. Lift the top hinge pin up to release it from the retainer.

Figure 5-1312 Lift the top hinge pin



2. Pull the top hinge pin up to remove it.

Figure 5-1313 Remove the top hinge pin



3. Use a small, flat-blade screwdriver to release the lower hinge pin from the retainer, and then rotate it away from the finisher.

**Figure 5-1314** Release the lower hinge pin




4. Support the door with one hand, and then pull the lower hinge pin straight up to remove it.

**Figure 5-1315** Remove the lower hinge pin

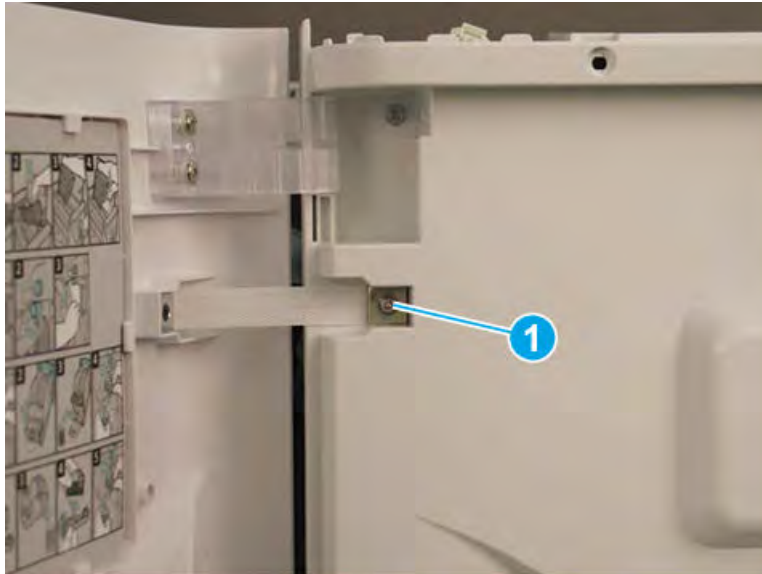




5. Support the door with one hand, and then remove one screw (callout 1) to release the strap. Remove the front door.

 **TIP:** Reverse the removal steps to install the assembly.

**Figure 5-1316** Remove the front door

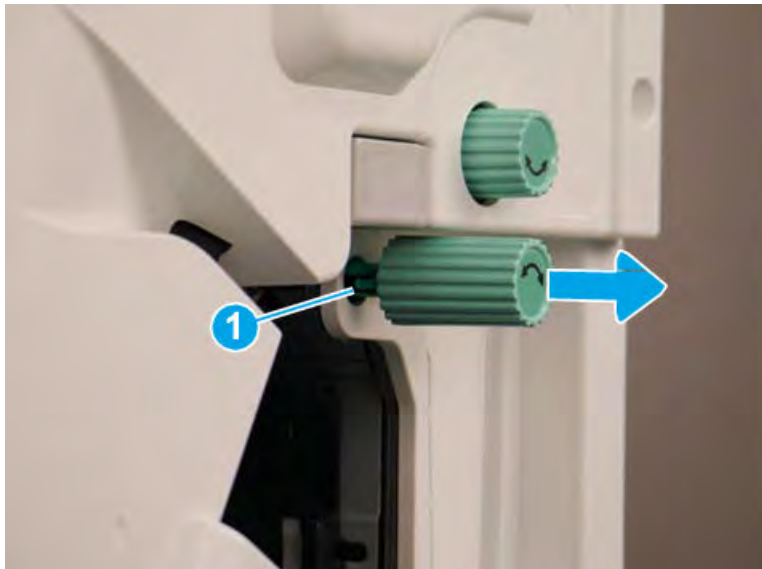


#### Remove the front cover (finisher)

Follow these steps to remove the front cover (finisher).

1. Release one tab (callout 1), and then pull the jam-access knob away from the finisher to remove it.

**Figure 5-1317** Remove the jam-access knob



2. If the punch unit is installed, remove the punch waste bin (callout 1).


3. Remove one screw (callout 1) on top of the front cover.

Figure 5-1318 Remove one screw



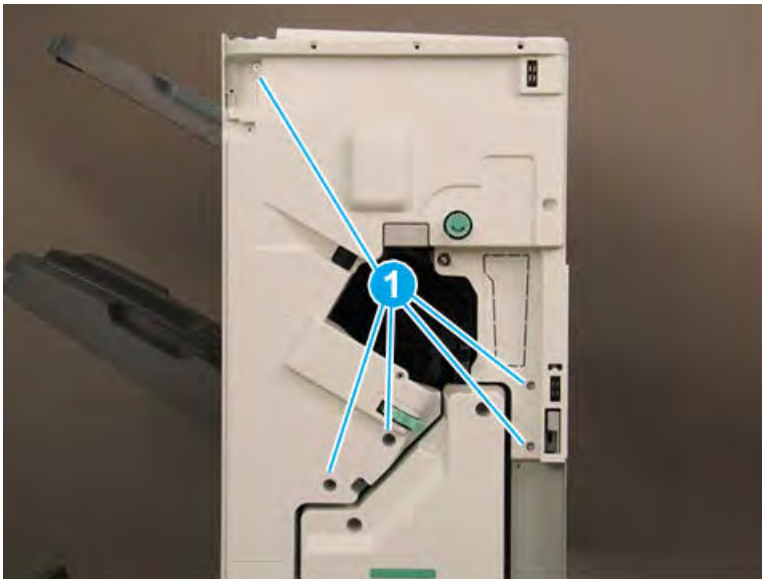
4. Remove five machine screws (callout 1), and then remove the front cover.

---

 **TIP:** Reverse the removal steps to install the assembly.

---

Figure 5-1319 Remove the front cover

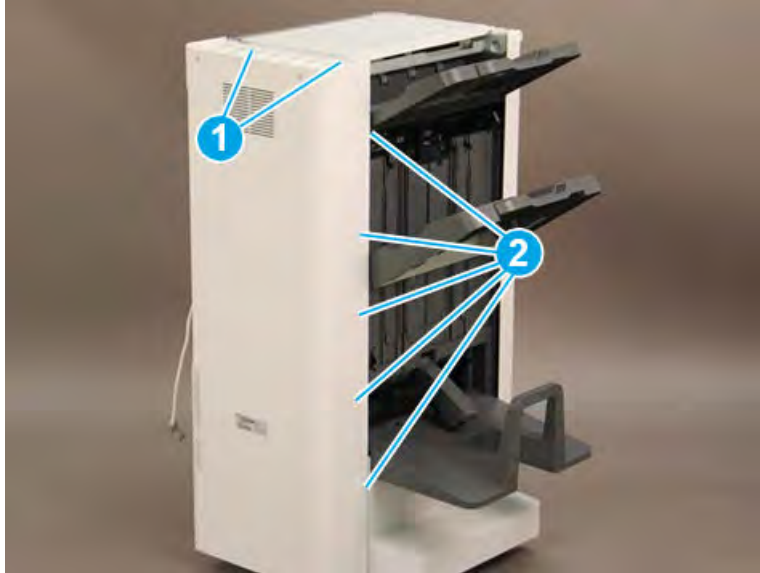


### Remove the rear cover (finisher)

Follow these steps to remove the rear cover (finisher).

1. Remove two self-tapping screws (callout 1) on the top of the rear cover, and then remove five screw caps and five machine screws (callout 2) on the left side of the cover.

Figure 5-1320 Remove seven screws



2. Remove one screw cap and four machine screws (callout 1) Remove the rear cover.

 **NOTE:** Make sure to thread the power cable (callout 2) through the opening in the cover.


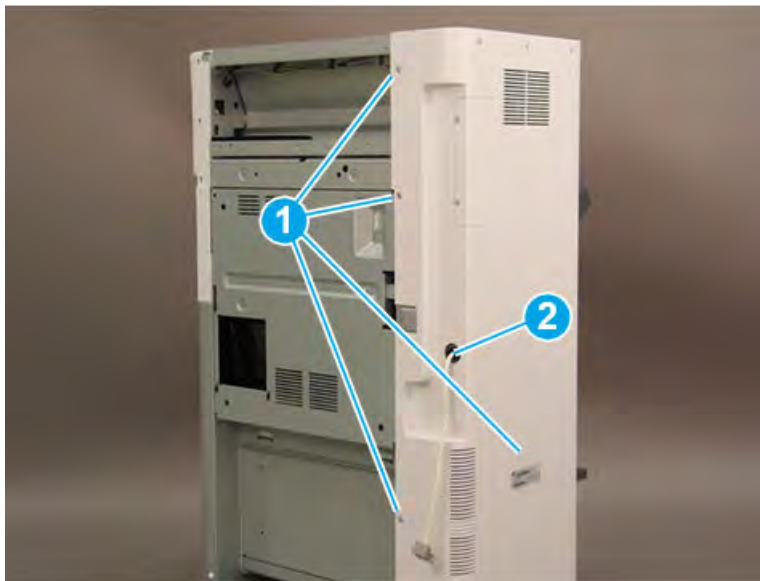
 **TIP:** Reverse the removal steps to install the assembly

Figure 5-1321 Remove the rear cover



### Remove the booklet output tray

Follow these steps to remove the booklet output tray.

1. Raise the booklet output tray up (callout 1), and then pull it away from the finisher (callout 2) to remove it.

Figure 5-1322 Remove the booklet output tray



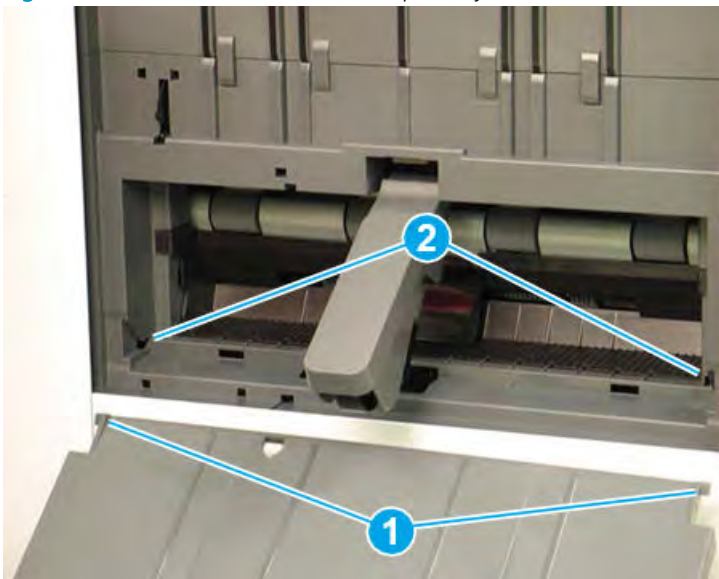
2. Reverse the removal steps to install the assembly. Also use the following special installation instructions.

 **NOTE:** Continue to reverse the removal steps to finish installing the assembly

Special installation instructions: booklet output tray

Position the tabs (callout 1) on the tray into the slots (callout 2) on the finisher.

Figure 5-1323 Install the booklet output tray

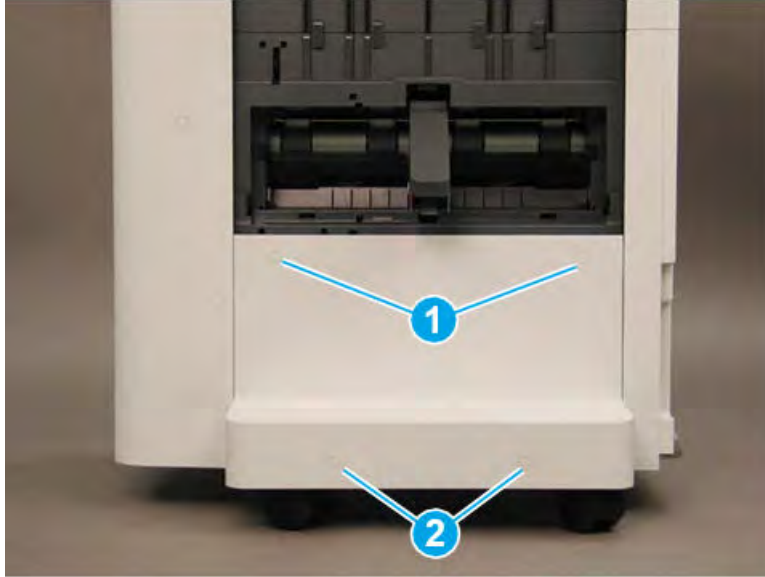


### Remove the caster cover

Follow these steps to remove the caster cover.

1. Remove two screw caps and two self-tapping screws (callout 1). Remove two screw caps and two machine screws (callout 2).

Figure 5-1324 Remove four screws



2. Rotate the left edge of the cover away from the finisher (callout 1), and then slide the cover to the left (callout 2) to remove it.

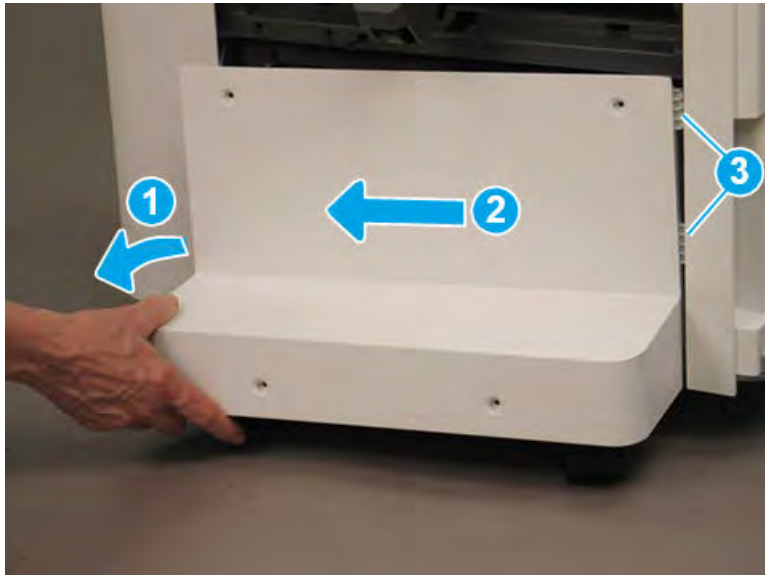
---

 **TIP:** Make sure that two tabs (callout 3) are positioned under the front lower cover when reinstalling the caster cover.

**TIP:** Reverse the removal steps to install the assembly

---

Figure 5-1325 Remove the caster cover




### Remove the left lower cover (finisher)

Follow these steps to remove the left lower cover (finisher).

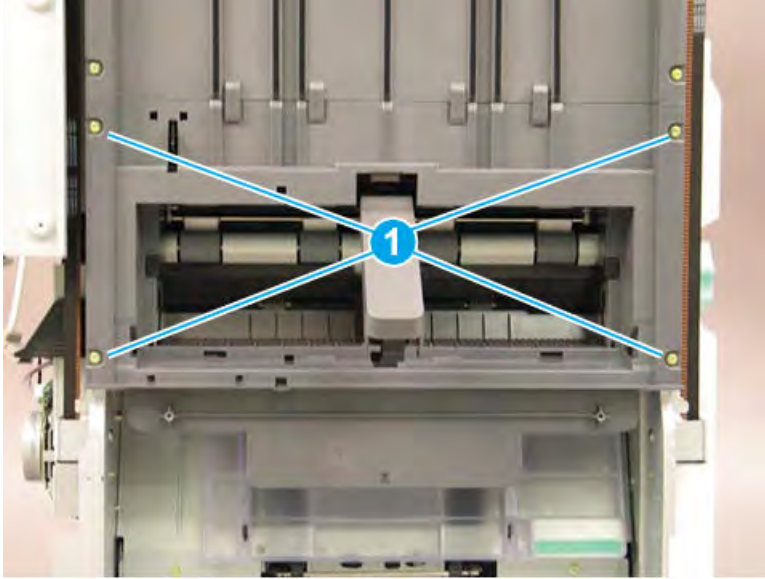
1. Remove four screws (callout 1).

---

 **NOTE:** Raise the lower output tray as needed to access the screws.

---

Figure 5-1326 Remove four screws

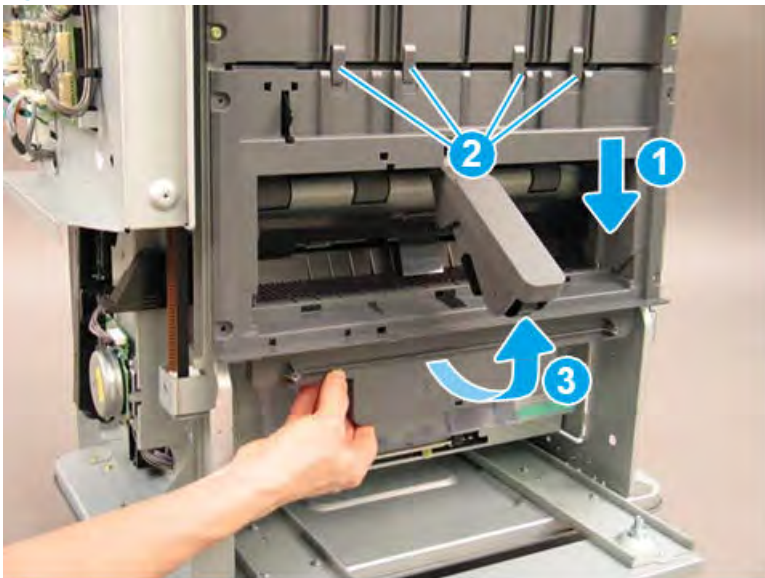


2. Slide the shield down (callout 1) to release it from four tabs (callout 2), and then rotate it away from the finisher (callout 3).


**⚠ CAUTION:** The shield is still attached to the finisher. Do not attempt to completely remove the shield.

**💡 TIP:** Position the shield under the four tabs (callout 2) when reinstalling it.

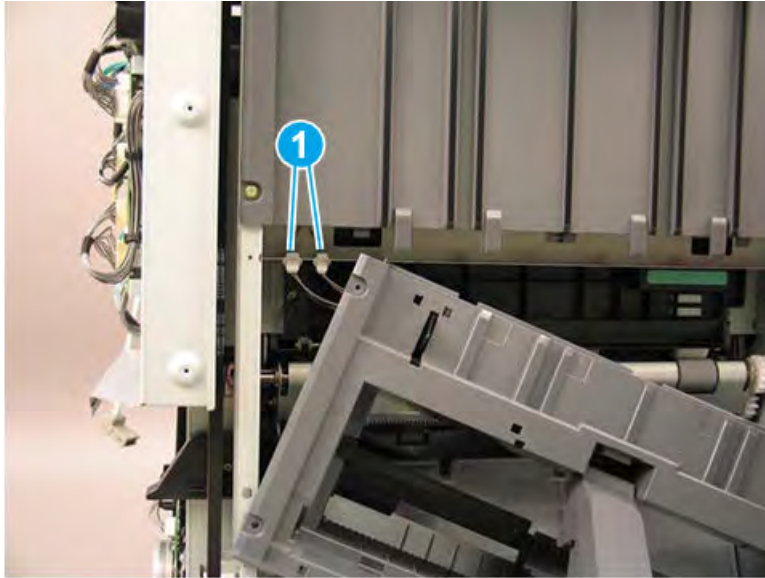
Figure 5-1327 Release the lower shield



3. Disconnect two connectors (callout 1), and then remove the shield.

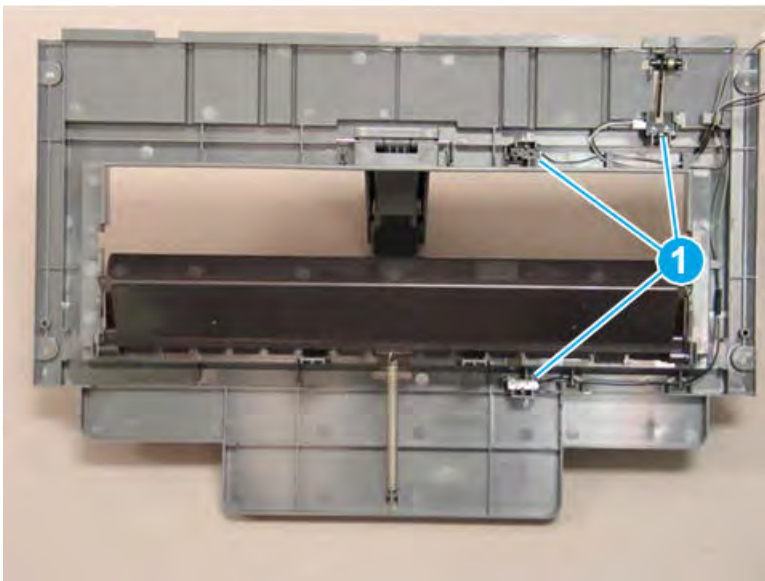
 **TIP:** Reverse the removal steps to install the assembly.

**Figure 5-1328** Disconnect two connectors



4. If you are replacing the left lower cover, locate three sensors (callout 1) on the back of the left lower cover. Remove these sensors and transfer them to the replacement part.

**Figure 5-1329** Remove the left lower cover

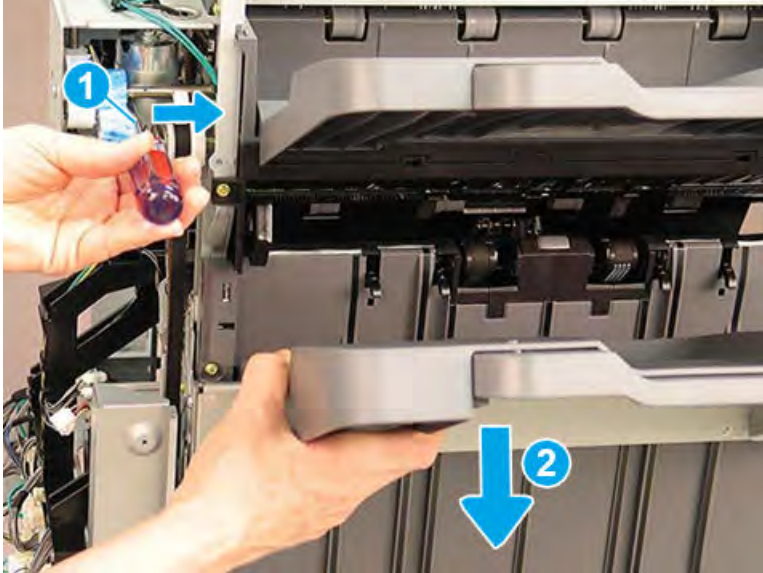


### Remove the left upper cover (finisher)

Follow these steps to remove the left upper cover (finisher).

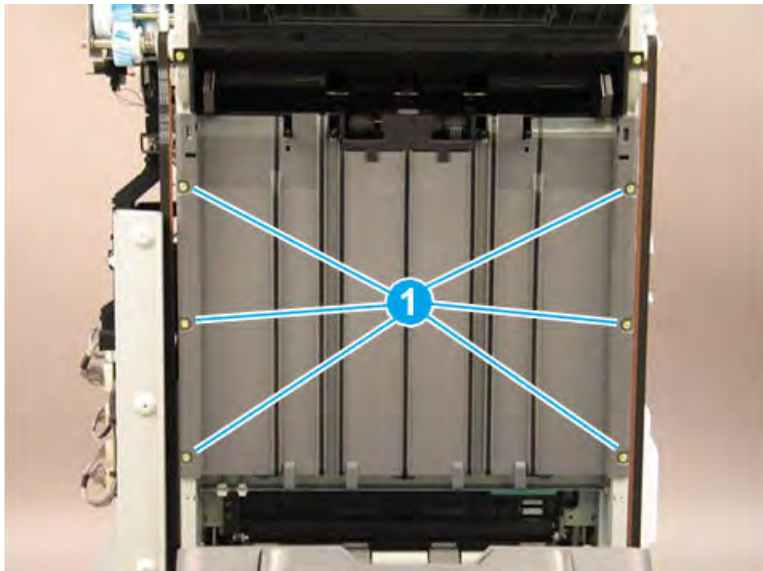
1. Bring the lower output tray down by positioning the shaft of a screwdriver on the clutch (callout 1) and gently pressing to the right to release the clutch. Hold the clutch in the released position and lower the tray (callout 2) to the lowest position.

Figure 5-1330 Lower the output tray



2. Remove six machine screws (callout 1).

Figure 5-1331 Remove six screws



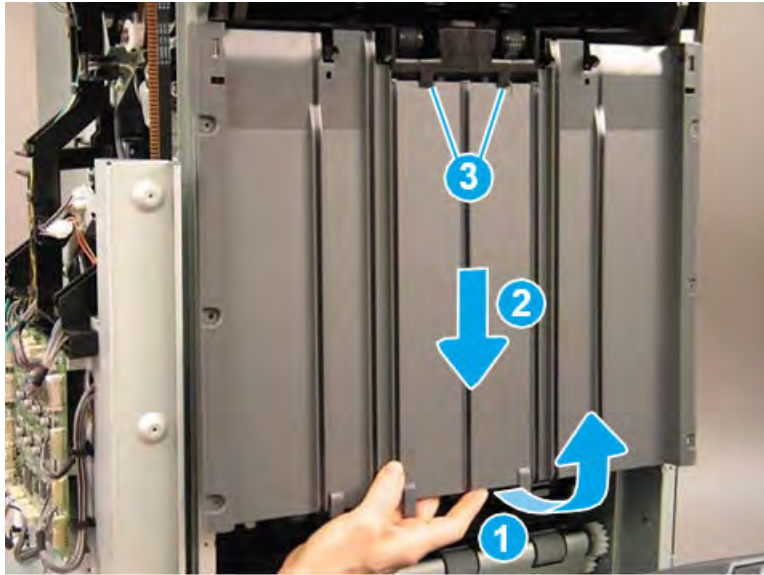


3. Rotate the lower edge of the shield away from the finisher (callout 1), and then slide the shield down (callout 2) to release it from two tabs (callout 3).

**CAUTION:** The shield is still attached to the finisher. Do not attempt to completely remove the shield.

**TIP:** Position the shield under the two tabs (callout 3) when reinstalling it.

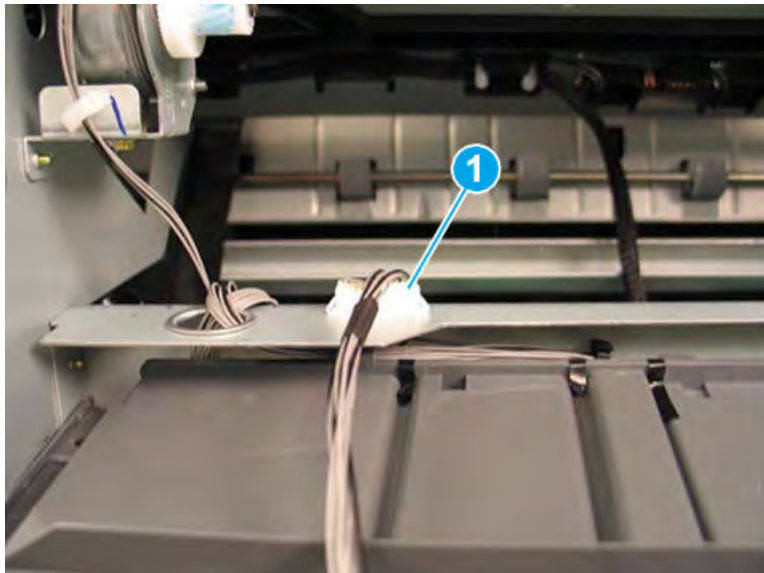
**Figure 5-1332** Release the shield



4. Disconnect one connector (callout 1), and then remove the upper shield assembly.

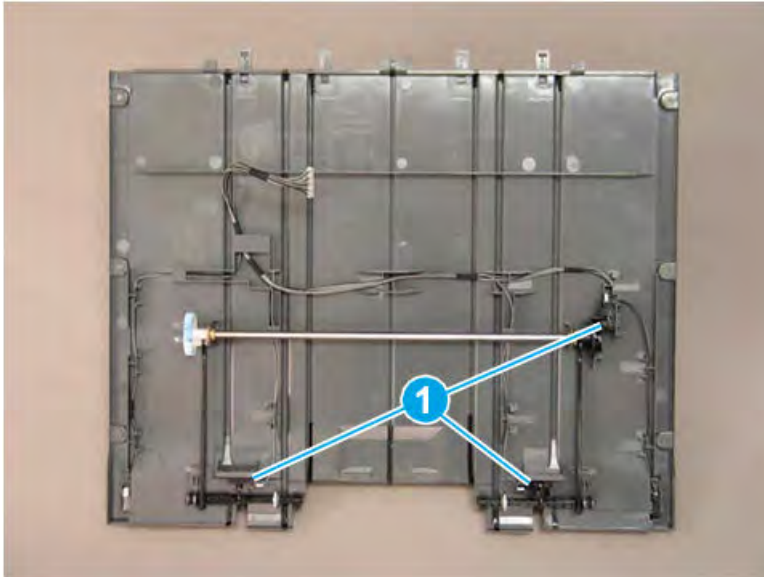
**TIP:** Reverse the removal steps to install the assembly.

**Figure 5-1333** Disconnect one connector



5. If you are replacing the left upper cover, locate three sensors (callout 1) on the back of the left upper cover. Remove these sensors and transfer them to the replacement part.

Figure 5-1334 Remove the left upper cover

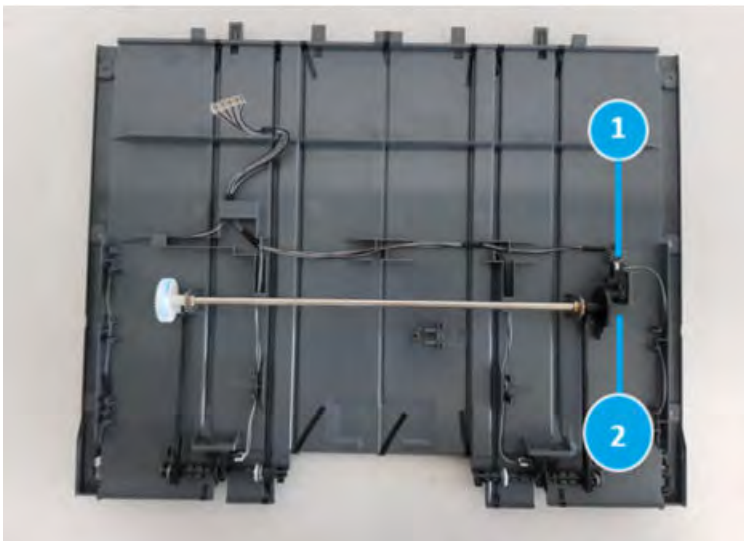


#### Remove the paper holding home sensor(S22)

Follow these steps to remove the paper holding home sensor(S22).

- ▲ Disconnect the connector(callout 1) and remove the sensor(S22, callout 2) from the upper shield assembly.

Figure 5-1335 Remove the paper holding home sensor



#### Unpack the replacement assembly

Follow these steps to unpack the replacement assembly.

1. Dispose of the defective part.



---

 **NOTE:** HP recommends responsible disposal of the defective part.


<http://www8.hp.com/us/en/hp-information/environment/product-recycling.html>

---

2. Unpack the replacement part from the packaging.


 **CAUTION:**  Some parts are sensitive to electrostatic discharge (ESD). Always perform service work at an ESD-protected workstation or mat. If an ESD workstation or mat is not available, touch the sheet-metal chassis to provide a static ground before touching an ESD-sensitive assembly. Protect the ESD-sensitive assemblies by placing them in ESD pouches when they are out of the printer.

 **IMPORTANT:** Make sure that all of the shipping materials (for example shipping tape) are removed from the replacement part prior to installation.

 **NOTE:** If the replacement part is a roller or pad, avoid touching the spongy part of it. Skin oils on the roller or pad can cause paper pickup and/or print-quality problems. HP recommends using disposable gloves when handling rollers or pads or washing your hands before touching rollers or pads.

---

3. To install an assembly, reverse the removal steps.

 **NOTE:** When applicable, special installation instructions are provided for an assembly at the end of the removal procedure. Always completely read the removal instructions and follow all special installation instructions.


---

## Removal and replacement: Paper holding front sensor (S17)


Learn how to remove and replace the front paper holding sensor.

### Introduction

This document provides the procedures to remove and replace the front paper holding sensor on the finisher.

 **IMPORTANT:** When applicable, special installation instructions are provided for an assembly at the end of the removal procedure. Always completely read the removal instructions and follow all special installation instructions.

### Before performing service

- Turn the printer power off. A shutting-down message appears on the control-panel display.
-  **WARNING!** To avoid damage to the printer, turn the power off and wait until the printer shuts down before removing the power cable.
- Disconnect the printer power cable after the printer has completely shut down (the control-panel display is blank).
- Release the finisher from the printer by pulling out on the release latch inside the finisher door.
- Disconnect the cable from the bridge unit to the finisher.
- Disconnect the cable from the finisher to the printer.

Use the table below to identify the correct part number for your printer. To order the part, go to <https://parts.hp.com>.

**Table 5-138** Part information

Part number	Part description
0604-001393	Front paper holding sensor

### Required tools

- #2 JIS screwdriver with a magnetic tip

### After performing service

- Connect the cable from the finisher to the printer.
- Connect the cable from the bridge unit to the finisher.
- Attach the finisher to the printer, and then push in on the release latch inside the finisher door.
- Connect the printer power cable.
- Turn the printer power on.

### Post service test

Process a job through the finisher and verify that the finisher works correctly.

### Remove the right upper cover (finisher)

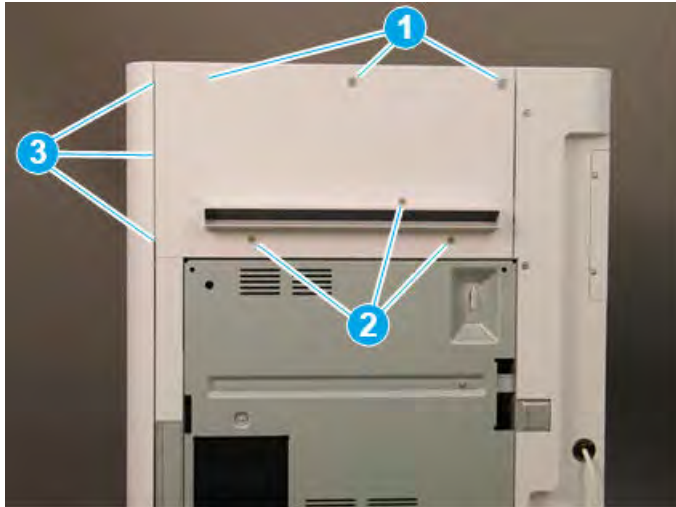
Follow these steps to remove the right upper cover (finisher).

- ▲ Remove one screw cap and three machine screws on the upper edge of the cover (callout 1). Remove three sheet metal screws (callout 2) on the lower portion of the cover. Rotate the right edge of the cover away from the finisher, and then slide the cover right to release three tabs (callout 3).

💡 **TIP:** The lower screws are shorter in length than the upper screws.

**TIP:** Reverse the removal steps to install the assembly.

Figure 5-1336 Remove the right upper cover

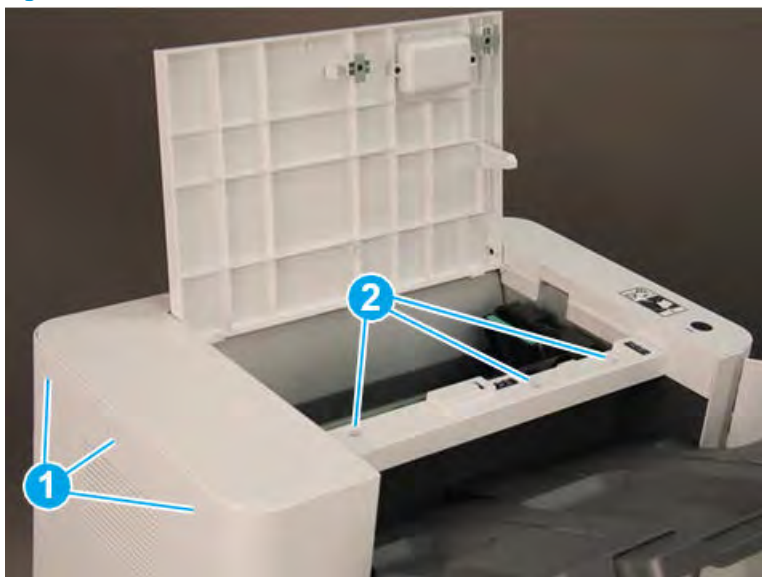


### Remove the top cover (finisher)

Follow these steps to remove the top cover (finisher).

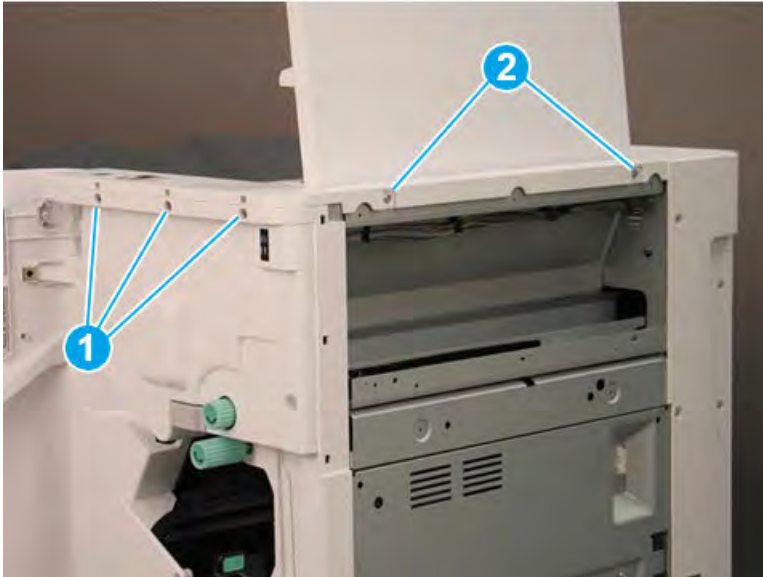
1. Remove three screw caps and three self-tapping screws at the top of the rear cover (callout 1), and then remove three machine screws (callout 2) on top of the cover.

Figure 5-1337 Remove six screws




2. Remove three self-tapping screws at the top of the front cover (callout 1), and then remove two machine screws (callout 2) at the top of the right side.

Figure 5-1338 Remove five screws



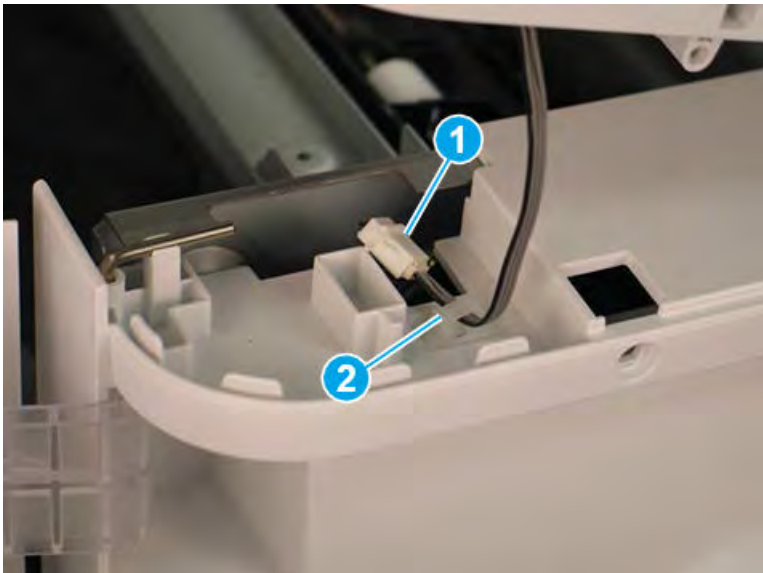
3. Lift the cover up slightly. Disconnect one in-line connector (callout 1), and then release one retainer (callout 2).

---

 **TIP:** Reverse the removal steps to install the assembly.

---

Figure 5-1339 Disconnect one connector and release retainer

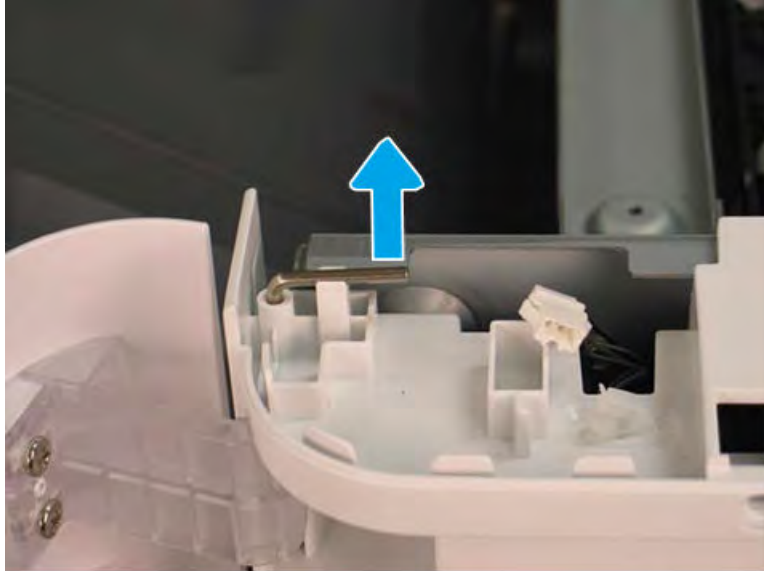


### Remove the front door (finisher)

Follow these steps to remove the front door (finisher).

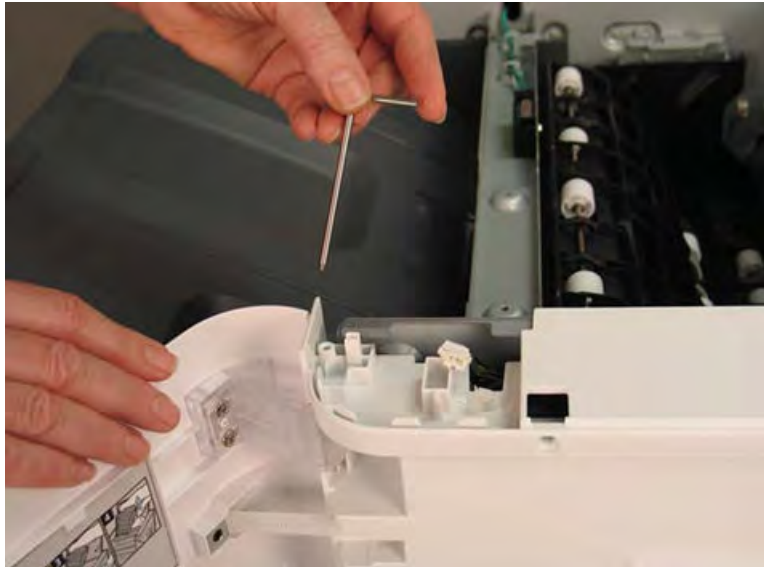
1. Lift the top hinge pin up to release it from the retainer.

Figure 5-1340 Lift the top hinge pin



2. Pull the top hinge pin up to remove it.

Figure 5-1341 Remove the top hinge pin



3. Use a small, flat-blade screwdriver to release the lower hinge pin from the retainer, and then rotate it away from the finisher.

**Figure 5-1342** Release the lower hinge pin




4. Support the door with one hand, and then pull the lower hinge pin straight up to remove it.

**Figure 5-1343** Remove the lower hinge pin

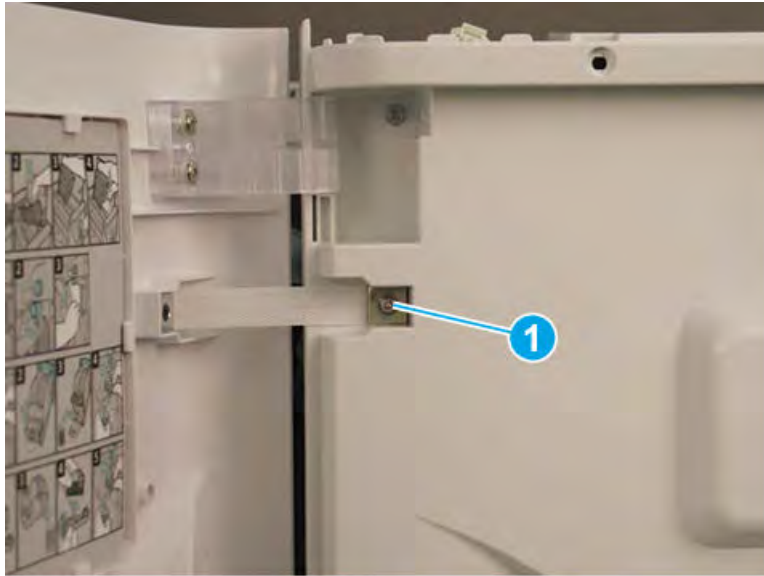




5. Support the door with one hand, and then remove one screw (callout 1) to release the strap. Remove the front door.

 **TIP:** Reverse the removal steps to install the assembly.

**Figure 5-1344** Remove the front door

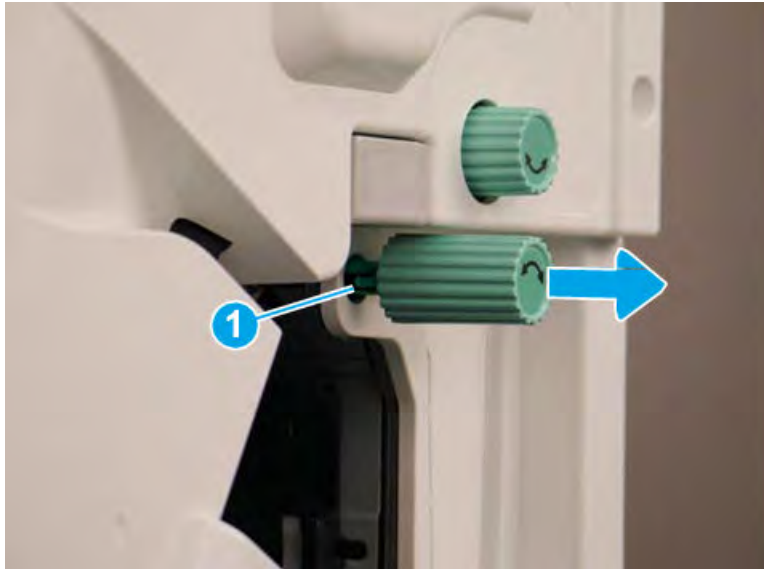


#### Remove the front cover (finisher)

Follow these steps to remove the front cover (finisher).

1. Release one tab (callout 1), and then pull the jam-access knob away from the finisher to remove it.

**Figure 5-1345** Remove the jam-access knob



2. If the punch unit is installed, remove the punch waste bin (callout 1).


3. Remove one screw (callout 1) on top of the front cover.

Figure 5-1346 Remove one screw



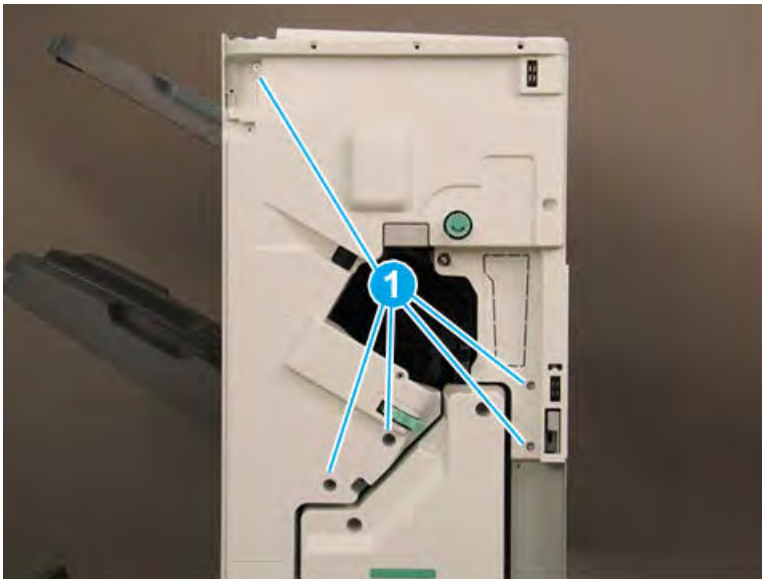
4. Remove five machine screws (callout 1), and then remove the front cover.

---

 **TIP:** Reverse the removal steps to install the assembly.

---

Figure 5-1347 Remove the front cover

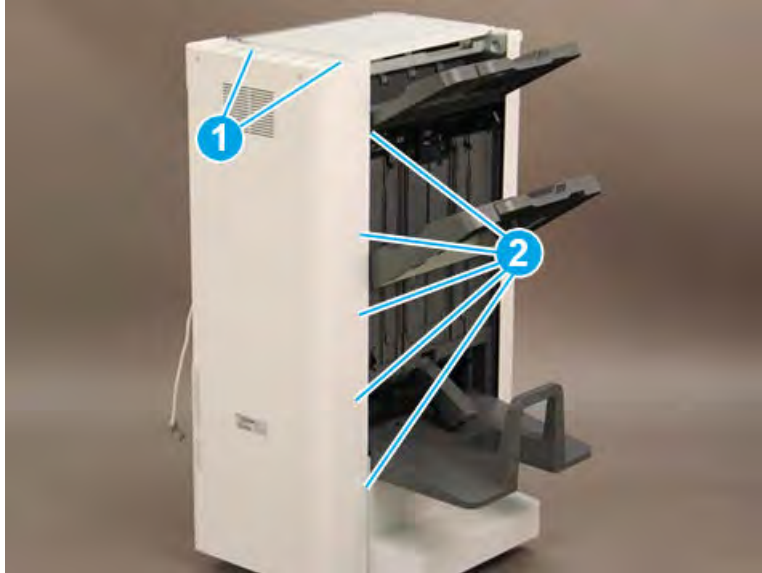


### Remove the rear cover (finisher)

Follow these steps to remove the rear cover (finisher).

1. Remove two self-tapping screws (callout 1) on the top of the rear cover, and then remove five screw caps and five machine screws (callout 2) on the left side of the cover.

Figure 5-1348 Remove seven screws



2. Remove one screw cap and four machine screws (callout 1) Remove the rear cover.

 **NOTE:** Make sure to thread the power cable (callout 2) through the opening in the cover.


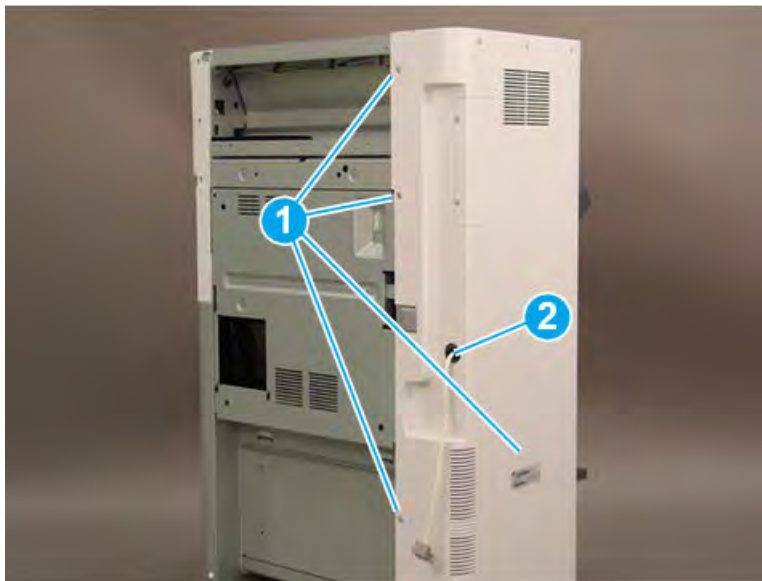
 **TIP:** Reverse the removal steps to install the assembly

Figure 5-1349 Remove the rear cover



### Remove the booklet output tray

Follow these steps to remove the booklet output tray.

1. Raise the booklet output tray up (callout 1), and then pull it away from the finisher (callout 2) to remove it.

Figure 5-1350 Remove the booklet output tray



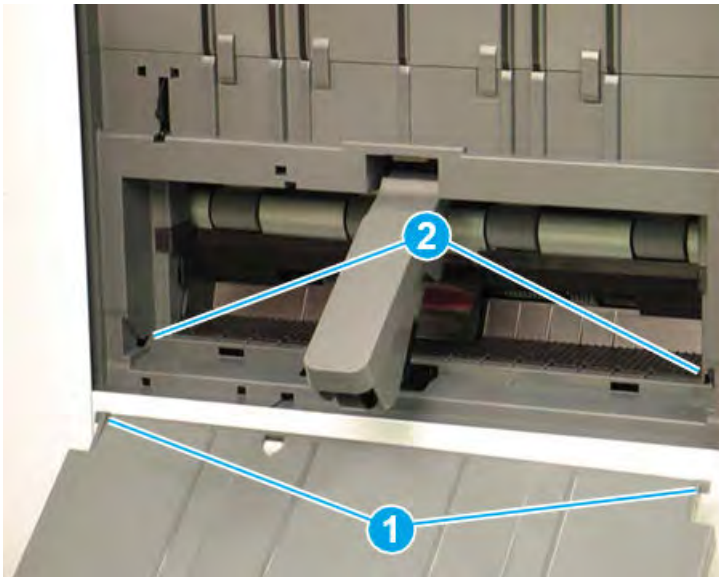
2. Reverse the removal steps to install the assembly. Also use the following special installation instructions.

 **NOTE:** Continue to reverse the removal steps to finish installing the assembly

Special installation instructions: booklet output tray

Position the tabs (callout 1) on the tray into the slots (callout 2) on the finisher.

Figure 5-1351 Install the booklet output tray

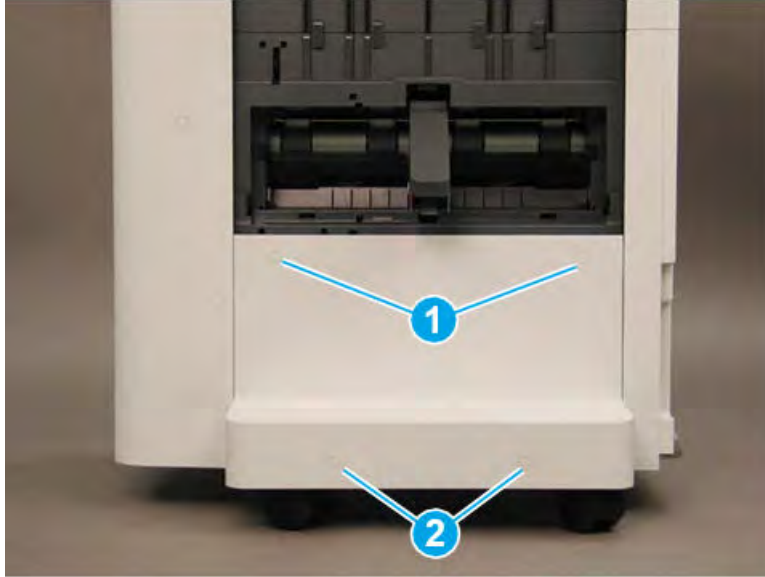


### Remove the caster cover

Follow these steps to remove the caster cover.

1. Remove two screw caps and two self-tapping screws (callout 1). Remove two screw caps and two machine screws (callout 2).

Figure 5-1352 Remove four screws



2. Rotate the left edge of the cover away from the finisher (callout 1), and then slide the cover to the left (callout 2) to remove it.

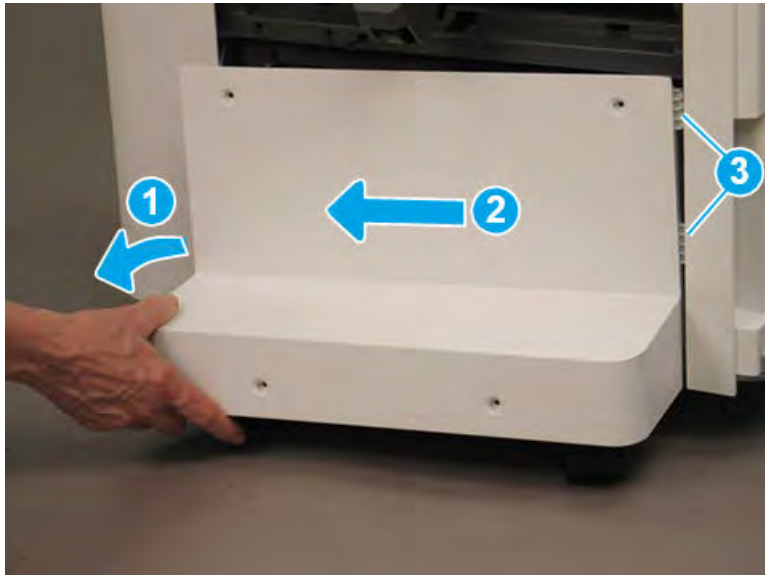
---

 **TIP:** Make sure that two tabs (callout 3) are positioned under the front lower cover when reinstalling the caster cover.

**TIP:** Reverse the removal steps to install the assembly

---

Figure 5-1353 Remove the caster cover




### Remove the left lower cover (finisher)

Follow these steps to remove the left lower cover (finisher).

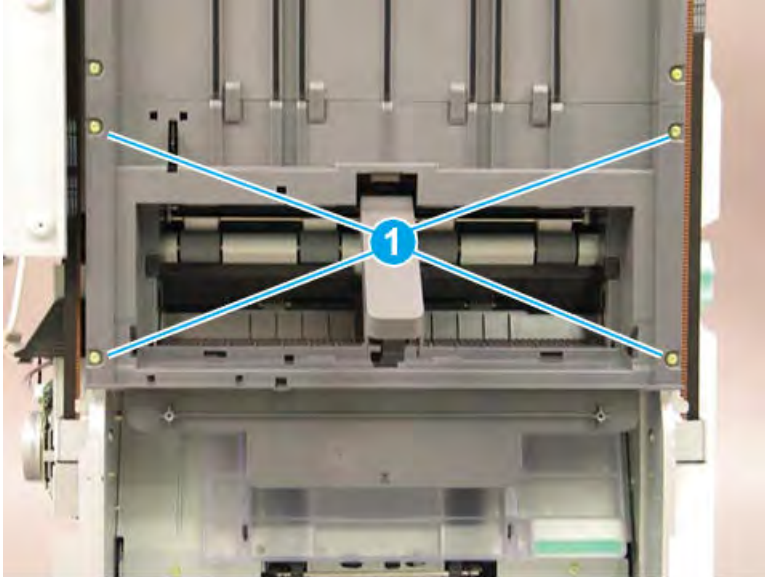
1. Remove four screws (callout 1).

---

 **NOTE:** Raise the lower output tray as needed to access the screws.

---

Figure 5-1354 Remove four screws

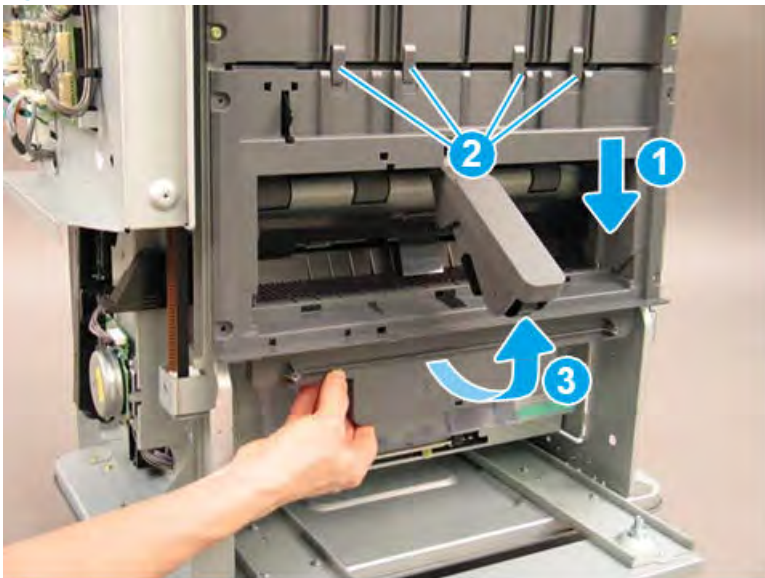


2. Slide the shield down (callout 1) to release it from four tabs (callout 2), and then rotate it away from the finisher (callout 3).

**⚠ CAUTION:** The shield is still attached to the finisher. Do not attempt to completely remove the shield.

**💡 TIP:** Position the shield under the four tabs (callout 2) when reinstalling it.

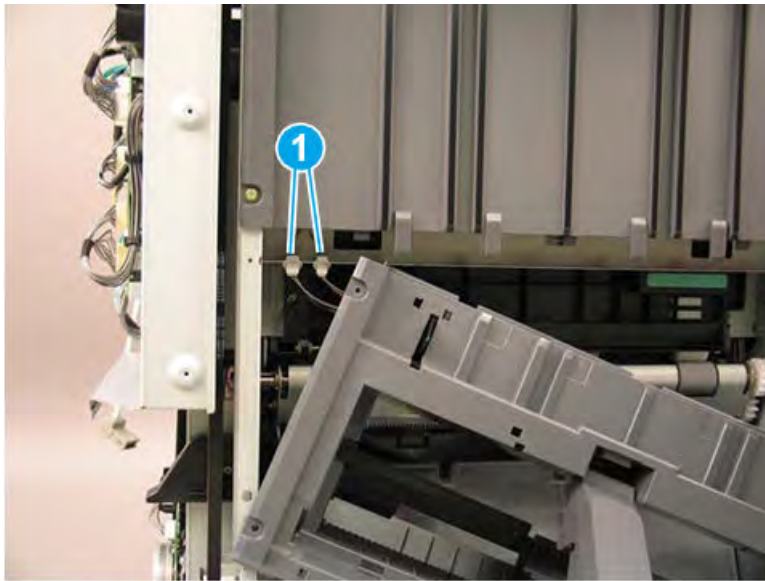
Figure 5-1355 Release the lower shield



3. Disconnect two connectors (callout 1), and then remove the shield.

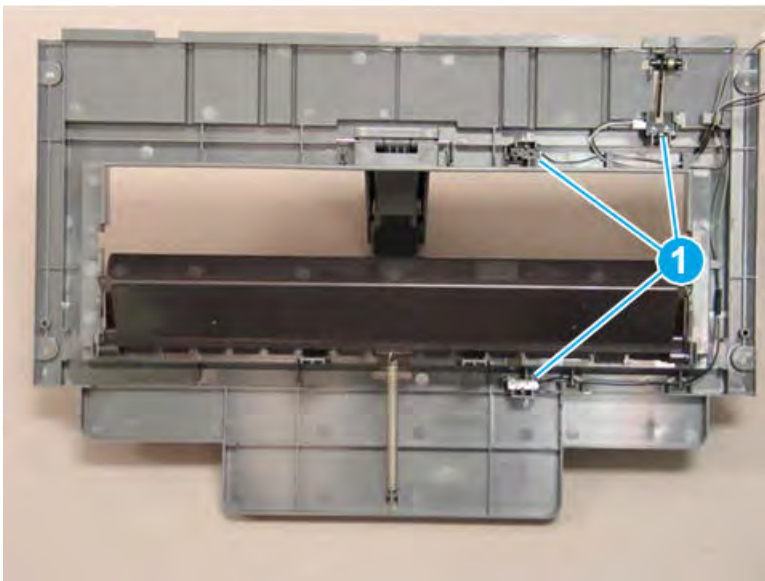
 **TIP:** Reverse the removal steps to install the assembly.

**Figure 5-1356** Disconnect two connectors



4. If you are replacing the left lower cover, locate three sensors (callout 1) on the back of the left lower cover. Remove these sensors and transfer them to the replacement part.

**Figure 5-1357** Remove the left lower cover

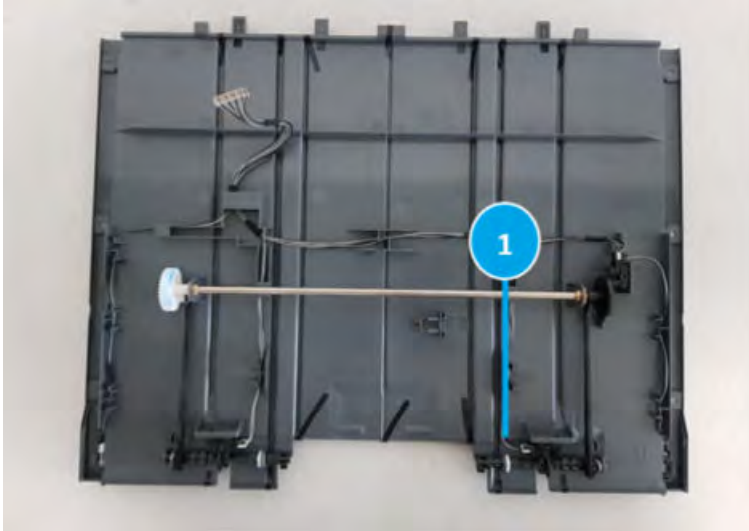


### Remove the paper holding sensor (S17)

Follow these steps to remove the paper holding sensor (S17).

- ▲ Remove the sensor (callout 1, S17) from the upper shield assembly.

Figure 5-1358 Remove the paper holding sensor



### Unpack the replacement assembly



Follow these steps to unpack the replacement assembly.


1. Dispose of the defective part.


 **NOTE:** HP recommends responsible disposal of the defective part.

<http://www8.hp.com/us/en/hp-information/environment/product-recycling.html>


2. Unpack the replacement part from the packaging.

 **CAUTION:**  Some parts are sensitive to electrostatic discharge (ESD). Always perform service work at an ESD-protected workstation or mat. If an ESD workstation or mat is not available, touch the sheet-metal chassis to provide a static ground before touching an ESD-sensitive assembly. Protect the ESD-sensitive assemblies by placing them in ESD pouches when they are out of the printer.

 **IMPORTANT:** Make sure that all of the shipping materials (for example shipping tape) are removed from the replacement part prior to installation.

 **NOTE:** If the replacement part is a roller or pad, avoid touching the spongy part of it. Skin oils on the roller or pad can cause paper pickup and/or print-quality problems. HP recommends using disposable gloves when handling rollers or pads or washing your hands before touching rollers or pads.

3. To install an assembly, reverse the removal steps.

 **NOTE:** When applicable, special installation instructions are provided for an assembly at the end of the removal procedure. Always completely read the removal instructions and follow all special installation instructions.



## Removal and replacement: Paper holding rear sensor (S31)

Learn how to remove and replace the rear paper holding sensor.

### Introduction

This document provides the procedures to remove and replace the rear paper holding sensor on the finisher.



**IMPORTANT:** When applicable, special installation instructions are provided for an assembly at the end of the removal procedure. Always completely read the removal instructions and follow all special installation instructions.

### Before performing service

- Turn the printer power off. A shutting-down message appears on the control-panel display.
- ⚠ **WARNING!** To avoid damage to the printer, turn the power off and wait until the printer shuts down before removing the power cable.
- Disconnect the printer power cable after the printer has completely shut down (the control-panel display is blank).
- Release the finisher from the printer by pulling out on the release latch inside the finisher door.
- Disconnect the cable from the bridge unit to the finisher.
- Disconnect the cable from the finisher to the printer.

Use the table below to identify the correct part number for your printer. To order the part, go to <https://parts.hp.com>.

**Table 5-139** Part information

Part number	Part description
0604-001393	Rear paper holding sensor

### Required tools

- #2 JIS screwdriver with a magnetic tip

### After performing service

- Connect the cable from the finisher to the printer.
- Connect the cable from the bridge unit to the finisher.
- Attach the finisher to the printer, and then push in on the release latch inside the finisher door.
- Connect the printer power cable.
- Turn the printer power on.

### Post service test

Process a job through the finisher and verify that the finisher works correctly.

### Remove the right upper cover (finisher)

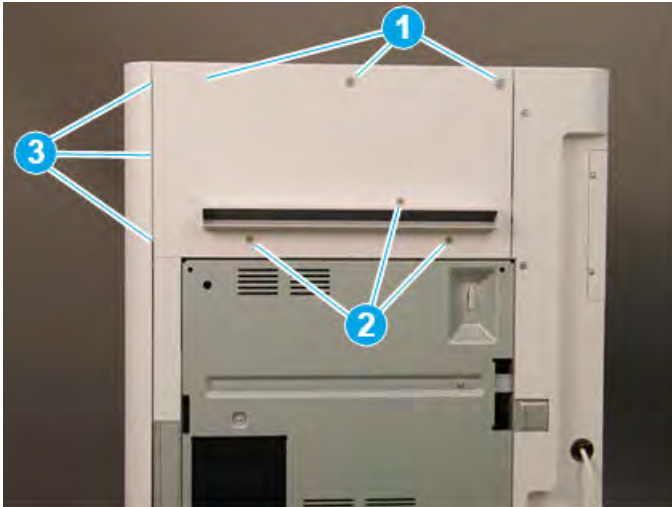
Follow these steps to remove the right upper cover (finisher).

- ▲ Remove one screw cap and three machine screws on the upper edge of the cover (callout 1). Remove three sheet metal screws (callout 2) on the lower portion of the cover. Rotate the right edge of the cover away from the finisher, and then slide the cover right to release three tabs (callout 3).

💡 **TIP:** The lower screws are shorter in length than the upper screws.

**TIP:** Reverse the removal steps to install the assembly.

**Figure 5-1359** Remove the right upper cover

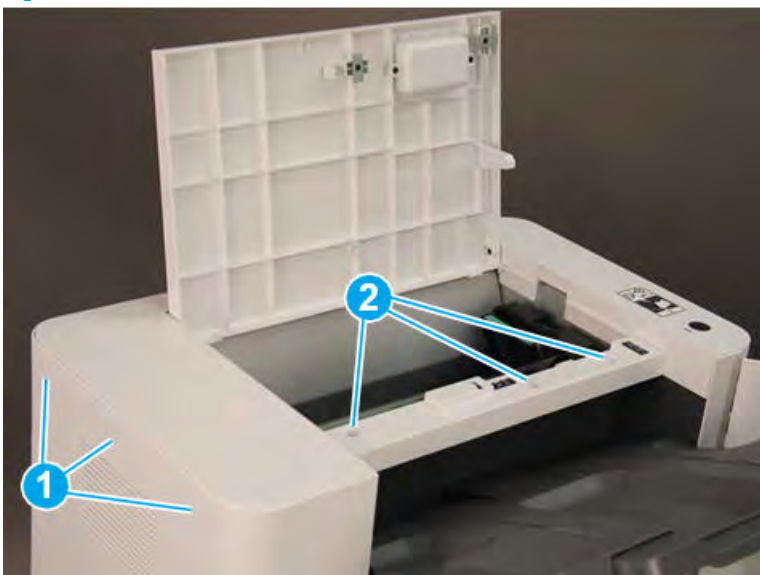


### Remove the top cover (finisher)

Follow these steps to remove the top cover (finisher).

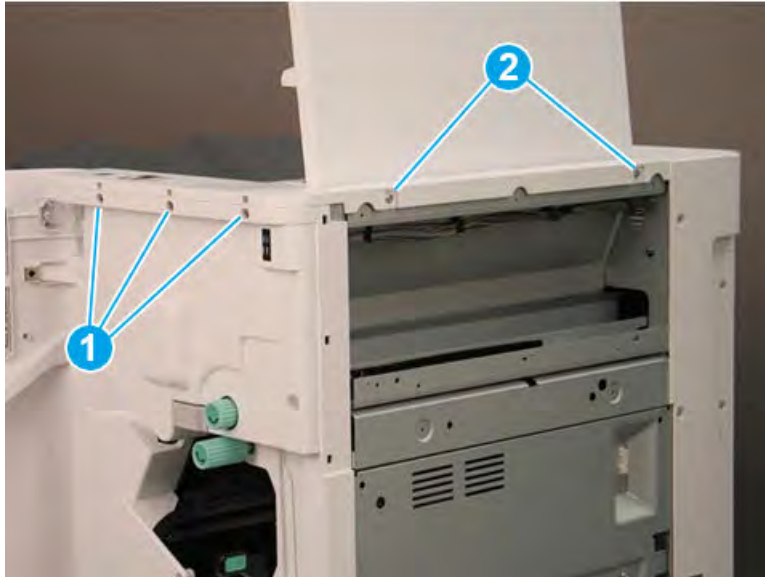
1. Remove three screw caps and three self-tapping screws at the top of the rear cover (callout 1), and then remove three machine screws (callout 2) on top of the cover.

**Figure 5-1360** Remove six screws



2. Remove three self-tapping screws at the top of the front cover (callout 1), and then remove two machine screws (callout 2) at the top of the right side.

Figure 5-1361 Remove five screws



3. Lift the cover up slightly. Disconnect one in-line connector (callout 1), and then release one retainer (callout 2).


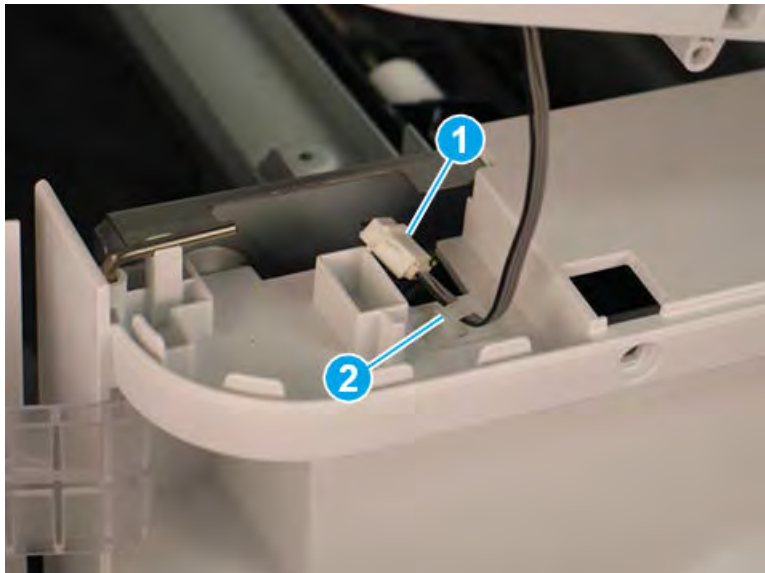
 **TIP:** Reverse the removal steps to install the assembly.

Figure 5-1362 Disconnect one connector and release retainer

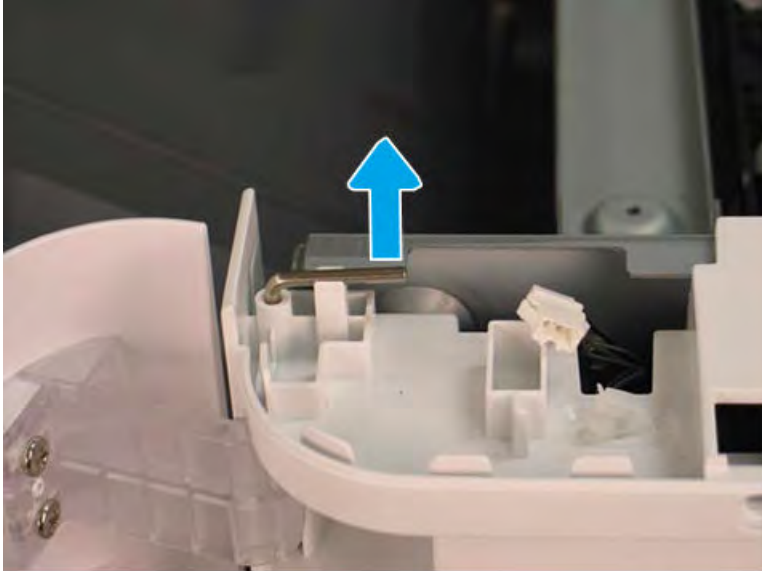


### Remove the front door (finisher)

Follow these steps to remove the front door (finisher).

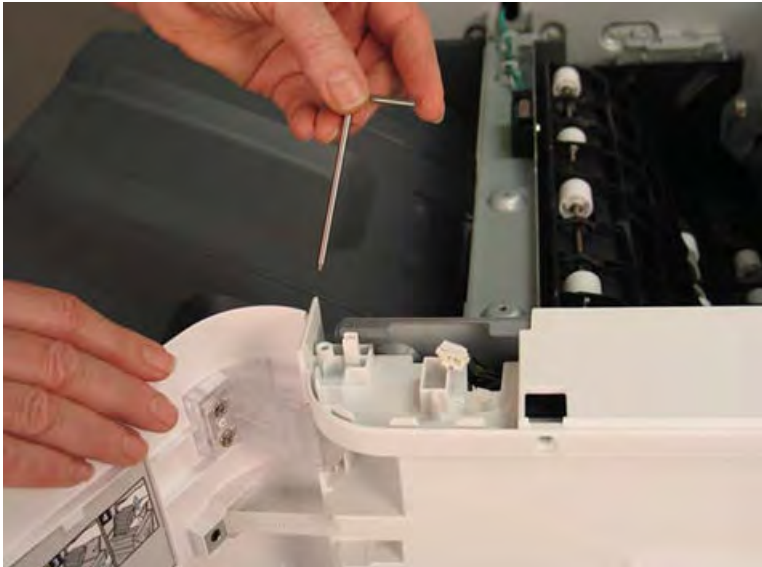
1. Lift the top hinge pin up to release it from the retainer.

Figure 5-1363 Lift the top hinge pin



2. Pull the top hinge pin up to remove it.

Figure 5-1364 Remove the top hinge pin



3. Use a small, flat-blade screwdriver to release the lower hinge pin from the retainer, and then rotate it away from the finisher.

Figure 5-1365 Release the lower hinge pin




4. Support the door with one hand, and then pull the lower hinge pin straight up to remove it.

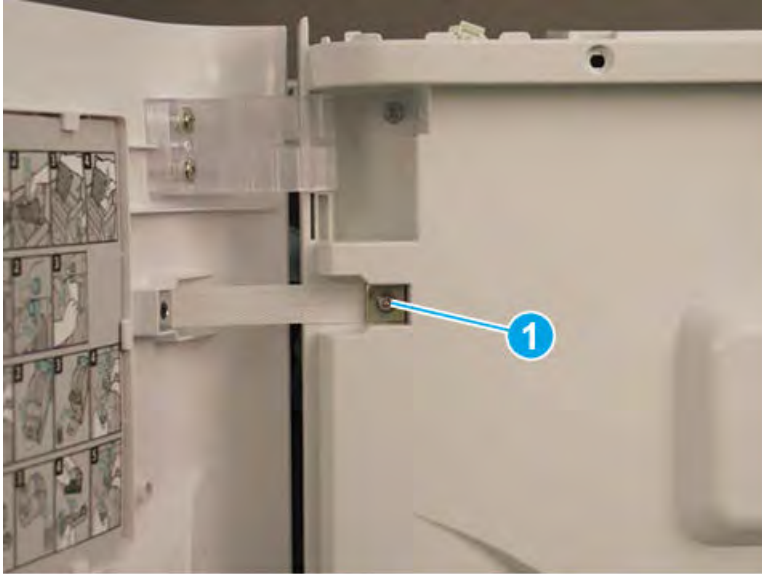
Figure 5-1366 Remove the lower hinge pin



5. Support the door with one hand, and then remove one screw (callout 1) to release the strap. Remove the front door.

 **TIP:** Reverse the removal steps to install the assembly.

**Figure 5-1367** Remove the front door

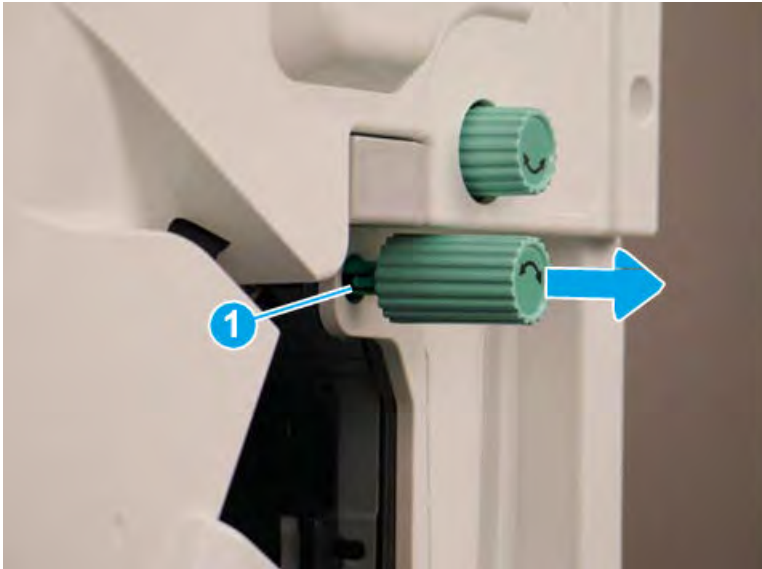


#### Remove the front cover (finisher)

Follow these steps to remove the front cover (finisher).

1. Release one tab (callout 1), and then pull the jam-access knob away from the finisher to remove it.

**Figure 5-1368** Remove the jam-access knob



2. If the punch unit is installed, remove the punch waste bin (callout 1).


3. Remove one screw (callout 1) on top of the front cover.

Figure 5-1369 Remove one screw



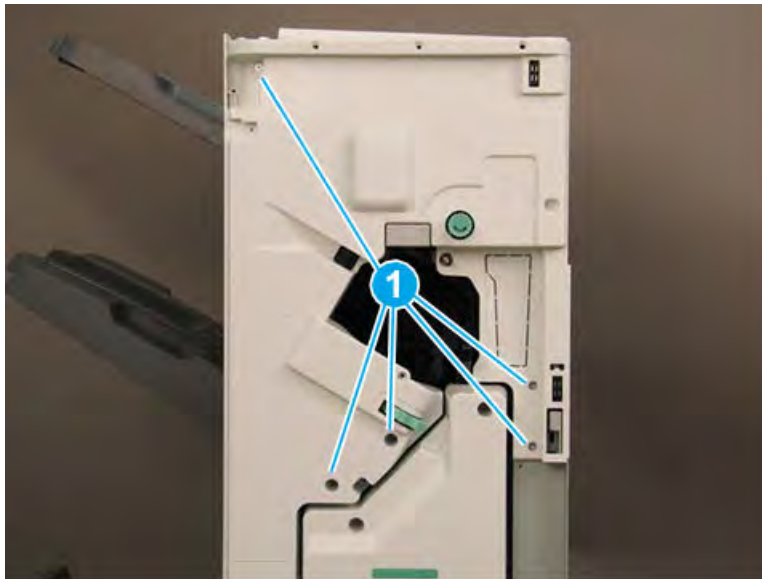
4. Remove five machine screws (callout 1), and then remove the front cover.

---

 **TIP:** Reverse the removal steps to install the assembly.

---

Figure 5-1370 Remove the front cover

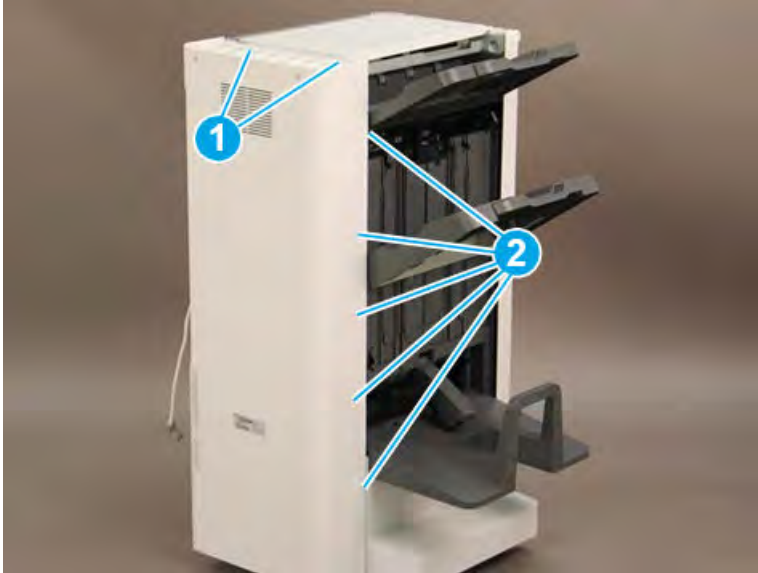


### Remove the rear cover (finisher)

Follow these steps to remove the rear cover (finisher).

1. Remove two self-tapping screws (callout 1) on the top of the rear cover, and then remove five screw caps and five machine screws (callout 2) on the left side of the cover.

Figure 5-1371 Remove seven screws

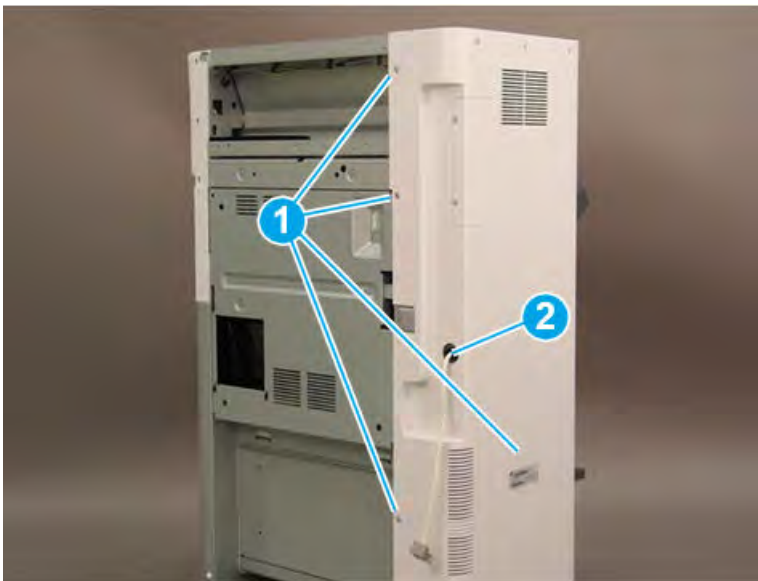


2. Remove one screw cap and four machine screws (callout 1) Remove the rear cover.

 **NOTE:** Make sure to thread the power cable (callout 2) through the opening in the cover.

 **TIP:** Reverse the removal steps to install the assembly

Figure 5-1372 Remove the rear cover



### Remove the booklet output tray

Follow these steps to remove the booklet output tray.

1. Raise the booklet output tray up (callout 1), and then pull it away from the finisher (callout 2) to remove it.



Figure 5-1373 Remove the booklet output tray



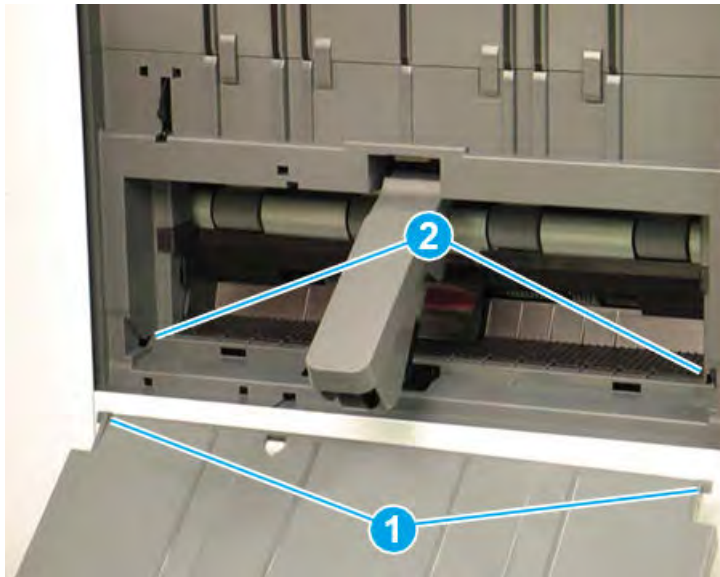
2. Reverse the removal steps to install the assembly. Also use the following special installation instructions.

 **NOTE:** Continue to reverse the removal steps to finish installing the assembly

Special installation instructions: booklet output tray

Position the tabs (callout 1) on the tray into the slots (callout 2) on the finisher.

Figure 5-1374 Install the booklet output tray

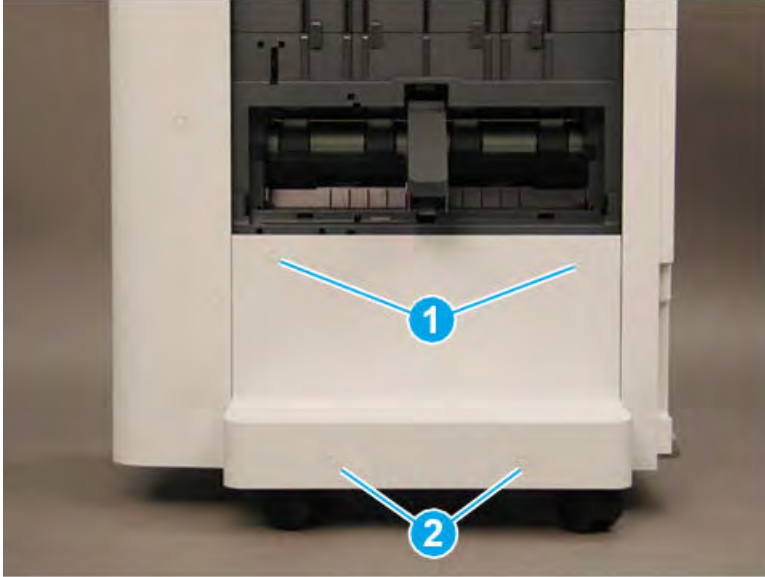


### Remove the caster cover

Follow these steps to remove the caster cover.


1. Remove two screw caps and two self-tapping screws (callout 1). Remove two screw caps and two machine screws (callout 2).

Figure 5-1375 Remove four screws



2. Rotate the left edge of the cover away from the finisher (callout 1), and then slide the cover to the left (callout 2) to remove it.

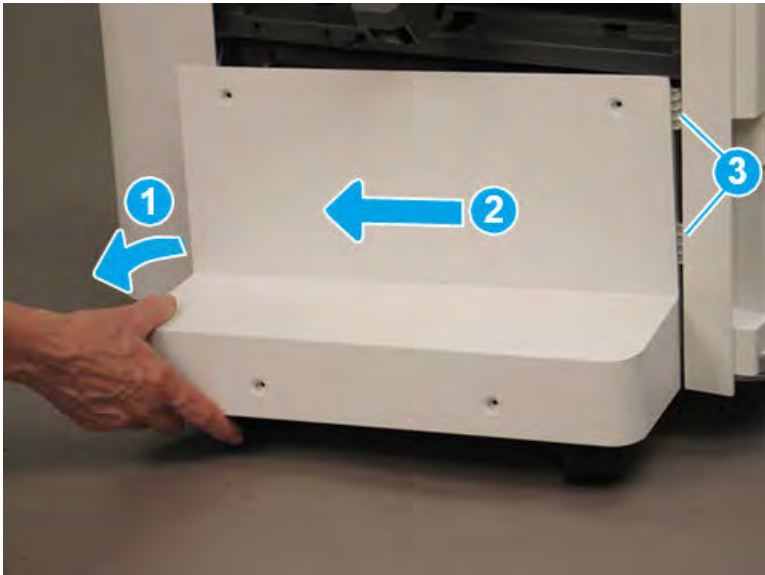
---

 **TIP:** Make sure that two tabs (callout 3) are positioned under the front lower cover when reinstalling the caster cover.

**TIP:** Reverse the removal steps to install the assembly

---

Figure 5-1376 Remove the caster cover




### Remove the left lower cover (finisher)

Follow these steps to remove the left lower cover (finisher).

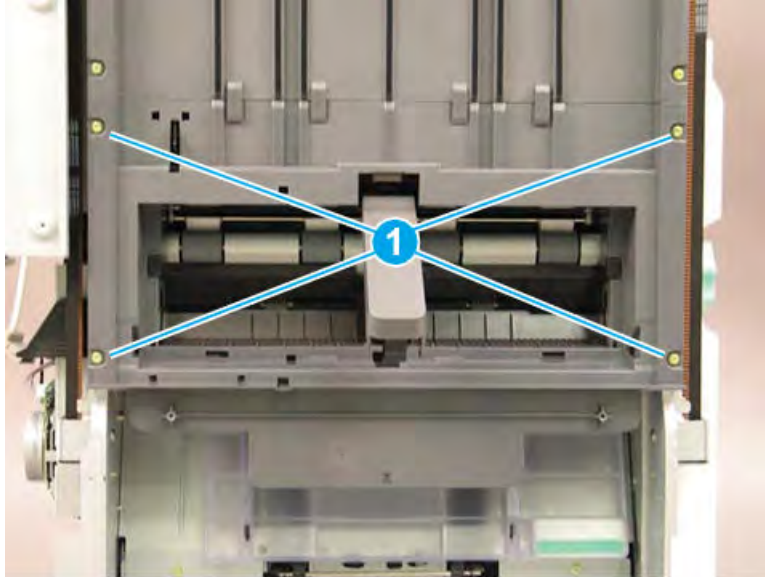
1. Remove four screws (callout 1).

---

 **NOTE:** Raise the lower output tray as needed to access the screws.

---

Figure 5-1377 Remove four screws

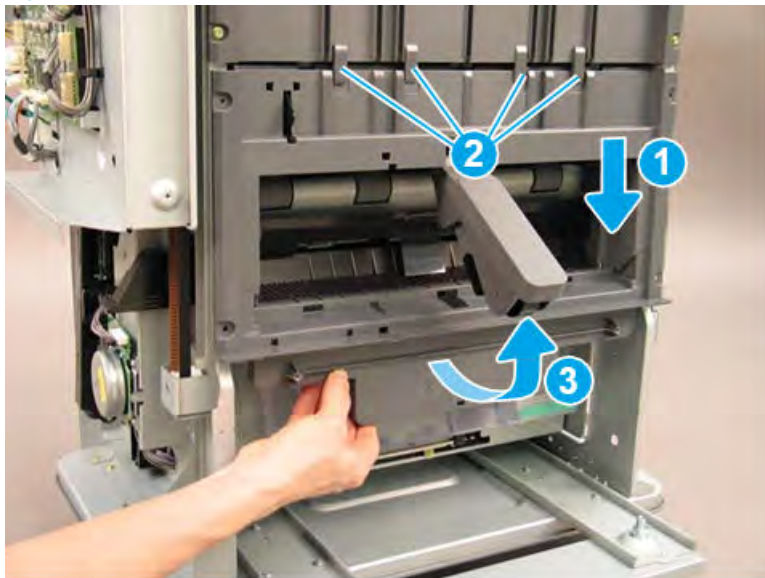


2. Slide the shield down (callout 1) to release it from four tabs (callout 2), and then rotate it away from the finisher (callout 3).


**⚠ CAUTION:** The shield is still attached to the finisher. Do not attempt to completely remove the shield.

**💡 TIP:** Position the shield under the four tabs (callout 2) when reinstalling it.

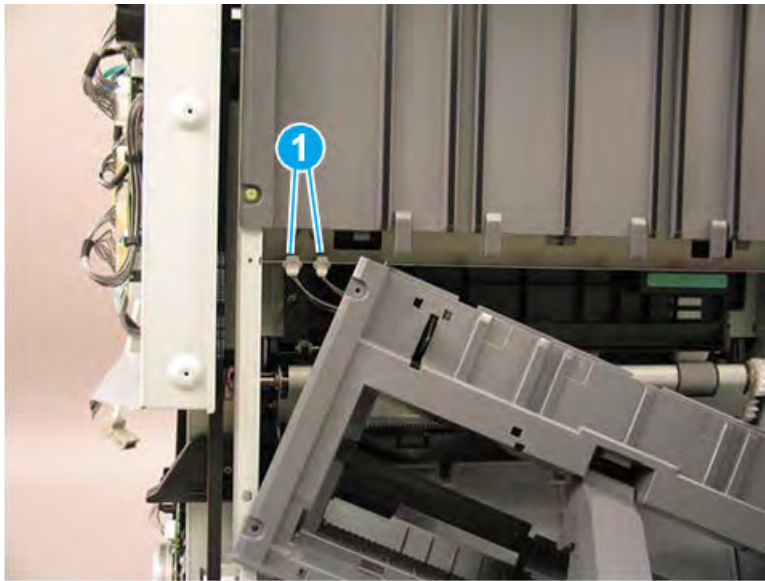
Figure 5-1378 Release the lower shield



3. Disconnect two connectors (callout 1), and then remove the shield.

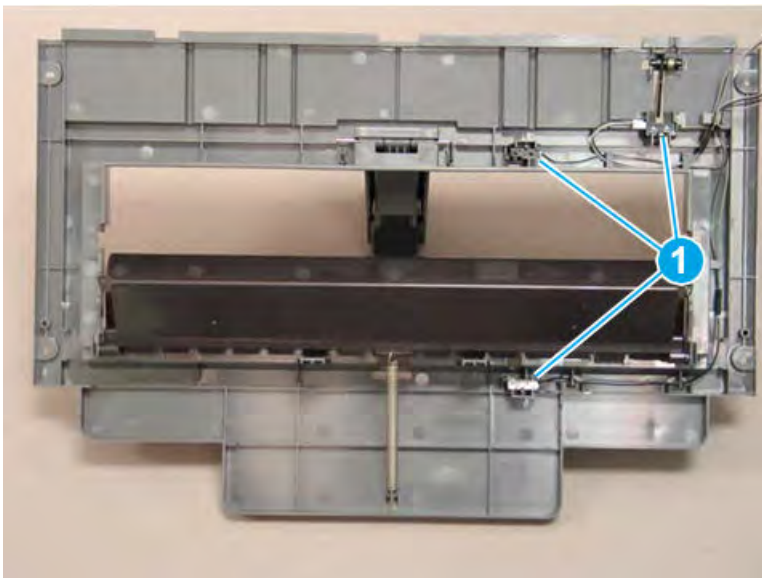
 **TIP:** Reverse the removal steps to install the assembly.

**Figure 5-1379** Disconnect two connectors



4. If you are replacing the left lower cover, locate three sensors (callout 1) on the back of the left lower cover. Remove these sensors and transfer them to the replacement part.

**Figure 5-1380** Remove the left lower cover

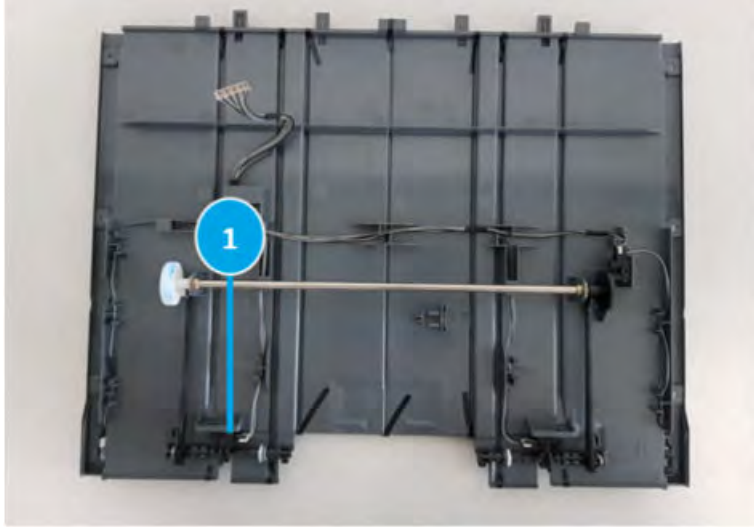


### Remove the rear paper holding sensor(S31)

Follow these steps to remove the rear paper holding sensor(S31).

- ▲ Remove the sensor(S31, callout 1) from the upper shield assembly.

Figure 5-1381 Remove the rear paper holding sensor



### Unpack the replacement assembly



Follow these steps to unpack the replacement assembly.


1. Dispose of the defective part.


 **NOTE:** HP recommends responsible disposal of the defective part.

<http://www8.hp.com/us/en/hp-information/environment/product-recycling.html>


2. Unpack the replacement part from the packaging.

 **CAUTION:**  Some parts are sensitive to electrostatic discharge (ESD). Always perform service work at an ESD-protected workstation or mat. If an ESD workstation or mat is not available, touch the sheet-metal chassis to provide a static ground before touching an ESD-sensitive assembly. Protect the ESD-sensitive assemblies by placing them in ESD pouches when they are out of the printer.

 **IMPORTANT:** Make sure that all of the shipping materials (for example shipping tape) are removed from the replacement part prior to installation.

 **NOTE:** If the replacement part is a roller or pad, avoid touching the spongy part of it. Skin oils on the roller or pad can cause paper pickup and/or print-quality problems. HP recommends using disposable gloves when handling rollers or pads or washing your hands before touching rollers or pads.

3. To install an assembly, reverse the removal steps.


 **NOTE:** When applicable, special installation instructions are provided for an assembly at the end of the removal procedure. Always completely read the removal instructions and follow all special installation instructions.

## Removal and replacement: Paper holding Motor (M7)

Learn how to remove and replace the paper holding Motor.

### Introduction

This document provides the procedures to remove and replace the paper holding Motor on the finisher.

 **IMPORTANT:** When applicable, special installation instructions are provided for an assembly at the end of the removal procedure. Always completely read the removal instructions and follow all special installation instructions.

### Before performing service

- Turn the printer power off. A shutting-down message appears on the control-panel display.
- ⚠ **WARNING!** To avoid damage to the printer, turn the power off and wait until the printer shuts down before removing the power cable.
- Disconnect the printer power cable after the printer has completely shut down (the control-panel display is blank).
- Release the finisher from the printer by pulling out on the release latch inside the finisher door.
- Disconnect the cable from the bridge unit to the finisher.
- Disconnect the cable from the finisher to the printer.

Use the table below to identify the correct part number for your printer. To order the part, go to <https://parts.hp.com>.

**Table 5-140** Part information

Part number	Part description
JC90-01414A	Paper holding motor assembly
JC93-01156A	Paper holding motor

### Required tools

- #2 JIS screwdriver with a magnetic tip

### After performing service

- Connect the cable from the finisher to the printer.
- Connect the cable from the bridge unit to the finisher.
- Attach the finisher to the printer, and then push in on the release latch inside the finisher door.
- Connect the printer power cable.
- Turn the printer power on.

### Post service test

Process a job through the finisher and verify that the finisher works correctly.

### Remove the right upper cover (finisher)

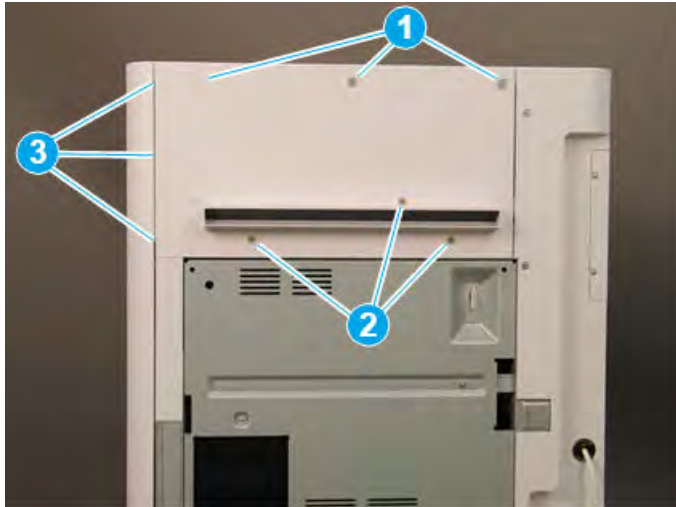
Follow these steps to remove the right upper cover (finisher).

- ▲ Remove one screw cap and three machine screws on the upper edge of the cover (callout 1). Remove three sheet metal screws (callout 2) on the lower portion of the cover. Rotate the right edge of the cover away from the finisher, and then slide the cover right to release three tabs (callout 3).

💡 **TIP:** The lower screws are shorter in length than the upper screws.

**TIP:** Reverse the removal steps to install the assembly.

Figure 5-1382 Remove the right upper cover

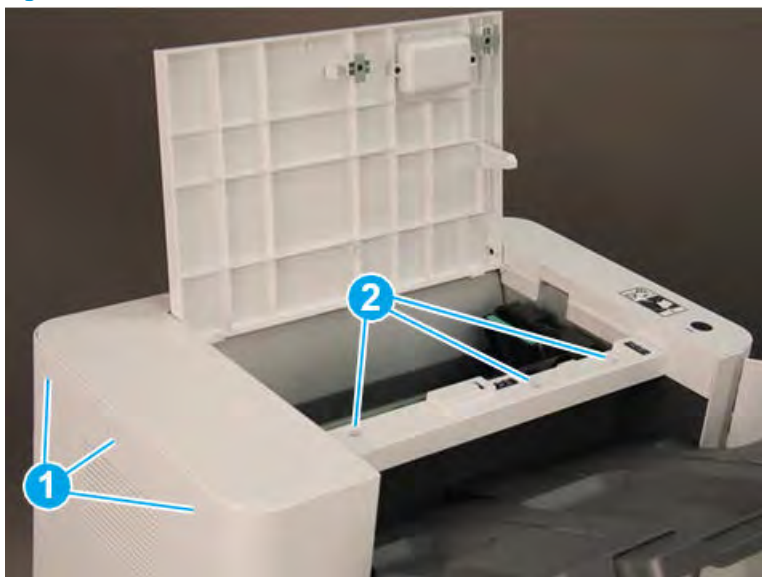


### Remove the top cover (finisher)

Follow these steps to remove the top cover (finisher).

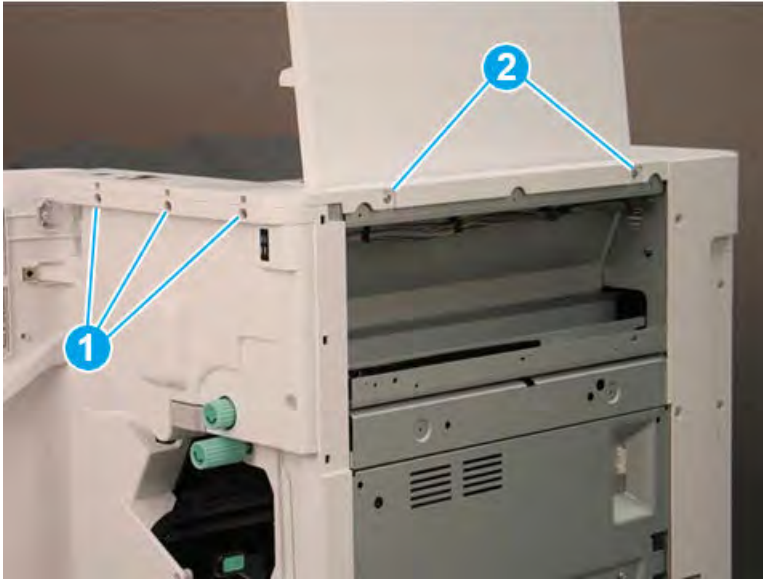
1. Remove three screw caps and three self-tapping screws at the top of the rear cover (callout 1), and then remove three machine screws (callout 2) on top of the cover.

Figure 5-1383 Remove six screws




2. Remove three self-tapping screws at the top of the front cover (callout 1), and then remove two machine screws (callout 2) at the top of the right side.

Figure 5-1384 Remove five screws



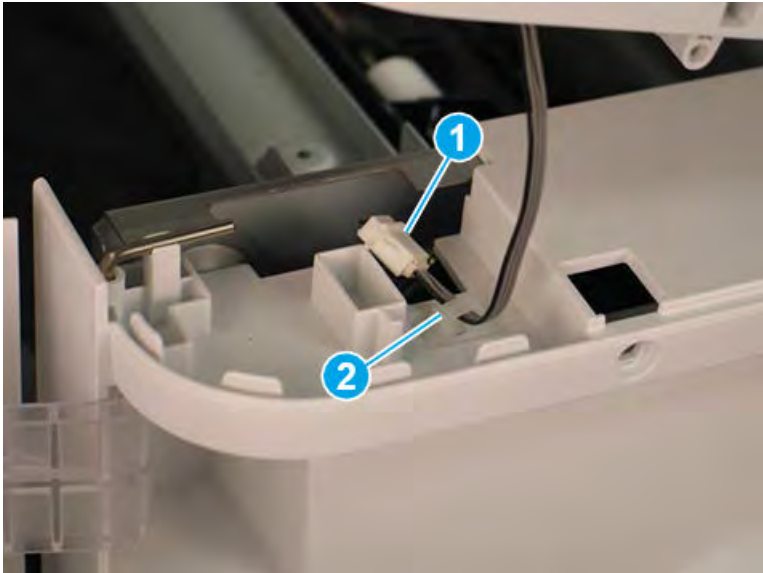
3. Lift the cover up slightly. Disconnect one in-line connector (callout 1), and then release one retainer (callout 2).

---

 **TIP:** Reverse the removal steps to install the assembly.

---

Figure 5-1385 Disconnect one connector and release retainer



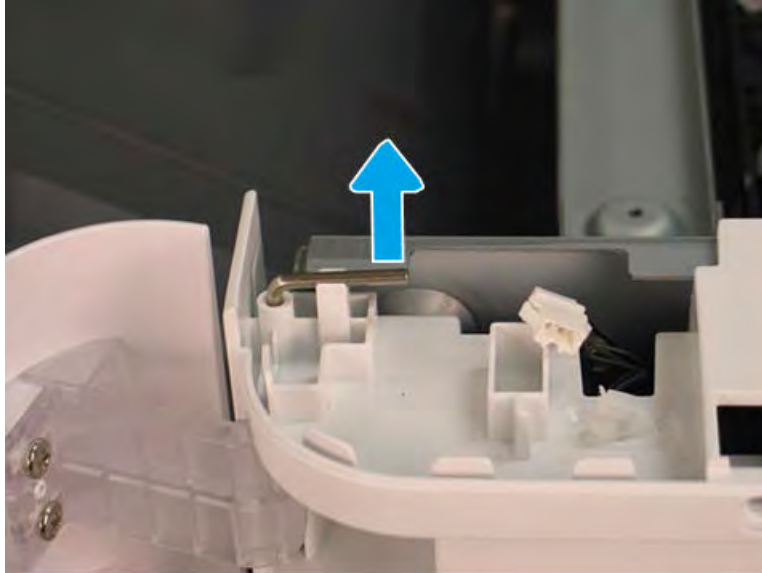
### Remove the front door (finisher)

Follow these steps to remove the front door (finisher).

1. Lift the top hinge pin up to release it from the retainer.

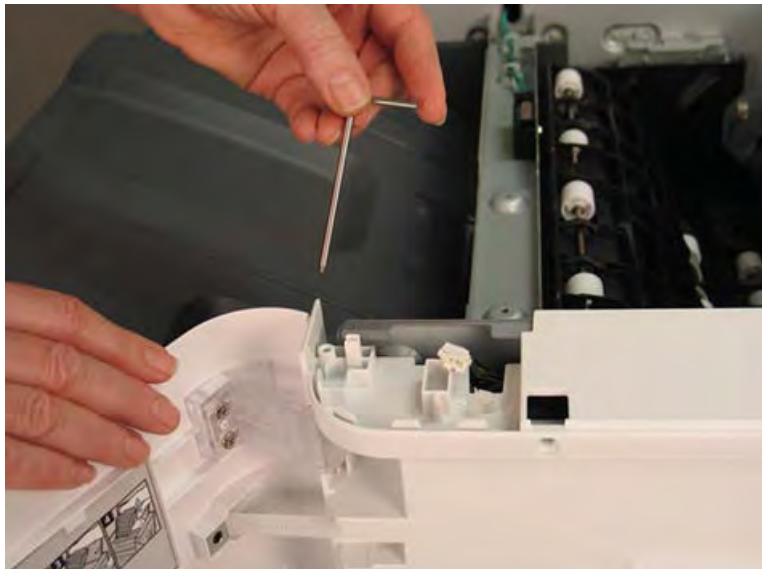


Figure 5-1386 Lift the top hinge pin



2. Pull the top hinge pin up to remove it.

Figure 5-1387 Remove the top hinge pin



3. Use a small, flat-blade screwdriver to release the lower hinge pin from the retainer, and then rotate it away from the finisher.

**Figure 5-1388** Release the lower hinge pin




4. Support the door with one hand, and then pull the lower hinge pin straight up to remove it.

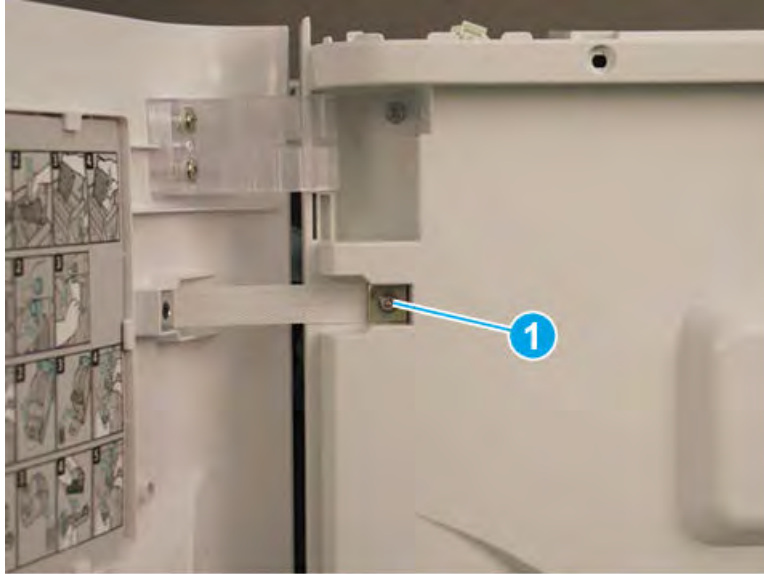
**Figure 5-1389** Remove the lower hinge pin



5. Support the door with one hand, and then remove one screw (callout 1) to release the strap. Remove the front door.

 **TIP:** Reverse the removal steps to install the assembly.

**Figure 5-1390** Remove the front door

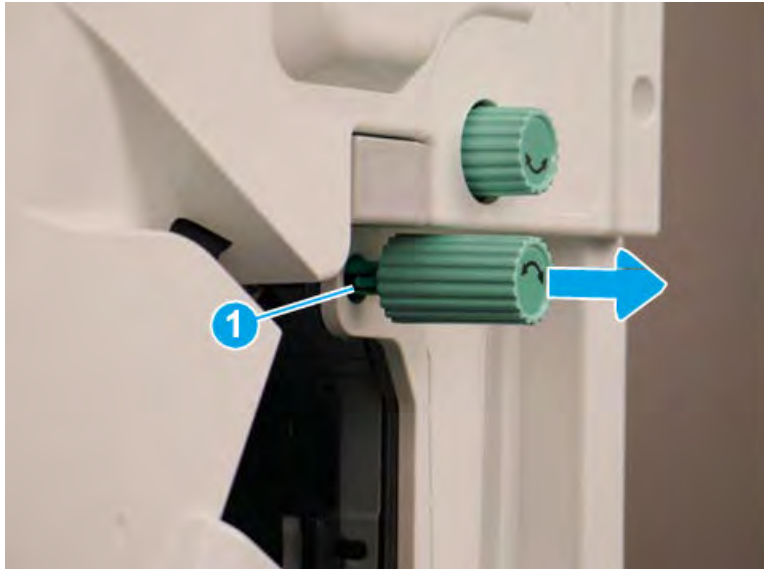


#### Remove the front cover (finisher)

Follow these steps to remove the front cover (finisher).

1. Release one tab (callout 1), and then pull the jam-access knob away from the finisher to remove it.

**Figure 5-1391** Remove the jam-access knob



2. If the punch unit is installed, remove the punch waste bin (callout 1).

3. Remove one screw (callout 1) on top of the front cover.

Figure 5-1392 Remove one screw



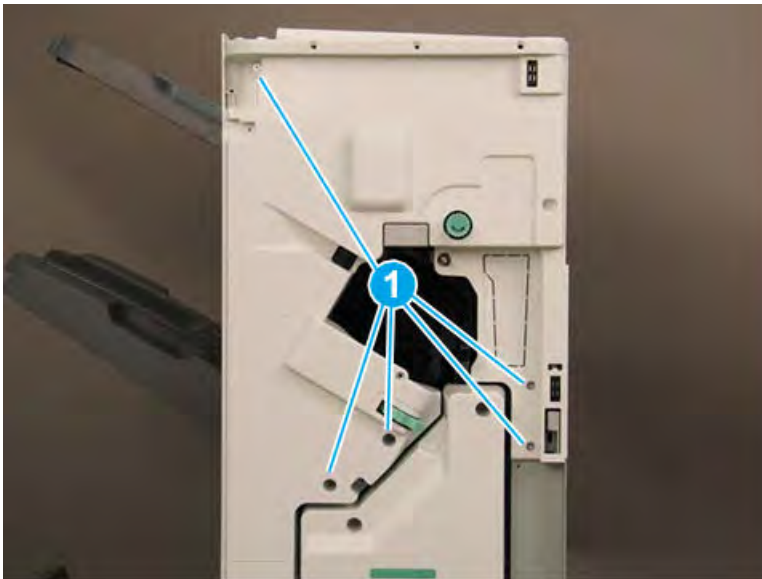
4. Remove five machine screws (callout 1), and then remove the front cover.

---

 **TIP:** Reverse the removal steps to install the assembly.

---

Figure 5-1393 Remove the front cover

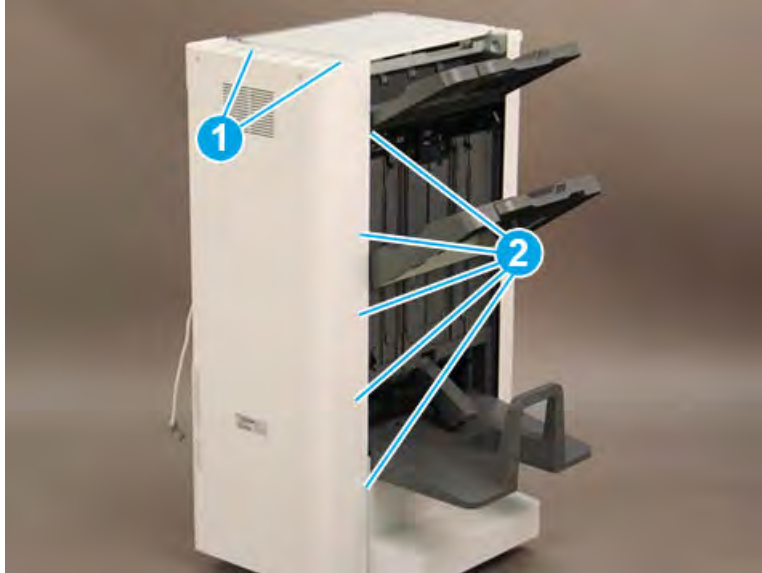


#### Remove the rear cover (finisher)

Follow these steps to remove the rear cover (finisher).

1. Remove two self-tapping screws (callout 1) on the top of the rear cover, and then remove five screw caps and five machine screws (callout 2) on the left side of the cover.

Figure 5-1394 Remove seven screws



2. Remove one screw cap and four machine screws (callout 1) Remove the rear cover.

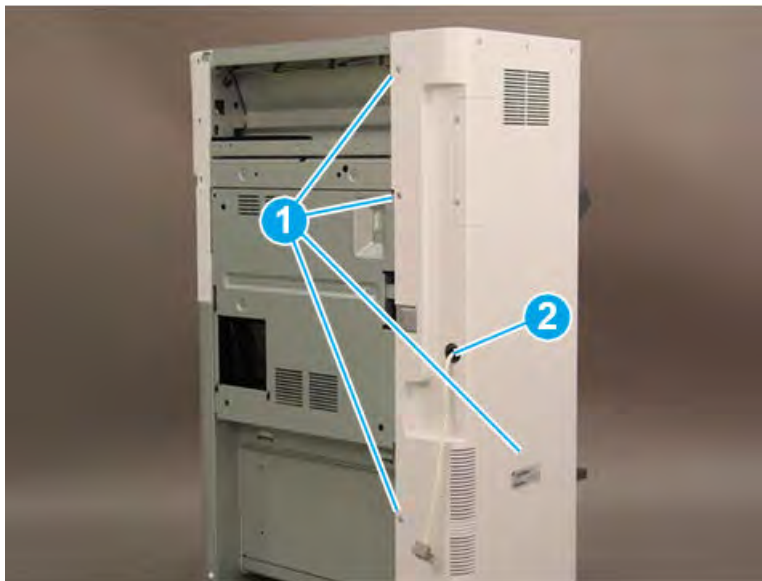
---

 **NOTE:** Make sure to thread the power cable (callout 2) through the opening in the cover.

 **TIP:** Reverse the removal steps to install the assembly

---

Figure 5-1395 Remove the rear cover



### Remove the booklet output tray

Follow these steps to remove the booklet output tray.

1. Raise the booklet output tray up (callout 1), and then pull it away from the finisher (callout 2) to remove it.

Figure 5-1396 Remove the booklet output tray



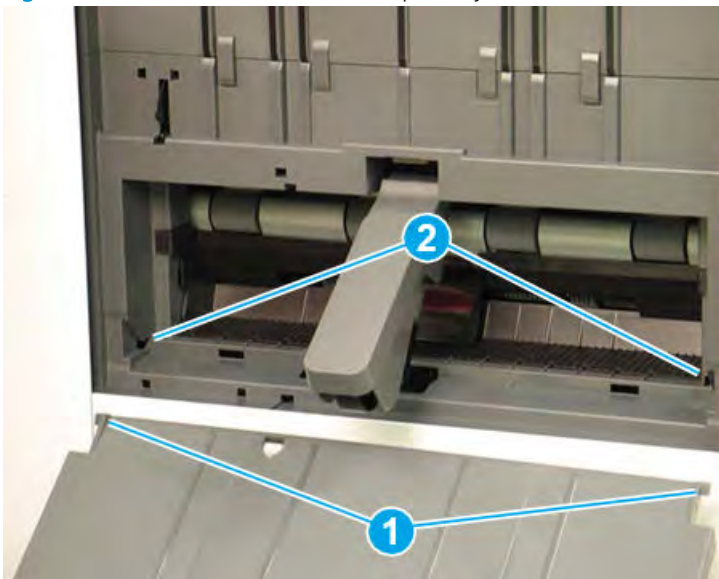
2. Reverse the removal steps to install the assembly. Also use the following special installation instructions.

 **NOTE:** Continue to reverse the removal steps to finish installing the assembly

Special installation instructions: booklet output tray

Position the tabs (callout 1) on the tray into the slots (callout 2) on the finisher.

Figure 5-1397 Install the booklet output tray

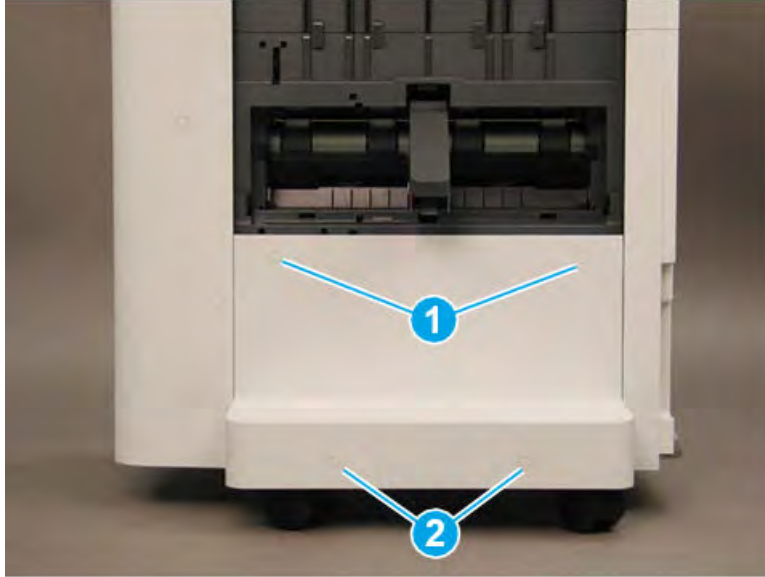


### Remove the caster cover

Follow these steps to remove the caster cover.

1. Remove two screw caps and two self-tapping screws (callout 1). Remove two screw caps and two machine screws (callout 2).

Figure 5-1398 Remove four screws



2. Rotate the left edge of the cover away from the finisher (callout 1), and then slide the cover to the left (callout 2) to remove it.

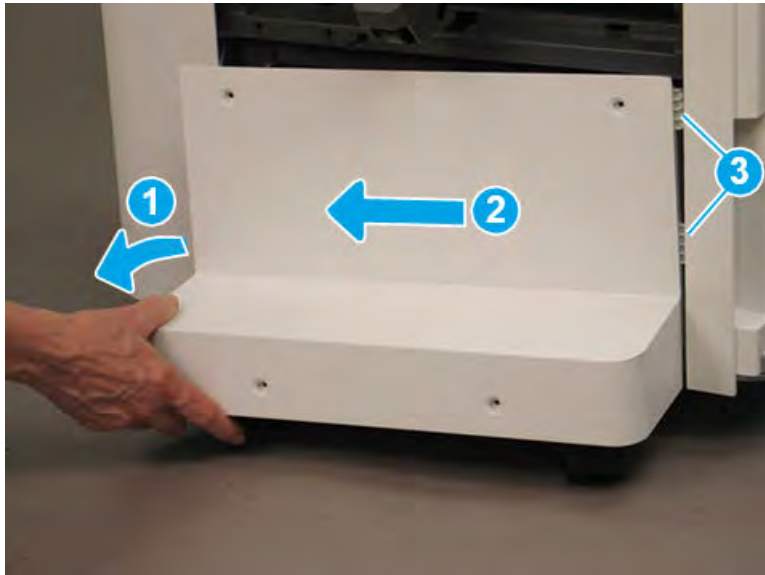
---

 **TIP:** Make sure that two tabs (callout 3) are positioned under the front lower cover when reinstalling the caster cover.

**TIP:** Reverse the removal steps to install the assembly

---

Figure 5-1399 Remove the caster cover




### Remove the left lower cover (finisher)

Follow these steps to remove the left lower cover (finisher).

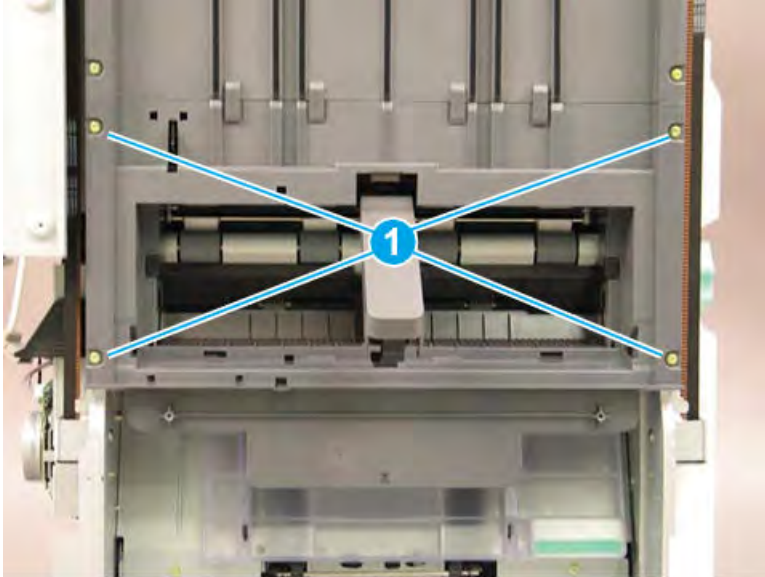
1. Remove four screws (callout 1).

---

 **NOTE:** Raise the lower output tray as needed to access the screws.

---

Figure 5-1400 Remove four screws



2. Slide the shield down (callout 1) to release it from four tabs (callout 2), and then rotate it away from the finisher (callout 3).

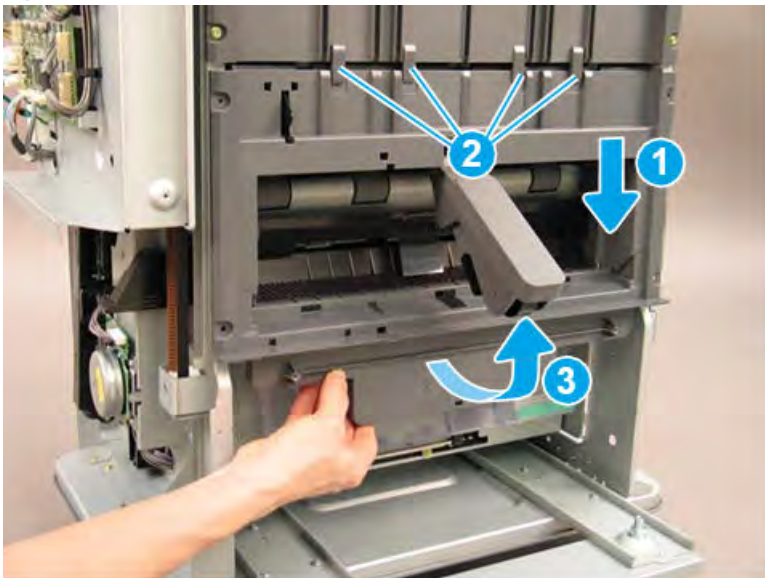
---

**⚠ CAUTION:** The shield is still attached to the finisher. Do not attempt to completely remove the shield.

**💡 TIP:** Position the shield under the four tabs (callout 2) when reinstalling it.

---

Figure 5-1401 Release the lower shield

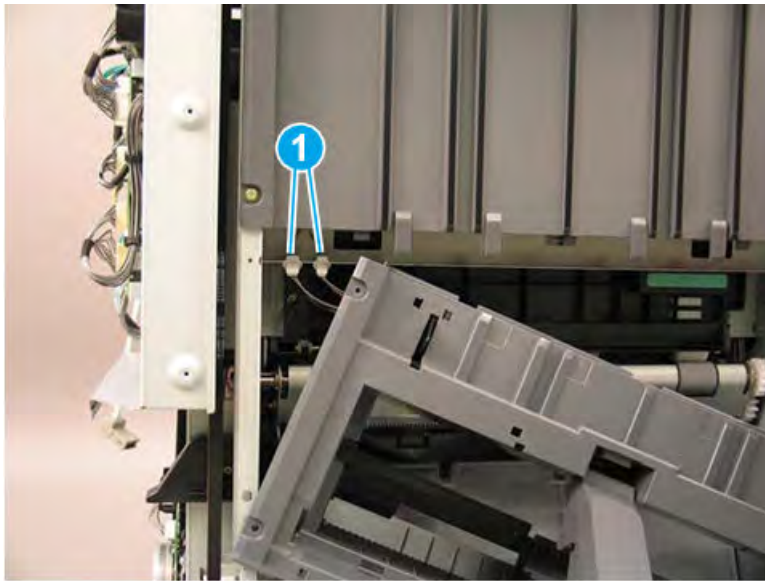




3. Disconnect two connectors (callout 1), and then remove the shield.

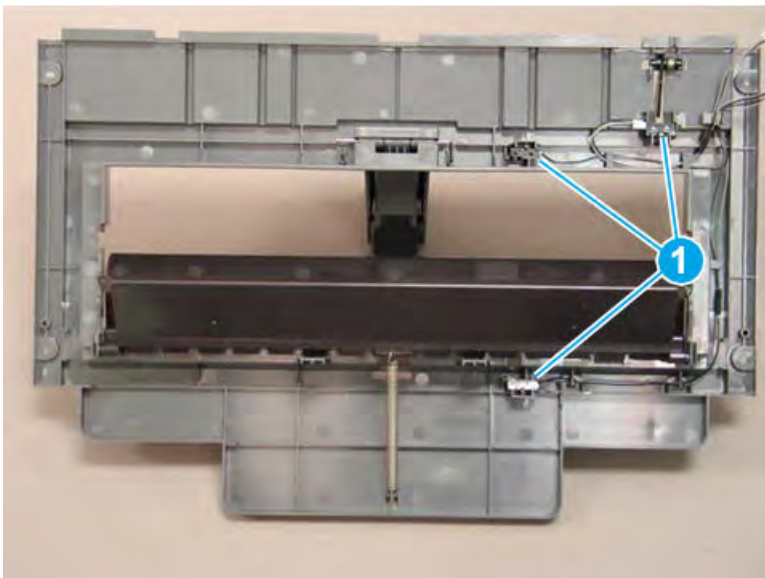
 **TIP:** Reverse the removal steps to install the assembly.

**Figure 5-1402** Disconnect two connectors



4. If you are replacing the left lower cover, locate three sensors (callout 1) on the back of the left lower cover. Remove these sensors and transfer them to the replacement part.

**Figure 5-1403** Remove the left lower cover

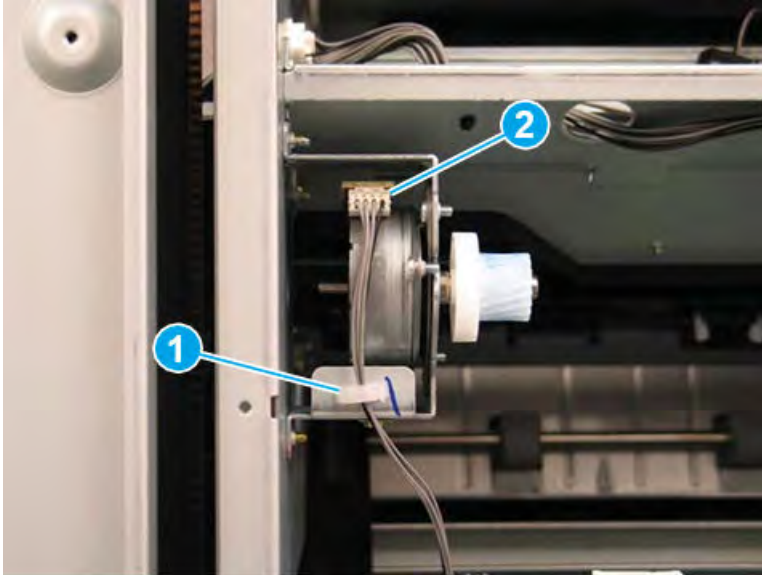


### Remove the paper holding Motor (M7)

Follow these steps to remove the paper holding Motor (M7).

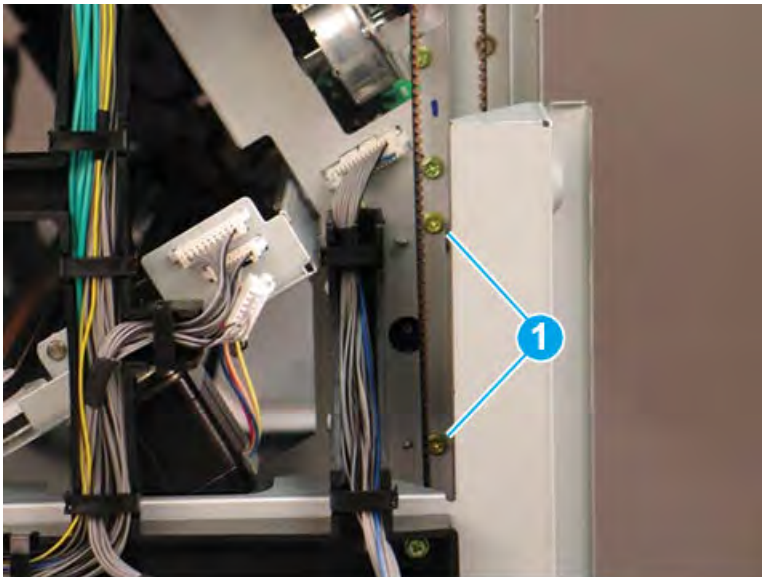
1. Release one retainer (callout 1), and then disconnect one connector (callout 2).

Figure 5-1404 Disconnect one connector



2. Remove two screws (callout 1), and then remove the motor and bracket.

Figure 5-1405 Remove two screws



3. Remove two screws (callout 1), and then remove the motor.

Figure 5-1406 Remove two screws and the motor



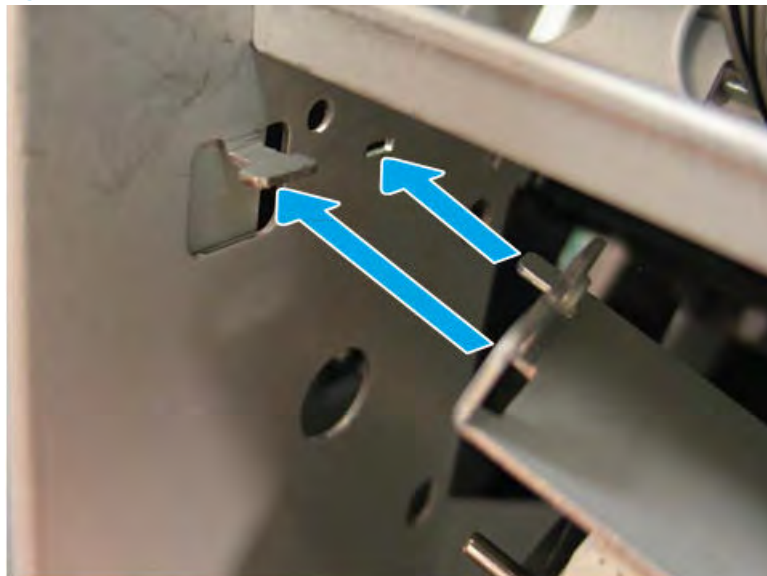
4. Reverse the removal steps to install the assembly. Also use the following special installation instructions.

 **NOTE:** Continue to reverse the removal steps to finish installing the assembly

**Special installation instructions: paper holding Motor (M10)**

When installing the motor and bracket, align the tab and slot on the motor bracket with the tab and slot in the printer.

Figure 5-1407 Install the motor and bracket




**Unpack the replacement assembly**

Follow these steps to unpack the replacement assembly.

1. Dispose of the defective part.



---


 **NOTE:** HP recommends responsible disposal of the defective part.


<http://www8.hp.com/us/en/hp-information/environment/product-recycling.html>

---

2. Unpack the replacement part from the packaging.


 **CAUTION:**  Some parts are sensitive to electrostatic discharge (ESD). Always perform service work at an ESD-protected workstation or mat. If an ESD workstation or mat is not available, touch the sheet-metal chassis to provide a static ground before touching an ESD-sensitive assembly. Protect the ESD-sensitive assemblies by placing them in ESD pouches when they are out of the printer.

 **IMPORTANT:** Make sure that all of the shipping materials (for example shipping tape) are removed from the replacement part prior to installation.

 **NOTE:** If the replacement part is a roller or pad, avoid touching the spongy part of it. Skin oils on the roller or pad can cause paper pickup and/or print-quality problems. HP recommends using disposable gloves when handling rollers or pads or washing your hands before touching rollers or pads.

---

3. To install an assembly, reverse the removal steps.

 **NOTE:** When applicable, special installation instructions are provided for an assembly at the end of the removal procedure. Always completely read the removal instructions and follow all special installation instructions.

---


## Buffer unit

## Removal and replacement: Buffer motor (M10)


Learn how to remove and replace the buffer motor.

### Introduction

This document provides the procedures to remove and replace the buffer motor on the finisher.

 **IMPORTANT:** When applicable, special installation instructions are provided for an assembly at the end of the removal procedure. Always completely read the removal instructions and follow all special installation instructions.

### Before performing service

- Turn the printer power off. A shutting-down message appears on the control-panel display.
-  **WARNING!** To avoid damage to the printer, turn the power off and wait until the printer shuts down before removing the power cable.
- Disconnect the printer power cable after the printer has completely shut down (the control-panel display is blank).
- Release the finisher from the printer by pulling out on the release latch inside the finisher door.
- Disconnect the cable from the bridge unit to the finisher.
- Disconnect the cable from the finisher to the printer.

Use the table below to identify the correct part number for your printer. To order the part, go to <https://parts.hp.com>.

**Table 5-141** Part information

Part number	Part description
JC93-01152A	Buffer motor

### Required tools

- #2 JIS screwdriver with a magnetic tip

### After performing service

- Connect the cable from the finisher to the printer.
- Connect the cable from the bridge unit to the finisher.
- Attach the finisher to the printer, and then push in on the release latch inside the finisher door.
- Connect the printer power cable.
- Turn the printer power on.

### Post service test

Process a job through the finisher and verify that the finisher works correctly.

### Remove the right upper cover (finisher)

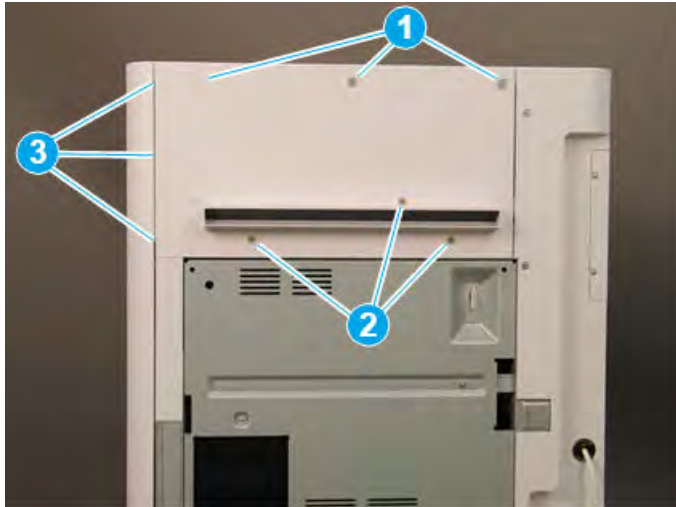
Follow these steps to remove the right upper cover (finisher).

- ▲ Remove one screw cap and three machine screws on the upper edge of the cover (callout 1). Remove three sheet metal screws (callout 2) on the lower portion of the cover. Rotate the right edge of the cover away from the finisher, and then slide the cover right to release three tabs (callout 3).

💡 **TIP:** The lower screws are shorter in length than the upper screws.

**TIP:** Reverse the removal steps to install the assembly.

Figure 5-1408 Remove the right upper cover

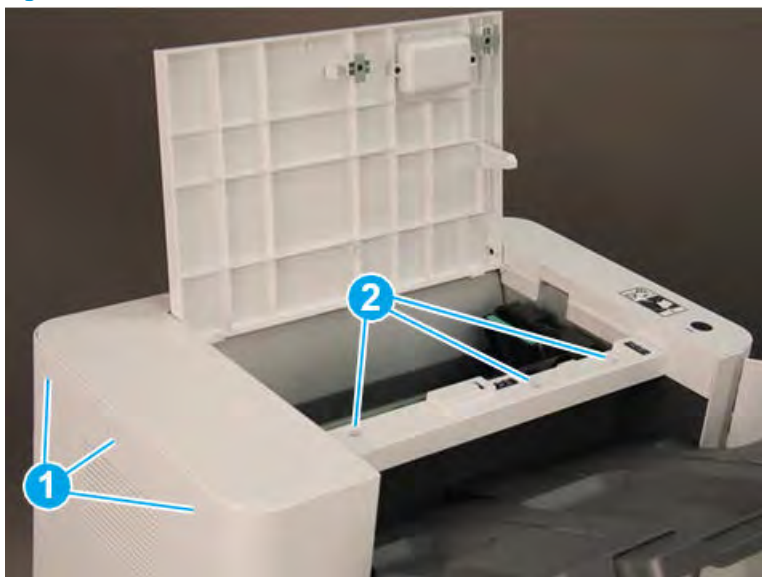


### Remove the top cover (finisher)

Follow these steps to remove the top cover (finisher).

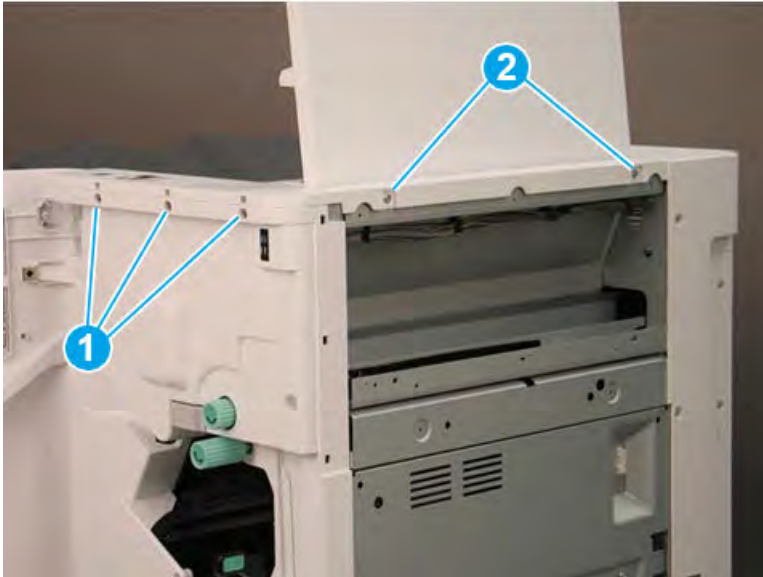
1. Remove three screw caps and three self-tapping screws at the top of the rear cover (callout 1), and then remove three machine screws (callout 2) on top of the cover.

Figure 5-1409 Remove six screws




2. Remove three self-tapping screws at the top of the front cover (callout 1), and then remove two machine screws (callout 2) at the top of the right side.

Figure 5-1410 Remove five screws



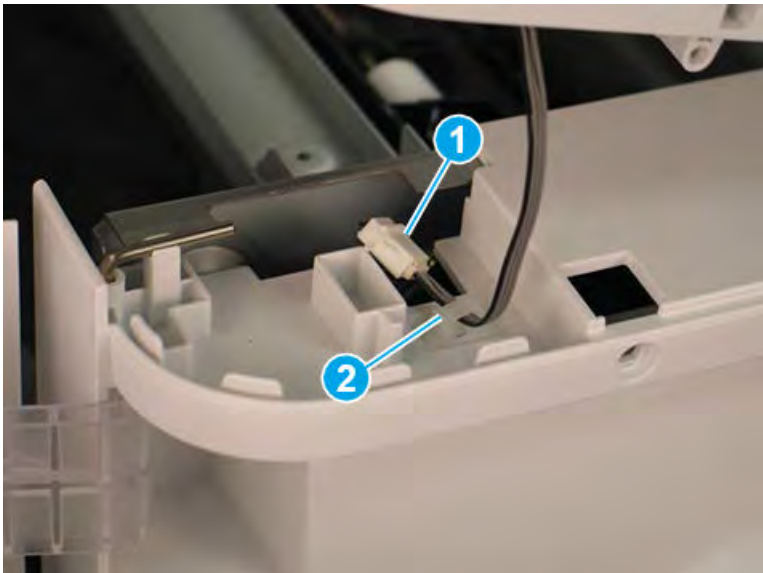
3. Lift the cover up slightly. Disconnect one in-line connector (callout 1), and then release one retainer (callout 2).

---

 **TIP:** Reverse the removal steps to install the assembly.

---

Figure 5-1411 Disconnect one connector and release retainer



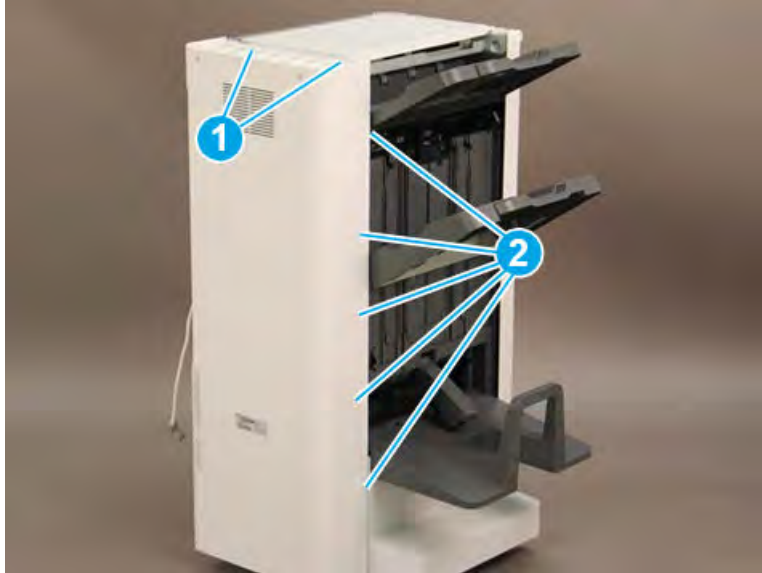
### Remove the rear cover (finisher)

Follow these steps to remove the rear cover (finisher).

1. Remove two self-tapping screws (callout 1) on the top of the rear cover, and then remove five screw caps and five machine screws (callout 2) on the left side of the cover.



Figure 5-1412 Remove seven screws



2. Remove one screw cap and four machine screws (callout 1) Remove the rear cover.

 **NOTE:** Make sure to thread the power cable (callout 2) through the opening in the cover.


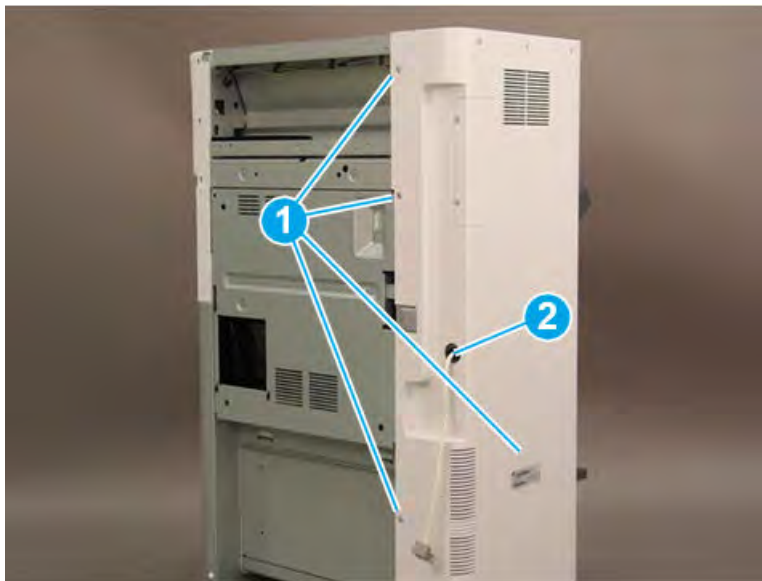
 **TIP:** Reverse the removal steps to install the assembly

Figure 5-1413 Remove the rear cover

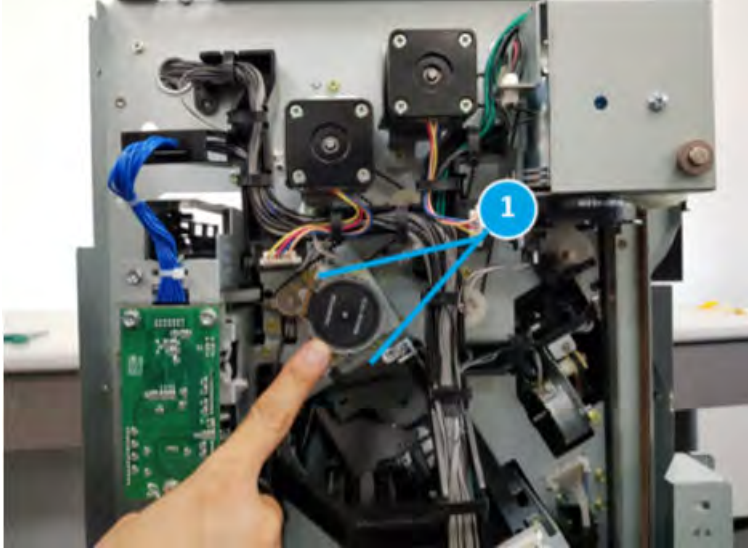


### Remove the main exit cam motor(M10)

Follow these steps to remove the main exit cam motor(M10).

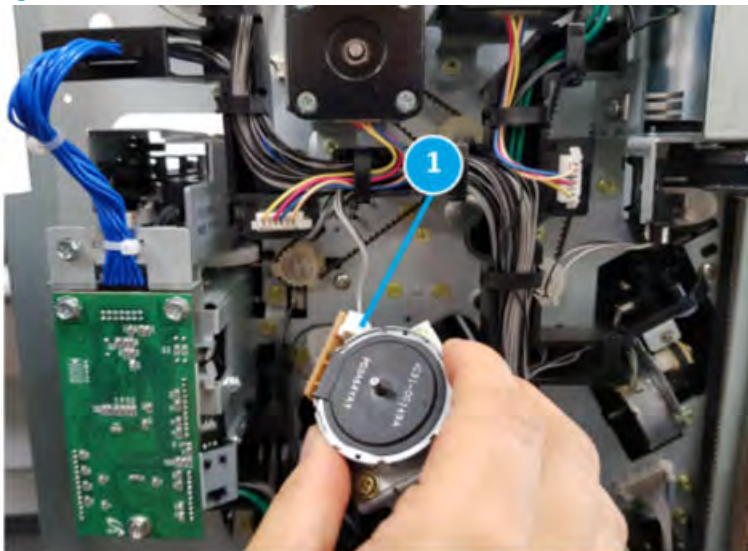
1. At the rear of the finisher, remove two screws(callout 1).

Figure 5-1414 Remove two screws



2. Disconnect the connector(callout 1)

Figure 5-1415 Disconnect the connector



### Unpack the replacement assembly

Follow these steps to unpack the replacement assembly.

1. Dispose of the defective part.



---

 **NOTE:** HP recommends responsible disposal of the defective part.


<http://www8.hp.com/us/en/hp-information/environment/product-recycling.html>

---

2. Unpack the replacement part from the packaging.


 **CAUTION:**  Some parts are sensitive to electrostatic discharge (ESD). Always perform service work at an ESD-protected workstation or mat. If an ESD workstation or mat is not available, touch the sheet-metal chassis to provide a static ground before touching an ESD-sensitive assembly. Protect the ESD-sensitive assemblies by placing them in ESD pouches when they are out of the printer.

 **IMPORTANT:** Make sure that all of the shipping materials (for example shipping tape) are removed from the replacement part prior to installation.

 **NOTE:** If the replacement part is a roller or pad, avoid touching the spongy part of it. Skin oils on the roller or pad can cause paper pickup and/or print-quality problems. HP recommends using disposable gloves when handling rollers or pads or washing your hands before touching rollers or pads.

---

3. To install an assembly, reverse the removal steps.

 **NOTE:** When applicable, special installation instructions are provided for an assembly at the end of the removal procedure. Always completely read the removal instructions and follow all special installation instructions.


---

## Removal and replacement: Buffer solenoid (SL1)


Learn how to remove and replace the buffer solenoid.

### Introduction

This document provides the procedures to remove and replace the buffer solenoid on the finisher.

 **IMPORTANT:** When applicable, special installation instructions are provided for an assembly at the end of the removal procedure. Always completely read the removal instructions and follow all special installation instructions.

### Before performing service

- Turn the printer power off. A shutting-down message appears on the control-panel display.
-  **WARNING!** To avoid damage to the printer, turn the power off and wait until the printer shuts down before removing the power cable.
- Disconnect the printer power cable after the printer has completely shut down (the control-panel display is blank).
- Release the finisher from the printer by pulling out on the release latch inside the finisher door.
- Disconnect the cable from the bridge unit to the finisher.
- Disconnect the cable from the finisher to the printer.

Use the table below to identify the correct part number for your printer. To order the part, go to <https://parts.hp.com>.

Table 5-142 Part information

Part number	Part description
JC90-01675A	Buffer solenoid

### Required tools

- #2 JIS screwdriver with a magnetic tip

### After performing service

- Connect the cable from the finisher to the printer.
- Connect the cable from the bridge unit to the finisher.
- Attach the finisher to the printer, and then push in on the release latch inside the finisher door.
- Connect the printer power cable.
- Turn the printer power on.

### Post service test

Process a job through the finisher and verify that the finisher works correctly.

### Remove the right upper cover (finisher)

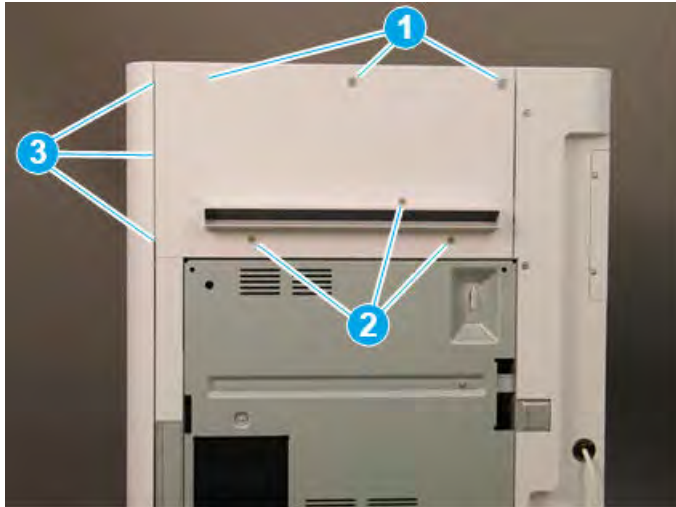
Follow these steps to remove the right upper cover (finisher).

- ▲ Remove one screw cap and three machine screws on the upper edge of the cover (callout 1). Remove three sheet metal screws (callout 2) on the lower portion of the cover. Rotate the right edge of the cover away from the finisher, and then slide the cover right to release three tabs (callout 3).

💡 **TIP:** The lower screws are shorter in length than the upper screws.

**TIP:** Reverse the removal steps to install the assembly.

Figure 5-1416 Remove the right upper cover

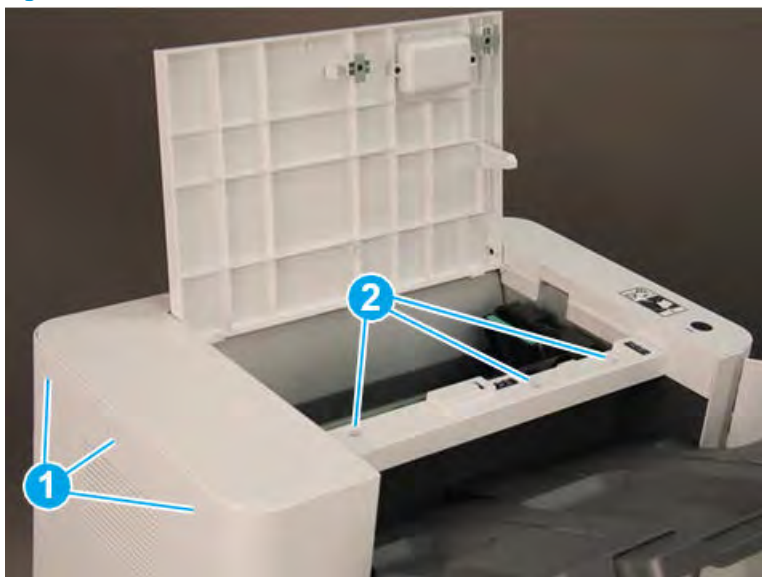


### Remove the top cover (finisher)

Follow these steps to remove the top cover (finisher).

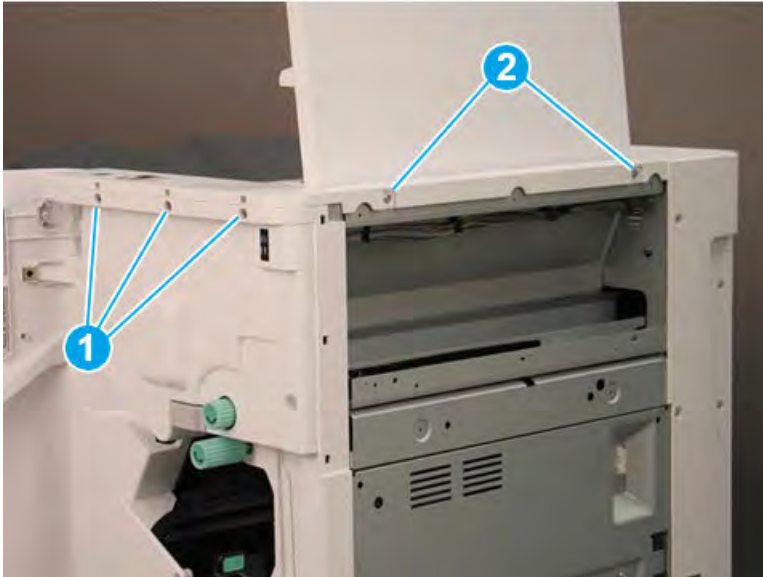
1. Remove three screw caps and three self-tapping screws at the top of the rear cover (callout 1), and then remove three machine screws (callout 2) on top of the cover.

Figure 5-1417 Remove six screws




2. Remove three self-tapping screws at the top of the front cover (callout 1), and then remove two machine screws (callout 2) at the top of the right side.

Figure 5-1418 Remove five screws



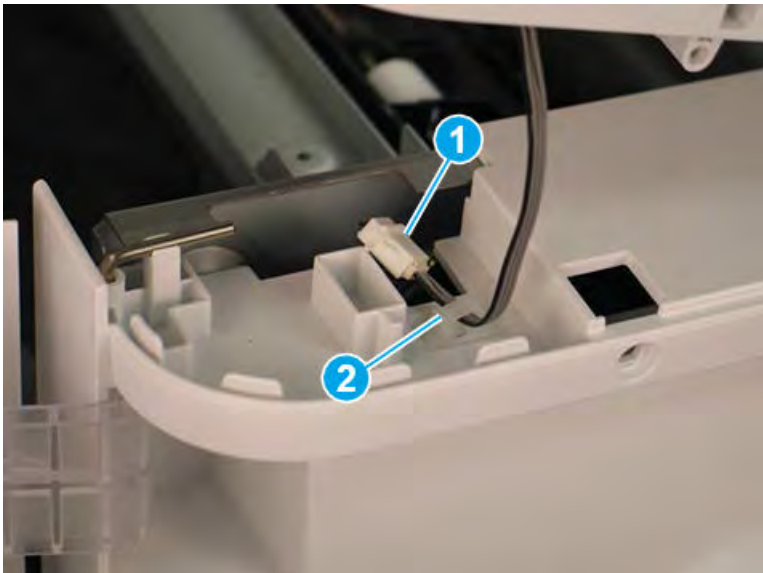
3. Lift the cover up slightly. Disconnect one in-line connector (callout 1), and then release one retainer (callout 2).

---

 **TIP:** Reverse the removal steps to install the assembly.

---

Figure 5-1419 Disconnect one connector and release retainer

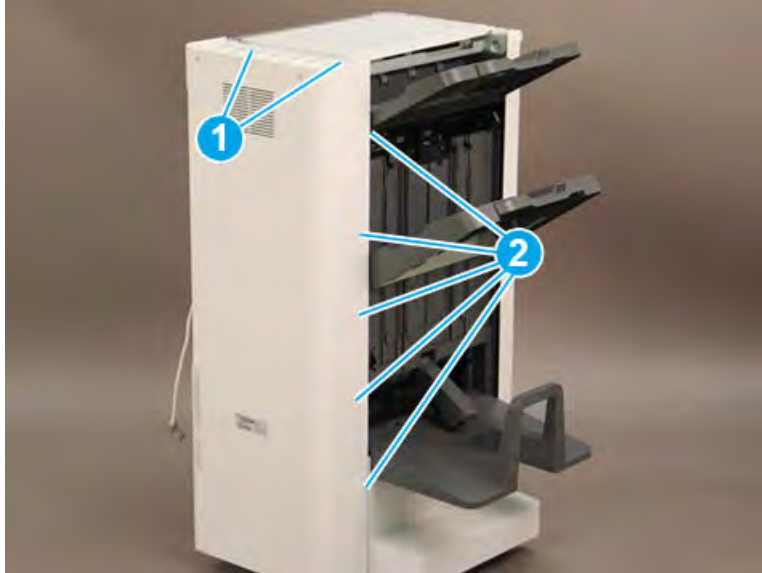


### Remove the rear cover (finisher)

Follow these steps to remove the rear cover (finisher).

1. Remove two self-tapping screws (callout 1) on the top of the rear cover, and then remove five screw caps and five machine screws (callout 2) on the left side of the cover.

Figure 5-1420 Remove seven screws



2. Remove one screw cap and four machine screws (callout 1) Remove the rear cover.

 **NOTE:** Make sure to thread the power cable (callout 2) through the opening in the cover.


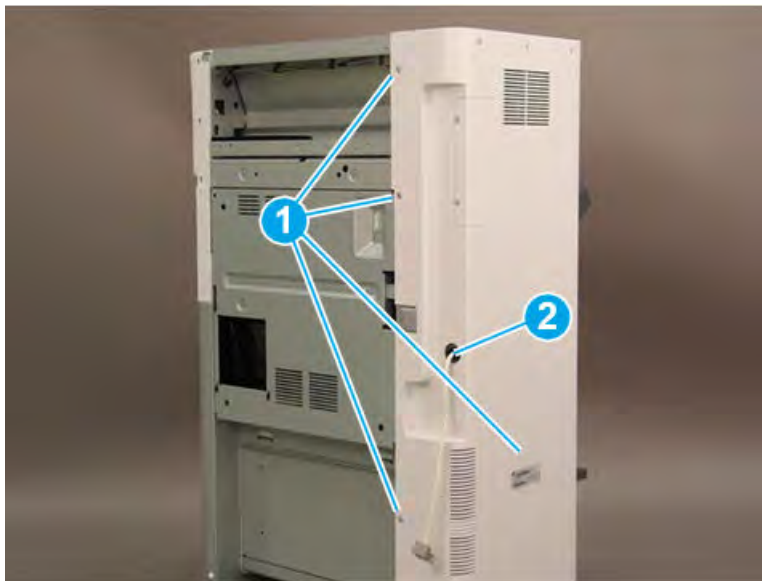
 **TIP:** Reverse the removal steps to install the assembly

Figure 5-1421 Remove the rear cover

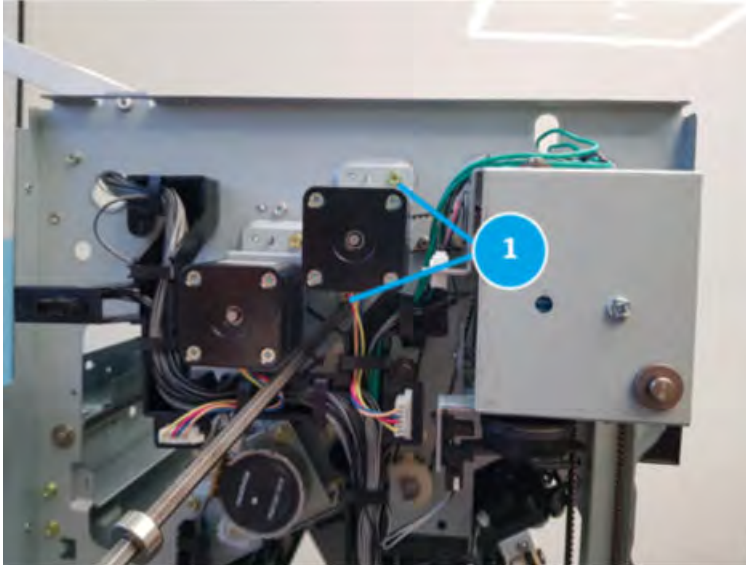


### Remove the buffer solenoid(SL1)

Follow these steps to remove the buffer solenoid(SL1).

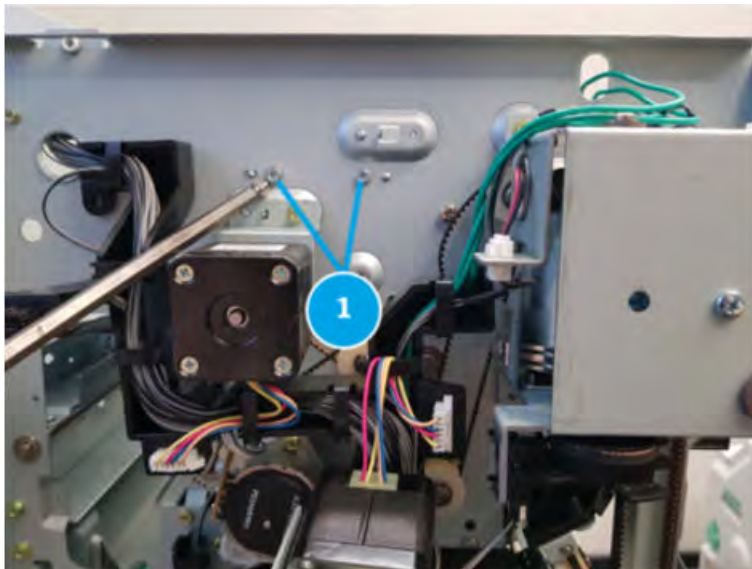
1. At the rear of the finisher, remove two screws(Callout 1)

Figure 5-1422 Remove two screws



2. At the rear of the finisher, remove two screws(Callout 1)

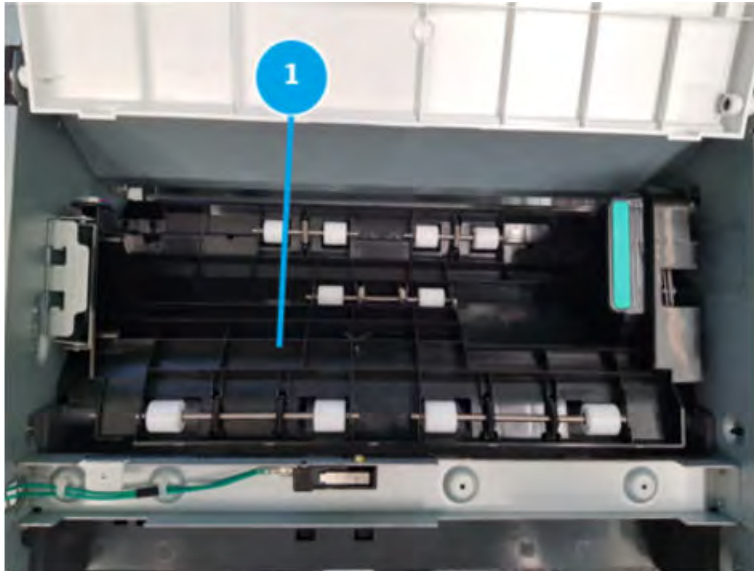
Figure 5-1423 Remove two screws





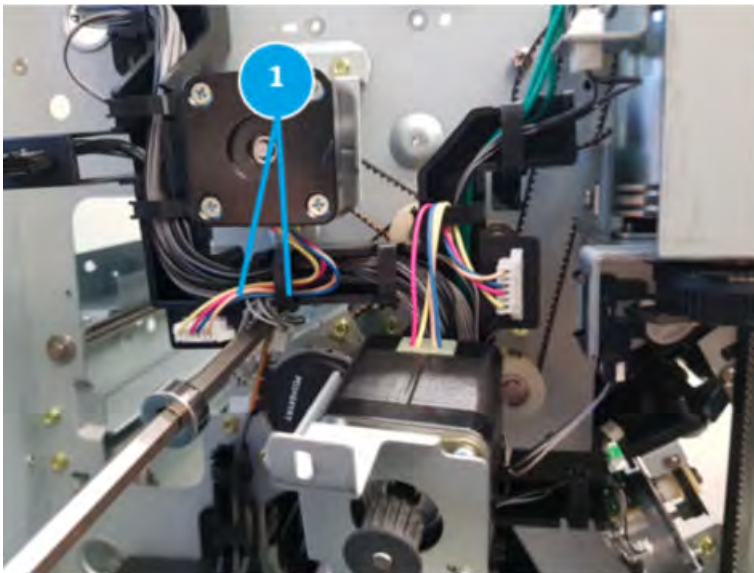
3. Remove top jam cover assembly (Callout 1)

Figure 5-1424 Remove top jam cover assembly



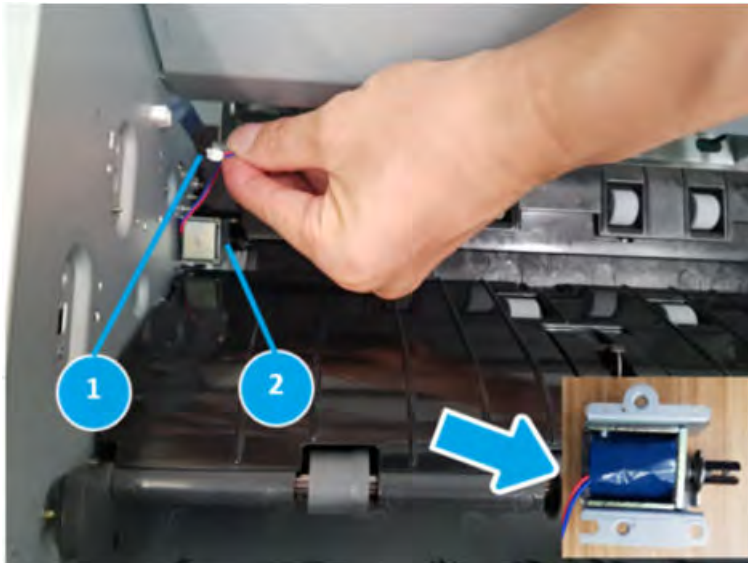
4. At the rear of the finisher, remove two screws (Callout 1)

Figure 5-1425 Remove two screws



5. Disconnect the connector(Callout 1) and remove the buffer solenoid(Callout 2)

Figure 5-1426 Remove the buffer solenoid



### Unpack the replacement assembly



Follow these steps to unpack the replacement assembly.


1. Dispose of the defective part.


 **NOTE:** HP recommends responsible disposal of the defective part.

<http://www8.hp.com/us/en/hp-information/environment/product-recycling.html>


2. Unpack the replacement part from the packaging.

 **CAUTION:**  Some parts are sensitive to electrostatic discharge (ESD). Always perform service work at an ESD-protected workstation or mat. If an ESD workstation or mat is not available, touch the sheet-metal chassis to provide a static ground before touching an ESD-sensitive assembly. Protect the ESD-sensitive assemblies by placing them in ESD pouches when they are out of the printer.

 **IMPORTANT:** Make sure that all of the shipping materials (for example shipping tape) are removed from the replacement part prior to installation.

 **NOTE:** If the replacement part is a roller or pad, avoid touching the spongy part of it. Skin oils on the roller or pad can cause paper pickup and/or print-quality problems. HP recommends using disposable gloves when handling rollers or pads or washing your hands before touching rollers or pads.

3. To install an assembly, reverse the removal steps.

 **NOTE:** When applicable, special installation instructions are provided for an assembly at the end of the removal procedure. Always completely read the removal instructions and follow all special installation instructions.

## Booklet maker

## Removal and replacement: Booklet finisher

Learn how to remove and replace the booklet maker.

### Introduction

This document provides the procedures to remove and replace the booklet maker on the finisher.



**IMPORTANT:** When applicable, special installation instructions are provided for an assembly at the end of the removal procedure. Always completely read the removal instructions and follow all special installation instructions.

### Before performing service

- Turn the printer power off. A shutting-down message appears on the control-panel display.
- ⚠ **WARNING!** To avoid damage to the printer, turn the power off and wait until the printer shuts down before removing the power cable.
- Disconnect the printer power cable after the printer has completely shut down (the control-panel display is blank).
- Release the finisher from the printer by pulling out on the release latch inside the finisher door.
- Disconnect the cable from the bridge unit to the finisher.
- Disconnect the cable from the finisher to the printer.

Use the table below to identify the correct part number for your printer. To order the part, go to <https://parts.hp.com>.

**Table 5-143** Part information

Part number	Part description
JC82-00905A	Booklet maker

### Required tools

- #2 JIS screwdriver with a magnetic tip

### After performing service

- Connect the cable from the finisher to the printer.
- Connect the cable from the bridge unit to the finisher.
- Attach the finisher to the printer, and then push in on the release latch inside the finisher door.
- Connect the printer power cable.
- Turn the printer power on.

### Post service test

Process a job through the finisher and verify that the finisher works correctly.

### Remove the right upper cover (finisher)

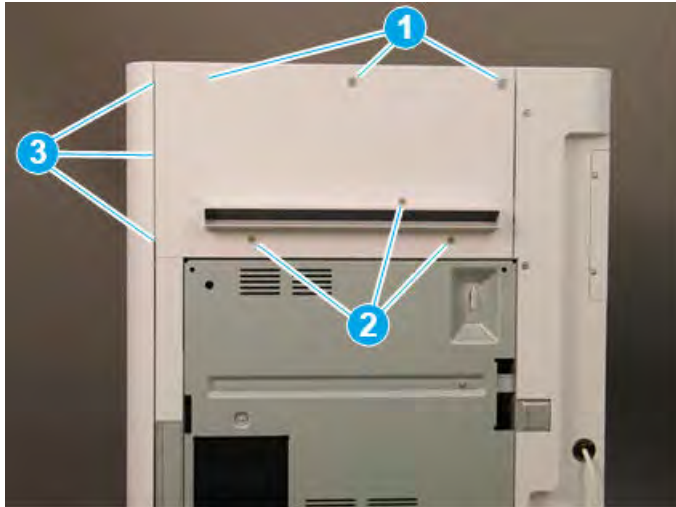
Follow these steps to remove the right upper cover (finisher).

- ▲ Remove one screw cap and three machine screws on the upper edge of the cover (callout 1). Remove three sheet metal screws (callout 2) on the lower portion of the cover. Rotate the right edge of the cover away from the finisher, and then slide the cover right to release three tabs (callout 3).

💡 **TIP:** The lower screws are shorter in length than the upper screws.

**TIP:** Reverse the removal steps to install the assembly.

Figure 5-1427 Remove the right upper cover

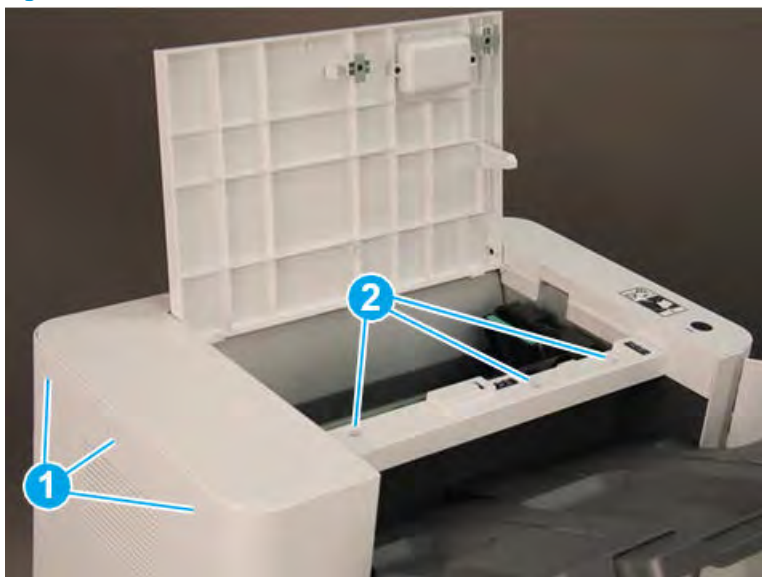


### Remove the top cover (finisher)

Follow these steps to remove the top cover (finisher).

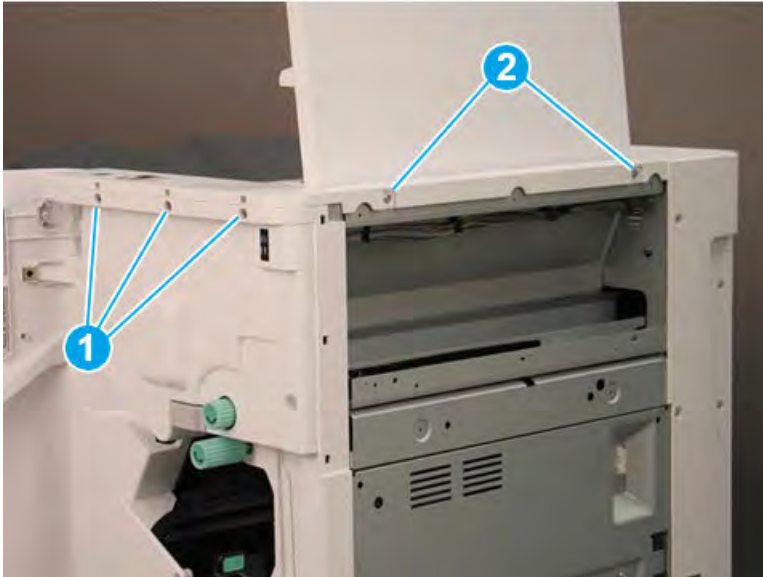
1. Remove three screw caps and three self-tapping screws at the top of the rear cover (callout 1), and then remove three machine screws (callout 2) on top of the cover.

Figure 5-1428 Remove six screws




2. Remove three self-tapping screws at the top of the front cover (callout 1), and then remove two machine screws (callout 2) at the top of the right side.

Figure 5-1429 Remove five screws



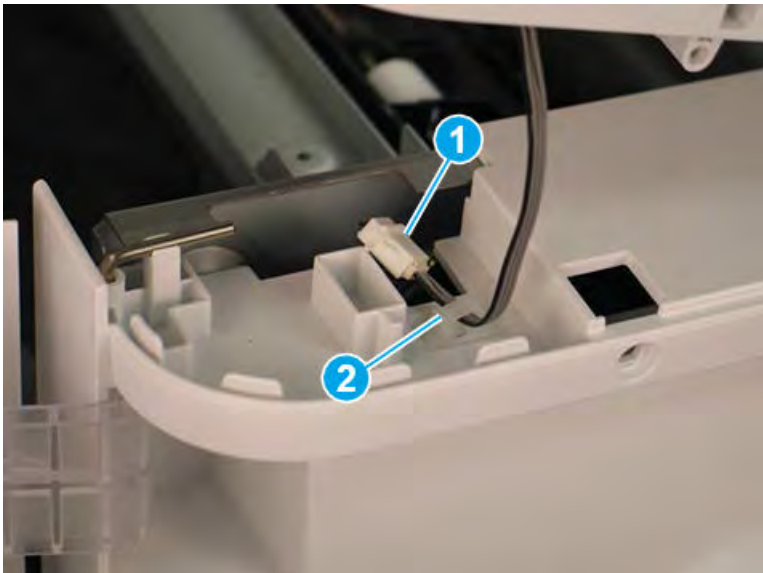
3. Lift the cover up slightly. Disconnect one in-line connector (callout 1), and then release one retainer (callout 2).

---

 **TIP:** Reverse the removal steps to install the assembly.

---

Figure 5-1430 Disconnect one connector and release retainer

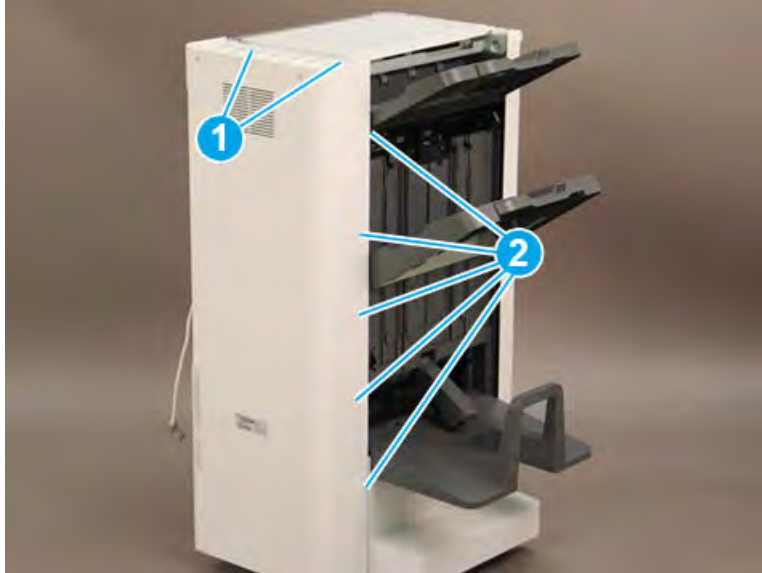


### Remove the rear cover (finisher)

Follow these steps to remove the rear cover (finisher).

1. Remove two self-tapping screws (callout 1) on the top of the rear cover, and then remove five screw caps and five machine screws (callout 2) on the left side of the cover.

Figure 5-1431 Remove seven screws




2. Remove one screw cap and four machine screws (callout 1) Remove the rear cover.

---

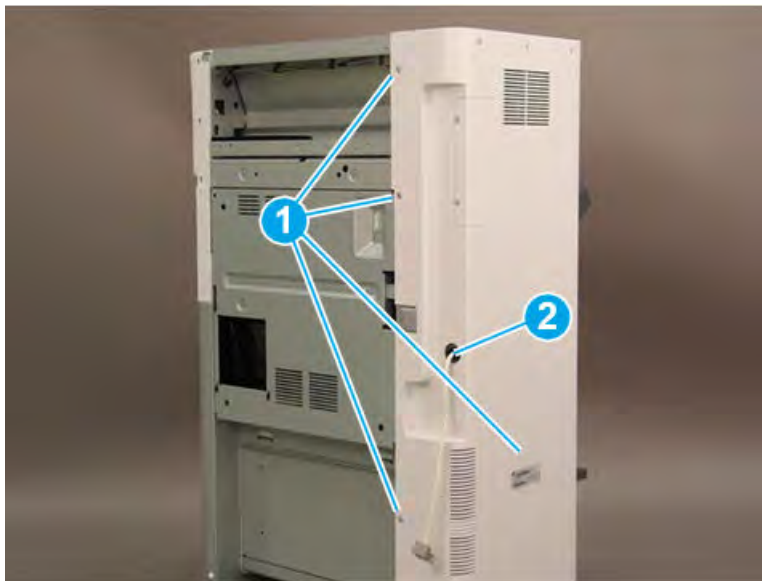
 **NOTE:** Make sure to thread the power cable (callout 2) through the opening in the cover.

---

 **TIP:** Reverse the removal steps to install the assembly

---

Figure 5-1432 Remove the rear cover



### Remove the booklet maker

Follow these steps to remove the booklet maker.

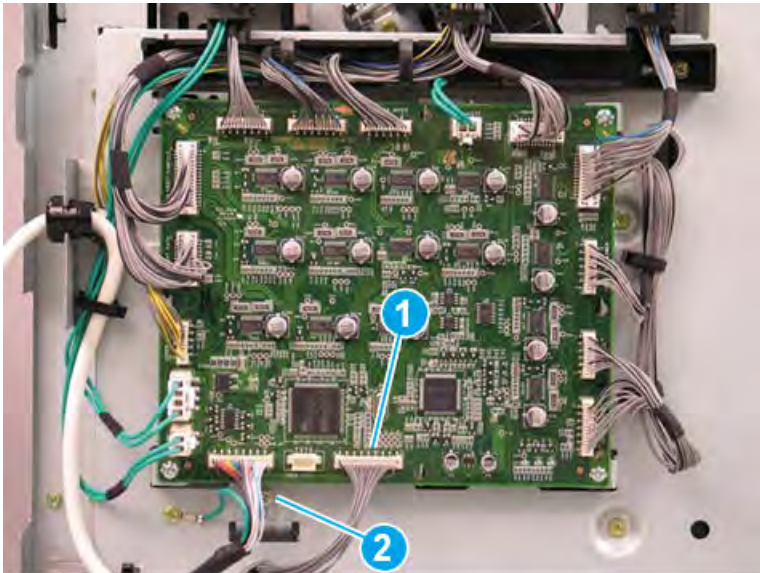
1. Slide the booklet maker away from the finisher.

Figure 5-1433 Slide the booklet maker away from the finisher



2. At the Disconnect one connector (callout 1), and then remove one screw (callout 2).

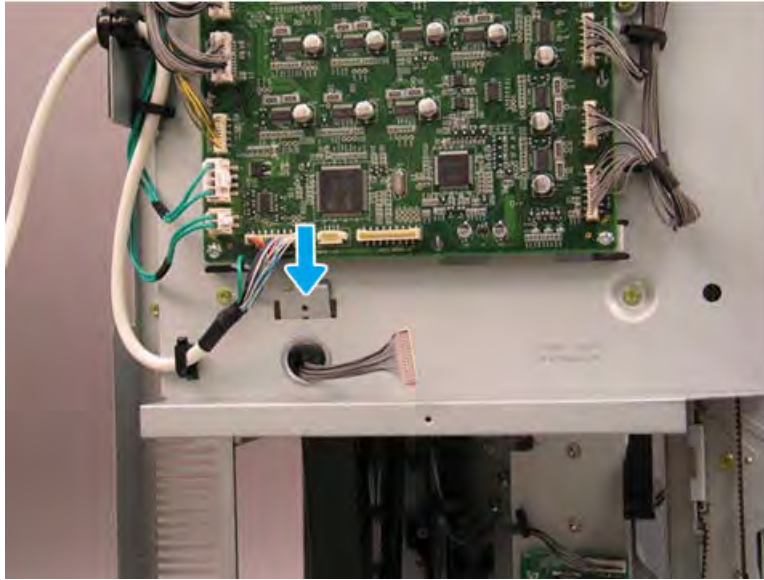
Figure 5-1434 Disconnect one connector and remove one screw





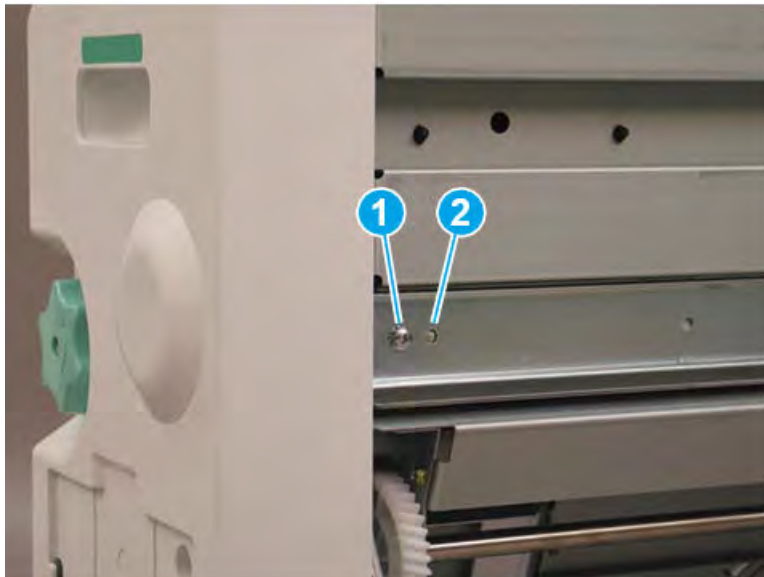
3. Release the metal bracket through the opening in the sheet metal.

Figure 5-1435 Release the metal bracket



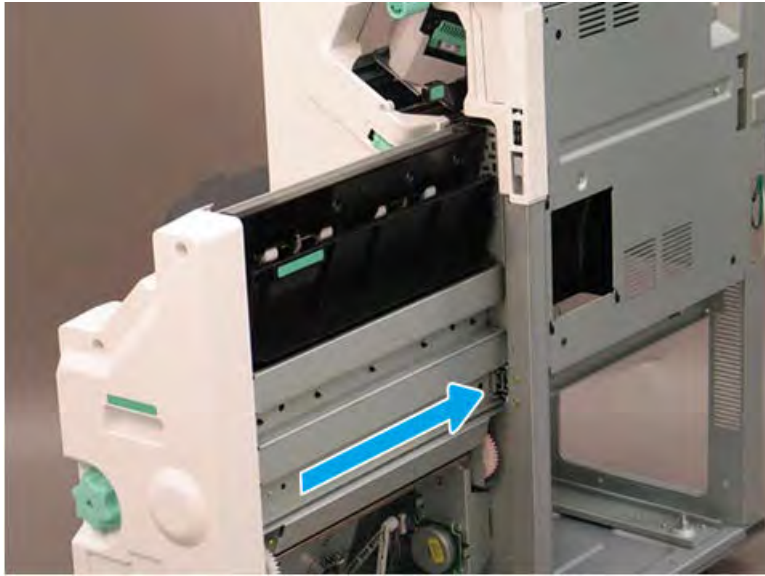
4. Remove one star-washer screw (callout 1), and then release the alignment pin (callout 2) on the right side of the booklet maker.

Figure 5-1436 Remove one screw



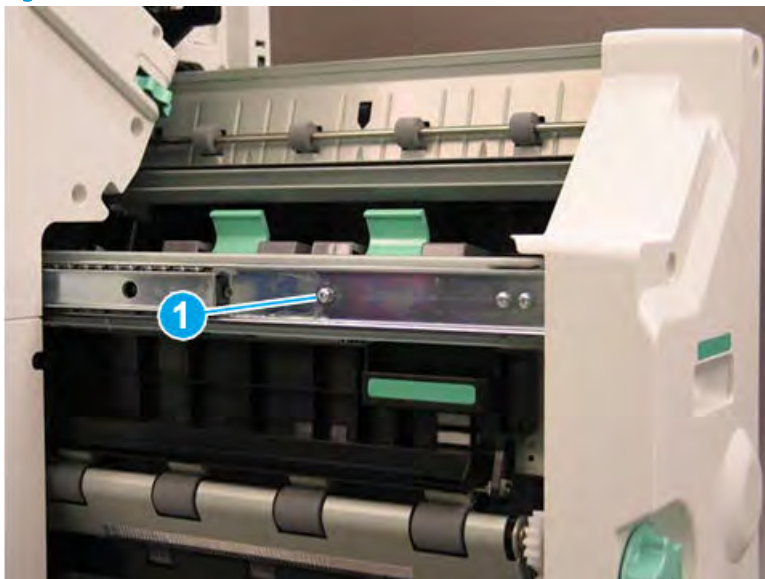
5. Slide the right rail toward the finisher.

Figure 5-1437 Slide the right rail



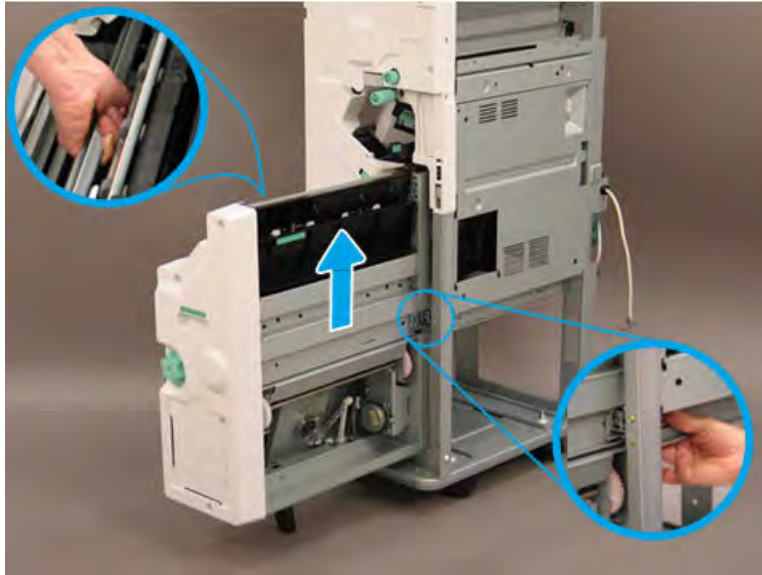
6. Remove one star-washer screw (callout 1) on the left side of the booklet maker.

Figure 5-1438 Remove one screw



7. Lift the booklet maker up on the left side while squeezing the right rail away from the finisher slightly to clear the sheet metal. Remove the booklet maker.

**Figure 5-1439** Remove the booklet maker



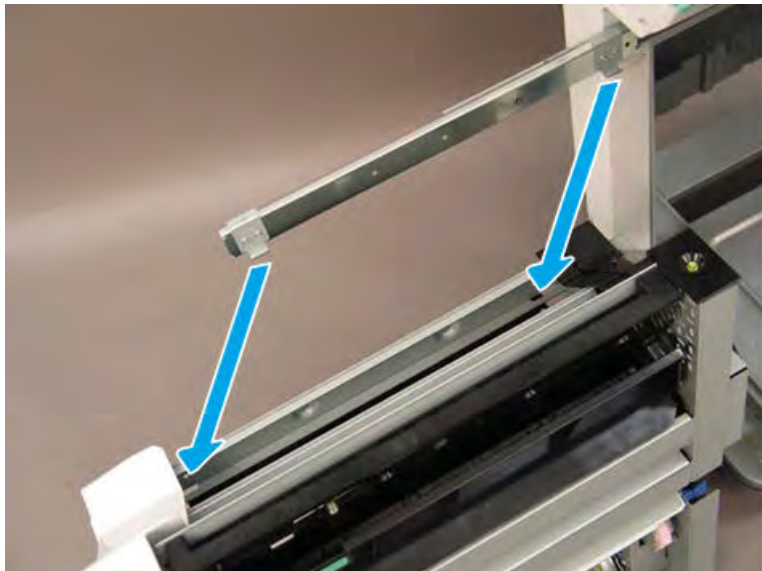
8. Reverse the removal steps to install the assembly. Also use the following special installation instructions.

 **NOTE:** Continue to reverse the removal steps to finish installing the assembly.

**Special installation instructions: booklet maker**

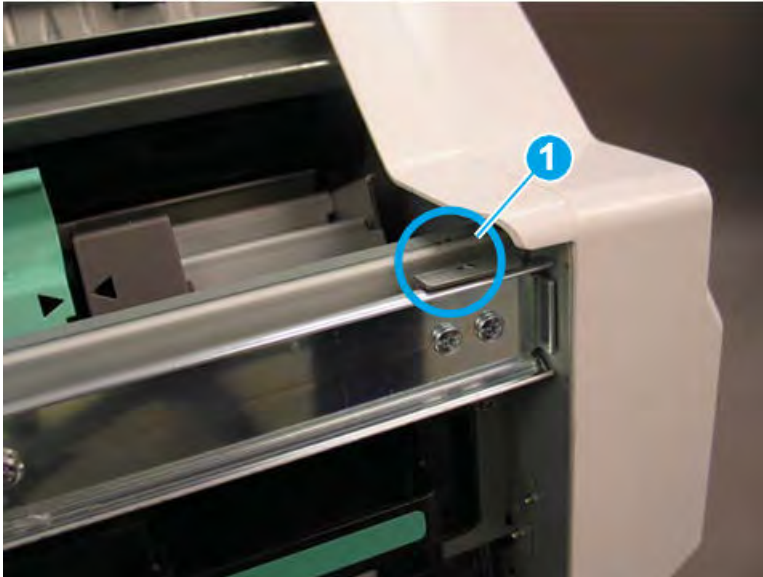
When installing the booklet maker, position the hooks on the rail under the slots on the booklet maker.

**Figure 5-1440** Position the hooks



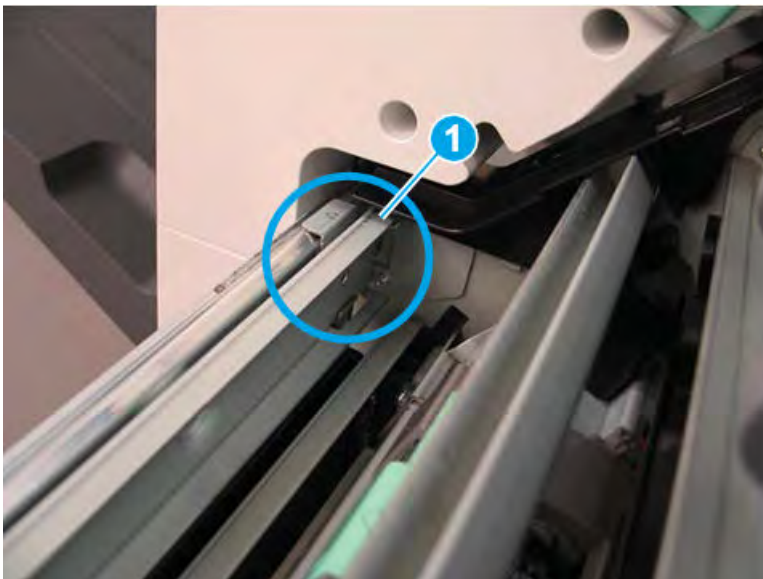
9. When installed correctly, the arrow on the front of the booklet maker aligns with the arrow on the finisher rail.

Figure 5-1441 Align arrows



10. When installed correctly, the arrow on the back of the booklet maker aligns with the arrow on the finisher rail.

Figure 5-1442 Align arrows



11. Extend the right rail away from the finisher and position it in the booklet maker slot.

Figure 5-1443 Extend the right rail



### Unpack the replacement assembly



Follow these steps to unpack the replacement assembly.


1. Dispose of the defective part.


 **NOTE:** HP recommends responsible disposal of the defective part.

<http://www8.hp.com/us/en/hp-information/environment/product-recycling.html>


2. Unpack the replacement part from the packaging.

 **CAUTION:**  Some parts are sensitive to electrostatic discharge (ESD). Always perform service work at an ESD-protected workstation or mat. If an ESD workstation or mat is not available, touch the sheet-metal chassis to provide a static ground before touching an ESD-sensitive assembly. Protect the ESD-sensitive assemblies by placing them in ESD pouches when they are out of the printer.

 **IMPORTANT:** Make sure that all of the shipping materials (for example shipping tape) are removed from the replacement part prior to installation.

 **NOTE:** If the replacement part is a roller or pad, avoid touching the spongy part of it. Skin oils on the roller or pad can cause paper pickup and/or print-quality problems. HP recommends using disposable gloves when handling rollers or pads or washing your hands before touching rollers or pads.

3. To install an assembly, reverse the removal steps.

 **NOTE:** When applicable, special installation instructions are provided for an assembly at the end of the removal procedure. Always completely read the removal instructions and follow all special installation instructions.

## Booklet entrance unit

## Removal and replacement: Booklet entrance motor (M15)

Learn how to remove and replace the booklet entrance motor.

### Introduction

This document provides the procedures to remove and replace the booklet entrance motor on the finisher.



**IMPORTANT:** When applicable, special installation instructions are provided for an assembly at the end of the removal procedure. Always completely read the removal instructions and follow all special installation instructions.

### Before performing service

- Turn the printer power off. A shutting-down message appears on the control-panel display.
- ⚠ **WARNING!** To avoid damage to the printer, turn the power off and wait until the printer shuts down before removing the power cable.
- Disconnect the printer power cable after the printer has completely shut down (the control-panel display is blank).
- Release the finisher from the printer by pulling out on the release latch inside the finisher door.
- Disconnect the cable from the bridge unit to the finisher.
- Disconnect the cable from the finisher to the printer.

Use the table below to identify the correct part number for your printer. To order the part, go to <https://parts.hp.com>.

**Table 5-144 Part information**

Part number	Part description
JC93-01152A	Booklet entrance motor

### Required tools

- #2 JIS screwdriver with a magnetic tip

### After performing service

- Connect the cable from the finisher to the printer.
- Connect the cable from the bridge unit to the finisher.
- Attach the finisher to the printer, and then push in on the release latch inside the finisher door.
- Connect the printer power cable.
- Turn the printer power on.

### Post service test

Process a job through the finisher and verify that the finisher works correctly.

## Remove the booklet front cover

Follow these steps to remove the booklet front cover.

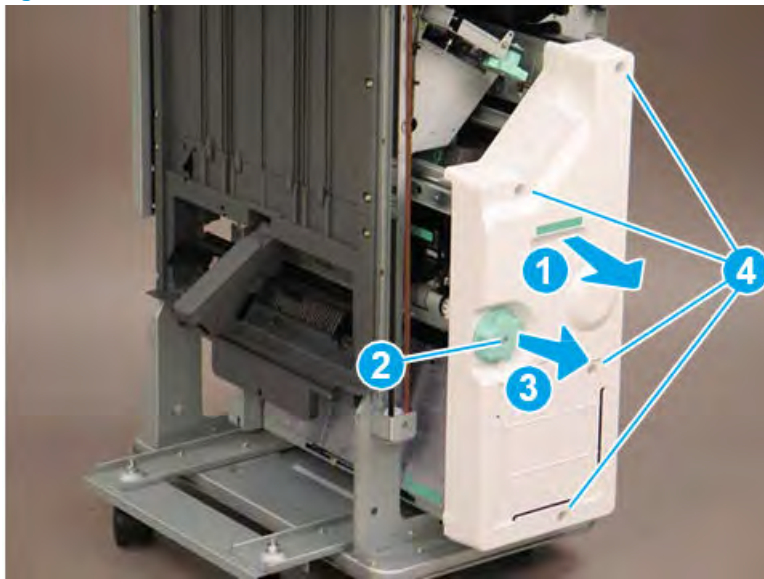
- ▲ Slide the booklet maker slightly away from the finisher (callout 1). Remove one screw (callout 2), and then slide the green knob away from the booklet maker to remove it (callout 3). Remove four screws (callout 4), and then remove the booklet front cover.

---

💡 **TIP:** Reverse the removal steps to install the assembly

---

**Figure 5-1444** Remove five screws and the cover



## Remove the booklet entrance motor (M15)

Follow these steps to remove the booklet entrance motor (M15).

- ▲ Disconnect one connector (callout 1), and then remove two screws (callout 2). Lift the motor away from the booklet maker and release the belt (callout 3) from the back of the motor.

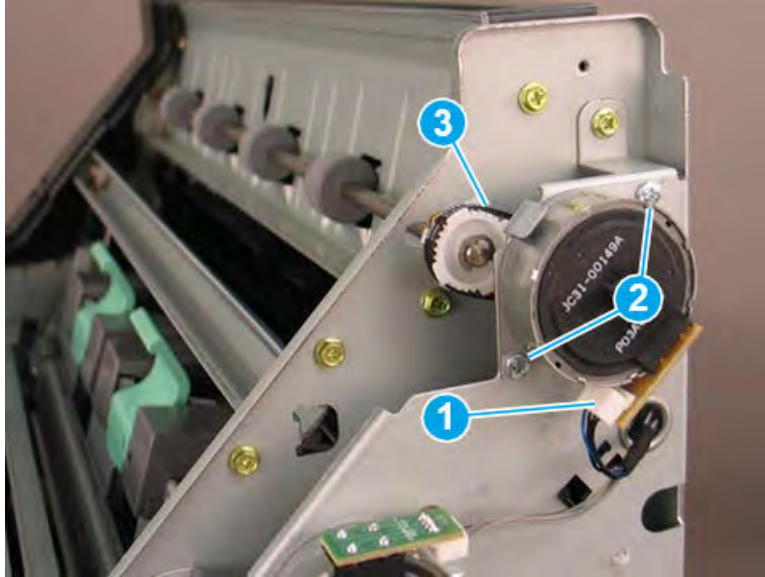
---

💡 **TIP:** Reverse the removal steps to install the assembly.

---



Figure 5-1445 Remove the booklet entrance motor



### Unpack the replacement assembly



Follow these steps to unpack the replacement assembly.


1. Dispose of the defective part.


 **NOTE:** HP recommends responsible disposal of the defective part.

<http://www8.hp.com/us/en/hp-information/environment/product-recycling.html>


2. Unpack the replacement part from the packaging.

 **CAUTION:**  Some parts are sensitive to electrostatic discharge (ESD). Always perform service work at an ESD-protected workstation or mat. If an ESD workstation or mat is not available, touch the sheet-metal chassis to provide a static ground before touching an ESD-sensitive assembly. Protect the ESD-sensitive assemblies by placing them in ESD pouches when they are out of the printer.

 **IMPORTANT:** Make sure that all of the shipping materials (for example shipping tape) are removed from the replacement part prior to installation.

 **NOTE:** If the replacement part is a roller or pad, avoid touching the spongy part of it. Skin oils on the roller or pad can cause paper pickup and/or print-quality problems. HP recommends using disposable gloves when handling rollers or pads or washing your hands before touching rollers or pads.

3. To install an assembly, reverse the removal steps.


 **NOTE:** When applicable, special installation instructions are provided for an assembly at the end of the removal procedure. Always completely read the removal instructions and follow all special installation instructions.

## Removal and replacement: Booklet entrance sensor (S36)

Learn how to remove and replace the booklet entrance sensor.

### Introduction

This document provides the procedures to remove and replace the booklet entrance sensor on the finisher.

 **IMPORTANT:** When applicable, special installation instructions are provided for an assembly at the end of the removal procedure. Always completely read the removal instructions and follow all special installation instructions.

### Before performing service

- Turn the printer power off. A shutting-down message appears on the control-panel display.
- ⚠ **WARNING!** To avoid damage to the printer, turn the power off and wait until the printer shuts down before removing the power cable.
- Disconnect the printer power cable after the printer has completely shut down (the control-panel display is blank).
- Release the finisher from the printer by pulling out on the release latch inside the finisher door.
- Disconnect the cable from the bridge unit to the finisher.
- Disconnect the cable from the finisher to the printer.

Use the table below to identify the correct part number for your printer. To order the part, go to <https://parts.hp.com>.

**Table 5-145 Part information**

Part number	Part description
0604-001415	Booklet entrance sensor

### Required tools

- #2 JIS screwdriver with a magnetic tip

### After performing service

- Connect the cable from the finisher to the printer.
- Connect the cable from the bridge unit to the finisher.
- Attach the finisher to the printer, and then push in on the release latch inside the finisher door.
- Connect the printer power cable.
- Turn the printer power on.

### Post service test

Process a job through the finisher and verify that the finisher works correctly.

### Remove the right upper cover (finisher)

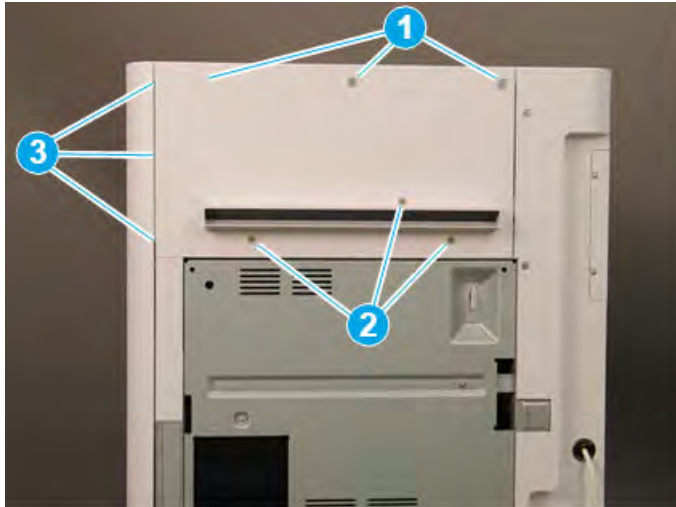
Follow these steps to remove the right upper cover (finisher).

- ▲ Remove one screw cap and three machine screws on the upper edge of the cover (callout 1). Remove three sheet metal screws (callout 2) on the lower portion of the cover. Rotate the right edge of the cover away from the finisher, and then slide the cover right to release three tabs (callout 3).

💡 **TIP:** The lower screws are shorter in length than the upper screws.

**TIP:** Reverse the removal steps to install the assembly.

Figure 5-1446 Remove the right upper cover

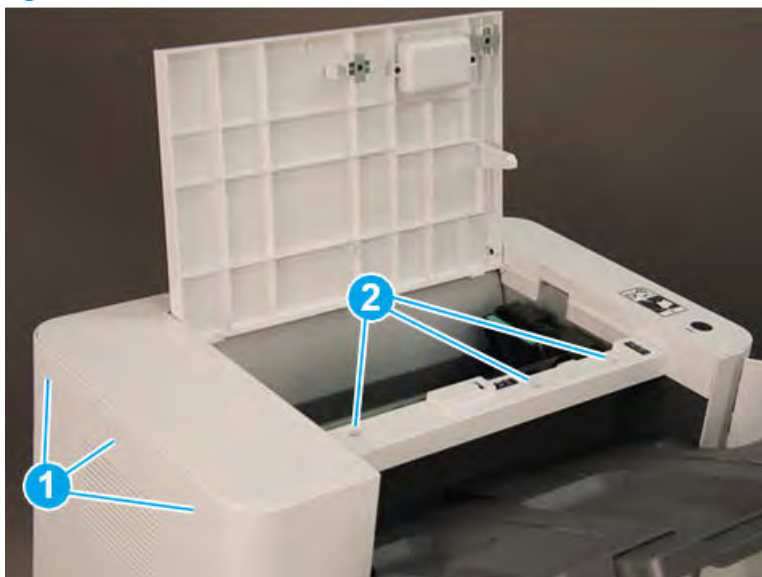


### Remove the top cover (finisher)

Follow these steps to remove the top cover (finisher).

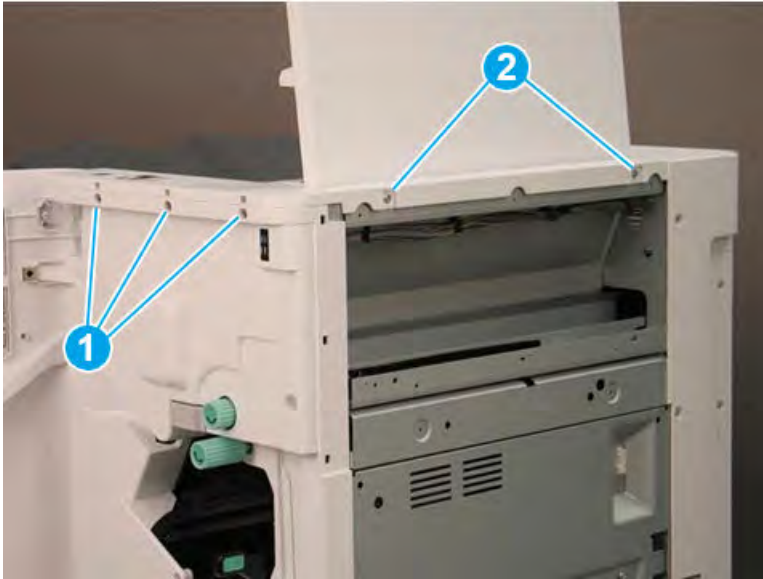
1. Remove three screw caps and three self-tapping screws at the top of the rear cover (callout 1), and then remove three machine screws (callout 2) on top of the cover.

Figure 5-1447 Remove six screws




2. Remove three self-tapping screws at the top of the front cover (callout 1), and then remove two machine screws (callout 2) at the top of the right side.

Figure 5-1448 Remove five screws



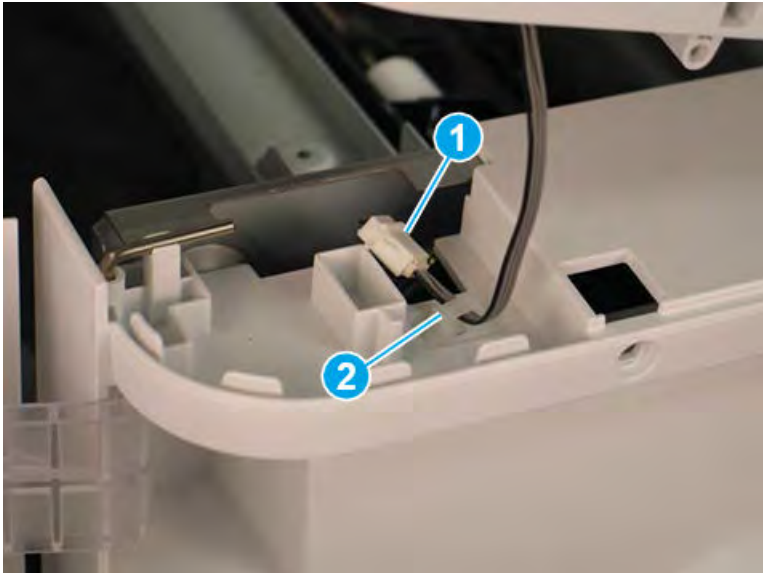
3. Lift the cover up slightly. Disconnect one in-line connector (callout 1), and then release one retainer (callout 2).

---

 **TIP:** Reverse the removal steps to install the assembly.

---

Figure 5-1449 Disconnect one connector and release retainer

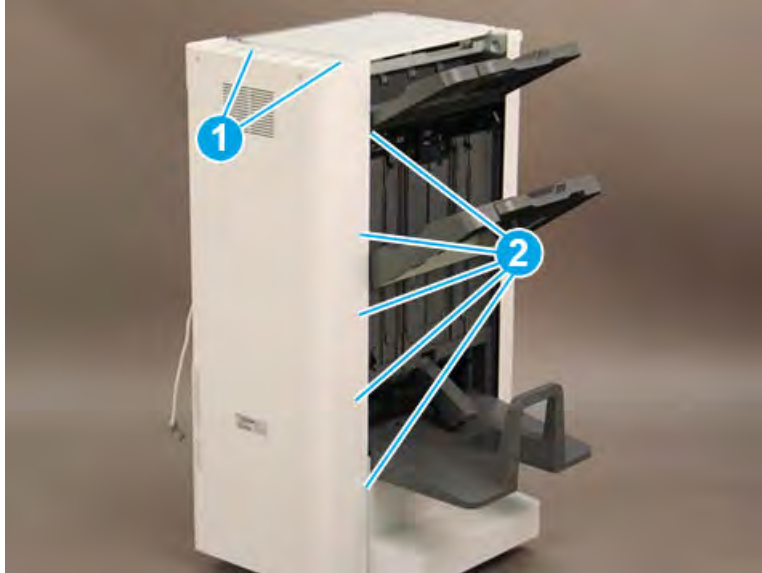


### Remove the rear cover (finisher)

Follow these steps to remove the rear cover (finisher).


1. Remove two self-tapping screws (callout 1) on the top of the rear cover, and then remove five screw caps and five machine screws (callout 2) on the left side of the cover.

Figure 5-1450 Remove seven screws




2. Remove one screw cap and four machine screws (callout 1) Remove the rear cover.

---

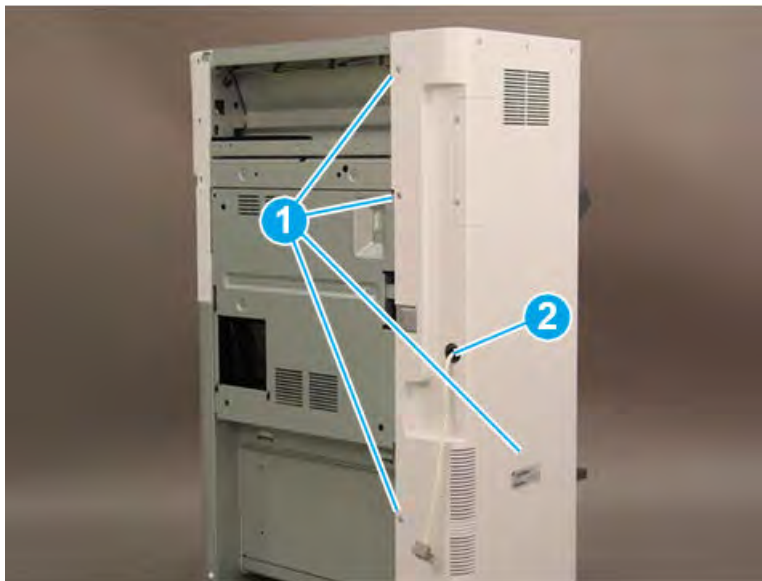
 **NOTE:** Make sure to thread the power cable (callout 2) through the opening in the cover.

---

 **TIP:** Reverse the removal steps to install the assembly

---

Figure 5-1451 Remove the rear cover



### Remove the booklet maker

Follow these steps to remove the booklet maker.

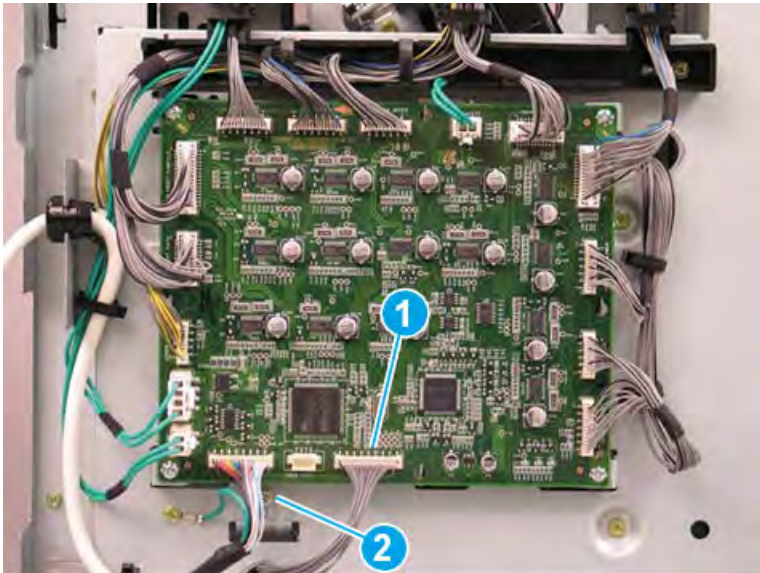
1. Slide the booklet maker away from the finisher.

Figure 5-1452 Slide the booklet maker away from the finisher



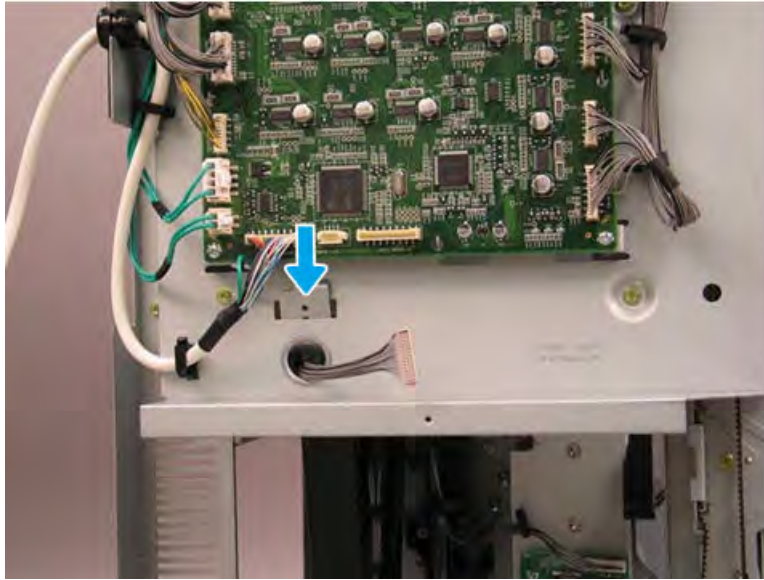
2. At the Disconnect one connector (callout 1), and then remove one screw (callout 2).

Figure 5-1453 Disconnect one connector and remove one screw



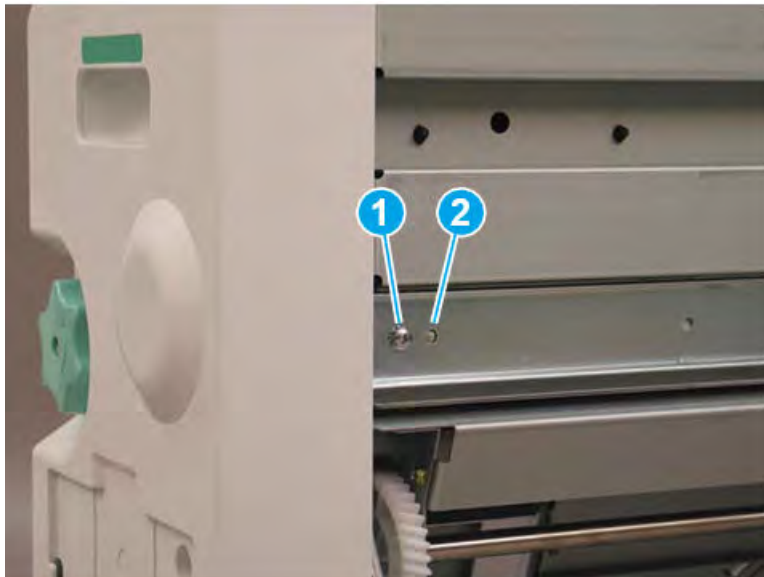
3. Release the metal bracket through the opening in the sheet metal.

Figure 5-1454 Release the metal bracket



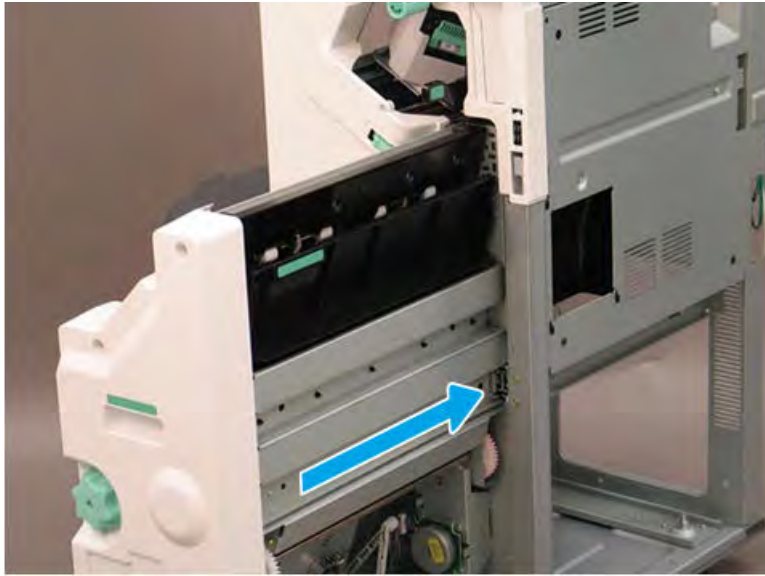
4. Remove one star-washer screw (callout 1), and then release the alignment pin (callout 2) on the right side of the booklet maker.

Figure 5-1455 Remove one screw



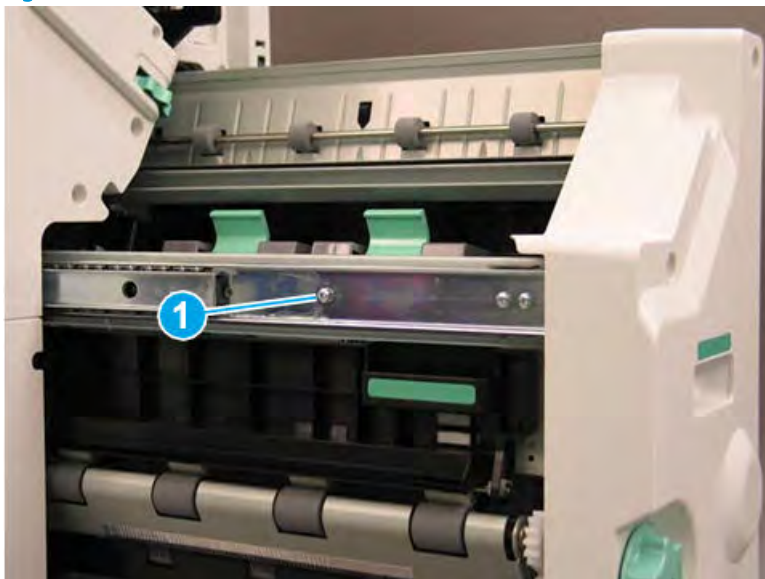
5. Slide the right rail toward the finisher.

Figure 5-1456 Slide the right rail



6. Remove one star-washer screw (callout 1) on the left side of the booklet maker.

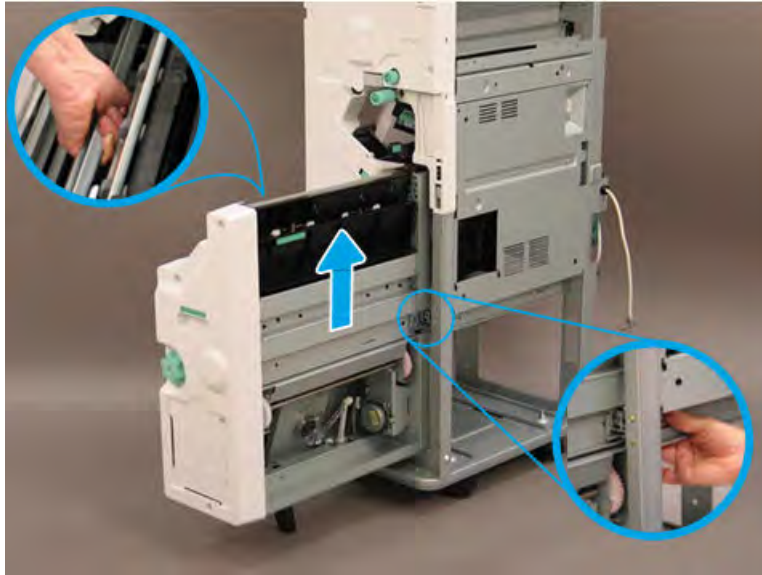
Figure 5-1457 Remove one screw





7. Lift the booklet maker up on the left side while squeezing the right rail away from the finisher slightly to clear the sheet metal. Remove the booklet maker.

Figure 5-1458 Remove the booklet maker



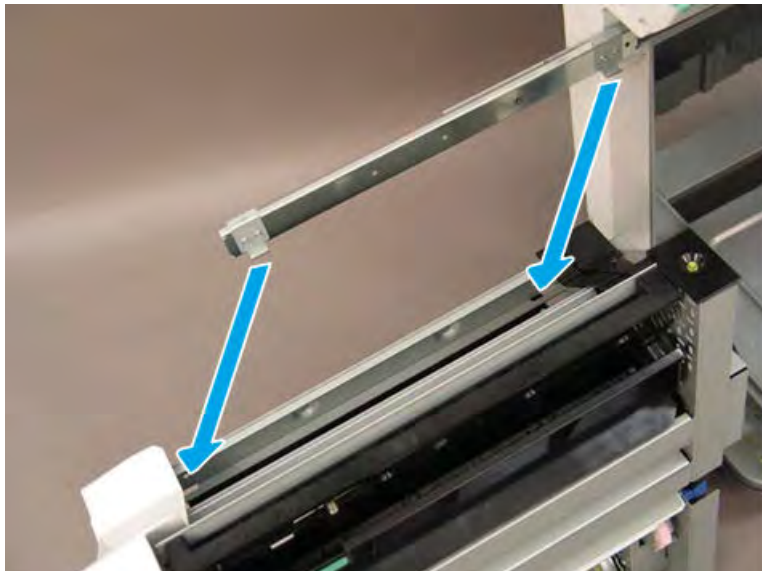
8. Reverse the removal steps to install the assembly. Also use the following special installation instructions.

 **NOTE:** Continue to reverse the removal steps to finish installing the assembly.

**Special installation instructions: booklet maker**

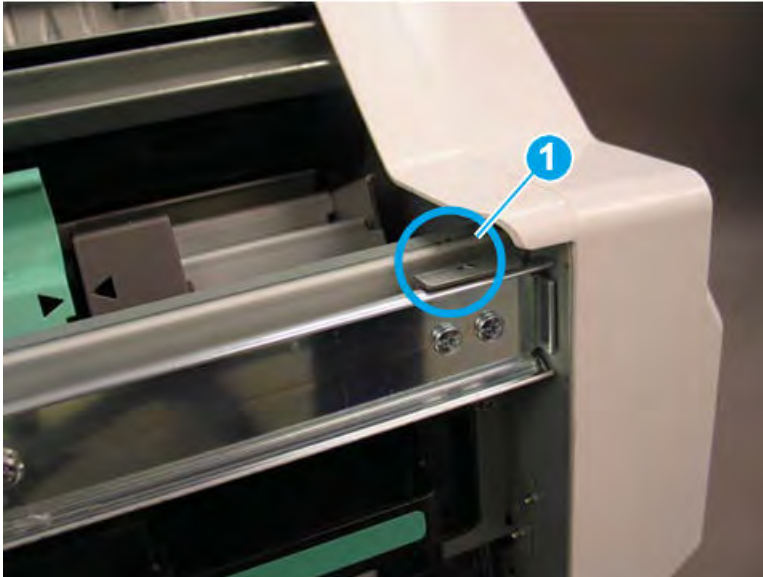
When installing the booklet maker, position the hooks on the rail under the slots on the booklet maker.

Figure 5-1459 Position the hooks



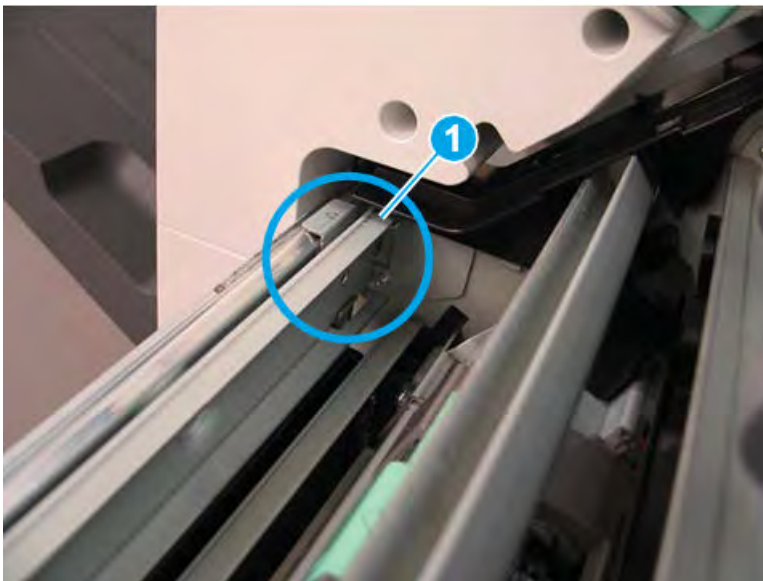
9. When installed correctly, the arrow on the front of the booklet maker aligns with the arrow on the finisher rail.

Figure 5-1460 Align arrows



10. When installed correctly, the arrow on the back of the booklet maker aligns with the arrow on the finisher rail.

Figure 5-1461 Align arrows



11. Extend the right rail away from the finisher and position it in the booklet maker slot.

Figure 5-1462 Extend the right rail

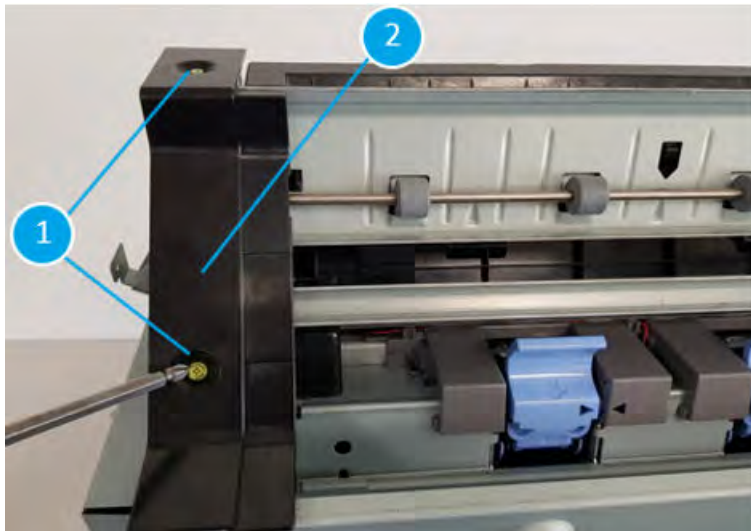


#### Remove the booklet entrance unit

Follow these steps to remove the booklet entrance unit.

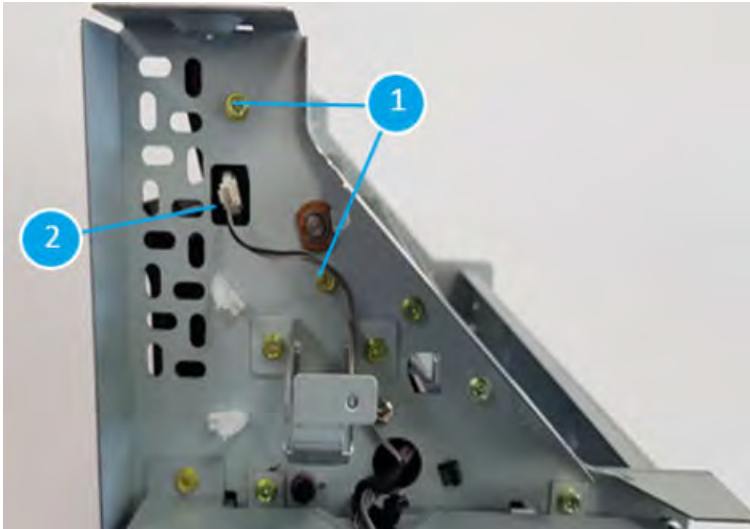
1. Remove two screws (callout 1) then remove the black cover (callout 2)

Figure 5-1463 Remove two screws then remove the black cover



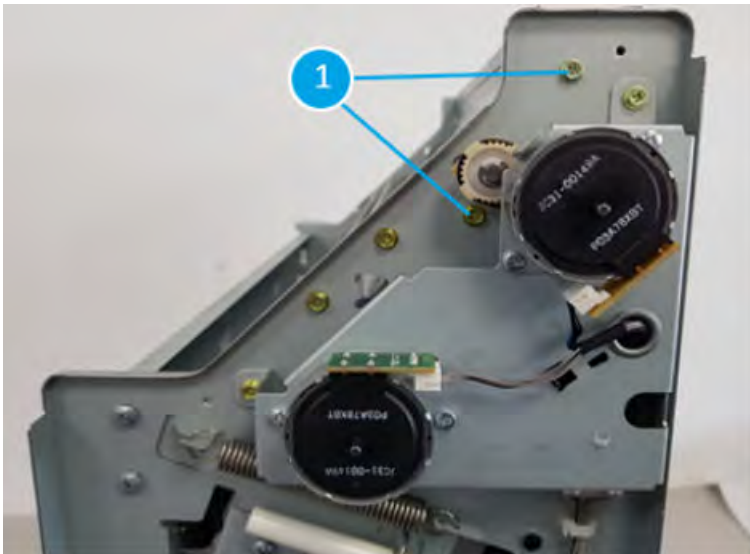
2. Remove two screws(callout 1) and disconnect one connector(callout 2)

Figure 5-1464 Remove two screws and disconnect one connector



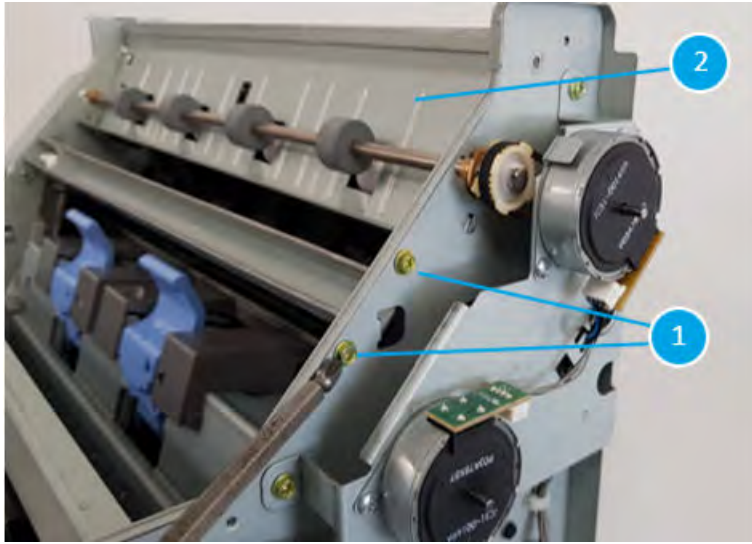
3. Remove two screws(callout 1)

Figure 5-1465 Remove two screws



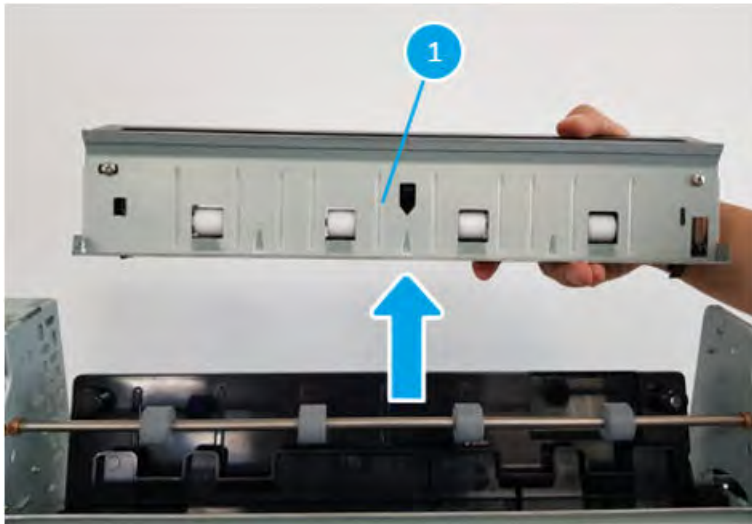
4. Remove two screws(callout 1) to make it easy to pull off the booklet entrance unit (callout2)

Figure 5-1466 Remove two screws to make it easy to pull off the booklet entrance unit



5. Remove the booklet entrance unit (callout 1)

Figure 5-1467 Remove the booklet entrance unit

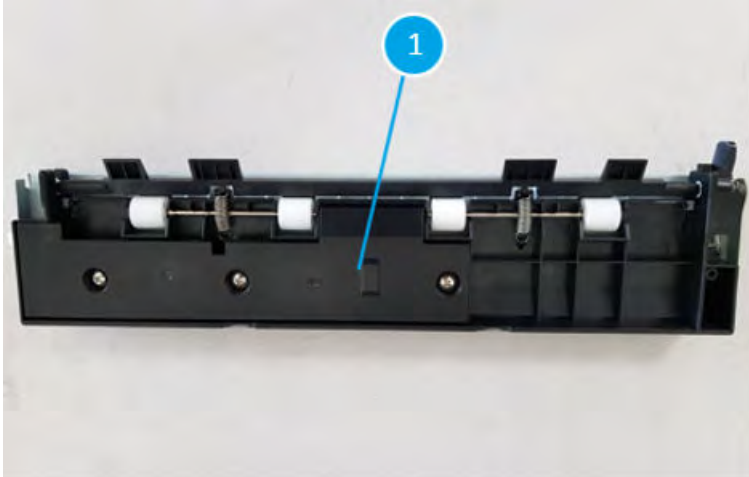


#### Remove the booklet entrance sensor (S36)

Follow these steps to remove the booklet entrance sensor (S36).

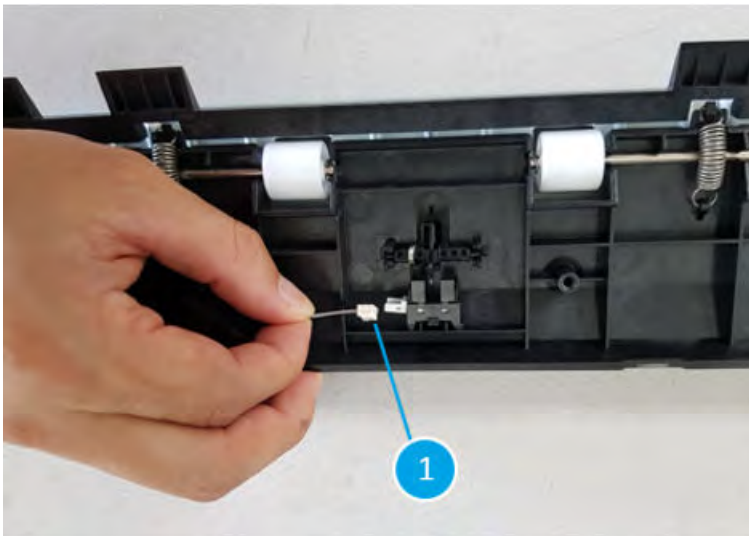
1. Entrance unit (callout 1)

Figure 5-1468 Entrance unit



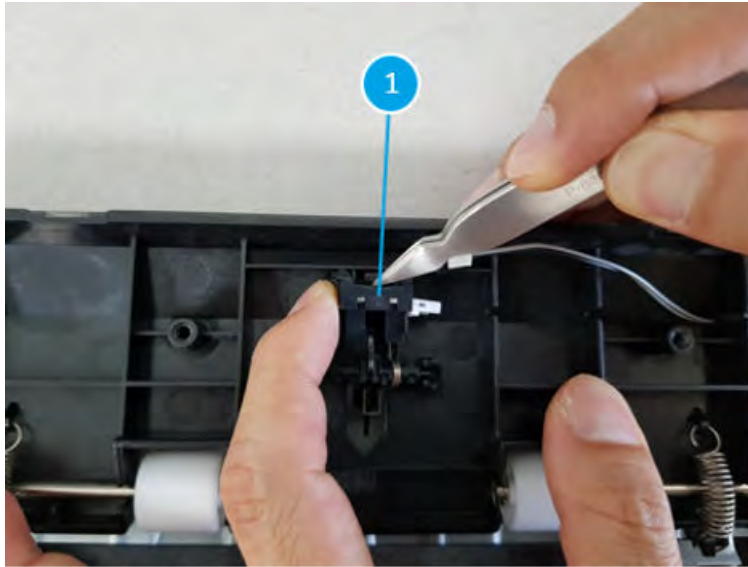
2. Unplug one connector (callout 1)

Figure 5-1469 Unplug one connector



3. Use a tweezer to remove the entrance sensor (S36, callout1)

Figure 5-1470 Remove the entrance sensor



### Unpack the replacement assembly

Follow these steps to unpack the replacement assembly.

1. Dispose of the defective part.




**NOTE:** HP recommends responsible disposal of the defective part.

<http://www8.hp.com/us/en/hp-information/environment/product-recycling.html>

2. Unpack the replacement part from the packaging.



**CAUTION:**  Some parts are sensitive to electrostatic discharge (ESD). Always perform service work at an ESD-protected workstation or mat. If an ESD workstation or mat is not available, touch the sheet-metal chassis to provide a static ground before touching an ESD-sensitive assembly. Protect the ESD-sensitive assemblies by placing them in ESD pouches when they are out of the printer.



**IMPORTANT:** Make sure that all of the shipping materials (for example shipping tape) are removed from the replacement part prior to installation.



**NOTE:** If the replacement part is a roller or pad, avoid touching the spongy part of it. Skin oils on the roller or pad can cause paper pickup and/or print-quality problems. HP recommends using disposable gloves when handling rollers or pads or washing your hands before touching rollers or pads.

3. To install an assembly, reverse the removal steps.



**NOTE:** When applicable, special installation instructions are provided for an assembly at the end of the removal procedure. Always completely read the removal instructions and follow all special installation instructions.

## Booklet paddle unit



## Removal and replacement: Booklet paddle motor (M19)

Learn how to remove and replace the booklet paddle motor.

### Introduction

This document provides the procedures to remove and replace the booklet paddle motor on the finisher.



**IMPORTANT:** When applicable, special installation instructions are provided for an assembly at the end of the removal procedure. Always completely read the removal instructions and follow all special installation instructions.

### Before performing service

- Turn the printer power off. A shutting-down message appears on the control-panel display.
- ⚠ **WARNING!** To avoid damage to the printer, turn the power off and wait until the printer shuts down before removing the power cable.
- Disconnect the printer power cable after the printer has completely shut down (the control-panel display is blank).
- Release the finisher from the printer by pulling out on the release latch inside the finisher door.
- Disconnect the cable from the bridge unit to the finisher.
- Disconnect the cable from the finisher to the printer.

Use the table below to identify the correct part number for your printer. To order the part, go to <https://parts.hp.com>.

**Table 5-146 Part information**

Part number	Part description
JC93-01001A	Booklet paddle motor
JC90-01430A	Booklet paddle motor assembly

### Required tools

- #2 JIS screwdriver with a magnetic tip

### After performing service

- Connect the cable from the finisher to the printer.
- Connect the cable from the bridge unit to the finisher.
- Attach the finisher to the printer, and then push in on the release latch inside the finisher door.
- Connect the printer power cable.
- Turn the printer power on.

### Post service test

Process a job through the finisher and verify that the finisher works correctly.

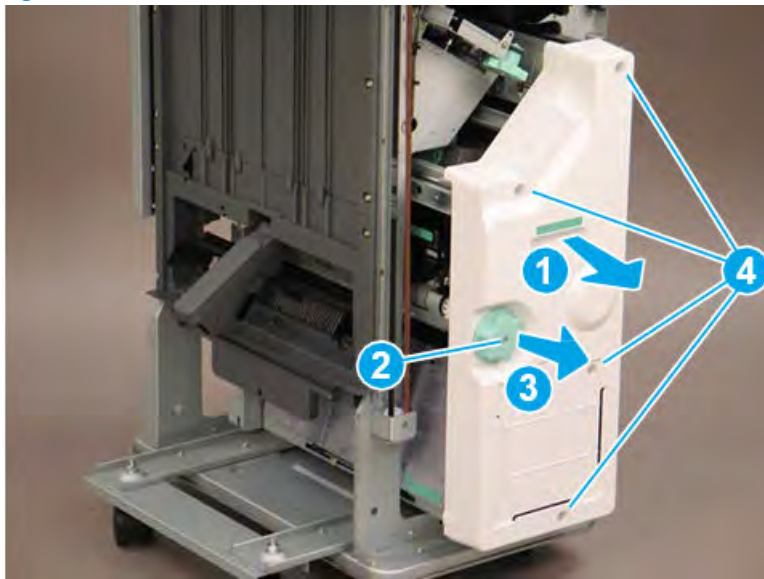
## Remove the booklet front cover

Follow these steps to remove the booklet front cover.

- ▲ Slide the booklet maker slightly away from the finisher (callout 1). Remove one screw (callout 2), and then slide the green knob away from the booklet maker to remove it (callout 3). Remove four screws (callout 4), and then remove the booklet front cover.

💡 **TIP:** Reverse the removal steps to install the assembly

**Figure 5-1471** Remove five screws and the cover

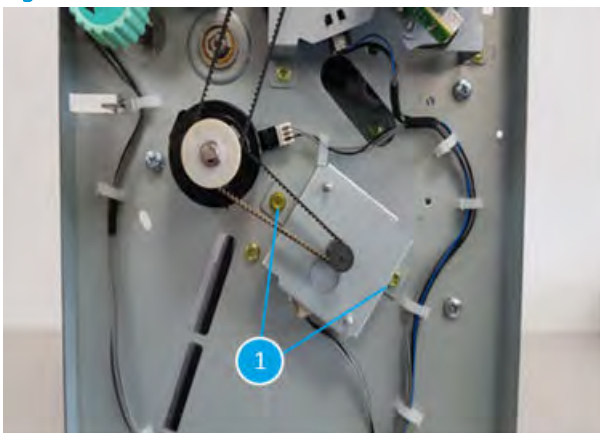


## Remove the booklet paddle motor (M19)

Follow these steps to remove the booklet paddle motor (M19).

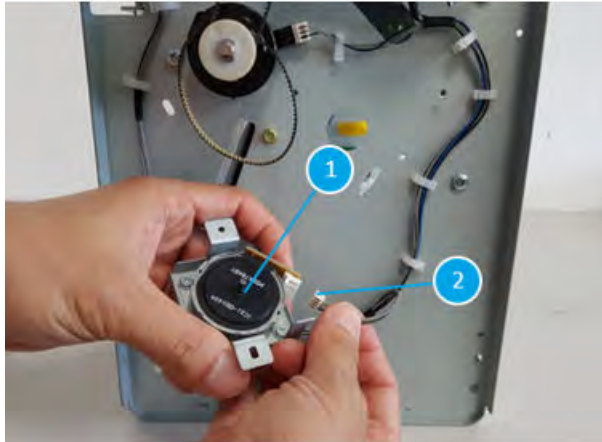
1. Remove two screws (callout 1)

**Figure 5-1472** Remove two screws



2. Remove the booklet paddle motor (M19, callout1) and unplug one connector (callout 2)

**Figure 5-1473** Remove the booklet paddle motor and unplug one connector



### Unpack the replacement assembly



Follow these steps to unpack the replacement assembly.

1. Dispose of the defective part.


 **NOTE:** HP recommends responsible disposal of the defective part.

<http://www8.hp.com/us/en/hp-information/environment/product-recycling.html>


2. Unpack the replacement part from the packaging.

 **CAUTION:**  Some parts are sensitive to electrostatic discharge (ESD). Always perform service work at an ESD-protected workstation or mat. If an ESD workstation or mat is not available, touch the sheet-metal chassis to provide a static ground before touching an ESD-sensitive assembly. Protect the ESD-sensitive assemblies by placing them in ESD pouches when they are out of the printer.

 **IMPORTANT:** Make sure that all of the shipping materials (for example shipping tape) are removed from the replacement part prior to installation.

 **NOTE:** If the replacement part is a roller or pad, avoid touching the spongy part of it. Skin oils on the roller or pad can cause paper pickup and/or print-quality problems. HP recommends using disposable gloves when handling rollers or pads or washing your hands before touching rollers or pads.

3. To install an assembly, reverse the removal steps.


 **NOTE:** When applicable, special installation instructions are provided for an assembly at the end of the removal procedure. Always completely read the removal instructions and follow all special installation instructions.

## Removal and replacement: Booklet paddle home sensor (S41)

Learn how to remove and replace the booklet paddle home sensor.

### Introduction

This document provides the procedures to remove and replace the booklet paddle home sensor on the finisher.

 **IMPORTANT:** When applicable, special installation instructions are provided for an assembly at the end of the removal procedure. Always completely read the removal instructions and follow all special installation instructions.

### Before performing service

- Turn the printer power off. A shutting-down message appears on the control-panel display.
- ⚠ **WARNING!** To avoid damage to the printer, turn the power off and wait until the printer shuts down before removing the power cable.
- Disconnect the printer power cable after the printer has completely shut down (the control-panel display is blank).
- Release the finisher from the printer by pulling out on the release latch inside the finisher door.
- Disconnect the cable from the bridge unit to the finisher.
- Disconnect the cable from the finisher to the printer.

Use the table below to identify the correct part number for your printer. To order the part, go to <https://parts.hp.com>.

**Table 5-147** Part information

Part number	Part description
0604-001393	Booklet paddle home sensor

### Required tools

- #2 JIS screwdriver with a magnetic tip

### After performing service

- Connect the cable from the finisher to the printer.
- Connect the cable from the bridge unit to the finisher.
- Attach the finisher to the printer, and then push in on the release latch inside the finisher door.
- Connect the printer power cable.
- Turn the printer power on.

### Post service test

Process a job through the finisher and verify that the finisher works correctly.

### Remove the right upper cover (finisher)

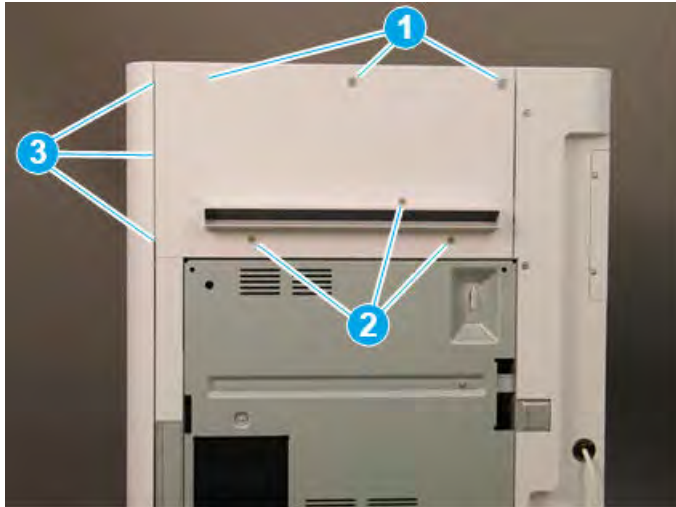
Follow these steps to remove the right upper cover (finisher).

- ▲ Remove one screw cap and three machine screws on the upper edge of the cover (callout 1). Remove three sheet metal screws (callout 2) on the lower portion of the cover. Rotate the right edge of the cover away from the finisher, and then slide the cover right to release three tabs (callout 3).

💡 **TIP:** The lower screws are shorter in length than the upper screws.

**TIP:** Reverse the removal steps to install the assembly.

Figure 5-1474 Remove the right upper cover

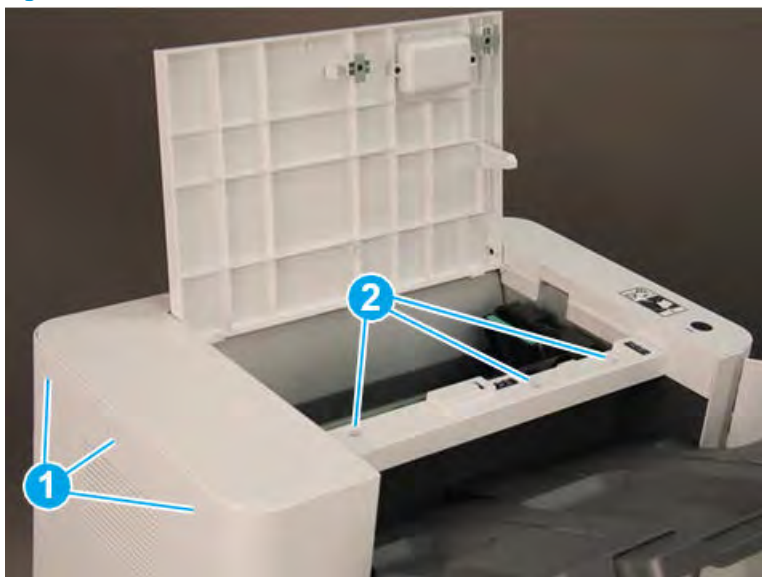


### Remove the top cover (finisher)

Follow these steps to remove the top cover (finisher).

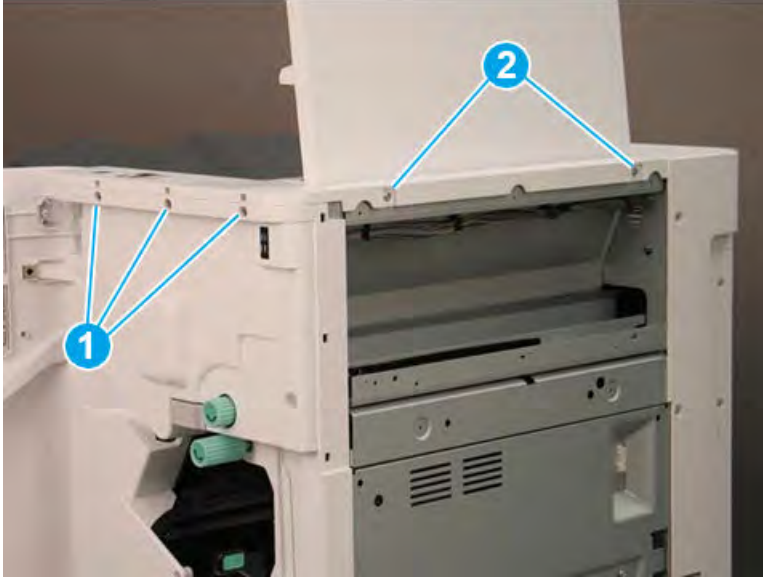
1. Remove three screw caps and three self-tapping screws at the top of the rear cover (callout 1), and then remove three machine screws (callout 2) on top of the cover.

Figure 5-1475 Remove six screws




2. Remove three self-tapping screws at the top of the front cover (callout 1), and then remove two machine screws (callout 2) at the top of the right side.

Figure 5-1476 Remove five screws



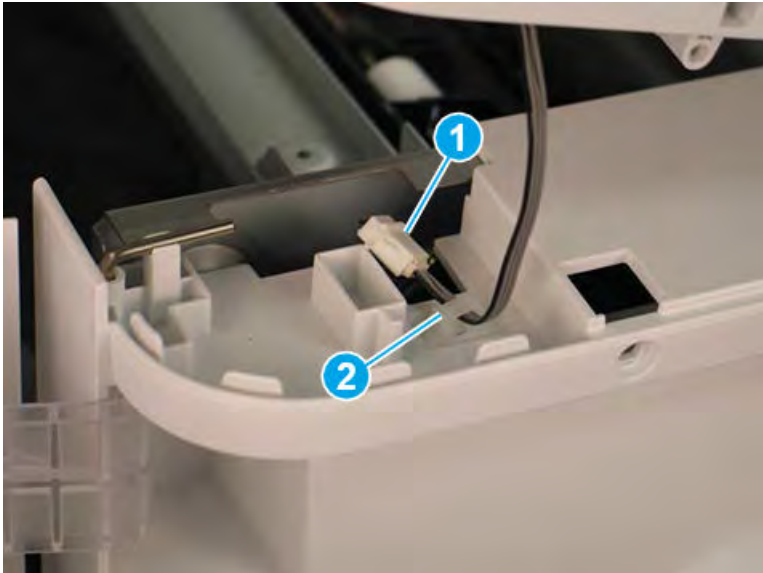
3. Lift the cover up slightly. Disconnect one in-line connector (callout 1), and then release one retainer (callout 2).

---

 **TIP:** Reverse the removal steps to install the assembly.

---

Figure 5-1477 Disconnect one connector and release retainer



### Remove the rear cover (finisher)

Follow these steps to remove the rear cover (finisher).

1. Remove two self-tapping screws (callout 1) on the top of the rear cover, and then remove five screw caps and five machine screws (callout 2) on the left side of the cover.

Figure 5-1478 Remove seven screws



2. Remove one screw cap and four machine screws (callout 1) Remove the rear cover.

 **NOTE:** Make sure to thread the power cable (callout 2) through the opening in the cover.


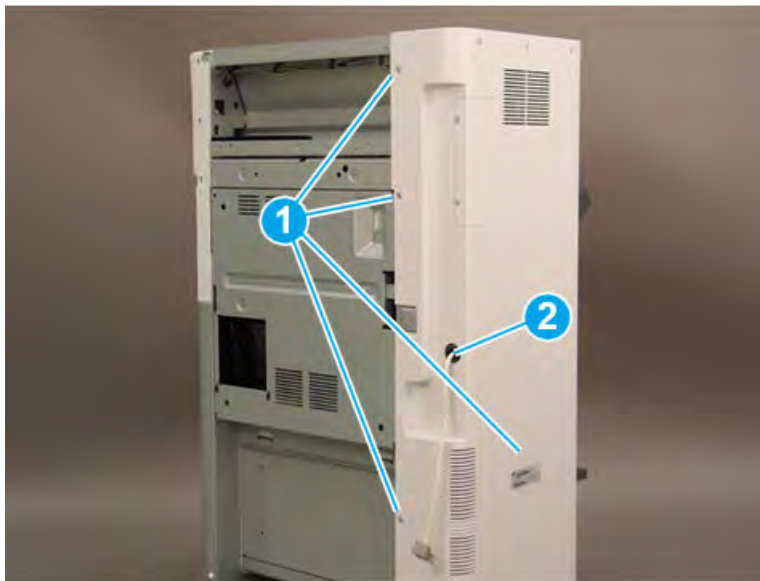
 **TIP:** Reverse the removal steps to install the assembly

Figure 5-1479 Remove the rear cover



### Remove the booklet front cover

Follow these steps to remove the booklet front cover.

- ▲ Slide the booklet maker slightly away from the finisher (callout 1). Remove one screw (callout 2), and then slide the green knob away from the booklet maker to remove it (callout 3). Remove four screws (callout 4), and then remove the booklet front cover.


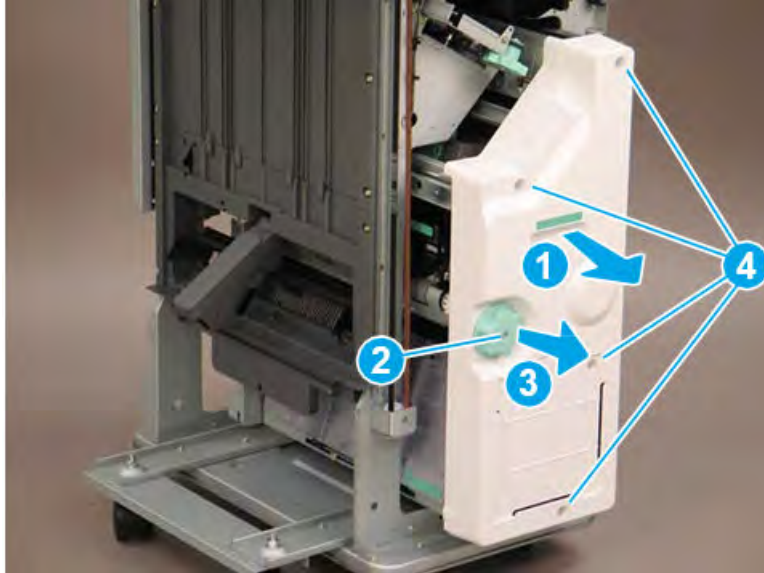
 **TIP:** Reverse the removal steps to install the assembly

Figure 5-1480 Remove five screws and the cover

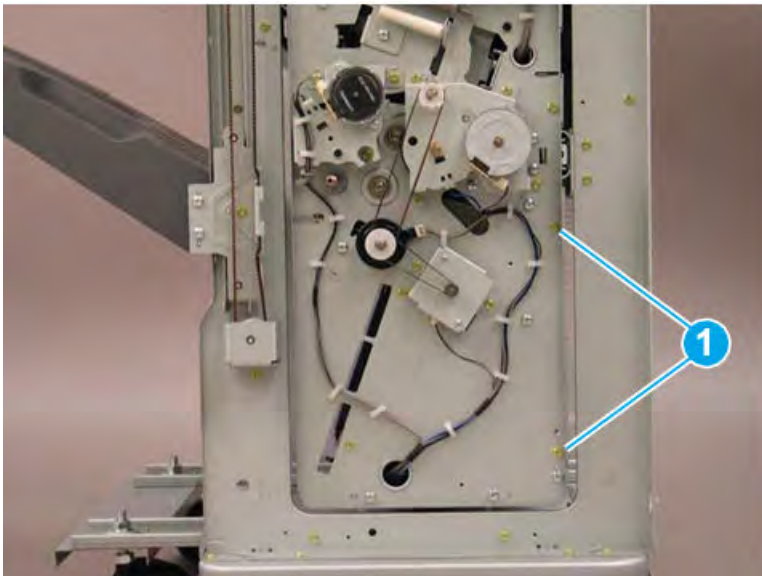


### Remove the booklet right lower shield

Follow these steps to remove the booklet right lower shield.

1. Remove two screws at the front of the booklet maker (callout 1).

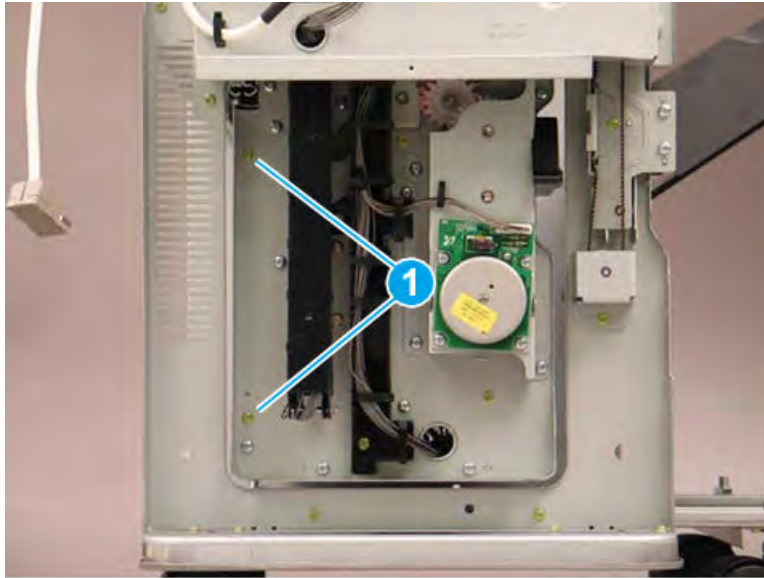
Figure 5-1481 Remove two screws





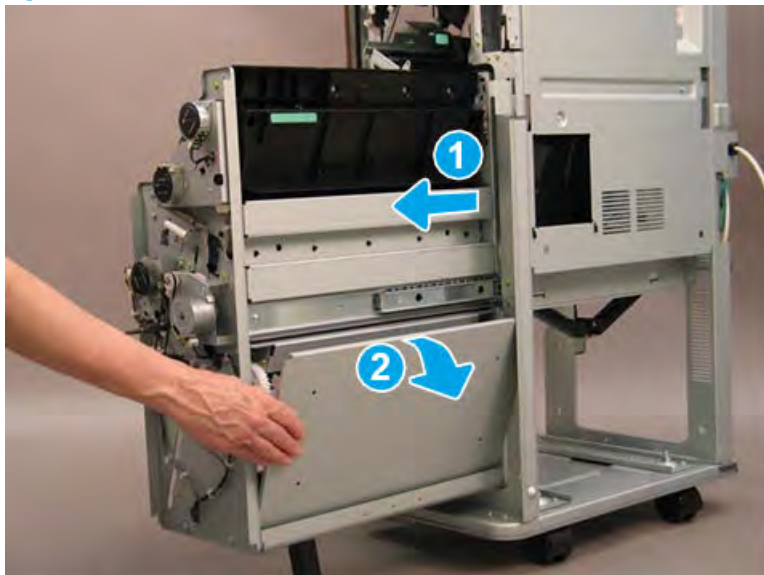
2. Remove two screws at the back of the booklet maker (callout 1).

Figure 5-1482 Remove two screws



3. Slide the booklet maker out of the finisher (callout 1), and then rotate the top of the right lower shield (callout 2) away from the booklet maker to remove it.

Figure 5-1483 Remove the right lower shield

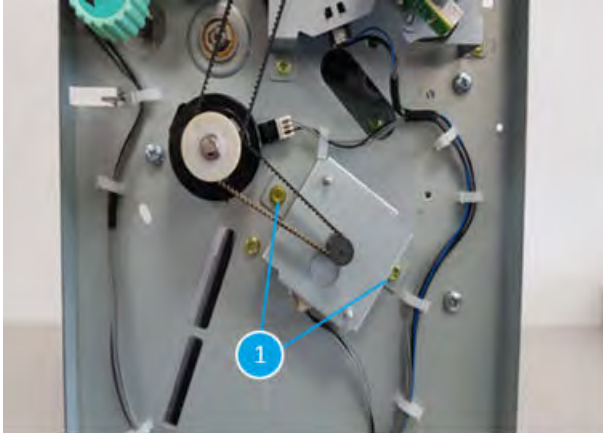


### Remove the booklet paddle motor (M19)

Follow these steps to remove the booklet paddle motor (M19).

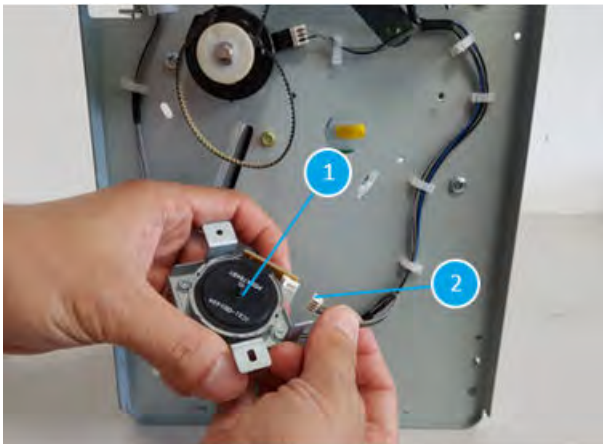
1. Remove two screws (callout 1)

Figure 5-1484 Remove two screws



2. Remove the booklet paddle motor (M19, callout 1) and unplug one connector (callout 2)

Figure 5-1485 Remove the booklet paddle motor and unplug one connector



### Remove the booklet paddle home sensor (S41)

Follow these steps to remove the booklet paddle home sensor (S41).

1. Remove one e-clip on top of the white washer and then remove the white washer (callout 1)

Figure 5-1486 Remove white washer



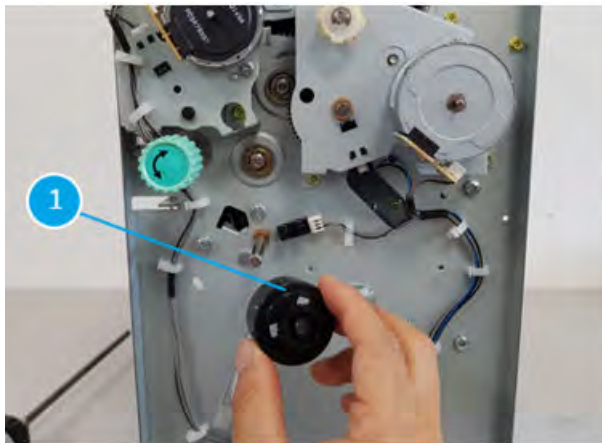
2. Remove two belts (callout 1)

Figure 5-1487 Remove two belts



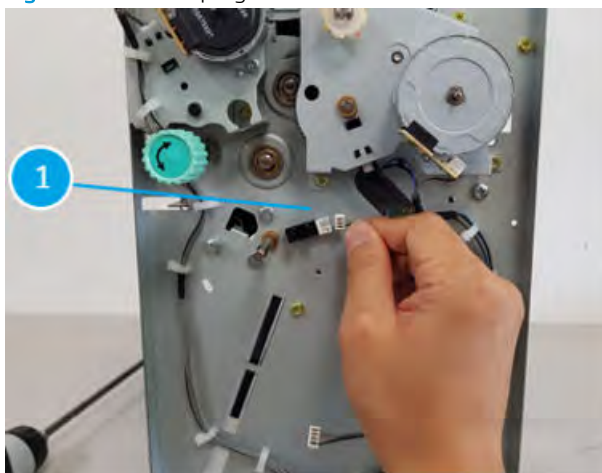
3. Remove the black actuator (callout 1)

Figure 5-1488 Remove the black actuator



4. Unplug one connector (callout 1)

Figure 5-1489 Unplug one connector



5. Use a tweezer to remove the Booklet paddle home sensor (S41, callout 1) from the left side

**Figure 5-1490** Use a tweezer to remove the Booklet paddle home sensor



### Unpack the replacement assembly

Follow these steps to unpack the replacement assembly.

1. Dispose of the defective part.

---



 **NOTE:** HP recommends responsible disposal of the defective part.

<http://www8.hp.com/us/en/hp-information/environment/product-recycling.html>


---

2. Unpack the replacement part from the packaging.

---

 **CAUTION:**  Some parts are sensitive to electrostatic discharge (ESD). Always perform service work at an ESD-protected workstation or mat. If an ESD workstation or mat is not available, touch the sheet-metal chassis to provide a static ground before touching an ESD-sensitive assembly. Protect the ESD-sensitive assemblies by placing them in ESD pouches when they are out of the printer.


 **IMPORTANT:** Make sure that all of the shipping materials (for example shipping tape) are removed from the replacement part prior to installation.

 **NOTE:** If the replacement part is a roller or pad, avoid touching the spongy part of it. Skin oils on the roller or pad can cause paper pickup and/or print-quality problems. HP recommends using disposable gloves when handling rollers or pads or washing your hands before touching rollers or pads.

---

3. To install an assembly, reverse the removal steps.

---

 **NOTE:** When applicable, special installation instructions are provided for an assembly at the end of the removal procedure. Always completely read the removal instructions and follow all special installation instructions.

---

## Booklet end fence unit

## Removal and replacement: Booklet end fence unit

Learn how to remove and replace the booklet end fence.

### Introduction

This document provides the procedures to remove and replace the booklet end fence on the finisher.



**IMPORTANT:** When applicable, special installation instructions are provided for an assembly at the end of the removal procedure. Always completely read the removal instructions and follow all special installation instructions.

### Before performing service

- Turn the printer power off. A shutting-down message appears on the control-panel display.
- ⚠ **WARNING!** To avoid damage to the printer, turn the power off and wait until the printer shuts down before removing the power cable.
- Disconnect the printer power cable after the printer has completely shut down (the control-panel display is blank).
- Release the finisher from the printer by pulling out on the release latch inside the finisher door.
- Disconnect the cable from the bridge unit to the finisher.
- Disconnect the cable from the finisher to the printer.

Use the table below to identify the correct part number for your printer. To order the part, go to <https://parts.hp.com>.

**Table 5-148** Part information

Part number	Part description
JC90-01432A	Booklet end fence unit

### Required tools

- #2 JIS screwdriver with a magnetic tip

### After performing service

- Connect the cable from the finisher to the printer.
- Connect the cable from the bridge unit to the finisher.
- Attach the finisher to the printer, and then push in on the release latch inside the finisher door.
- Connect the printer power cable.
- Turn the printer power on.

### Post service test

Process a job through the finisher and verify that the finisher works correctly.

### Remove the right upper cover (finisher)

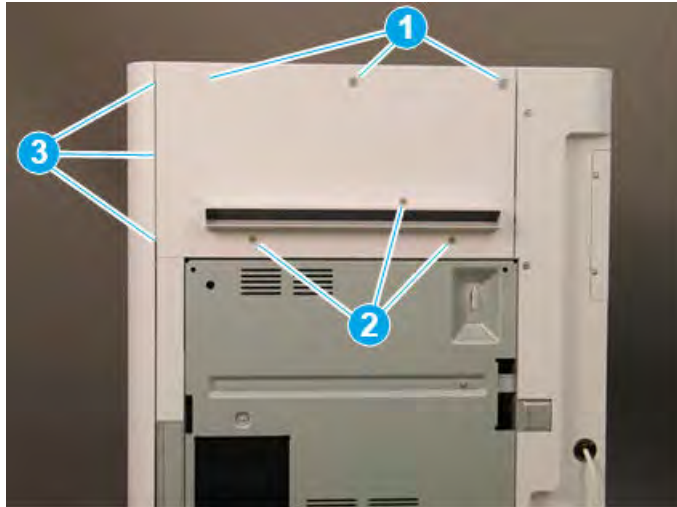
Follow these steps to remove the right upper cover (finisher).

- ▲ Remove one screw cap and three machine screws on the upper edge of the cover (callout 1). Remove three sheet metal screws (callout 2) on the lower portion of the cover. Rotate the right edge of the cover away from the finisher, and then slide the cover right to release three tabs (callout 3).

💡 **TIP:** The lower screws are shorter in length than the upper screws.

**TIP:** Reverse the removal steps to install the assembly.

Figure 5-1491 Remove the right upper cover

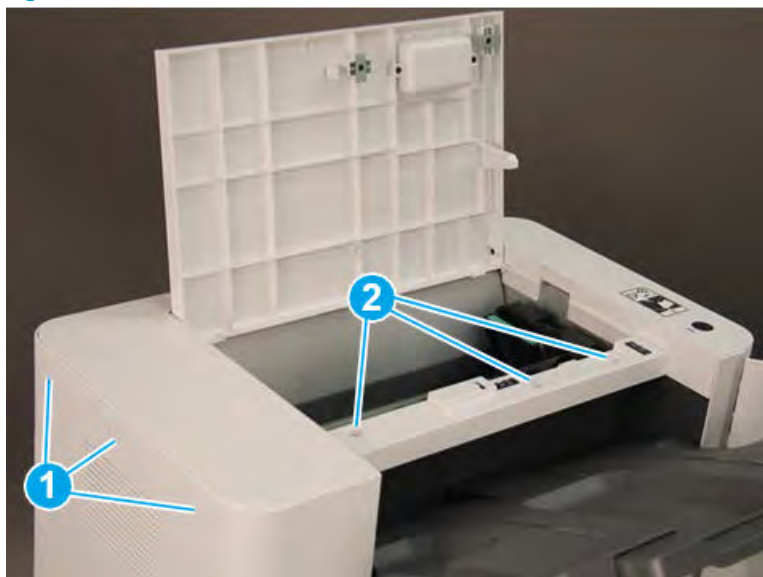


### Remove the top cover (finisher)

Follow these steps to remove the top cover (finisher).

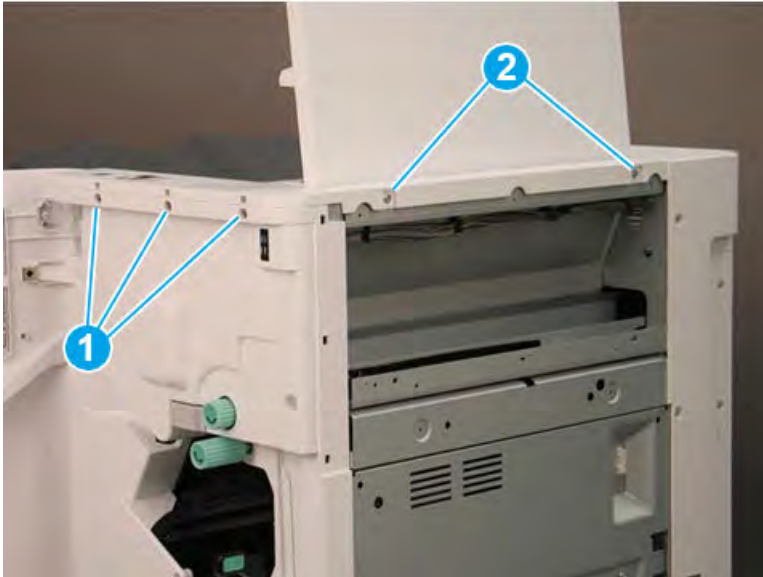
1. Remove three screw caps and three self-tapping screws at the top of the rear cover (callout 1), and then remove three machine screws (callout 2) on top of the cover.

Figure 5-1492 Remove six screws




2. Remove three self-tapping screws at the top of the front cover (callout 1), and then remove two machine screws (callout 2) at the top of the right side.

Figure 5-1493 Remove five screws



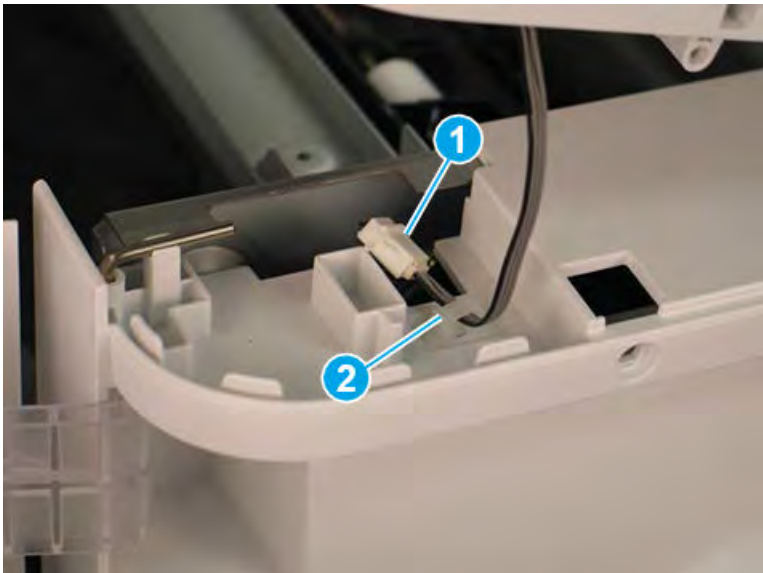
3. Lift the cover up slightly. Disconnect one in-line connector (callout 1), and then release one retainer (callout 2).

---

 **TIP:** Reverse the removal steps to install the assembly.

---

Figure 5-1494 Disconnect one connector and release retainer



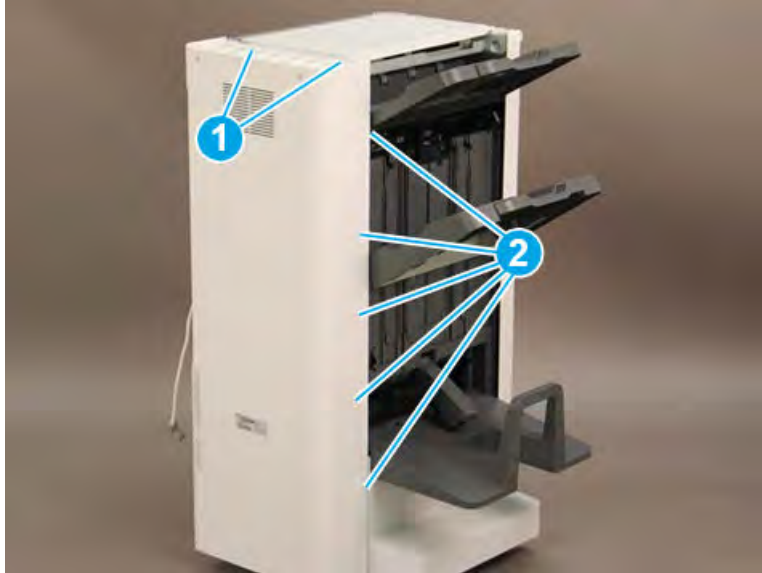
### Remove the rear cover (finisher)

Follow these steps to remove the rear cover (finisher).

1. Remove two self-tapping screws (callout 1) on the top of the rear cover, and then remove five screw caps and five machine screws (callout 2) on the left side of the cover.



Figure 5-1495 Remove seven screws



2. Remove one screw cap and four machine screws (callout 1) Remove the rear cover.

---

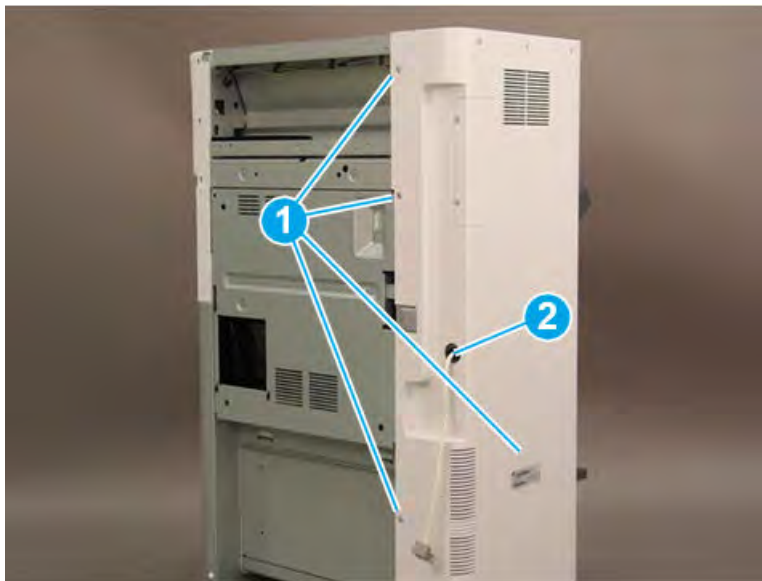
 **NOTE:** Make sure to thread the power cable (callout 2) through the opening in the cover.

---

 **TIP:** Reverse the removal steps to install the assembly

---

Figure 5-1496 Remove the rear cover




### Remove the booklet front cover

Follow these steps to remove the booklet front cover.

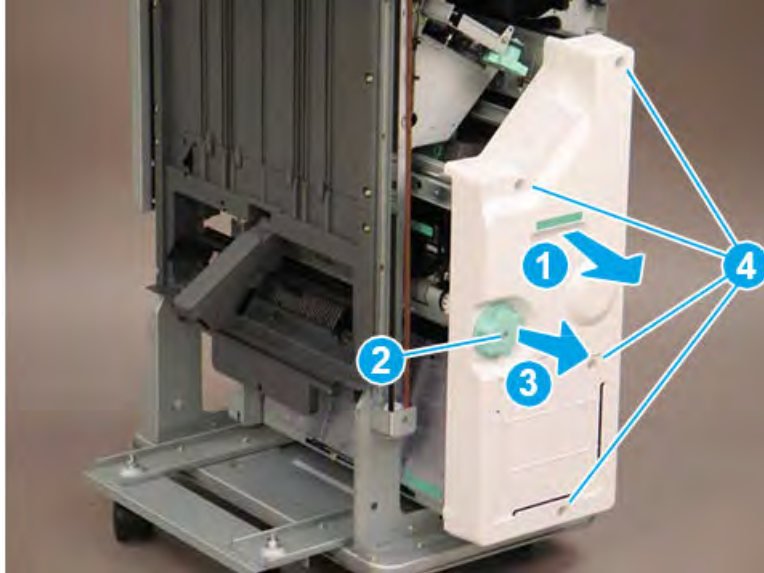
- ▲ Slide the booklet maker slightly away from the finisher (callout 1). Remove one screw (callout 2), and then slide the green knob away from the booklet maker to remove it (callout 3). Remove four screws (callout 4), and then remove the booklet front cover.

---

 **TIP:** Reverse the removal steps to install the assembly

---

Figure 5-1497 Remove five screws and the cover

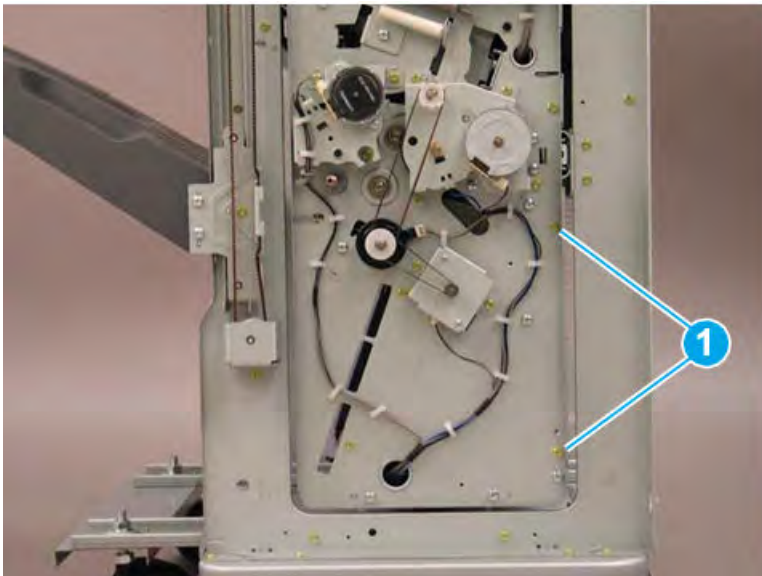


### Remove the booklet right lower shield

Follow these steps to remove the booklet right lower shield.

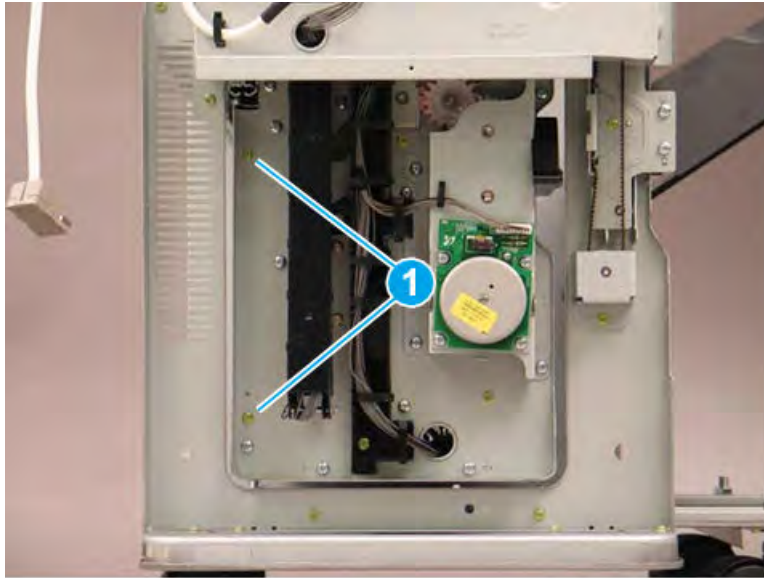
1. Remove two screws at the front of the booklet maker (callout 1).

Figure 5-1498 Remove two screws



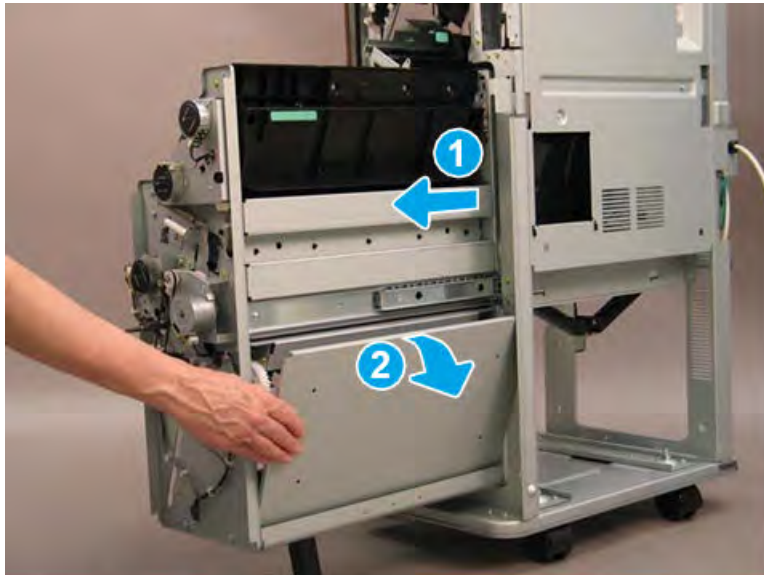
2. Remove two screws at the back of the booklet maker (callout 1).

Figure 5-1499 Remove two screws



3. Slide the booklet maker out of the finisher (callout 1), and then rotate the top of the right lower shield (callout 2) away from the booklet maker to remove it.

Figure 5-1500 Remove the right lower shield

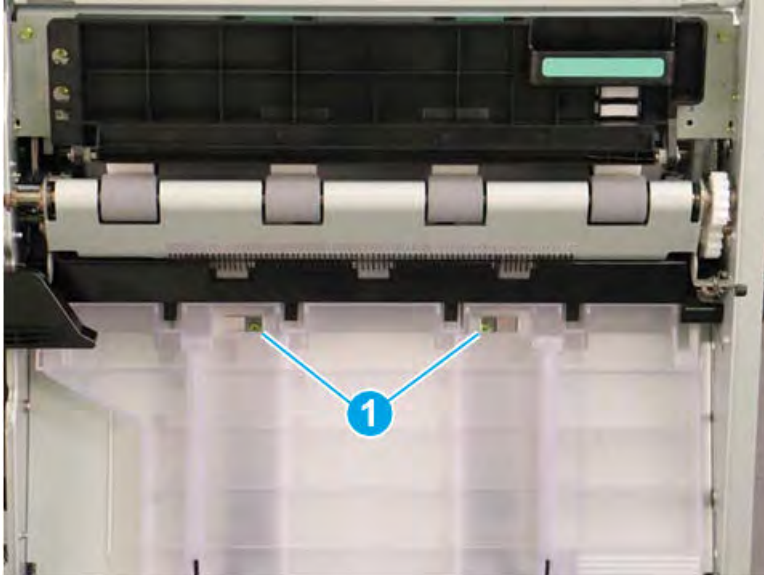


### Remove the fold stopper unit

Follow these steps to remove the fold stopper unit.

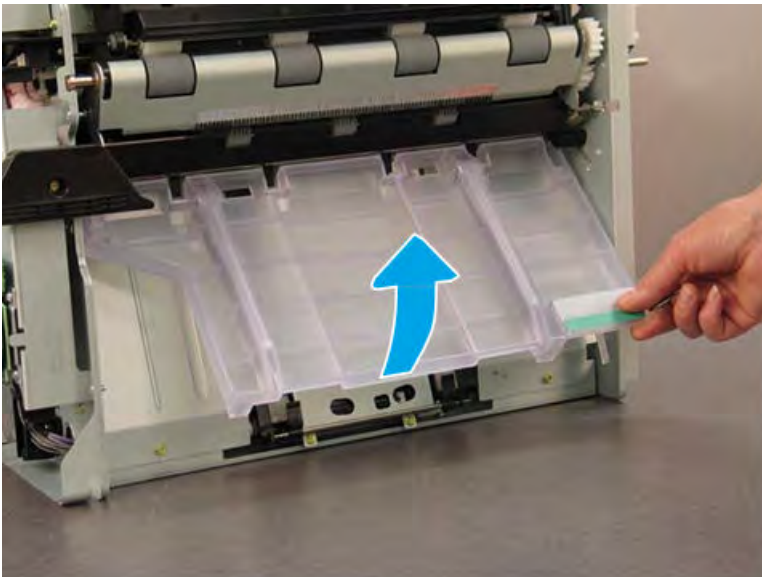
1. On the left side of the booklet maker, remove two screws through access openings in the jam access cover (callout 1).

Figure 5-1501 Remove two screws



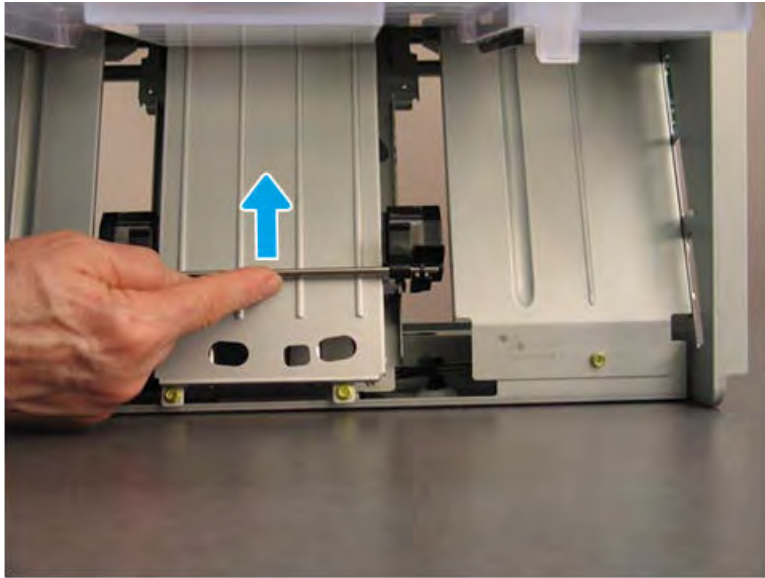
2. Raise the jam access cover.

Figure 5-1502 Raise the jam access cover



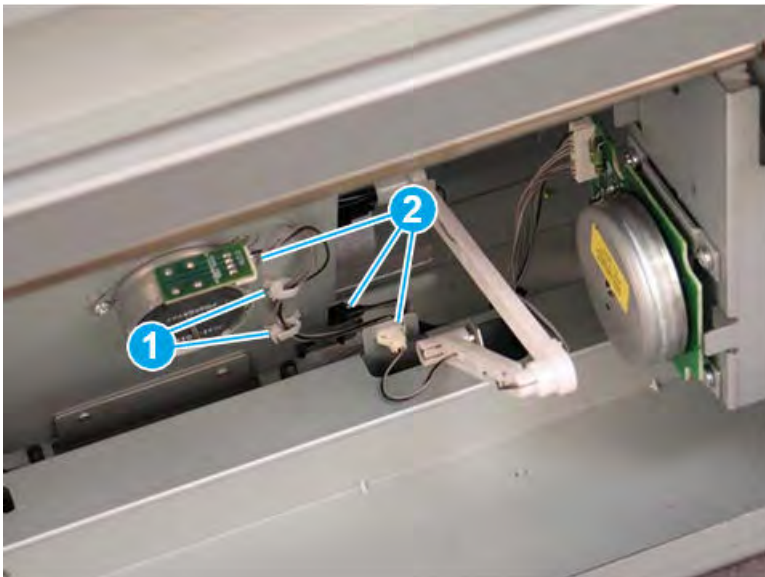
3. Raise the booklet width guide.

Figure 5-1503 Raise the booklet width guide.



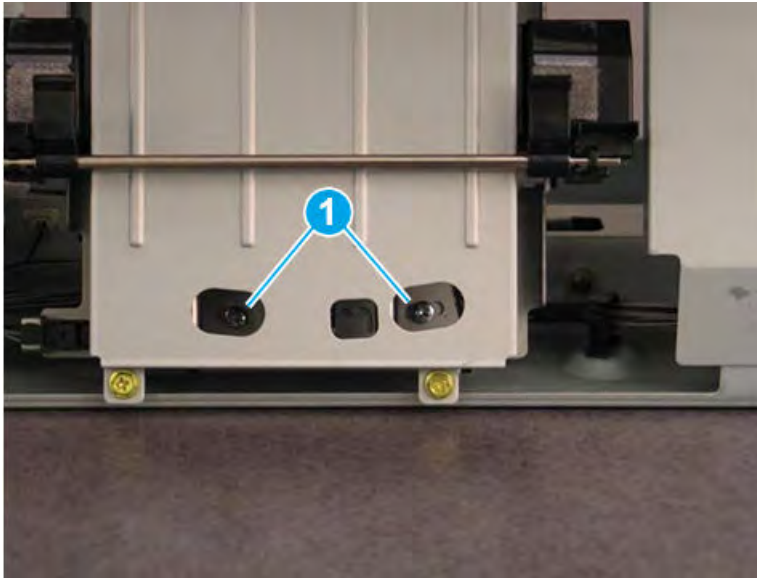
4. On the right side of the booklet maker, open two retainers (callout 1), and then disconnect three connectors (callout 2).

Figure 5-1504 Disconnect three connectors



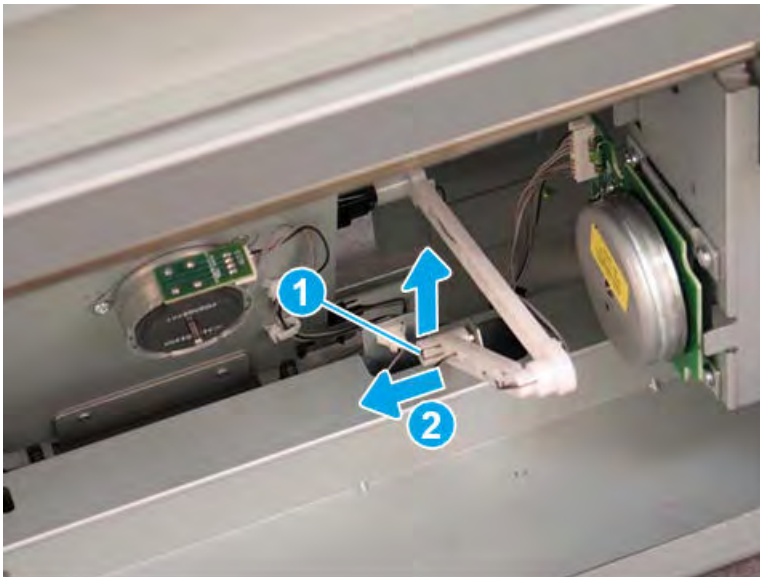
5. Remove two screws (callout 1).

Figure 5-1505 Remove two screws



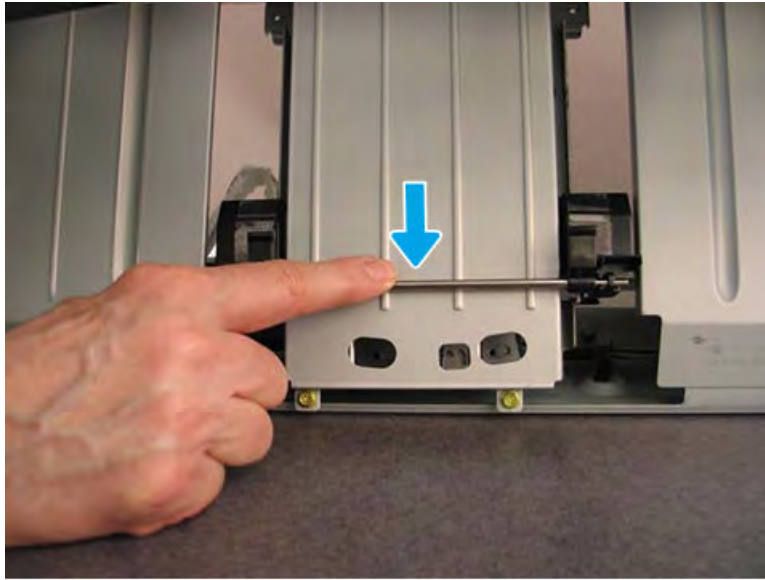
6. Release the tab (callout 1) on the guide arm, and then slide the guide off of the shaft (callout 2) to remove it.

Figure 5-1506 Release the guide arm



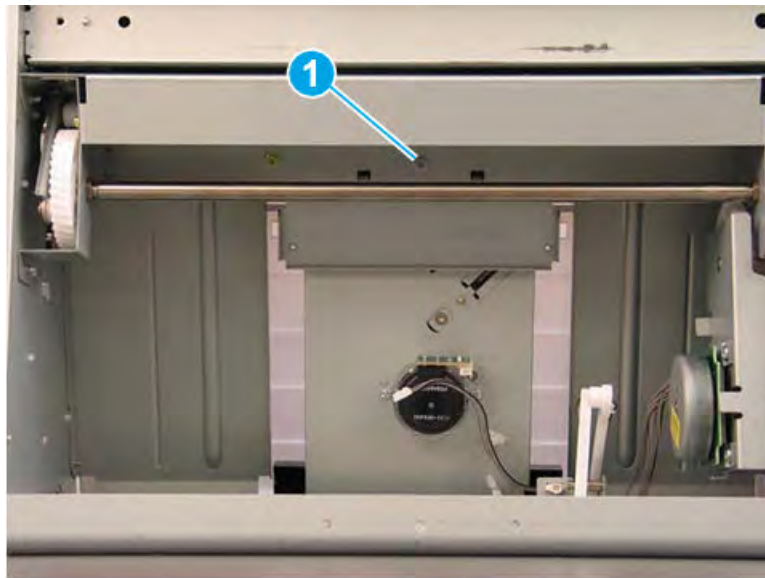
7. Lower the width guide to the lowest position.

Figure 5-1507 Lower the width guide



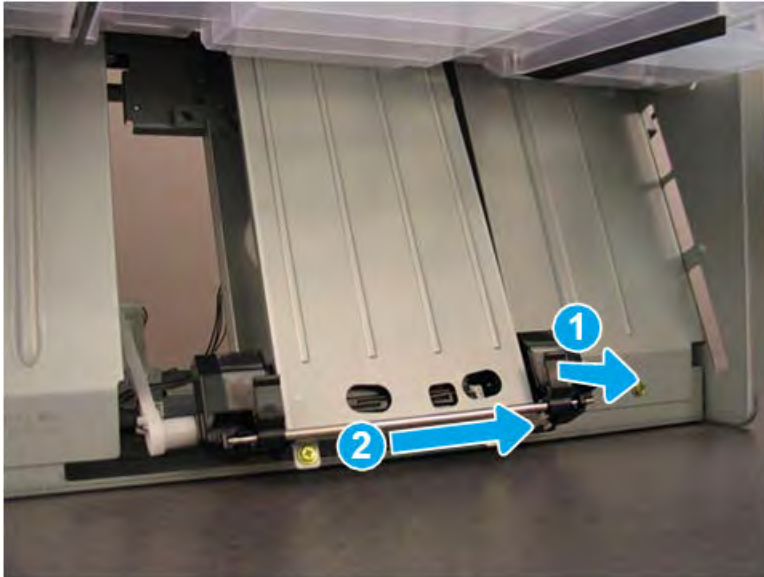
8. On the right side of the booklet maker, remove one screw (callout 1).

Figure 5-1508 Remove one screw



9. Lift the right lower corner (callout 1) to clear the cable guide, and then slide the assembly to the right (callout 2) to remove it.

**Figure 5-1509** Remove the fold stopper unit



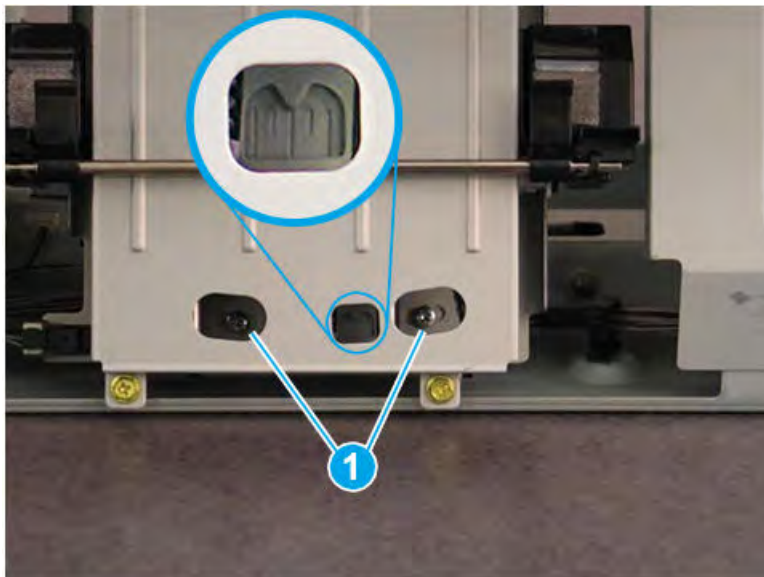
10. Reverse the removal steps to install the assembly. Also use the following special installation instructions.

 **NOTE:** Continue to reverse the removal steps to finish installing the assembly.

#### Special installation instructions: Fold stopper unit

Loosen the two alignment screws (callout 1) and move the fold unit side to side until the alignment gauge is positioned on the center line. Tighten the screws and run a folded job through the finisher and verify that the fold is correct. If the fold is not correct, loosen the screws, adjust the alignment, and run another fold job. Continue this process until the fold is correct.

**Figure 5-1510** Adjust the alignment gauge





## Unpack the replacement assembly

Follow these steps to unpack the replacement assembly.

1. Dispose of the defective part.




**NOTE:** HP recommends responsible disposal of the defective part.

<http://www8.hp.com/us/en/hp-information/environment/product-recycling.html>

---

2. Unpack the replacement part from the packaging.



**CAUTION:**  Some parts are sensitive to electrostatic discharge (ESD). Always perform service work at an ESD-protected workstation or mat. If an ESD workstation or mat is not available, touch the sheet-metal chassis to provide a static ground before touching an ESD-sensitive assembly. Protect the ESD-sensitive assemblies by placing them in ESD pouches when they are out of the printer.



**IMPORTANT:** Make sure that all of the shipping materials (for example shipping tape) are removed from the replacement part prior to installation.



**NOTE:** If the replacement part is a roller or pad, avoid touching the spongy part of it. Skin oils on the roller or pad can cause paper pickup and/or print-quality problems. HP recommends using disposable gloves when handling rollers or pads or washing your hands before touching rollers or pads.

---

3. To install an assembly, reverse the removal steps.



**NOTE:** When applicable, special installation instructions are provided for an assembly at the end of the removal procedure. Always completely read the removal instructions and follow all special installation instructions.


---

## Removal and replacement: End fence motor (M3)


Learn how to remove and replace the booklet end fence motor.

### Introduction

This document provides the procedures to remove and replace the booklet end fence motor on the finisher.

 **IMPORTANT:** When applicable, special installation instructions are provided for an assembly at the end of the removal procedure. Always completely read the removal instructions and follow all special installation instructions.

### Before performing service

- Turn the printer power off. A shutting-down message appears on the control-panel display.
-  **WARNING!** To avoid damage to the printer, turn the power off and wait until the printer shuts down before removing the power cable.
- Disconnect the printer power cable after the printer has completely shut down (the control-panel display is blank).
- Release the finisher from the printer by pulling out on the release latch inside the finisher door.
- Disconnect the cable from the bridge unit to the finisher.
- Disconnect the cable from the finisher to the printer.

Use the table below to identify the correct part number for your printer. To order the part, go to <https://parts.hp.com>.

**Table 5-149** Part information

Part number	Part description
JC93-01155A	Booklet end fence motor

### Required tools

- #2 JIS screwdriver with a magnetic tip

### After performing service

- Connect the cable from the finisher to the printer.
- Connect the cable from the bridge unit to the finisher.
- Attach the finisher to the printer, and then push in on the release latch inside the finisher door.
- Connect the printer power cable.
- Turn the printer power on.


### Post service test

Process a job through the finisher and verify that the finisher works correctly.

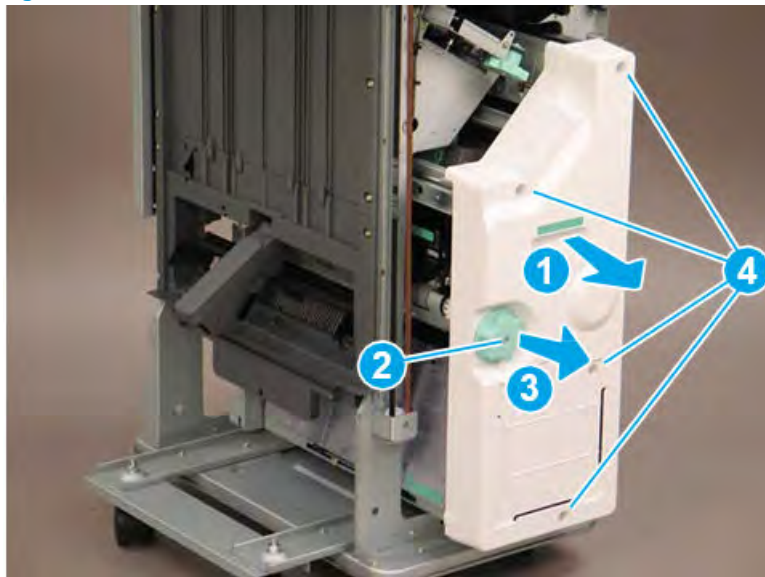
## Remove the booklet front cover

Follow these steps to remove the booklet front cover.

- ▲ Slide the booklet maker slightly away from the finisher (callout 1). Remove one screw (callout 2), and then slide the green knob away from the booklet maker to remove it (callout 3). Remove four screws (callout 4), and then remove the booklet front cover.

 **TIP:** Reverse the removal steps to install the assembly

**Figure 5-1511** Remove five screws and the cover

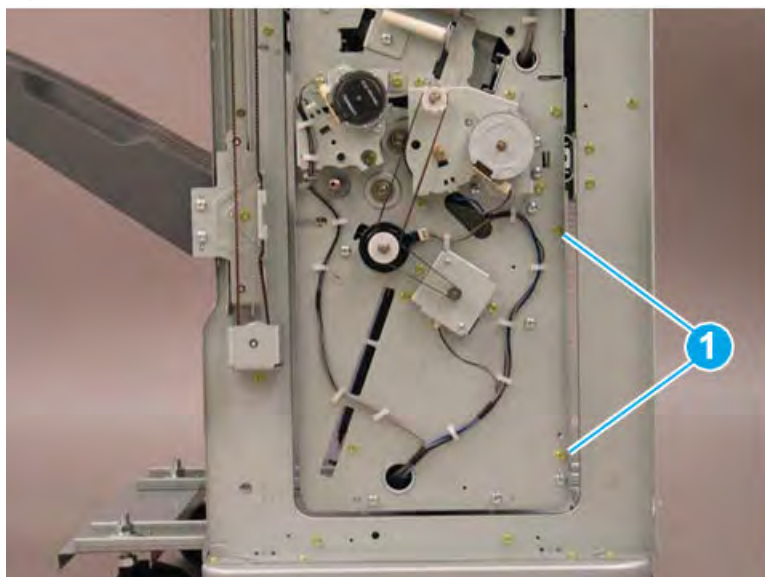


## Remove the booklet right lower shield

Follow these steps to remove the booklet right lower shield.

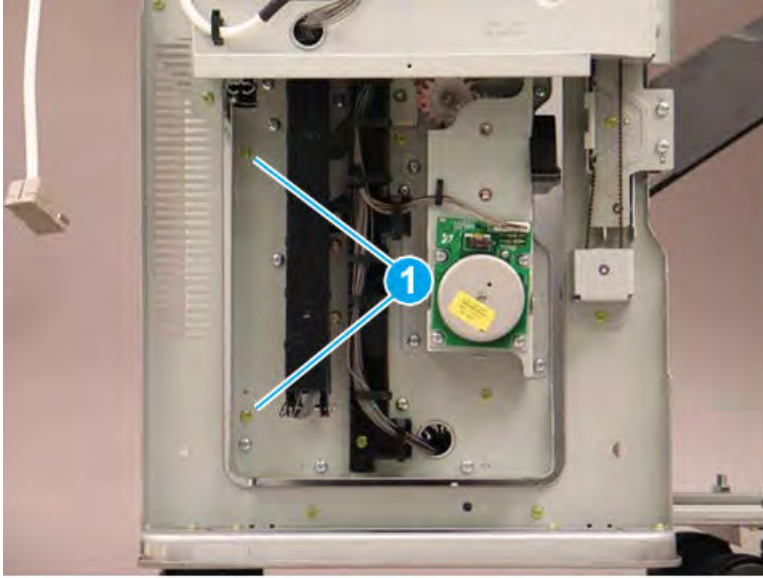
1. Remove two screws at the front of the booklet maker (callout 1).

**Figure 5-1512** Remove two screws



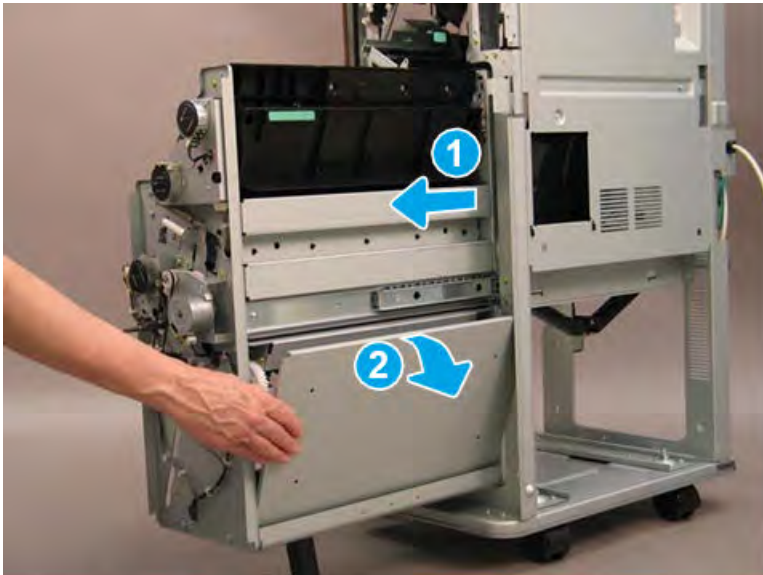
2. Remove two screws at the back of the booklet maker (callout 1).

Figure 5-1513 Remove two screws



3. Slide the booklet maker out of the finisher (callout 1), and then rotate the top of the right lower shield (callout 2) away from the booklet maker to remove it.

Figure 5-1514 Remove the right lower shield



### Remove the booklet end fence motor (M20)

Follow these steps to remove the booklet end fence motor (M20).

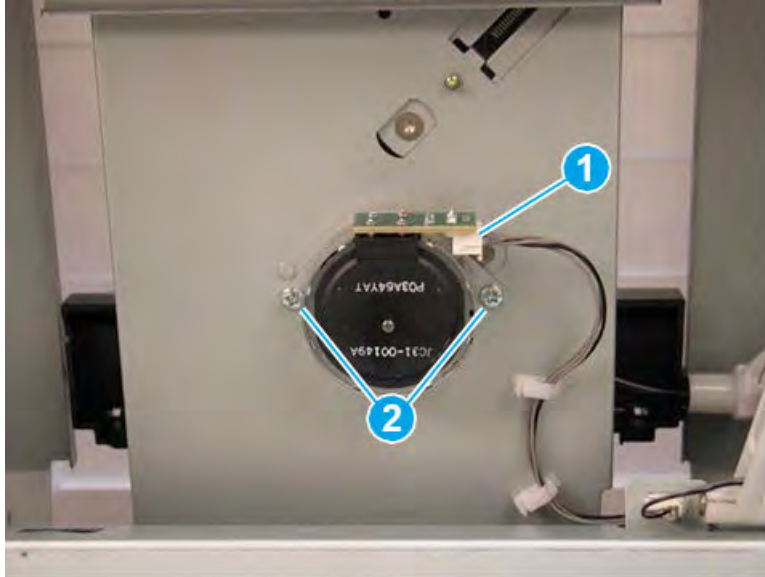
- ▲ Disconnect one connector (callout 1), remove two screws (callout 2), and then remove the booklet end fence motor.

---

 **TIP:** Reverse the removal steps to install the assembly.

---

Figure 5-1515 Remove the booklet end fence motor



### Unpack the replacement assembly



Follow these steps to unpack the replacement assembly.


1. Dispose of the defective part.


 **NOTE:** HP recommends responsible disposal of the defective part.

<http://www8.hp.com/us/en/hp-information/environment/product-recycling.html>


2. Unpack the replacement part from the packaging.

 **CAUTION:**  Some parts are sensitive to electrostatic discharge (ESD). Always perform service work at an ESD-protected workstation or mat. If an ESD workstation or mat is not available, touch the sheet-metal chassis to provide a static ground before touching an ESD-sensitive assembly. Protect the ESD-sensitive assemblies by placing them in ESD pouches when they are out of the printer.

 **IMPORTANT:** Make sure that all of the shipping materials (for example shipping tape) are removed from the replacement part prior to installation.

 **NOTE:** If the replacement part is a roller or pad, avoid touching the spongy part of it. Skin oils on the roller or pad can cause paper pickup and/or print-quality problems. HP recommends using disposable gloves when handling rollers or pads or washing your hands before touching rollers or pads.

3. To install an assembly, reverse the removal steps.


 **NOTE:** When applicable, special installation instructions are provided for an assembly at the end of the removal procedure. Always completely read the removal instructions and follow all special installation instructions.

## Removal and replacement: Booklet end fence home sensor (S42)


Learn how to remove and replace the booklet end fence home sensor.

### Introduction

This document provides the procedures to remove and replace the booklet end fence home sensor on the finisher.

 **IMPORTANT:** When applicable, special installation instructions are provided for an assembly at the end of the removal procedure. Always completely read the removal instructions and follow all special installation instructions.

### Before performing service

- Turn the printer power off. A shutting-down message appears on the control-panel display.
-  **WARNING!** To avoid damage to the printer, turn the power off and wait until the printer shuts down before removing the power cable.
- Disconnect the printer power cable after the printer has completely shut down (the control-panel display is blank).
- Release the finisher from the printer by pulling out on the release latch inside the finisher door.
- Disconnect the cable from the bridge unit to the finisher.
- Disconnect the cable from the finisher to the printer.

Use the table below to identify the correct part number for your printer. To order the part, go to <https://parts.hp.com>.

**Table 5-150 Part information**

Part number	Part description
0604-001393	Booklet end fence home sensor

### Required tools

- #2 JIS screwdriver with a magnetic tip

### After performing service

- Connect the cable from the finisher to the printer.
- Connect the cable from the bridge unit to the finisher.
- Attach the finisher to the printer, and then push in on the release latch inside the finisher door.
- Connect the printer power cable.
- Turn the printer power on.


### Post service test

Process a job through the finisher and verify that the finisher works correctly.

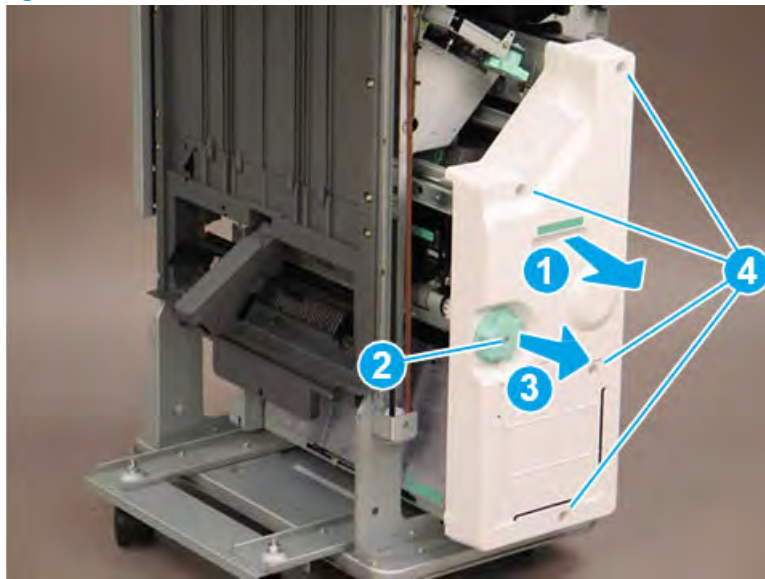
## Remove the booklet front cover

Follow these steps to remove the booklet front cover.

- ▲ Slide the booklet maker slightly away from the finisher (callout 1). Remove one screw (callout 2), and then slide the green knob away from the booklet maker to remove it (callout 3). Remove four screws (callout 4), and then remove the booklet front cover.

 **TIP:** Reverse the removal steps to install the assembly

**Figure 5-1516** Remove five screws and the cover

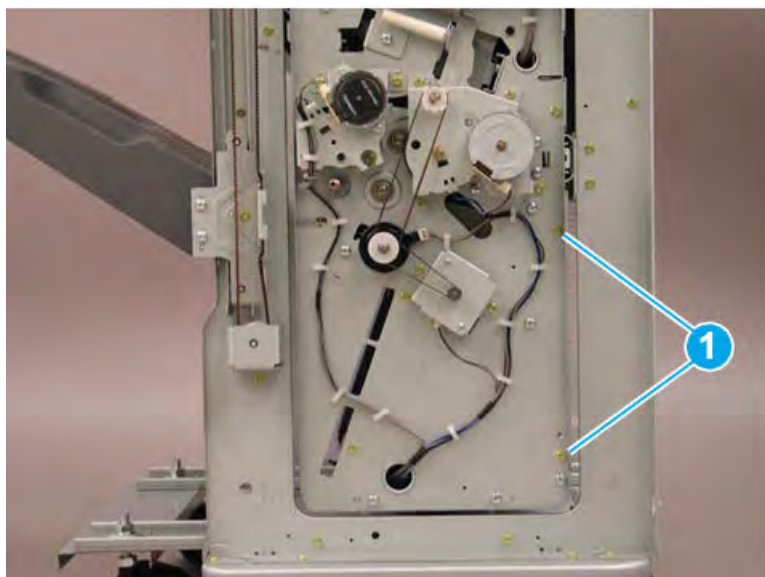


## Remove the booklet right lower shield

Follow these steps to remove the booklet right lower shield.

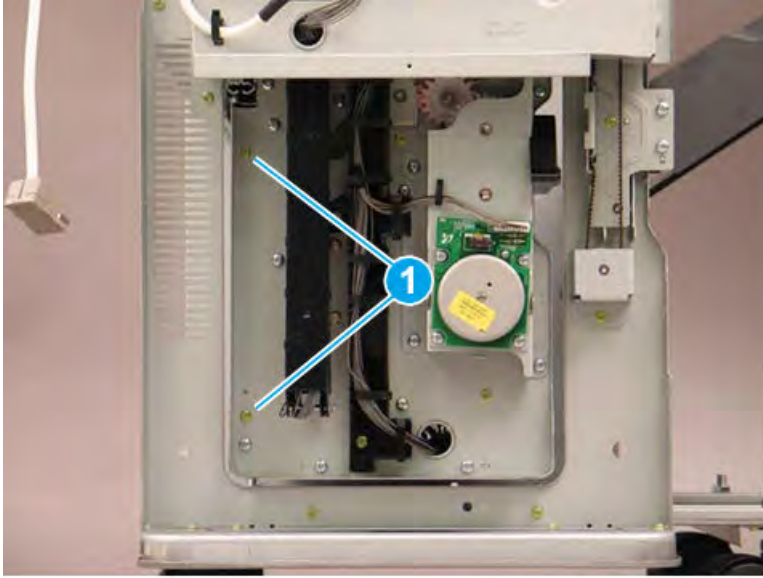
1. Remove two screws at the front of the booklet maker (callout 1).

**Figure 5-1517** Remove two screws



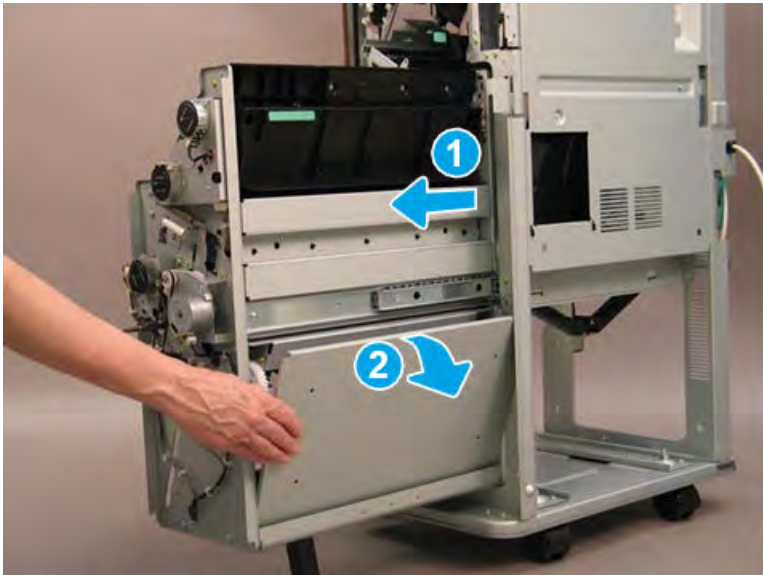
2. Remove two screws at the back of the booklet maker (callout 1).

Figure 5-1518 Remove two screws



3. Slide the booklet maker out of the finisher (callout 1), and then rotate the top of the right lower shield (callout 2) away from the booklet maker to remove it.

Figure 5-1519 Remove the right lower shield



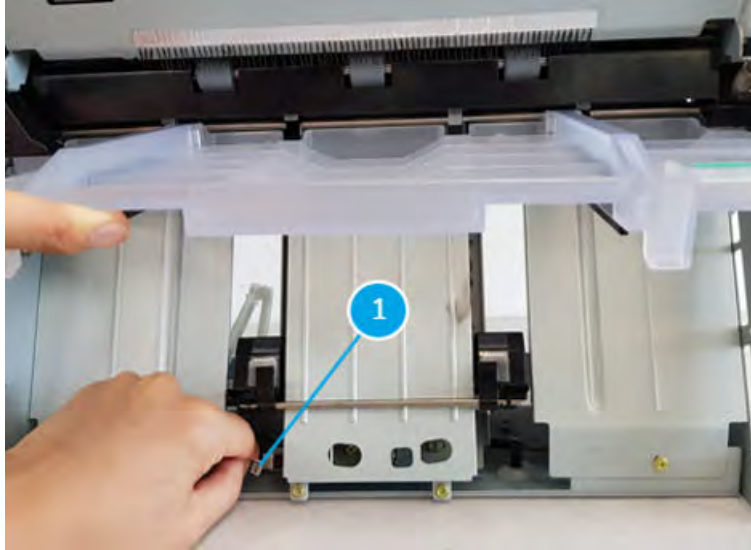
#### Remove the Booklet end fence home sensor (S42)

Follow these steps to remove the Booklet end fence home sensor (S42).

1. Unplug one connector (callout 1) at the left of the booklet maker



Figure 5-1520 Unplug one connector



2. Remove the Booklet end fence home sensor (S42, callout 1) at the right of the booklet maker.

Figure 5-1521 Remove the Booklet end fence home sensor



### Unpack the replacement assembly

Follow these steps to unpack the replacement assembly.

1. Dispose of the defective part.

---

 **NOTE:** HP recommends responsible disposal of the defective part.

<http://www8.hp.com/us/en/hp-information/environment/product-recycling.html>

---

2. Unpack the replacement part from the packaging.


 **CAUTION:**  Some parts are sensitive to electrostatic discharge (ESD). Always perform service work at an ESD-protected workstation or mat. If an ESD workstation or mat is not available, touch the sheet-metal chassis to provide a static ground before touching an ESD-sensitive assembly. Protect the ESD-sensitive assemblies by placing them in ESD pouches when they are out of the printer.

 **IMPORTANT:** Make sure that all of the shipping materials (for example shipping tape) are removed from the replacement part prior to installation.

 **NOTE:** If the replacement part is a roller or pad, avoid touching the spongy part of it. Skin oils on the roller or pad can cause paper pickup and/or print-quality problems. HP recommends using disposable gloves when handling rollers or pads or washing your hands before touching rollers or pads.

---

3. To install an assembly, reverse the removal steps.

 **NOTE:** When applicable, special installation instructions are provided for an assembly at the end of the removal procedure. Always completely read the removal instructions and follow all special installation instructions.

---


## Booklet presser unit

## Removal and replacement: Booklet presser

Learn how to remove and replace the booklet presser.

### Introduction

This document provides the procedures to remove and replace the booklet presser on the finisher.

 **IMPORTANT:** When applicable, special installation instructions are provided for an assembly at the end of the removal procedure. Always completely read the removal instructions and follow all special installation instructions.

### Before performing service

- Turn the printer power off. A shutting-down message appears on the control-panel display.
- ⚠ **WARNING!** To avoid damage to the printer, turn the power off and wait until the printer shuts down before removing the power cable.
- Disconnect the printer power cable after the printer has completely shut down (the control-panel display is blank).
- Release the finisher from the printer by pulling out on the release latch inside the finisher door.
- Disconnect the cable from the bridge unit to the finisher.
- Disconnect the cable from the finisher to the printer.

Use the table below to identify the correct part number for your printer. To order the part, go to <https://parts.hp.com>.

**Table 5-151 Part information**

Part number	Part description
JC61-07237A	Booklet presser

### Required tools

- #2 JIS screwdriver with a magnetic tip

### After performing service

- Connect the cable from the finisher to the printer.
- Connect the cable from the bridge unit to the finisher.
- Attach the finisher to the printer, and then push in on the release latch inside the finisher door.
- Connect the printer power cable.
- Turn the printer power on.

### Post service test

Process a job through the finisher and verify that the finisher works correctly.

### Remove the right upper cover (finisher)

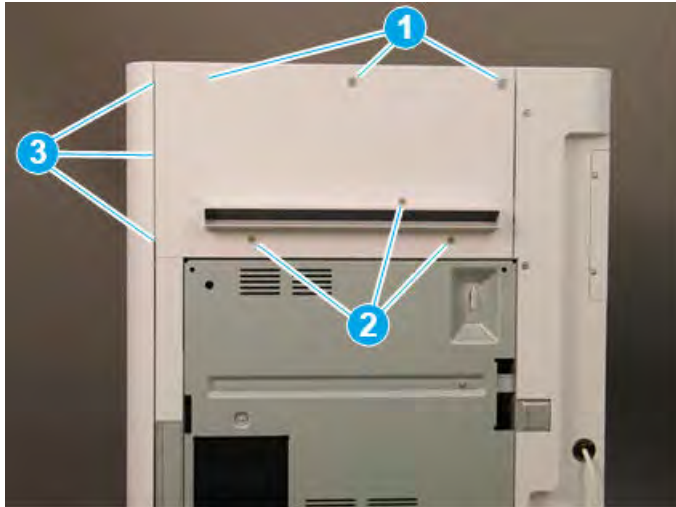
Follow these steps to remove the right upper cover (finisher).

- ▲ Remove one screw cap and three machine screws on the upper edge of the cover (callout 1). Remove three sheet metal screws (callout 2) on the lower portion of the cover. Rotate the right edge of the cover away from the finisher, and then slide the cover right to release three tabs (callout 3).

💡 **TIP:** The lower screws are shorter in length than the upper screws.

**TIP:** Reverse the removal steps to install the assembly.

Figure 5-1522 Remove the right upper cover

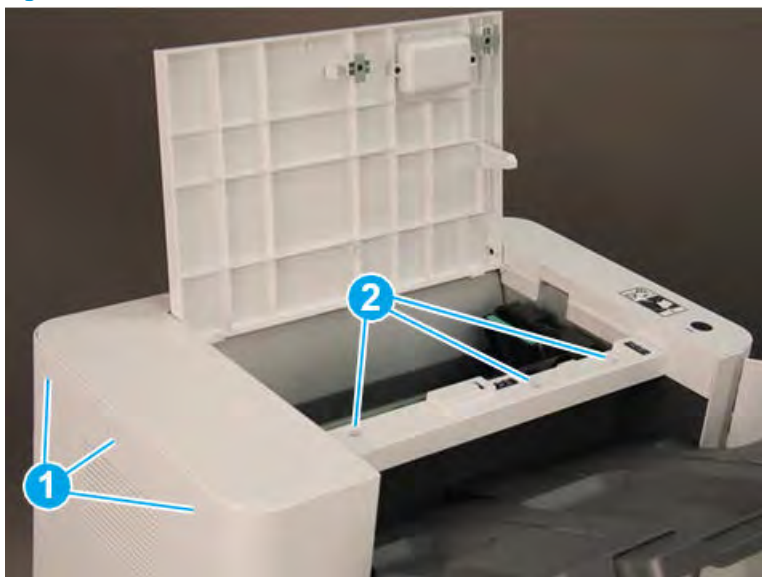


### Remove the top cover (finisher)

Follow these steps to remove the top cover (finisher).

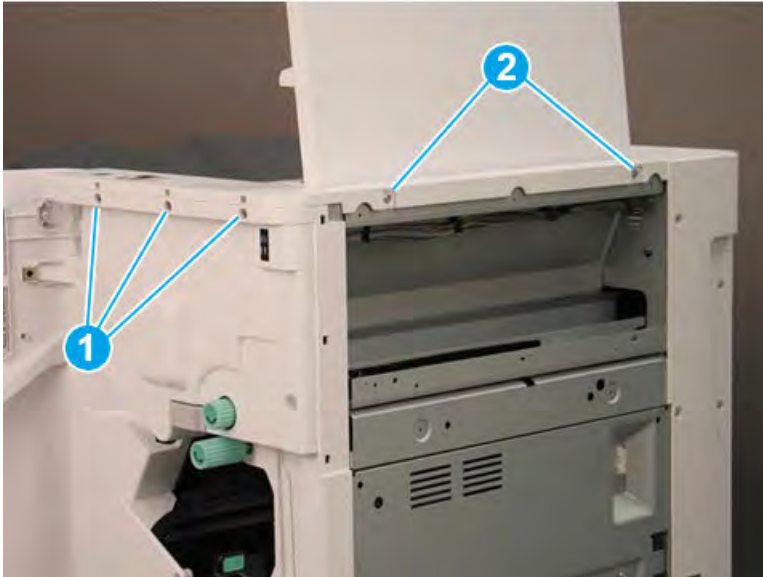
1. Remove three screw caps and three self-tapping screws at the top of the rear cover (callout 1), and then remove three machine screws (callout 2) on top of the cover.

Figure 5-1523 Remove six screws




2. Remove three self-tapping screws at the top of the front cover (callout 1), and then remove two machine screws (callout 2) at the top of the right side.

Figure 5-1524 Remove five screws



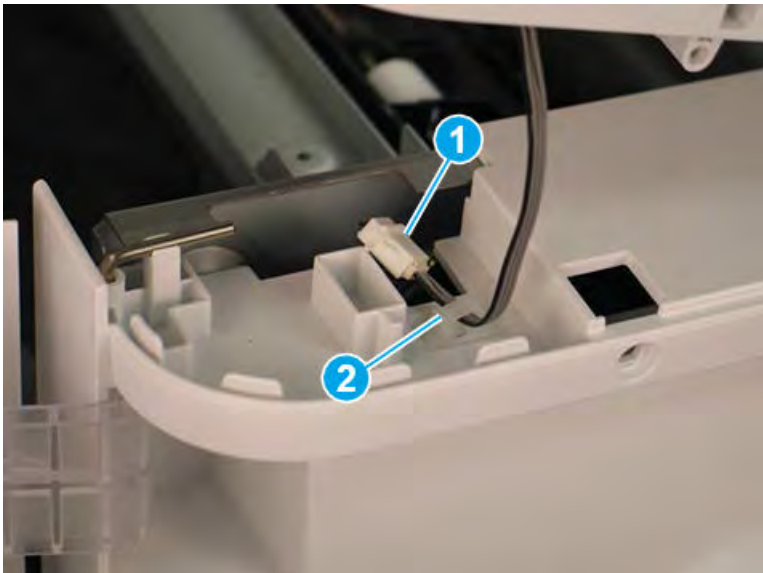
3. Lift the cover up slightly. Disconnect one in-line connector (callout 1), and then release one retainer (callout 2).

---

 **TIP:** Reverse the removal steps to install the assembly.

---

Figure 5-1525 Disconnect one connector and release retainer

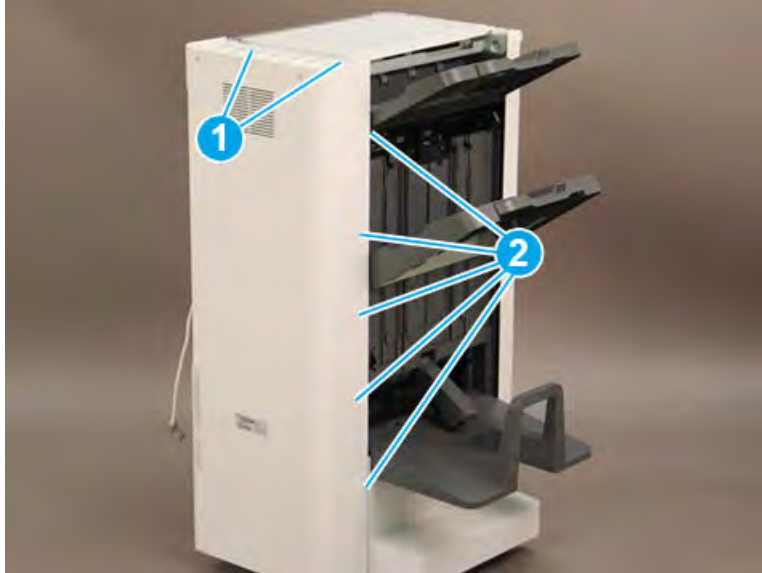


### Remove the rear cover (finisher)

Follow these steps to remove the rear cover (finisher).

1. Remove two self-tapping screws (callout 1) on the top of the rear cover, and then remove five screw caps and five machine screws (callout 2) on the left side of the cover.

Figure 5-1526 Remove seven screws




2. Remove one screw cap and four machine screws (callout 1) Remove the rear cover.

---

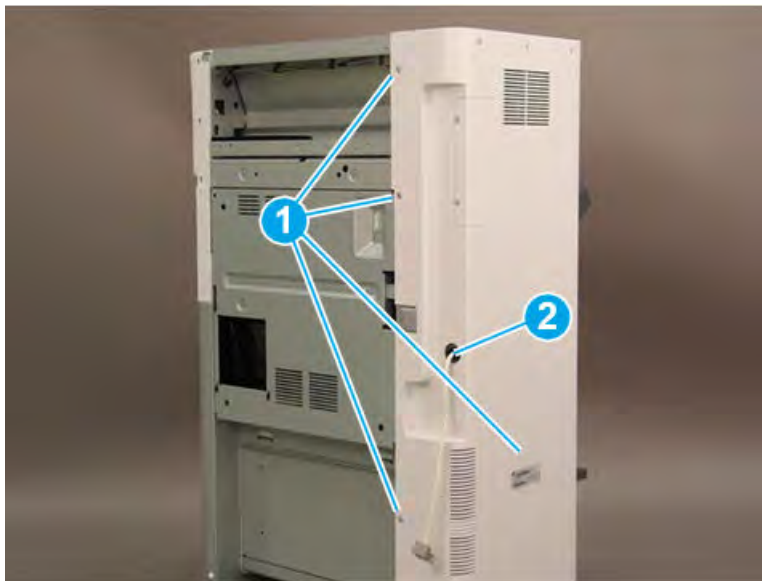
 **NOTE:** Make sure to thread the power cable (callout 2) through the opening in the cover.

---

 **TIP:** Reverse the removal steps to install the assembly

---

Figure 5-1527 Remove the rear cover



### Remove the booklet maker

Follow these steps to remove the booklet maker.

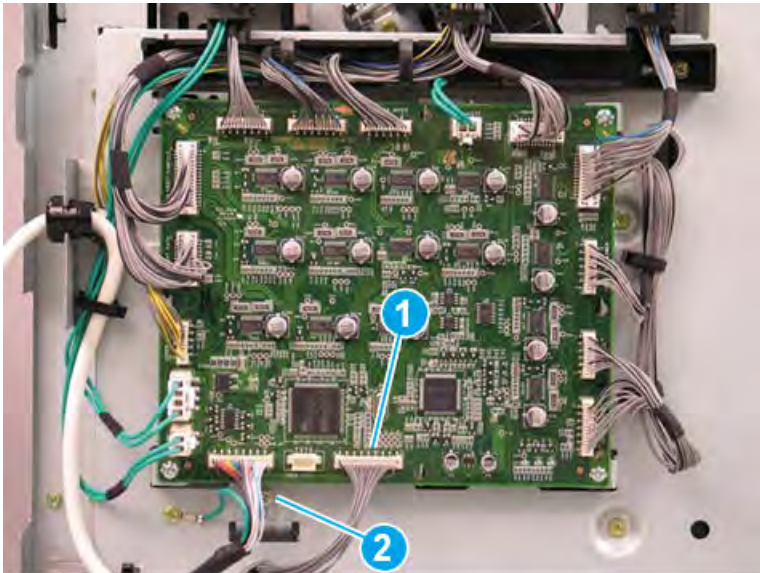
1. Slide the booklet maker away from the finisher.

Figure 5-1528 Slide the booklet maker away from the finisher



2. At the Disconnect one connector (callout 1), and then remove one screw (callout 2).

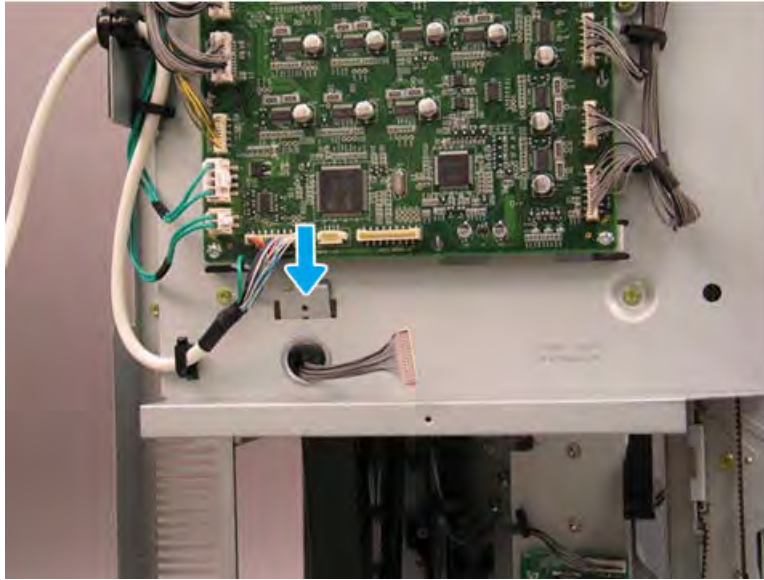
Figure 5-1529 Disconnect one connector and remove one screw





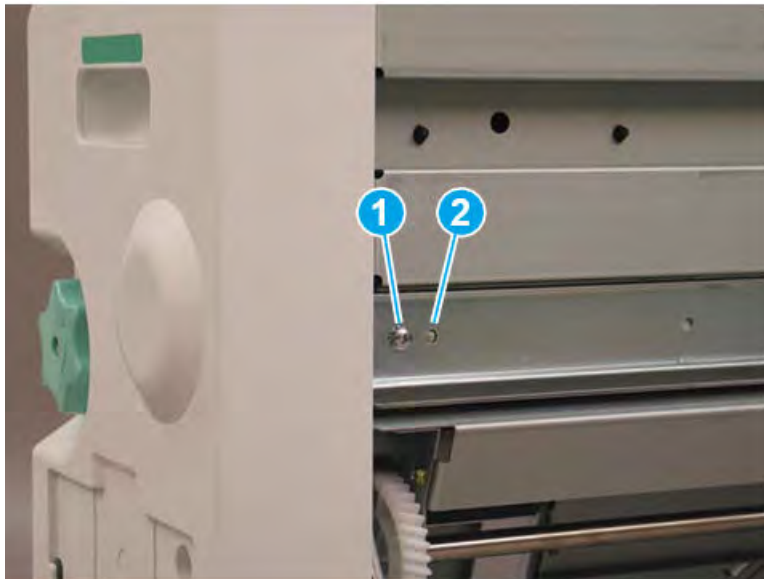
3. Release the metal bracket through the opening in the sheet metal.

Figure 5-1530 Release the metal bracket



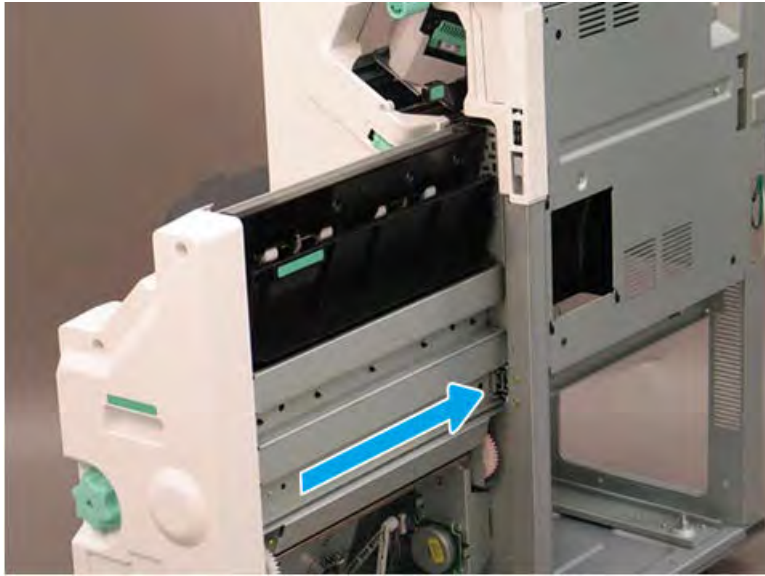
4. Remove one star-washer screw (callout 1), and then release the alignment pin (callout 2) on the right side of the booklet maker.

Figure 5-1531 Remove one screw



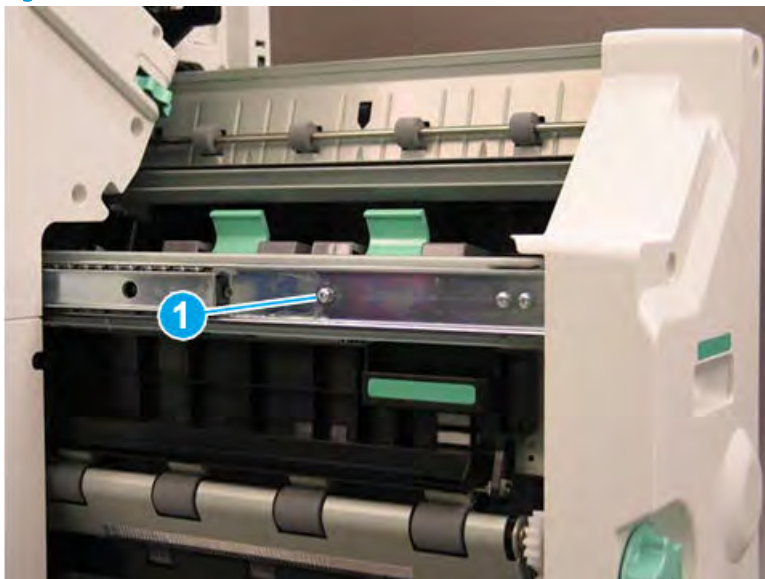
5. Slide the right rail toward the finisher.

Figure 5-1532 Slide the right rail



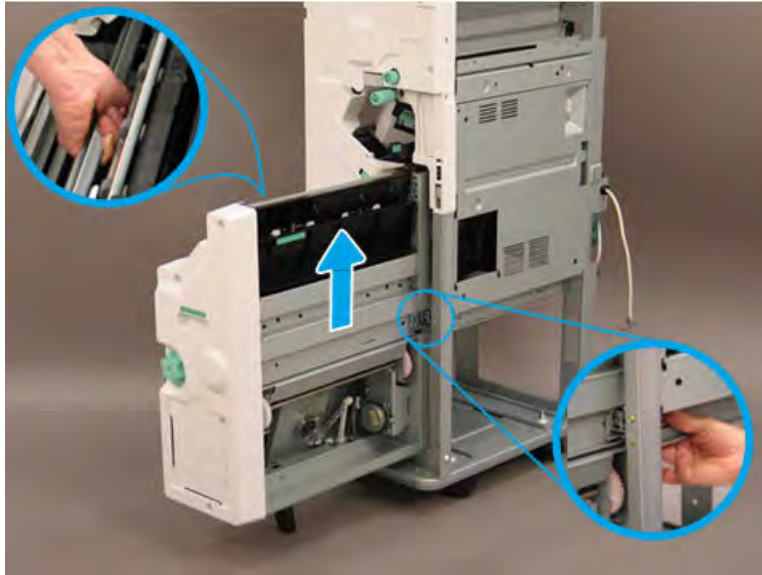
6. Remove one star-washer screw (callout 1) on the left side of the booklet maker.

Figure 5-1533 Remove one screw



7. Lift the booklet maker up on the left side while squeezing the right rail away from the finisher slightly to clear the sheet metal. Remove the booklet maker.

**Figure 5-1534** Remove the booklet maker



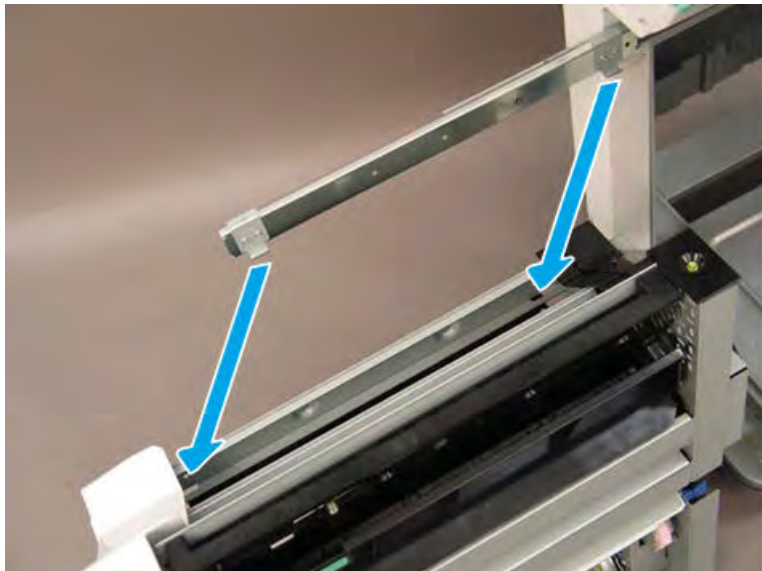
8. Reverse the removal steps to install the assembly. Also use the following special installation instructions.

 **NOTE:** Continue to reverse the removal steps to finish installing the assembly.

**Special installation instructions: booklet maker**

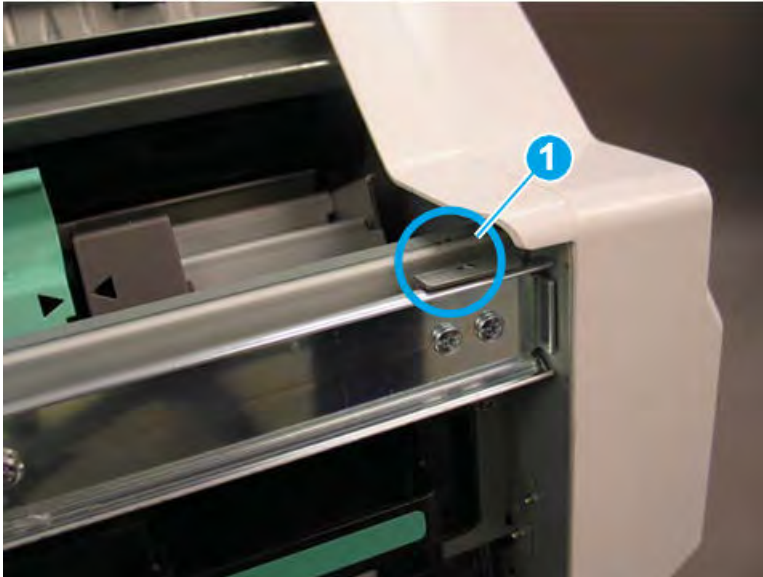
When installing the booklet maker, position the hooks on the rail under the slots on the booklet maker.

**Figure 5-1535** Position the hooks



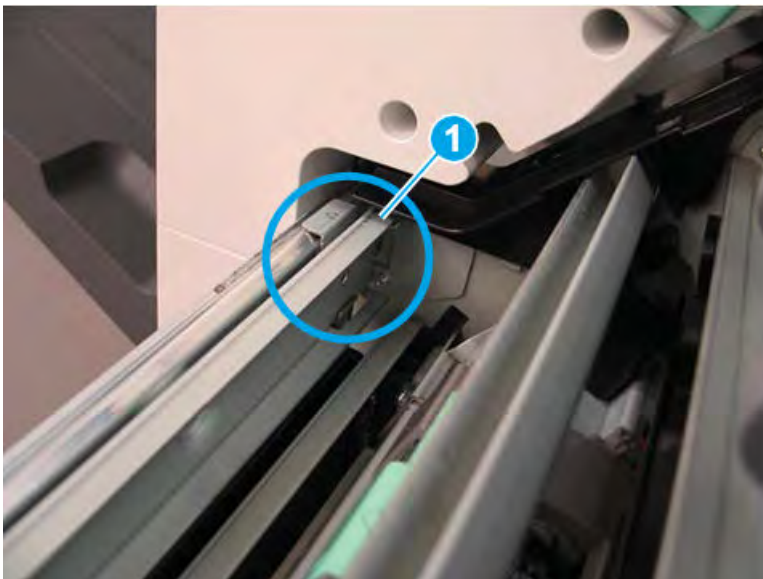
9. When installed correctly, the arrow on the front of the booklet maker aligns with the arrow on the finisher rail.

Figure 5-1536 Align arrows



10. When installed correctly, the arrow on the back of the booklet maker aligns with the arrow on the finisher rail.

Figure 5-1537 Align arrows



11. Extend the right rail away from the finisher and position it in the booklet maker slot.

Figure 5-1538 Extend the right rail

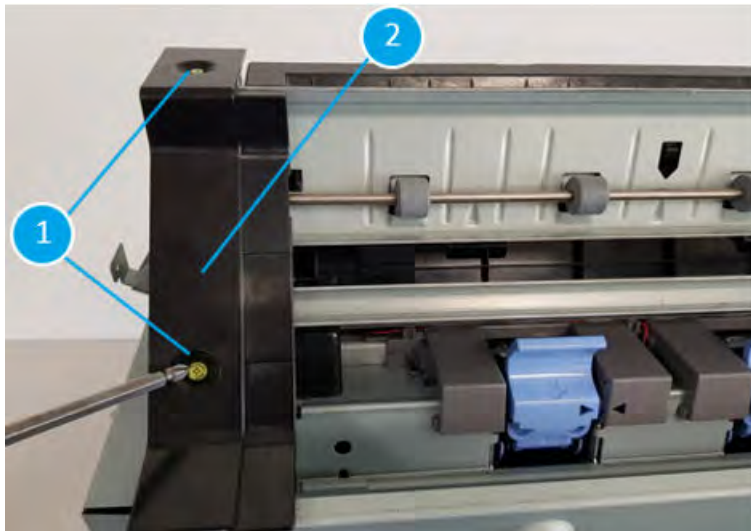


#### Remove the booklet entrance unit

Follow these steps to remove the booklet entrance unit.

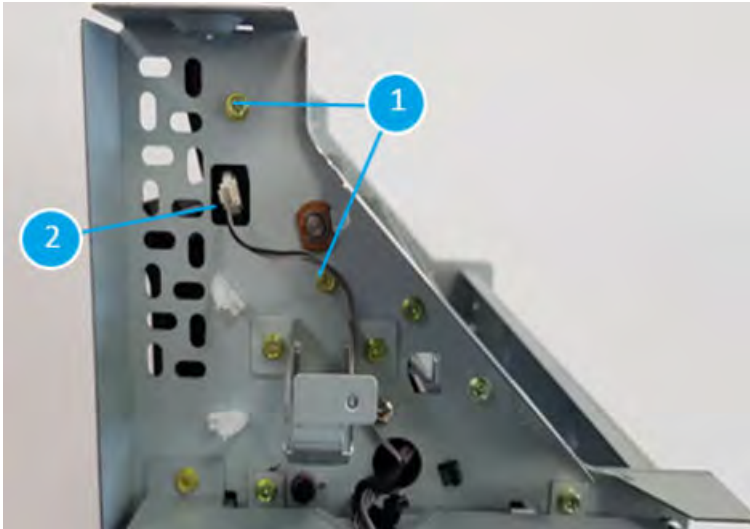
1. Remove two screws (callout 1) then remove the black cover (callout 2)

Figure 5-1539 Remove two screws then remove the black cover



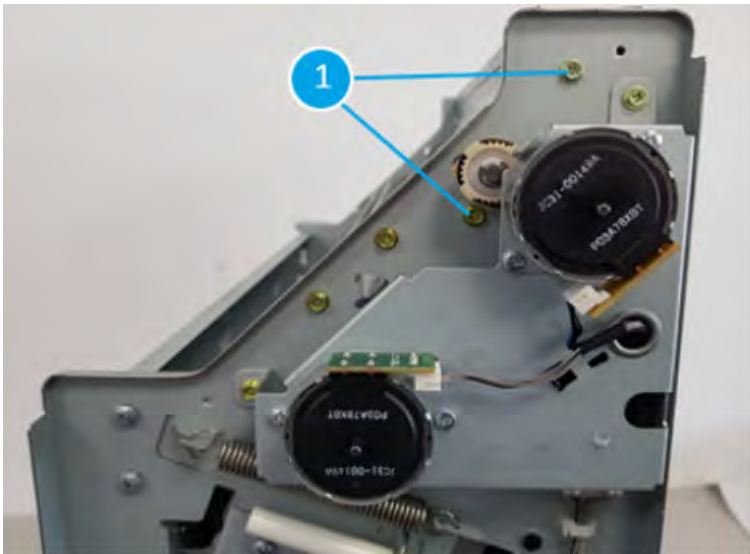
2. Remove two screws(callout 1) and disconnect one connector(callout 2)

Figure 5-1540 Remove two screws and disconnect one connector



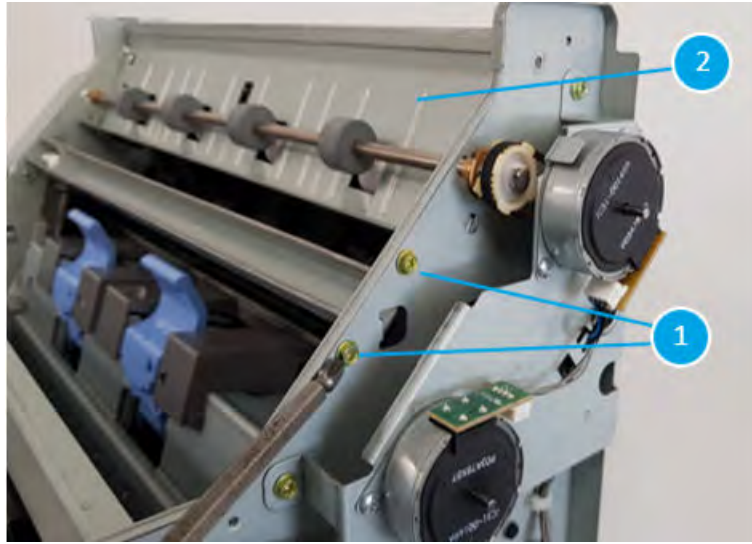
3. Remove two screws(callout 1)

Figure 5-1541 Remove two screws



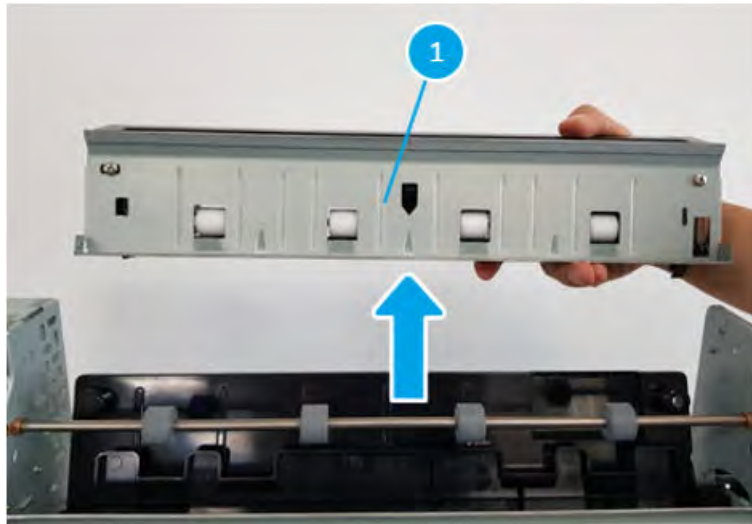
4. Remove two screws(callout 1) to make it easy to pull off the booklet entrance unit (callout2)

Figure 5-1542 Remove two screws to make it easy to pull off the booklet entrance unit



5. Remove the booklet entrance unit (callout 1)

Figure 5-1543 Remove the booklet entrance unit



### Remove the booklet presser

Follow these steps to remove the booklet presser.

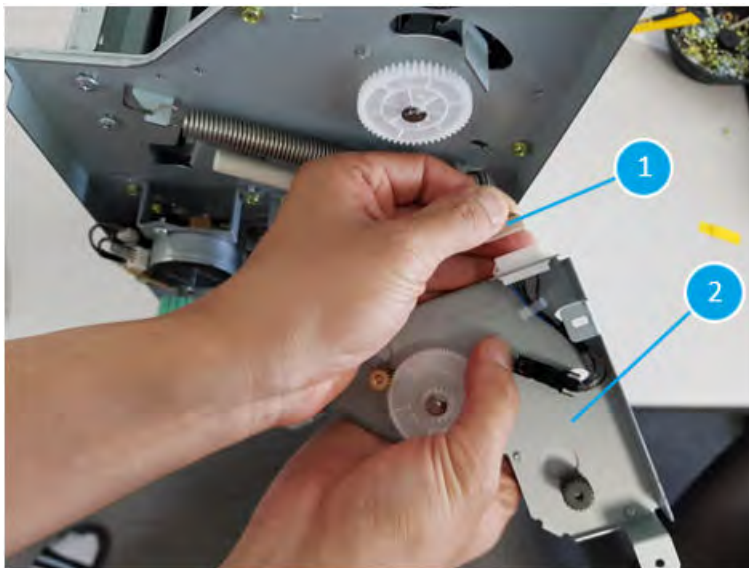
1. Remove three screws (callout 1)

Figure 5-1544 Remove three screws



2. Disconnect one connector (callout 1) and remove the motor unit (callout 2)

Figure 5-1545 Disconnect one connector and remove the motor unit





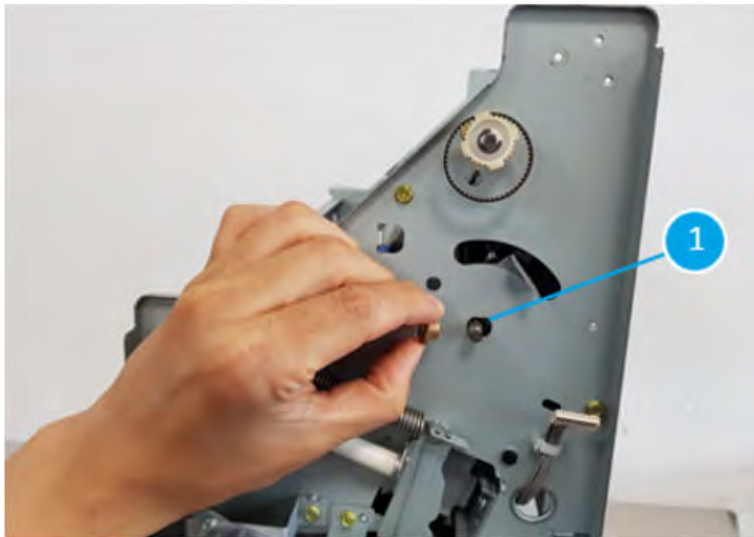
3. Remove one e-clip on top of the white gear then remove the white gear (callout 1)

Figure 5-1546 Remove one e-clip on top of the white gear then remove the white gear



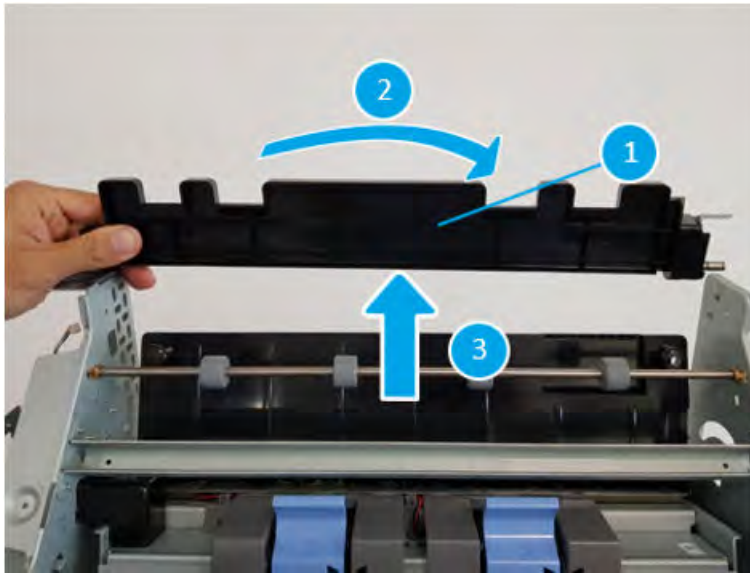
4. Remove one e-clip on top of the bush then remove the bush (callout 1)

Figure 5-1547 Remove one e-clip on top of the bush then remove the bush



5. Band (callout 2) the booklet presser (callout 1) out to make it easy to pull out (callout 3)

Figure 5-1548 Band the booklet presser out to make it easy to pull out



### Unpack the replacement assembly

Follow these steps to unpack the replacement assembly.

1. Dispose of the defective part.




**NOTE:** HP recommends responsible disposal of the defective part.

<http://www8.hp.com/us/en/hp-information/environment/product-recycling.html>

2. Unpack the replacement part from the packaging.



**CAUTION:**  Some parts are sensitive to electrostatic discharge (ESD). Always perform service work at an ESD-protected workstation or mat. If an ESD workstation or mat is not available, touch the sheet-metal chassis to provide a static ground before touching an ESD-sensitive assembly. Protect the ESD-sensitive assemblies by placing them in ESD pouches when they are out of the printer.



**IMPORTANT:** Make sure that all of the shipping materials (for example shipping tape) are removed from the replacement part prior to installation.



**NOTE:** If the replacement part is a roller or pad, avoid touching the spongy part of it. Skin oils on the roller or pad can cause paper pickup and/or print-quality problems. HP recommends using disposable gloves when handling rollers or pads or washing your hands before touching rollers or pads.

3. To install an assembly, reverse the removal steps.



**NOTE:** When applicable, special installation instructions are provided for an assembly at the end of the removal procedure. Always completely read the removal instructions and follow all special installation instructions.

## Removal and replacement: Booklet presser home sensor (S37)

Learn how to remove and replace the booklet presser home sensor.

### Introduction

This document provides the procedures to remove and replace the booklet presser home sensor on the finisher.



**IMPORTANT:** When applicable, special installation instructions are provided for an assembly at the end of the removal procedure. Always completely read the removal instructions and follow all special installation instructions.

### Before performing service

- Turn the printer power off. A shutting-down message appears on the control-panel display.
- ⚠ **WARNING!** To avoid damage to the printer, turn the power off and wait until the printer shuts down before removing the power cable.
- Disconnect the printer power cable after the printer has completely shut down (the control-panel display is blank).
- Release the finisher from the printer by pulling out on the release latch inside the finisher door.
- Disconnect the cable from the bridge unit to the finisher.
- Disconnect the cable from the finisher to the printer.

Use the table below to identify the correct part number for your printer. To order the part, go to <https://parts.hp.com>.

**Table 5-152** Part information

Part number	Part description
0604-001393	Booklet presser home sensor

### Required tools

- #2 JIS screwdriver with a magnetic tip

### After performing service

- Connect the cable from the finisher to the printer.
- Connect the cable from the bridge unit to the finisher.
- Attach the finisher to the printer, and then push in on the release latch inside the finisher door.
- Connect the printer power cable.
- Turn the printer power on.


### Post service test

Process a job through the finisher and verify that the finisher works correctly.

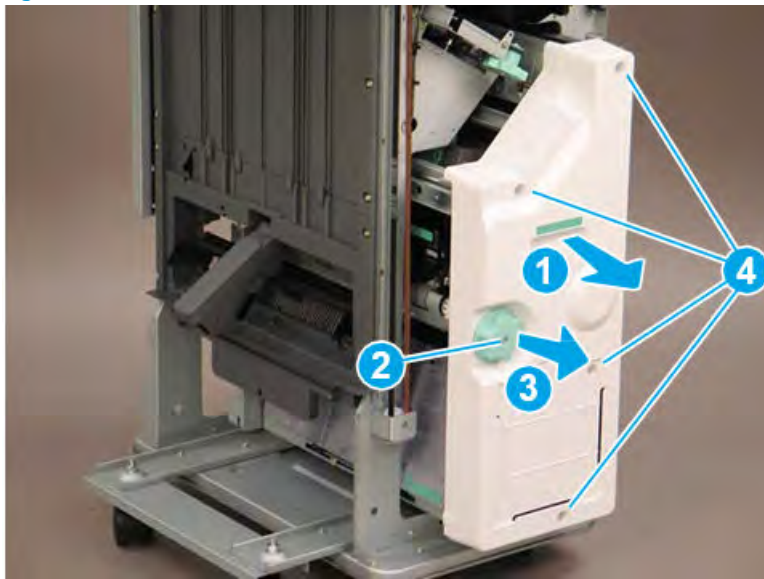
## Remove the booklet front cover

Follow these steps to remove the booklet front cover.

- ▲ Slide the booklet maker slightly away from the finisher (callout 1). Remove one screw (callout 2), and then slide the green knob away from the booklet maker to remove it (callout 3). Remove four screws (callout 4), and then remove the booklet front cover.

 **TIP:** Reverse the removal steps to install the assembly

**Figure 5-1549** Remove five screws and the cover



## Remove the booklet presser home sensor (S37)

Follow these steps to remove the booklet presser home sensor (S37).

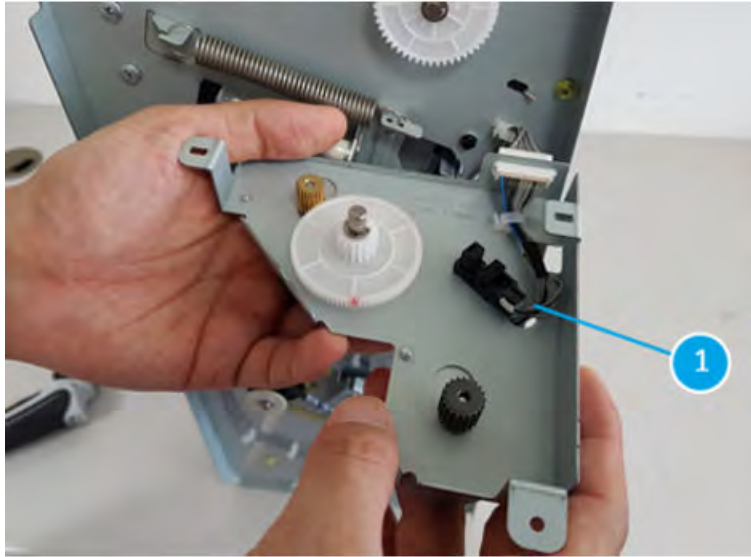
1. Remove three screws (callout 1)

**Figure 5-1550** Remove three screws



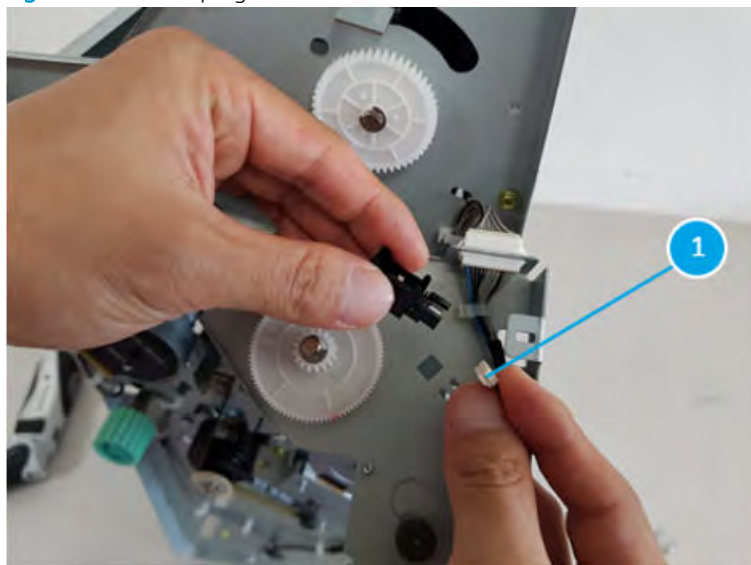
2. Use a tweezer to remove booklet presser home sensor (S37, callout 1)

Figure 5-1551 Remove booklet presser home sensor



3. Unplug one connector (callout 1)

Figure 5-1552 Unplug one connector



### Unpack the replacement assembly

Follow these steps to unpack the replacement assembly.

1. Dispose of the defective part.



---


 **NOTE:** HP recommends responsible disposal of the defective part.


<http://www8.hp.com/us/en/hp-information/environment/product-recycling.html>

---

2. Unpack the replacement part from the packaging.


 **CAUTION:**  Some parts are sensitive to electrostatic discharge (ESD). Always perform service work at an ESD-protected workstation or mat. If an ESD workstation or mat is not available, touch the sheet-metal chassis to provide a static ground before touching an ESD-sensitive assembly. Protect the ESD-sensitive assemblies by placing them in ESD pouches when they are out of the printer.

 **IMPORTANT:** Make sure that all of the shipping materials (for example shipping tape) are removed from the replacement part prior to installation.

 **NOTE:** If the replacement part is a roller or pad, avoid touching the spongy part of it. Skin oils on the roller or pad can cause paper pickup and/or print-quality problems. HP recommends using disposable gloves when handling rollers or pads or washing your hands before touching rollers or pads.

---

3. To install an assembly, reverse the removal steps.

 **NOTE:** When applicable, special installation instructions are provided for an assembly at the end of the removal procedure. Always completely read the removal instructions and follow all special installation instructions.

---

## Removal and replacement: Booklet presser motor (M16)

Learn how to remove and replace the booklet presser motor.

### Introduction

This document provides the procedures to remove and replace the booklet presser motor on the finisher.



**IMPORTANT:** When applicable, special installation instructions are provided for an assembly at the end of the removal procedure. Always completely read the removal instructions and follow all special installation instructions.

### Before performing service

- Turn the printer power off. A shutting-down message appears on the control-panel display.
- ⚠ **WARNING!** To avoid damage to the printer, turn the power off and wait until the printer shuts down before removing the power cable.
- Disconnect the printer power cable after the printer has completely shut down (the control-panel display is blank).
- Release the finisher from the printer by pulling out on the release latch inside the finisher door.
- Disconnect the cable from the bridge unit to the finisher.
- Disconnect the cable from the finisher to the printer.

Use the table below to identify the correct part number for your printer. To order the part, go to <https://parts.hp.com>.

**Table 5-153** Part information

Part number	Part description
JC93-01155A	Booklet presser motor

### Required tools

- #2 JIS screwdriver with a magnetic tip

### After performing service

- Connect the cable from the finisher to the printer.
- Connect the cable from the bridge unit to the finisher.
- Attach the finisher to the printer, and then push in on the release latch inside the finisher door.
- Connect the printer power cable.
- Turn the printer power on.

### Post service test

Process a job through the finisher and verify that the finisher works correctly.

## Remove the booklet front cover

Follow these steps to remove the booklet front cover.

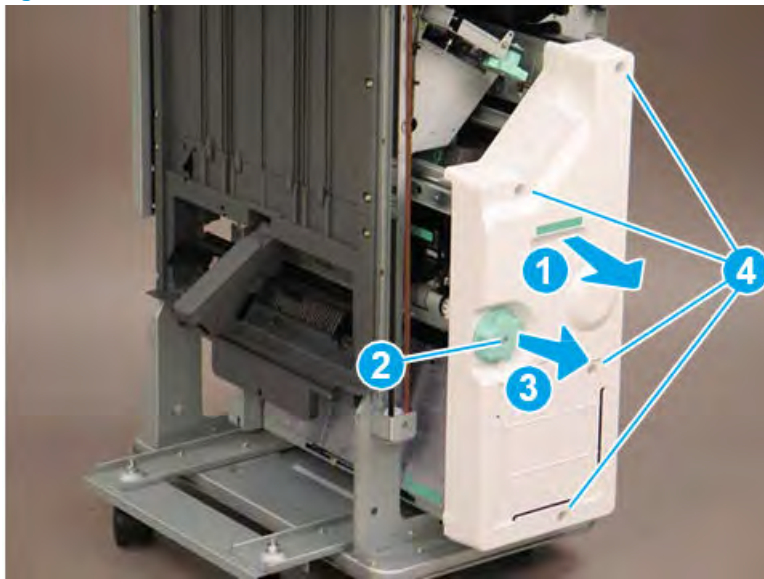
- ▲ Slide the booklet maker slightly away from the finisher (callout 1). Remove one screw (callout 2), and then slide the green knob away from the booklet maker to remove it (callout 3). Remove four screws (callout 4), and then remove the booklet front cover.

---

💡 **TIP:** Reverse the removal steps to install the assembly

---

**Figure 5-1553** Remove five screws and the cover



## Remove the booklet presser motor (M16)

Follow these steps to remove the booklet presser motor (M16).

- ▲ Disconnect one connector (callout 1), remove two screws (callout 2), and then remove the booklet presser motor.

---

💡 **TIP:** Reverse the removal steps to install the assembly.

---



Figure 5-1554 Remove the booklet presser motor



### Unpack the replacement assembly

Follow these steps to unpack the replacement assembly.

1. Dispose of the defective part.




**NOTE:** HP recommends responsible disposal of the defective part.

<http://www8.hp.com/us/en/hp-information/environment/product-recycling.html>

2. Unpack the replacement part from the packaging.



**CAUTION:**  Some parts are sensitive to electrostatic discharge (ESD). Always perform service work at an ESD-protected workstation or mat. If an ESD workstation or mat is not available, touch the sheet-metal chassis to provide a static ground before touching an ESD-sensitive assembly. Protect the ESD-sensitive assemblies by placing them in ESD pouches when they are out of the printer.



**IMPORTANT:** Make sure that all of the shipping materials (for example shipping tape) are removed from the replacement part prior to installation.



**NOTE:** If the replacement part is a roller or pad, avoid touching the spongy part of it. Skin oils on the roller or pad can cause paper pickup and/or print-quality problems. HP recommends using disposable gloves when handling rollers or pads or washing your hands before touching rollers or pads.

3. To install an assembly, reverse the removal steps.



**NOTE:** When applicable, special installation instructions are provided for an assembly at the end of the removal procedure. Always completely read the removal instructions and follow all special installation instructions.


## Booklet tamper unit

## Removal and replacement: Booklet tamper unit

Learn how to remove and replace the tray booklet tamper unit.

### Introduction

This document provides the procedures to remove and replace the booklet tamper unit on the finisher.

 **IMPORTANT:** When applicable, special installation instructions are provided for an assembly at the end of the removal procedure. Always completely read the removal instructions and follow all special installation instructions.

### Before performing service

- Turn the printer power off. A shutting-down message appears on the control-panel display.
- ⚠ **WARNING!** To avoid damage to the printer, turn the power off and wait until the printer shuts down before removing the power cable.
- Disconnect the printer power cable after the printer has completely shut down (the control-panel display is blank).
- Release the finisher from the printer by pulling out on the release latch inside the finisher door.
- Disconnect the cable from the bridge unit to the finisher.
- Disconnect the cable from the finisher to the printer.

Use the table below to identify the correct part number for your printer. To order the part, go to <https://parts.hp.com>.

**Table 5-154 Part information**

Part number	Part description
JC90-01431A	Booklet tamper unit

### Required tools

- #2 JIS screwdriver with a magnetic tip

### After performing service

- Connect the cable from the finisher to the printer.
- Connect the cable from the bridge unit to the finisher.
- Attach the finisher to the printer, and then push in on the release latch inside the finisher door.
- Connect the printer power cable.
- Turn the printer power on.

### Post service test

Process a job through the finisher and verify that the finisher works correctly.

## Remove the right upper cover (finisher)

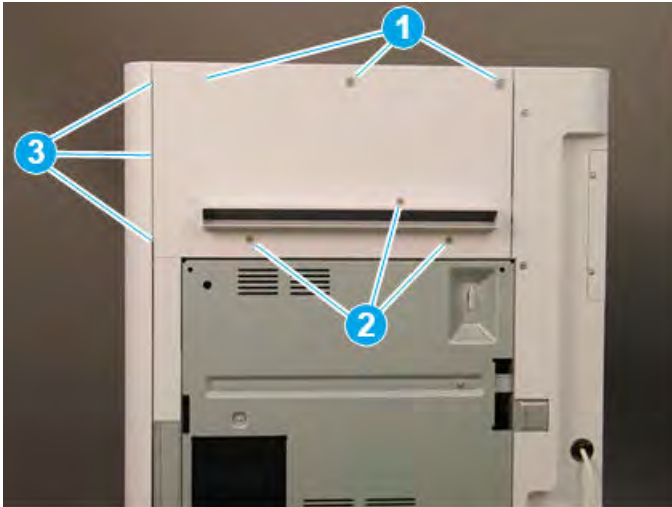
Follow these steps to remove the right upper cover (finisher).

- ▲ Remove one screw cap and three machine screws on the upper edge of the cover (callout 1). Remove three sheet metal screws (callout 2) on the lower portion of the cover. Rotate the right edge of the cover away from the finisher, and then slide the cover right to release three tabs (callout 3).

💡 **TIP:** The lower screws are shorter in length than the upper screws.

**TIP:** Reverse the removal steps to install the assembly.

**Figure 5-1555** Remove the right upper cover

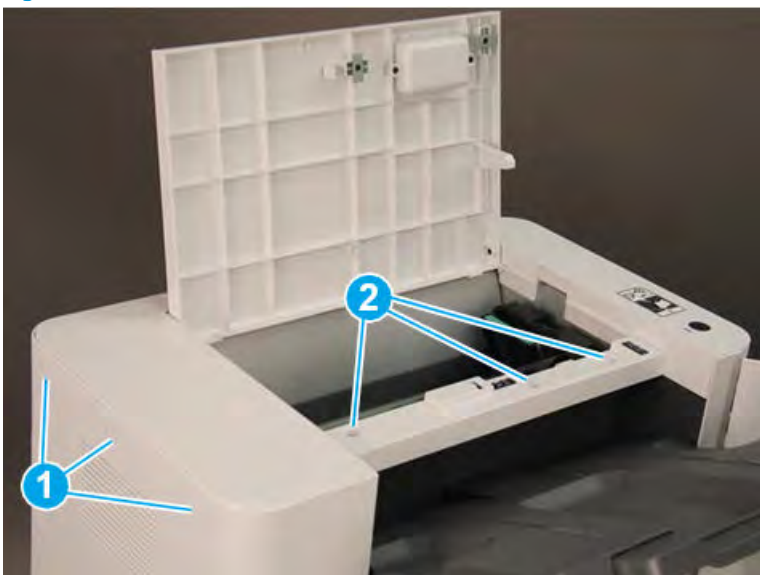


## Remove the top cover (finisher)

Follow these steps to remove the top cover (finisher).

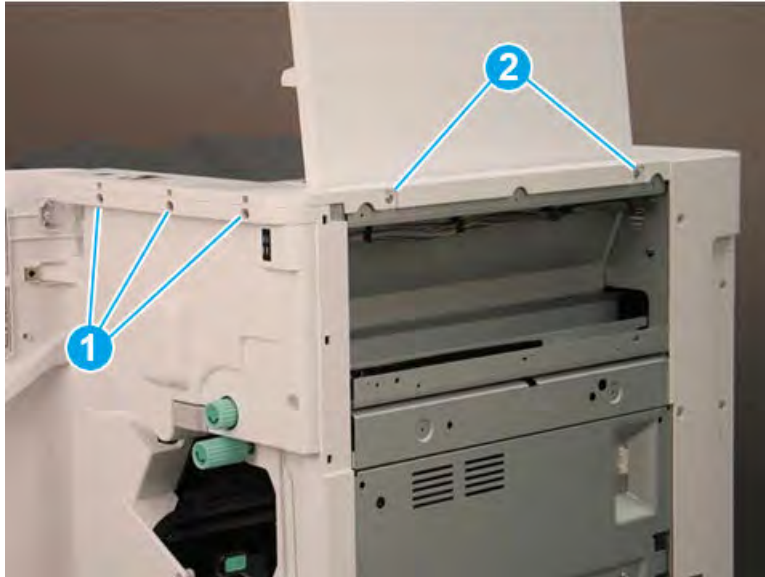
1. Remove three screw caps and three self-tapping screws at the top of the rear cover (callout 1), and then remove three machine screws (callout 2) on top of the cover.

**Figure 5-1556** Remove six screws




2. Remove three self-tapping screws at the top of the front cover (callout 1), and then remove two machine screws (callout 2) at the top of the right side.

Figure 5-1557 Remove five screws



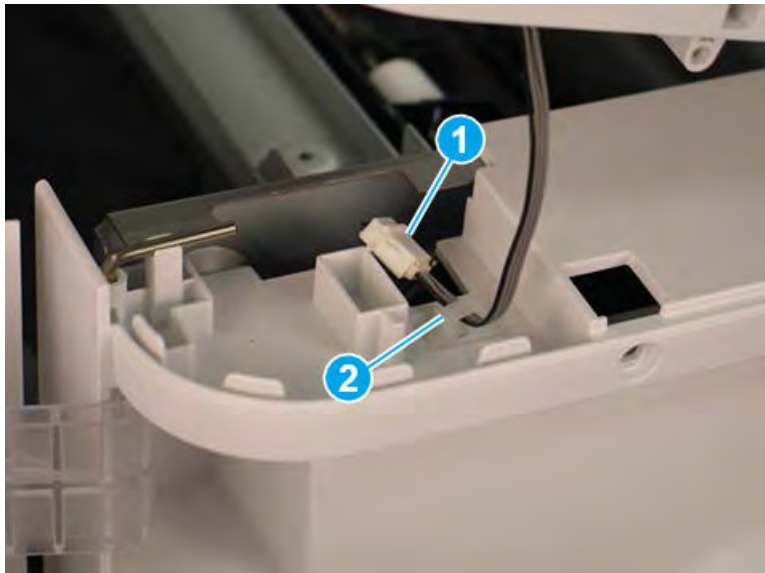
3. Lift the cover up slightly. Disconnect one in-line connector (callout 1), and then release one retainer (callout 2).

---

 **TIP:** Reverse the removal steps to install the assembly.

---

Figure 5-1558 Disconnect one connector and release retainer



### Remove the rear cover (finisher)

Follow these steps to remove the rear cover (finisher).

1. Remove two self-tapping screws (callout 1) on the top of the rear cover, and then remove five screw caps and five machine screws (callout 2) on the left side of the cover.

Figure 5-1559 Remove seven screws

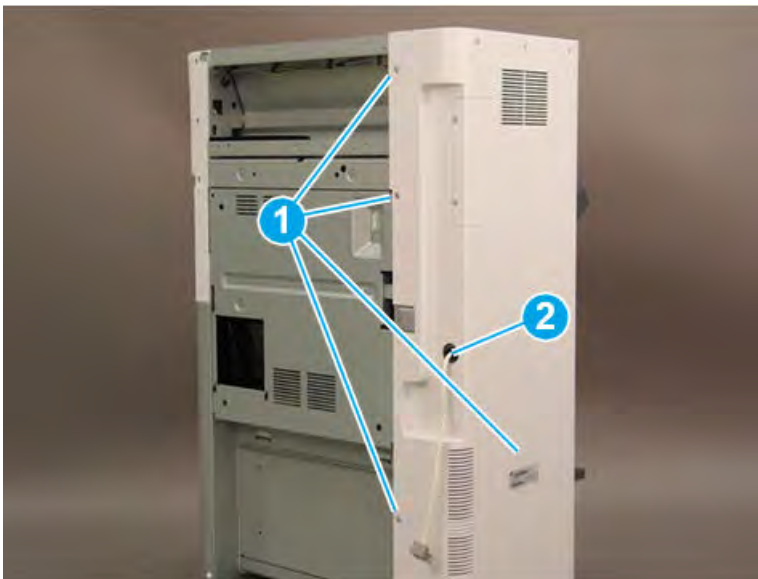


2. Remove one screw cap and four machine screws (callout 1) Remove the rear cover.

 **NOTE:** Make sure to thread the power cable (callout 2) through the opening in the cover.

 **TIP:** Reverse the removal steps to install the assembly

Figure 5-1560 Remove the rear cover



### Remove the booklet maker

Follow these steps to remove the booklet maker.

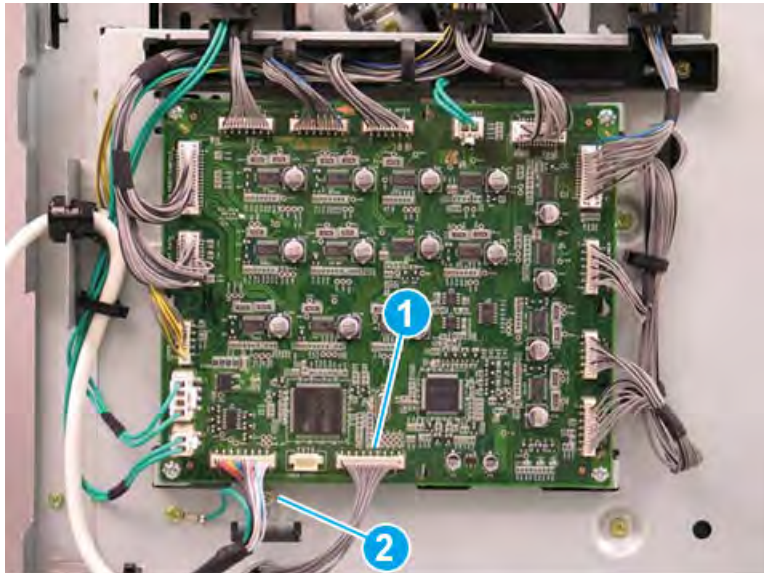
1. Slide the booklet maker away from the finisher.

Figure 5-1561 Slide the booklet maker away from the finisher



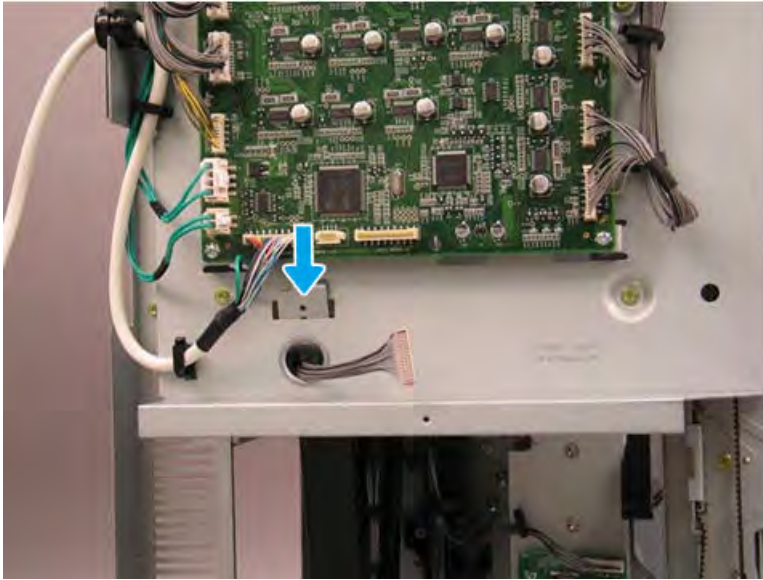
2. At the Disconnect one connector (callout 1), and then remove one screw (callout 2).

Figure 5-1562 Disconnect one connector and remove one screw



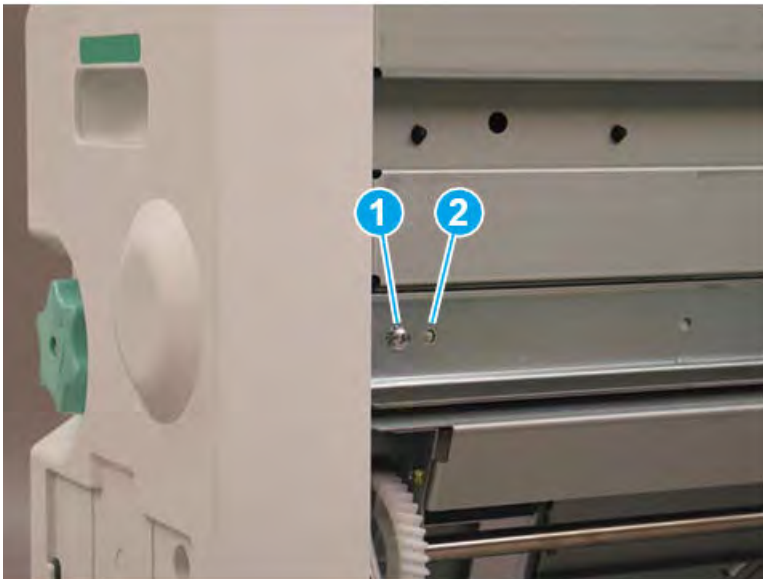
3. Release the metal bracket through the opening in the sheet metal.

Figure 5-1563 Release the metal bracket



4. Remove one star-washer screw (callout 1), and then release the alignment pin (callout 2) on the right side of the booklet maker.

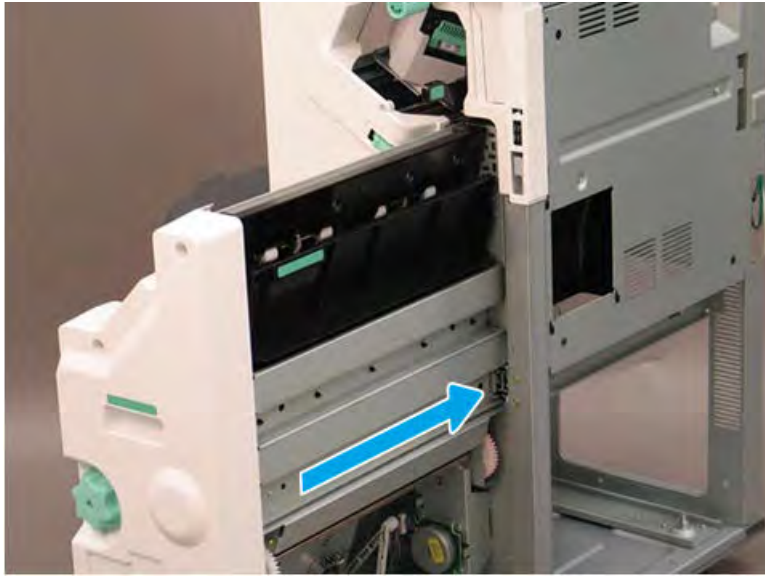
Figure 5-1564 Remove one screw





5. Slide the right rail toward the finisher.

Figure 5-1565 Slide the right rail



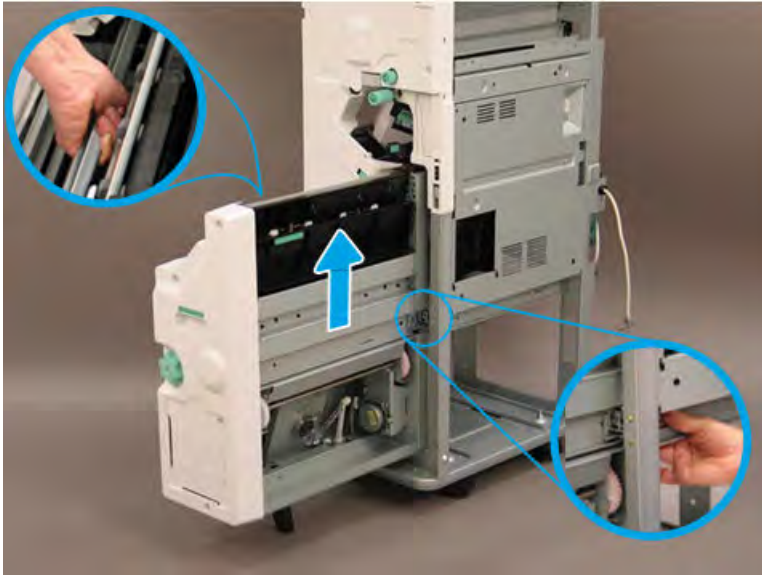
6. Remove one star-washer screw (callout 1) on the left side of the booklet maker.

Figure 5-1566 Remove one screw



7. Lift the booklet maker up on the left side while squeezing the right rail away from the finisher slightly to clear the sheet metal. Remove the booklet maker.

**Figure 5-1567** Remove the booklet maker



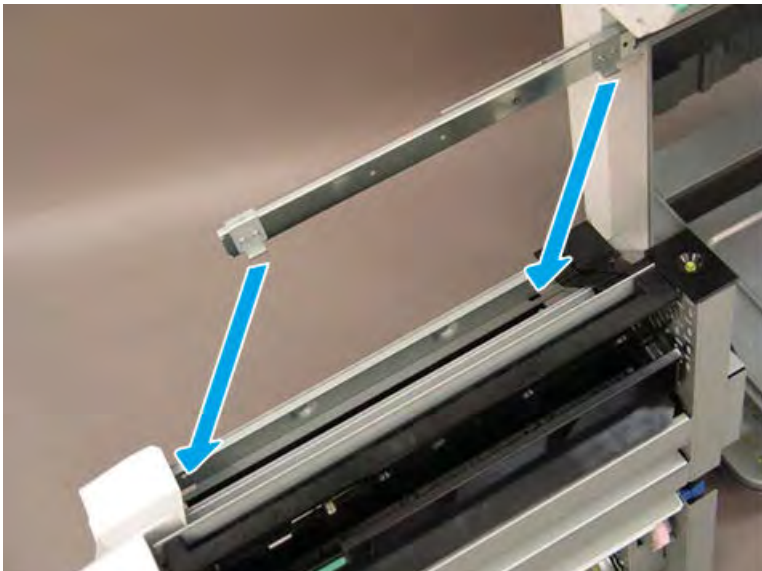
8. Reverse the removal steps to install the assembly. Also use the following special installation instructions.

 **NOTE:** Continue to reverse the removal steps to finish installing the assembly.

**Special installation instructions: booklet maker**

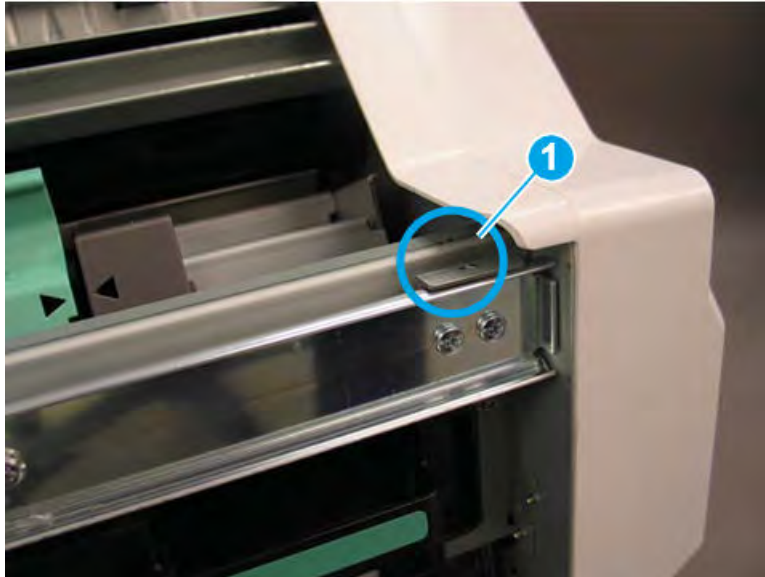
When installing the booklet maker, position the hooks on the rail under the slots on the booklet maker.

**Figure 5-1568** Position the hooks



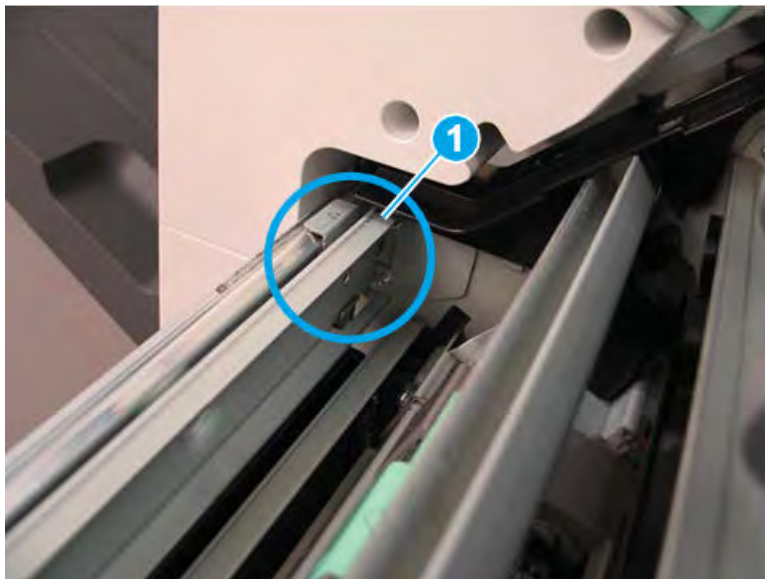
9. When installed correctly, the arrow on the front of the booklet maker aligns with the arrow on the finisher rail.

Figure 5-1569 Align arrows



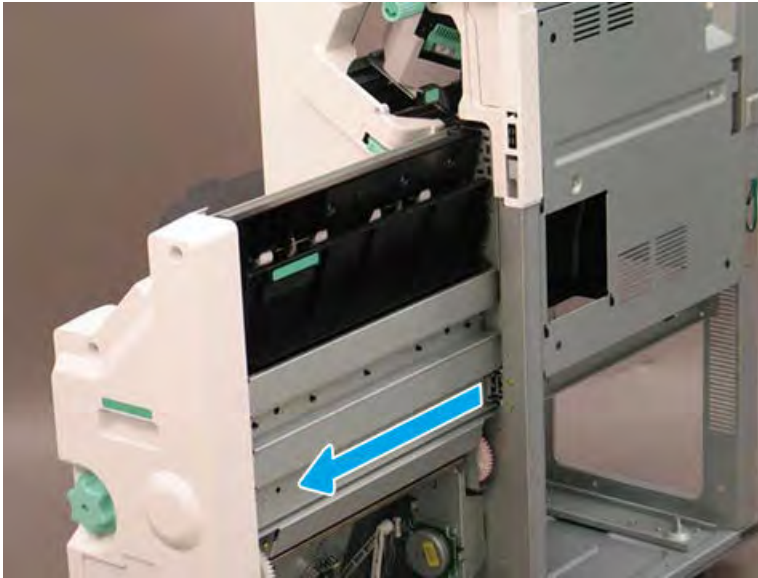
10. When installed correctly, the arrow on the back of the booklet maker aligns with the arrow on the finisher rail.

Figure 5-1570 Align arrows



11. Extend the right rail away from the finisher and position it in the booklet maker slot.

Figure 5-1571 Extend the right rail



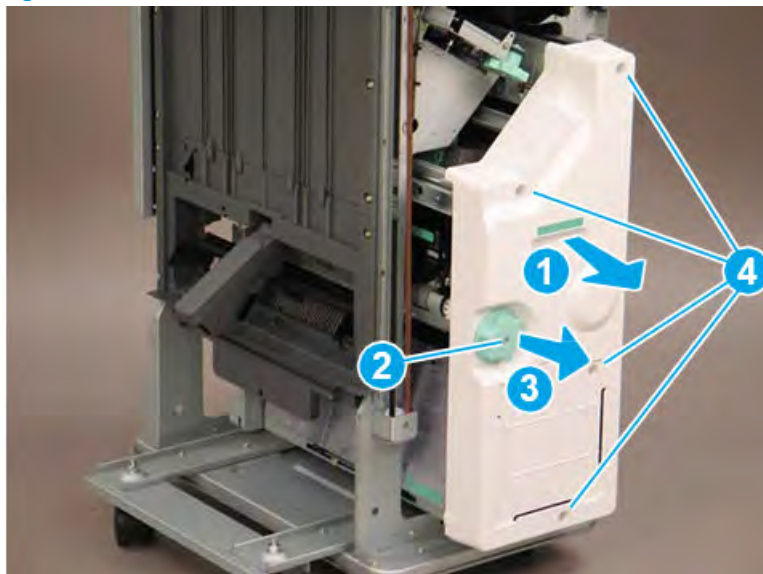
### Remove the booklet front cover

Follow these steps to remove the booklet front cover.

- ▲ Slide the booklet maker slightly away from the finisher (callout 1). Remove one screw (callout 2), and then slide the green knob away from the booklet maker to remove it (callout 3). Remove four screws (callout 4), and then remove the booklet front cover.

 **TIP:** Reverse the removal steps to install the assembly

Figure 5-1572 Remove five screws and the cover

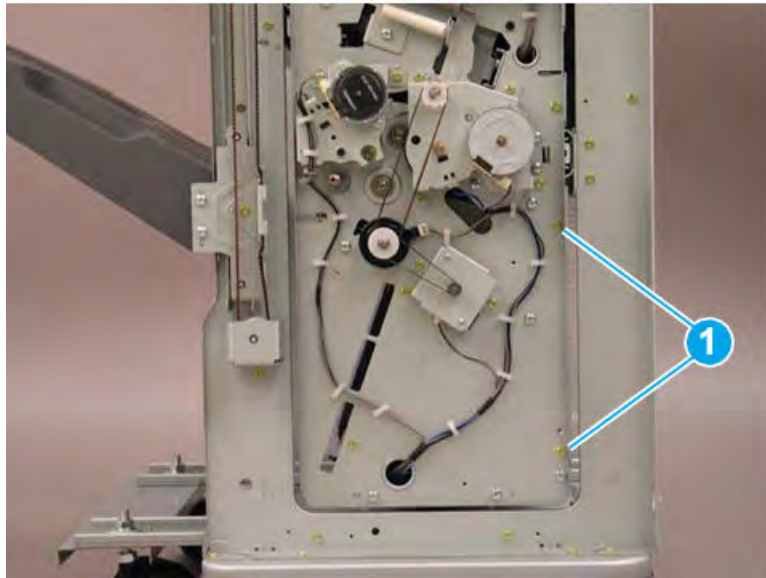


### Remove the booklet right lower shield

Follow these steps to remove the booklet right lower shield.

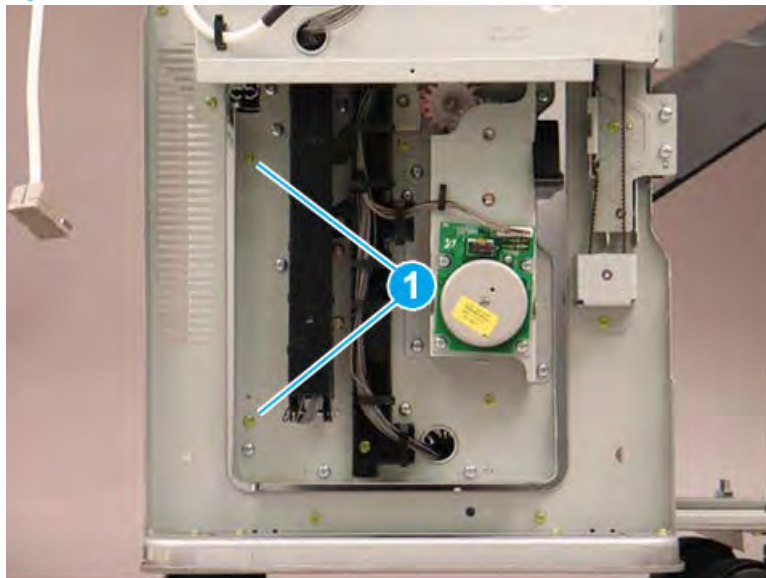
1. Remove two screws at the front of the booklet maker (callout 1).

Figure 5-1573 Remove two screws



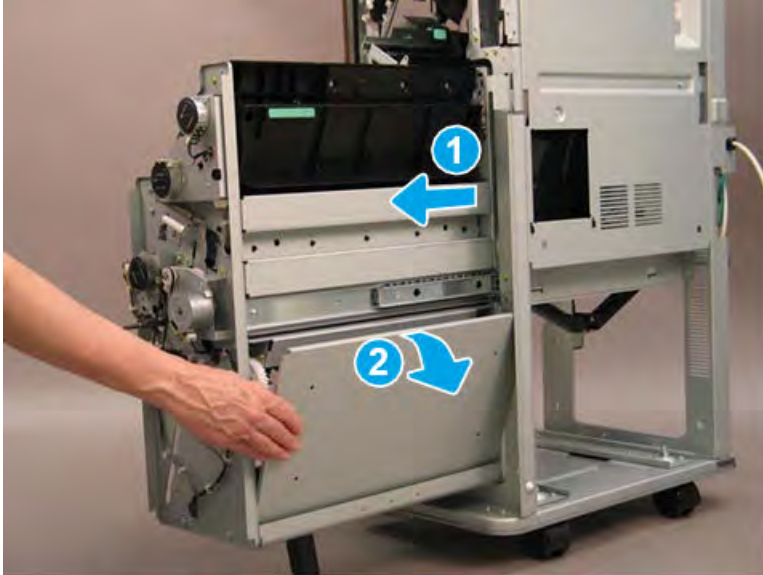
2. Remove two screws at the back of the booklet maker (callout 1).

Figure 5-1574 Remove two screws



3. Slide the booklet maker out of the finisher (callout 1), and then rotate the top of the right lower shield (callout 2) away from the booklet maker to remove it.

**Figure 5-1575** Remove the right lower shield

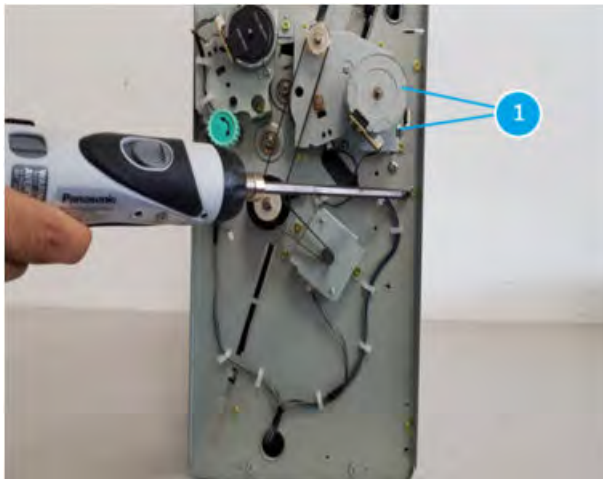


#### Remove the booklet maker middle right shield

Follow these steps to remove the booklet maker middle right shield.

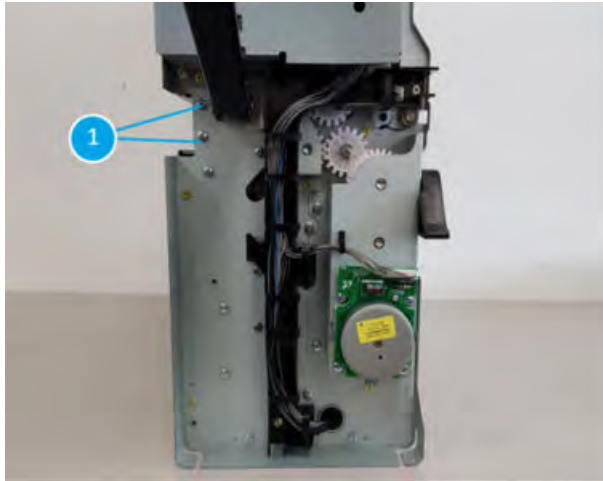
1. Remove two screws at the front of the booklet maker (callout 1).

**Figure 5-1576** Remove two screws at the front of the booklet maker



2. Remove two screws at the back of the booklet maker (callout 1).

**Figure 5-1577** Remove two screws at the back of the booklet maker



### Remove the booklet finisher upper right shield

Follow these steps to remove the booklet finisher upper right shield.

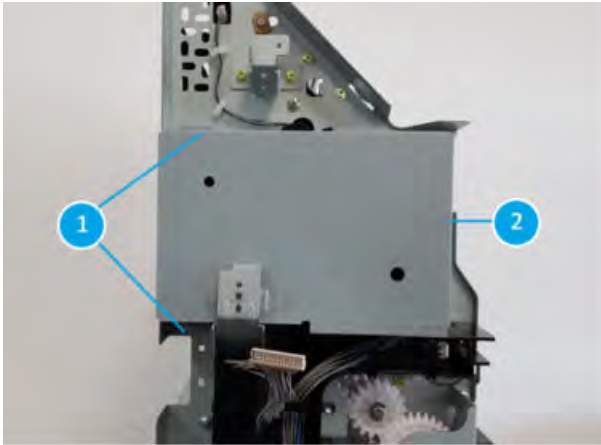
1. Remove two screws at the front of the booklet maker (callout 1)

**Figure 5-1578** Remove two screws at the front of the booklet maker



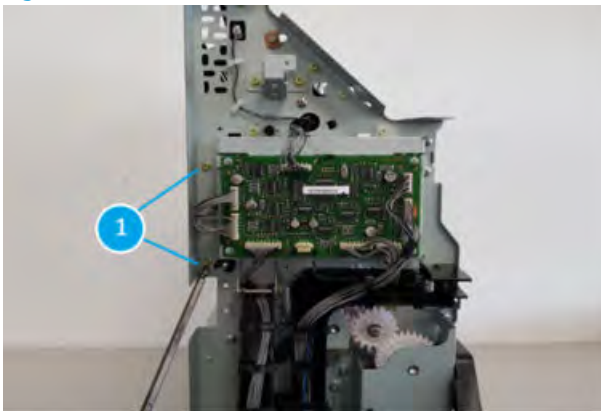
2. Remove two screws (callout 1) and one screw (callout 2) at the back of the booklet maker and then remove the board cover.

Figure 5-1579 Remove the board cover



3. Remove two screws at the back of the booklet maker (callout 1).

Figure 5-1580 Remove two screws



4. Disconnect one connector at the front of the booklet maker (callout 1).

Figure 5-1581 Disconnect one connector





5. Disconnect one connector at the right of the booklet maker (callout 1).

Figure 5-1582 Disconnect one connector



### Remove the booklet tamper and fold unit

Follow these steps to remove the booklet tamper and fold unit.

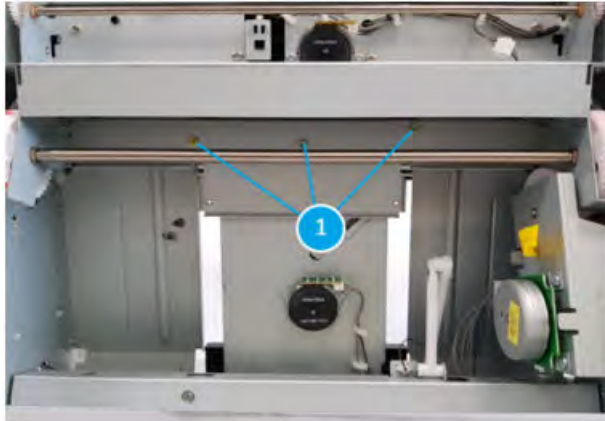
1. Remove two screws at the left of the booklet maker (callout 1).

Figure 5-1583 Remove two screws at the left of the booklet maker



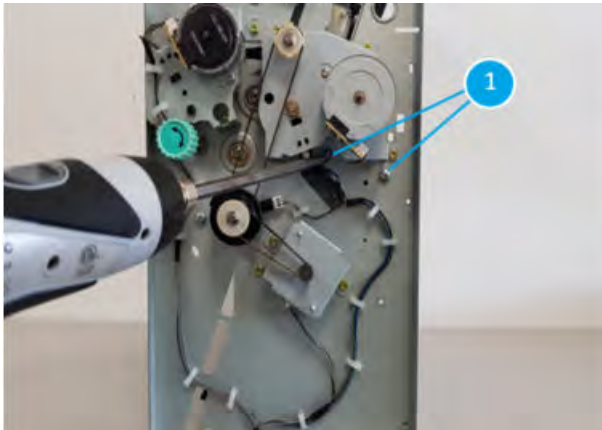
2. Remove three screws at the right of the booklet maker (callout 1).

**Figure 5-1584** Remove three screws at the right of the booklet maker



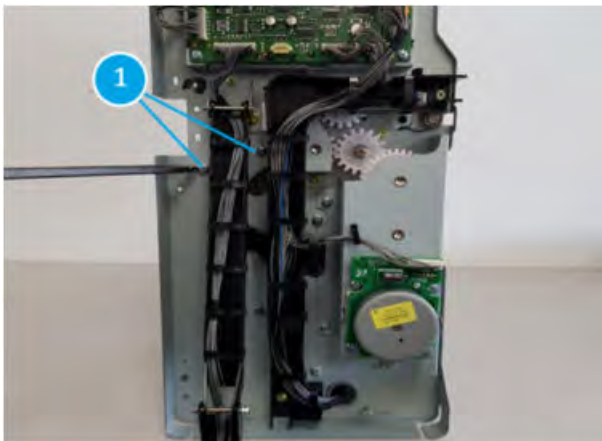
3. Remove two screws at the front of the booklet maker (callout 1).

**Figure 5-1585** Remove two screws at the front of the booklet maker



4. Remove two screws at the back of the booklet maker (callout 1).

**Figure 5-1586** Remove two screws at the back of the booklet maker



5. Disconnect one connector at the right of the booklet maker (callout 1).

Figure 5-1587 Disconnect one connector

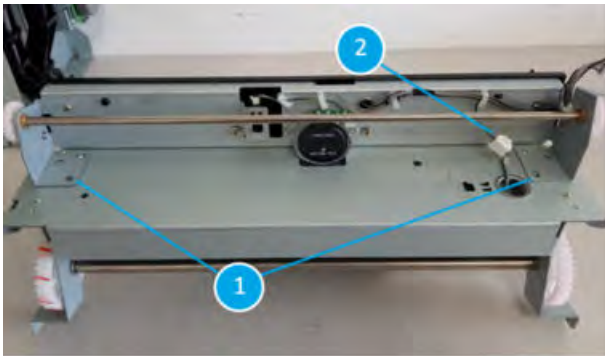


### Remove the booklet tamper unit

Follow these steps to remove the booklet tamper unit.

1. Remove two screws and disconnect one connector (callout 2)

Figure 5-1588 Remove two screws



2. Booklet tamper unit (callout 1)

Figure 5-1589 Booklet tamper unit



### Unpack the replacement assembly

Follow these steps to unpack the replacement assembly.

1. Dispose of the defective part.



---


 **NOTE:** HP recommends responsible disposal of the defective part.


<http://www8.hp.com/us/en/hp-information/environment/product-recycling.html>

---

2. Unpack the replacement part from the packaging.


 **CAUTION:**  Some parts are sensitive to electrostatic discharge (ESD). Always perform service work at an ESD-protected workstation or mat. If an ESD workstation or mat is not available, touch the sheet-metal chassis to provide a static ground before touching an ESD-sensitive assembly. Protect the ESD-sensitive assemblies by placing them in ESD pouches when they are out of the printer.

 **IMPORTANT:** Make sure that all of the shipping materials (for example shipping tape) are removed from the replacement part prior to installation.

 **NOTE:** If the replacement part is a roller or pad, avoid touching the spongy part of it. Skin oils on the roller or pad can cause paper pickup and/or print-quality problems. HP recommends using disposable gloves when handling rollers or pads or washing your hands before touching rollers or pads.

---

3. To install an assembly, reverse the removal steps.

 **NOTE:** When applicable, special installation instructions are provided for an assembly at the end of the removal procedure. Always completely read the removal instructions and follow all special installation instructions.

---

## Removal and replacement: Booklet presser home sensor (S37)

Learn how to remove and replace the tray booklet tamper home sensor.

### Introduction

This document provides the procedures to remove and replace the booklet tamper home sensor on the finisher.



**IMPORTANT:** When applicable, special installation instructions are provided for an assembly at the end of the removal procedure. Always completely read the removal instructions and follow all special installation instructions.

### Before performing service

- Turn the printer power off. A shutting-down message appears on the control-panel display.
- ⚠ **WARNING!** To avoid damage to the printer, turn the power off and wait until the printer shuts down before removing the power cable.
- Disconnect the printer power cable after the printer has completely shut down (the control-panel display is blank).
- Release the finisher from the printer by pulling out on the release latch inside the finisher door.
- Disconnect the cable from the bridge unit to the finisher.
- Disconnect the cable from the finisher to the printer.

Use the table below to identify the correct part number for your printer. To order the part, go to <https://parts.hp.com>.

**Table 5-155** Part information

Part number	Part description
0604-001393	Booklet tamper home sensor

### Required tools

- #2 JIS screwdriver with a magnetic tip

### After performing service

- Connect the cable from the finisher to the printer.
- Connect the cable from the bridge unit to the finisher.
- Attach the finisher to the printer, and then push in on the release latch inside the finisher door.
- Connect the printer power cable.
- Turn the printer power on.

### Post service test

Process a job through the finisher and verify that the finisher works correctly.

## Remove the right upper cover (finisher)

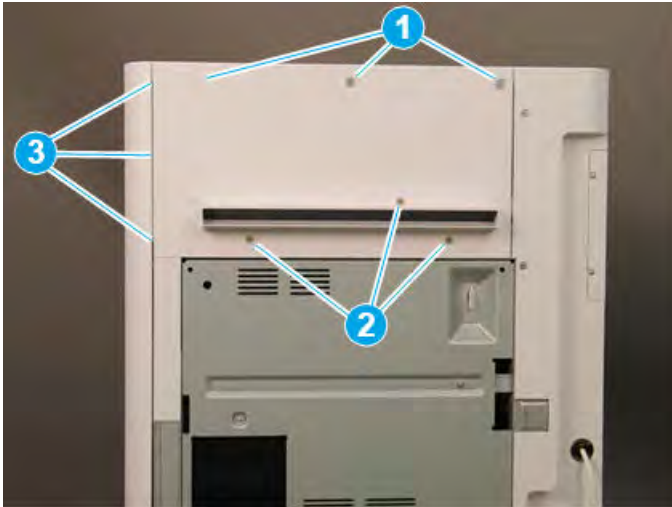
Follow these steps to remove the right upper cover (finisher).

- ▲ Remove one screw cap and three machine screws on the upper edge of the cover (callout 1). Remove three sheet metal screws (callout 2) on the lower portion of the cover. Rotate the right edge of the cover away from the finisher, and then slide the cover right to release three tabs (callout 3).

💡 **TIP:** The lower screws are shorter in length than the upper screws.

**TIP:** Reverse the removal steps to install the assembly.

**Figure 5-1590** Remove the right upper cover

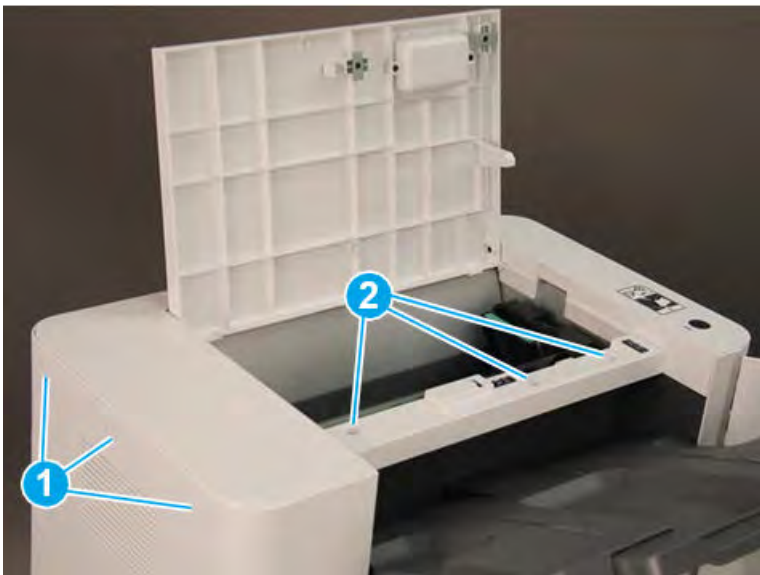


## Remove the top cover (finisher)

Follow these steps to remove the top cover (finisher).

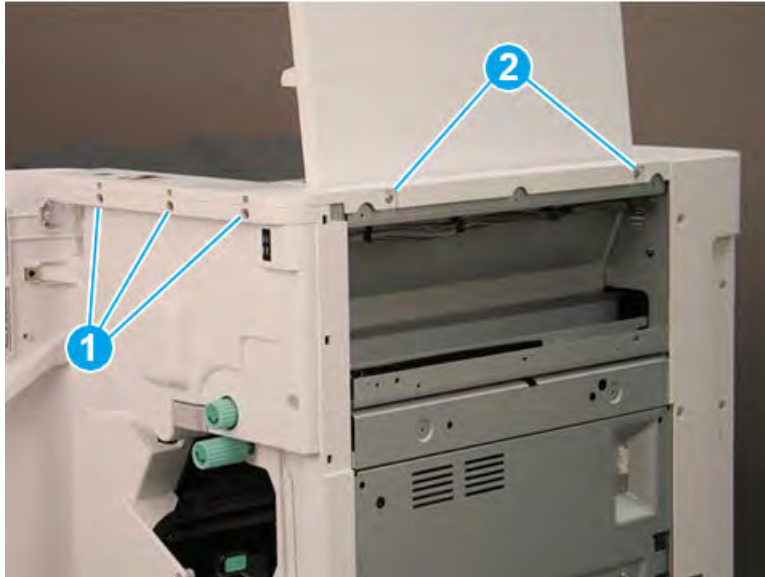
1. Remove three screw caps and three self-tapping screws at the top of the rear cover (callout 1), and then remove three machine screws (callout 2) on top of the cover.

**Figure 5-1591** Remove six screws



2. Remove three self-tapping screws at the top of the front cover (callout 1), and then remove two machine screws (callout 2) at the top of the right side.

Figure 5-1592 Remove five screws



3. Lift the cover up slightly. Disconnect one in-line connector (callout 1), and then release one retainer (callout 2).


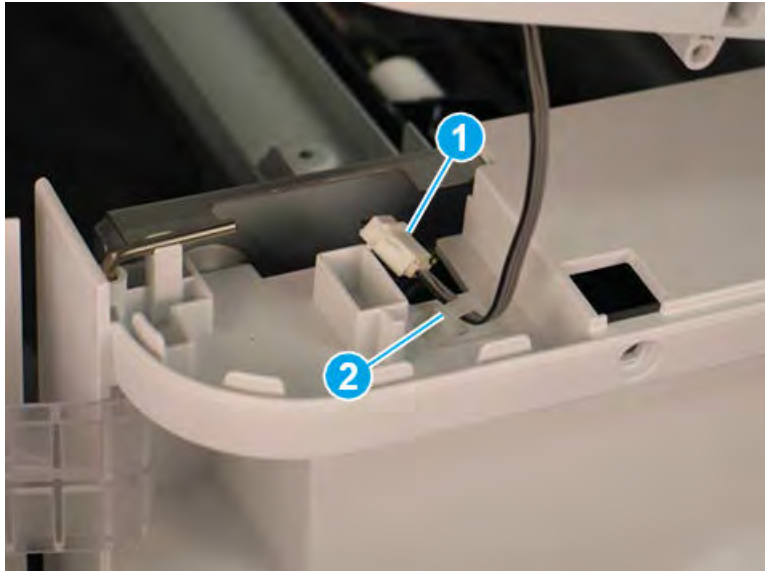
 **TIP:** Reverse the removal steps to install the assembly.

Figure 5-1593 Disconnect one connector and release retainer

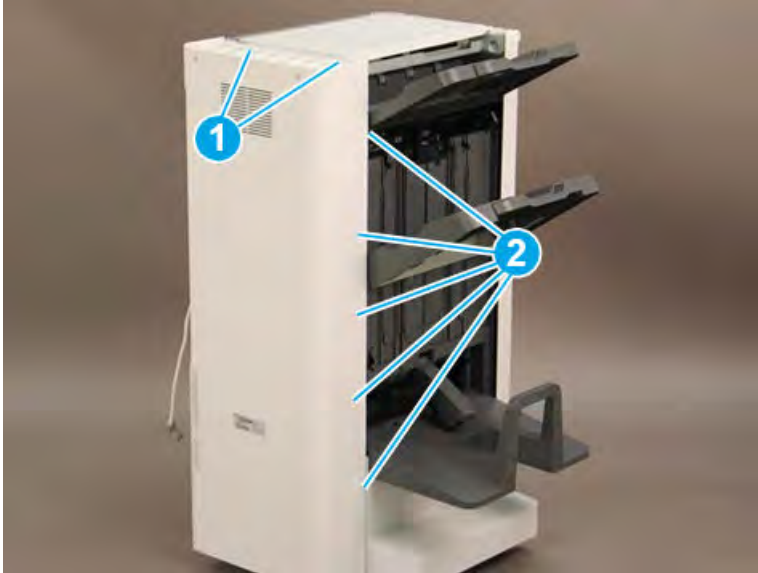


### Remove the rear cover (finisher)

Follow these steps to remove the rear cover (finisher).

1. Remove two self-tapping screws (callout 1) on the top of the rear cover, and then remove five screw caps and five machine screws (callout 2) on the left side of the cover.

Figure 5-1594 Remove seven screws



2. Remove one screw cap and four machine screws (callout 1) Remove the rear cover.

 **NOTE:** Make sure to thread the power cable (callout 2) through the opening in the cover.


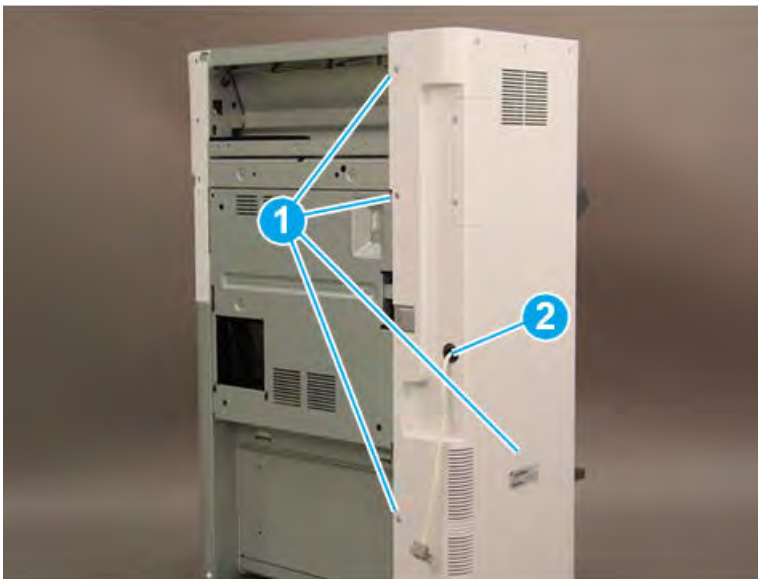
 **TIP:** Reverse the removal steps to install the assembly

Figure 5-1595 Remove the rear cover



### Remove the booklet maker

Follow these steps to remove the booklet maker.

1. Slide the booklet maker away from the finisher.

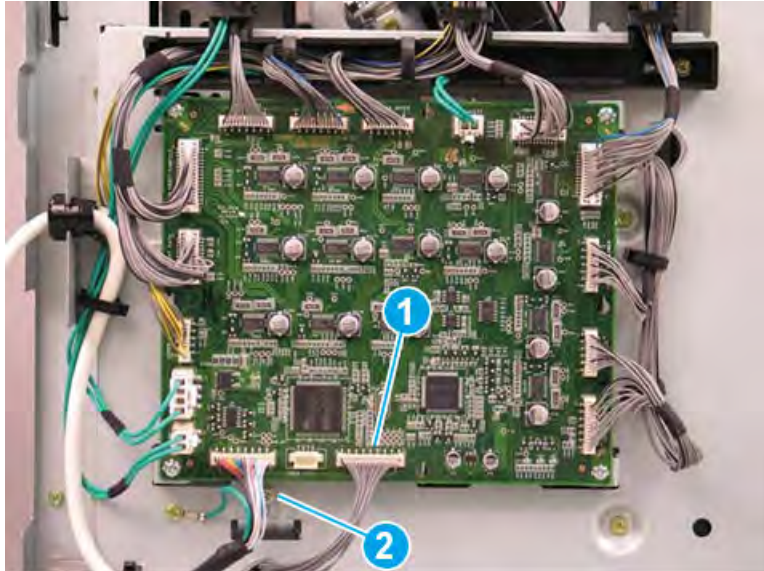


Figure 5-1596 Slide the booklet maker away from the finisher



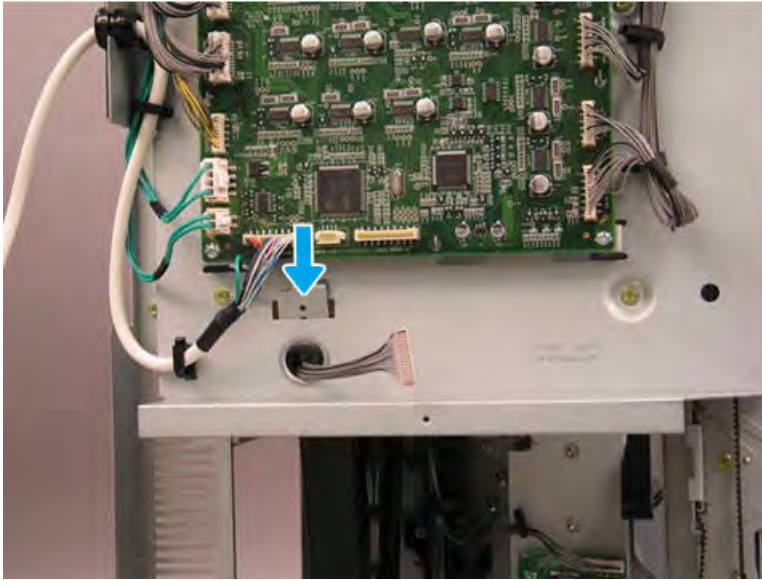
2. At the Disconnect one connector (callout 1), and then remove one screw (callout 2).

Figure 5-1597 Disconnect one connector and remove one screw



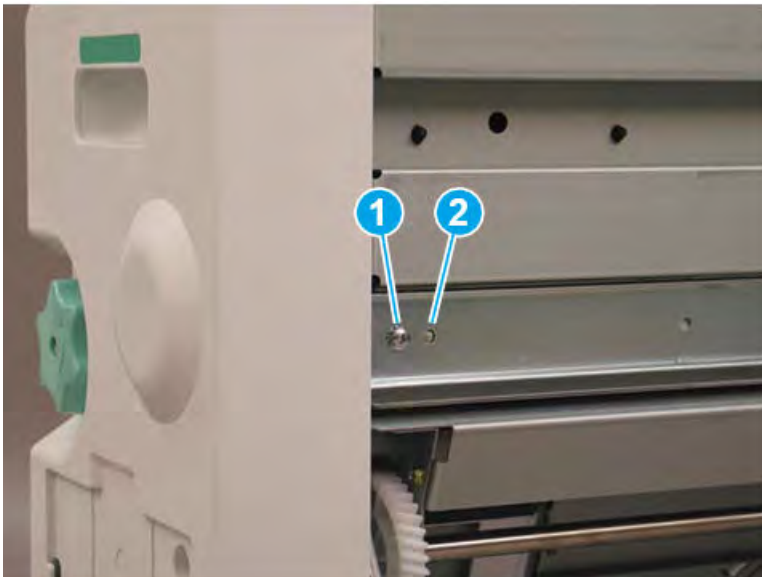
3. Release the metal bracket through the opening in the sheet metal.

Figure 5-1598 Release the metal bracket



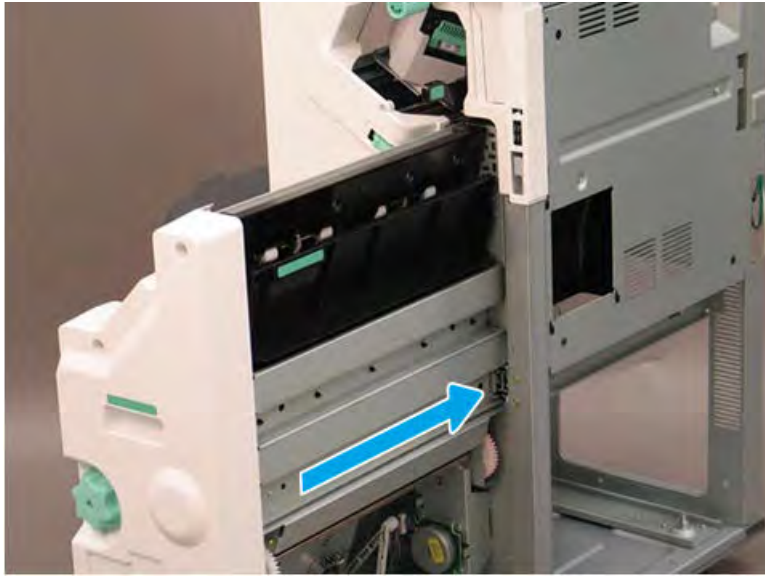
4. Remove one star-washer screw (callout 1), and then release the alignment pin (callout 2) on the right side of the booklet maker.

Figure 5-1599 Remove one screw



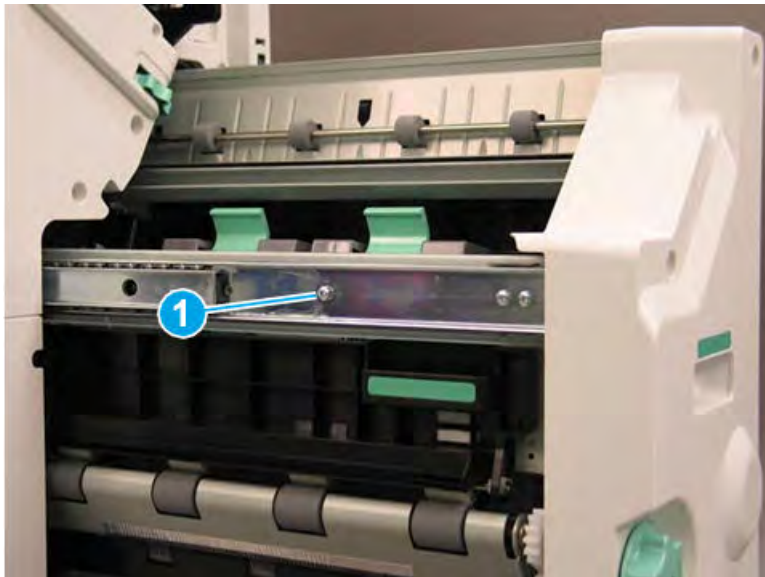
5. Slide the right rail toward the finisher.

Figure 5-1600 Slide the right rail



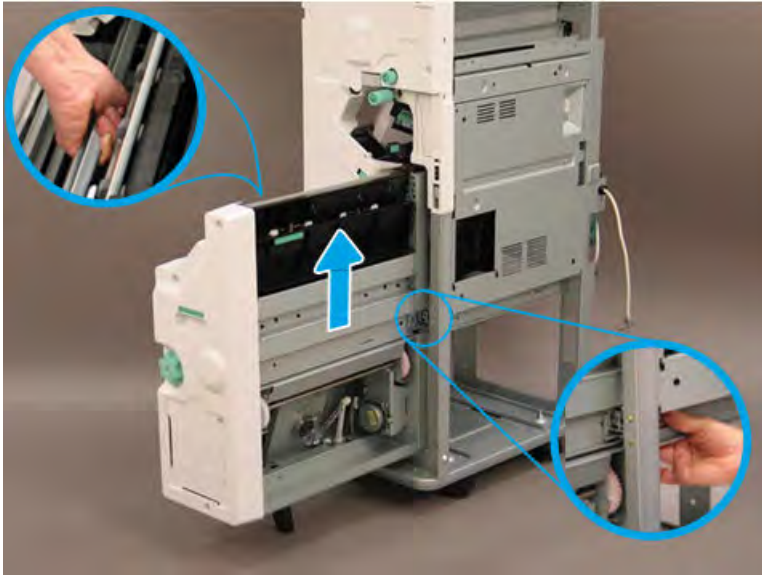
6. Remove one star-washer screw (callout 1) on the left side of the booklet maker.

Figure 5-1601 Remove one screw



7. Lift the booklet maker up on the left side while squeezing the right rail away from the finisher slightly to clear the sheet metal. Remove the booklet maker.

Figure 5-1602 Remove the booklet maker



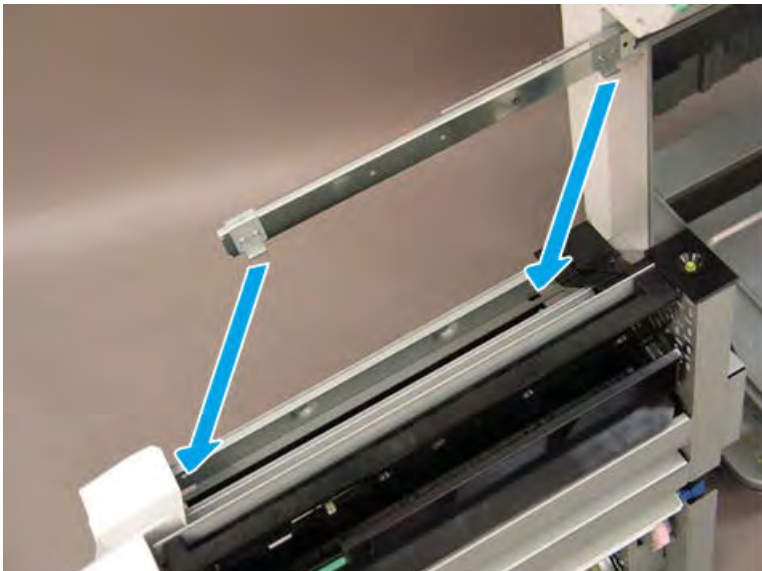
8. Reverse the removal steps to install the assembly. Also use the following special installation instructions.

 **NOTE:** Continue to reverse the removal steps to finish installing the assembly.

**Special installation instructions: booklet maker**

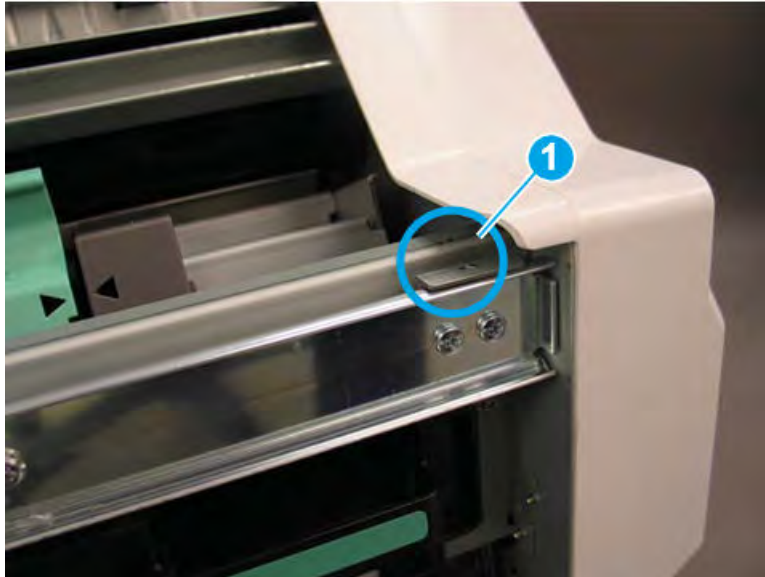
When installing the booklet maker, position the hooks on the rail under the slots on the booklet maker.

Figure 5-1603 Position the hooks



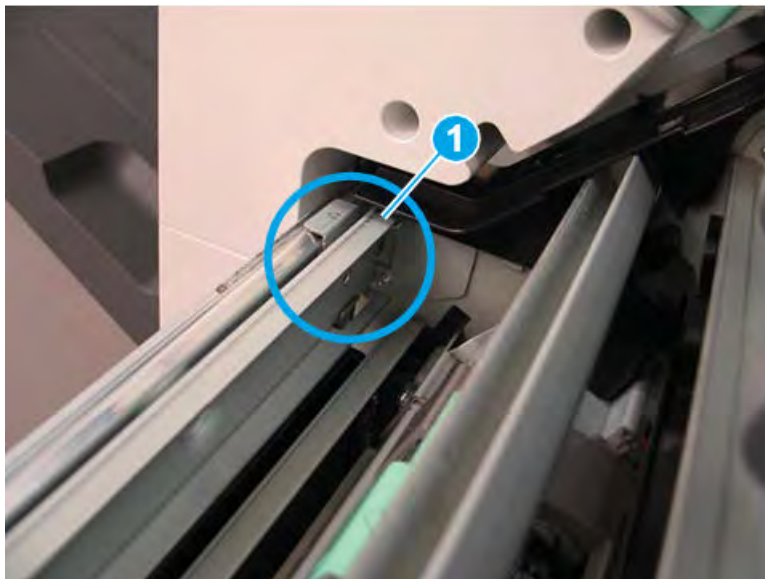
9. When installed correctly, the arrow on the front of the booklet maker aligns with the arrow on the finisher rail.

Figure 5-1604 Align arrows



10. When installed correctly, the arrow on the back of the booklet maker aligns with the arrow on the finisher rail.

Figure 5-1605 Align arrows



11. Extend the right rail away from the finisher and position it in the booklet maker slot.

Figure 5-1606 Extend the right rail



#### Remove the booklet front cover

Follow these steps to remove the booklet front cover.

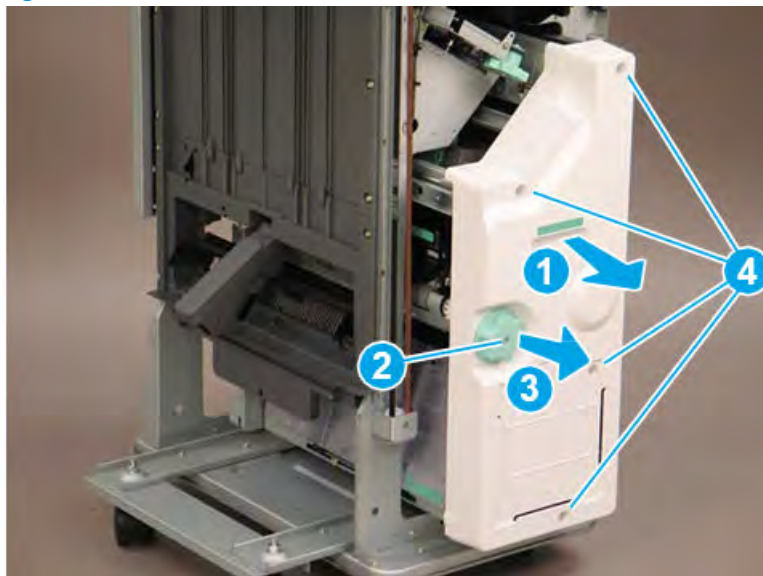
- ▲ Slide the booklet maker slightly away from the finisher (callout 1). Remove one screw (callout 2), and then slide the green knob away from the booklet maker to remove it (callout 3). Remove four screws (callout 4), and then remove the booklet front cover.

---

 **TIP:** Reverse the removal steps to install the assembly

---

Figure 5-1607 Remove five screws and the cover

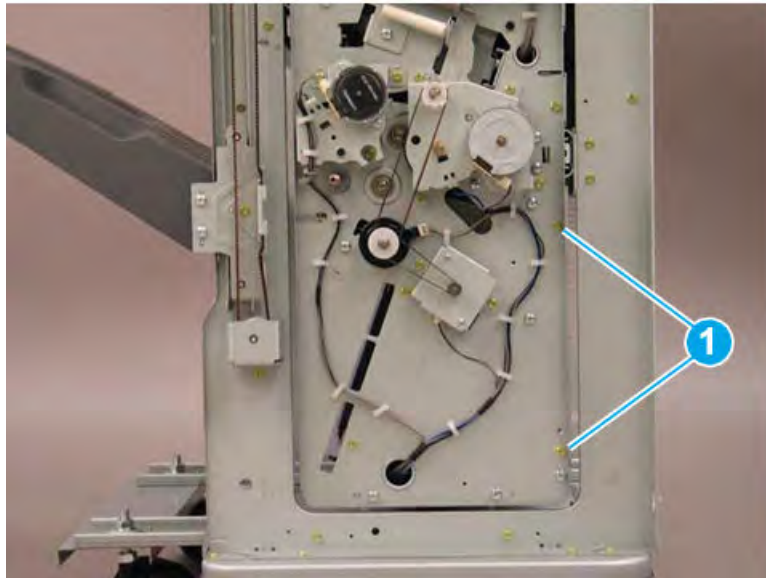


#### Remove the booklet right lower shield

Follow these steps to remove the booklet right lower shield.

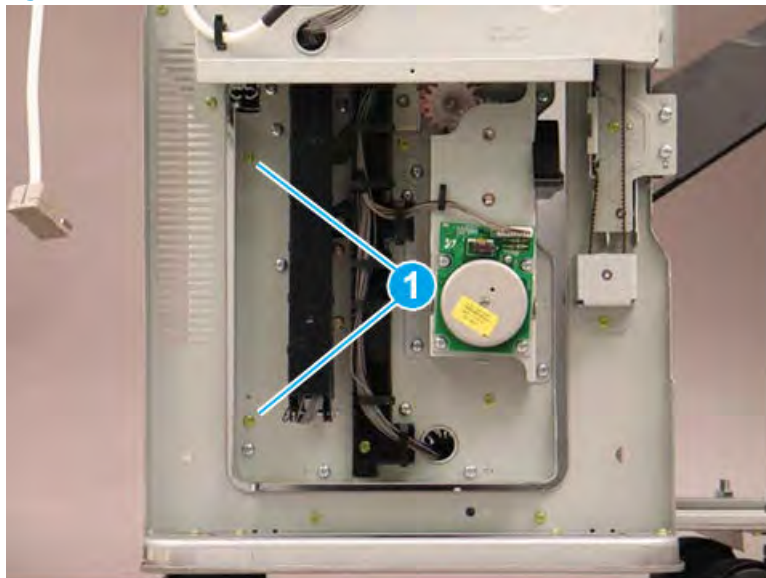
1. Remove two screws at the front of the booklet maker (callout 1).

Figure 5-1608 Remove two screws



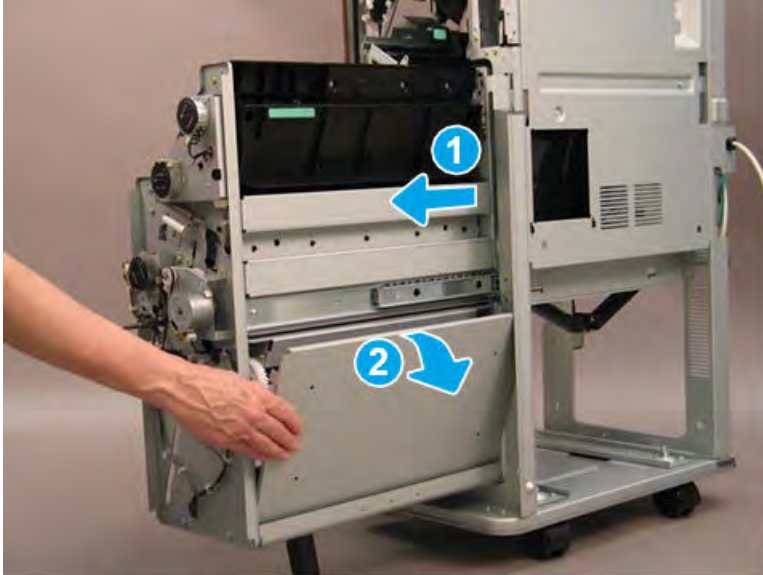
2. Remove two screws at the back of the booklet maker (callout 1).

Figure 5-1609 Remove two screws



3. Slide the booklet maker out of the finisher (callout 1), and then rotate the top of the right lower shield (callout 2) away from the booklet maker to remove it.

**Figure 5-1610** Remove the right lower shield

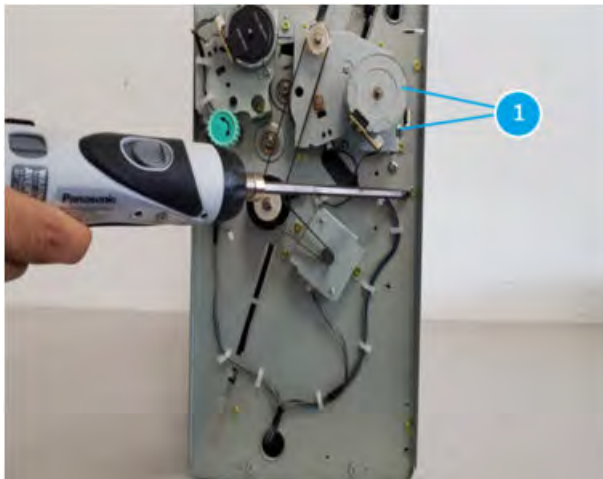


#### Remove the booklet maker middle right shield

Follow these steps to remove the booklet maker middle right shield.

1. Remove two screws at the front of the booklet maker (callout 1).

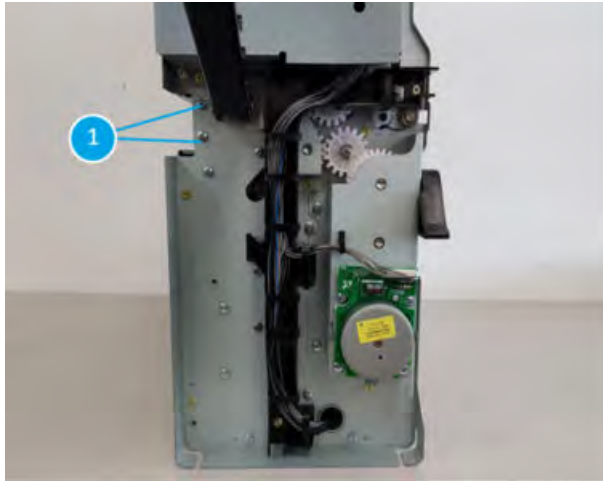
**Figure 5-1611** Remove two screws at the front of the booklet maker





2. Remove two screws at the back of the booklet maker (callout 1).

**Figure 5-1612** Remove two screws at the back of the booklet maker



### Remove the booklet finisher upper right shield

Follow these steps to remove the booklet finisher upper right shield.

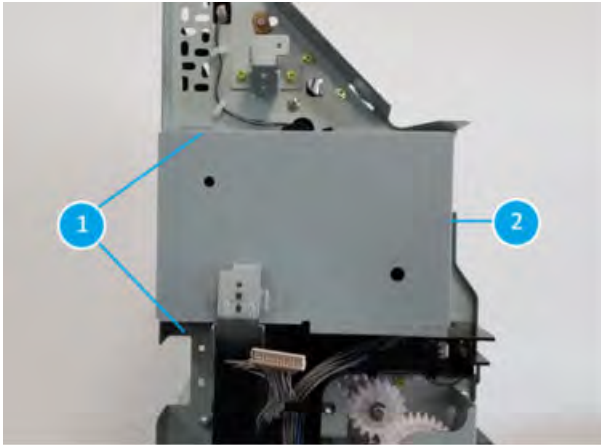
1. Remove two screws at the front of the booklet maker (callout 1)

**Figure 5-1613** Remove two screws at the front of the booklet maker



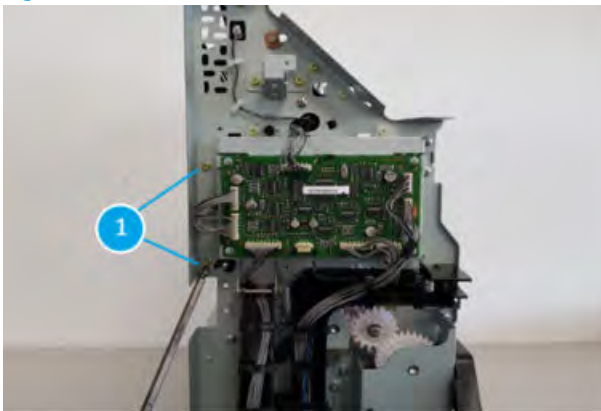
2. Remove two screws (callout 1) and one screw (callout 2) at the back of the booklet maker and then remove the board cover.

Figure 5-1614 Remove the board cover



3. Remove two screws at the back of the booklet maker (callout 1).

Figure 5-1615 Remove two screws



4. Disconnect one connector at the front of the booklet maker (callout 1).

Figure 5-1616 Disconnect one connector



5. Disconnect one connector at the right of the booklet maker (callout 1).

Figure 5-1617 Disconnect one connector



### Remove the booklet tamper and fold unit

Follow these steps to remove the booklet tamper and fold unit.

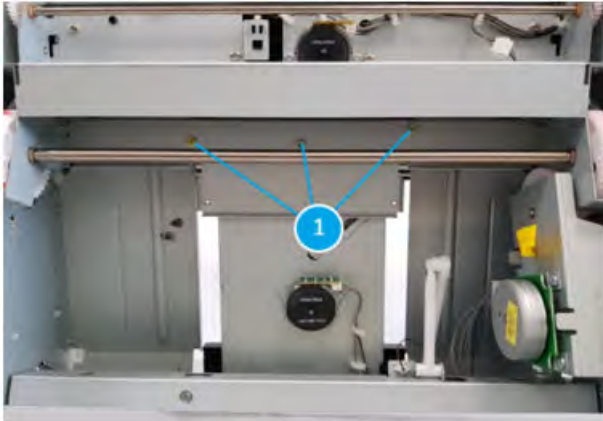
1. Remove two screws at the left of the booklet maker (callout 1).

Figure 5-1618 Remove two screws at the left of the booklet maker



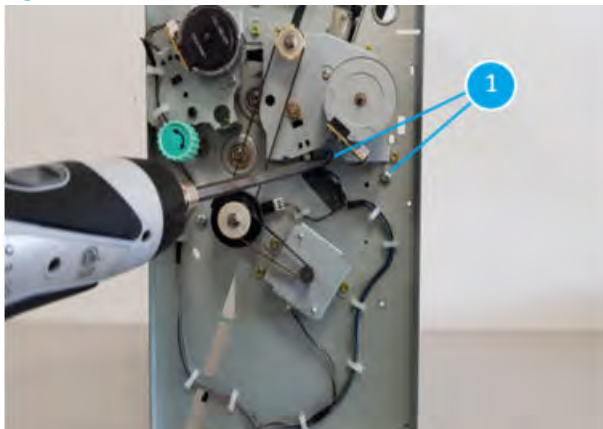
2. Remove three screws at the right of the booklet maker (callout 1).

Figure 5-1619 Remove three screws at the right of the booklet maker



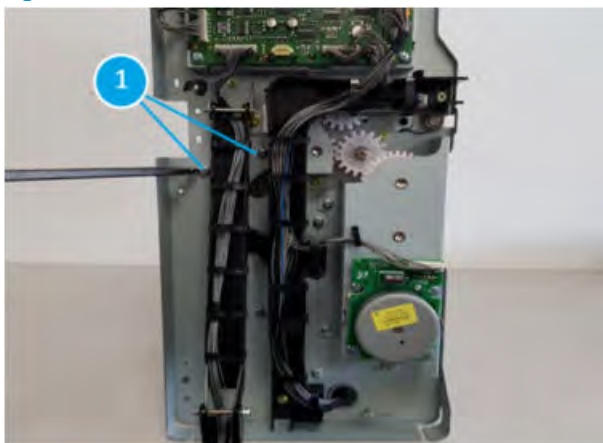
3. Remove two screws at the front of the booklet maker (callout 1).

Figure 5-1620 Remove two screws at the front of the booklet maker



4. Remove two screws at the back of the booklet maker (callout 1).

Figure 5-1621 Remove two screws at the back of the booklet maker



5. Disconnect one connector at the right of the booklet maker (callout 1).

Figure 5-1622 Disconnect one connector

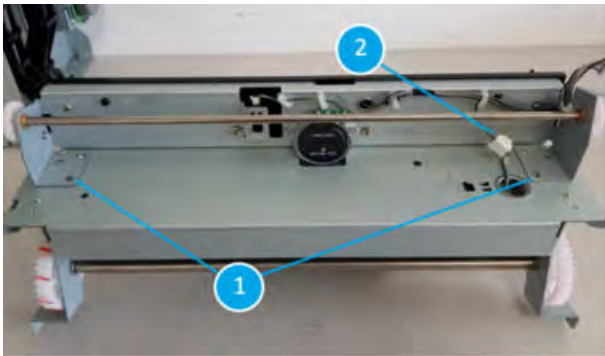


### Remove the booklet tamper unit

Follow these steps to remove the booklet tamper unit.

1. Remove two screws and disconnect one connector (callout 2)

Figure 5-1623 Remove two screws



2. Booklet tamper unit (callout 1)

Figure 5-1624 Booklet tamper unit

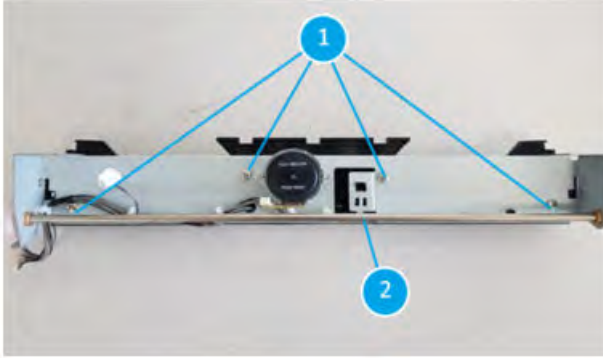


### Remove the booklet tamper home sensor (S38)

Follow these steps to remove the booklet tamper home sensor (S38).

1. Remove four screws (callout 1) and unplug one connector (callout 2)

Figure 5-1625 Remove four screws



2. Use a tweezer to remove the booklet tamper home sensor (S38, callout 1)

Figure 5-1626 Remove booklet tamper home sensor



### Unpack the replacement assembly



Follow these steps to unpack the replacement assembly.

1. Dispose of the defective part.


 **NOTE:** HP recommends responsible disposal of the defective part.

<http://www8.hp.com/us/en/hp-information/environment/product-recycling.html>

2. Unpack the replacement part from the packaging.


 **CAUTION:**  Some parts are sensitive to electrostatic discharge (ESD). Always perform service work at an ESD-protected workstation or mat. If an ESD workstation or mat is not available, touch the sheet-metal chassis to provide a static ground before touching an ESD-sensitive assembly. Protect the ESD-sensitive assemblies by placing them in ESD pouches when they are out of the printer.

 **IMPORTANT:** Make sure that all of the shipping materials (for example shipping tape) are removed from the replacement part prior to installation.

 **NOTE:** If the replacement part is a roller or pad, avoid touching the spongy part of it. Skin oils on the roller or pad can cause paper pickup and/or print-quality problems. HP recommends using disposable gloves when handling rollers or pads or washing your hands before touching rollers or pads.

3. To install an assembly, reverse the removal steps.

---

 **NOTE:** When applicable, special installation instructions are provided for an assembly at the end of the removal procedure. Always completely read the removal instructions and follow all special installation instructions.


---

## Removal and replacement: Booklet tamper motor (M23)

Learn how to remove and replace the tray booklet tamper motor.

### Introduction

This document provides the procedures to remove and replace the booklet tamper motor on the finisher.

 **IMPORTANT:** When applicable, special installation instructions are provided for an assembly at the end of the removal procedure. Always completely read the removal instructions and follow all special installation instructions.

### Before performing service

- Turn the printer power off. A shutting-down message appears on the control-panel display.
- ⚠ **WARNING!** To avoid damage to the printer, turn the power off and wait until the printer shuts down before removing the power cable.
- Disconnect the printer power cable after the printer has completely shut down (the control-panel display is blank).
- Release the finisher from the printer by pulling out on the release latch inside the finisher door.
- Disconnect the cable from the bridge unit to the finisher.
- Disconnect the cable from the finisher to the printer.

Use the table below to identify the correct part number for your printer. To order the part, go to <https://parts.hp.com>.

**Table 5-156 Part information**

Part number	Part description
JC93-01155A	Booklet tamper motor

### Required tools

- #2 JIS screwdriver with a magnetic tip

### After performing service

- Connect the cable from the finisher to the printer.
- Connect the cable from the bridge unit to the finisher.
- Attach the finisher to the printer, and then push in on the release latch inside the finisher door.
- Connect the printer power cable.
- Turn the printer power on.

### Post service test

Process a job through the finisher and verify that the finisher works correctly.



### Remove the right upper cover (finisher)

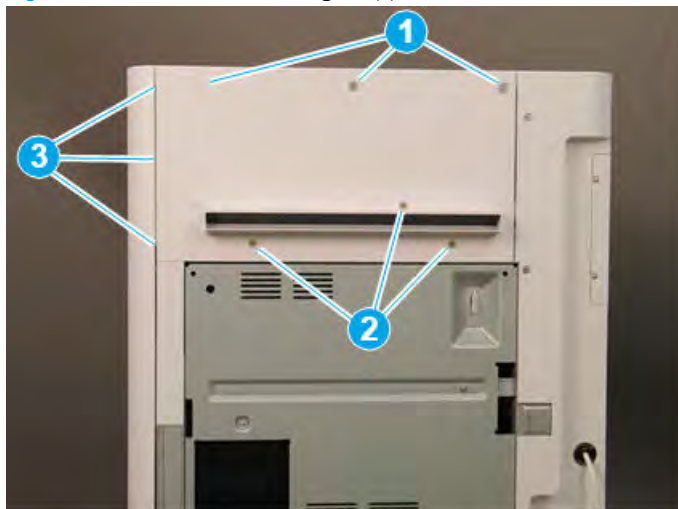
Follow these steps to remove the right upper cover (finisher).

- ▲ Remove one screw cap and three machine screws on the upper edge of the cover (callout 1). Remove three sheet metal screws (callout 2) on the lower portion of the cover. Rotate the right edge of the cover away from the finisher, and then slide the cover right to release three tabs (callout 3).

💡 **TIP:** The lower screws are shorter in length than the upper screws.

**TIP:** Reverse the removal steps to install the assembly.

Figure 5-1627 Remove the right upper cover

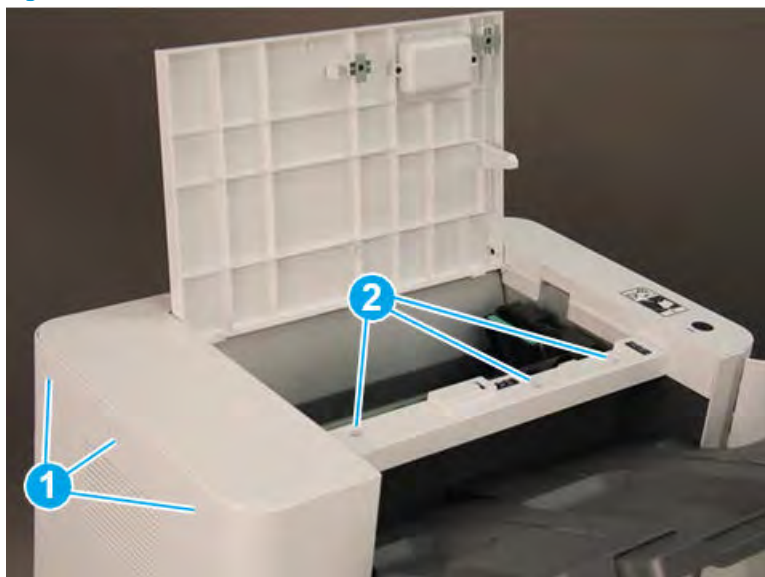


### Remove the top cover (finisher)

Follow these steps to remove the top cover (finisher).

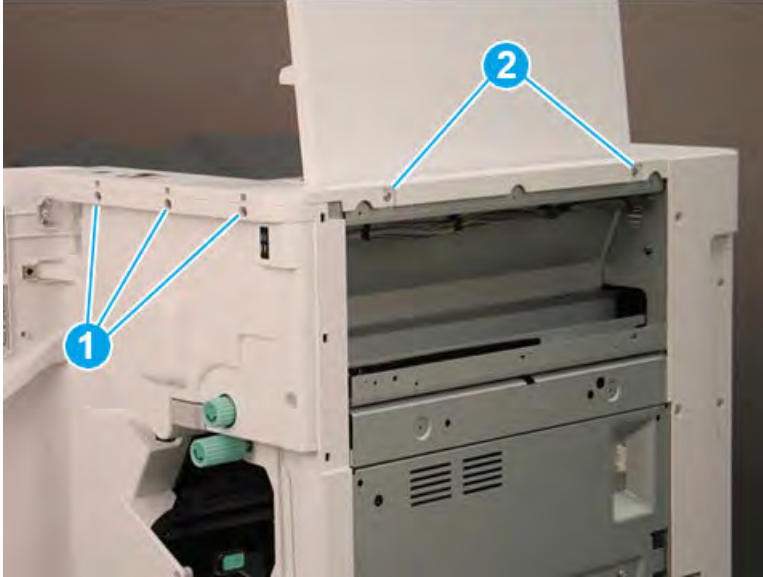
1. Remove three screw caps and three self-tapping screws at the top of the rear cover (callout 1), and then remove three machine screws (callout 2) on top of the cover.

Figure 5-1628 Remove six screws



2. Remove three self-tapping screws at the top of the front cover (callout 1), and then remove two machine screws (callout 2) at the top of the right side.

Figure 5-1629 Remove five screws



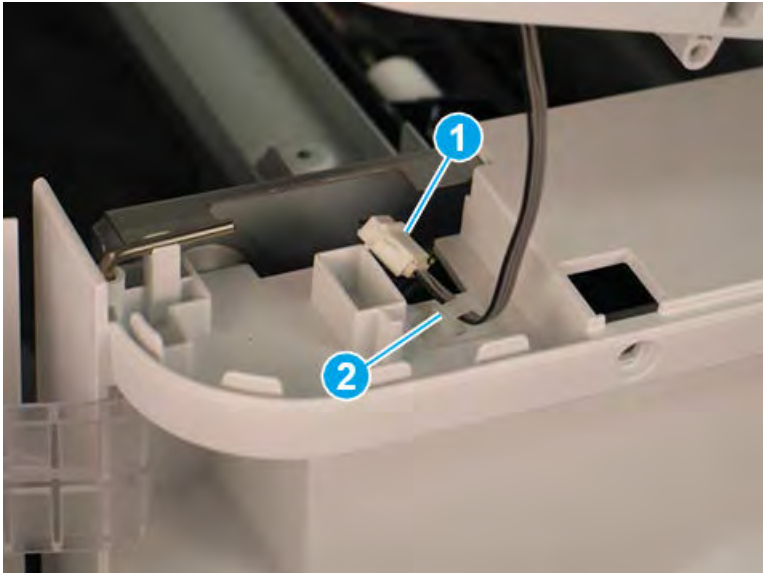
3. Lift the cover up slightly. Disconnect one in-line connector (callout 1), and then release one retainer (callout 2).

---

 **TIP:** Reverse the removal steps to install the assembly.

---

Figure 5-1630 Disconnect one connector and release retainer

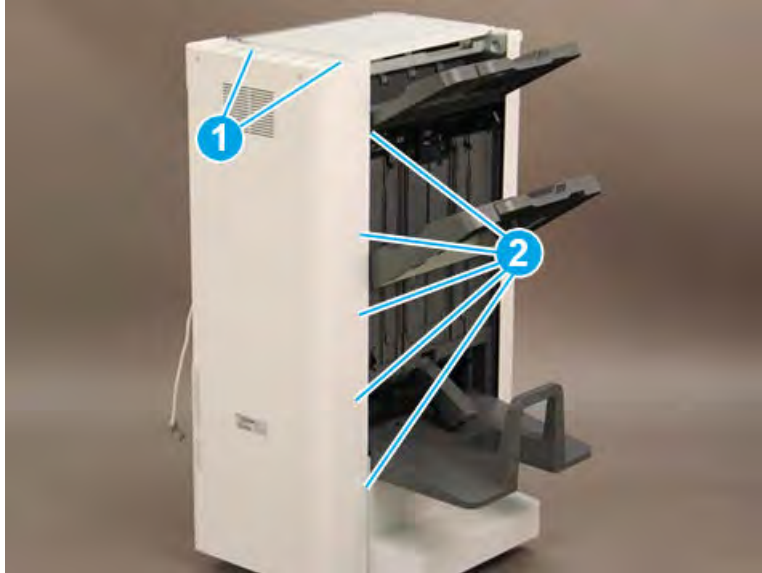


### Remove the rear cover (finisher)

Follow these steps to remove the rear cover (finisher).

1. Remove two self-tapping screws (callout 1) on the top of the rear cover, and then remove five screw caps and five machine screws (callout 2) on the left side of the cover.

Figure 5-1631 Remove seven screws



2. Remove one screw cap and four machine screws (callout 1) Remove the rear cover.

 **NOTE:** Make sure to thread the power cable (callout 2) through the opening in the cover.


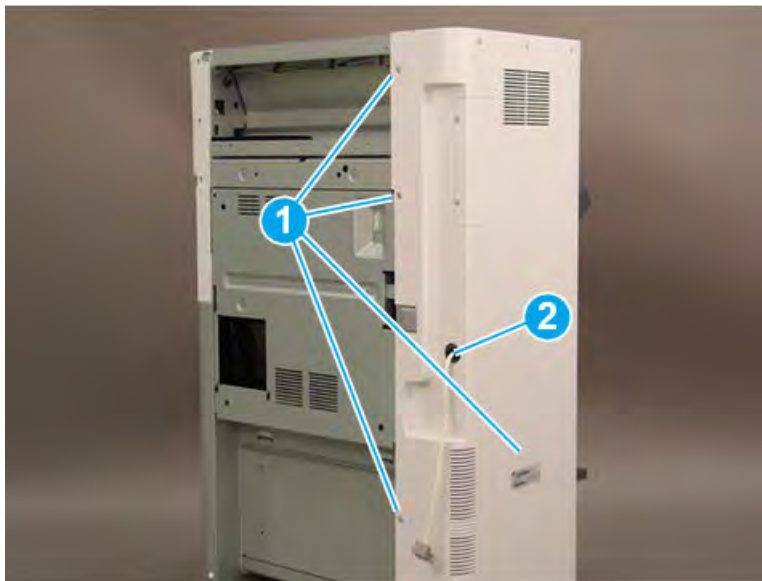
 **TIP:** Reverse the removal steps to install the assembly

Figure 5-1632 Remove the rear cover



### Remove the booklet maker

Follow these steps to remove the booklet maker.

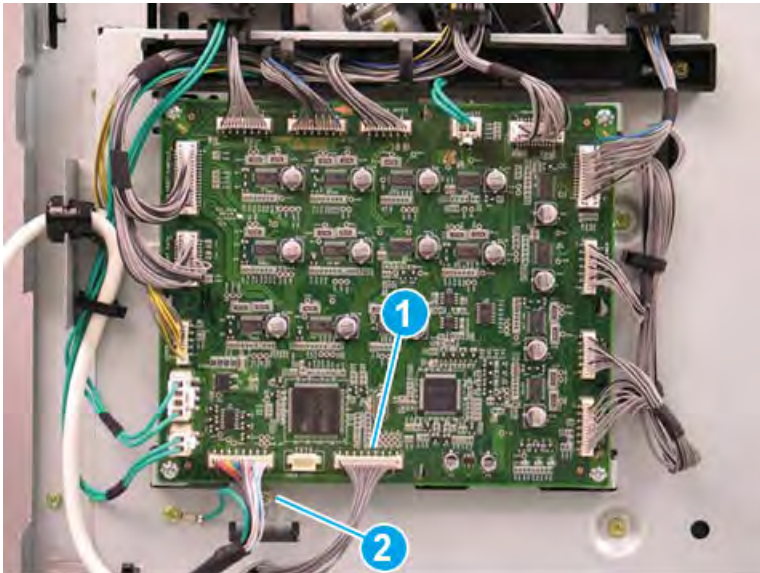
1. Slide the booklet maker away from the finisher.

Figure 5-1633 Slide the booklet maker away from the finisher



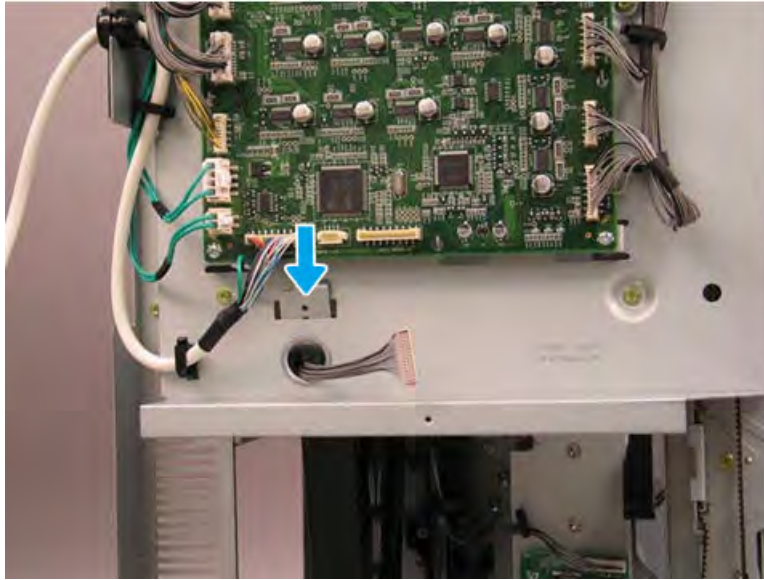
2. At the Disconnect one connector (callout 1), and then remove one screw (callout 2).

Figure 5-1634 Disconnect one connector and remove one screw



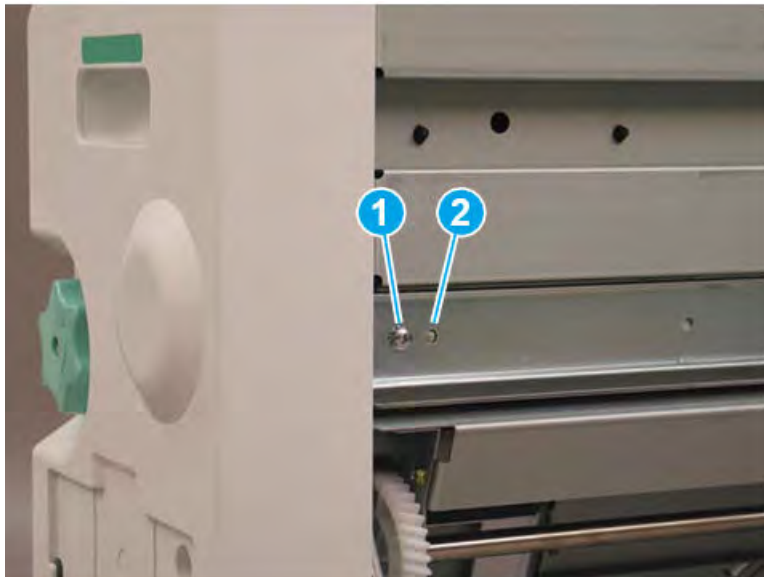
3. Release the metal bracket through the opening in the sheet metal.

Figure 5-1635 Release the metal bracket



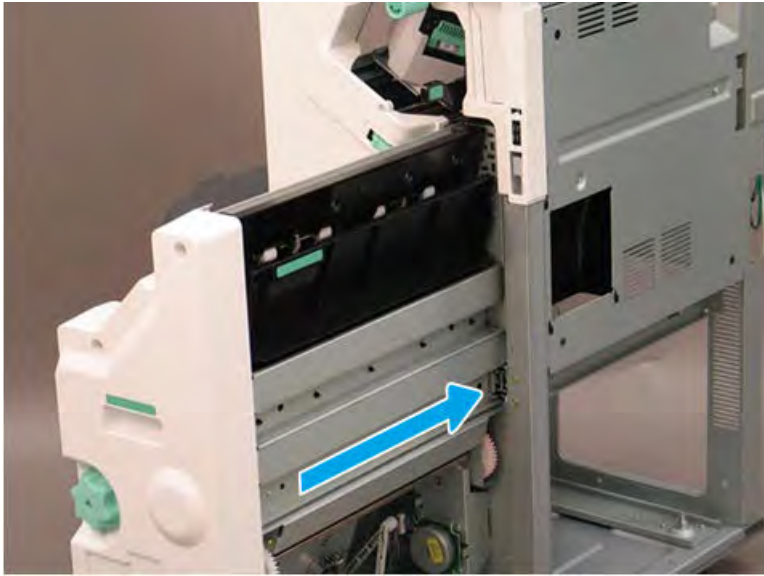
4. Remove one star-washer screw (callout 1), and then release the alignment pin (callout 2) on the right side of the booklet maker.

Figure 5-1636 Remove one screw



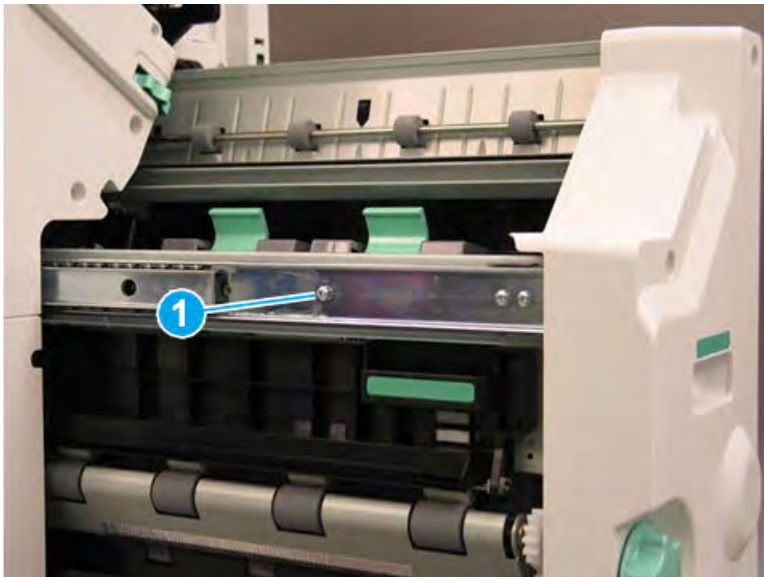
5. Slide the right rail toward the finisher.

Figure 5-1637 Slide the right rail



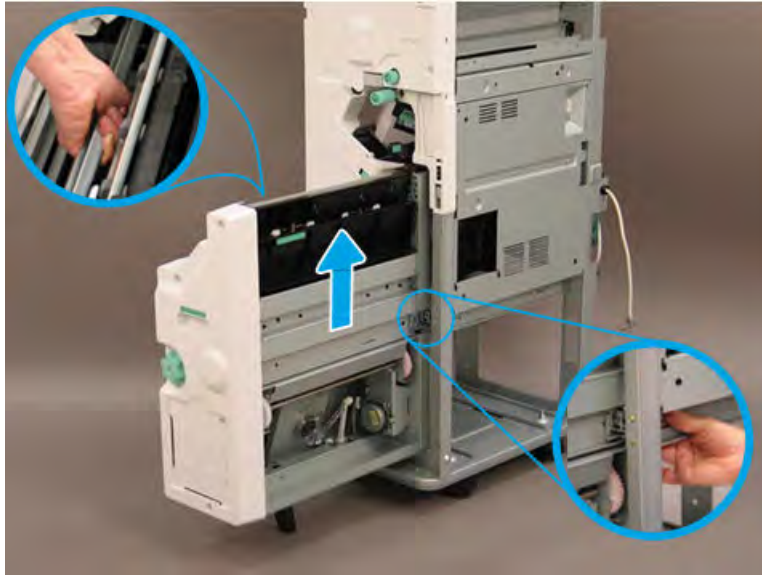
6. Remove one star-washer screw (callout 1) on the left side of the booklet maker.

Figure 5-1638 Remove one screw



7. Lift the booklet maker up on the left side while squeezing the right rail away from the finisher slightly to clear the sheet metal. Remove the booklet maker.

**Figure 5-1639** Remove the booklet maker



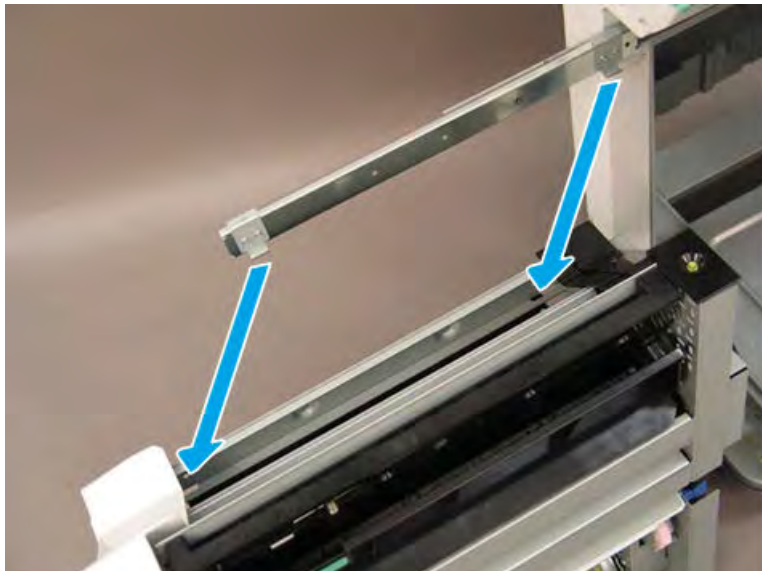
8. Reverse the removal steps to install the assembly. Also use the following special installation instructions.

 **NOTE:** Continue to reverse the removal steps to finish installing the assembly.

**Special installation instructions: booklet maker**

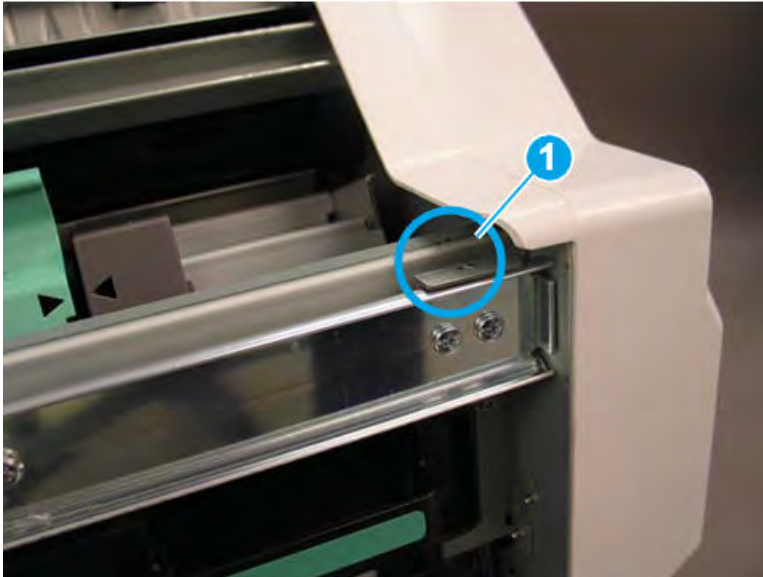
When installing the booklet maker, position the hooks on the rail under the slots on the booklet maker.

**Figure 5-1640** Position the hooks



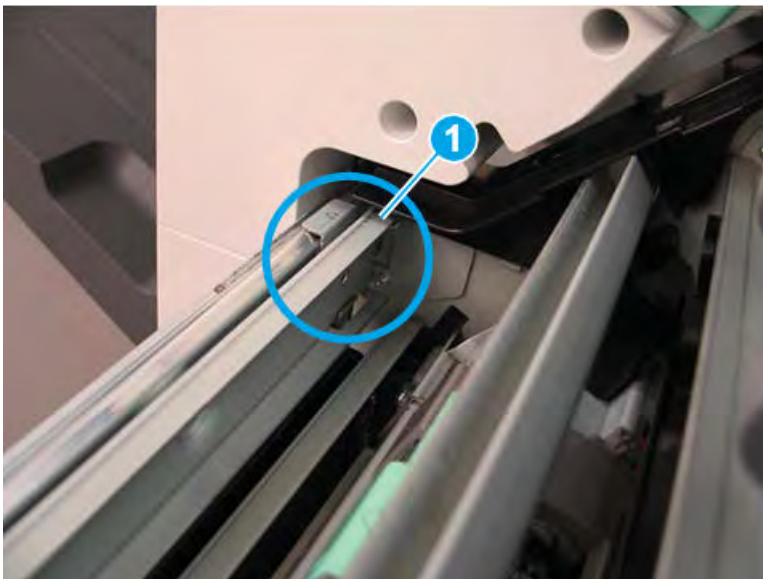
9. When installed correctly, the arrow on the front of the booklet maker aligns with the arrow on the finisher rail.

Figure 5-1641 Align arrows



10. When installed correctly, the arrow on the back of the booklet maker aligns with the arrow on the finisher rail.

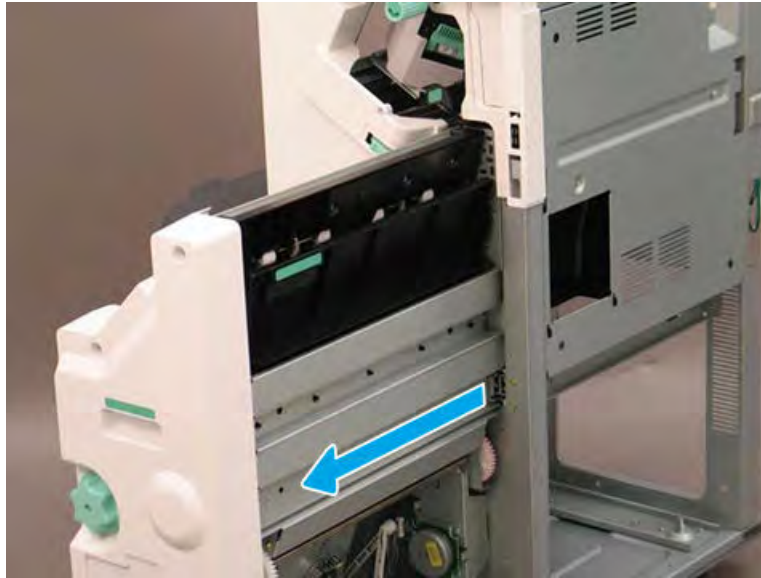
Figure 5-1642 Align arrows





11. Extend the right rail away from the finisher and position it in the booklet maker slot.

Figure 5-1643 Extend the right rail



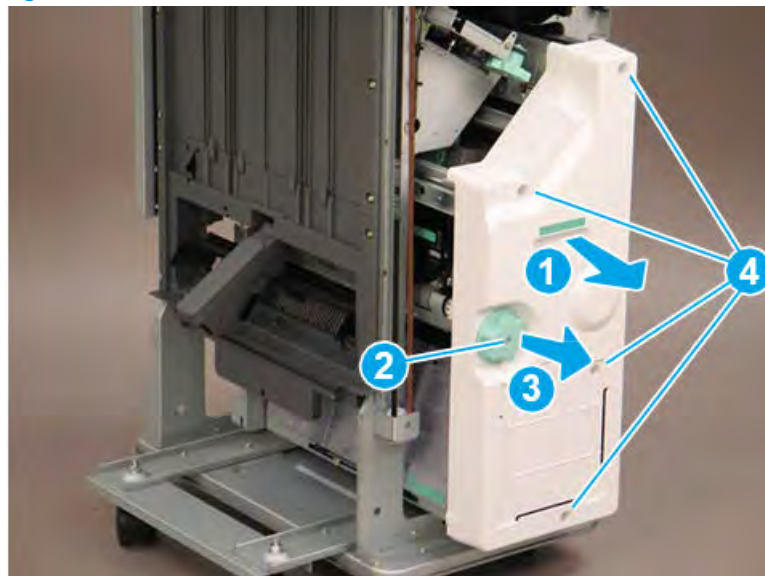
#### Remove the booklet front cover

Follow these steps to remove the booklet front cover.

- ▲ Slide the booklet maker slightly away from the finisher (callout 1). Remove one screw (callout 2), and then slide the green knob away from the booklet maker to remove it (callout 3). Remove four screws (callout 4), and then remove the booklet front cover.

💡 **TIP:** Reverse the removal steps to install the assembly

Figure 5-1644 Remove five screws and the cover

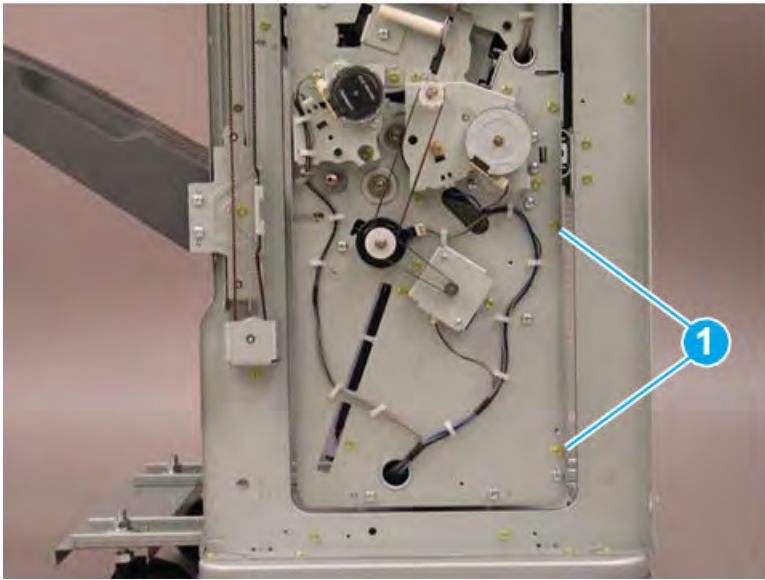


#### Remove the booklet right lower shield

Follow these steps to remove the booklet right lower shield.

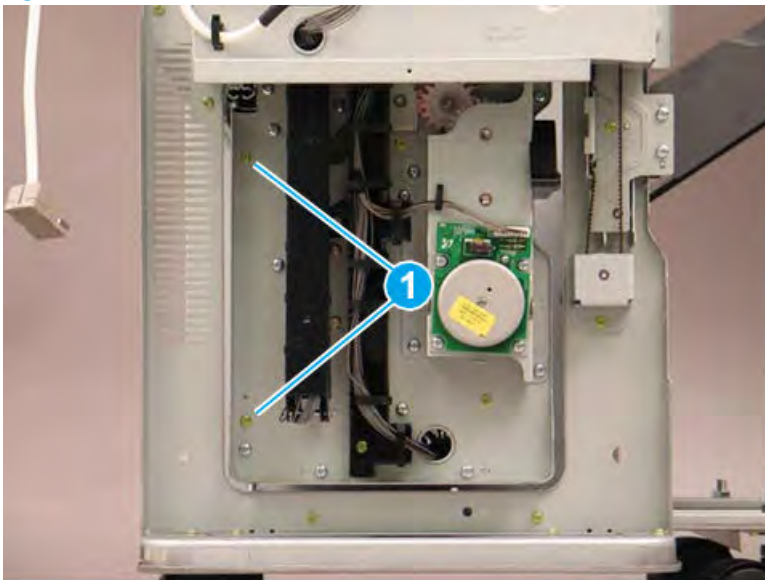
1. Remove two screws at the front of the booklet maker (callout 1).

Figure 5-1645 Remove two screws



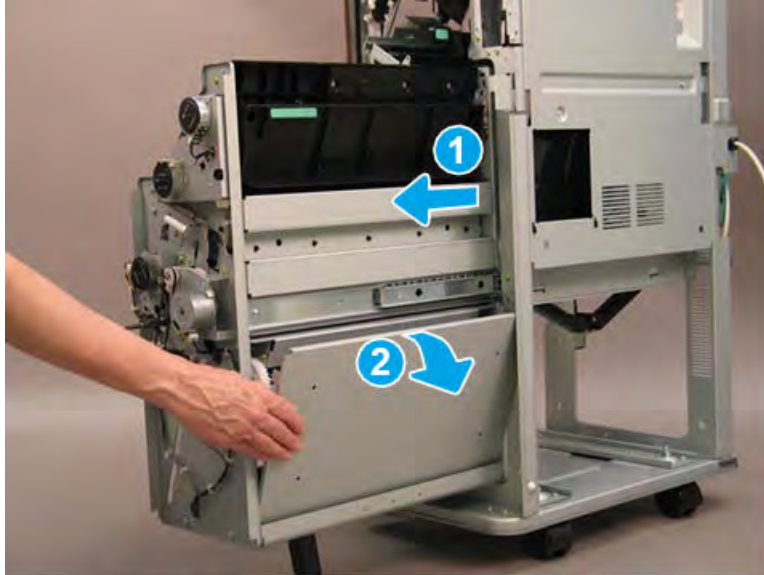
2. Remove two screws at the back of the booklet maker (callout 1).

Figure 5-1646 Remove two screws



3. Slide the booklet maker out of the finisher (callout 1), and then rotate the top of the right lower shield (callout 2) away from the booklet maker to remove it.

Figure 5-1647 Remove the right lower shield

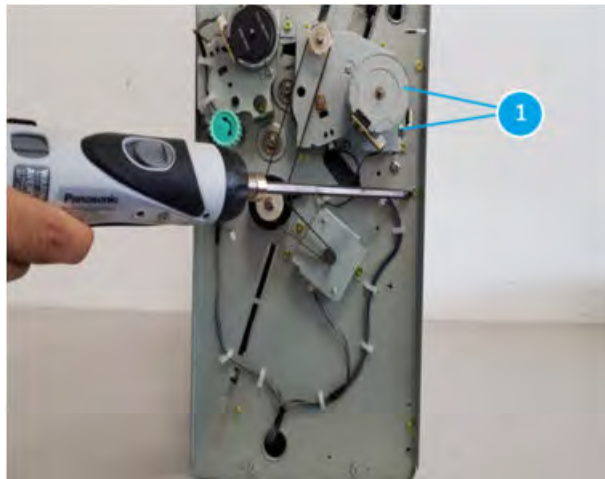


#### Remove the booklet maker middle right shield

Follow these steps to remove the booklet maker middle right shield.

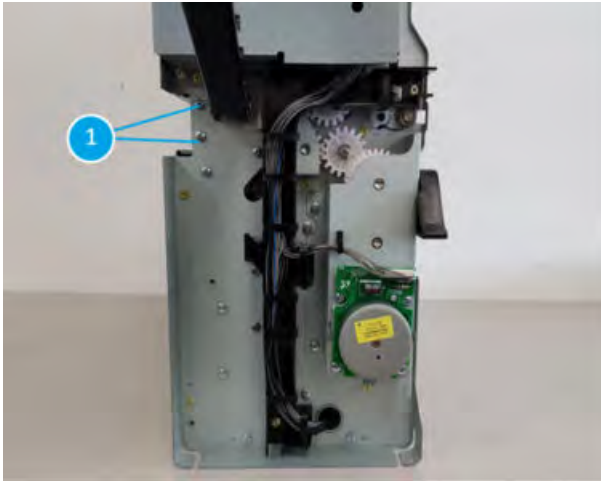
1. Remove two screws at the front of the booklet maker (callout 1).

Figure 5-1648 Remove two screws at the front of the booklet maker



2. Remove two screws at the back of the booklet maker (callout 1).

**Figure 5-1649** Remove two screws at the back of the booklet maker



### Remove the booklet finisher upper right shield

Follow these steps to remove the booklet finisher upper right shield.

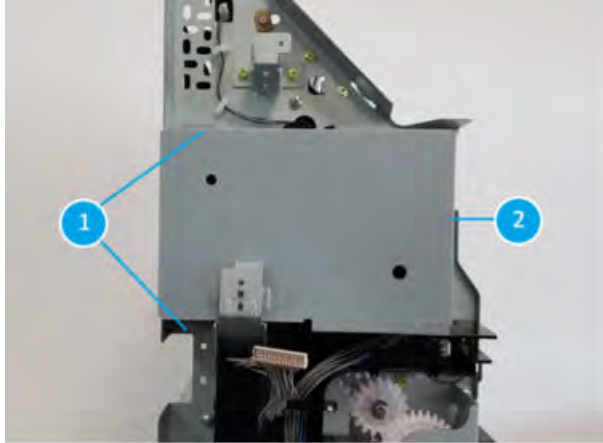
1. Remove two screws at the front of the booklet maker (callout 1)

**Figure 5-1650** Remove two screws at the front of the booklet maker



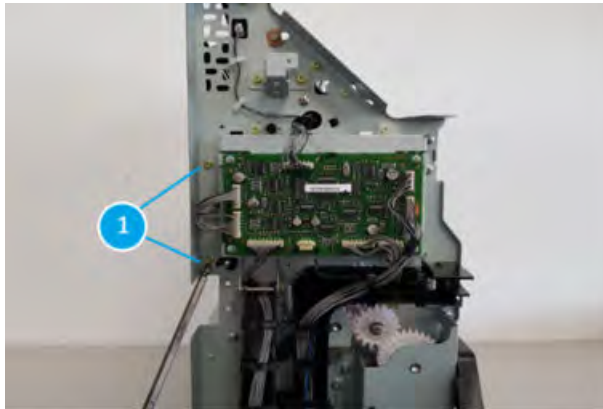
2. Remove two screws(callout 1) and one screw(callout 2) at the back of the booklet maker and then remove the board cover.

Figure 5-1651 Remove the board cover



3. Remove two screws at the back of the booklet maker (callout 1).

Figure 5-1652 Remove two screws



4. Disconnect one connector at the front of the booklet maker (callout 1).

Figure 5-1653 Disconnect one connector



5. Disconnect one connector at the right of the booklet maker (callout 1).

**Figure 5-1654** Disconnect one connector



### Remove the booklet tamper and fold unit

Follow these steps to remove the booklet tamper and fold unit.

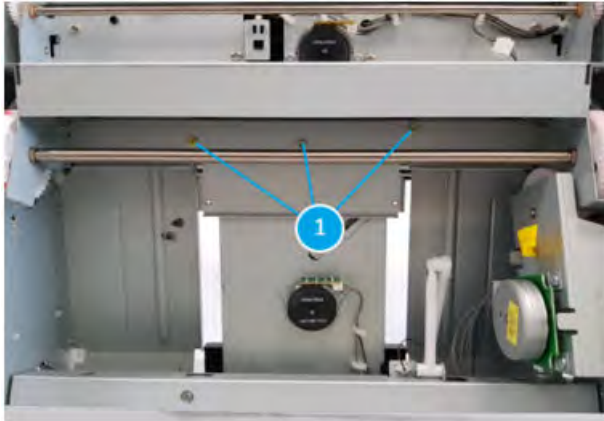
1. Remove two screws at the left of the booklet maker (callout 1).

**Figure 5-1655** Remove two screws at the left of the booklet maker



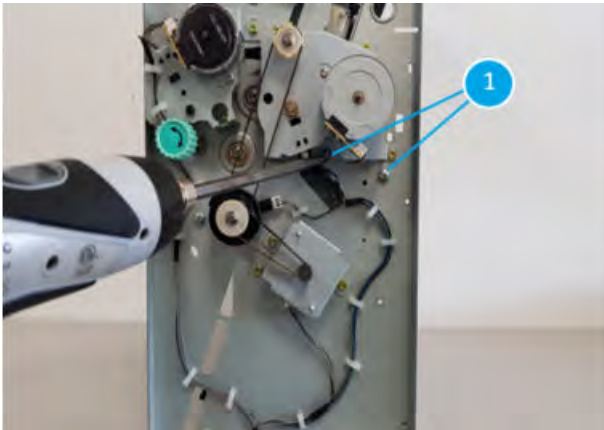
2. Remove three screws at the right of the booklet maker (callout 1).

Figure 5-1656 Remove three screws at the right of the booklet maker



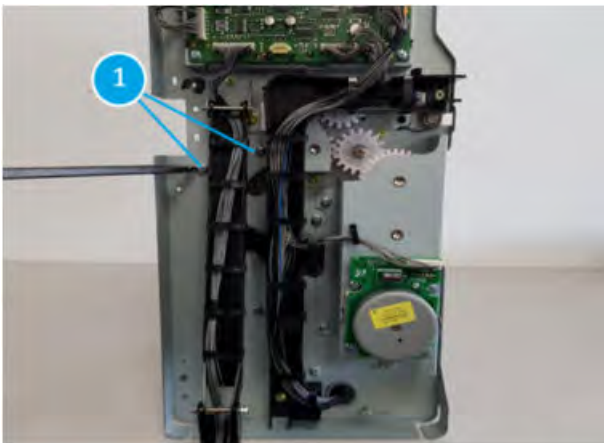
3. Remove two screws at the front of the booklet maker (callout 1).

Figure 5-1657 Remove two screws at the front of the booklet maker



4. Remove two screws at the back of the booklet maker (callout 1).

Figure 5-1658 Remove two screws at the back of the booklet maker



5. Disconnect one connector at the right of the booklet maker (callout 1).

Figure 5-1659 Disconnect one connector

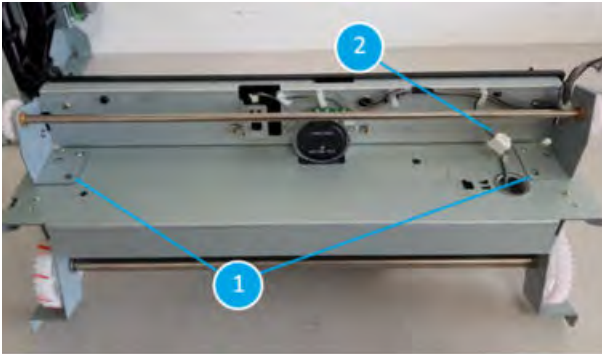


### Remove the booklet tamper unit

Follow these steps to remove the booklet tamper unit.

1. Remove two screws and disconnect one connector (callout 2)

Figure 5-1660 Remove two screws



2. Booklet tamper unit (callout 1)

Figure 5-1661 Booklet tamper unit



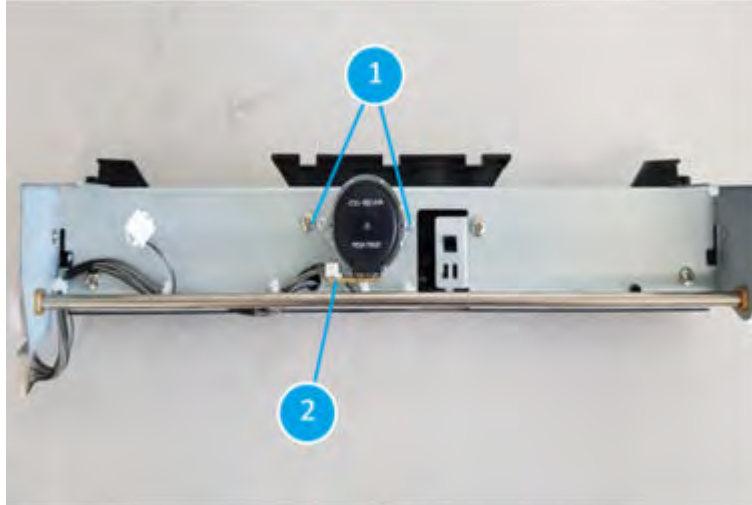
### Remove the booklet tamper motor (M23)

Follow these steps to remove the booklet tamper motor (M23).

1. Remove two screws (callout 1) and unplug one connector (callout 2)

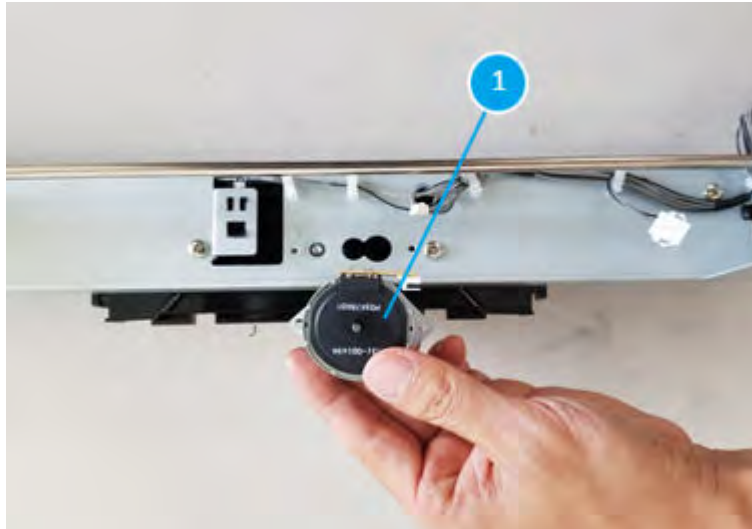


Figure 5-1662 Remove two screws and unplug one connector



2. Remove the booklet tamper motor (M23, callout 1)

Figure 5-1663 Remove the booklet tamper motor



### Unpack the replacement assembly

Follow these steps to unpack the replacement assembly.

1. Dispose of the defective part.

---

 **NOTE:** HP recommends responsible disposal of the defective part.

<http://www8.hp.com/us/en/hp-information/environment/product-recycling.html>

---

2. Unpack the replacement part from the packaging.


 **CAUTION:**  Some parts are sensitive to electrostatic discharge (ESD). Always perform service work at an ESD-protected workstation or mat. If an ESD workstation or mat is not available, touch the sheet-metal chassis to provide a static ground before touching an ESD-sensitive assembly. Protect the ESD-sensitive assemblies by placing them in ESD pouches when they are out of the printer.

 **IMPORTANT:** Make sure that all of the shipping materials (for example shipping tape) are removed from the replacement part prior to installation.

 **NOTE:** If the replacement part is a roller or pad, avoid touching the spongy part of it. Skin oils on the roller or pad can cause paper pickup and/or print-quality problems. HP recommends using disposable gloves when handling rollers or pads or washing your hands before touching rollers or pads.

---

3. To install an assembly, reverse the removal steps.

 **NOTE:** When applicable, special installation instructions are provided for an assembly at the end of the removal procedure. Always completely read the removal instructions and follow all special installation instructions.

---


## Booklet stapler unit

## Removal and replacement: Booklet stapler unit

Learn how to remove and replace the tray booklet stapler unit.

### Introduction

This document provides the procedures to remove and replace the booklet stapler unit on the finisher.

 **IMPORTANT:** When applicable, special installation instructions are provided for an assembly at the end of the removal procedure. Always completely read the removal instructions and follow all special installation instructions.

### Before performing service

- Turn the printer power off. A shutting-down message appears on the control-panel display.
- ⚠ **WARNING!** To avoid damage to the printer, turn the power off and wait until the printer shuts down before removing the power cable.
- Disconnect the printer power cable after the printer has completely shut down (the control-panel display is blank).
- Release the finisher from the printer by pulling out on the release latch inside the finisher door.
- Disconnect the cable from the bridge unit to the finisher.
- Disconnect the cable from the finisher to the printer.

Use the table below to identify the correct part number for your printer. To order the part, go to <https://parts.hp.com>.

**Table 5-157 Part information**

Part number	Part description
JCB1-08274B	Booklet stapler unit

### Required tools

- #2 JIS screwdriver with a magnetic tip

### After performing service

- Connect the cable from the finisher to the printer.
- Connect the cable from the bridge unit to the finisher.
- Attach the finisher to the printer, and then push in on the release latch inside the finisher door.
- Connect the printer power cable.
- Turn the printer power on.

### Post service test

Process a job through the finisher and verify that the finisher works correctly.

### Remove the right upper cover (finisher)

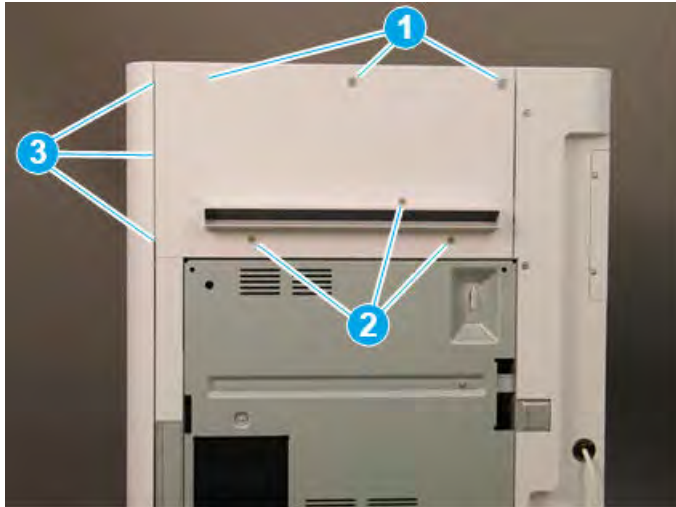
Follow these steps to remove the right upper cover (finisher).

- ▲ Remove one screw cap and three machine screws on the upper edge of the cover (callout 1). Remove three sheet metal screws (callout 2) on the lower portion of the cover. Rotate the right edge of the cover away from the finisher, and then slide the cover right to release three tabs (callout 3).

💡 **TIP:** The lower screws are shorter in length than the upper screws.

**TIP:** Reverse the removal steps to install the assembly.

Figure 5-1664 Remove the right upper cover

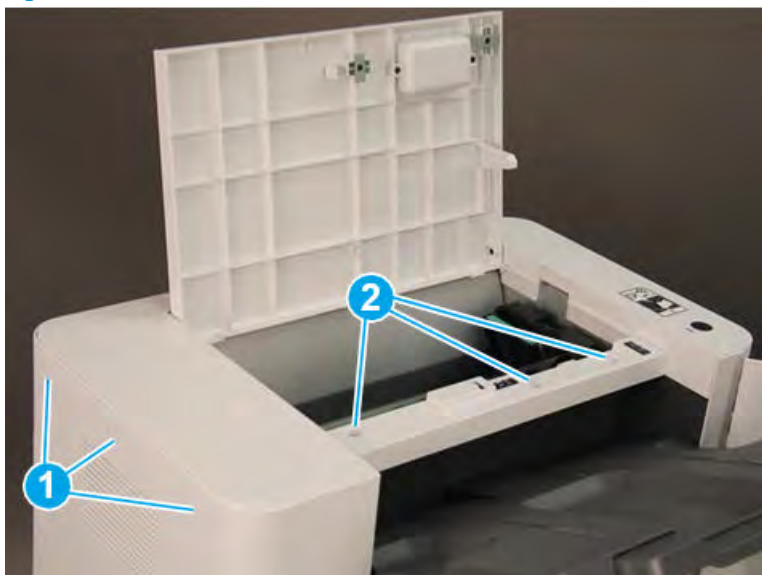


### Remove the top cover (finisher)

Follow these steps to remove the top cover (finisher).

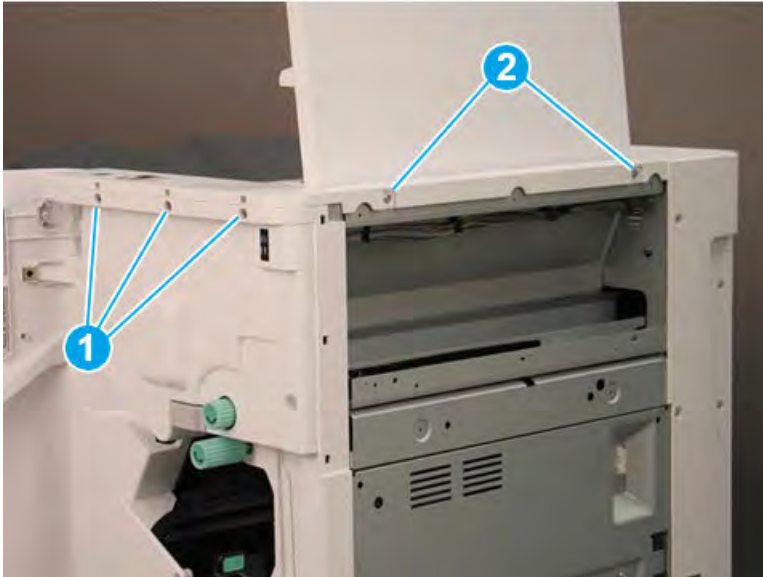
1. Remove three screw caps and three self-tapping screws at the top of the rear cover (callout 1), and then remove three machine screws (callout 2) on top of the cover.

Figure 5-1665 Remove six screws




2. Remove three self-tapping screws at the top of the front cover (callout 1), and then remove two machine screws (callout 2) at the top of the right side.

Figure 5-1666 Remove five screws



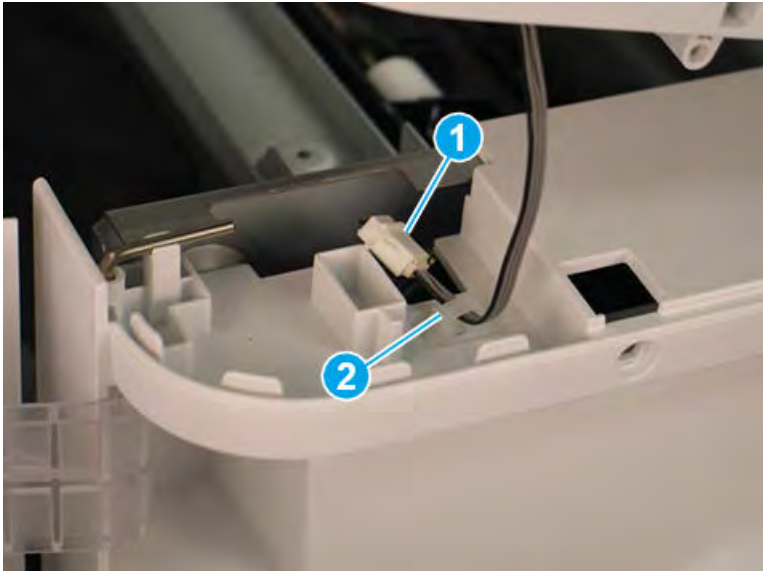
3. Lift the cover up slightly. Disconnect one in-line connector (callout 1), and then release one retainer (callout 2).

---

 **TIP:** Reverse the removal steps to install the assembly.

---

Figure 5-1667 Disconnect one connector and release retainer

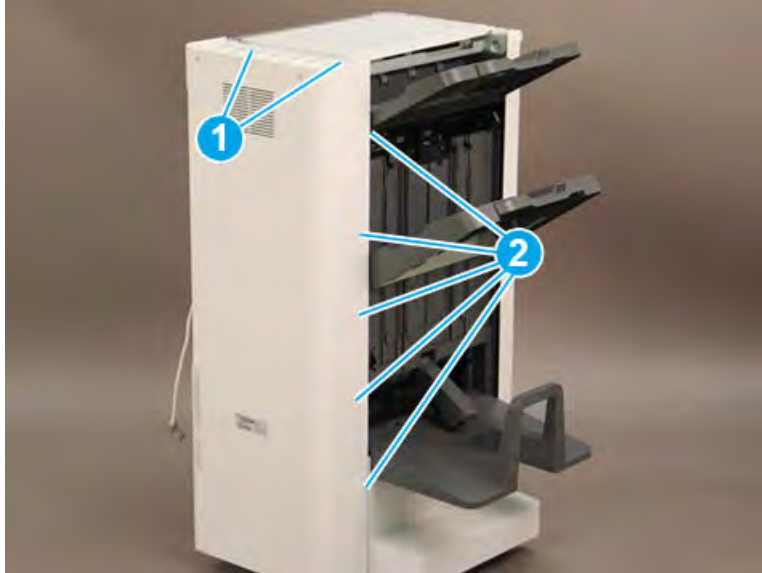


### Remove the rear cover (finisher)

Follow these steps to remove the rear cover (finisher).

1. Remove two self-tapping screws (callout 1) on the top of the rear cover, and then remove five screw caps and five machine screws (callout 2) on the left side of the cover.

Figure 5-1668 Remove seven screws



2. Remove one screw cap and four machine screws (callout 1) Remove the rear cover.

 **NOTE:** Make sure to thread the power cable (callout 2) through the opening in the cover.


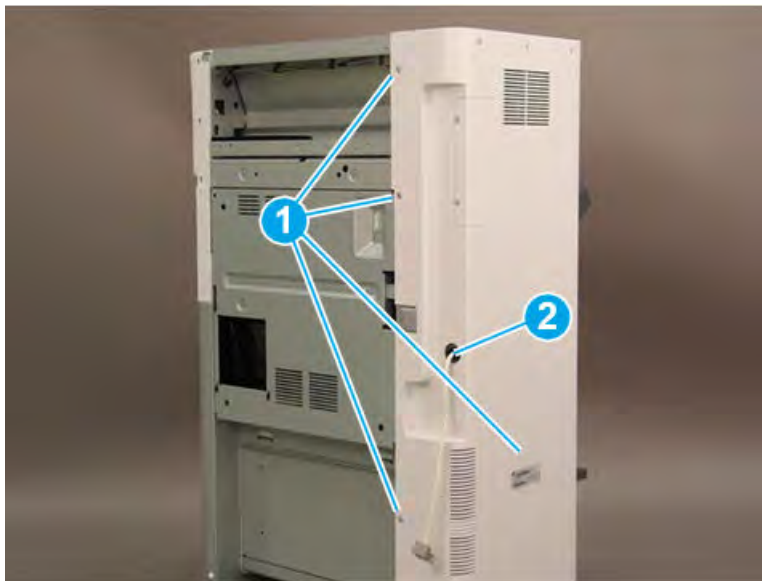
 **TIP:** Reverse the removal steps to install the assembly

Figure 5-1669 Remove the rear cover



### Remove the booklet maker

Follow these steps to remove the booklet maker.

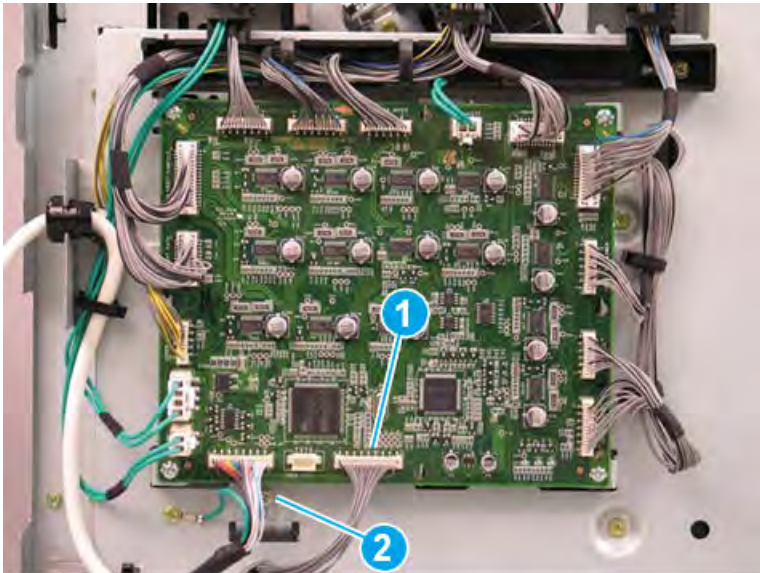
1. Slide the booklet maker away from the finisher.

Figure 5-1670 Slide the booklet maker away from the finisher



2. At the Disconnect one connector (callout 1), and then remove one screw (callout 2).

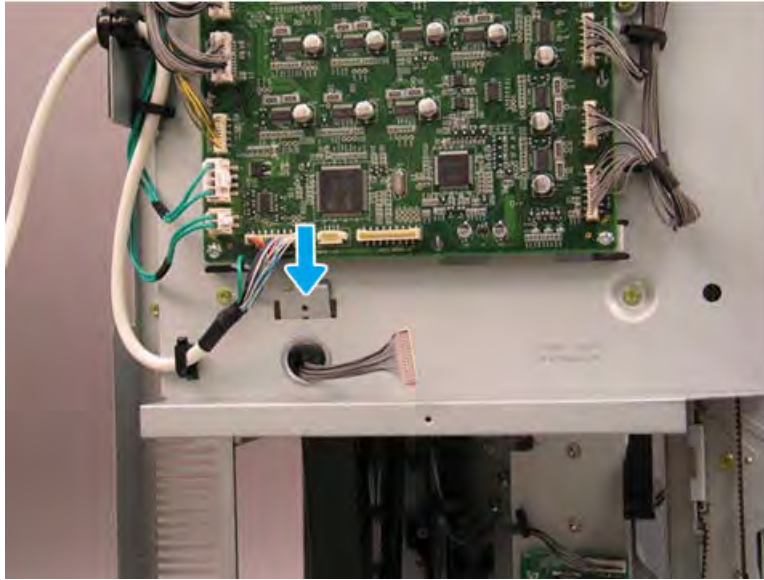
Figure 5-1671 Disconnect one connector and remove one screw





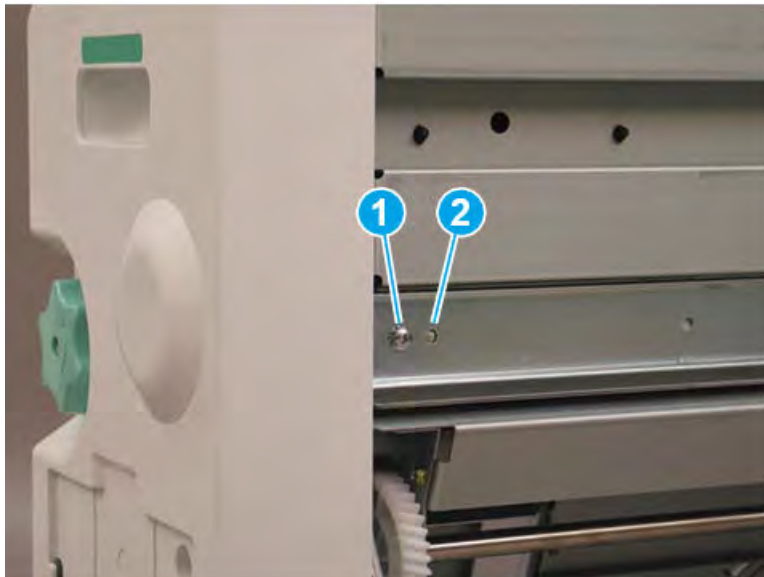
3. Release the metal bracket through the opening in the sheet metal.

Figure 5-1672 Release the metal bracket



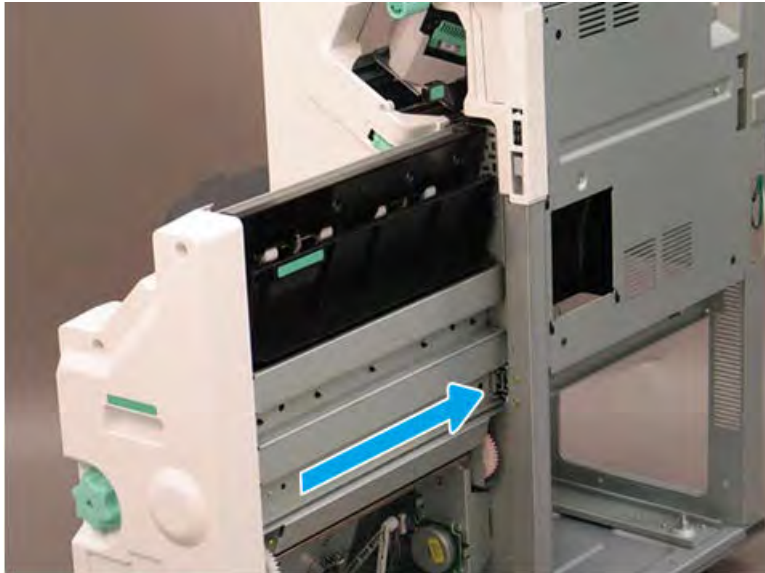
4. Remove one star-washer screw (callout 1), and then release the alignment pin (callout 2) on the right side of the booklet maker.

Figure 5-1673 Remove one screw



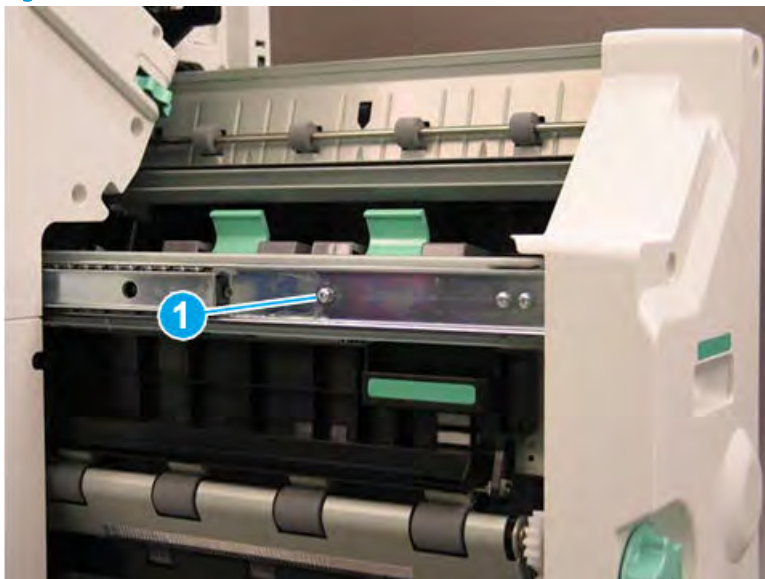
5. Slide the right rail toward the finisher.

Figure 5-1674 Slide the right rail



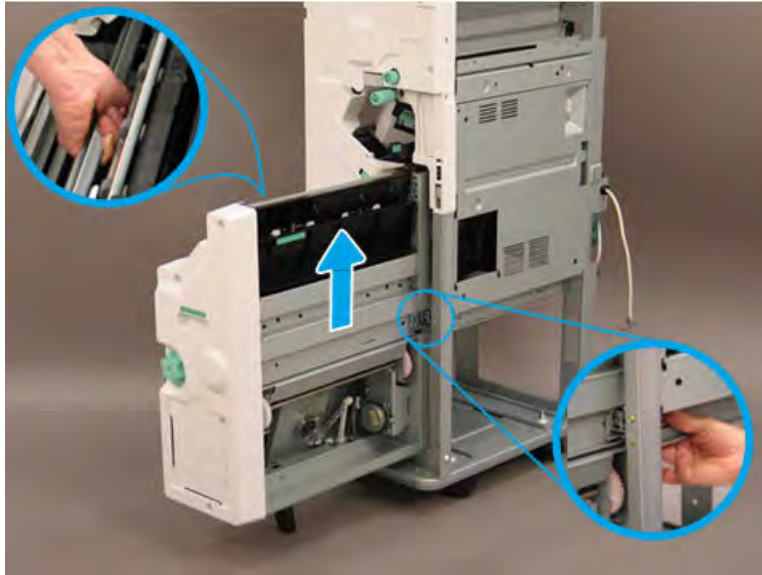
6. Remove one star-washer screw (callout 1) on the left side of the booklet maker.

Figure 5-1675 Remove one screw



7. Lift the booklet maker up on the left side while squeezing the right rail away from the finisher slightly to clear the sheet metal. Remove the booklet maker.

**Figure 5-1676** Remove the booklet maker



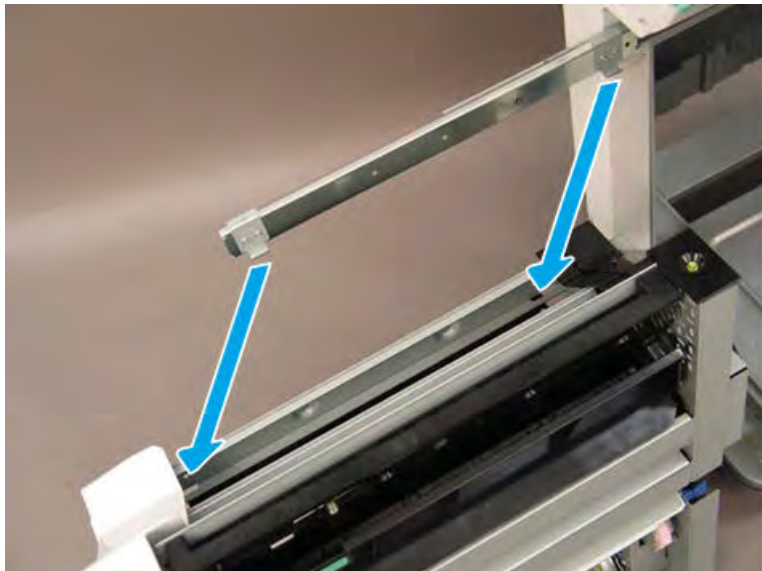
8. Reverse the removal steps to install the assembly. Also use the following special installation instructions.

 **NOTE:** Continue to reverse the removal steps to finish installing the assembly.

**Special installation instructions: booklet maker**

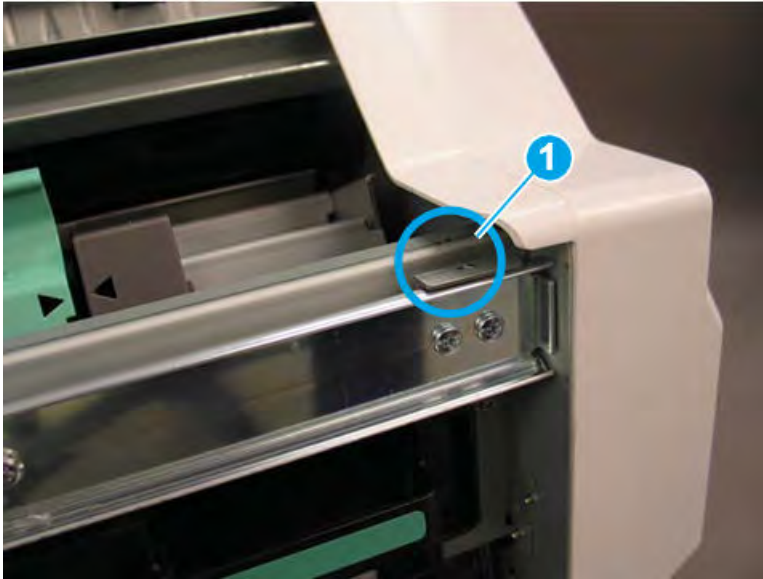
When installing the booklet maker, position the hooks on the rail under the slots on the booklet maker.

**Figure 5-1677** Position the hooks



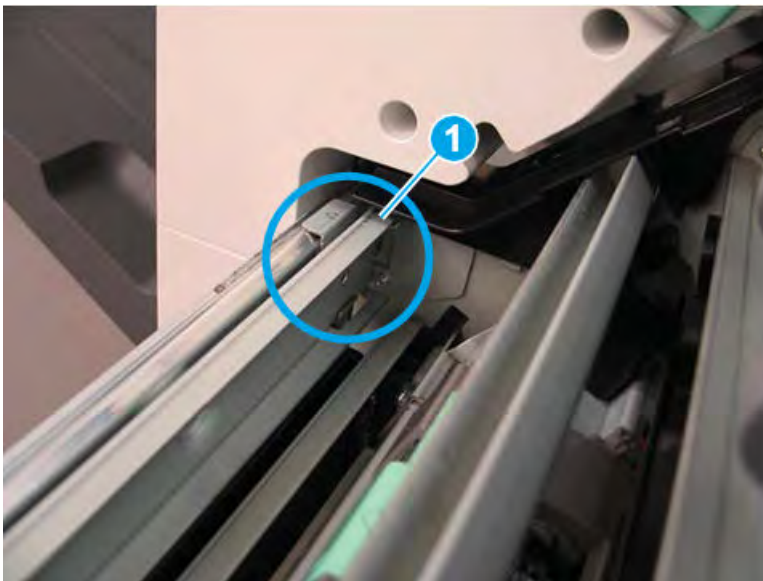
9. When installed correctly, the arrow on the front of the booklet maker aligns with the arrow on the finisher rail.

Figure 5-1678 Align arrows



10. When installed correctly, the arrow on the back of the booklet maker aligns with the arrow on the finisher rail.

Figure 5-1679 Align arrows



11. Extend the right rail away from the finisher and position it in the booklet maker slot.

Figure 5-1680 Extend the right rail



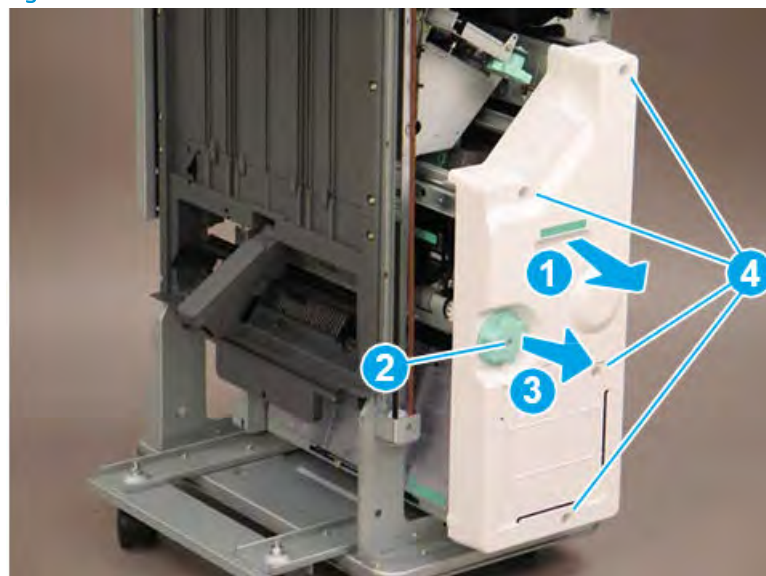
#### Remove the booklet front cover

Follow these steps to remove the booklet front cover.

- ▲ Slide the booklet maker slightly away from the finisher (callout 1). Remove one screw (callout 2), and then slide the green knob away from the booklet maker to remove it (callout 3). Remove four screws (callout 4), and then remove the booklet front cover.

 **TIP:** Reverse the removal steps to install the assembly

Figure 5-1681 Remove five screws and the cover

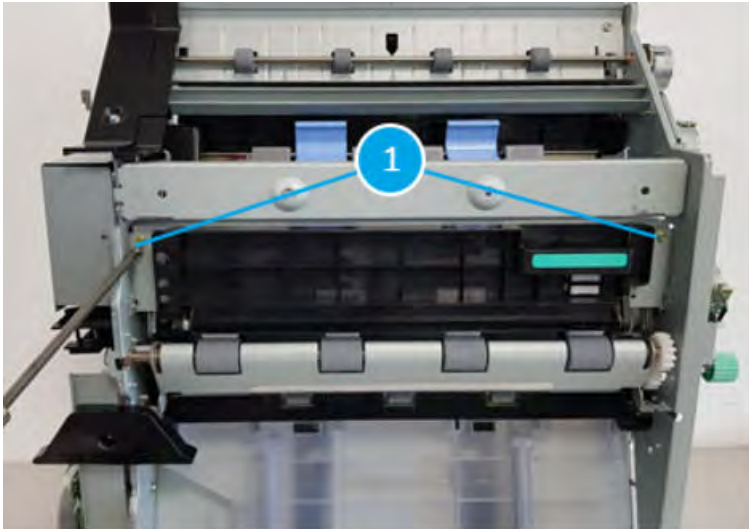


#### Remove the Booklet c-fold blade unit

Follow these steps to remove the Booklet c-fold blade unit.

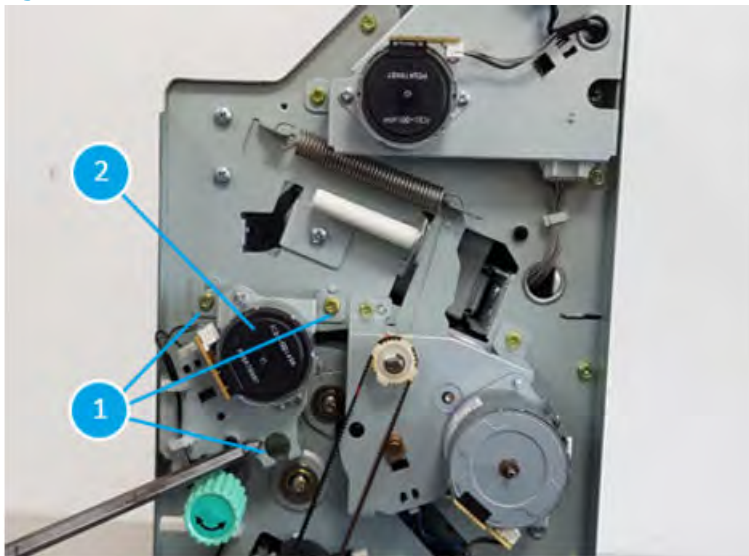
1. Remove two screws(callout 1) at the left of the booklet maker

Figure 5-1682 Remove two screws at the left of the booklet maker



2. Remove three screws(callout 1) at the front of the booklet maker to remove motor unit(callout 2) to reach out to the screw.

Figure 5-1683 Remove three screws to remove motor unit to reach out to the screw



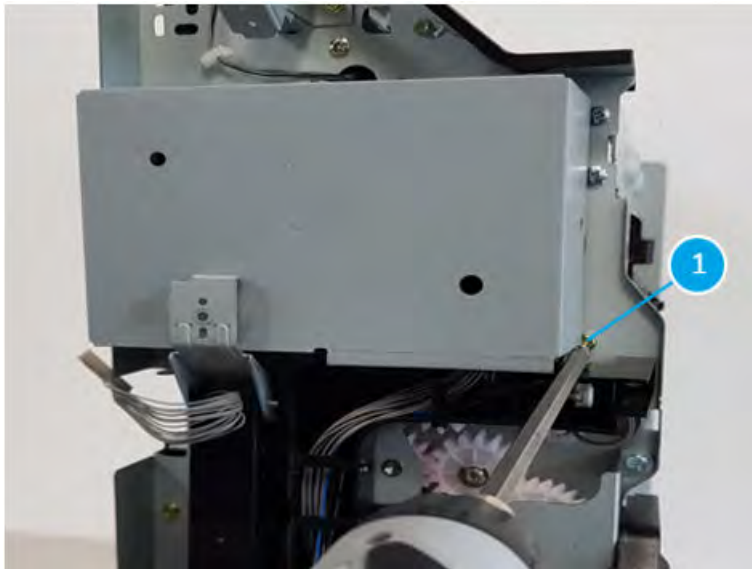
3. Remove one screw(callout 1) at the front of the booklet maker.

Figure 5-1684 Remove one screw at the front of the booklet maker



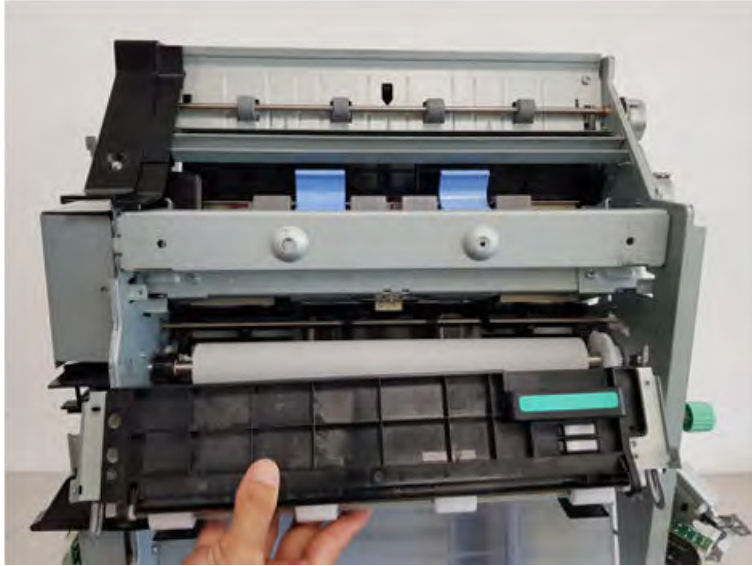
4. Remove one screw(callout 1) at the rear of the booklet maker.

Figure 5-1685 Remove one screw at the rear of the booklet maker



5. Take the booklet c-fold blade unit out from the booklet maker.

**Figure 5-1686** Take the booklet c-fold blade unit out from the booklet maker

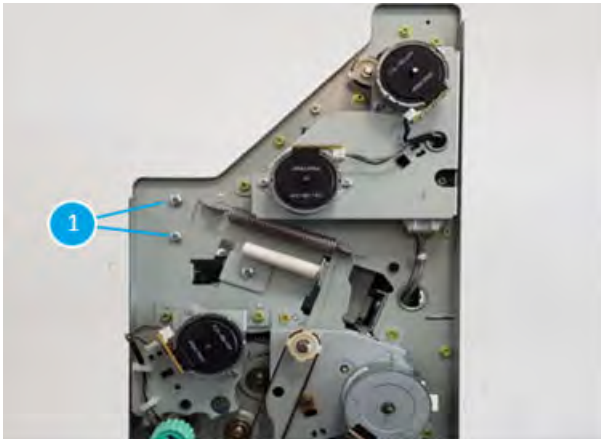


#### Remove the booklet stapler unit

Follow these steps to remove the booklet stapler unit.

1. Remove two screws (callout 1) at the front of the booklet maker.

**Figure 5-1687** Remove two screws





2. Remove two screws (callout 1) at the rear of the booklet maker.

Figure 5-1688 Remove two screws



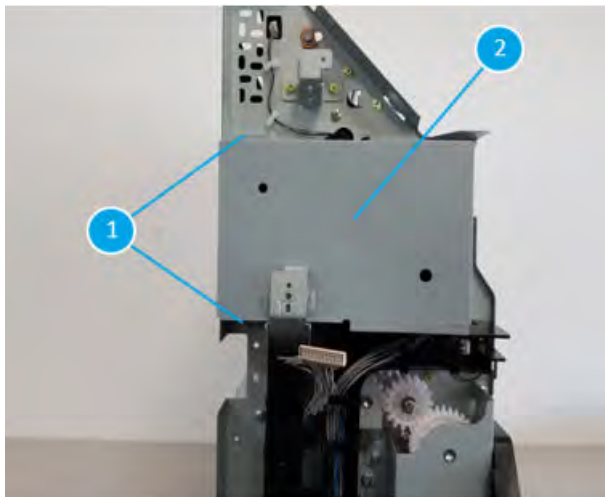
3. Remove the metal frame (callout 1)

Figure 5-1689 Remove the metal frame



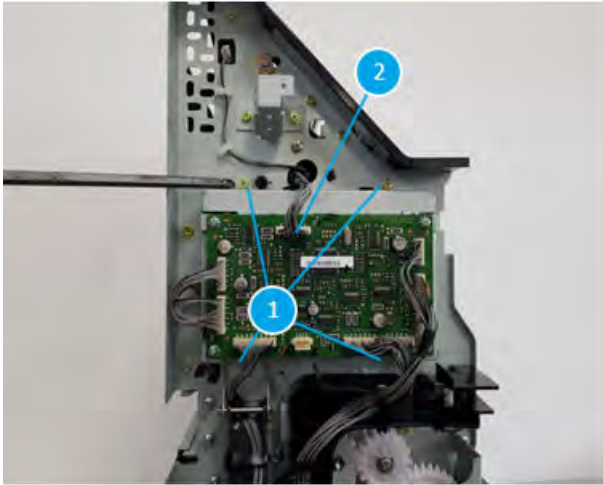
4. Remove two screws (callout 1) at the rear of the booklet maker to remove the board cover (callout 2)

Figure 5-1690 Remove the board cover



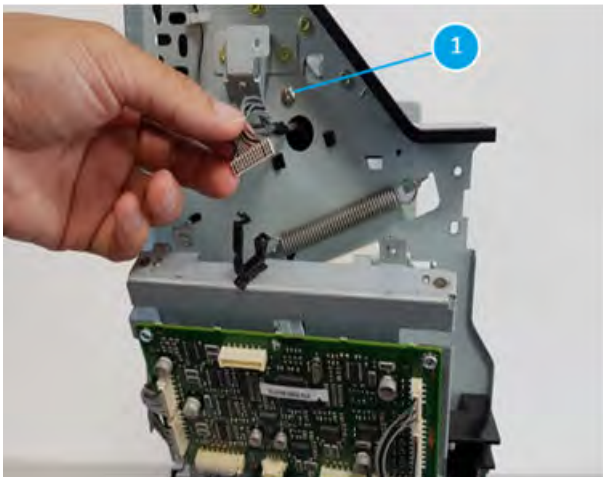
5. Remove four screws (callout 1) and unplug the connector (callout 2) at the rear of the booklet maker.

Figure 5-1691 Remove four screws and unplug the connector



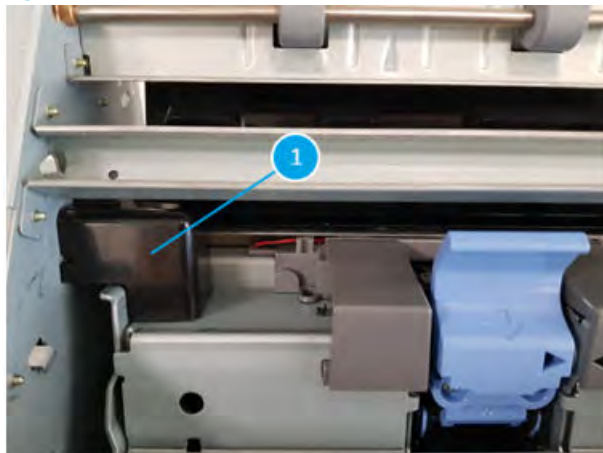
6. Remove one screw (callout 1).

Figure 5-1692 Remove one screw



7. Remove the connector cover (callout 1).

Figure 5-1693 Remove the connector cover



8. Remove one screw(callout 1) at the front of the booklet maker.

Figure 5-1694 Remove one screw



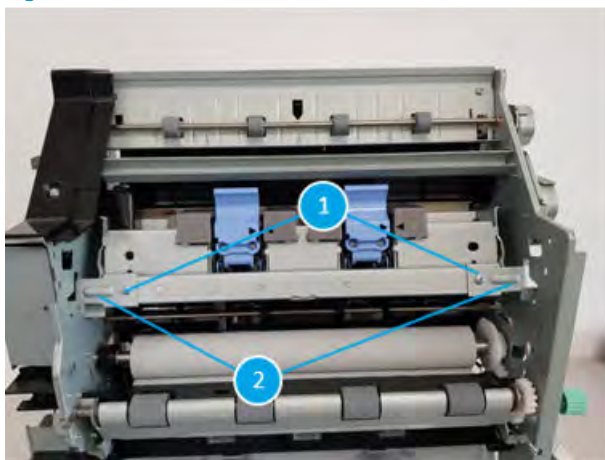
9. Remove one screw(callout 1) at the rear of the booklet maker.

Figure 5-1695 Remove one screw



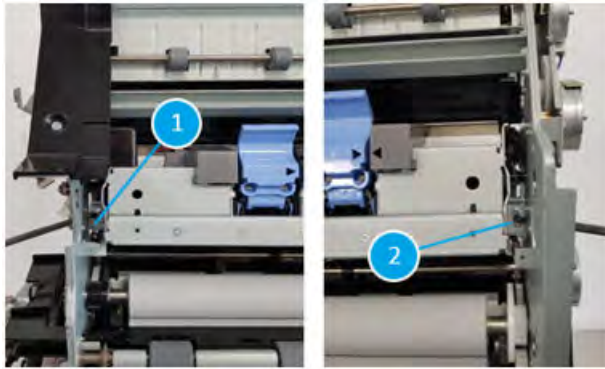
10. Remove two screws (callout 1) at the left of the booklet maker and pull the metal bracket (callout 2) out each side.

Figure 5-1696 Remove two screws



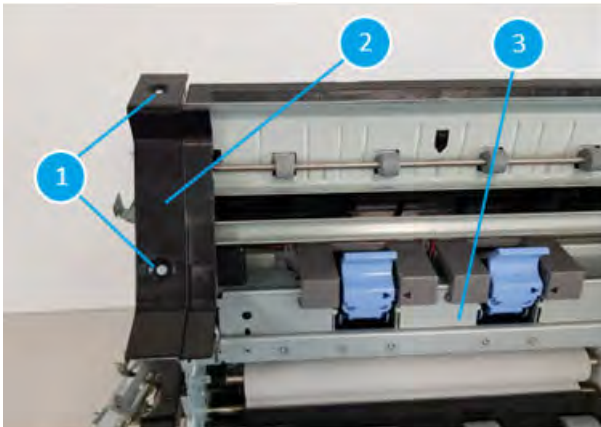
11. Remove one screw(callout 1) and remove one screw(callout 2) (Remove two screws each side)

Figure 5-1697 Remove two screws each side



12. Remove two screws (callout 1) and remove the black cover (callout 2) and pull the stapler unit (callout 3) out

Figure 5-1698 Pull the stapler unit



### Unpack the replacement assembly

Follow these steps to unpack the replacement assembly.

1. Dispose of the defective part.



---

 **NOTE:** HP recommends responsible disposal of the defective part.


<http://www8.hp.com/us/en/hp-information/environment/product-recycling.html>

---

2. Unpack the replacement part from the packaging.


 **CAUTION:**  Some parts are sensitive to electrostatic discharge (ESD). Always perform service work at an ESD-protected workstation or mat. If an ESD workstation or mat is not available, touch the sheet-metal chassis to provide a static ground before touching an ESD-sensitive assembly. Protect the ESD-sensitive assemblies by placing them in ESD pouches when they are out of the printer.

 **IMPORTANT:** Make sure that all of the shipping materials (for example shipping tape) are removed from the replacement part prior to installation.

 **NOTE:** If the replacement part is a roller or pad, avoid touching the spongy part of it. Skin oils on the roller or pad can cause paper pickup and/or print-quality problems. HP recommends using disposable gloves when handling rollers or pads or washing your hands before touching rollers or pads.

---

3. To install an assembly, reverse the removal steps.

 **NOTE:** When applicable, special installation instructions are provided for an assembly at the end of the removal procedure. Always completely read the removal instructions and follow all special installation instructions.

---


## Booklet fold unit

## Removal and replacement: Booklet blade

Learn how to remove and replace the tray booklet blade.

### Introduction

This document provides the procedures to remove and replace the booklet blade on the finisher.

 **IMPORTANT:** When applicable, special installation instructions are provided for an assembly at the end of the removal procedure. Always completely read the removal instructions and follow all special installation instructions.

### Before performing service

- Turn the printer power off. A shutting-down message appears on the control-panel display.
- ⚠ **WARNING!** To avoid damage to the printer, turn the power off and wait until the printer shuts down before removing the power cable.
- Disconnect the printer power cable after the printer has completely shut down (the control-panel display is blank).
- Release the finisher from the printer by pulling out on the release latch inside the finisher door.
- Disconnect the cable from the bridge unit to the finisher.
- Disconnect the cable from the finisher to the printer.

Use the table below to identify the correct part number for your printer. To order the part, go to <https://parts.hp.com>.

**Table 5-158** Part information

Part number	Part description
JC93-01163A	Booklet blade

### Required tools

- #2 JIS screwdriver with a magnetic tip

### After performing service

- Connect the cable from the finisher to the printer.
- Connect the cable from the bridge unit to the finisher.
- Attach the finisher to the printer, and then push in on the release latch inside the finisher door.
- Connect the printer power cable.
- Turn the printer power on.

### Post service test

Process a job through the finisher and verify that the finisher works correctly.

### Remove the right upper cover (finisher)

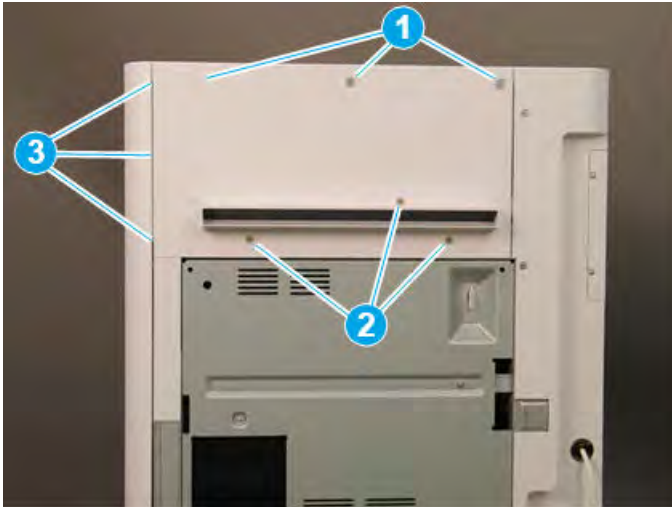
Follow these steps to remove the right upper cover (finisher).

- ▲ Remove one screw cap and three machine screws on the upper edge of the cover (callout 1). Remove three sheet metal screws (callout 2) on the lower portion of the cover. Rotate the right edge of the cover away from the finisher, and then slide the cover right to release three tabs (callout 3).

💡 **TIP:** The lower screws are shorter in length than the upper screws.

**TIP:** Reverse the removal steps to install the assembly.

**Figure 5-1699** Remove the right upper cover

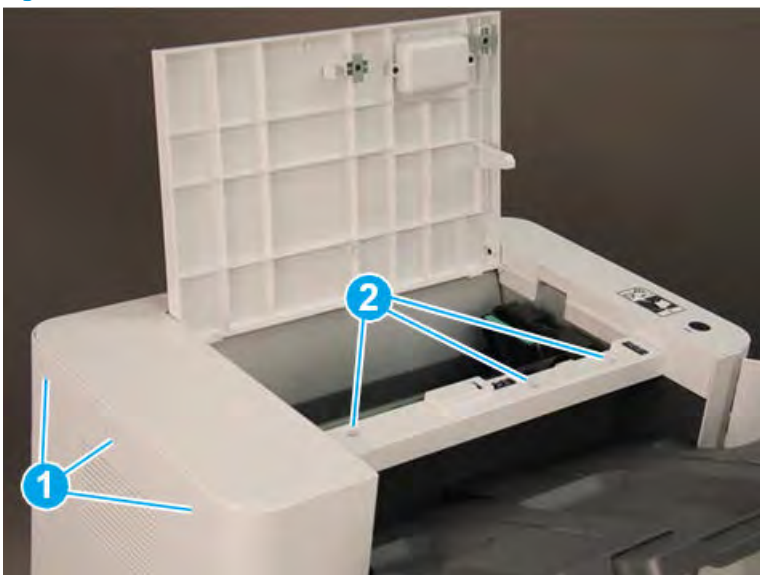


### Remove the top cover (finisher)

Follow these steps to remove the top cover (finisher).

1. Remove three screw caps and three self-tapping screws at the top of the rear cover (callout 1), and then remove three machine screws (callout 2) on top of the cover.

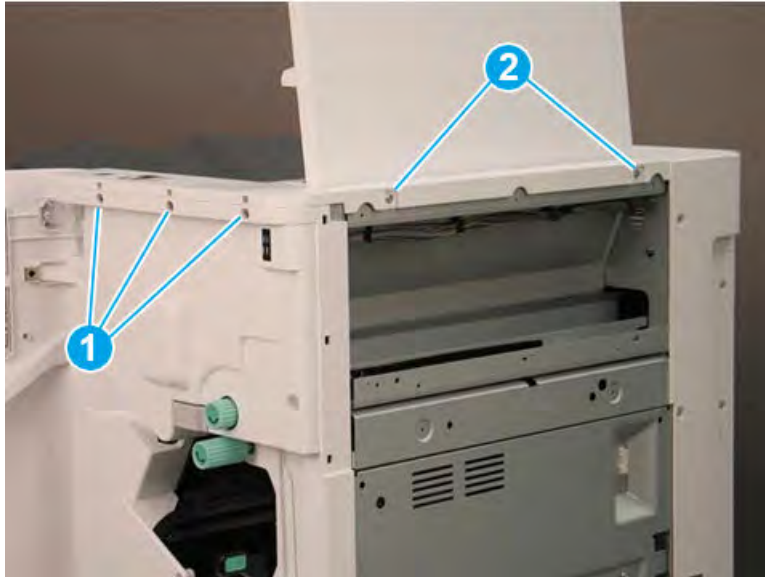
**Figure 5-1700** Remove six screws





2. Remove three self-tapping screws at the top of the front cover (callout 1), and then remove two machine screws (callout 2) at the top of the right side.

Figure 5-1701 Remove five screws



3. Lift the cover up slightly. Disconnect one in-line connector (callout 1), and then release one retainer (callout 2).


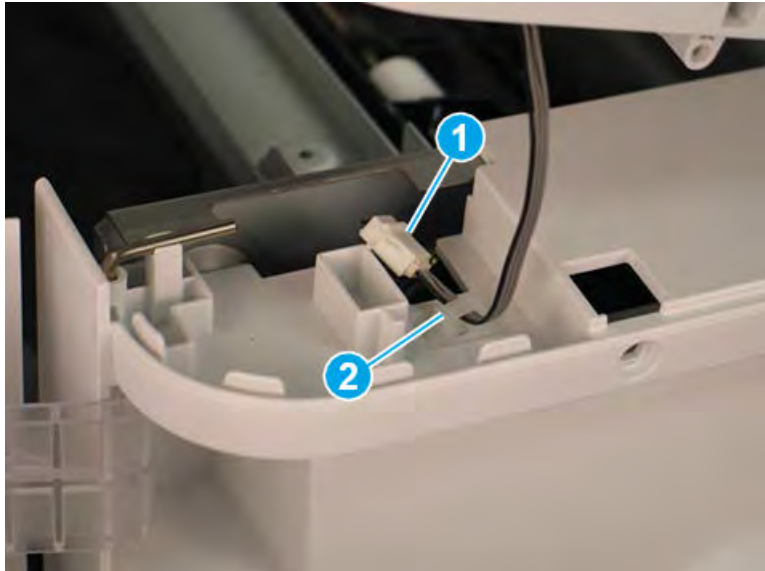
 **TIP:** Reverse the removal steps to install the assembly.

Figure 5-1702 Disconnect one connector and release retainer

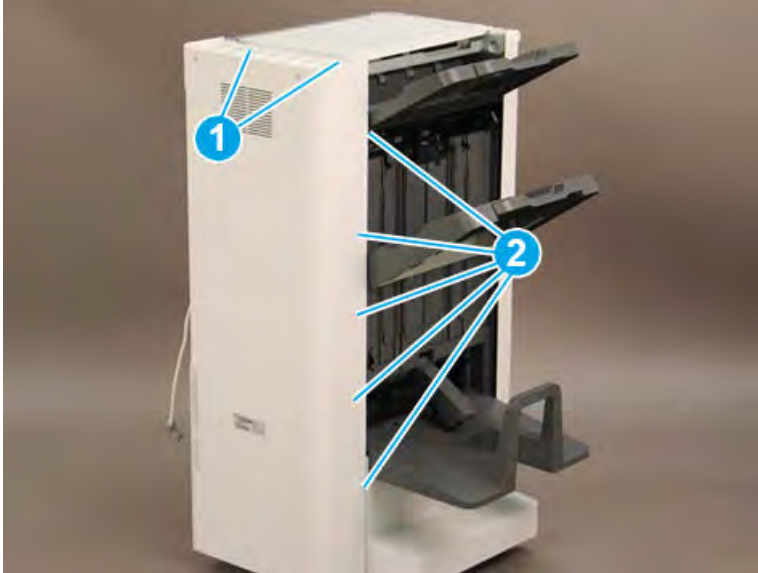


### Remove the rear cover (finisher)

Follow these steps to remove the rear cover (finisher).

1. Remove two self-tapping screws (callout 1) on the top of the rear cover, and then remove five screw caps and five machine screws (callout 2) on the left side of the cover.


Figure 5-1703 Remove seven screws



2. Remove one screw cap and four machine screws (callout 1) Remove the rear cover.

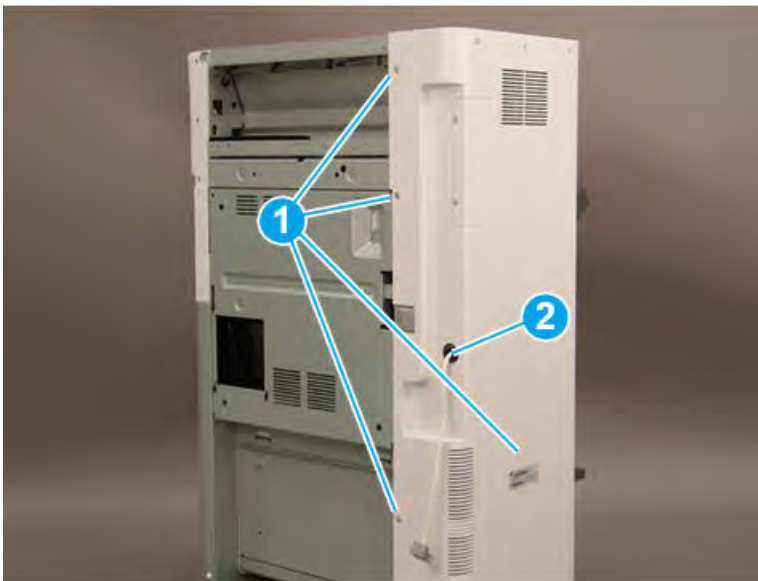
---

 **NOTE:** Make sure to thread the power cable (callout 2) through the opening in the cover.

 **TIP:** Reverse the removal steps to install the assembly

---

Figure 5-1704 Remove the rear cover



### Remove the booklet maker

Follow these steps to remove the booklet maker.

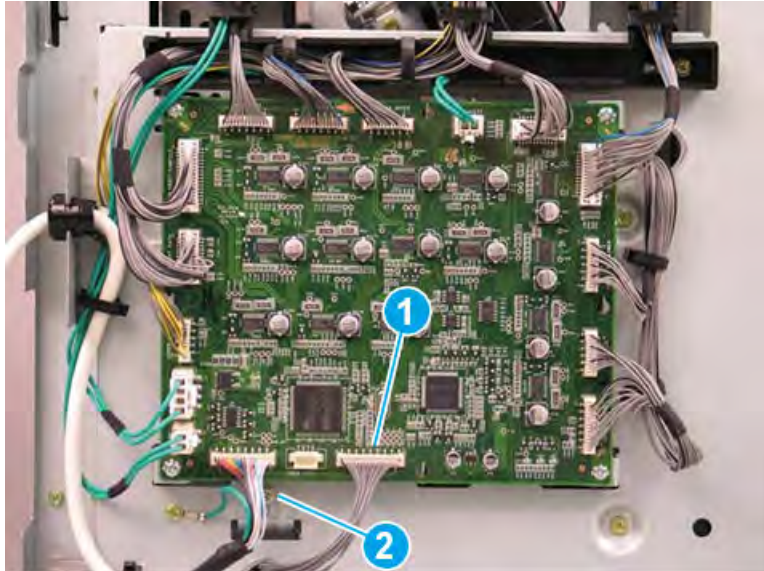
1. Slide the booklet maker away from the finisher.

Figure 5-1705 Slide the booklet maker away from the finisher



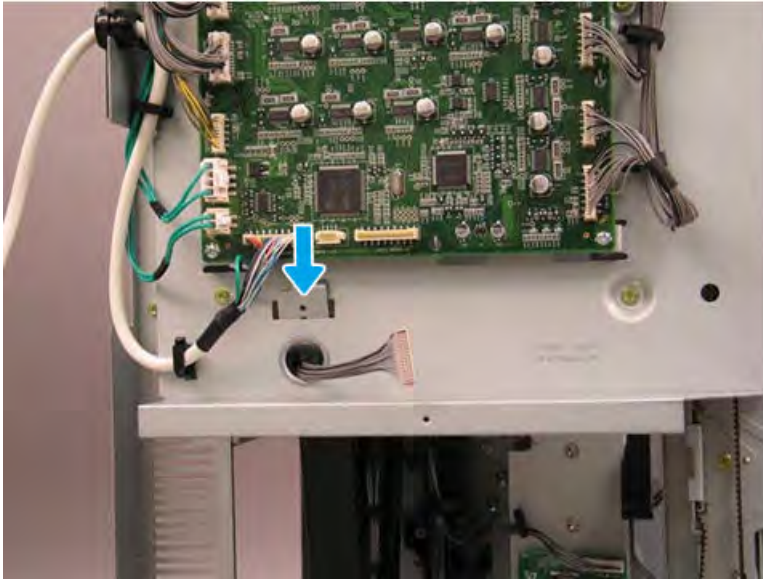
2. At the Disconnect one connector (callout 1), and then remove one screw (callout 2).

Figure 5-1706 Disconnect one connector and remove one screw



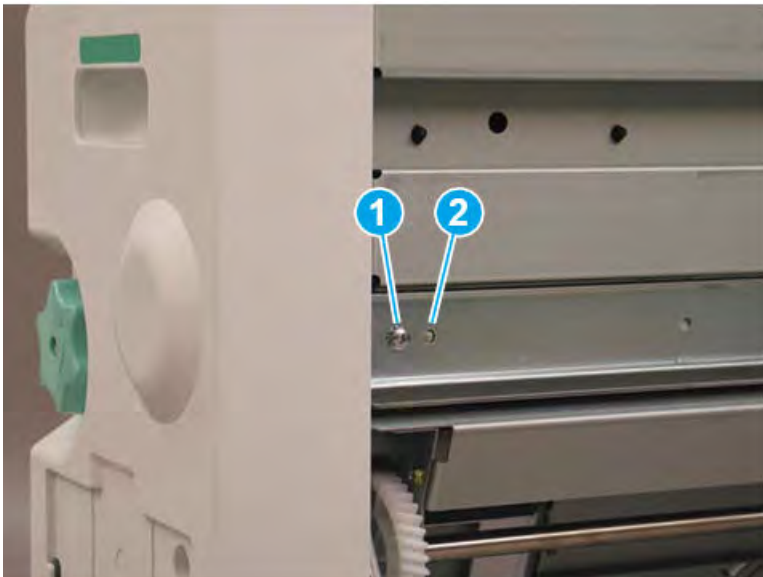
3. Release the metal bracket through the opening in the sheet metal.

Figure 5-1707 Release the metal bracket



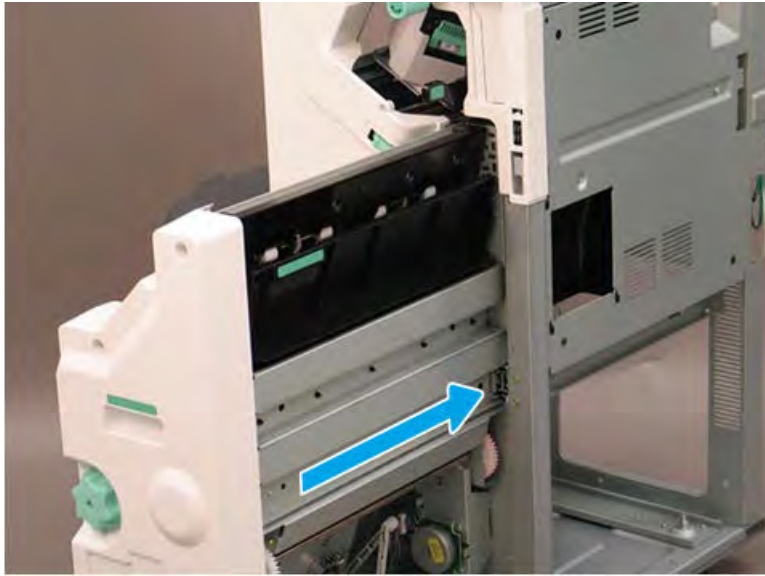
4. Remove one star-washer screw (callout 1), and then release the alignment pin (callout 2) on the right side of the booklet maker.

Figure 5-1708 Remove one screw



5. Slide the right rail toward the finisher.

Figure 5-1709 Slide the right rail



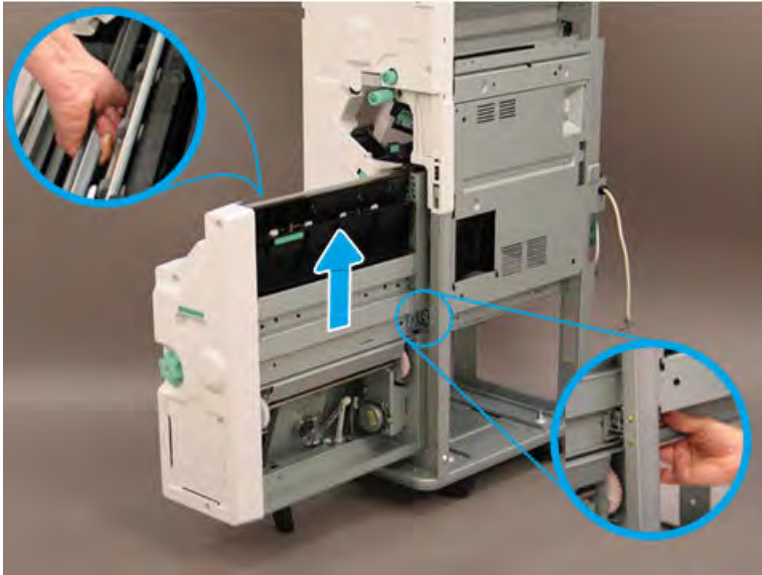
6. Remove one star-washer screw (callout 1) on the left side of the booklet maker.

Figure 5-1710 Remove one screw



7. Lift the booklet maker up on the left side while squeezing the right rail away from the finisher slightly to clear the sheet metal. Remove the booklet maker.

**Figure 5-1711** Remove the booklet maker



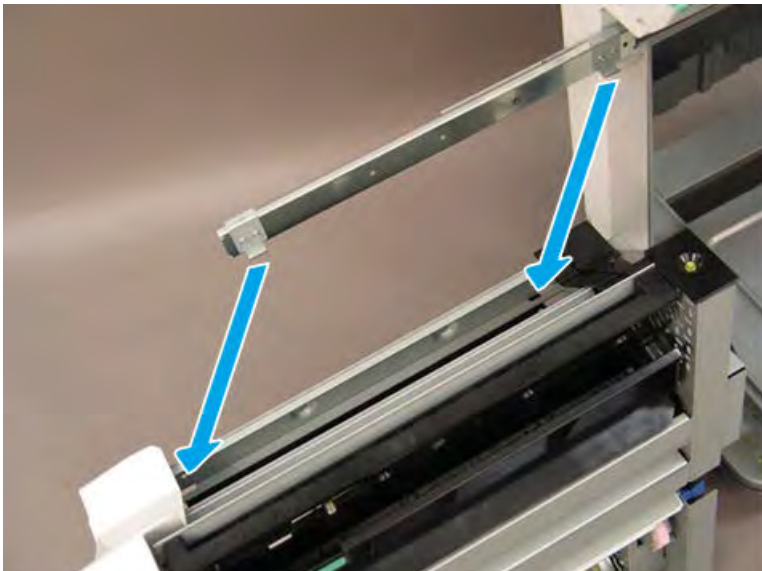
8. Reverse the removal steps to install the assembly. Also use the following special installation instructions.

 **NOTE:** Continue to reverse the removal steps to finish installing the assembly.

**Special installation instructions: booklet maker**

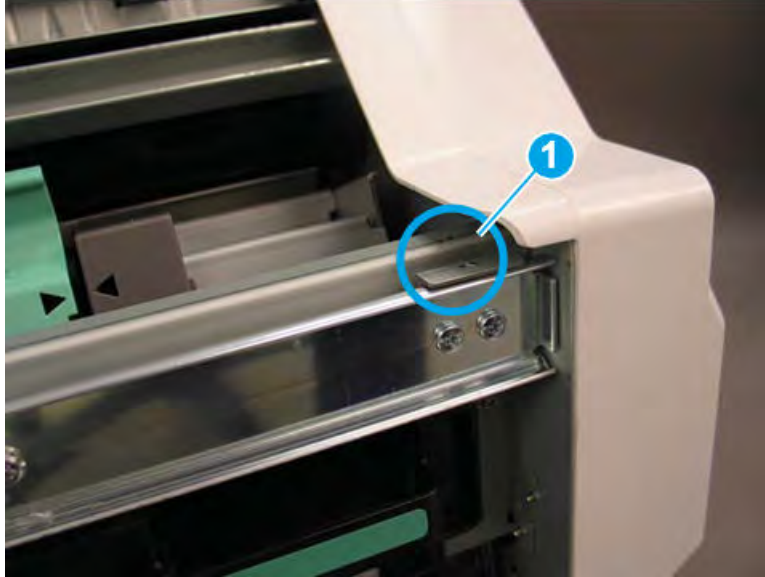
When installing the booklet maker, position the hooks on the rail under the slots on the booklet maker.

**Figure 5-1712** Position the hooks



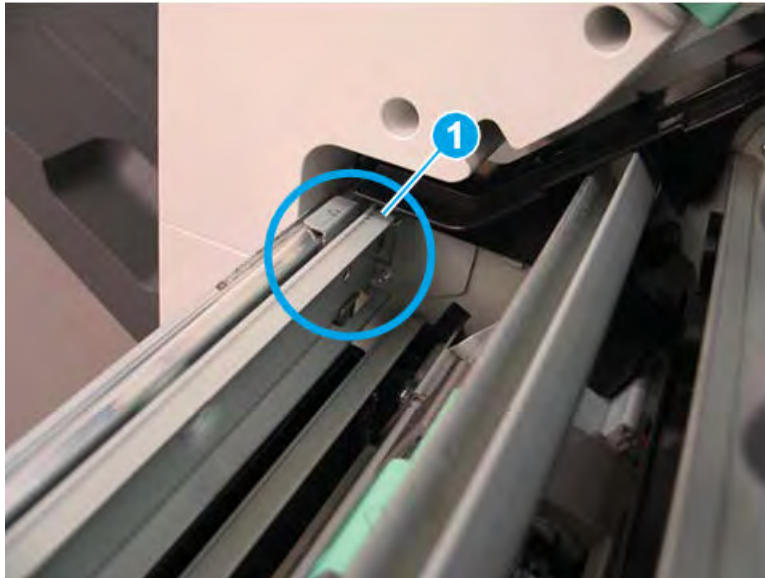
9. When installed correctly, the arrow on the front of the booklet maker aligns with the arrow on the finisher rail.

Figure 5-1713 Align arrows



10. When installed correctly, the arrow on the back of the booklet maker aligns with the arrow on the finisher rail.

Figure 5-1714 Align arrows



11. Extend the right rail away from the finisher and position it in the booklet maker slot.

Figure 5-1715 Extend the right rail



#### Remove the booklet front cover

Follow these steps to remove the booklet front cover.

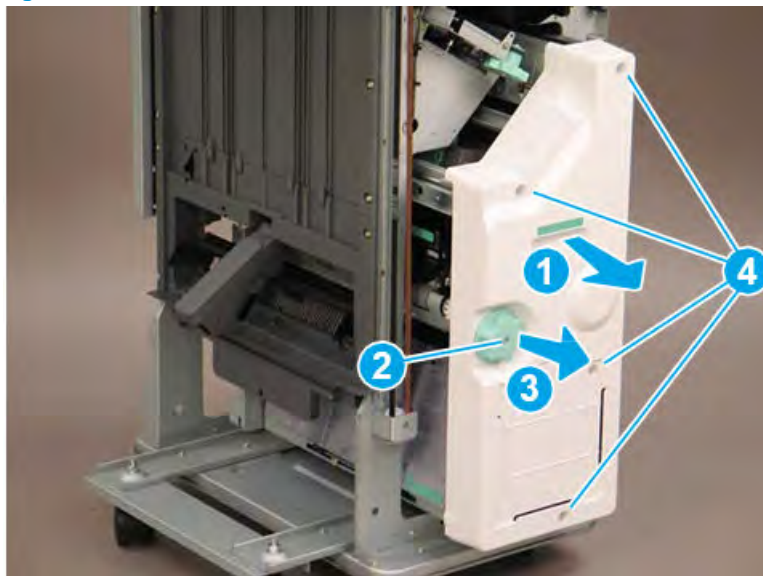
- ▲ Slide the booklet maker slightly away from the finisher (callout 1). Remove one screw (callout 2), and then slide the green knob away from the booklet maker to remove it (callout 3). Remove four screws (callout 4), and then remove the booklet front cover.

---

 **TIP:** Reverse the removal steps to install the assembly

---

Figure 5-1716 Remove five screws and the cover



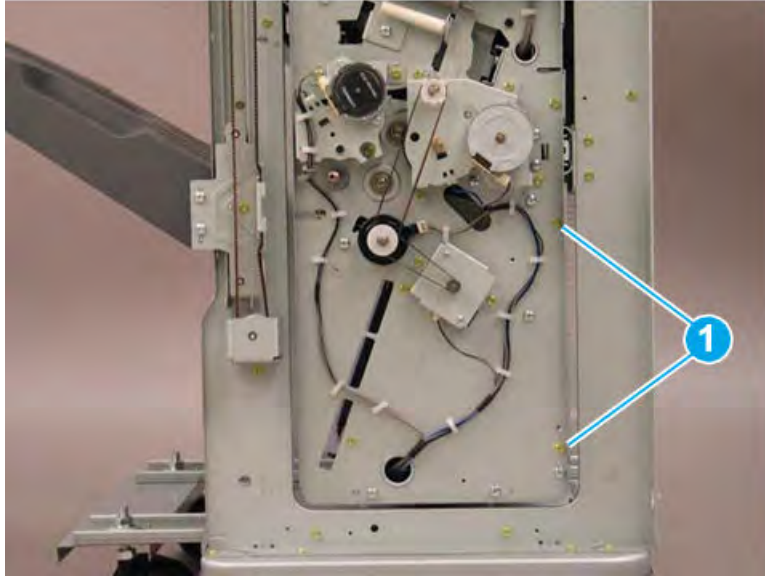
#### Remove the booklet right lower shield

Follow these steps to remove the booklet right lower shield.



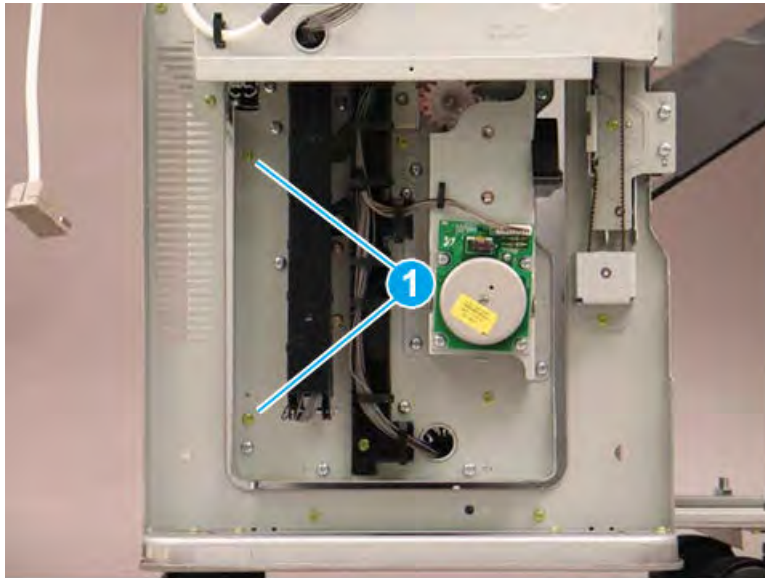
1. Remove two screws at the front of the booklet maker (callout 1).

Figure 5-1717 Remove two screws



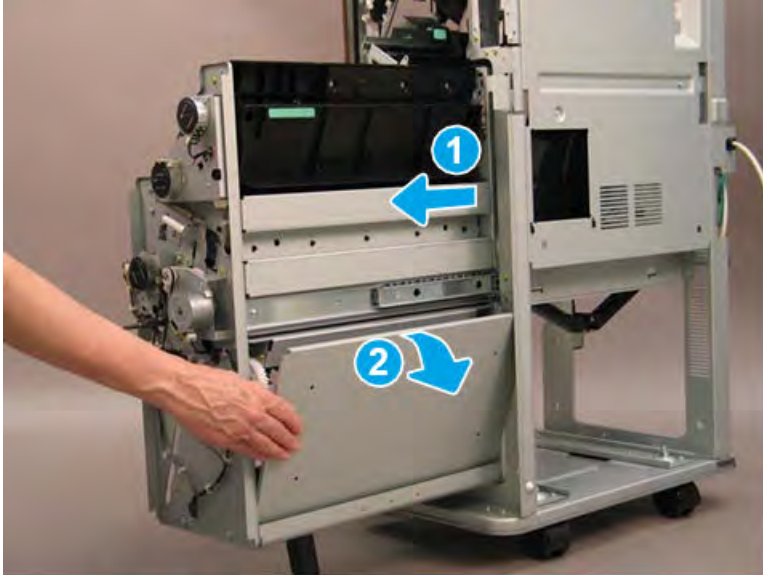
2. Remove two screws at the back of the booklet maker (callout 1).

Figure 5-1718 Remove two screws



3. Slide the booklet maker out of the finisher (callout 1), and then rotate the top of the right lower shield (callout 2) away from the booklet maker to remove it.

Figure 5-1719 Remove the right lower shield

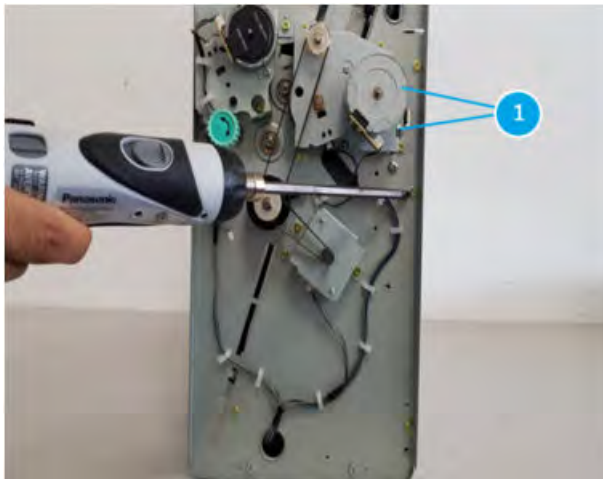


#### Remove the booklet maker middle right shield

Follow these steps to remove the booklet maker middle right shield.

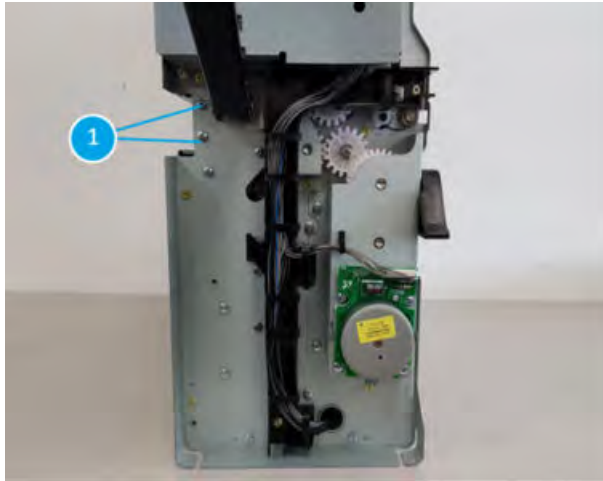
1. Remove two screws at the front of the booklet maker (callout 1).

Figure 5-1720 Remove two screws at the front of the booklet maker



2. Remove two screws at the back of the booklet maker (callout 1).

**Figure 5-1721** Remove two screws at the back of the booklet maker



#### Remove the booklet finisher upper right shield

Follow these steps to remove the booklet finisher upper right shield.

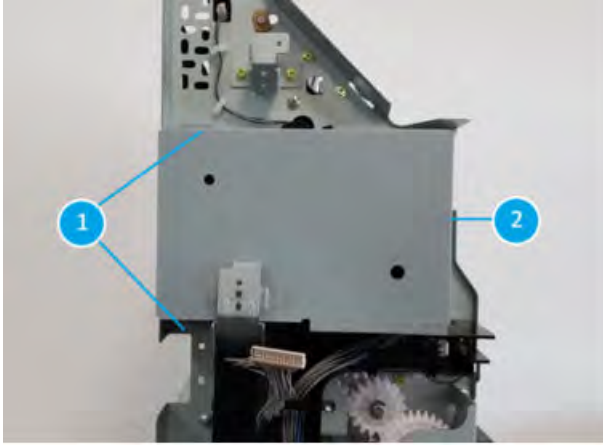
1. Remove two screws at the front of the booklet maker (callout 1)

**Figure 5-1722** Remove two screws at the front of the booklet maker



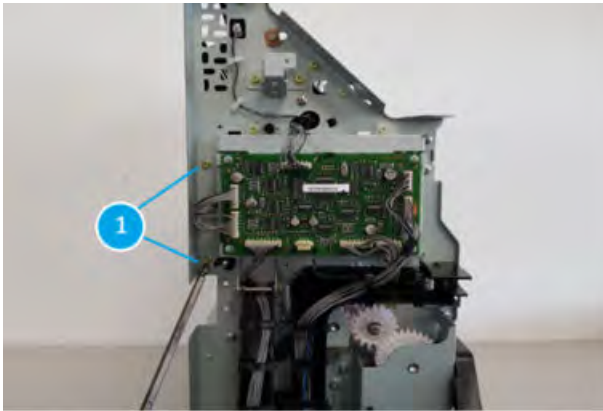
2. Remove two screws (callout 1) and one screw (callout 2) at the back of the booklet maker and then remove the board cover.

Figure 5-1723 Remove the board cover



3. Remove two screws at the back of the booklet maker (callout 1).

Figure 5-1724 Remove two screws



4. Disconnect one connector at the front of the booklet maker (callout 1).

Figure 5-1725 Disconnect one connector



5. Disconnect one connector at the right of the booklet maker (callout 1).

Figure 5-1726 Disconnect one connector



### Remove the booklet tamper and fold unit

Follow these steps to remove the booklet tamper and fold unit.

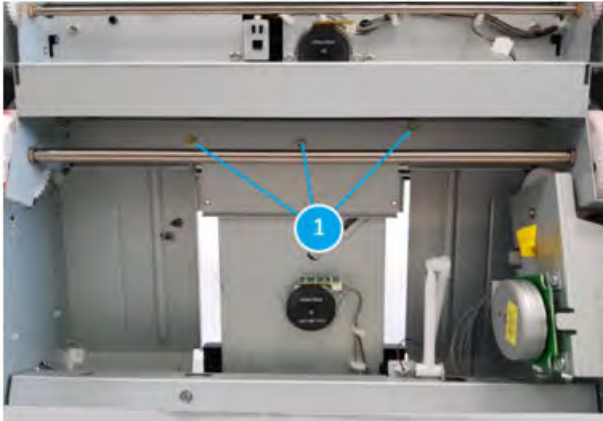
1. Remove two screws at the left of the booklet maker (callout 1).

Figure 5-1727 Remove two screws at the left of the booklet maker



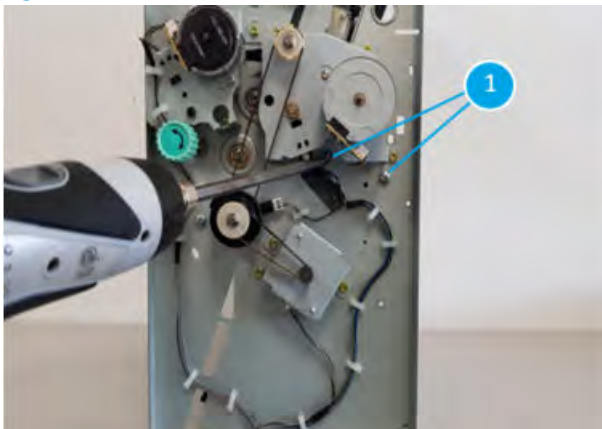
2. Remove three screws at the right of the booklet maker (callout 1).

Figure 5-1728 Remove three screws at the right of the booklet maker



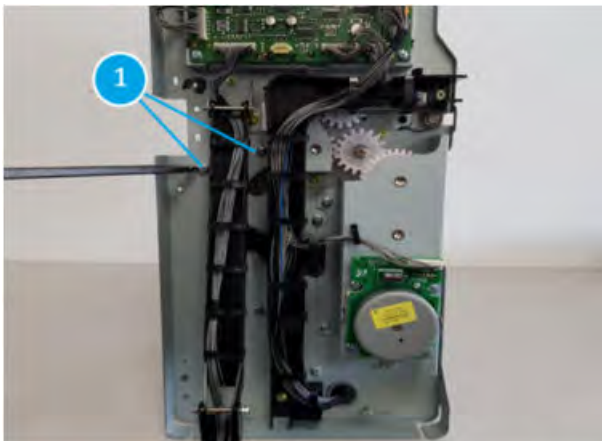
3. Remove two screws at the front of the booklet maker (callout 1).

Figure 5-1729 Remove two screws at the front of the booklet maker



4. Remove two screws at the back of the booklet maker (callout 1).

Figure 5-1730 Remove two screws at the back of the booklet maker



5. Disconnect one connector at the right of the booklet maker (callout 1).

Figure 5-1731 Disconnect one connector

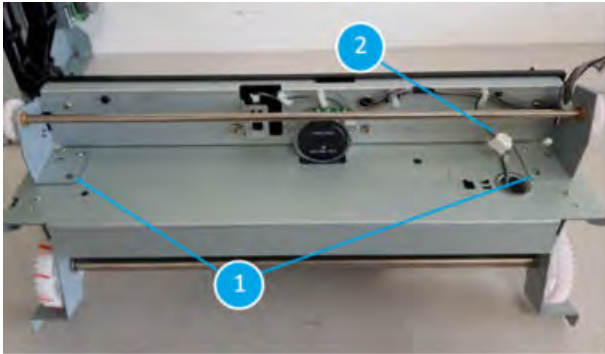


### Remove the booklet blade

Follow these steps to remove the booklet blade.

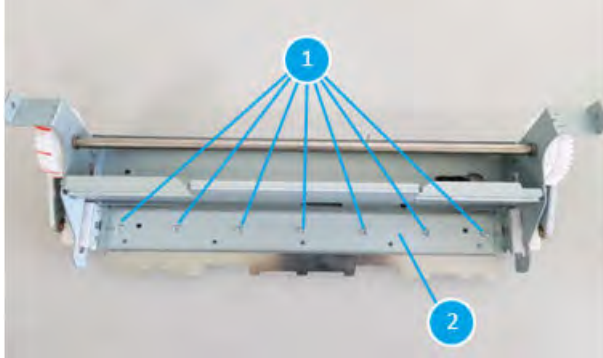
1. Remove two screws (callout 1) and disconnect one connector (callout 2)


Figure 5-1732 Remove two screws and disconnect one connector



2. Remove 7 screws (callout 1) and remove the booklet blade (callout 2)

**Figure 5-1733** Remove 7 screws and remove the booklet blade



 **NOTE:** Be sure to make the scale when you reassemble with the new blade



### Unpack the replacement assembly



Follow these steps to unpack the replacement assembly.


1. Dispose of the defective part.


 **NOTE:** HP recommends responsible disposal of the defective part.

<http://www8.hp.com/us/en/hp-information/environment/product-recycling.html>

2. Unpack the replacement part from the packaging.

 **CAUTION:**  Some parts are sensitive to electrostatic discharge (ESD). Always perform service work at an ESD-protected workstation or mat. If an ESD workstation or mat is not available, touch the sheet-metal chassis to provide a static ground before touching an ESD-sensitive assembly. Protect the ESD-sensitive assemblies by placing them in ESD pouches when they are out of the printer.

 **IMPORTANT:** Make sure that all of the shipping materials (for example shipping tape) are removed from the replacement part prior to installation.

 **NOTE:** If the replacement part is a roller or pad, avoid touching the spongy part of it. Skin oils on the roller or pad can cause paper pickup and/or print-quality problems. HP recommends using disposable gloves when handling rollers or pads or washing your hands before touching rollers or pads.

3. To install an assembly, reverse the removal steps.





---

**NOTE:** When applicable, special installation instructions are provided for an assembly at the end of the removal procedure. Always completely read the removal instructions and follow all special installation instructions.


---

## Removal and replacement: Booklet blade home sensor (S45)

Learn how to remove and replace the tray booklet blade home sensor.

### Introduction

This document provides the procedures to remove and replace the booklet blade home sensor on the finisher.

 **IMPORTANT:** When applicable, special installation instructions are provided for an assembly at the end of the removal procedure. Always completely read the removal instructions and follow all special installation instructions.

### Before performing service

- Turn the printer power off. A shutting-down message appears on the control-panel display.
- ⚠ **WARNING!** To avoid damage to the printer, turn the power off and wait until the printer shuts down before removing the power cable.
- Disconnect the printer power cable after the printer has completely shut down (the control-panel display is blank).
- Release the finisher from the printer by pulling out on the release latch inside the finisher door.
- Disconnect the cable from the bridge unit to the finisher.
- Disconnect the cable from the finisher to the printer.

Use the table below to identify the correct part number for your printer. To order the part, go to <https://parts.hp.com>.

**Table 5-159** Part information

Part number	Part description
0604-001393	Booklet blade home sensor

### Required tools

- #2 JIS screwdriver with a magnetic tip

### After performing service

- Connect the cable from the finisher to the printer.
- Connect the cable from the bridge unit to the finisher.
- Attach the finisher to the printer, and then push in on the release latch inside the finisher door.
- Connect the printer power cable.
- Turn the printer power on.

### Post service test

Process a job through the finisher and verify that the finisher works correctly.

### Remove the right upper cover (finisher)

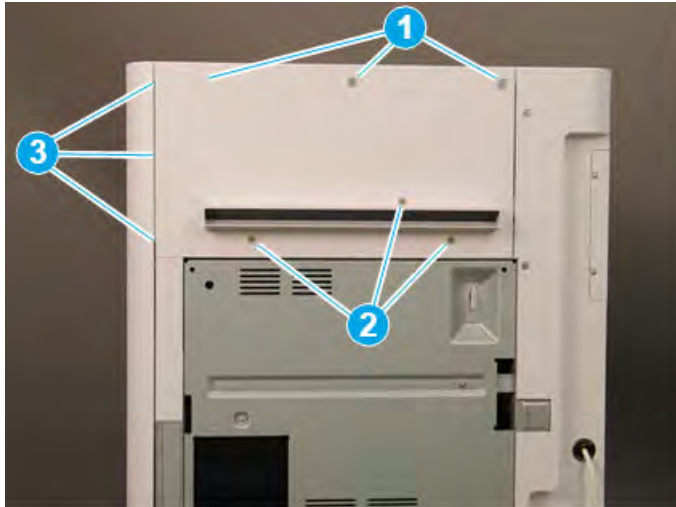
Follow these steps to remove the right upper cover (finisher).

- ▲ Remove one screw cap and three machine screws on the upper edge of the cover (callout 1). Remove three sheet metal screws (callout 2) on the lower portion of the cover. Rotate the right edge of the cover away from the finisher, and then slide the cover right to release three tabs (callout 3).

💡 **TIP:** The lower screws are shorter in length than the upper screws.

**TIP:** Reverse the removal steps to install the assembly.

Figure 5-1734 Remove the right upper cover

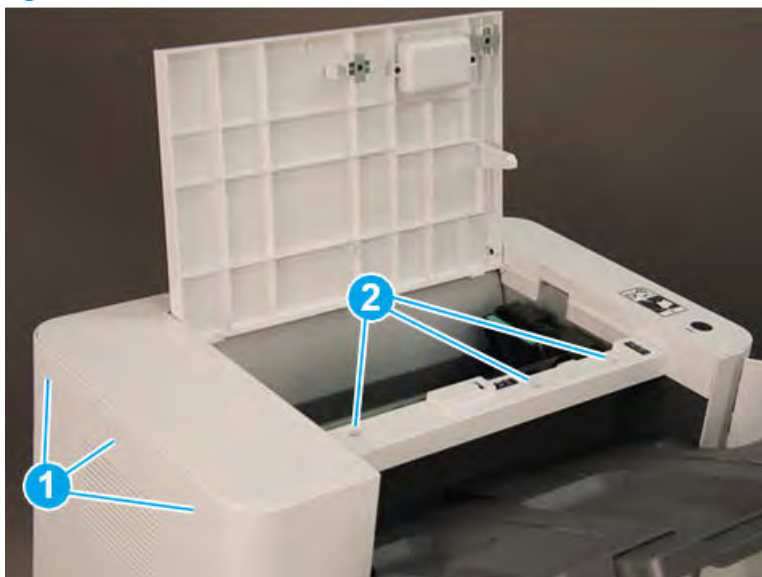


### Remove the top cover (finisher)

Follow these steps to remove the top cover (finisher).

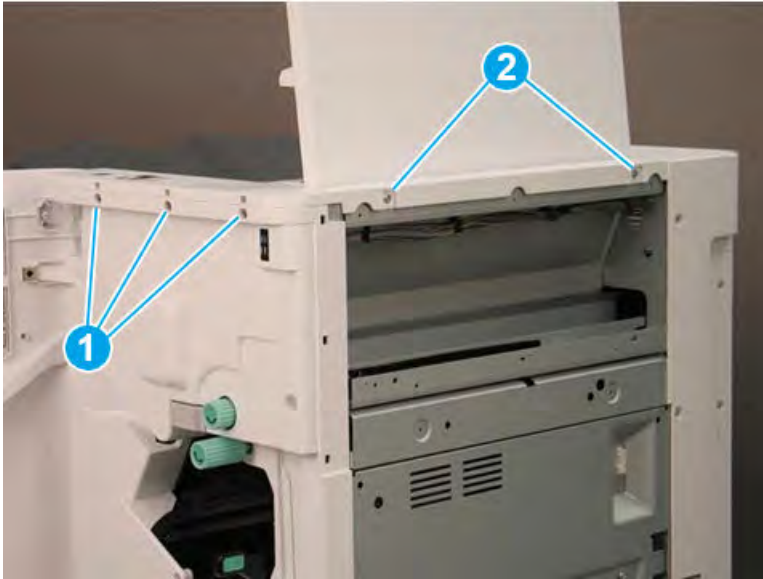
1. Remove three screw caps and three self-tapping screws at the top of the rear cover (callout 1), and then remove three machine screws (callout 2) on top of the cover.

Figure 5-1735 Remove six screws




2. Remove three self-tapping screws at the top of the front cover (callout 1), and then remove two machine screws (callout 2) at the top of the right side.

Figure 5-1736 Remove five screws



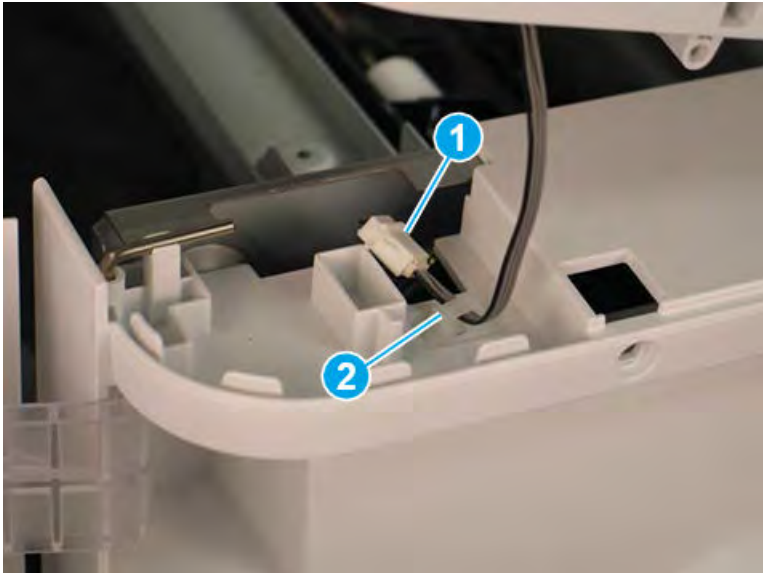
3. Lift the cover up slightly. Disconnect one in-line connector (callout 1), and then release one retainer (callout 2).

---

 **TIP:** Reverse the removal steps to install the assembly.

---

Figure 5-1737 Disconnect one connector and release retainer

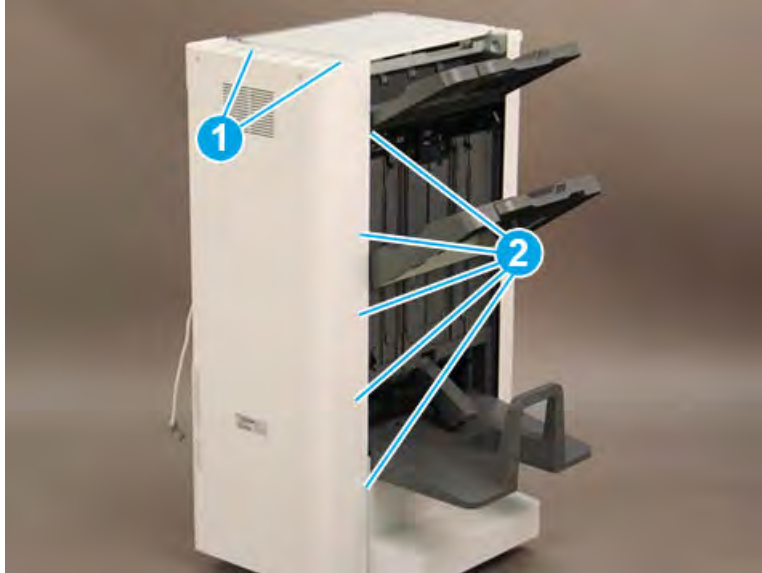


### Remove the rear cover (finisher)


Follow these steps to remove the rear cover (finisher).

1. Remove two self-tapping screws (callout 1) on the top of the rear cover, and then remove five screw caps and five machine screws (callout 2) on the left side of the cover.

Figure 5-1738 Remove seven screws



2. Remove one screw cap and four machine screws (callout 1) Remove the rear cover.

 **NOTE:** Make sure to thread the power cable (callout 2) through the opening in the cover.


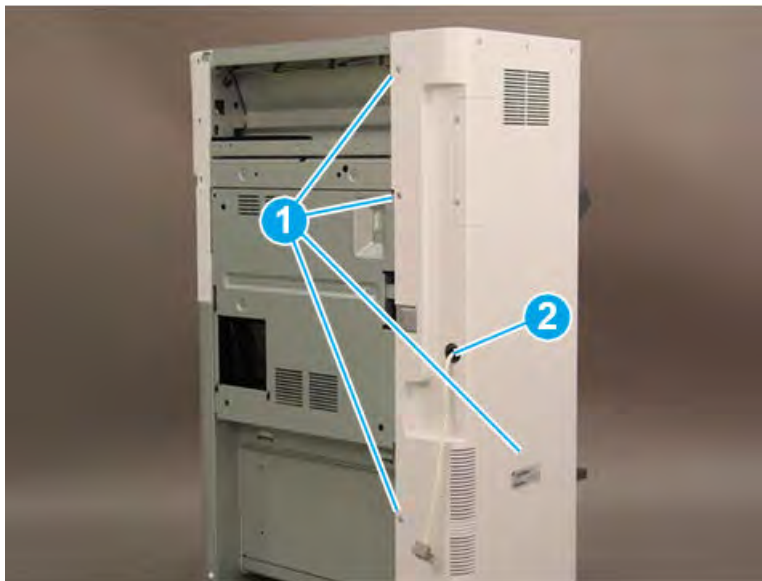
 **TIP:** Reverse the removal steps to install the assembly

Figure 5-1739 Remove the rear cover



### Remove the booklet maker

Follow these steps to remove the booklet maker.

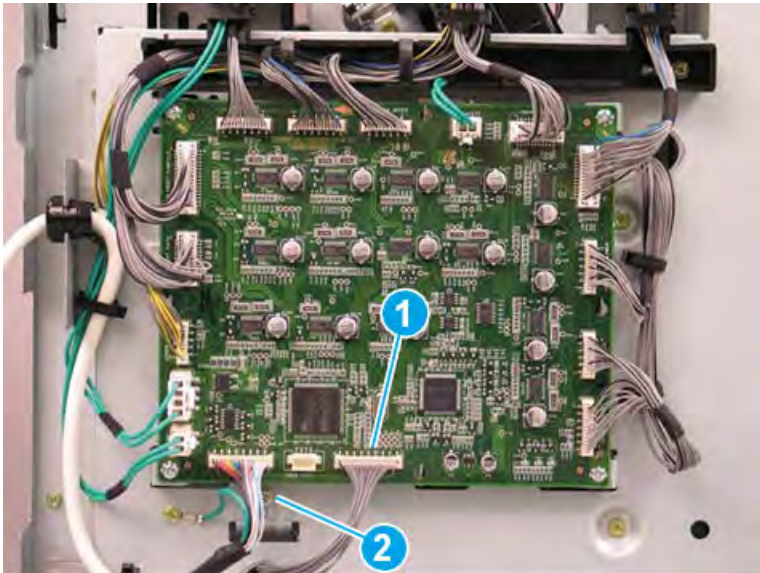
1. Slide the booklet maker away from the finisher.

Figure 5-1740 Slide the booklet maker away from the finisher



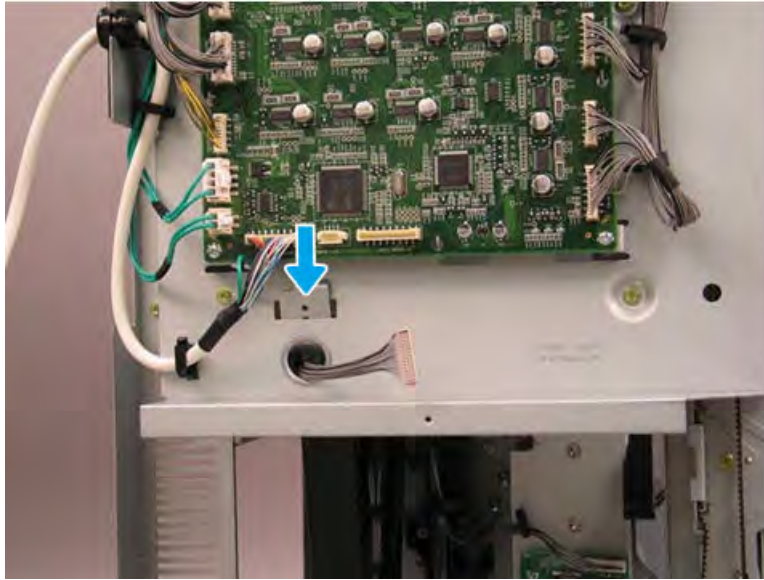
2. At the Disconnect one connector (callout 1), and then remove one screw (callout 2).

Figure 5-1741 Disconnect one connector and remove one screw



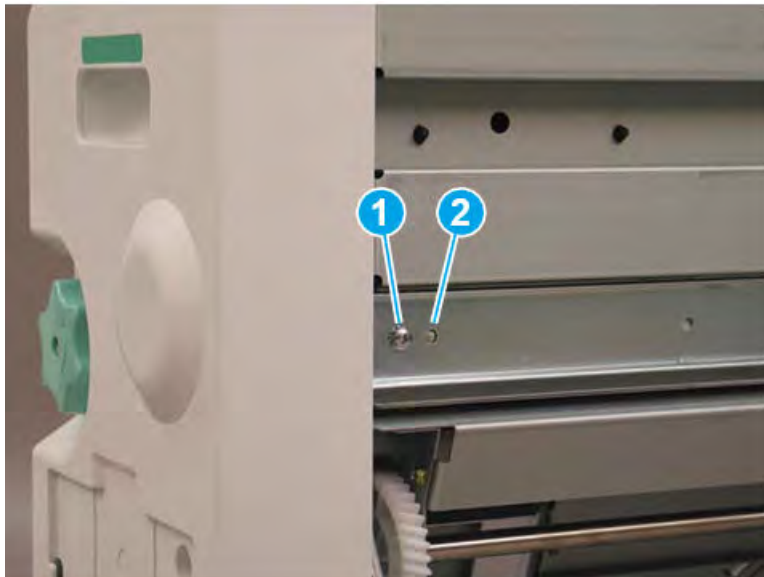
3. Release the metal bracket through the opening in the sheet metal.

Figure 5-1742 Release the metal bracket



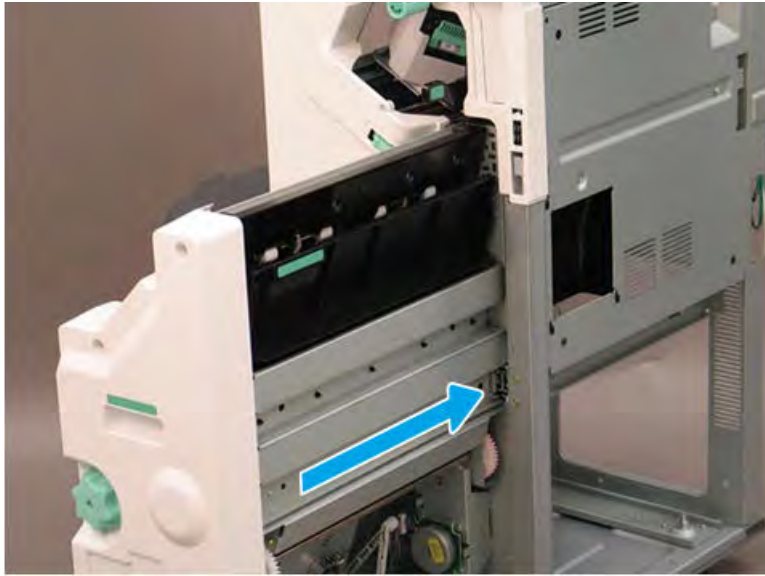
4. Remove one star-washer screw (callout 1), and then release the alignment pin (callout 2) on the right side of the booklet maker.

Figure 5-1743 Remove one screw



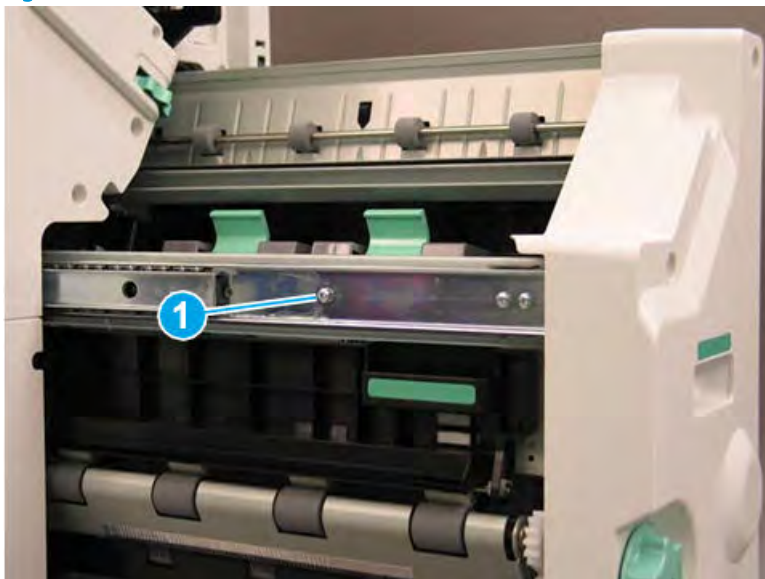
5. Slide the right rail toward the finisher.

Figure 5-1744 Slide the right rail



6. Remove one star-washer screw (callout 1) on the left side of the booklet maker.

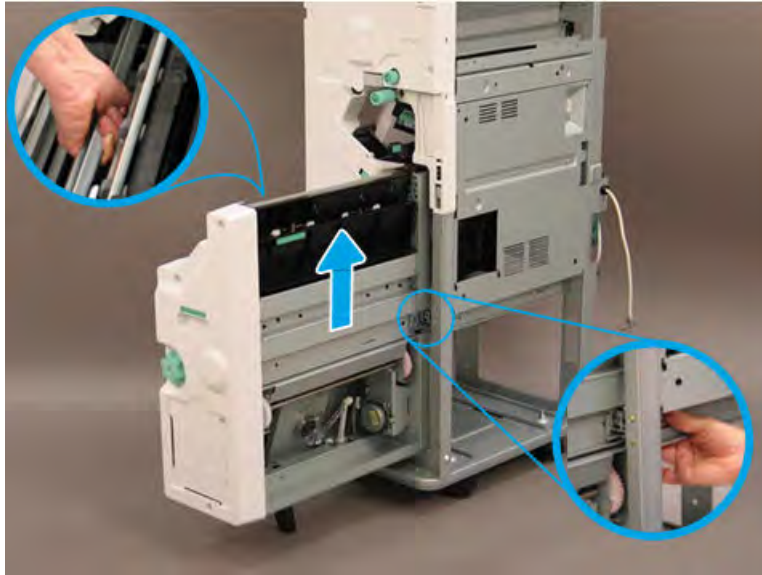
Figure 5-1745 Remove one screw





7. Lift the booklet maker up on the left side while squeezing the right rail away from the finisher slightly to clear the sheet metal. Remove the booklet maker.

**Figure 5-1746** Remove the booklet maker



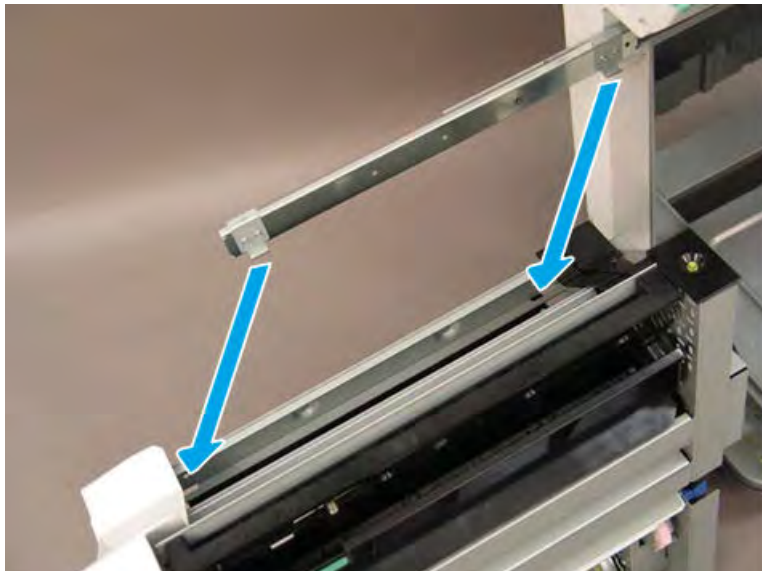
8. Reverse the removal steps to install the assembly. Also use the following special installation instructions.

 **NOTE:** Continue to reverse the removal steps to finish installing the assembly.

**Special installation instructions: booklet maker**

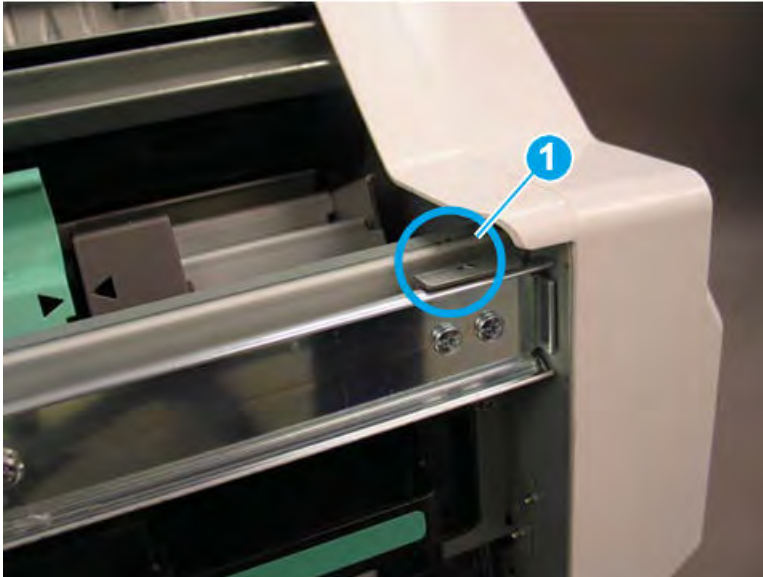
When installing the booklet maker, position the hooks on the rail under the slots on the booklet maker.

**Figure 5-1747** Position the hooks



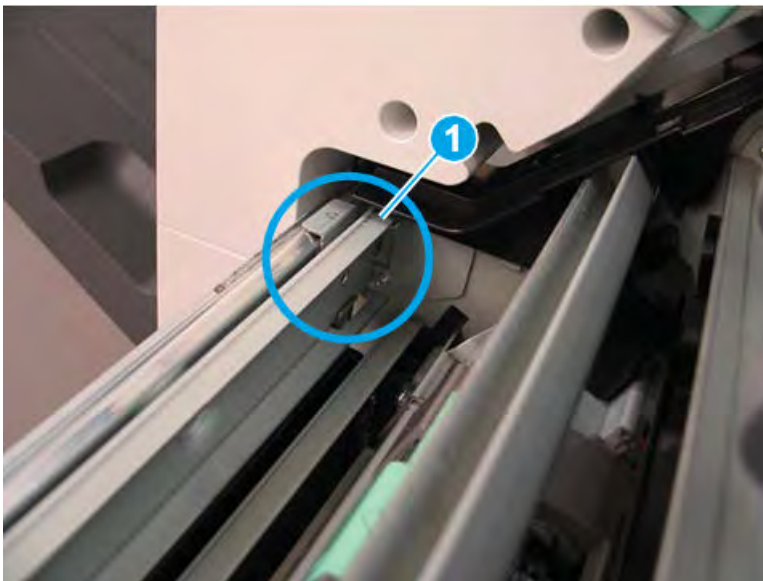
9. When installed correctly, the arrow on the front of the booklet maker aligns with the arrow on the finisher rail.

Figure 5-1748 Align arrows



10. When installed correctly, the arrow on the back of the booklet maker aligns with the arrow on the finisher rail.

Figure 5-1749 Align arrows



11. Extend the right rail away from the finisher and position it in the booklet maker slot.

Figure 5-1750 Extend the right rail



### Remove the booklet front cover

Follow these steps to remove the booklet front cover.

- ▲ Slide the booklet maker slightly away from the finisher (callout 1). Remove one screw (callout 2), and then slide the green knob away from the booklet maker to remove it (callout 3). Remove four screws (callout 4), and then remove the booklet front cover.


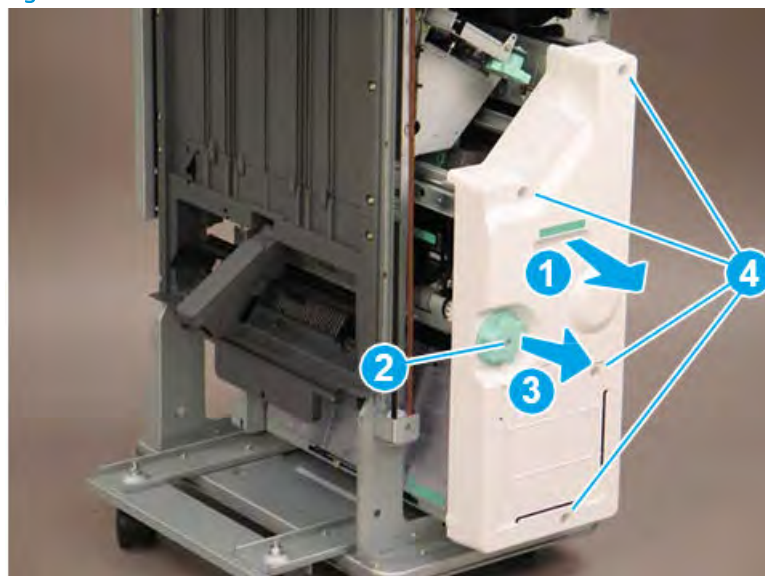
 **TIP:** Reverse the removal steps to install the assembly

Figure 5-1751 Remove five screws and the cover

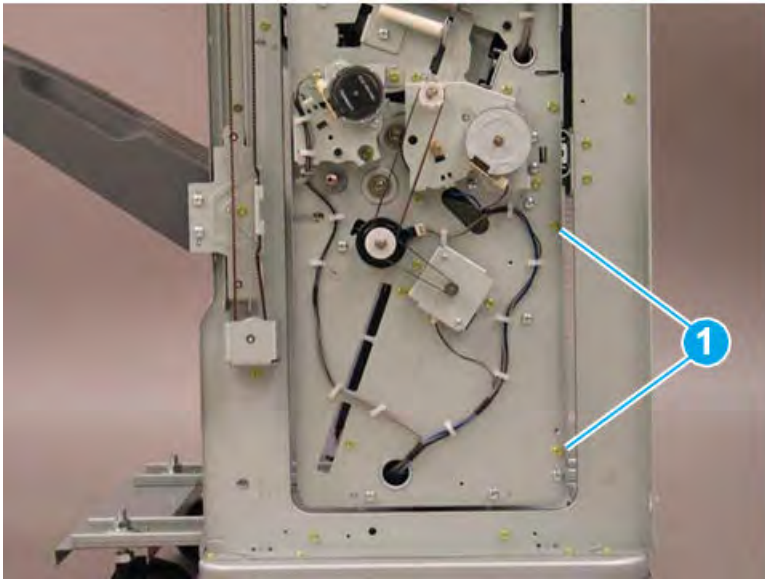


### Remove the booklet right lower shield

Follow these steps to remove the booklet right lower shield.

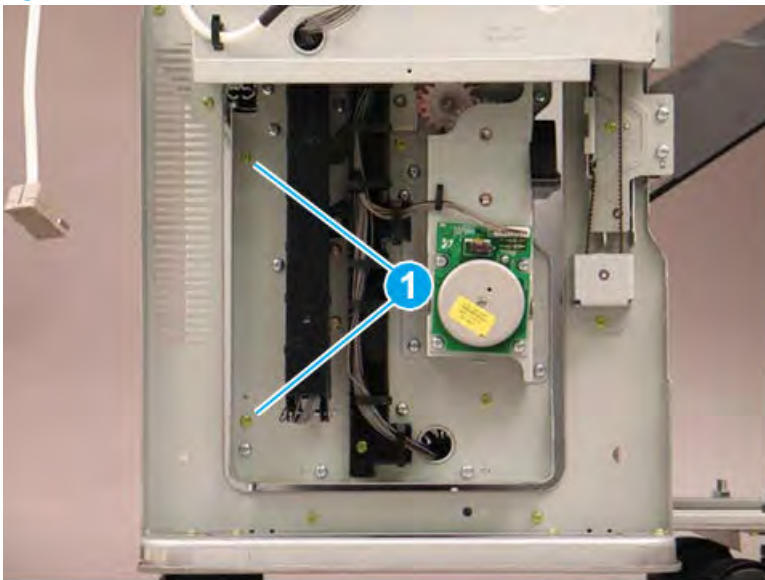
1. Remove two screws at the front of the booklet maker (callout 1).

Figure 5-1752 Remove two screws



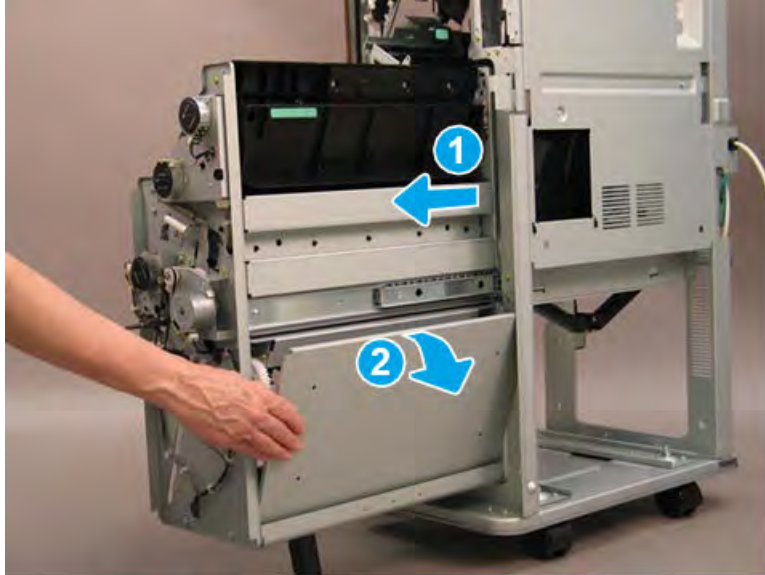
2. Remove two screws at the back of the booklet maker (callout 1).

Figure 5-1753 Remove two screws



3. Slide the booklet maker out of the finisher (callout 1), and then rotate the top of the right lower shield (callout 2) away from the booklet maker to remove it.

Figure 5-1754 Remove the right lower shield

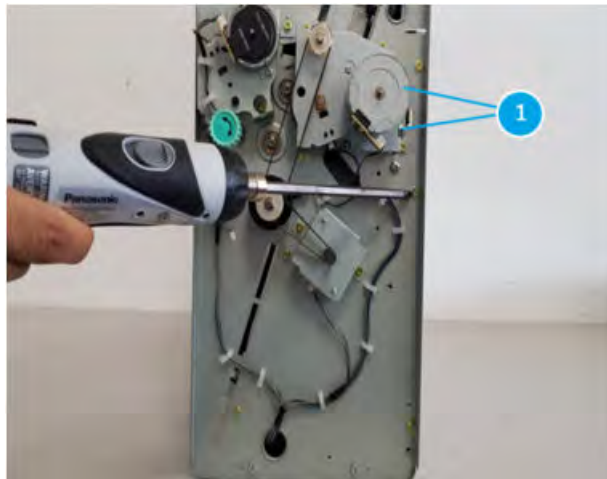


#### Remove the booklet maker middle right shield

Follow these steps to remove the booklet maker middle right shield.

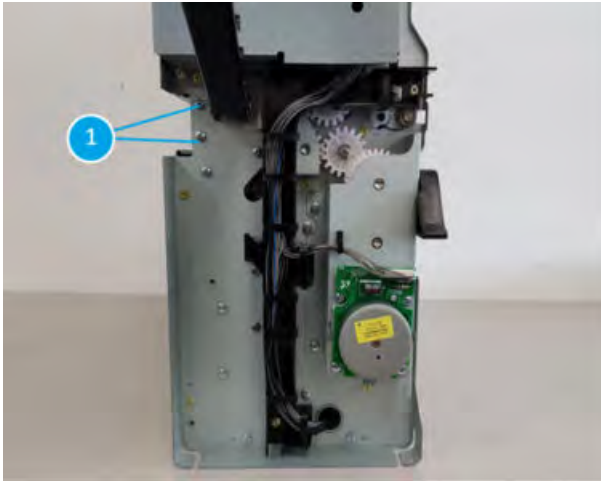
1. Remove two screws at the front of the booklet maker (callout 1).

Figure 5-1755 Remove two screws at the front of the booklet maker



2. Remove two screws at the back of the booklet maker (callout 1).

**Figure 5-1756** Remove two screws at the back of the booklet maker



### Remove the booklet finisher upper right shield

Follow these steps to remove the booklet finisher upper right shield.

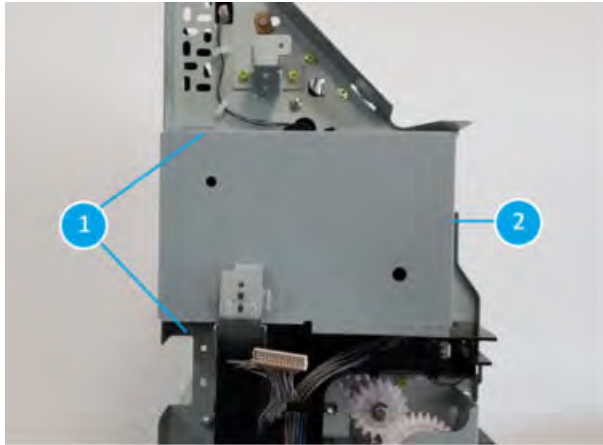
1. Remove two screws at the front of the booklet maker (callout 1)

**Figure 5-1757** Remove two screws at the front of the booklet maker



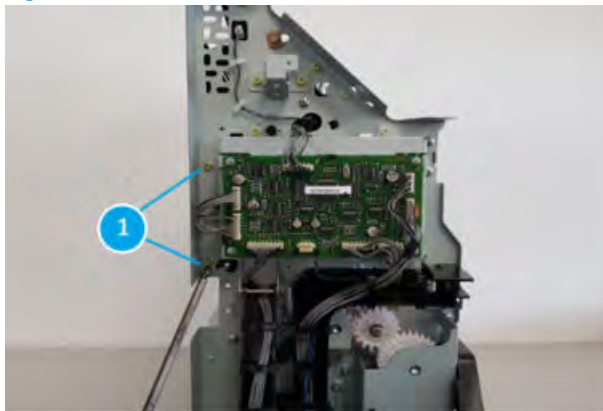
2. Remove two screws(callout 1) and one screw(callout 2) at the back of the booklet maker and then remove the board cover.

Figure 5-1758 Remove the board cover



3. Remove two screws at the back of the booklet maker (callout 1).

Figure 5-1759 Remove two screws



4. Disconnect one connector at the front of the booklet maker (callout 1).

Figure 5-1760 Disconnect one connector



5. Disconnect one connector at the right of the booklet maker (callout 1).

Figure 5-1761 Disconnect one connector



### Remove the booklet tamper and fold unit

Follow these steps to remove the booklet tamper and fold unit.

1. Remove two screws at the left of the booklet maker (callout 1).

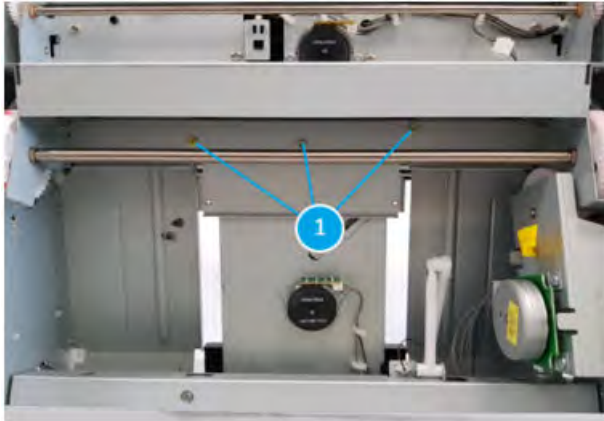
Figure 5-1762 Remove two screws at the left of the booklet maker





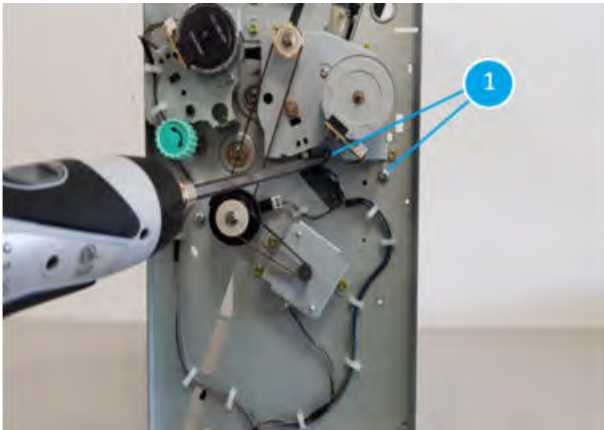
2. Remove three screws at the right of the booklet maker (callout 1).

Figure 5-1763 Remove three screws at the right of the booklet maker



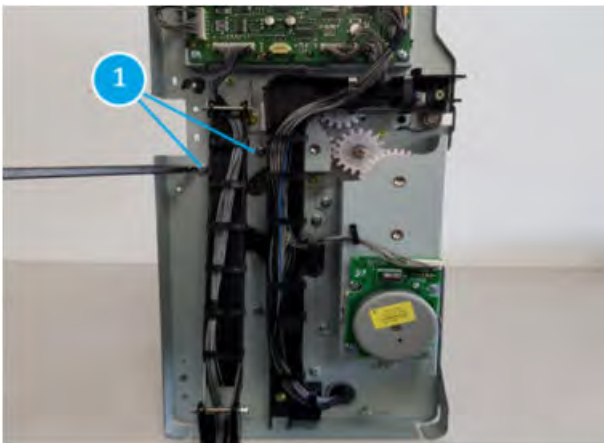
3. Remove two screws at the front of the booklet maker (callout 1).

Figure 5-1764 Remove two screws at the front of the booklet maker



4. Remove two screws at the back of the booklet maker (callout 1).

Figure 5-1765 Remove two screws at the back of the booklet maker



5. Disconnect one connector at the right of the booklet maker (callout 1).

**Figure 5-1766** Disconnect one connector

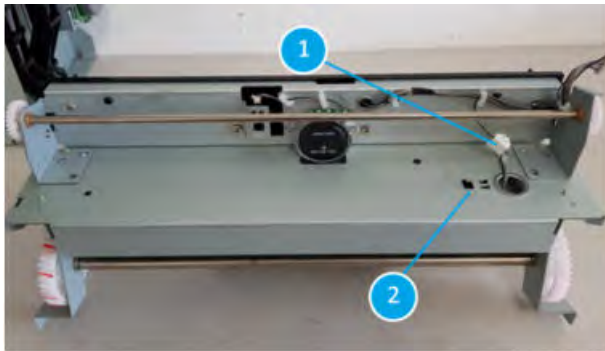


### Remove the booklet blade home sensor (S45)

Follow these steps to remove the booklet blade home sensor (S45).

- ▲ Disconnect one connector (callout 1) and remove the Booklet blade home sensor (S45, callout 2)

**Figure 5-1767** Disconnect one connector and remove the Booklet blade home sensor



### Unpack the replacement assembly

Follow these steps to unpack the replacement assembly.

1. Dispose of the defective part.



---

 **NOTE:** HP recommends responsible disposal of the defective part.


<http://www8.hp.com/us/en/hp-information/environment/product-recycling.html>

---

2. Unpack the replacement part from the packaging.


 **CAUTION:**  Some parts are sensitive to electrostatic discharge (ESD). Always perform service work at an ESD-protected workstation or mat. If an ESD workstation or mat is not available, touch the sheet-metal chassis to provide a static ground before touching an ESD-sensitive assembly. Protect the ESD-sensitive assemblies by placing them in ESD pouches when they are out of the printer.

 **IMPORTANT:** Make sure that all of the shipping materials (for example shipping tape) are removed from the replacement part prior to installation.

 **NOTE:** If the replacement part is a roller or pad, avoid touching the spongy part of it. Skin oils on the roller or pad can cause paper pickup and/or print-quality problems. HP recommends using disposable gloves when handling rollers or pads or washing your hands before touching rollers or pads.

---

3. To install an assembly, reverse the removal steps.

 **NOTE:** When applicable, special installation instructions are provided for an assembly at the end of the removal procedure. Always completely read the removal instructions and follow all special installation instructions.


---

## Removal and replacement: Booklet blade motor (M22)

Learn how to remove and replace the booklet blade motor.

### Introduction

This document provides the procedures to remove and replace the booklet blade motor on the finisher.

 **IMPORTANT:** When applicable, special installation instructions are provided for an assembly at the end of the removal procedure. Always completely read the removal instructions and follow all special installation instructions.

### Before performing service

- Turn the printer power off. A shutting-down message appears on the control-panel display.
- ⚠ **WARNING!** To avoid damage to the printer, turn the power off and wait until the printer shuts down before removing the power cable.
- Disconnect the printer power cable after the printer has completely shut down (the control-panel display is blank).
- Release the finisher from the printer by pulling out on the release latch inside the finisher door.
- Disconnect the cable from the bridge unit to the finisher.
- Disconnect the cable from the finisher to the printer.

Use the table below to identify the correct part number for your printer. To order the part, go to <https://parts.hp.com>.

**Table 5-160 Part information**

Part number	Part description
JC90-01435A	Booklet blade motor assembly
JC31-00144A	Booklet blade motor

### Required tools

- #2 JIS screwdriver with a magnetic tip

### After performing service

- Connect the cable from the finisher to the printer.
- Connect the cable from the bridge unit to the finisher.
- Attach the finisher to the printer, and then push in on the release latch inside the finisher door.
- Connect the printer power cable.
- Turn the printer power on.


### Post service test

Process a job through the finisher and verify that the finisher works correctly.

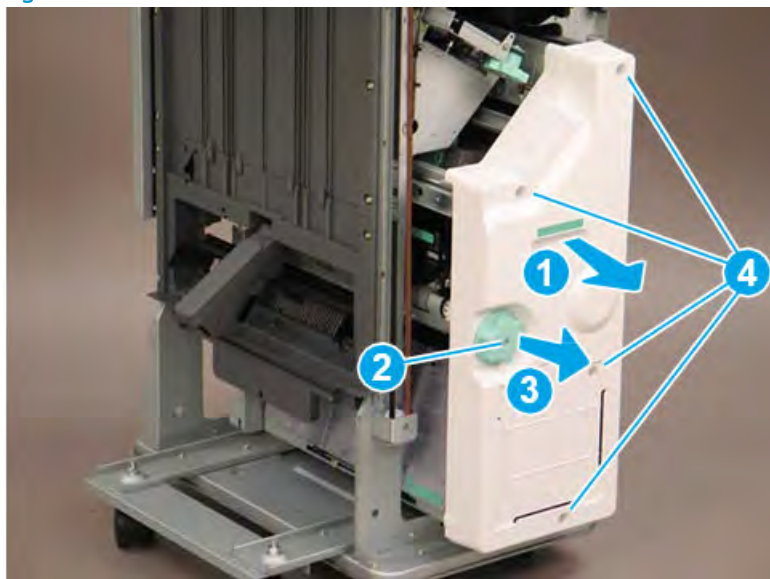
## Remove the booklet front cover

Follow these steps to remove the booklet front cover.

- ▲ Slide the booklet maker slightly away from the finisher (callout 1). Remove one screw (callout 2), and then slide the green knob away from the booklet maker to remove it (callout 3). Remove four screws (callout 4), and then remove the booklet front cover.

 **TIP:** Reverse the removal steps to install the assembly

**Figure 5-1768** Remove five screws and the cover

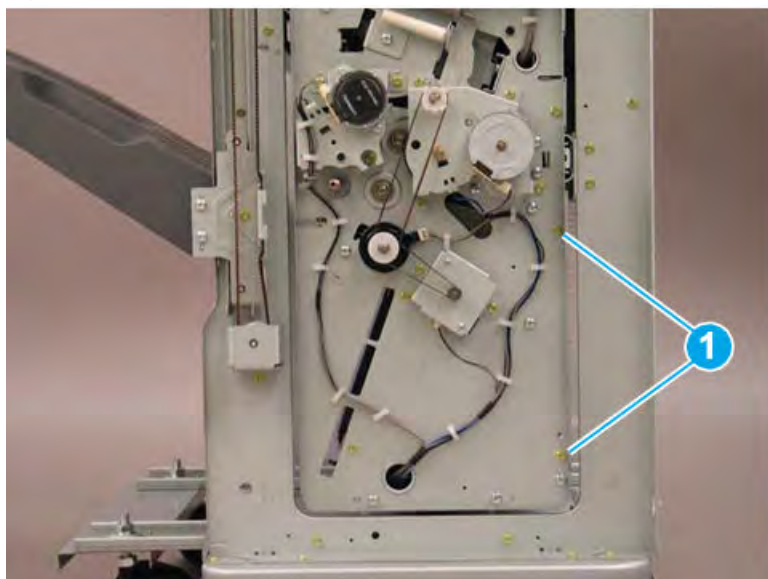


## Remove the booklet right lower shield

Follow these steps to remove the booklet right lower shield.

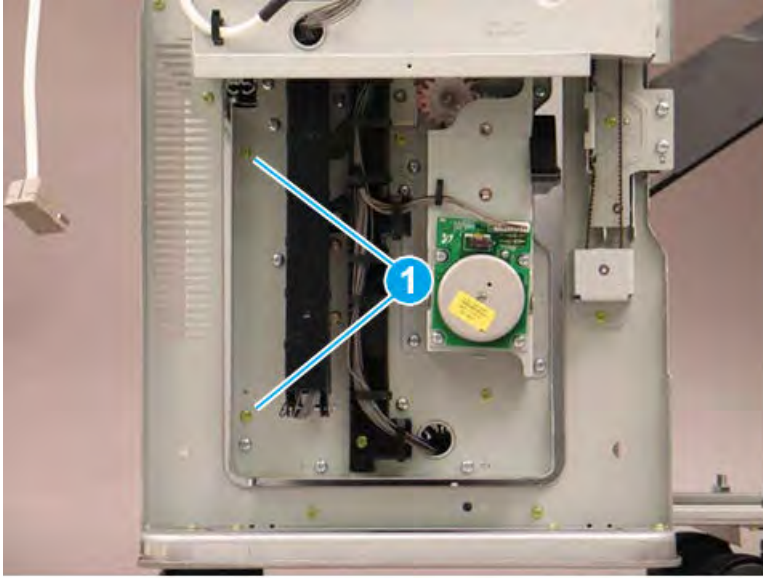
1. Remove two screws at the front of the booklet maker (callout 1).

**Figure 5-1769** Remove two screws



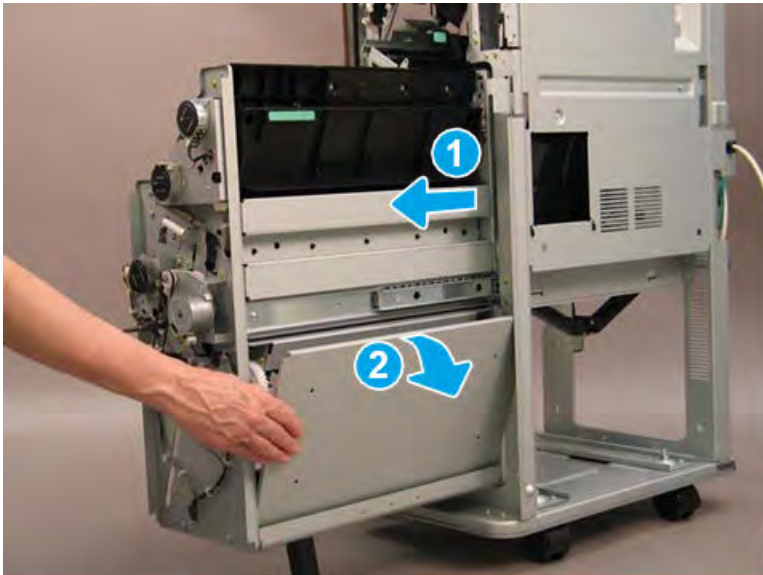
2. Remove two screws at the back of the booklet maker (callout 1).

Figure 5-1770 Remove two screws



3. Slide the booklet maker out of the finisher (callout 1), and then rotate the top of the right lower shield (callout 2) away from the booklet maker to remove it.

Figure 5-1771 Remove the right lower shield



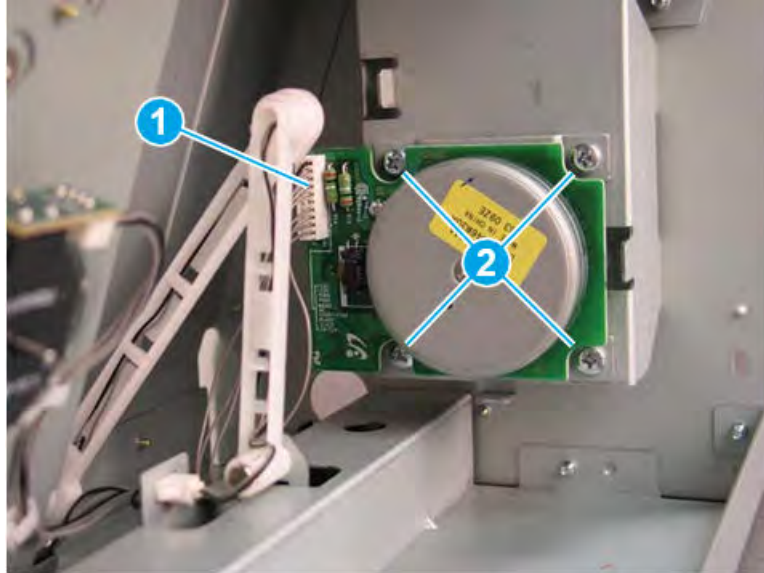
### Remove the booklet blade motor (M22)

Follow these steps to remove the booklet blade motor (M22).

- ▲ Disconnect one connector (callout 1), remove four screws (callout 2), and then remove the booklet blade motor.

💡 **TIP:** Reverse the removal steps to install the assembly.

Figure 5-1772 Remove the booklet blade motor



### Unpack the replacement assembly



Follow these steps to unpack the replacement assembly.


1. Dispose of the defective part.


 **NOTE:** HP recommends responsible disposal of the defective part.

<http://www8.hp.com/us/en/hp-information/environment/product-recycling.html>


2. Unpack the replacement part from the packaging.

 **CAUTION:**  Some parts are sensitive to electrostatic discharge (ESD). Always perform service work at an ESD-protected workstation or mat. If an ESD workstation or mat is not available, touch the sheet-metal chassis to provide a static ground before touching an ESD-sensitive assembly. Protect the ESD-sensitive assemblies by placing them in ESD pouches when they are out of the printer.

 **IMPORTANT:** Make sure that all of the shipping materials (for example shipping tape) are removed from the replacement part prior to installation.

 **NOTE:** If the replacement part is a roller or pad, avoid touching the spongy part of it. Skin oils on the roller or pad can cause paper pickup and/or print-quality problems. HP recommends using disposable gloves when handling rollers or pads or washing your hands before touching rollers or pads.

3. To install an assembly, reverse the removal steps.


 **NOTE:** When applicable, special installation instructions are provided for an assembly at the end of the removal procedure. Always completely read the removal instructions and follow all special installation instructions.

## Removal and replacement: Booklet fold motor (M21)

Learn how to remove and replace the booklet fold motor.

### Introduction

This document provides the procedures to remove and replace the booklet fold motor on the finisher.

 **IMPORTANT:** When applicable, special installation instructions are provided for an assembly at the end of the removal procedure. Always completely read the removal instructions and follow all special installation instructions.

### Before performing service

- Turn the printer power off. A shutting-down message appears on the control-panel display.
- ⚠ **WARNING!** To avoid damage to the printer, turn the power off and wait until the printer shuts down before removing the power cable.
- Disconnect the printer power cable after the printer has completely shut down (the control-panel display is blank).
- Release the finisher from the printer by pulling out on the release latch inside the finisher door.
- Disconnect the cable from the bridge unit to the finisher.
- Disconnect the cable from the finisher to the printer.

Use the table below to identify the correct part number for your printer. To order the part, go to <https://parts.hp.com>.

**Table 5-161** Part information

Part number	Part description
JC90-01436A	Booklet fold motor assembly
JC31-00144A	Booklet fold motor

### Required tools

- #2 JIS screwdriver with a magnetic tip

### After performing service

- Connect the cable from the finisher to the printer.
- Connect the cable from the bridge unit to the finisher.
- Attach the finisher to the printer, and then push in on the release latch inside the finisher door.
- Connect the printer power cable.
- Turn the printer power on.

### Post service test

Process a job through the finisher and verify that the finisher works correctly.



### Remove the right upper cover (finisher)

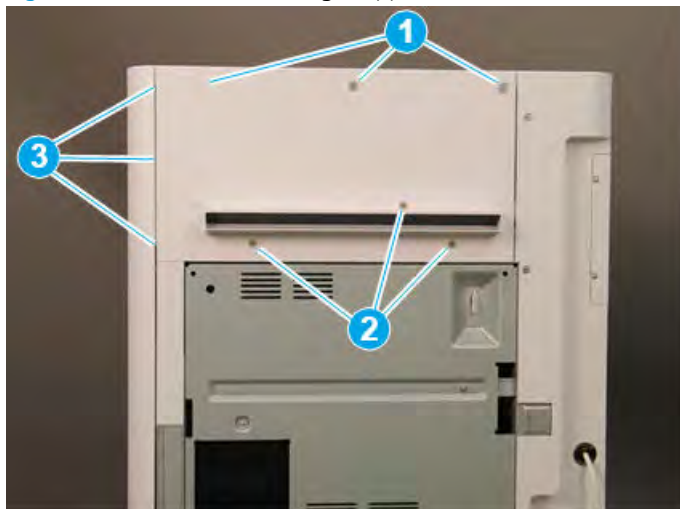
Follow these steps to remove the right upper cover (finisher).

- ▲ Remove one screw cap and three machine screws on the upper edge of the cover (callout 1). Remove three sheet metal screws (callout 2) on the lower portion of the cover. Rotate the right edge of the cover away from the finisher, and then slide the cover right to release three tabs (callout 3).

💡 **TIP:** The lower screws are shorter in length than the upper screws.

**TIP:** Reverse the removal steps to install the assembly.

Figure 5-1773 Remove the right upper cover

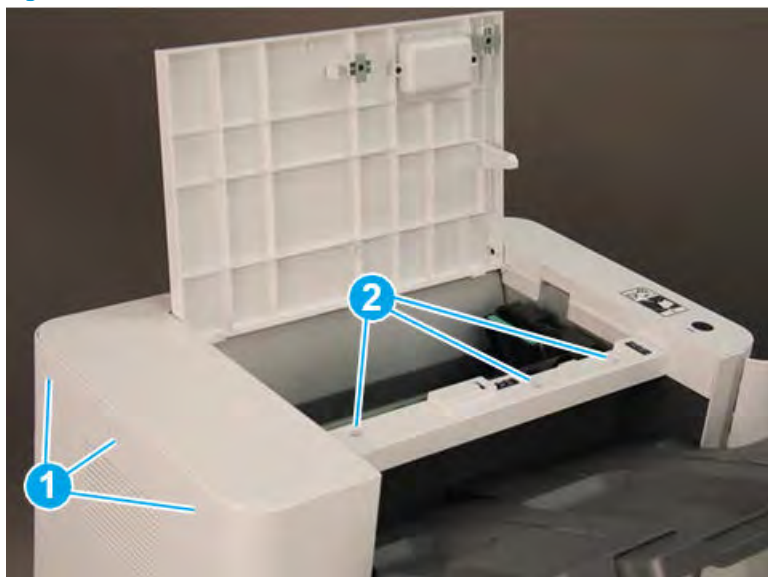


### Remove the top cover (finisher)

Follow these steps to remove the top cover (finisher).

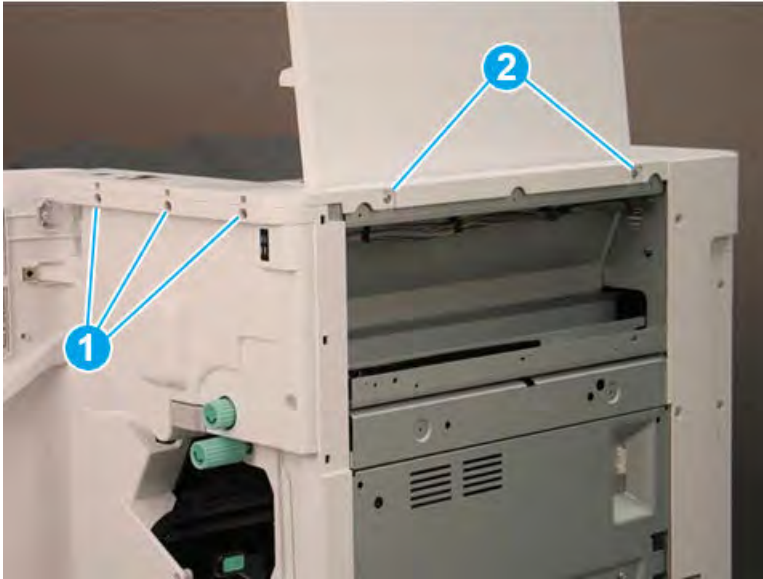
1. Remove three screw caps and three self-tapping screws at the top of the rear cover (callout 1), and then remove three machine screws (callout 2) on top of the cover.

Figure 5-1774 Remove six screws




2. Remove three self-tapping screws at the top of the front cover (callout 1), and then remove two machine screws (callout 2) at the top of the right side.

Figure 5-1775 Remove five screws



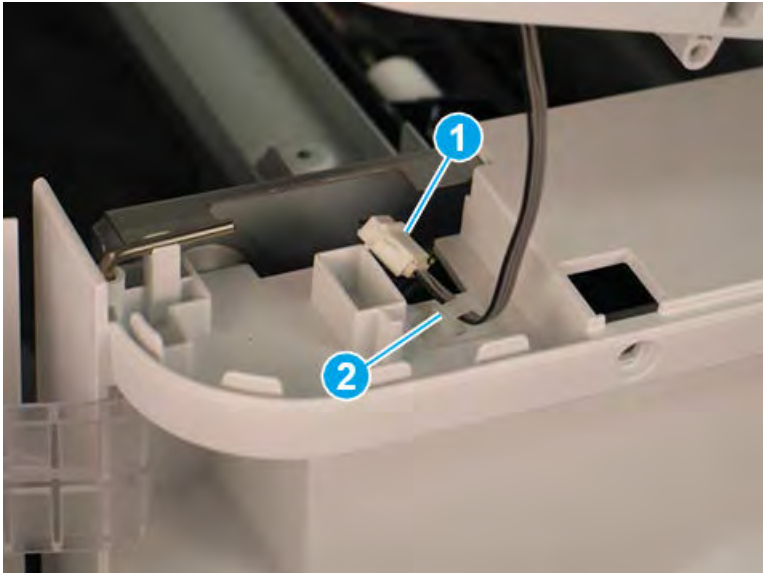
3. Lift the cover up slightly. Disconnect one in-line connector (callout 1), and then release one retainer (callout 2).

---

 **TIP:** Reverse the removal steps to install the assembly.

---

Figure 5-1776 Disconnect one connector and release retainer

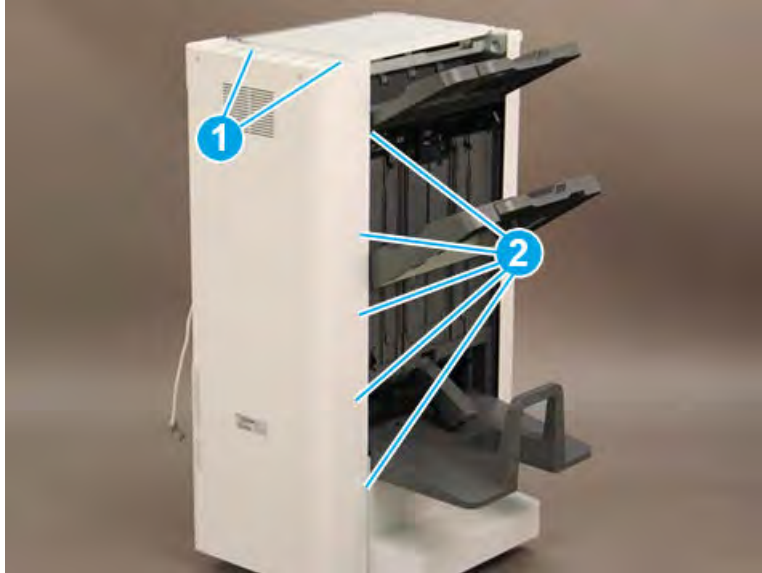


### Remove the rear cover (finisher)

Follow these steps to remove the rear cover (finisher).

1. Remove two self-tapping screws (callout 1) on the top of the rear cover, and then remove five screw caps and five machine screws (callout 2) on the left side of the cover.

Figure 5-1777 Remove seven screws



2. Remove one screw cap and four machine screws (callout 1) Remove the rear cover.

 **NOTE:** Make sure to thread the power cable (callout 2) through the opening in the cover.


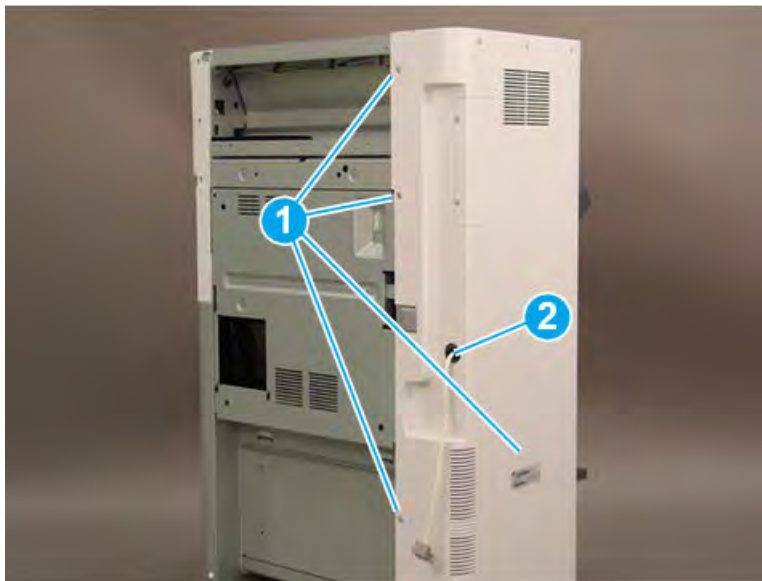
 **TIP:** Reverse the removal steps to install the assembly

Figure 5-1778 Remove the rear cover



### Remove the booklet fold motor (M21)

Follow these steps to remove the booklet fold motor (M21).

- ▲ Disconnect one connector (callout 1), remove four screws (callout 2), and then remove the folding roller motor.


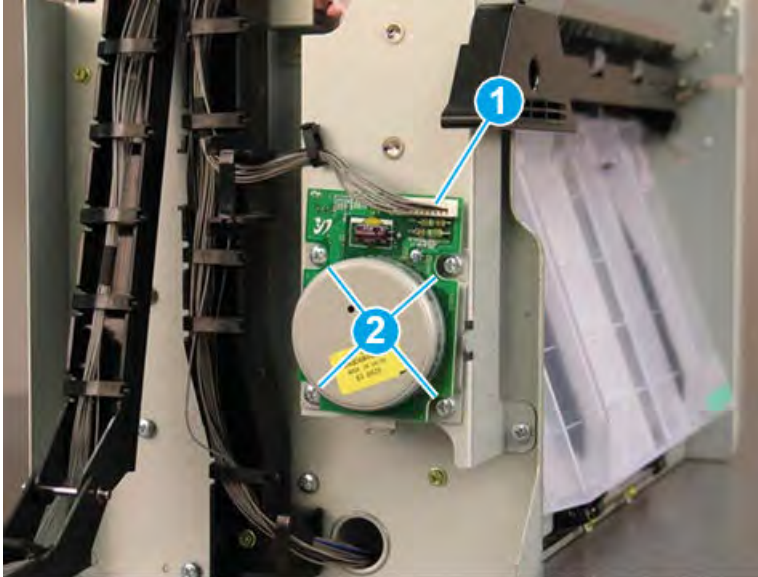
 **TIP:** Reverse the removal steps to install the assembly.

Figure 5-1779 Remove the booklet fold motor



### Unpack the replacement assembly

Follow these steps to unpack the replacement assembly.

1. Dispose of the defective part.

---



 **NOTE:** HP recommends responsible disposal of the defective part.


<http://www8.hp.com/us/en/hp-information/environment/product-recycling.html>


---

2. Unpack the replacement part from the packaging.

---

 **CAUTION:**  Some parts are sensitive to electrostatic discharge (ESD). Always perform service work at an ESD-protected workstation or mat. If an ESD workstation or mat is not available, touch the sheet-metal chassis to provide a static ground before touching an ESD-sensitive assembly. Protect the ESD-sensitive assemblies by placing them in ESD pouches when they are out of the printer.


 **IMPORTANT:** Make sure that all of the shipping materials (for example shipping tape) are removed from the replacement part prior to installation.

 **NOTE:** If the replacement part is a roller or pad, avoid touching the spongy part of it. Skin oils on the roller or pad can cause paper pickup and/or print-quality problems. HP recommends using disposable gloves when handling rollers or pads or washing your hands before touching rollers or pads.

---

3. To install an assembly, reverse the removal steps.

---

 **NOTE:** When applicable, special installation instructions are provided for an assembly at the end of the removal procedure. Always completely read the removal instructions and follow all special installation instructions.


---

## Removal and replacement: Booklet c-fold blade

Learn how to remove and replace the booklet c-fold blade.

### Introduction

This document provides the procedures to remove and replace the booklet c-fold blade on the finisher.

 **IMPORTANT:** When applicable, special installation instructions are provided for an assembly at the end of the removal procedure. Always completely read the removal instructions and follow all special installation instructions.

### Before performing service

- Turn the printer power off. A shutting-down message appears on the control-panel display.
- ⚠ **WARNING!** To avoid damage to the printer, turn the power off and wait until the printer shuts down before removing the power cable.
- Disconnect the printer power cable after the printer has completely shut down (the control-panel display is blank).
- Release the finisher from the printer by pulling out on the release latch inside the finisher door.
- Disconnect the cable from the bridge unit to the finisher.
- Disconnect the cable from the finisher to the printer.

Use the table below to identify the correct part number for your printer. To order the part, go to <https://parts.hp.com>.

**Table 5-162 Part information**

Part number	Part description
JC61-07366A	Booklet c-fold blade

### Required tools

- #2 JIS screwdriver with a magnetic tip

### After performing service

- Connect the cable from the finisher to the printer.
- Connect the cable from the bridge unit to the finisher.
- Attach the finisher to the printer, and then push in on the release latch inside the finisher door.
- Connect the printer power cable.
- Turn the printer power on.

### Post service test

Process a job through the finisher and verify that the finisher works correctly.

## Remove the right upper cover (finisher)

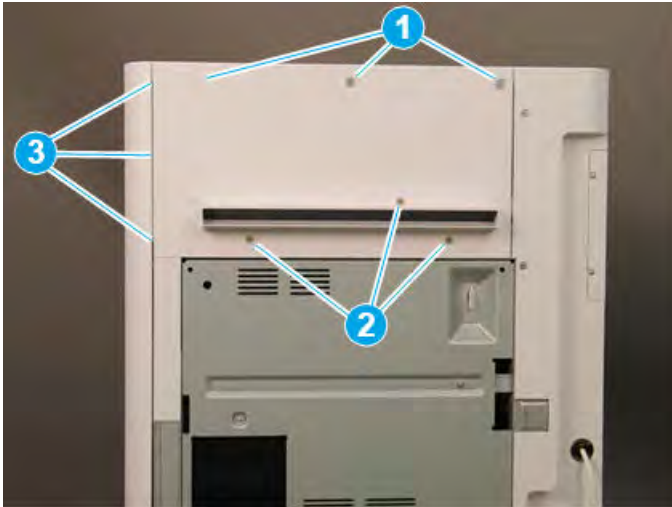
Follow these steps to remove the right upper cover (finisher).

- ▲ Remove one screw cap and three machine screws on the upper edge of the cover (callout 1). Remove three sheet metal screws (callout 2) on the lower portion of the cover. Rotate the right edge of the cover away from the finisher, and then slide the cover right to release three tabs (callout 3).

💡 **TIP:** The lower screws are shorter in length than the upper screws.

**TIP:** Reverse the removal steps to install the assembly.

**Figure 5-1780** Remove the right upper cover

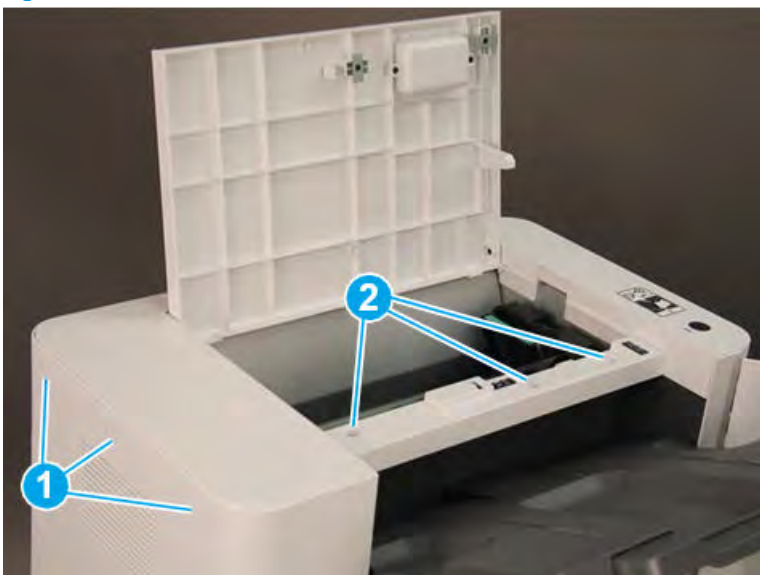


## Remove the top cover (finisher)

Follow these steps to remove the top cover (finisher).

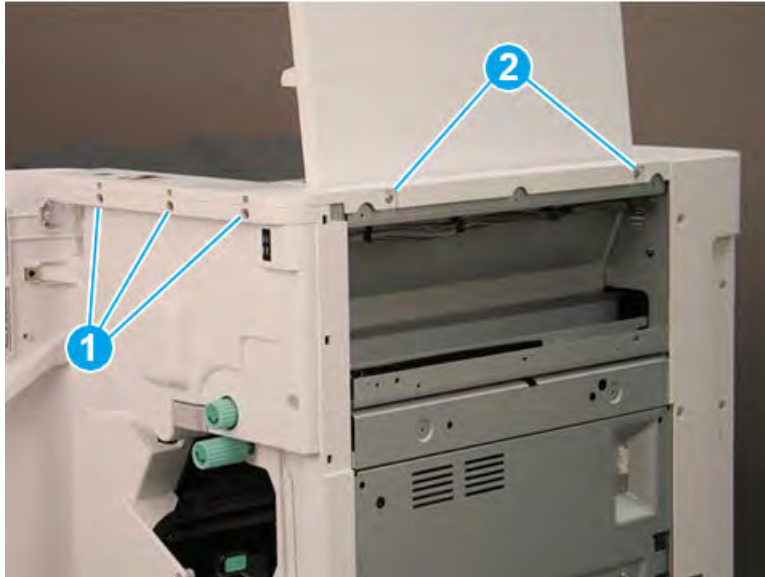
1. Remove three screw caps and three self-tapping screws at the top of the rear cover (callout 1), and then remove three machine screws (callout 2) on top of the cover.

**Figure 5-1781** Remove six screws



2. Remove three self-tapping screws at the top of the front cover (callout 1), and then remove two machine screws (callout 2) at the top of the right side.

Figure 5-1782 Remove five screws



3. Lift the cover up slightly. Disconnect one in-line connector (callout 1), and then release one retainer (callout 2).


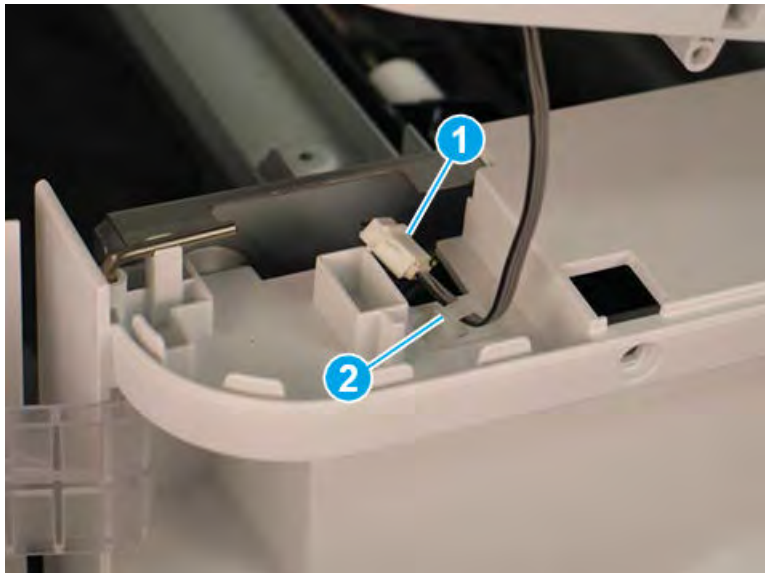
 **TIP:** Reverse the removal steps to install the assembly.

Figure 5-1783 Disconnect one connector and release retainer

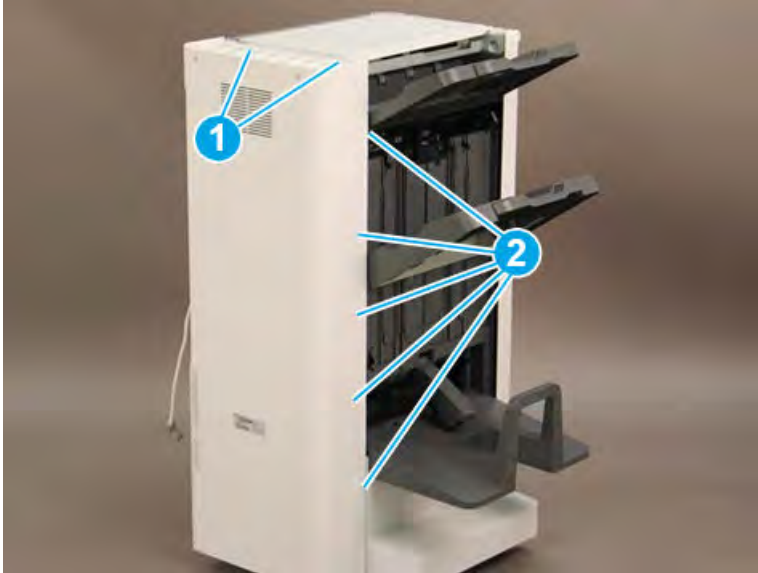


### Remove the rear cover (finisher)


Follow these steps to remove the rear cover (finisher).

1. Remove two self-tapping screws (callout 1) on the top of the rear cover, and then remove five screw caps and five machine screws (callout 2) on the left side of the cover.

Figure 5-1784 Remove seven screws

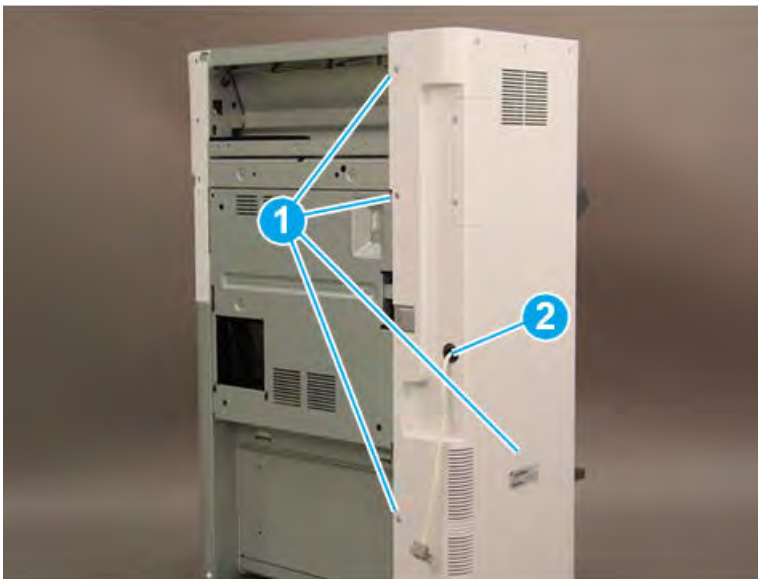


2. Remove one screw cap and four machine screws (callout 1) Remove the rear cover.

 **NOTE:** Make sure to thread the power cable (callout 2) through the opening in the cover.

 **TIP:** Reverse the removal steps to install the assembly

Figure 5-1785 Remove the rear cover



### Remove the booklet maker

Follow these steps to remove the booklet maker.

1. Slide the booklet maker away from the finisher.

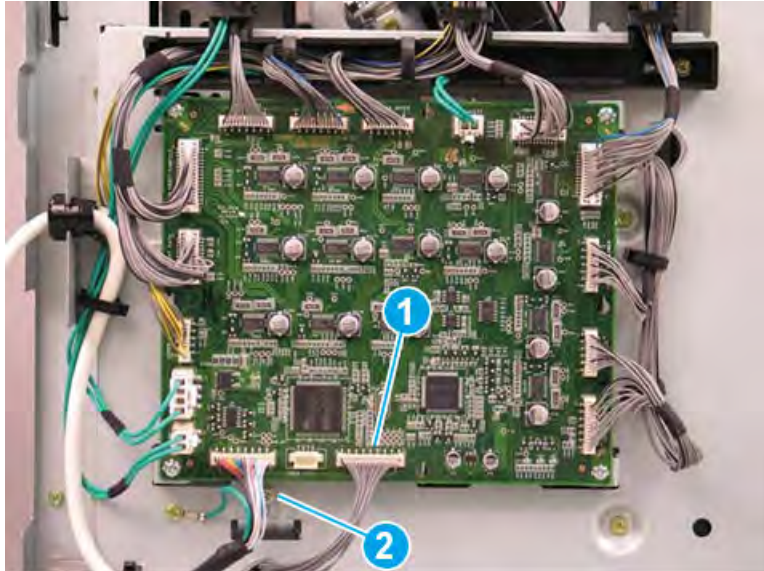


Figure 5-1786 Slide the booklet maker away from the finisher



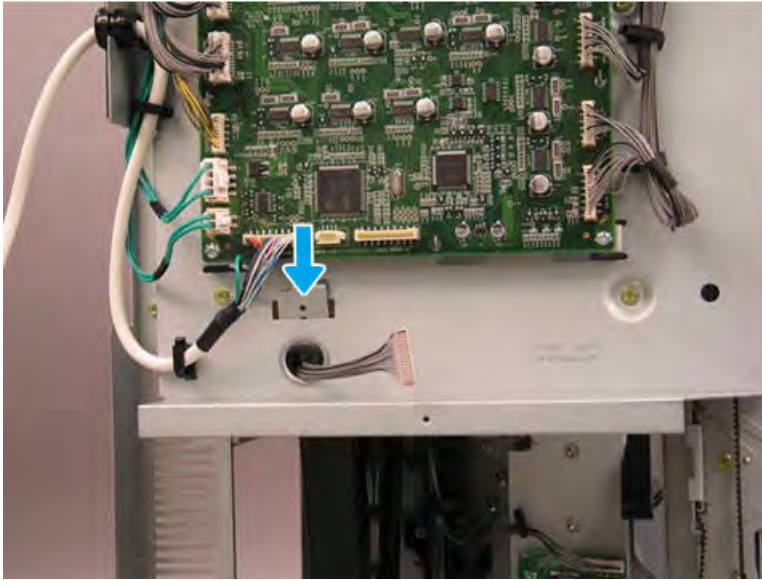
2. At the Disconnect one connector (callout 1), and then remove one screw (callout 2).

Figure 5-1787 Disconnect one connector and remove one screw



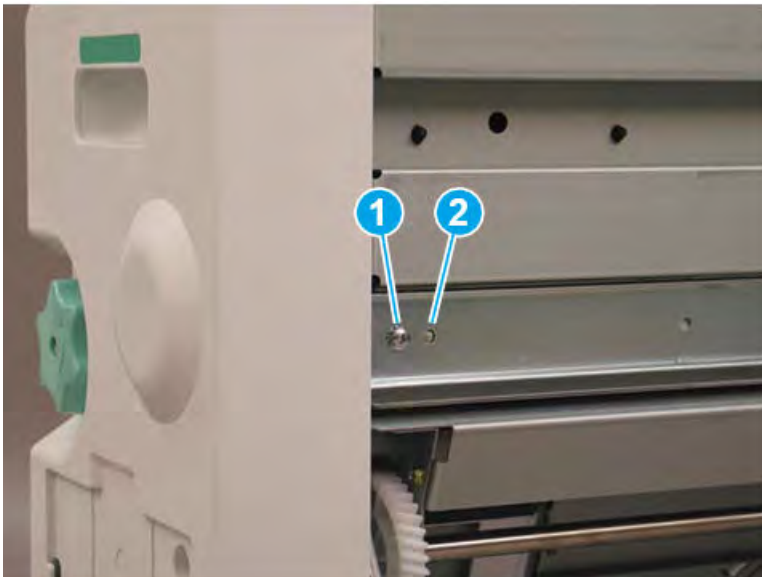
3. Release the metal bracket through the opening in the sheet metal.

Figure 5-1788 Release the metal bracket



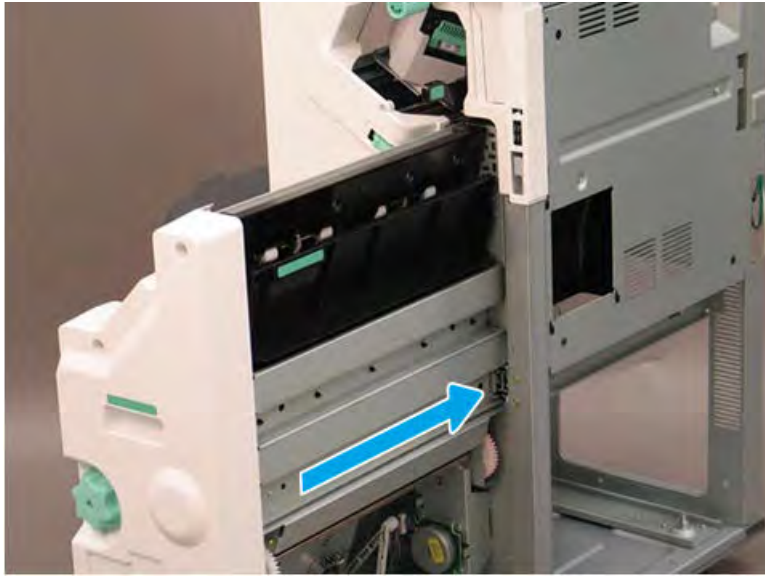
4. Remove one star-washer screw (callout 1), and then release the alignment pin (callout 2) on the right side of the booklet maker.

Figure 5-1789 Remove one screw



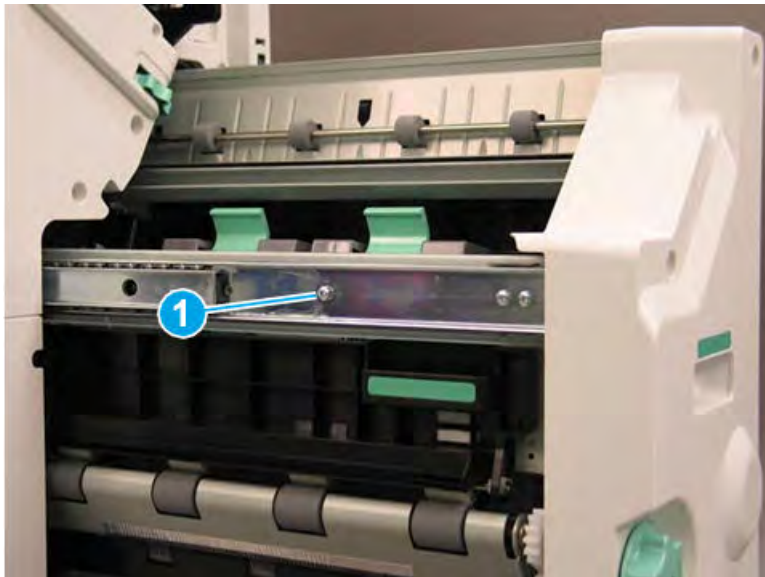
5. Slide the right rail toward the finisher.

Figure 5-1790 Slide the right rail



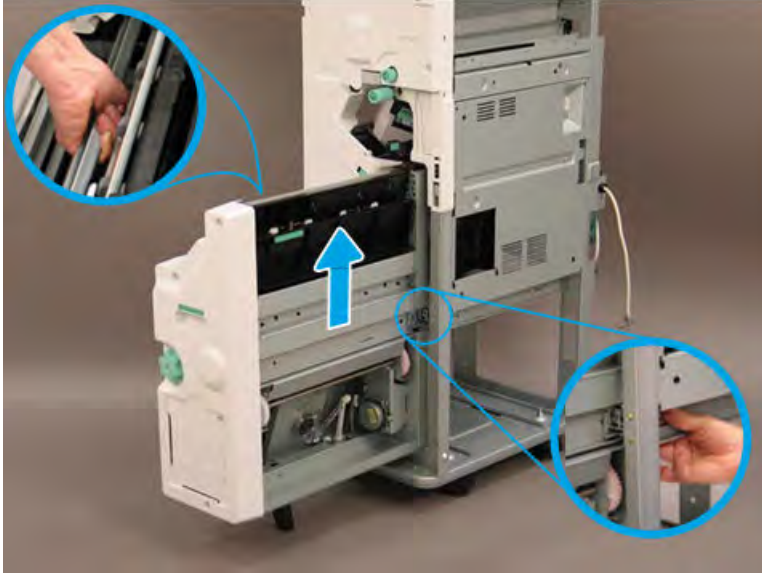
6. Remove one star-washer screw (callout 1) on the left side of the booklet maker.

Figure 5-1791 Remove one screw



7. Lift the booklet maker up on the left side while squeezing the right rail away from the finisher slightly to clear the sheet metal. Remove the booklet maker.

Figure 5-1792 Remove the booklet maker



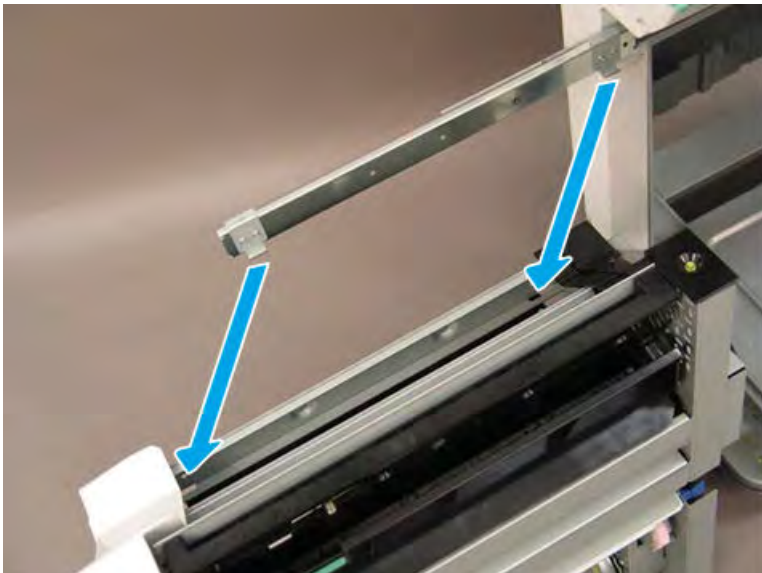
8. Reverse the removal steps to install the assembly. Also use the following special installation instructions.

 **NOTE:** Continue to reverse the removal steps to finish installing the assembly.

**Special installation instructions: booklet maker**

When installing the booklet maker, position the hooks on the rail under the slots on the booklet maker.

Figure 5-1793 Position the hooks



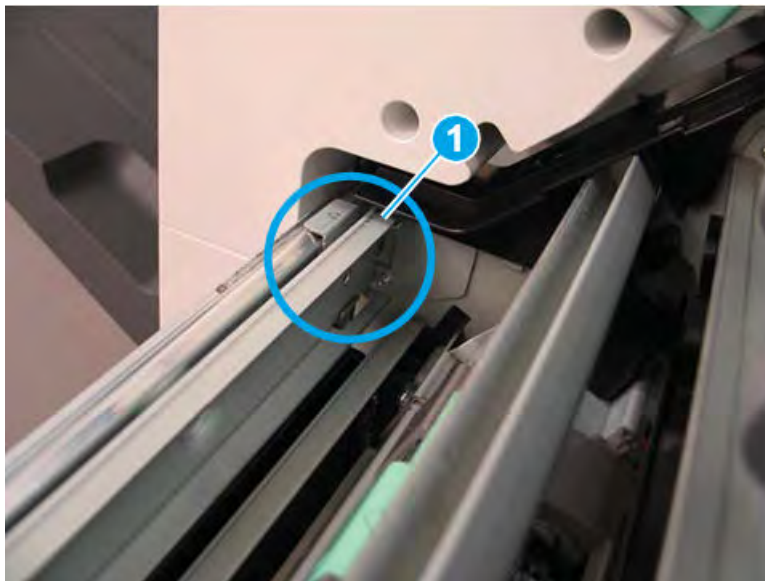
9. When installed correctly, the arrow on the front of the booklet maker aligns with the arrow on the finisher rail.

Figure 5-1794 Align arrows



10. When installed correctly, the arrow on the back of the booklet maker aligns with the arrow on the finisher rail.

Figure 5-1795 Align arrows



11. Extend the right rail away from the finisher and position it in the booklet maker slot.

Figure 5-1796 Extend the right rail



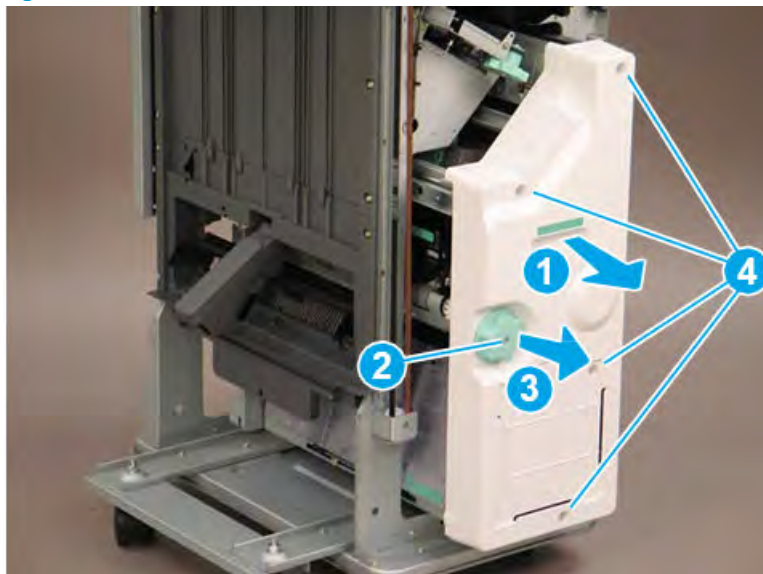
#### Remove the booklet front cover

Follow these steps to remove the booklet front cover.

- ▲ Slide the booklet maker slightly away from the finisher (callout 1). Remove one screw (callout 2), and then slide the green knob away from the booklet maker to remove it (callout 3). Remove four screws (callout 4), and then remove the booklet front cover.

 **TIP:** Reverse the removal steps to install the assembly

Figure 5-1797 Remove five screws and the cover

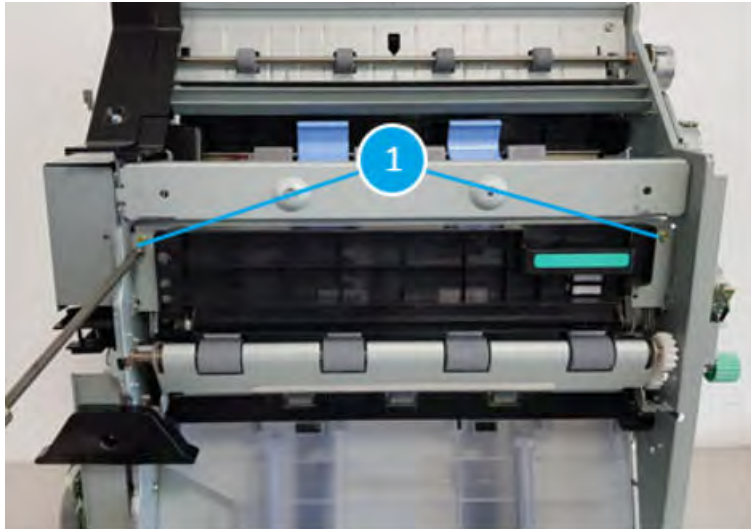


#### Remove the Booklet c-fold blade unit

Follow these steps to remove the Booklet c-fold blade unit.

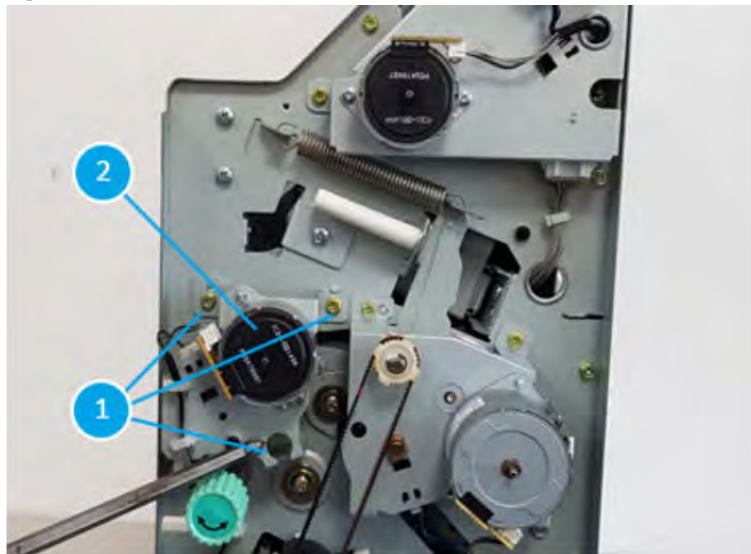
1. Remove two screws(callout 1) at the left of the booklet maker

Figure 5-1798 Remove two screws at the left of the booklet maker



2. Remove three screws(callout 1) at the front of the booklet maker to remove motor unit(callout 2) to reach out to the screw.

Figure 5-1799 Remove three screws to remove motor unit to reach out to the screw



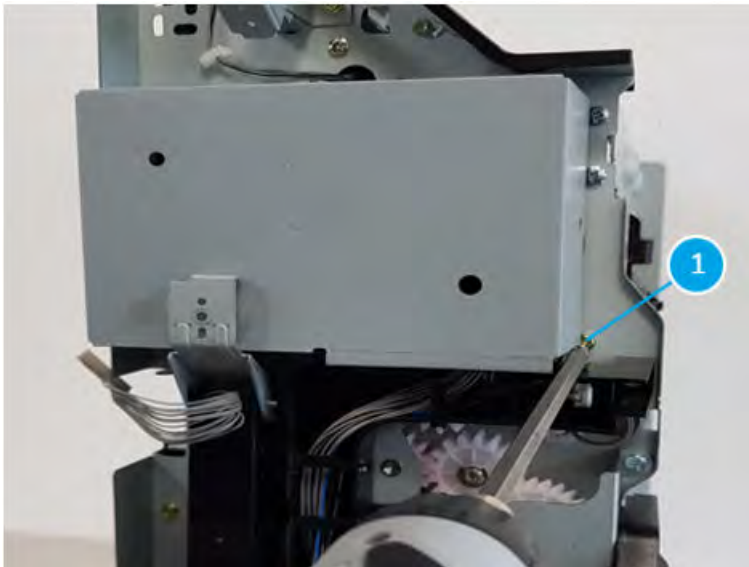
3. Remove one screw(callout 1) at the front of the booklet maker.

Figure 5-1800 Remove one screw at the front of the booklet maker



4. Remove one screw(callout 1) at the rear of the booklet maker.

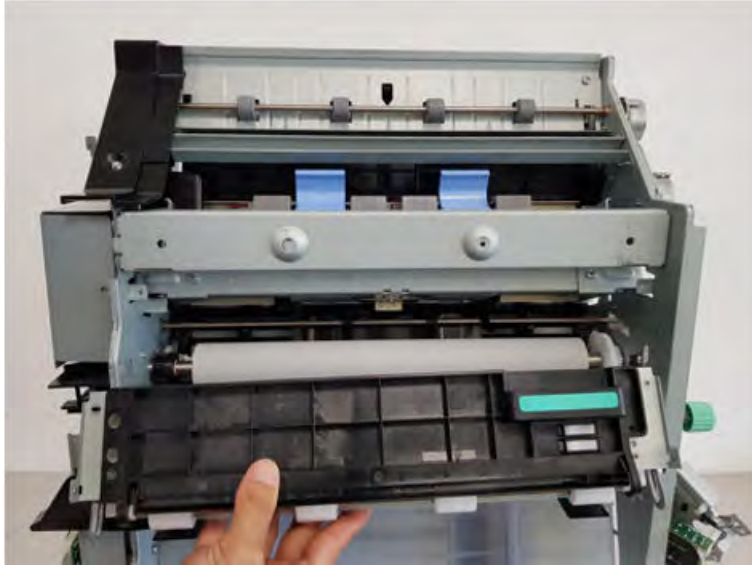
Figure 5-1801 Remove one screw at the rear of the booklet maker





5. Take the booklet c-fold blade unit out from the booklet maker.

**Figure 5-1802** Take the booklet c-fold blade unit out from the booklet maker

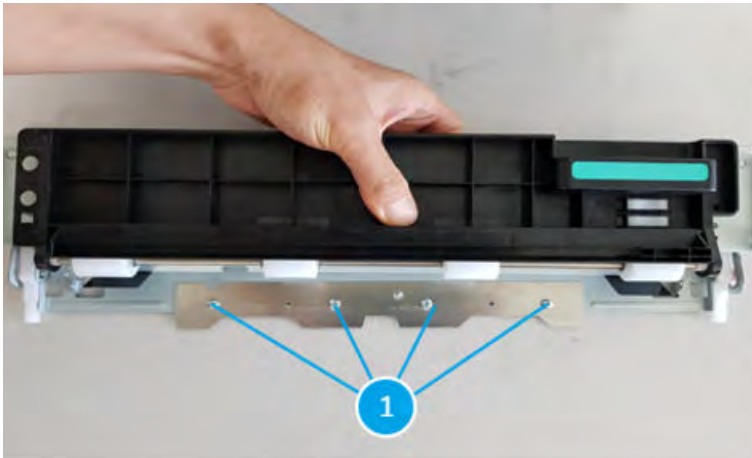


### Remove the Booklet c-fold blade

Follow these steps to remove the Booklet c-fold blade.

- ▲ Remove four screws (callout 1) to remove the booklet c-fold blade

**Figure 5-1803** Remove four screws to remove the booklet c-fold blade



 **NOTE:**

- Reverse the removal steps to install the assembly.
- Make sure the metal located on the home position when you reassemble the unit.  
You can make it by rotating the gear to the left direction.

 **TIP:** Rotate the white gear (callout 1) to the left direction to make the metal (callout 2) to the home position.



---

### Unpack the replacement assembly

Follow these steps to unpack the replacement assembly.

1. Dispose of the defective part.



---

 **NOTE:** HP recommends responsible disposal of the defective part.


<http://www8.hp.com/us/en/hp-information/environment/product-recycling.html>

---

2. Unpack the replacement part from the packaging.


 **CAUTION:**  Some parts are sensitive to electrostatic discharge (ESD). Always perform service work at an ESD-protected workstation or mat. If an ESD workstation or mat is not available, touch the sheet-metal chassis to provide a static ground before touching an ESD-sensitive assembly. Protect the ESD-sensitive assemblies by placing them in ESD pouches when they are out of the printer.

 **IMPORTANT:** Make sure that all of the shipping materials (for example shipping tape) are removed from the replacement part prior to installation.

 **NOTE:** If the replacement part is a roller or pad, avoid touching the spongy part of it. Skin oils on the roller or pad can cause paper pickup and/or print-quality problems. HP recommends using disposable gloves when handling rollers or pads or washing your hands before touching rollers or pads.

---

3. To install an assembly, reverse the removal steps.

 **NOTE:** When applicable, special installation instructions are provided for an assembly at the end of the removal procedure. Always completely read the removal instructions and follow all special installation instructions.

---

## Removal and replacement: Booklet c-fold blade home sensor (S39)

Learn how to remove and replace the booklet c-fold blade home sensor.

### Introduction

This document provides the procedures to remove and replace the booklet c-fold blade home sensor on the finisher.



**IMPORTANT:** When applicable, special installation instructions are provided for an assembly at the end of the removal procedure. Always completely read the removal instructions and follow all special installation instructions.

### Before performing service

- Turn the printer power off. A shutting-down message appears on the control-panel display.
- ⚠ **WARNING!** To avoid damage to the printer, turn the power off and wait until the printer shuts down before removing the power cable.
- Disconnect the printer power cable after the printer has completely shut down (the control-panel display is blank).
- Release the finisher from the printer by pulling out on the release latch inside the finisher door.
- Disconnect the cable from the bridge unit to the finisher.
- Disconnect the cable from the finisher to the printer.

Use the table below to identify the correct part number for your printer. To order the part, go to <https://parts.hp.com>.

**Table 5-163** Part information

Part number	Part description
0604-001393	Booklet c-fold blade home sensor

### Required tools

- #2 JIS screwdriver with a magnetic tip

### After performing service

- Connect the cable from the finisher to the printer.
- Connect the cable from the bridge unit to the finisher.
- Attach the finisher to the printer, and then push in on the release latch inside the finisher door.
- Connect the printer power cable.
- Turn the printer power on.

### Post service test

Process a job through the finisher and verify that the finisher works correctly.

### Remove the right upper cover (finisher)

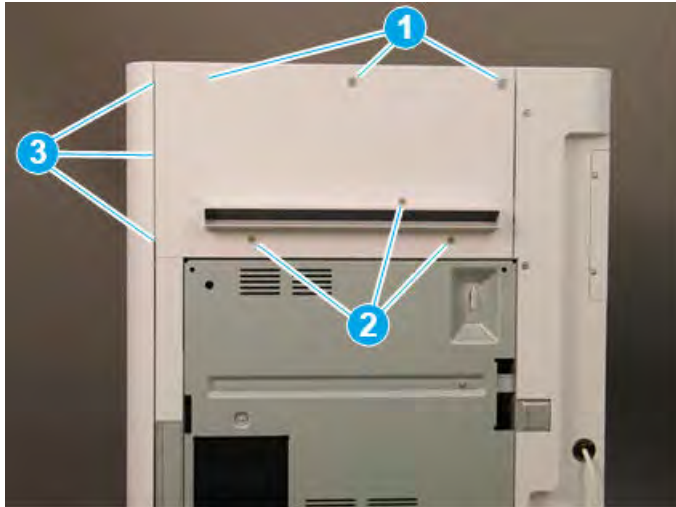
Follow these steps to remove the right upper cover (finisher).

- ▲ Remove one screw cap and three machine screws on the upper edge of the cover (callout 1). Remove three sheet metal screws (callout 2) on the lower portion of the cover. Rotate the right edge of the cover away from the finisher, and then slide the cover right to release three tabs (callout 3).

💡 **TIP:** The lower screws are shorter in length than the upper screws.

**TIP:** Reverse the removal steps to install the assembly.

Figure 5-1804 Remove the right upper cover

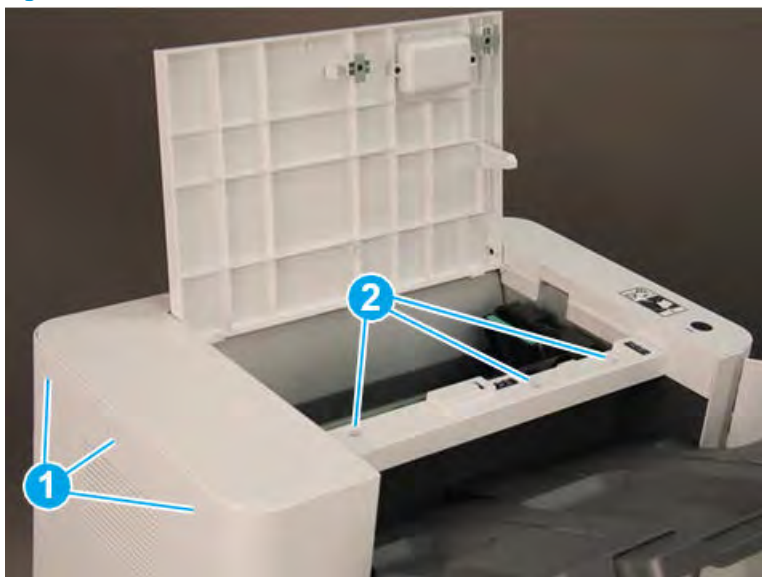


### Remove the top cover (finisher)

Follow these steps to remove the top cover (finisher).

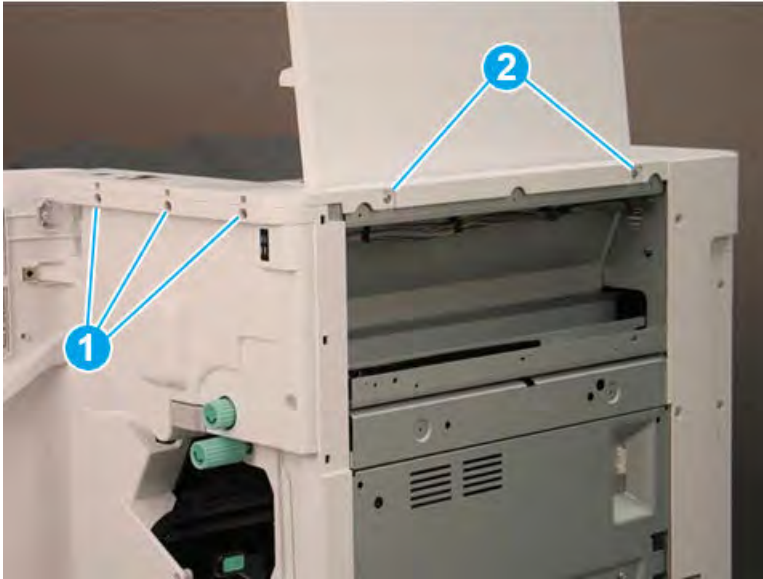
1. Remove three screw caps and three self-tapping screws at the top of the rear cover (callout 1), and then remove three machine screws (callout 2) on top of the cover.

Figure 5-1805 Remove six screws




2. Remove three self-tapping screws at the top of the front cover (callout 1), and then remove two machine screws (callout 2) at the top of the right side.

Figure 5-1806 Remove five screws



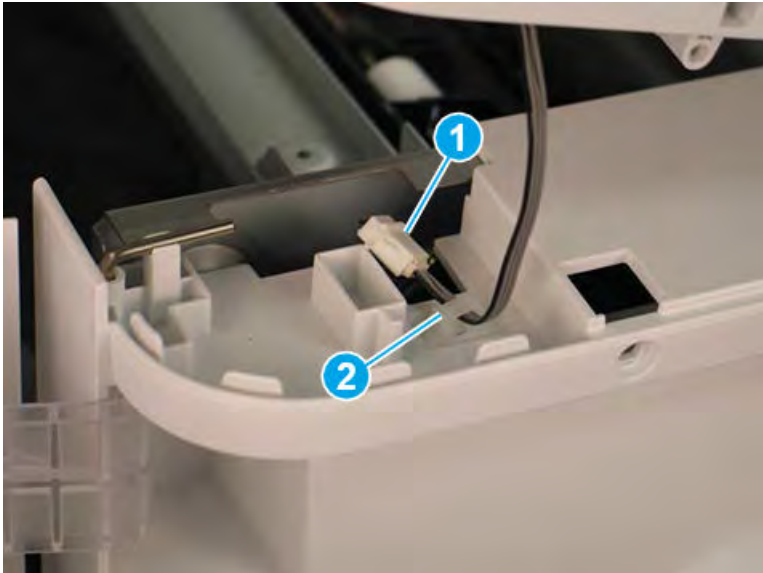
3. Lift the cover up slightly. Disconnect one in-line connector (callout 1), and then release one retainer (callout 2).

---

 **TIP:** Reverse the removal steps to install the assembly.

---

Figure 5-1807 Disconnect one connector and release retainer

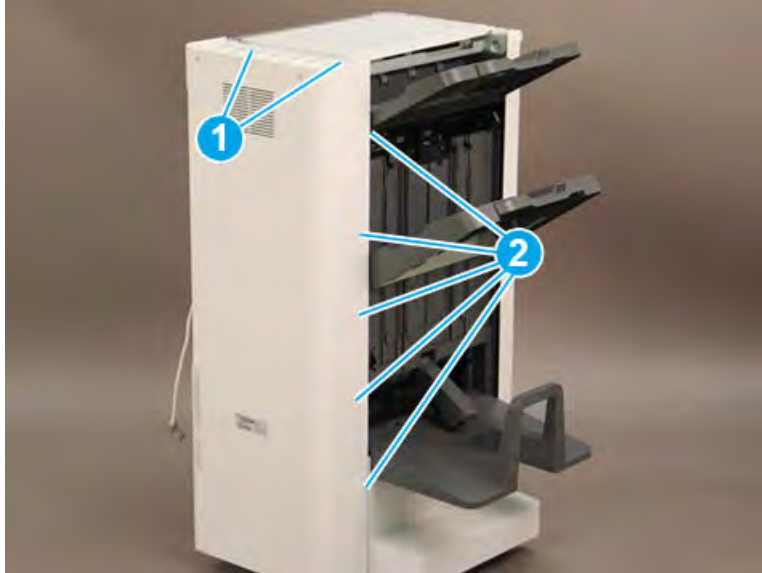


### Remove the rear cover (finisher)

Follow these steps to remove the rear cover (finisher).


1. Remove two self-tapping screws (callout 1) on the top of the rear cover, and then remove five screw caps and five machine screws (callout 2) on the left side of the cover.

Figure 5-1808 Remove seven screws



2. Remove one screw cap and four machine screws (callout 1) Remove the rear cover.

---

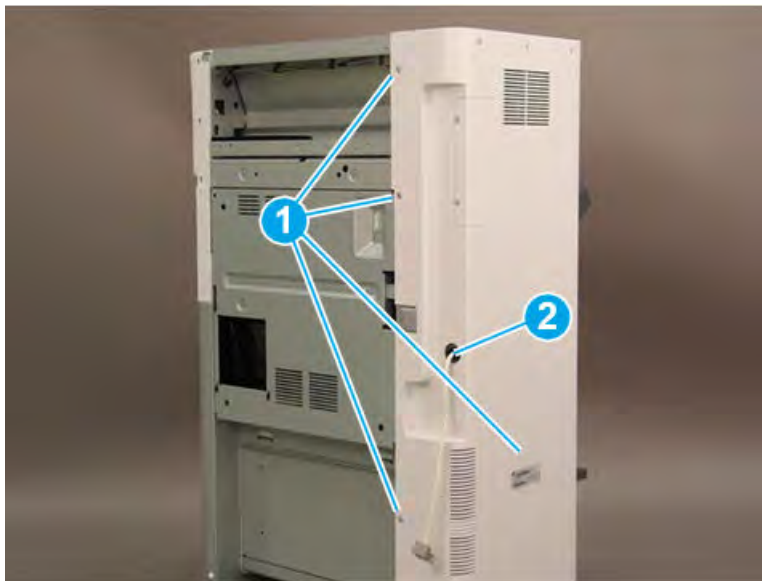
 **NOTE:** Make sure to thread the power cable (callout 2) through the opening in the cover.

---

 **TIP:** Reverse the removal steps to install the assembly

---

Figure 5-1809 Remove the rear cover



### Remove the booklet maker

Follow these steps to remove the booklet maker.

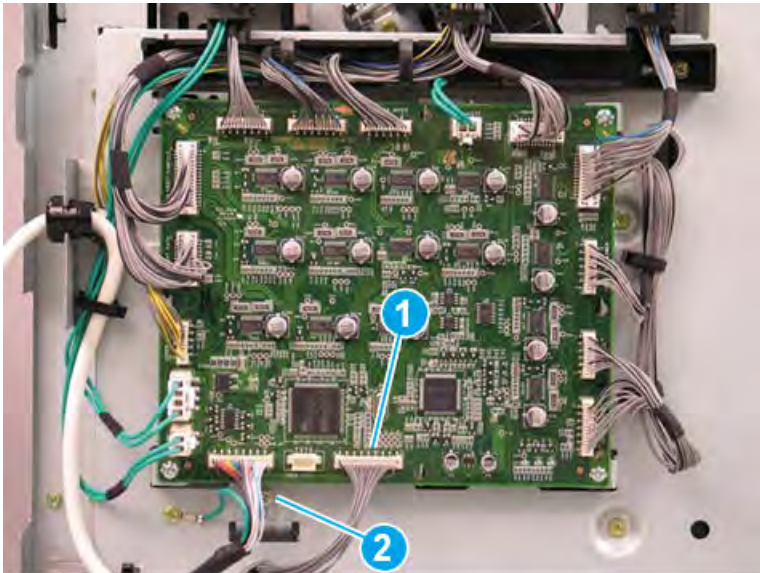
1. Slide the booklet maker away from the finisher.

Figure 5-1810 Slide the booklet maker away from the finisher



2. At the Disconnect one connector (callout 1), and then remove one screw (callout 2).

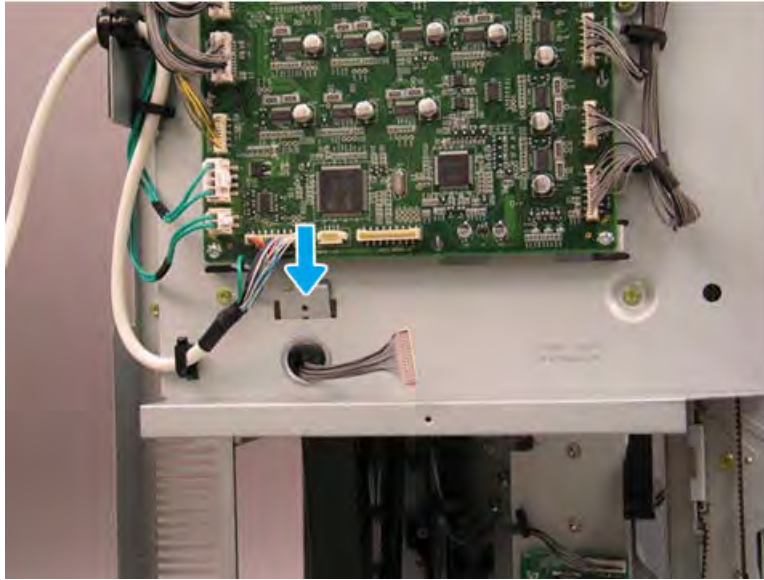
Figure 5-1811 Disconnect one connector and remove one screw





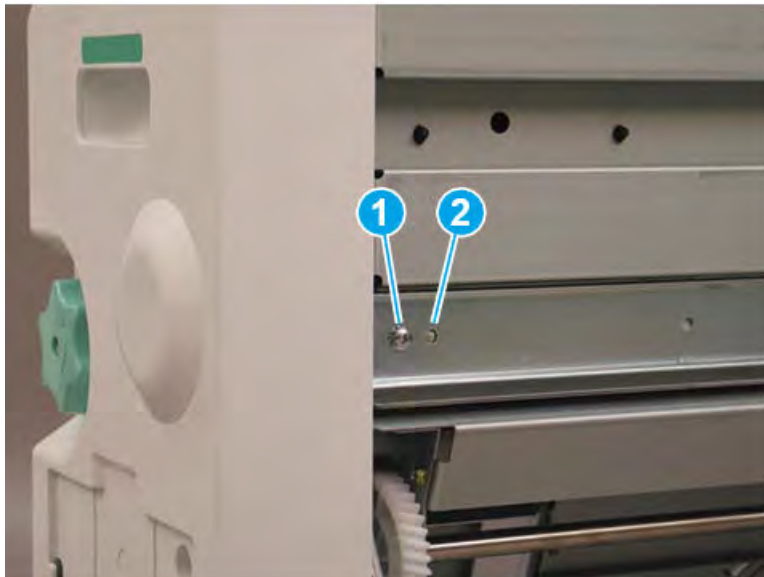
3. Release the metal bracket through the opening in the sheet metal.

Figure 5-1812 Release the metal bracket



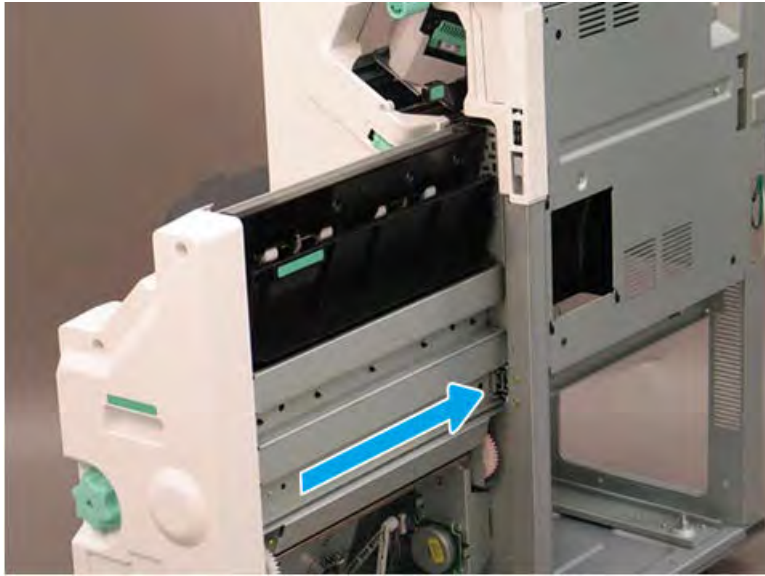
4. Remove one star-washer screw (callout 1), and then release the alignment pin (callout 2) on the right side of the booklet maker.

Figure 5-1813 Remove one screw



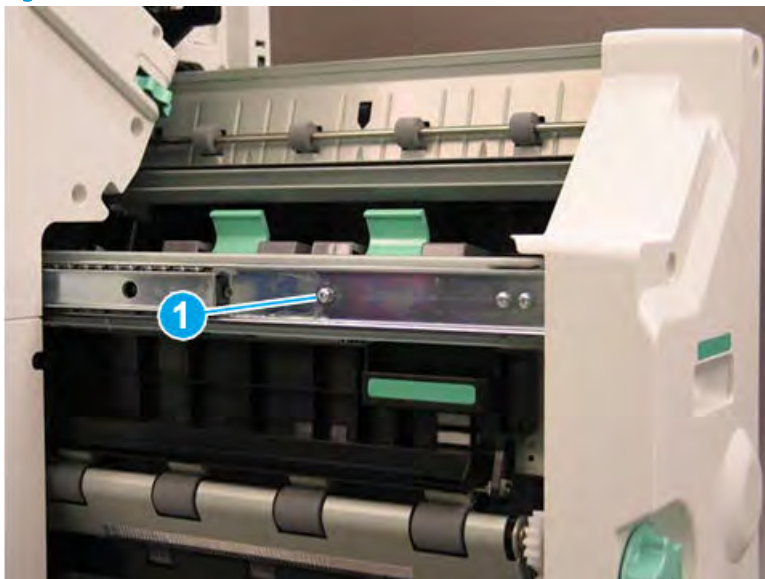
5. Slide the right rail toward the finisher.

Figure 5-1814 Slide the right rail



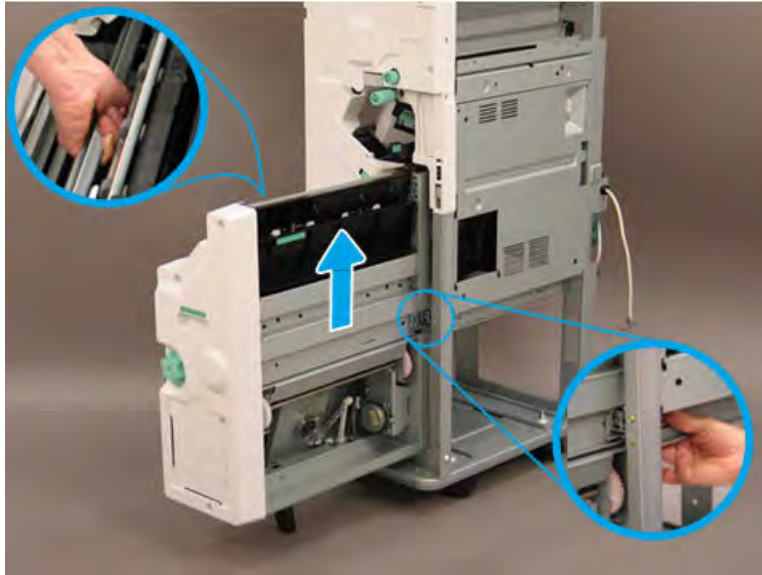
6. Remove one star-washer screw (callout 1) on the left side of the booklet maker.

Figure 5-1815 Remove one screw



7. Lift the booklet maker up on the left side while squeezing the right rail away from the finisher slightly to clear the sheet metal. Remove the booklet maker.

**Figure 5-1816** Remove the booklet maker



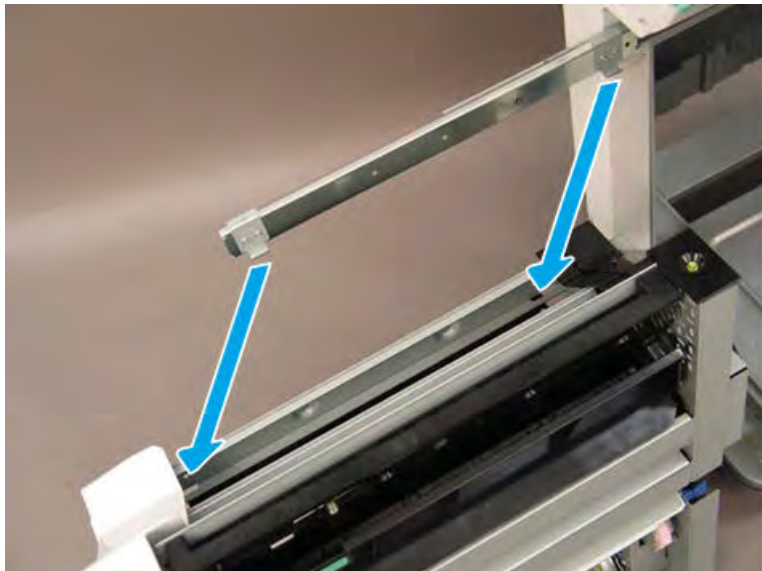
8. Reverse the removal steps to install the assembly. Also use the following special installation instructions.

 **NOTE:** Continue to reverse the removal steps to finish installing the assembly.

**Special installation instructions: booklet maker**

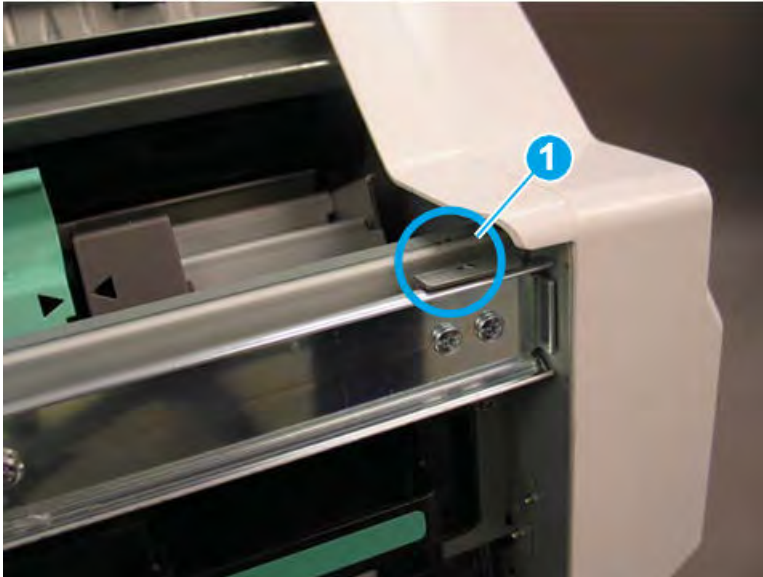
When installing the booklet maker, position the hooks on the rail under the slots on the booklet maker.

**Figure 5-1817** Position the hooks



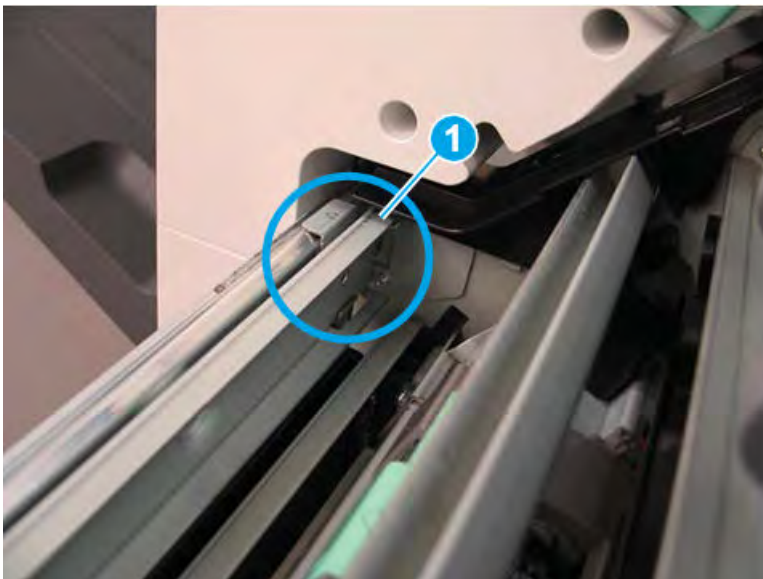
9. When installed correctly, the arrow on the front of the booklet maker aligns with the arrow on the finisher rail.

Figure 5-1818 Align arrows



10. When installed correctly, the arrow on the back of the booklet maker aligns with the arrow on the finisher rail.

Figure 5-1819 Align arrows



11. Extend the right rail away from the finisher and position it in the booklet maker slot.

Figure 5-1820 Extend the right rail



#### Remove the booklet front cover

Follow these steps to remove the booklet front cover.

- ▲ Slide the booklet maker slightly away from the finisher (callout 1). Remove one screw (callout 2), and then slide the green knob away from the booklet maker to remove it (callout 3). Remove four screws (callout 4), and then remove the booklet front cover.


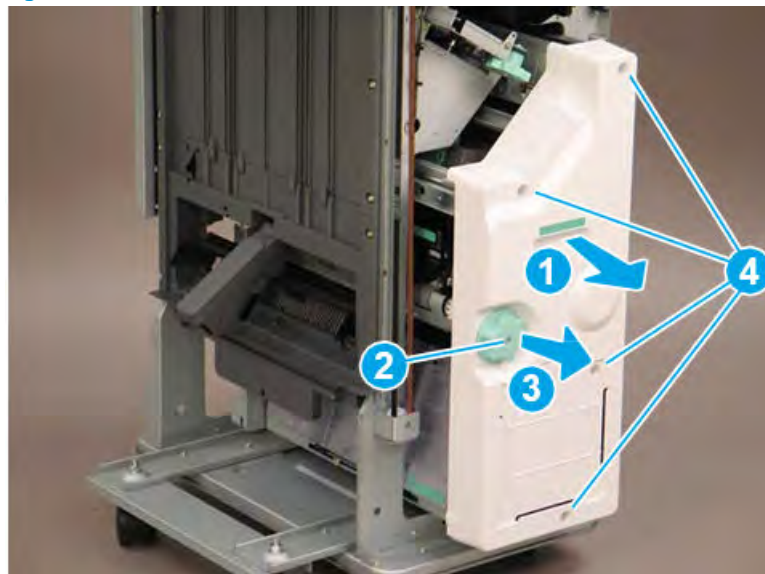
 **TIP:** Reverse the removal steps to install the assembly

Figure 5-1821 Remove five screws and the cover

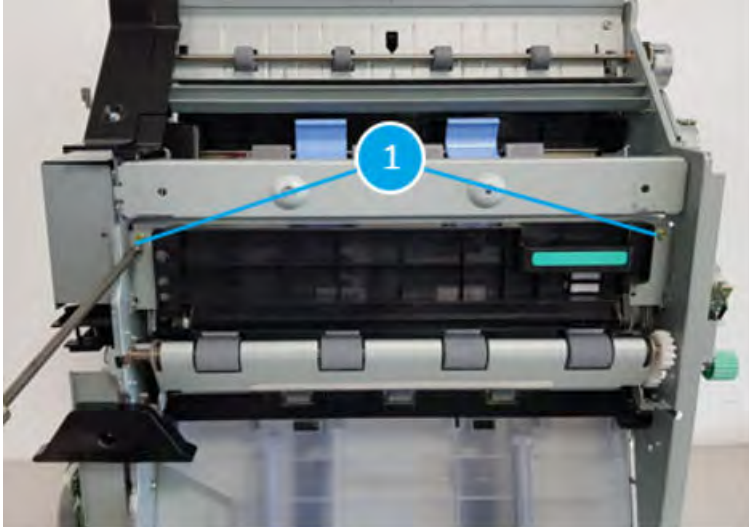


#### Remove the Booklet c-fold blade unit

Follow these steps to remove the Booklet c-fold blade unit.

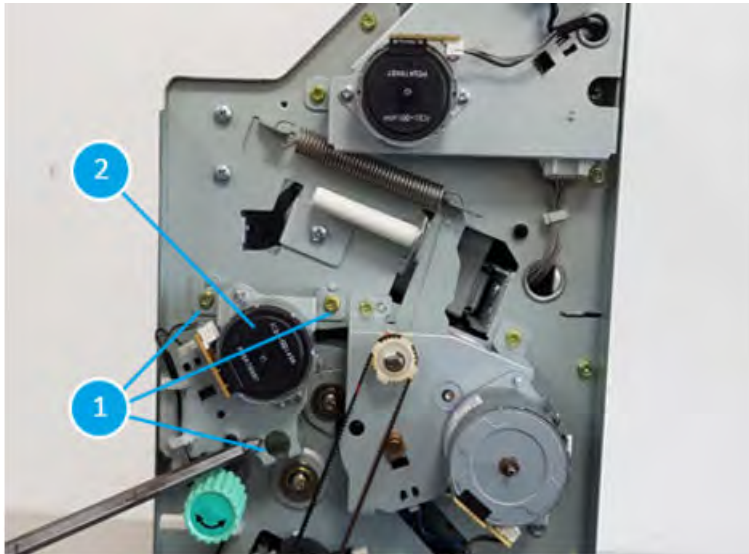
1. Remove two screws(callout 1) at the left of the booklet maker

Figure 5-1822 Remove two screws at the left of the booklet maker



2. Remove three screws(callout 1) at the front of the booklet maker to remove motor unit(callout 2) to reach out to the screw.

Figure 5-1823 Remove three screws to remove motor unit to reach out to the screw



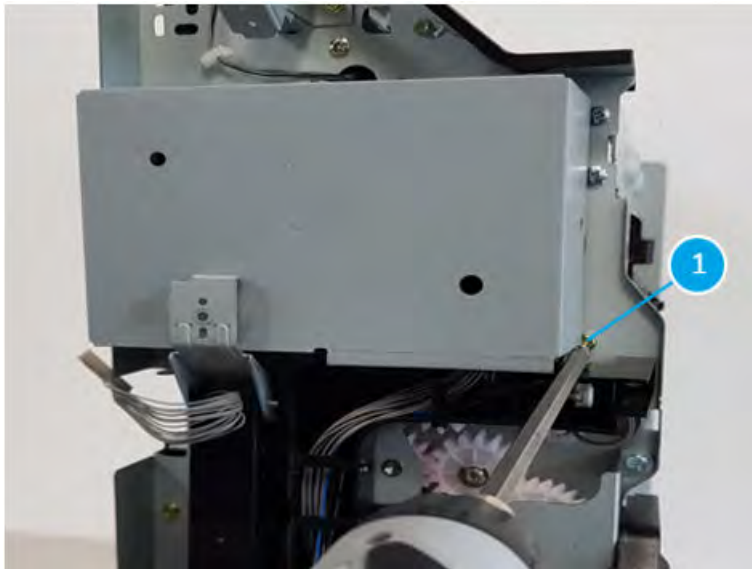
3. Remove one screw(callout 1) at the front of the booklet maker.

Figure 5-1824 Remove one screw at the front of the booklet maker



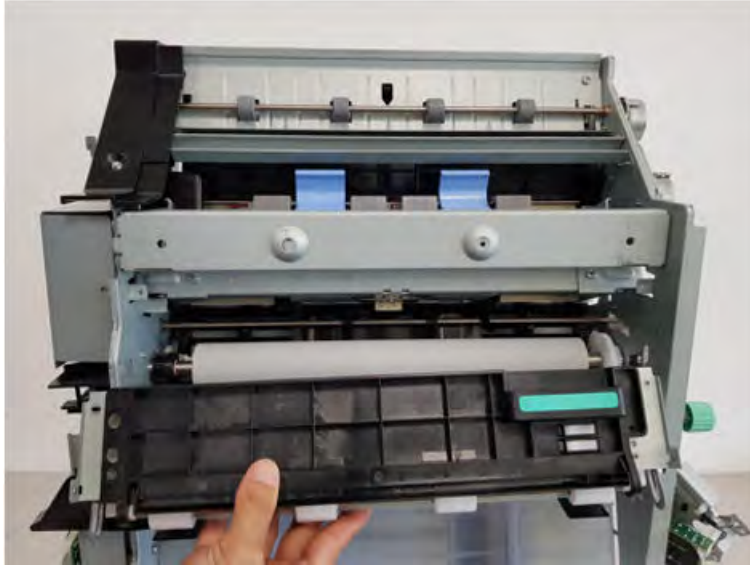
4. Remove one screw(callout 1) at the rear of the booklet maker.

Figure 5-1825 Remove one screw at the rear of the booklet maker



5. Take the booklet c-fold blade unit out from the booklet maker.

**Figure 5-1826** Take the booklet c-fold blade unit out from the booklet maker

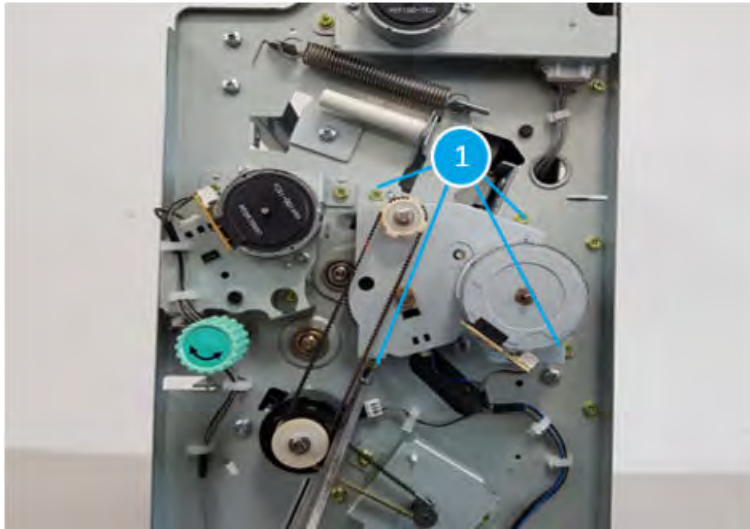


#### Remove the booklet c-fold blade home sensor (S39)

Follow these steps to remove the booklet c-fold blade home sensor (S39).

1. Remove three screws (callout 1) at the front of the booklet maker.

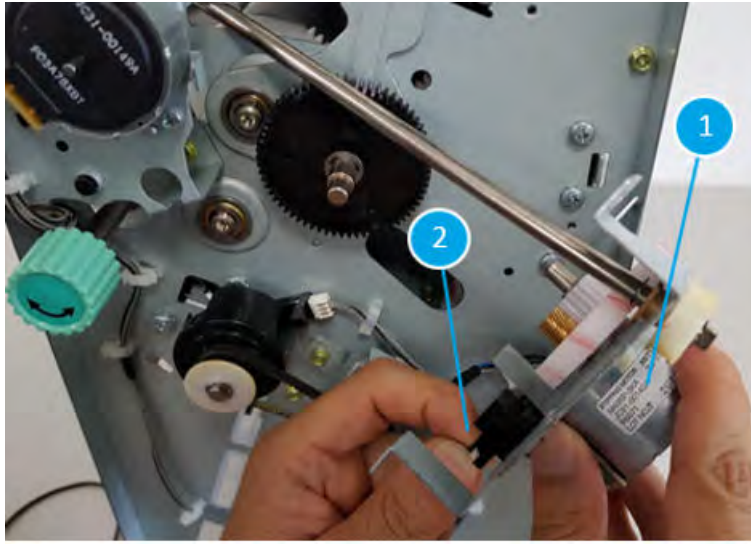
**Figure 5-1827** Remove three screws at the front of the booklet maker





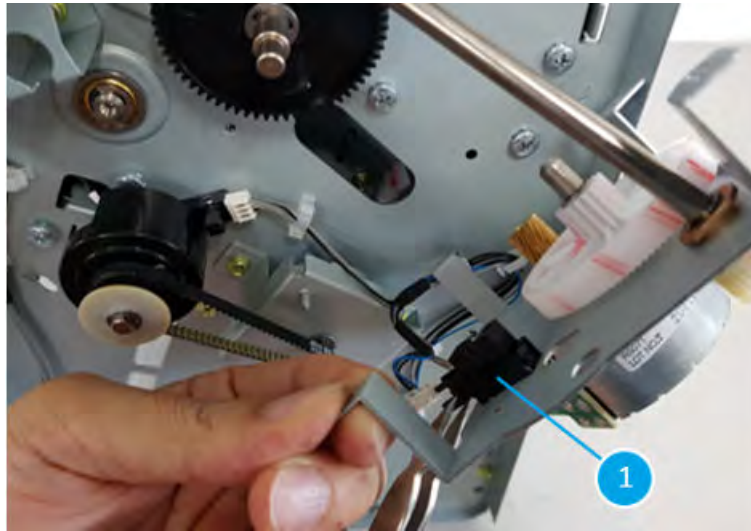
2. Take motor unit (callout 1) out from the booklet maker and unplug one connector (callout 2)

**Figure 5-1828** Take motor unit out from the booklet maker and unplug one connector



3. Remove the booklet c-fold blade home sensor (S39, callout 1)

**Figure 5-1829** Remove the booklet c-fold blade home sensor



### Unpack the replacement assembly

Follow these steps to unpack the replacement assembly.

1. Dispose of the defective part.

---

 **NOTE:** HP recommends responsible disposal of the defective part.

<http://www8.hp.com/us/en/hp-information/environment/product-recycling.html>

---

2. Unpack the replacement part from the packaging.


 **CAUTION:**  Some parts are sensitive to electrostatic discharge (ESD). Always perform service work at an ESD-protected workstation or mat. If an ESD workstation or mat is not available, touch the sheet-metal chassis to provide a static ground before touching an ESD-sensitive assembly. Protect the ESD-sensitive assemblies by placing them in ESD pouches when they are out of the printer.

 **IMPORTANT:** Make sure that all of the shipping materials (for example shipping tape) are removed from the replacement part prior to installation.

 **NOTE:** If the replacement part is a roller or pad, avoid touching the spongy part of it. Skin oils on the roller or pad can cause paper pickup and/or print-quality problems. HP recommends using disposable gloves when handling rollers or pads or washing your hands before touching rollers or pads.

---

3. To install an assembly, reverse the removal steps.

 **NOTE:** When applicable, special installation instructions are provided for an assembly at the end of the removal procedure. Always completely read the removal instructions and follow all special installation instructions.


---

## Removal and replacement: Booklet c-fold blade motor (M17)

Learn how to remove and replace the booklet c-fold blade motor.

### Introduction

This document provides the procedures to remove and replace the booklet c-fold blade motor on the finisher.

 **IMPORTANT:** When applicable, special installation instructions are provided for an assembly at the end of the removal procedure. Always completely read the removal instructions and follow all special installation instructions.

### Before performing service

- Turn the printer power off. A shutting-down message appears on the control-panel display.
- ⚠ **WARNING!** To avoid damage to the printer, turn the power off and wait until the printer shuts down before removing the power cable.
- Disconnect the printer power cable after the printer has completely shut down (the control-panel display is blank).
- Release the finisher from the printer by pulling out on the release latch inside the finisher door.
- Disconnect the cable from the bridge unit to the finisher.
- Disconnect the cable from the finisher to the printer.

Use the table below to identify the correct part number for your printer. To order the part, go to <https://parts.hp.com>.

**Table 5-164** Part information

Part number	Part description
JC93-01154A	Booklet c-fold blade motor
JC90-01396A	Booklet c-fold blade motor assembly

### Required tools

- #2 JIS screwdriver with a magnetic tip

### After performing service

- Connect the cable from the finisher to the printer.
- Connect the cable from the bridge unit to the finisher.
- Attach the finisher to the printer, and then push in on the release latch inside the finisher door.
- Connect the printer power cable.
- Turn the printer power on.


### Post service test

Process a job through the finisher and verify that the finisher works correctly.

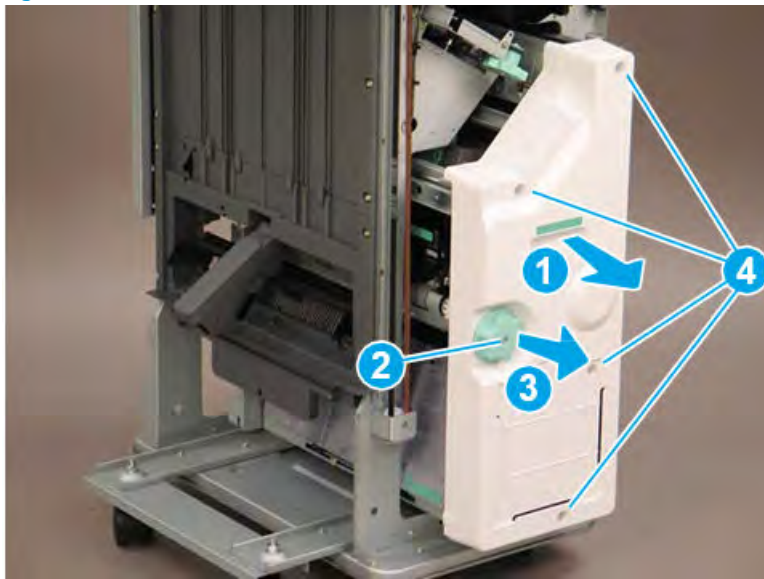
## Remove the booklet front cover

Follow these steps to remove the booklet front cover.

- ▲ Slide the booklet maker slightly away from the finisher (callout 1). Remove one screw (callout 2), and then slide the green knob away from the booklet maker to remove it (callout 3). Remove four screws (callout 4), and then remove the booklet front cover.

 **TIP:** Reverse the removal steps to install the assembly

**Figure 5-1830** Remove five screws and the cover

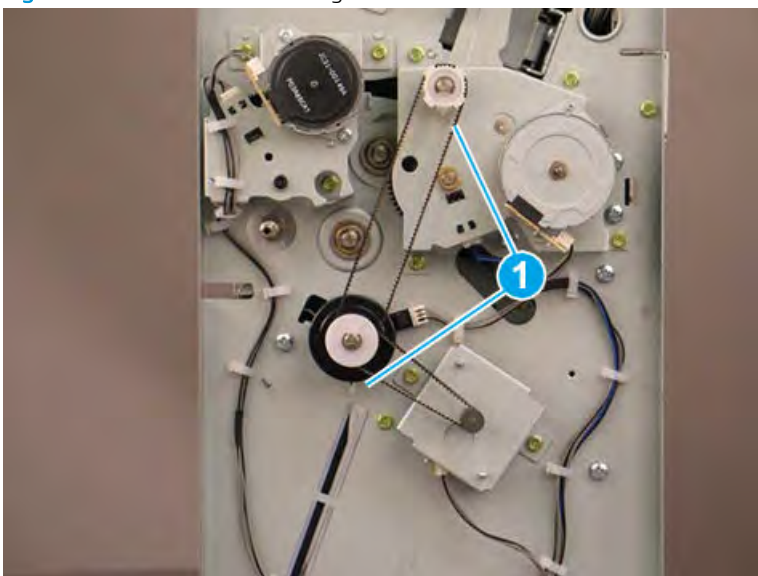


## Remove the booklet c-fold blade motor (M17)

Follow these steps to remove the booklet c-fold blade motor (M17).

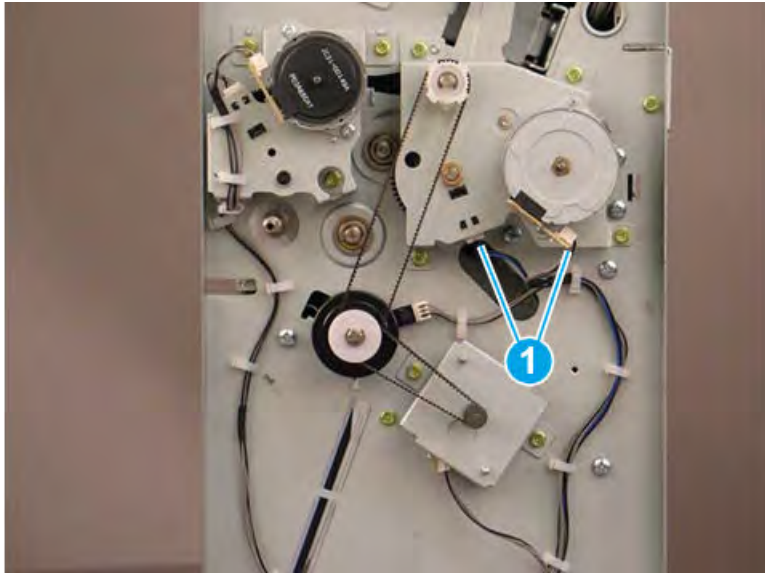
1. Note the position of the alignment arrows on the upper white gear and the lower motor (callout 1). These arrows must be aligned in these positions when the motor is reinstalled.

**Figure 5-1831** Check arrow alignment



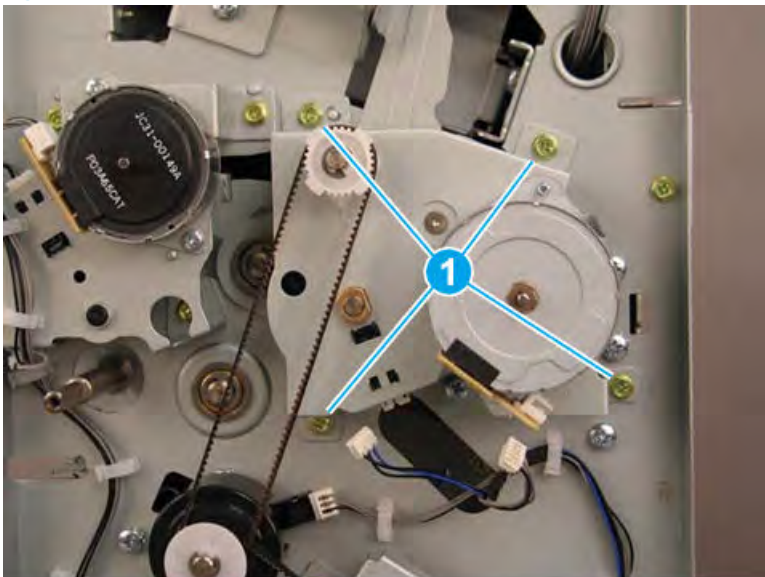
2. Disconnect two connectors (callout 1).

Figure 5-1832 Disconnect two connectors



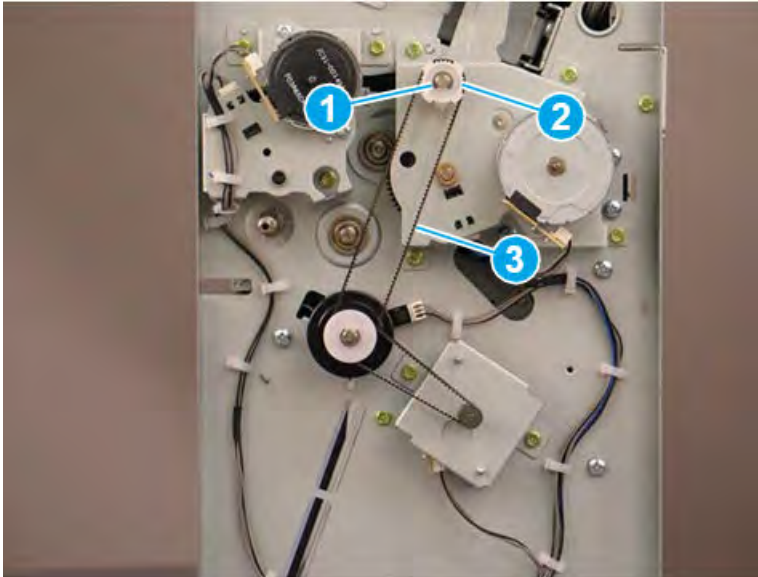
3. Remove four screws (callout 1).

Figure 5-1833 Remove four screws (callout 1).



4. Remove one e-clip (callout 1) on top of the white gear. Remove the white gear (callout 2) and release the belt (callout 3).

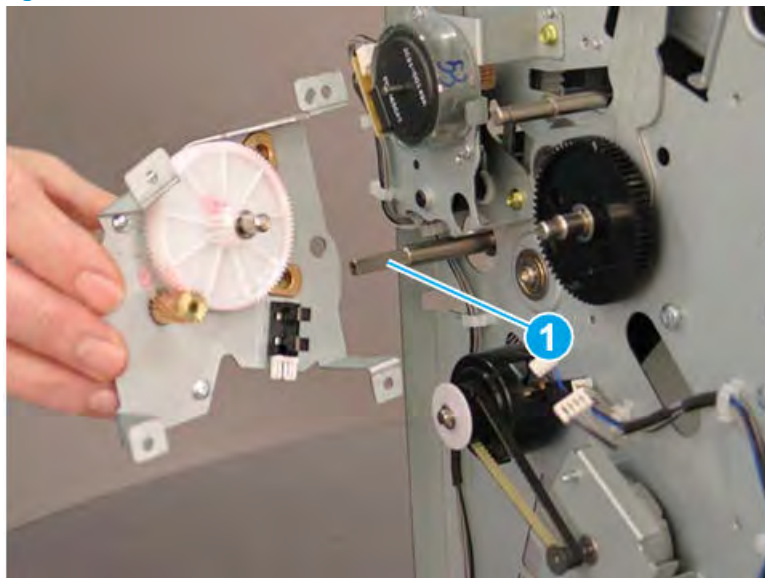
Figure 5-1834 Remove one e-clip, gear, and belt



5. Remove the bracket and motor from the booklet maker.

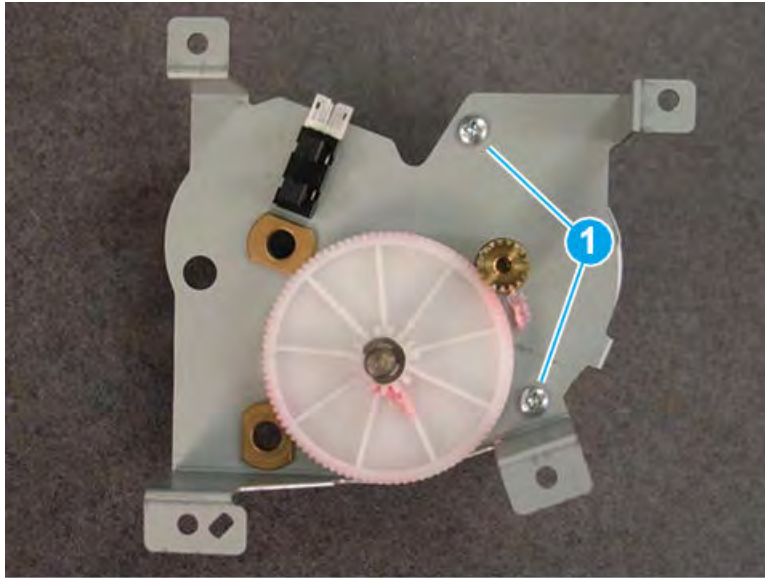
**⚠ CAUTION:** Do not pull on the shaft (callout 1) while removing the bracket and motor. The shaft might become dislodged at the other end. If the shaft becomes dislodged, remove the booklet maker PCA shield and PCA bracket to reinstall the shaft.

Figure 5-1835 Remove the bracket and motor



6. Remove two screws (callout 1), and then remove the C fold motor.

Figure 5-1836 Remove two screws

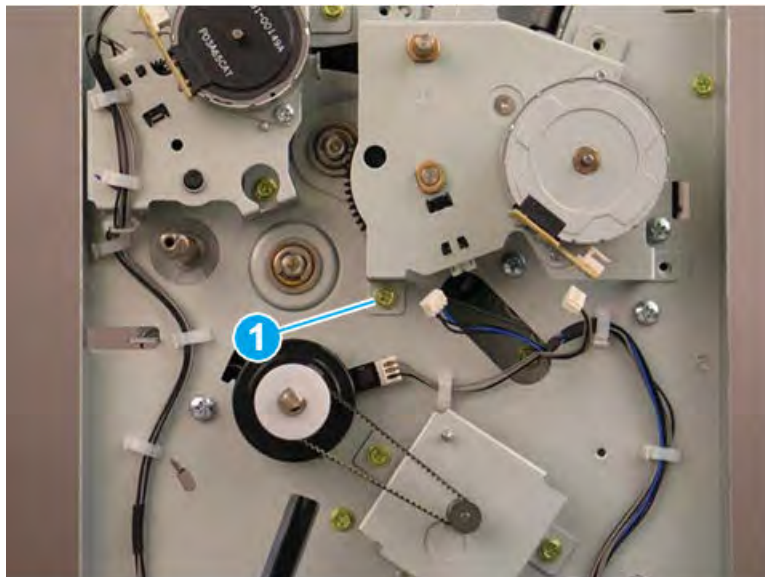


7. Reverse the removal steps to install the assembly. Also use the following special installation instructions.

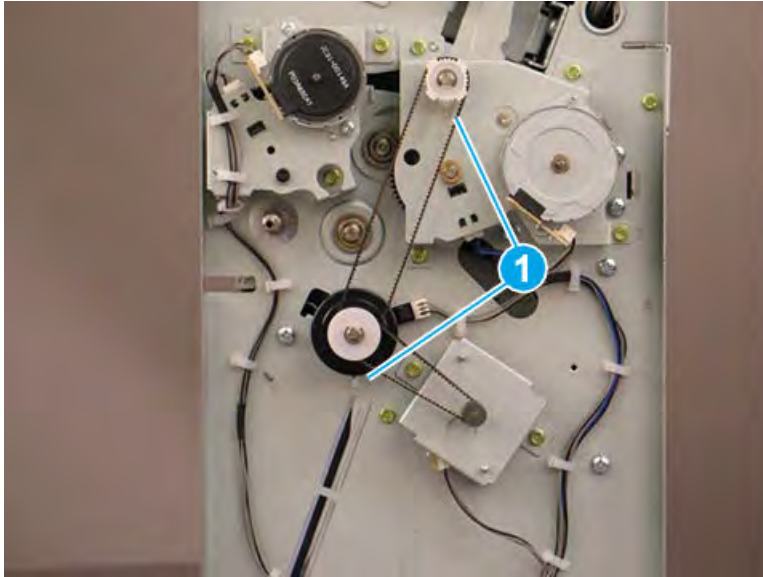
 **NOTE:** Continue to reverse the removal steps to finish installing the assembly.

#### Special installation instructions: C fold motor

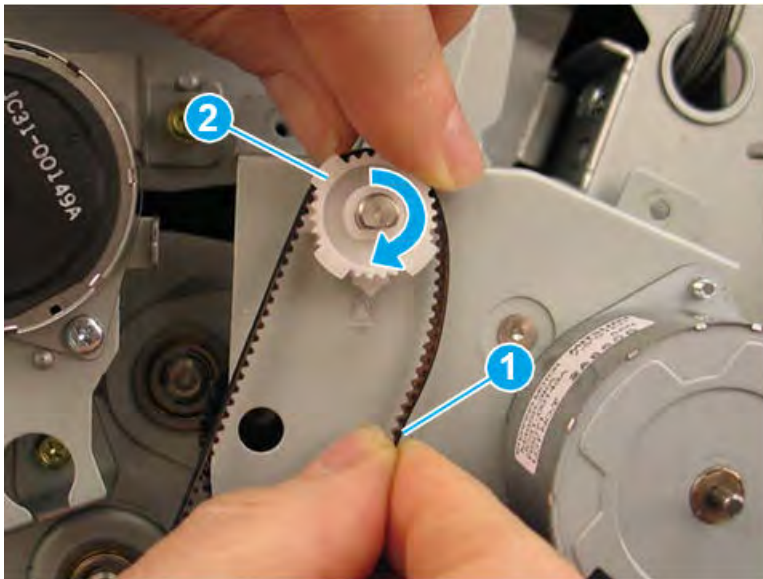
- a. When installing the motor, install one screw (callout 1) to hold the bracket in place while installing the gear and belt.



- b. Check the position of the alignment arrows on the upper white gear and the lower motor (callout 1).



- c. If the arrows are not aligned, slightly pull up on the belt to create some slack around the gear (callout 1), and then rotate the gear (callout 2) until the arrows align.



### Unpack the replacement assembly

Follow these steps to unpack the replacement assembly.

1. Dispose of the defective part.





---

 **NOTE:** HP recommends responsible disposal of the defective part.


<http://www8.hp.com/us/en/hp-information/environment/product-recycling.html>

---

2. Unpack the replacement part from the packaging.


 **CAUTION:**  Some parts are sensitive to electrostatic discharge (ESD). Always perform service work at an ESD-protected workstation or mat. If an ESD workstation or mat is not available, touch the sheet-metal chassis to provide a static ground before touching an ESD-sensitive assembly. Protect the ESD-sensitive assemblies by placing them in ESD pouches when they are out of the printer.

 **IMPORTANT:** Make sure that all of the shipping materials (for example shipping tape) are removed from the replacement part prior to installation.

 **NOTE:** If the replacement part is a roller or pad, avoid touching the spongy part of it. Skin oils on the roller or pad can cause paper pickup and/or print-quality problems. HP recommends using disposable gloves when handling rollers or pads or washing your hands before touching rollers or pads.

---

3. To install an assembly, reverse the removal steps.

 **NOTE:** When applicable, special installation instructions are provided for an assembly at the end of the removal procedure. Always completely read the removal instructions and follow all special installation instructions.

---

## Booklet diverter unit

## Removal and replacement: Booklet diverter

Learn how to remove and replace the booklet diverter.

### Introduction

This document provides the procedures to remove and replace the booklet diverter on the finisher.



**IMPORTANT:** When applicable, special installation instructions are provided for an assembly at the end of the removal procedure. Always completely read the removal instructions and follow all special installation instructions.

### Before performing service

- Turn the printer power off. A shutting-down message appears on the control-panel display.
- ⚠ **WARNING!** To avoid damage to the printer, turn the power off and wait until the printer shuts down before removing the power cable.
- Disconnect the printer power cable after the printer has completely shut down (the control-panel display is blank).
- Release the finisher from the printer by pulling out on the release latch inside the finisher door.
- Disconnect the cable from the bridge unit to the finisher.
- Disconnect the cable from the finisher to the printer.

Use the table below to identify the correct part number for your printer. To order the part, go to <https://parts.hp.com>.

**Table 5-165** Part information

Part number	Part description
JC90-01398A	Booklet diverter

### Required tools

- #2 JIS screwdriver with a magnetic tip

### After performing service

- Connect the cable from the finisher to the printer.
- Connect the cable from the bridge unit to the finisher.
- Attach the finisher to the printer, and then push in on the release latch inside the finisher door.
- Connect the printer power cable.
- Turn the printer power on.

### Post service test

Process a job through the finisher and verify that the finisher works correctly.

## Remove the right upper cover (finisher)

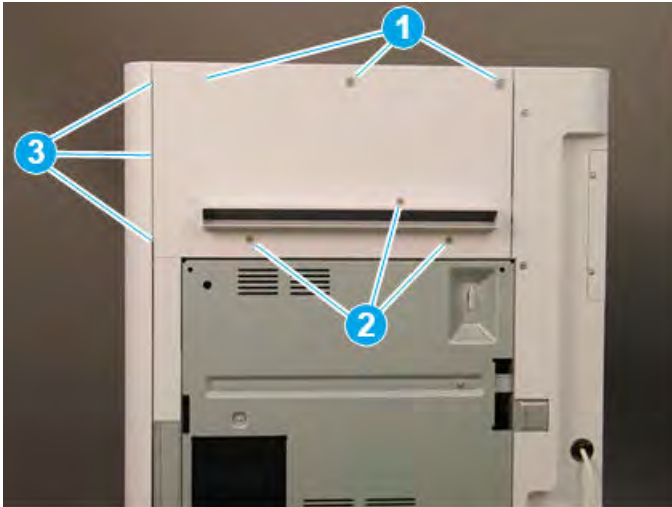
Follow these steps to remove the right upper cover (finisher).

- ▲ Remove one screw cap and three machine screws on the upper edge of the cover (callout 1). Remove three sheet metal screws (callout 2) on the lower portion of the cover. Rotate the right edge of the cover away from the finisher, and then slide the cover right to release three tabs (callout 3).

💡 **TIP:** The lower screws are shorter in length than the upper screws.

**TIP:** Reverse the removal steps to install the assembly.

**Figure 5-1837** Remove the right upper cover

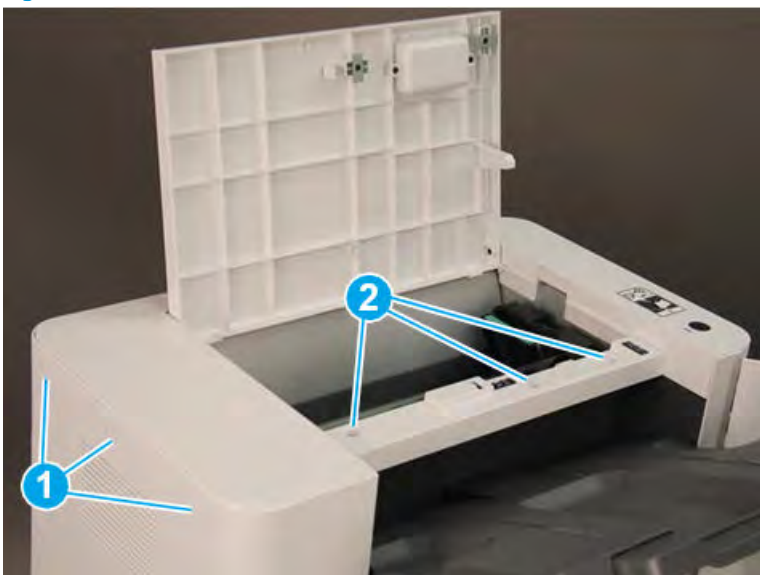


## Remove the top cover (finisher)

Follow these steps to remove the top cover (finisher).

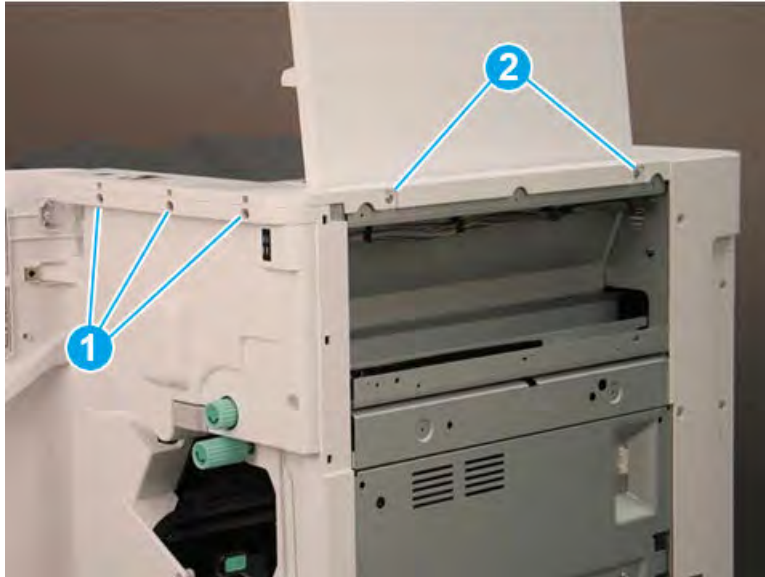
1. Remove three screw caps and three self-tapping screws at the top of the rear cover (callout 1), and then remove three machine screws (callout 2) on top of the cover.

**Figure 5-1838** Remove six screws




2. Remove three self-tapping screws at the top of the front cover (callout 1), and then remove two machine screws (callout 2) at the top of the right side.

Figure 5-1839 Remove five screws



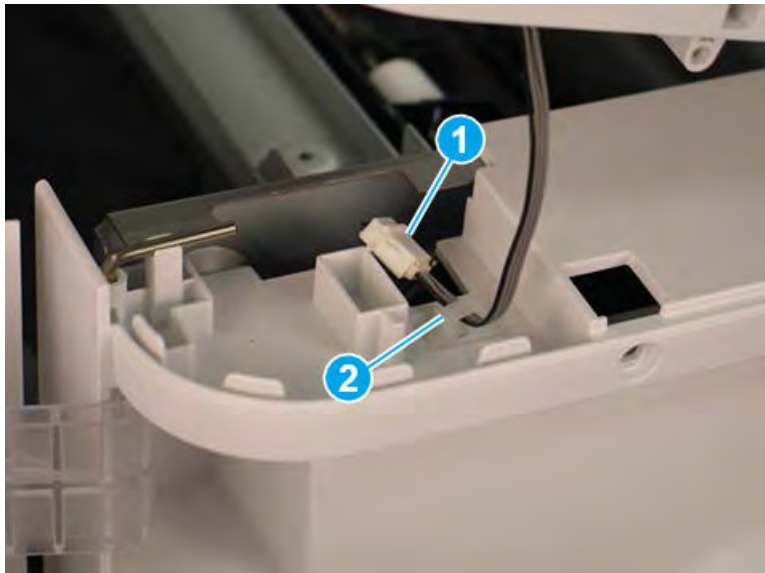
3. Lift the cover up slightly. Disconnect one in-line connector (callout 1), and then release one retainer (callout 2).

---

 **TIP:** Reverse the removal steps to install the assembly.

---

Figure 5-1840 Disconnect one connector and release retainer



### Remove the rear cover (finisher)

Follow these steps to remove the rear cover (finisher).

1. Remove two self-tapping screws (callout 1) on the top of the rear cover, and then remove five screw caps and five machine screws (callout 2) on the left side of the cover.

Figure 5-1841 Remove seven screws



2. Remove one screw cap and four machine screws (callout 1) Remove the rear cover.

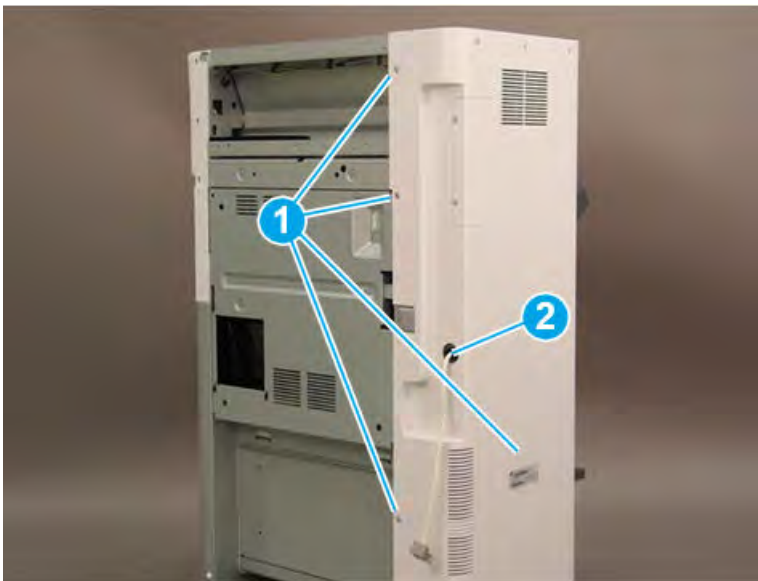
---

 **NOTE:** Make sure to thread the power cable (callout 2) through the opening in the cover.

 **TIP:** Reverse the removal steps to install the assembly

---

Figure 5-1842 Remove the rear cover



### Remove the booklet maker

Follow these steps to remove the booklet maker.

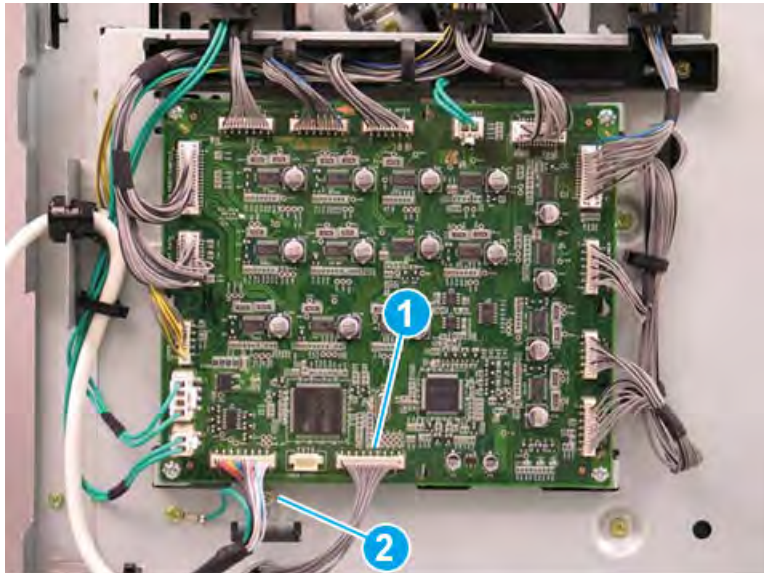
1. Slide the booklet maker away from the finisher.

Figure 5-1843 Slide the booklet maker away from the finisher



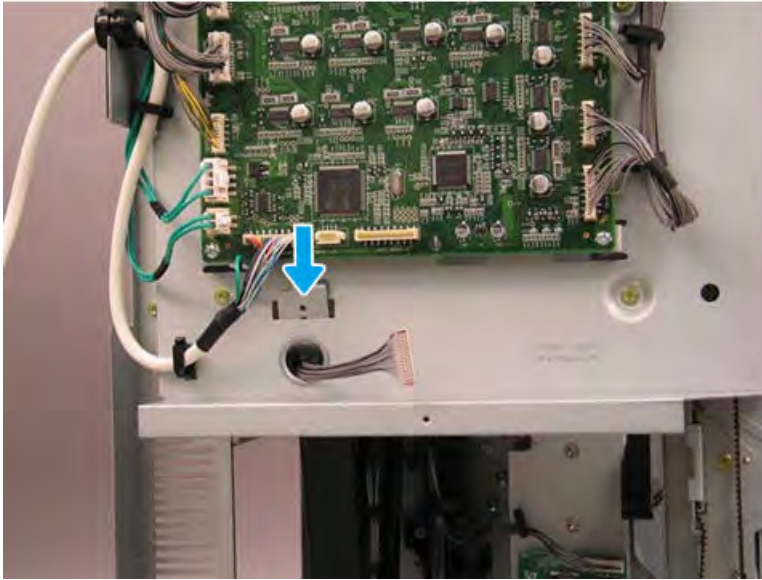
2. At the Disconnect one connector (callout 1), and then remove one screw (callout 2).

Figure 5-1844 Disconnect one connector and remove one screw



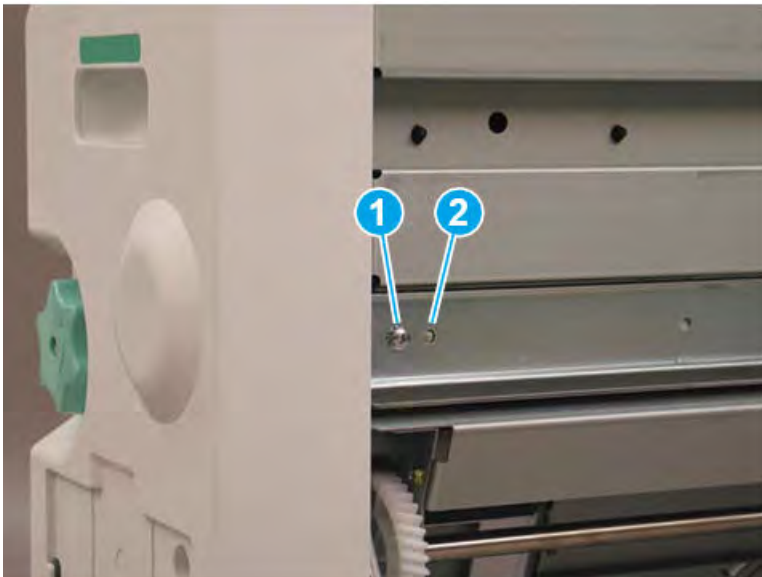
3. Release the metal bracket through the opening in the sheet metal.

Figure 5-1845 Release the metal bracket



4. Remove one star-washer screw (callout 1), and then release the alignment pin (callout 2) on the right side of the booklet maker.

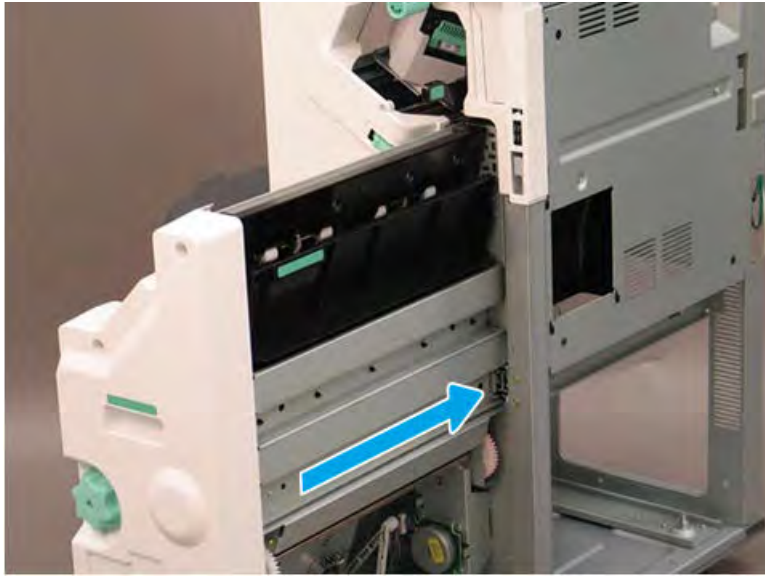
Figure 5-1846 Remove one screw





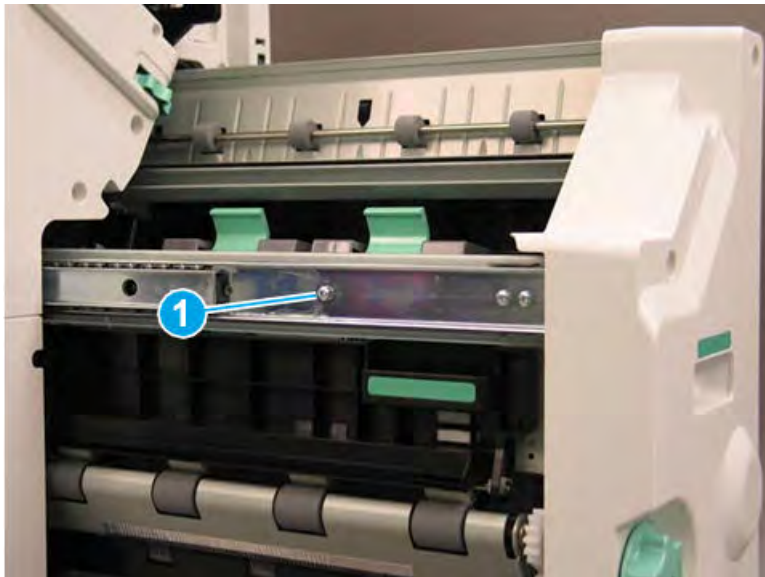
5. Slide the right rail toward the finisher.

Figure 5-1847 Slide the right rail



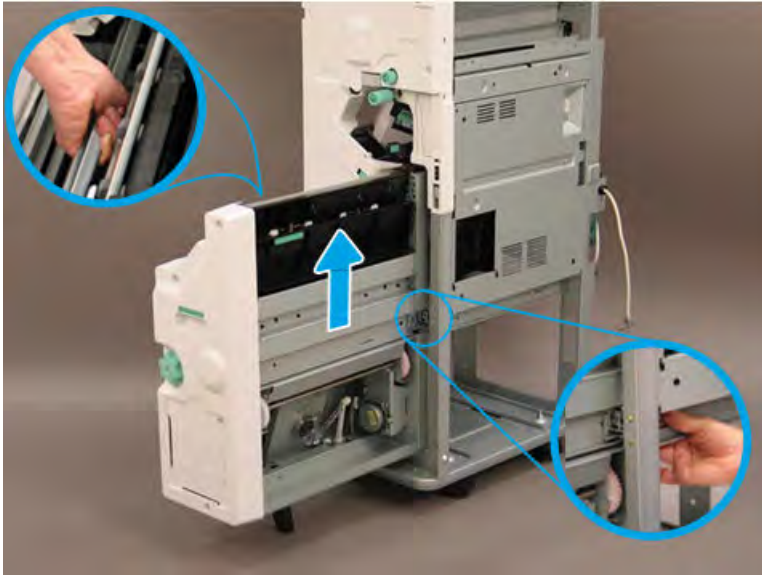
6. Remove one star-washer screw (callout 1) on the left side of the booklet maker.

Figure 5-1848 Remove one screw



7. Lift the booklet maker up on the left side while squeezing the right rail away from the finisher slightly to clear the sheet metal. Remove the booklet maker.

**Figure 5-1849** Remove the booklet maker



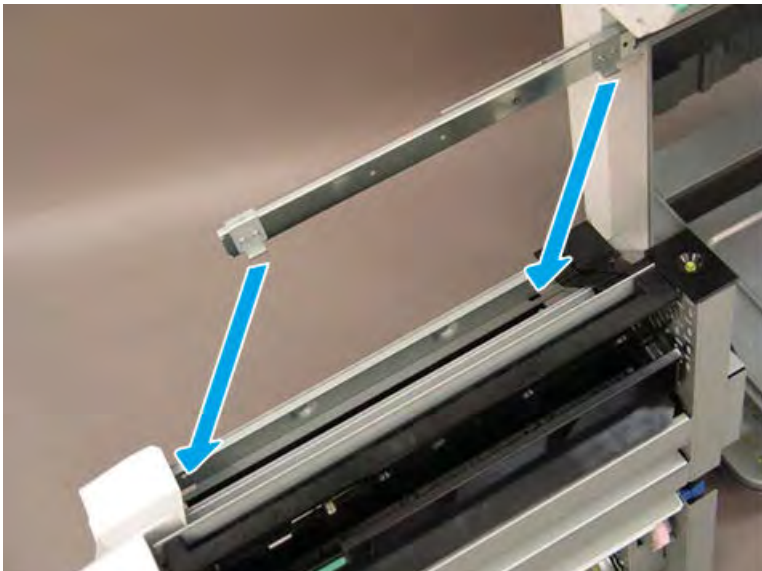
8. Reverse the removal steps to install the assembly. Also use the following special installation instructions.

 **NOTE:** Continue to reverse the removal steps to finish installing the assembly.

**Special installation instructions: booklet maker**

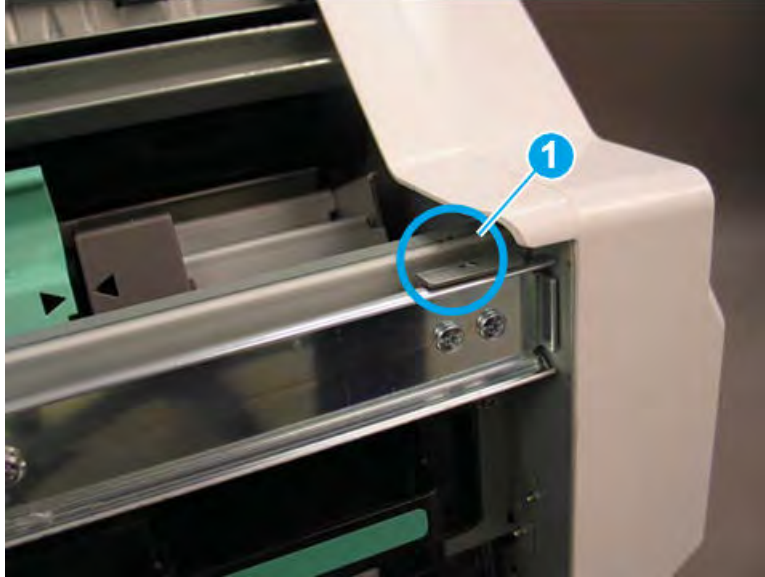
When installing the booklet maker, position the hooks on the rail under the slots on the booklet maker.

**Figure 5-1850** Position the hooks



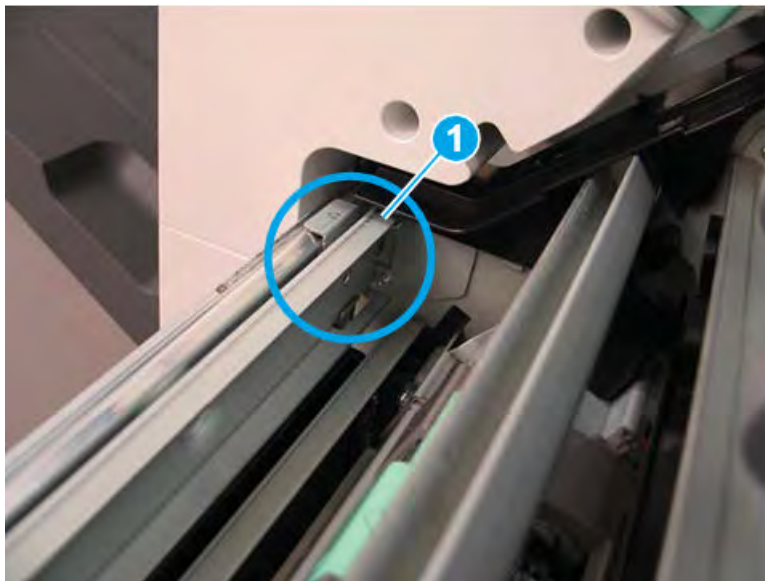
9. When installed correctly, the arrow on the front of the booklet maker aligns with the arrow on the finisher rail.

Figure 5-1851 Align arrows



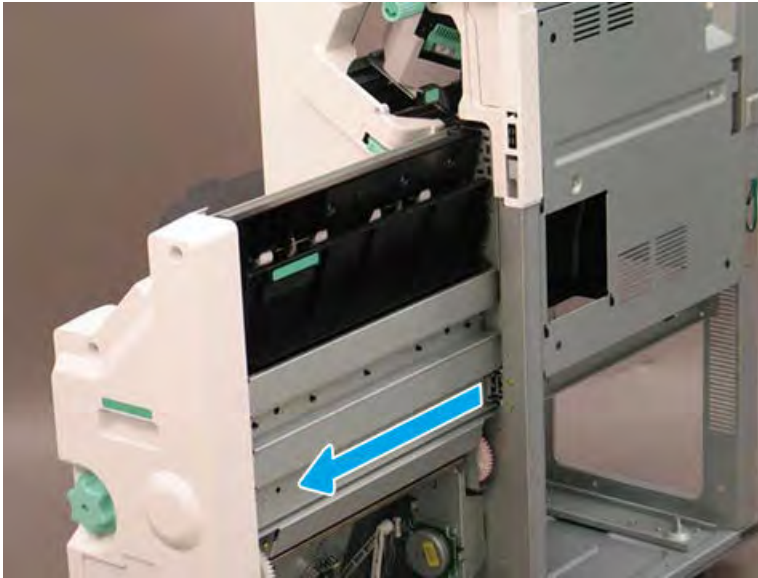
10. When installed correctly, the arrow on the back of the booklet maker aligns with the arrow on the finisher rail.

Figure 5-1852 Align arrows



11. Extend the right rail away from the finisher and position it in the booklet maker slot.

Figure 5-1853 Extend the right rail



#### Remove the booklet front cover

Follow these steps to remove the booklet front cover.

- ▲ Slide the booklet maker slightly away from the finisher (callout 1). Remove one screw (callout 2), and then slide the green knob away from the booklet maker to remove it (callout 3). Remove four screws (callout 4), and then remove the booklet front cover.


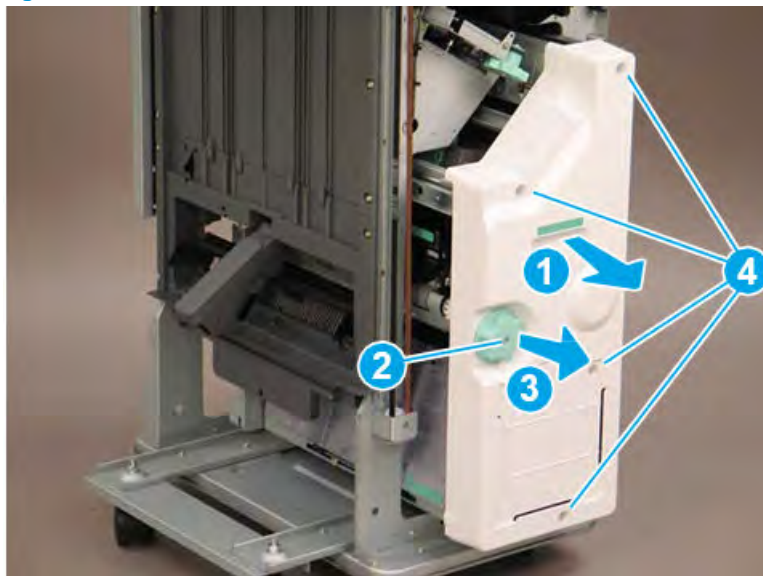
 **TIP:** Reverse the removal steps to install the assembly

Figure 5-1854 Remove five screws and the cover

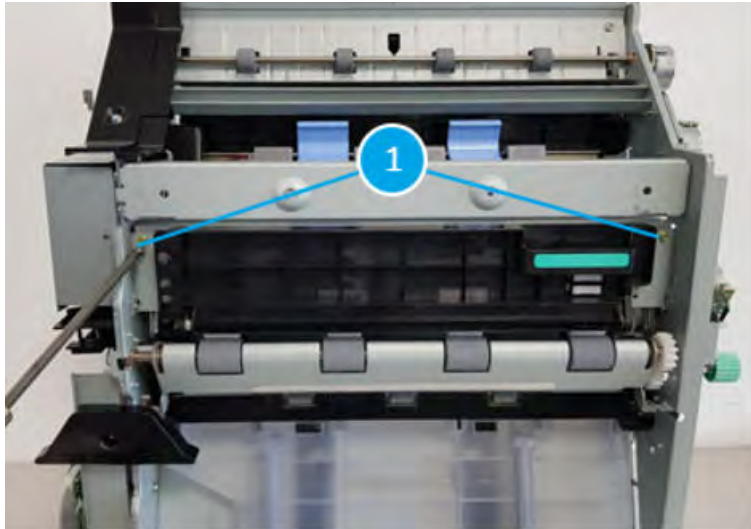


#### Remove the Booklet c-fold blade unit

Follow these steps to remove the Booklet c-fold blade unit.

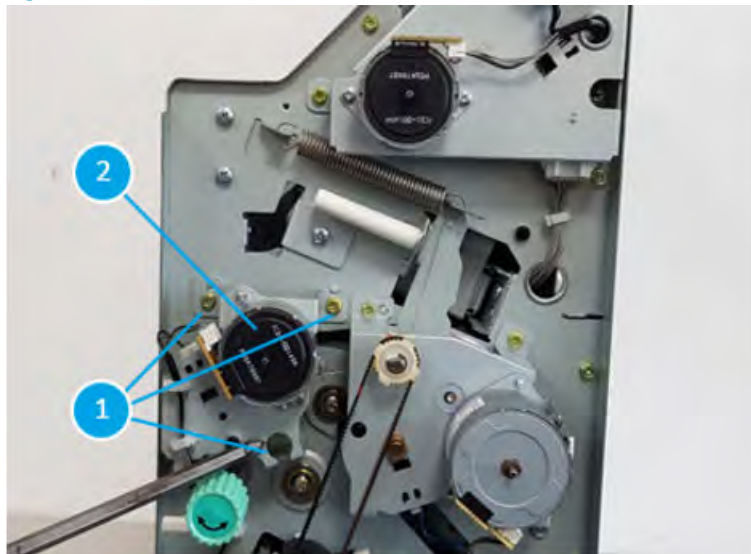
1. Remove two screws(callout 1) at the left of the booklet maker

Figure 5-1855 Remove two screws at the left of the booklet maker



2. Remove three screws(callout 1) at the front of the booklet maker to remove motor unit(callout 2) to reach out to the screw.

Figure 5-1856 Remove three screws to remove motor unit to reach out to the screw



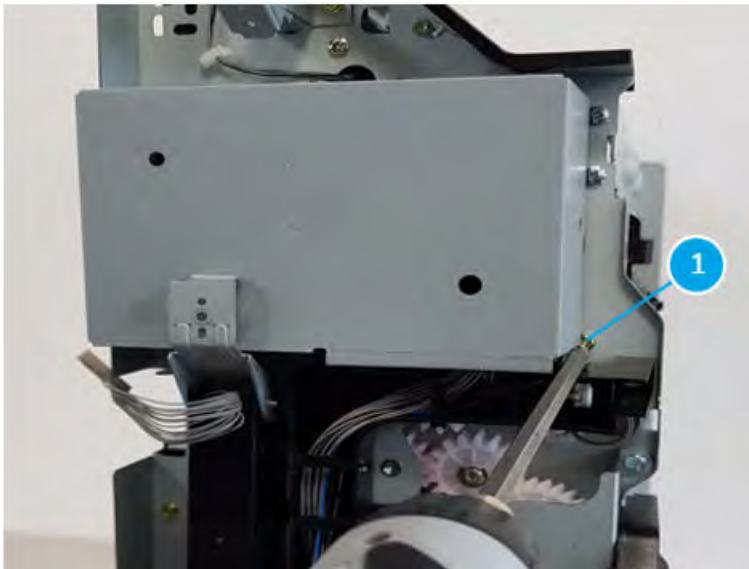
3. Remove one screw(callout 1) at the front of the booklet maker.

Figure 5-1857 Remove one screw at the front of the booklet maker



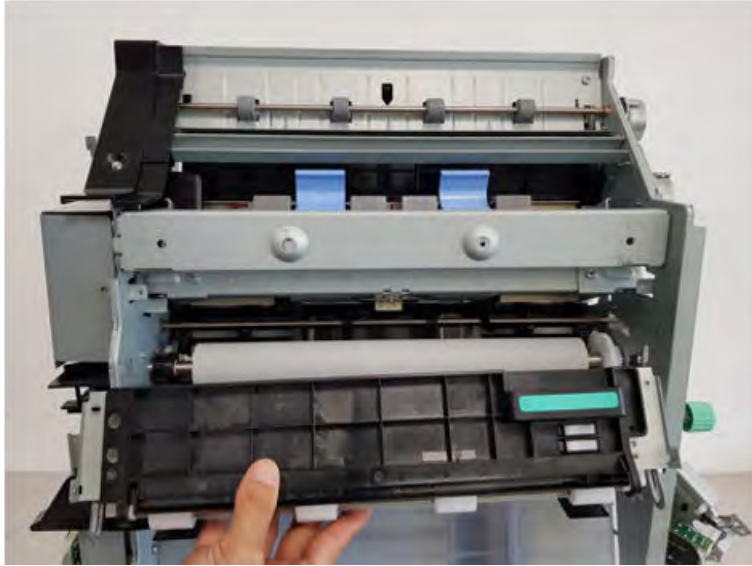
4. Remove one screw(callout 1) at the rear of the booklet maker.

Figure 5-1858 Remove one screw at the rear of the booklet maker



5. Take the booklet c-fold blade unit out from the booklet maker.

**Figure 5-1859** Take the booklet c-fold blade unit out from the booklet maker

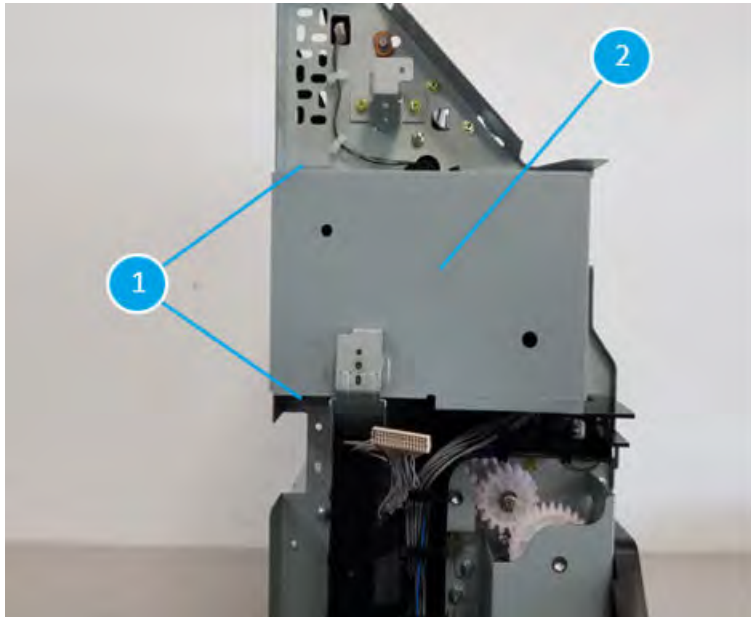


#### Remove the booklet diverter

Follow these steps to remove the booklet diverter.

1. Remove two screws (callout 1) at the rear of the booklet maker and remove the PCA cover (callout 2).

**Figure 5-1860** Remove two screws at the rear of the booklet maker and remove the PCA cover



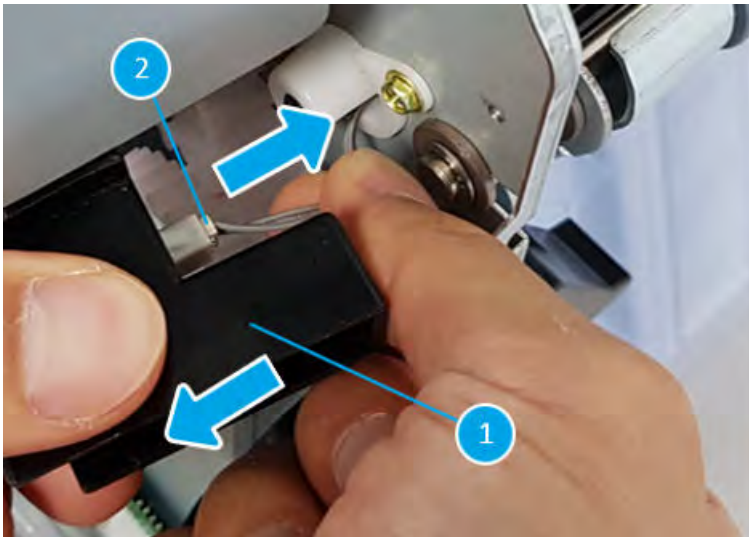
2. Remove one screw(callout 1) at the rear of the booklet maker to make it easy to disconnect the connector.

Figure 5-1861 Remove one screw at the rear of the booklet maker



3. Pull the connector cover (callout 1) and disconnect the one connector (callout 2)

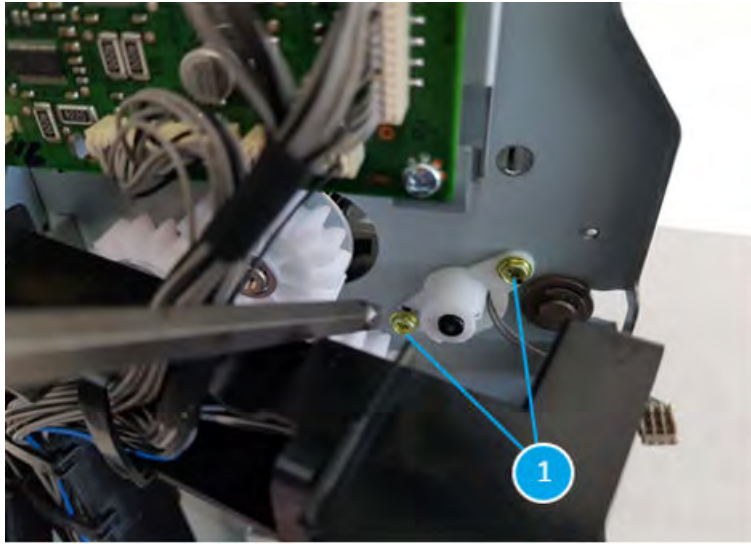
Figure 5-1862 Pull the connector cover and disconnect the one connector





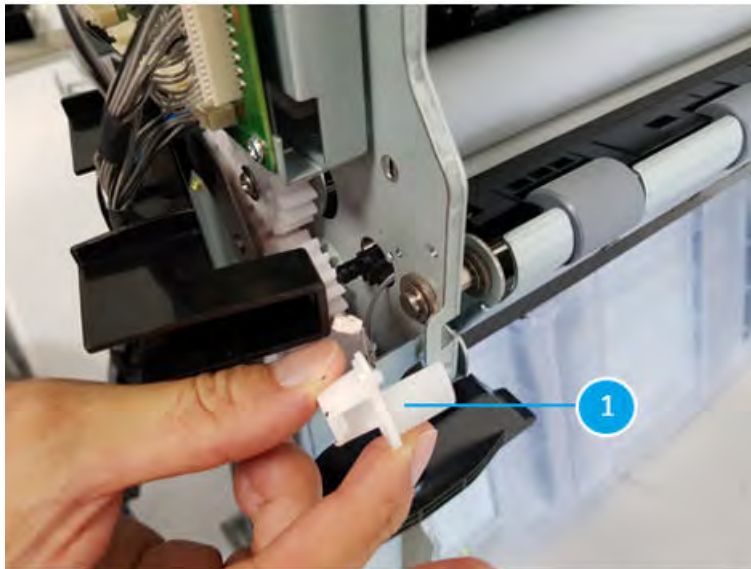
4. Remove two screws(callout 1)

Figure 5-1863 Remove two screws



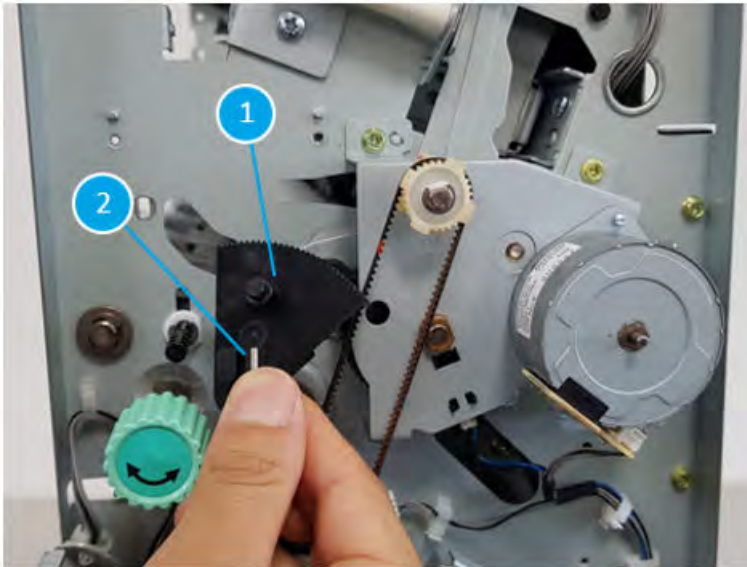
5. Remove the white bush

Figure 5-1864 Remove the white bush



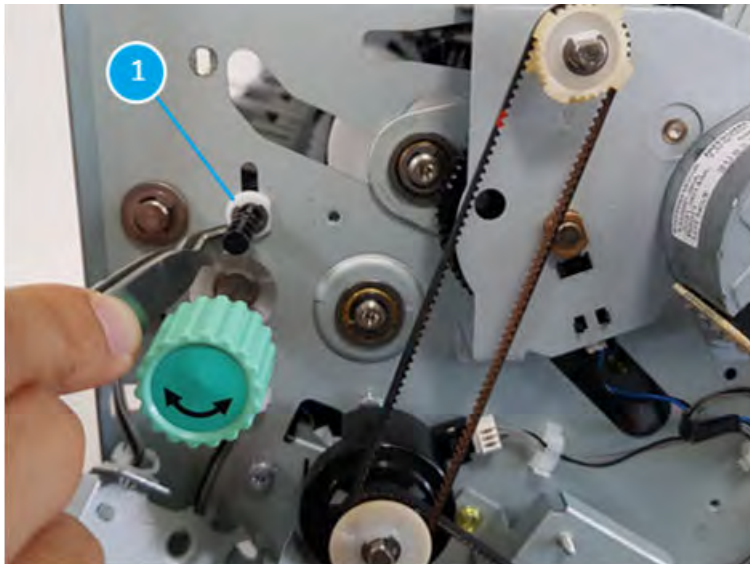
6. Remove one e-clip on top of the black actuator (callout 1) and remove the black actuator and make sure not to lose the pin (callout 2) when you pull out the black actuator.

**Figure 5-1865** Remove one e-clip on top of the black actuator (callout 1) and remove the black actuator



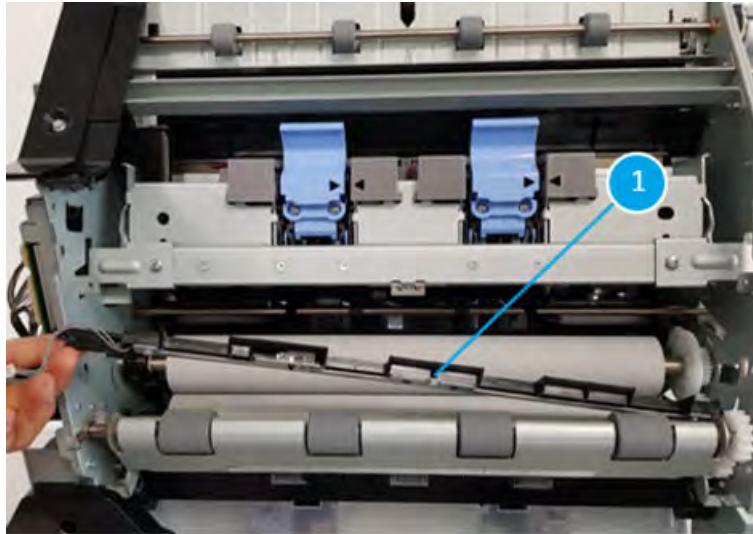
7. Remove the white bush (callout 1).

**Figure 5-1866** Remove the white bush



8. Pull the booklet diverter out from the booklet maker.

**Figure 5-1867** Pull the booklet diverter out from the booklet maker



### Unpack the replacement assembly

Follow these steps to unpack the replacement assembly.

1. Dispose of the defective part.




**NOTE:** HP recommends responsible disposal of the defective part.

<http://www8.hp.com/us/en/hp-information/environment/product-recycling.html>

2. Unpack the replacement part from the packaging.



**CAUTION:**  Some parts are sensitive to electrostatic discharge (ESD). Always perform service work at an ESD-protected workstation or mat. If an ESD workstation or mat is not available, touch the sheet-metal chassis to provide a static ground before touching an ESD-sensitive assembly. Protect the ESD-sensitive assemblies by placing them in ESD pouches when they are out of the printer.



**IMPORTANT:** Make sure that all of the shipping materials (for example shipping tape) are removed from the replacement part prior to installation.



**NOTE:** If the replacement part is a roller or pad, avoid touching the spongy part of it. Skin oils on the roller or pad can cause paper pickup and/or print-quality problems. HP recommends using disposable gloves when handling rollers or pads or washing your hands before touching rollers or pads.

3. To install an assembly, reverse the removal steps.




**NOTE:** When applicable, special installation instructions are provided for an assembly at the end of the removal procedure. Always completely read the removal instructions and follow all special installation instructions.

## Removal and replacement: Booklet diverter home sensor (S40)

Learn how to remove and replace the booklet diverter home sensor.

### Introduction

This document provides the procedures to remove and replace the booklet diverter home sensor on the finisher.

 **IMPORTANT:** When applicable, special installation instructions are provided for an assembly at the end of the removal procedure. Always completely read the removal instructions and follow all special installation instructions.

### Before performing service

- Turn the printer power off. A shutting-down message appears on the control-panel display.
- ⚠ **WARNING!** To avoid damage to the printer, turn the power off and wait until the printer shuts down before removing the power cable.
- Disconnect the printer power cable after the printer has completely shut down (the control-panel display is blank).
- Release the finisher from the printer by pulling out on the release latch inside the finisher door.
- Disconnect the cable from the bridge unit to the finisher.
- Disconnect the cable from the finisher to the printer.

Use the table below to identify the correct part number for your printer. To order the part, go to <https://parts.hp.com>.

**Table 5-166** Part information

Part number	Part description
0604-001415	Booklet diverter home sensor

### Required tools

- #2 JIS screwdriver with a magnetic tip

### After performing service

- Connect the cable from the finisher to the printer.
- Connect the cable from the bridge unit to the finisher.
- Attach the finisher to the printer, and then push in on the release latch inside the finisher door.
- Connect the printer power cable.
- Turn the printer power on.


### Post service test

Process a job through the finisher and verify that the finisher works correctly.

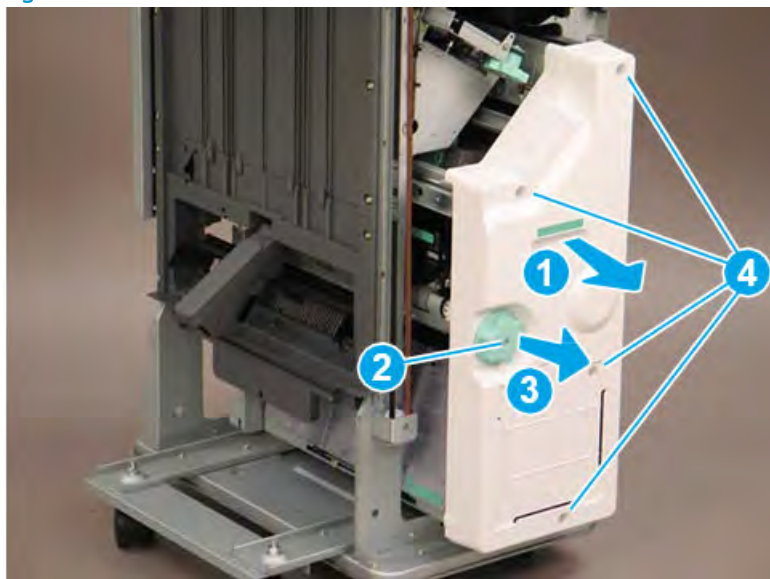
## Remove the booklet front cover

Follow these steps to remove the booklet front cover.

- ▲ Slide the booklet maker slightly away from the finisher (callout 1). Remove one screw (callout 2), and then slide the green knob away from the booklet maker to remove it (callout 3). Remove four screws (callout 4), and then remove the booklet front cover.

 **TIP:** Reverse the removal steps to install the assembly

**Figure 5-1868** Remove five screws and the cover

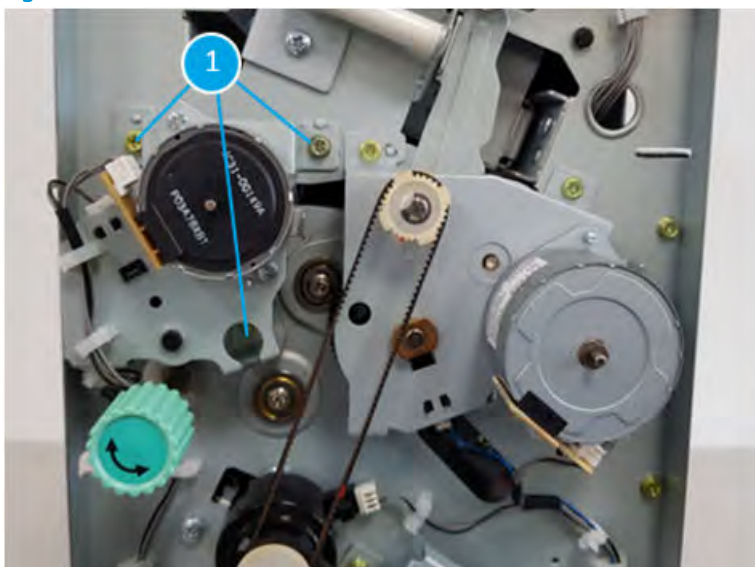


## Remove the booklet diverter home sensor (S40)

Follow these steps to remove the booklet diverter home sensor (S40).

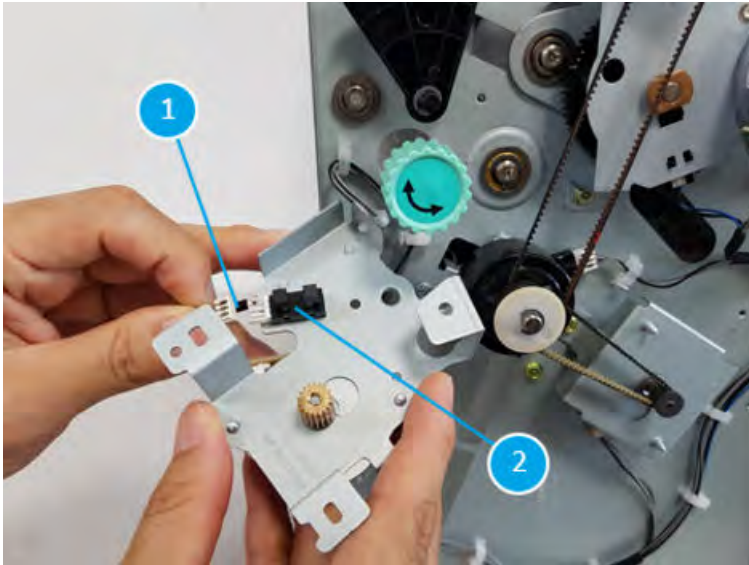
1. Remove three screws (callout 1)

**Figure 5-1869** Remove three screws



2. Unplug one connector (callout 1) and remove the booklet diverter home sensor (S40, callout 2)

Figure 5-1870 Remove the booklet diverter home sensor



### Unpack the replacement assembly



Follow these steps to unpack the replacement assembly.


1. Dispose of the defective part.


 **NOTE:** HP recommends responsible disposal of the defective part.

<http://www8.hp.com/us/en/hp-information/environment/product-recycling.html>


2. Unpack the replacement part from the packaging.

 **CAUTION:**  Some parts are sensitive to electrostatic discharge (ESD). Always perform service work at an ESD-protected workstation or mat. If an ESD workstation or mat is not available, touch the sheet-metal chassis to provide a static ground before touching an ESD-sensitive assembly. Protect the ESD-sensitive assemblies by placing them in ESD pouches when they are out of the printer.

 **IMPORTANT:** Make sure that all of the shipping materials (for example shipping tape) are removed from the replacement part prior to installation.

 **NOTE:** If the replacement part is a roller or pad, avoid touching the spongy part of it. Skin oils on the roller or pad can cause paper pickup and/or print-quality problems. HP recommends using disposable gloves when handling rollers or pads or washing your hands before touching rollers or pads.

3. To install an assembly, reverse the removal steps.

 **NOTE:** When applicable, special installation instructions are provided for an assembly at the end of the removal procedure. Always completely read the removal instructions and follow all special installation instructions.

## Removal and replacement: Booklet diverter motor (M18)

Learn how to remove and replace the booklet diverter motor.

### Introduction

This document provides the procedures to remove and replace the booklet diverter motor on the finisher.



**IMPORTANT:** When applicable, special installation instructions are provided for an assembly at the end of the removal procedure. Always completely read the removal instructions and follow all special installation instructions.

### Before performing service

- Turn the printer power off. A shutting-down message appears on the control-panel display.
- ⚠ **WARNING!** To avoid damage to the printer, turn the power off and wait until the printer shuts down before removing the power cable.
- Disconnect the printer power cable after the printer has completely shut down (the control-panel display is blank).
- Release the finisher from the printer by pulling out on the release latch inside the finisher door.
- Disconnect the cable from the bridge unit to the finisher.
- Disconnect the cable from the finisher to the printer.

Use the table below to identify the correct part number for your printer. To order the part, go to <https://parts.hp.com>.

**Table 5-167** Part information

Part number	Part description
JC90-01397A	Booklet diverter motor assembly
JC93-01153A	Booklet diverter motor

### Required tools

- #2 JIS screwdriver with a magnetic tip

### After performing service

- Connect the cable from the finisher to the printer.
- Connect the cable from the bridge unit to the finisher.
- Attach the finisher to the printer, and then push in on the release latch inside the finisher door.
- Connect the printer power cable.
- Turn the printer power on.

### Post service test

Process a job through the finisher and verify that the finisher works correctly.

## Remove the booklet front cover

Follow these steps to remove the booklet front cover.

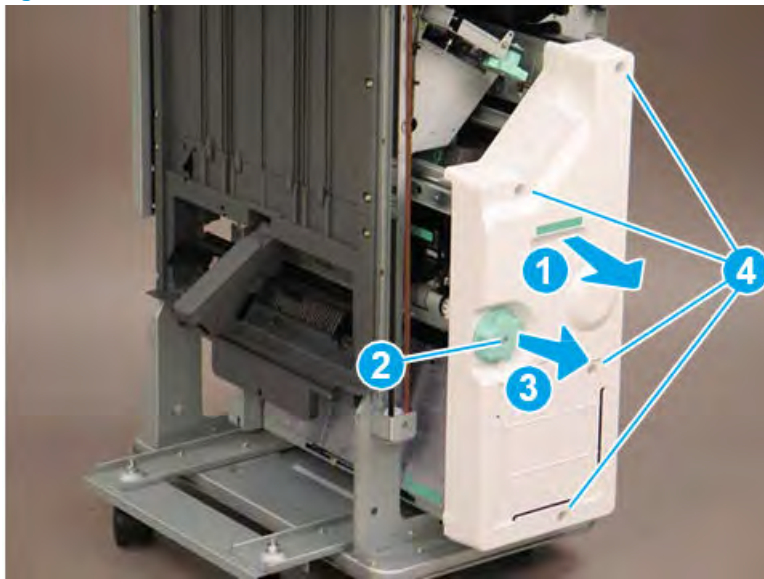
- ▲ Slide the booklet maker slightly away from the finisher (callout 1). Remove one screw (callout 2), and then slide the green knob away from the booklet maker to remove it (callout 3). Remove four screws (callout 4), and then remove the booklet front cover.

---

💡 **TIP:** Reverse the removal steps to install the assembly

---

**Figure 5-1871** Remove five screws and the cover



## Remove the booklet diverter motor (M18)

Follow these steps to remove the booklet diverter motor (M18).

- ▲ Disconnect one connector (callout 1), remove two screws (callout 2), and then remove the booklet diverter motor.

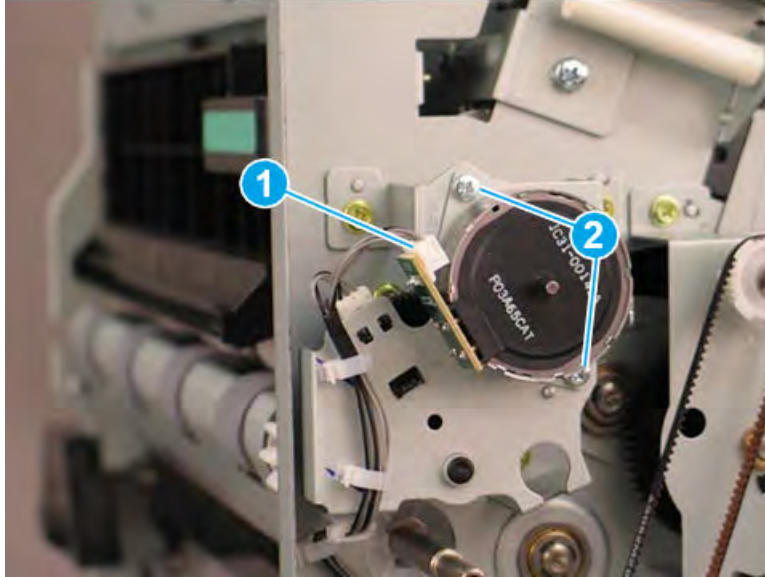
---

💡 **TIP:** Reverse the removal steps to install the assembly.

---



Figure 5-1872 Remove the separate pawl motor




### Unpack the replacement assembly

Follow these steps to unpack the replacement assembly.

1. Dispose of the defective part.

---



 **NOTE:** HP recommends responsible disposal of the defective part.


<http://www8.hp.com/us/en/hp-information/environment/product-recycling.html>


---

2. Unpack the replacement part from the packaging.

---

 **CAUTION:**  Some parts are sensitive to electrostatic discharge (ESD). Always perform service work at an ESD-protected workstation or mat. If an ESD workstation or mat is not available, touch the sheet-metal chassis to provide a static ground before touching an ESD-sensitive assembly. Protect the ESD-sensitive assemblies by placing them in ESD pouches when they are out of the printer.


 **IMPORTANT:** Make sure that all of the shipping materials (for example shipping tape) are removed from the replacement part prior to installation.

 **NOTE:** If the replacement part is a roller or pad, avoid touching the spongy part of it. Skin oils on the roller or pad can cause paper pickup and/or print-quality problems. HP recommends using disposable gloves when handling rollers or pads or washing your hands before touching rollers or pads.

---

3. To install an assembly, reverse the removal steps.

---

 **NOTE:** When applicable, special installation instructions are provided for an assembly at the end of the removal procedure. Always completely read the removal instructions and follow all special installation instructions.

---


## Booklet exit unit

## Removal and replacement: Booklet exit sensor (S44)

Learn how to remove and replace the tray booklet exit sensor.

### Introduction

This document provides the procedures to remove and replace the booklet exit sensor on the finisher.

 **IMPORTANT:** When applicable, special installation instructions are provided for an assembly at the end of the removal procedure. Always completely read the removal instructions and follow all special installation instructions.

### Before performing service

- Turn the printer power off. A shutting-down message appears on the control-panel display.
- ⚠ **WARNING!** To avoid damage to the printer, turn the power off and wait until the printer shuts down before removing the power cable.
- Disconnect the printer power cable after the printer has completely shut down (the control-panel display is blank).
- Release the finisher from the printer by pulling out on the release latch inside the finisher door.
- Disconnect the cable from the bridge unit to the finisher.
- Disconnect the cable from the finisher to the printer.

Use the table below to identify the correct part number for your printer. To order the part, go to <https://parts.hp.com..>

**Table 5-168 Part information**

Part number	Part description
JC32-00020A	Booklet exit sensor

### Required tools

- #2 JIS screwdriver with a magnetic tip

### After performing service

- Connect the cable from the finisher to the printer.
- Connect the cable from the bridge unit to the finisher.
- Attach the finisher to the printer, and then push in on the release latch inside the finisher door.
- Connect the printer power cable.
- Turn the printer power on.

### Post service test

Process a job through the finisher and verify that the finisher works correctly.

### Remove the right upper cover (finisher)

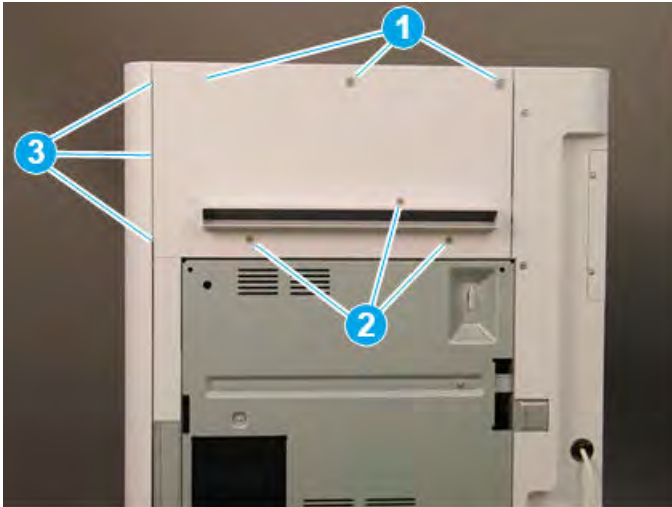
Follow these steps to remove the right upper cover (finisher).

- ▲ Remove one screw cap and three machine screws on the upper edge of the cover (callout 1). Remove three sheet metal screws (callout 2) on the lower portion of the cover. Rotate the right edge of the cover away from the finisher, and then slide the cover right to release three tabs (callout 3).

💡 **TIP:** The lower screws are shorter in length than the upper screws.

**TIP:** Reverse the removal steps to install the assembly.

**Figure 5-1873** Remove the right upper cover

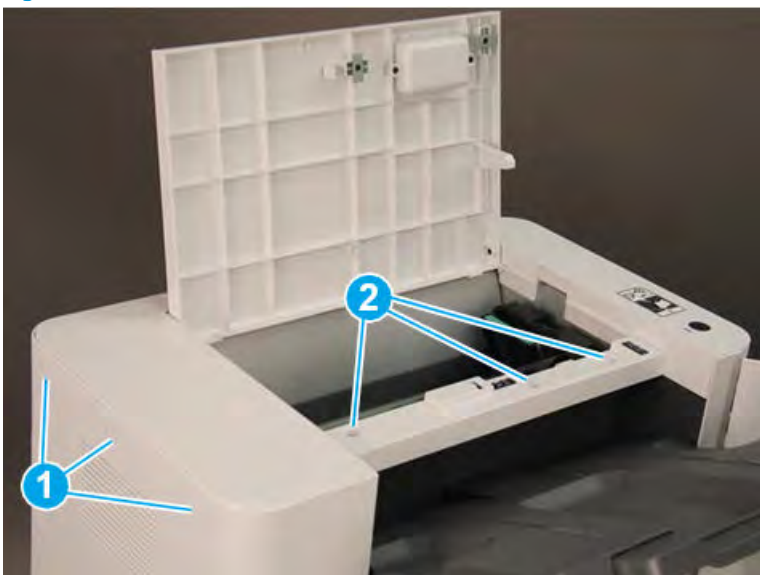


### Remove the top cover (finisher)

Follow these steps to remove the top cover (finisher).

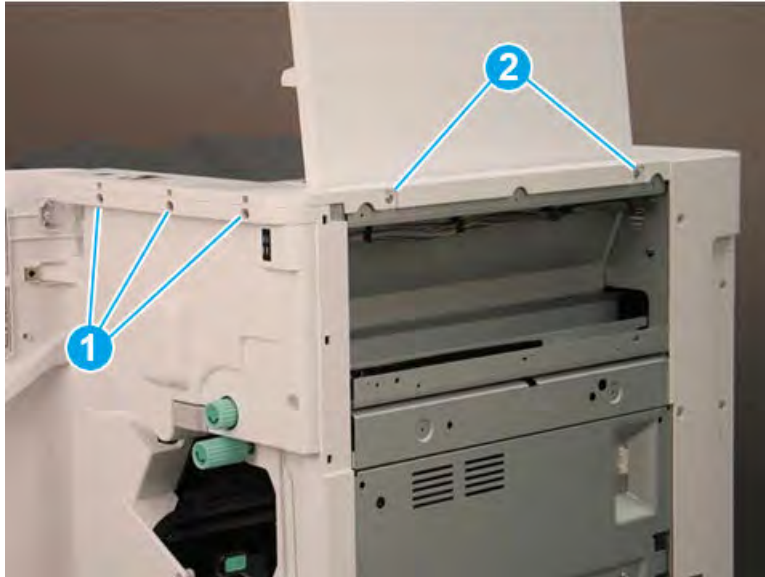
1. Remove three screw caps and three self-tapping screws at the top of the rear cover (callout 1), and then remove three machine screws (callout 2) on top of the cover.

**Figure 5-1874** Remove six screws



2. Remove three self-tapping screws at the top of the front cover (callout 1), and then remove two machine screws (callout 2) at the top of the right side.

Figure 5-1875 Remove five screws



3. Lift the cover up slightly. Disconnect one in-line connector (callout 1), and then release one retainer (callout 2).


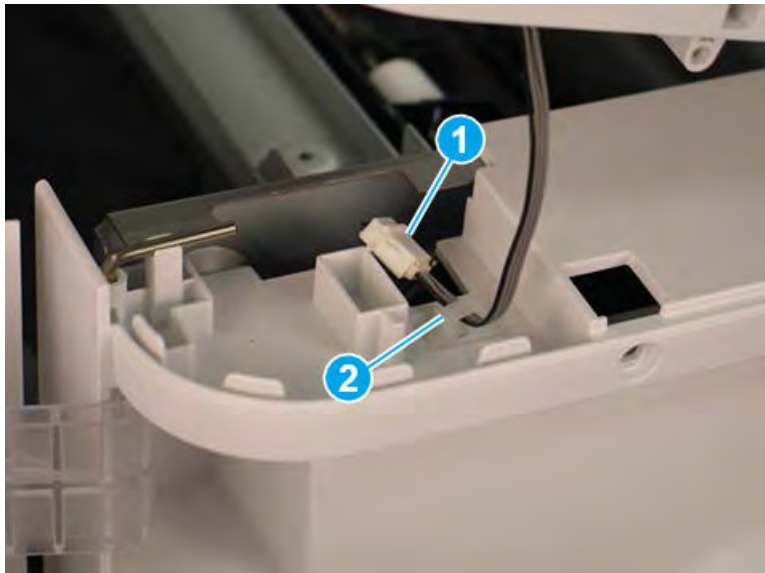
 **TIP:** Reverse the removal steps to install the assembly.

Figure 5-1876 Disconnect one connector and release retainer



### Remove the rear cover (finisher)

Follow these steps to remove the rear cover (finisher).

1. Remove two self-tapping screws (callout 1) on the top of the rear cover, and then remove five screw caps and five machine screws (callout 2) on the left side of the cover.

Figure 5-1877 Remove seven screws

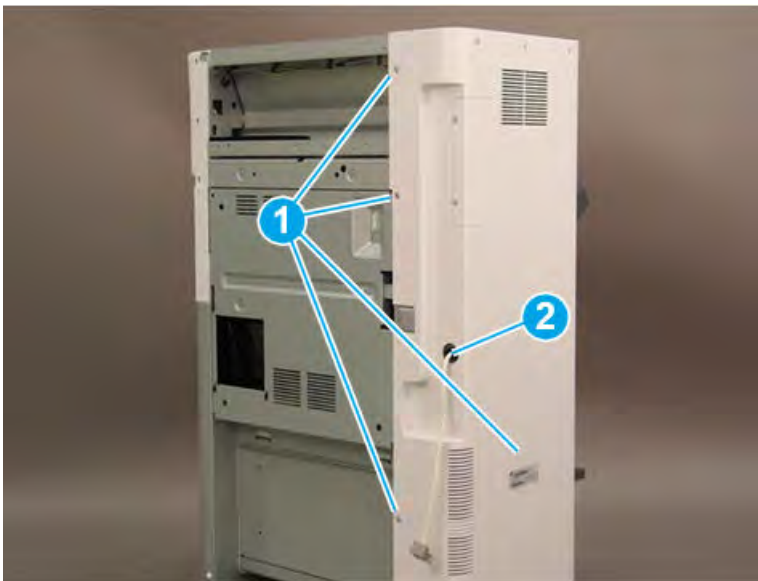


2. Remove one screw cap and four machine screws (callout 1) Remove the rear cover.

 **NOTE:** Make sure to thread the power cable (callout 2) through the opening in the cover.

 **TIP:** Reverse the removal steps to install the assembly

Figure 5-1878 Remove the rear cover



### Remove the booklet maker

Follow these steps to remove the booklet maker.

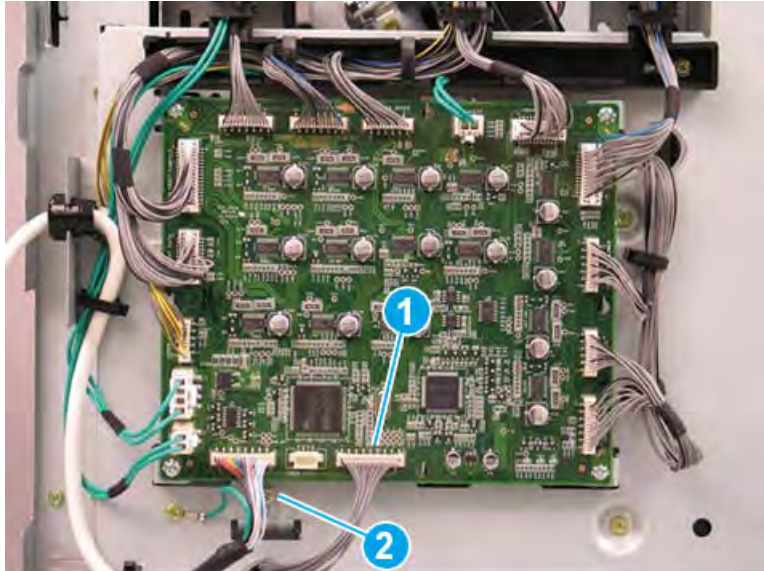
1. Slide the booklet maker away from the finisher.

Figure 5-1879 Slide the booklet maker away from the finisher



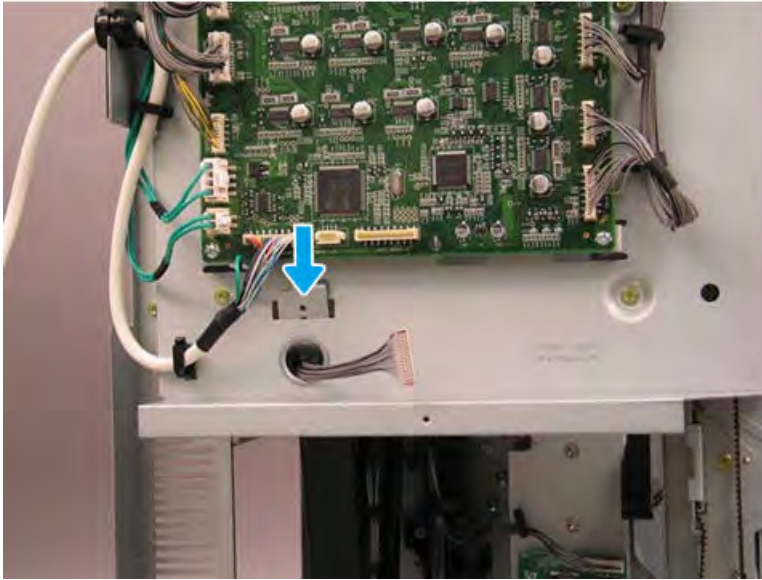
2. At the Disconnect one connector (callout 1), and then remove one screw (callout 2).

Figure 5-1880 Disconnect one connector and remove one screw



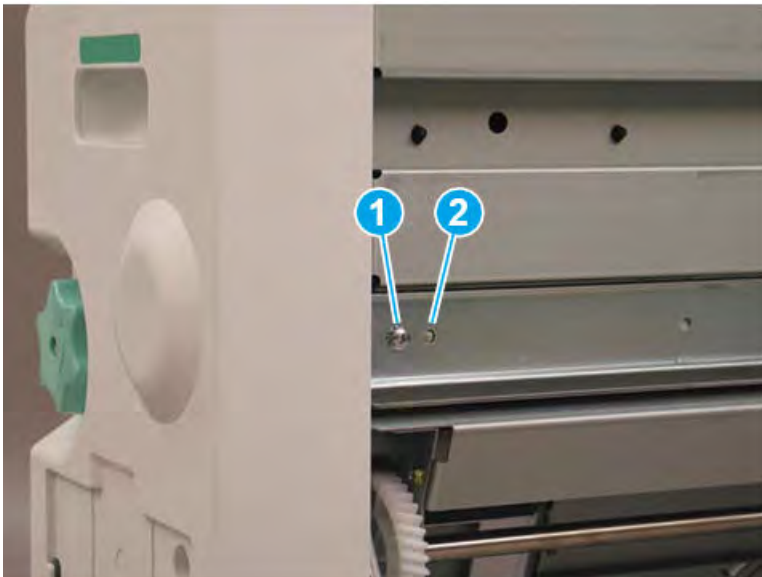
3. Release the metal bracket through the opening in the sheet metal.

Figure 5-1881 Release the metal bracket



4. Remove one star-washer screw (callout 1), and then release the alignment pin (callout 2) on the right side of the booklet maker.

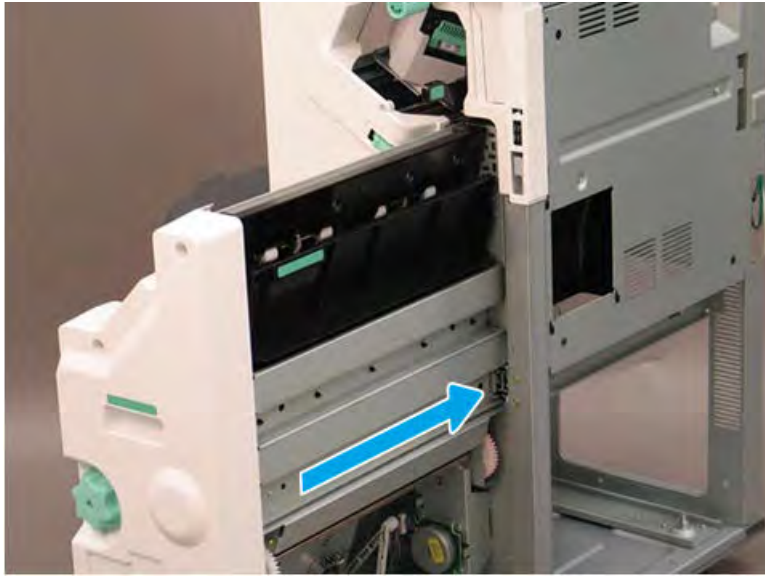
Figure 5-1882 Remove one screw





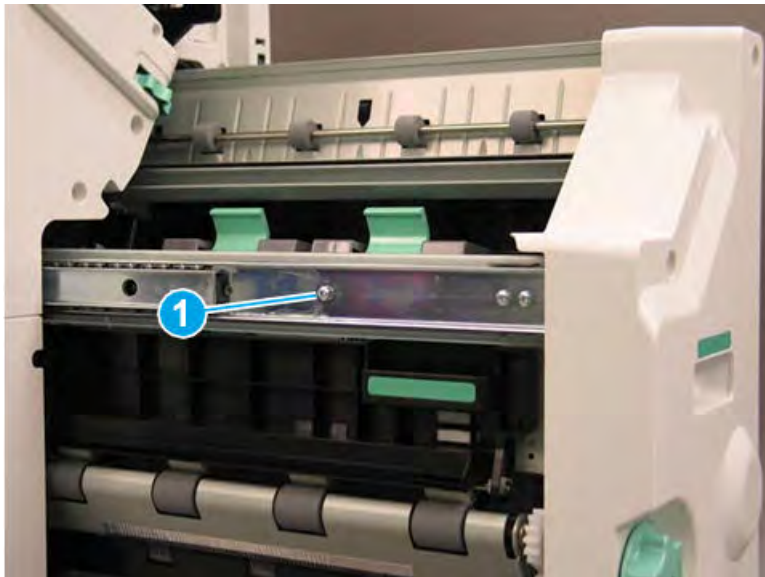
5. Slide the right rail toward the finisher.

Figure 5-1883 Slide the right rail



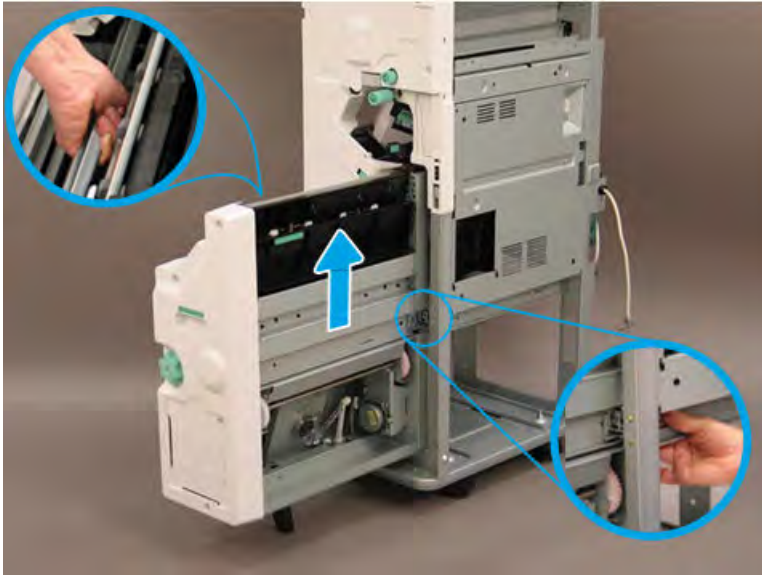
6. Remove one star-washer screw (callout 1) on the left side of the booklet maker.

Figure 5-1884 Remove one screw



7. Lift the booklet maker up on the left side while squeezing the right rail away from the finisher slightly to clear the sheet metal. Remove the booklet maker.

**Figure 5-1885** Remove the booklet maker



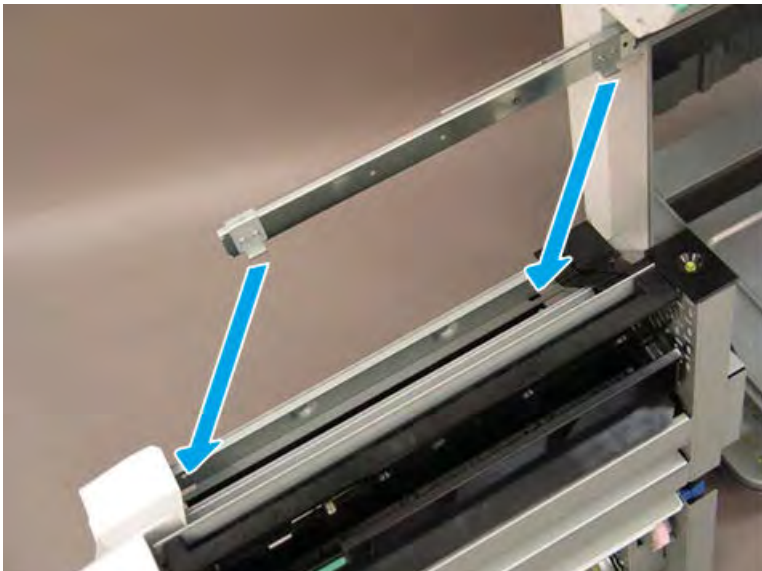
8. Reverse the removal steps to install the assembly. Also use the following special installation instructions.

 **NOTE:** Continue to reverse the removal steps to finish installing the assembly.

**Special installation instructions: booklet maker**

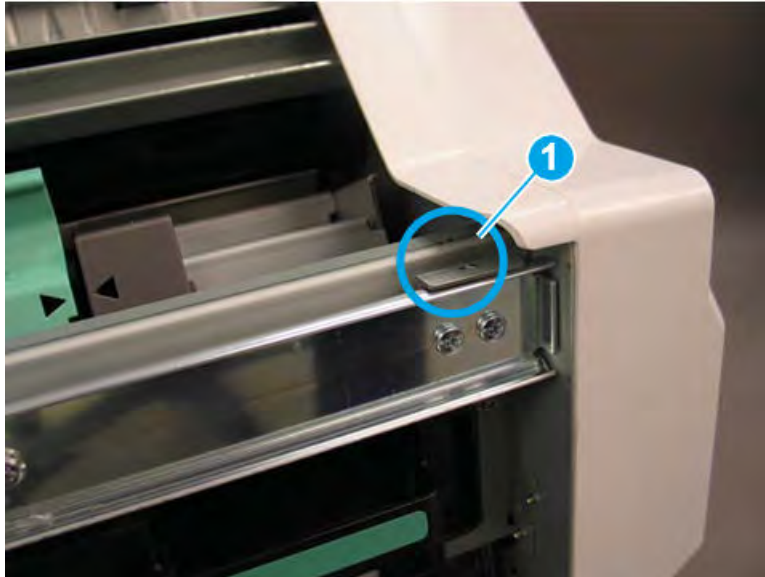
When installing the booklet maker, position the hooks on the rail under the slots on the booklet maker.

**Figure 5-1886** Position the hooks



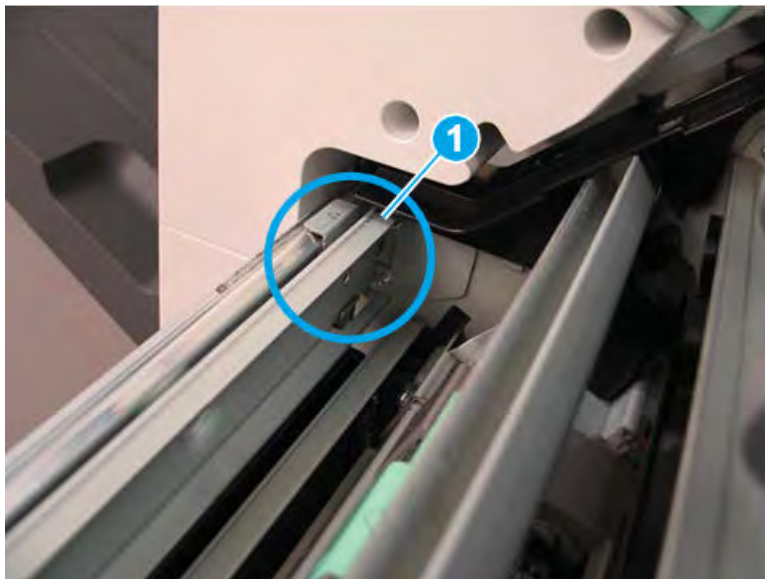
9. When installed correctly, the arrow on the front of the booklet maker aligns with the arrow on the finisher rail.

Figure 5-1887 Align arrows



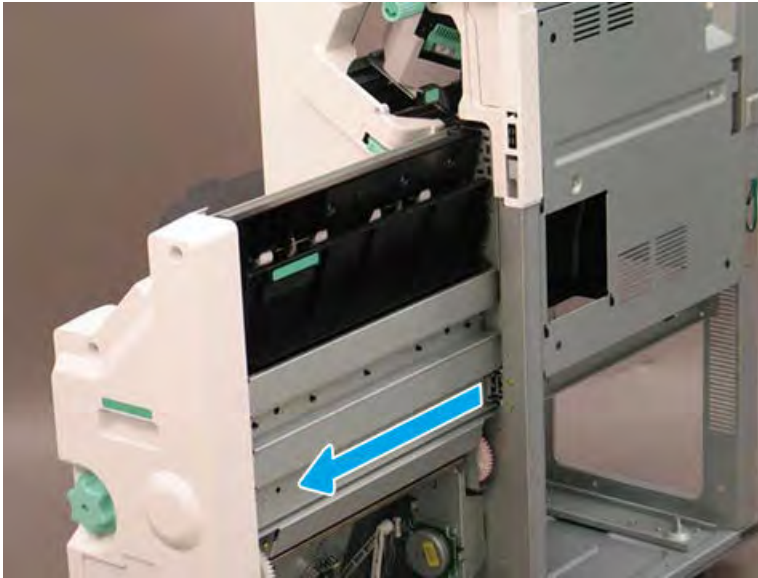
10. When installed correctly, the arrow on the back of the booklet maker aligns with the arrow on the finisher rail.

Figure 5-1888 Align arrows



11. Extend the right rail away from the finisher and position it in the booklet maker slot.

Figure 5-1889 Extend the right rail



### Remove the booklet front cover

Follow these steps to remove the booklet front cover.

- ▲ Slide the booklet maker slightly away from the finisher (callout 1). Remove one screw (callout 2), and then slide the green knob away from the booklet maker to remove it (callout 3). Remove four screws (callout 4), and then remove the booklet front cover.


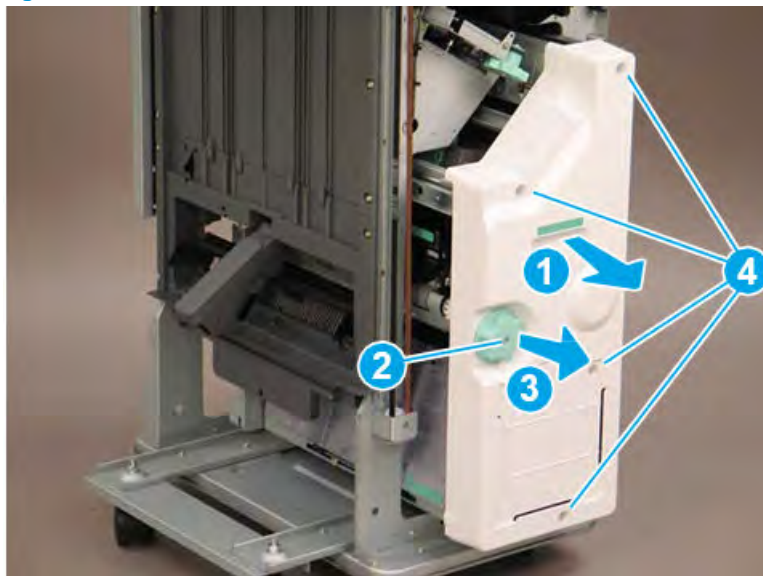
 **TIP:** Reverse the removal steps to install the assembly

Figure 5-1890 Remove five screws and the cover

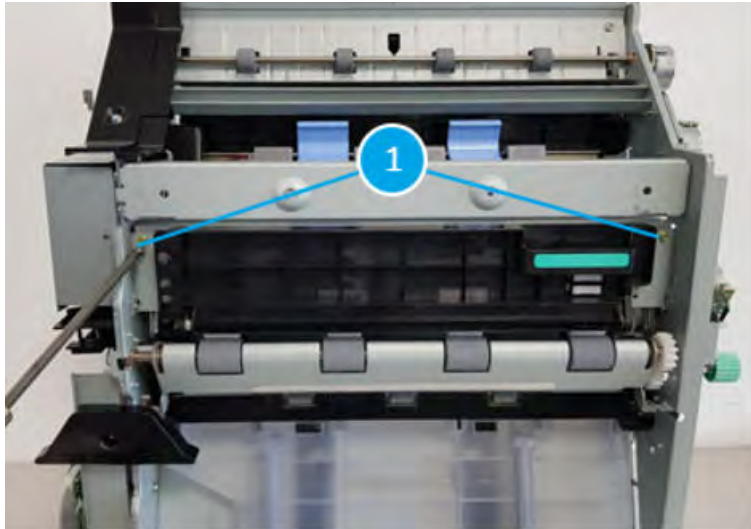


### Remove the Booklet c-fold blade unit

Follow these steps to remove the Booklet c-fold blade unit.

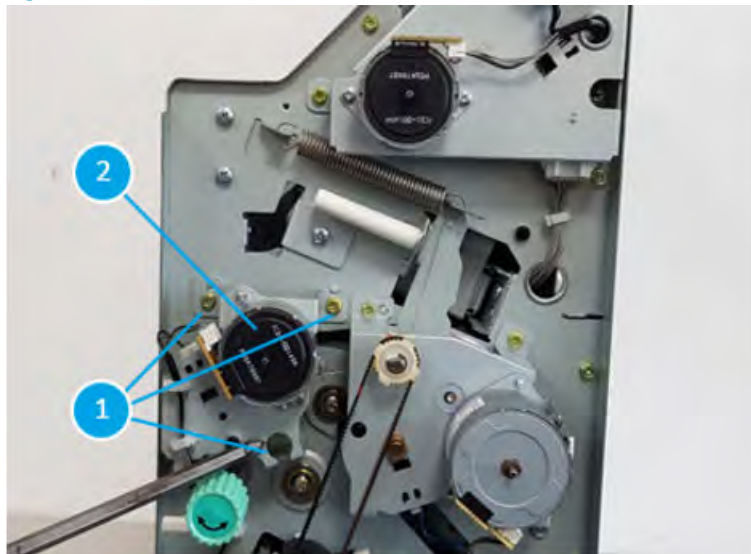
1. Remove two screws(callout 1) at the left of the booklet maker

Figure 5-1891 Remove two screws at the left of the booklet maker



2. Remove three screws(callout 1) at the front of the booklet maker to remove motor unit(callout 2) to reach out to the screw.

Figure 5-1892 Remove three screws to remove motor unit to reach out to the screw



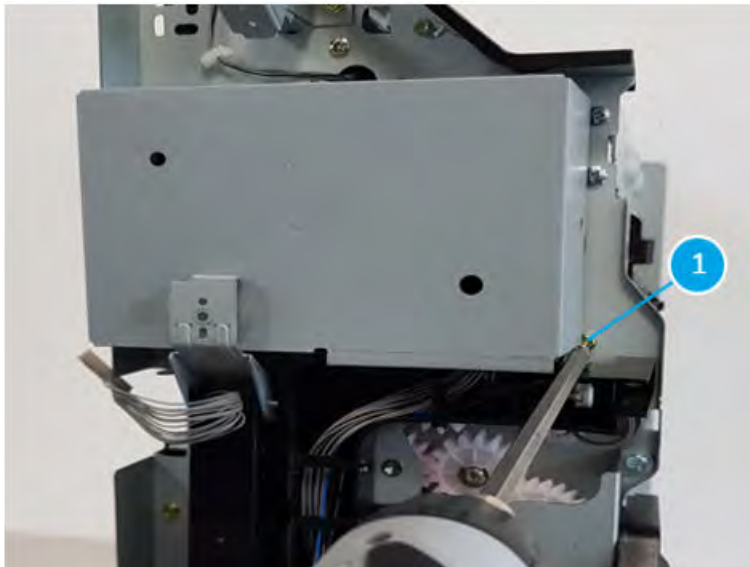
3. Remove one screw(callout 1) at the front of the booklet maker.

Figure 5-1893 Remove one screw at the front of the booklet maker



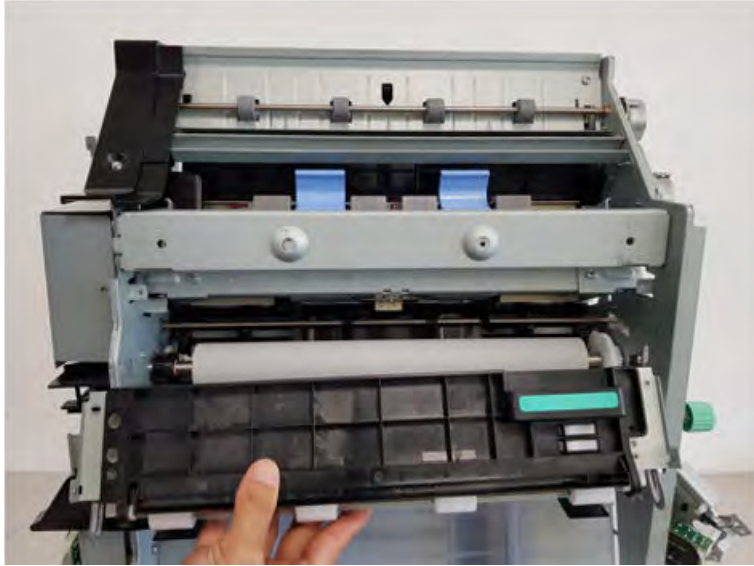
4. Remove one screw(callout 1) at the rear of the booklet maker.

Figure 5-1894 Remove one screw at the rear of the booklet maker



5. Take the booklet c-fold blade unit out from the booklet maker.

**Figure 5-1895** Take the booklet c-fold blade unit out from the booklet maker

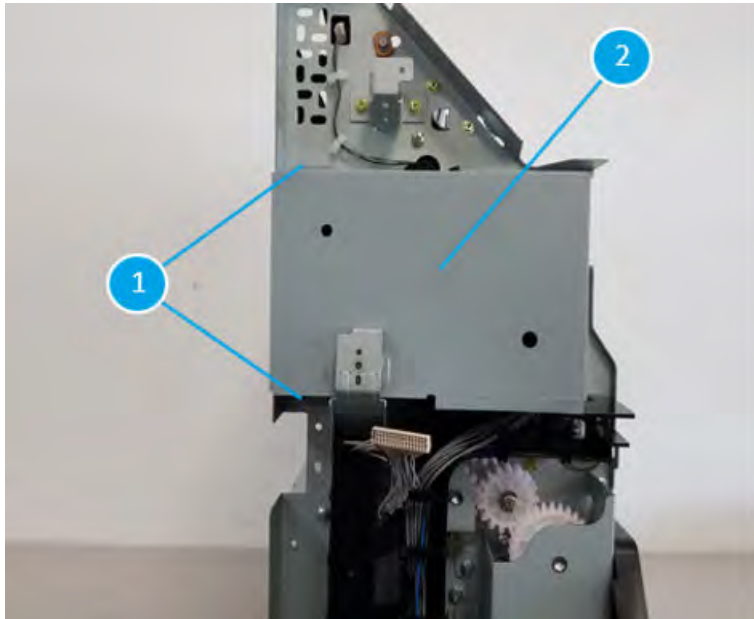


#### Remove the booklet diverter

Follow these steps to remove the booklet diverter.

1. Remove two screws (callout 1) at the rear of the booklet maker and remove the PCA cover (callout 2).

**Figure 5-1896** Remove two screws at the rear of the booklet maker and remove the PCA cover



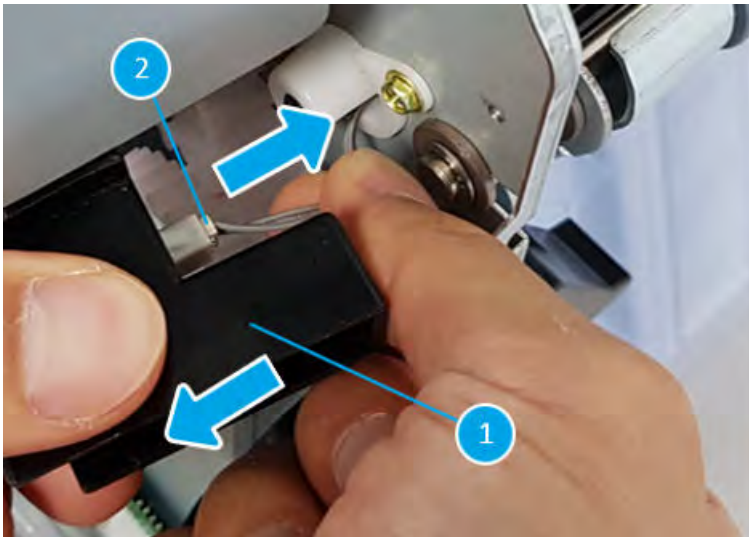
2. Remove one screw(callout 1) at the rear of the booklet maker to make it easy to disconnect the connector.

Figure 5-1897 Remove one screw at the rear of the booklet maker



3. Pull the connector cover (callout 1) and disconnect the one connector (callout 2)

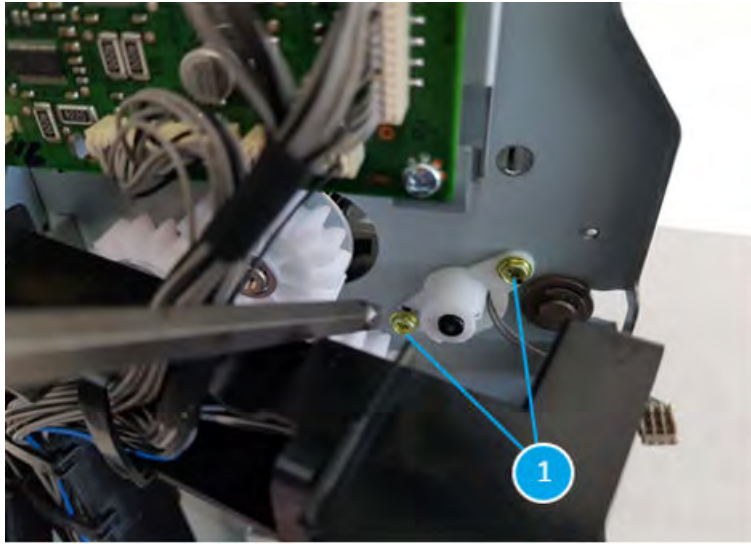
Figure 5-1898 Pull the connector cover and disconnect the one connector





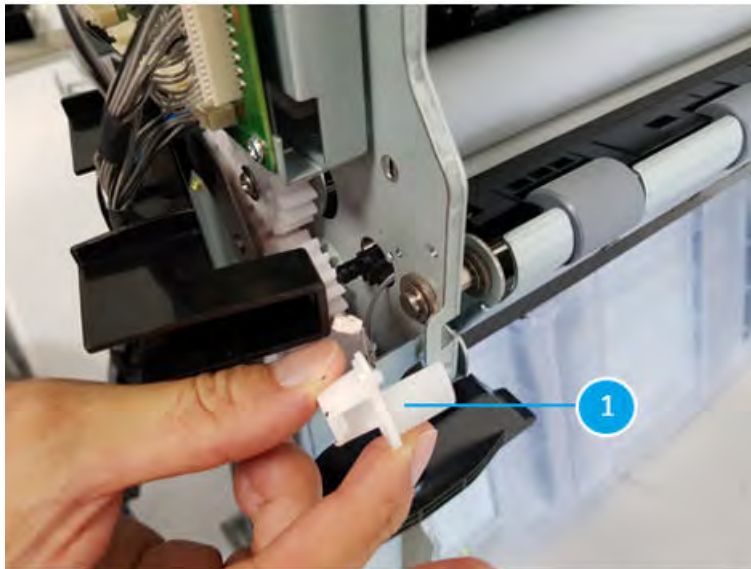
4. Remove two screws(callout 1)

Figure 5-1899 Remove two screws



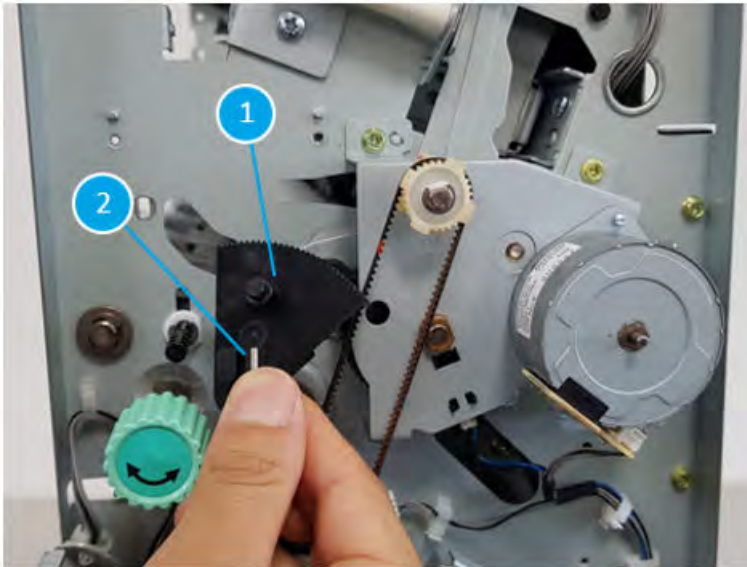
5. Remove the white bush

Figure 5-1900 Remove the white bush



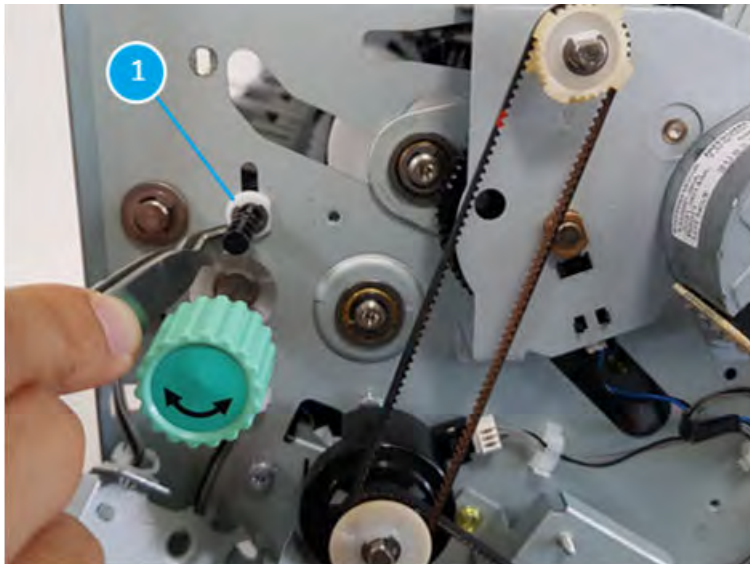
6. Remove one e-clip on top of the black actuator (callout 1) and remove the black actuator and make sure not to lose the pin (callout 2) when you pull out the black actuator.

**Figure 5-1901** Remove one e-clip on top of the black actuator (callout 1) and remove the black actuator



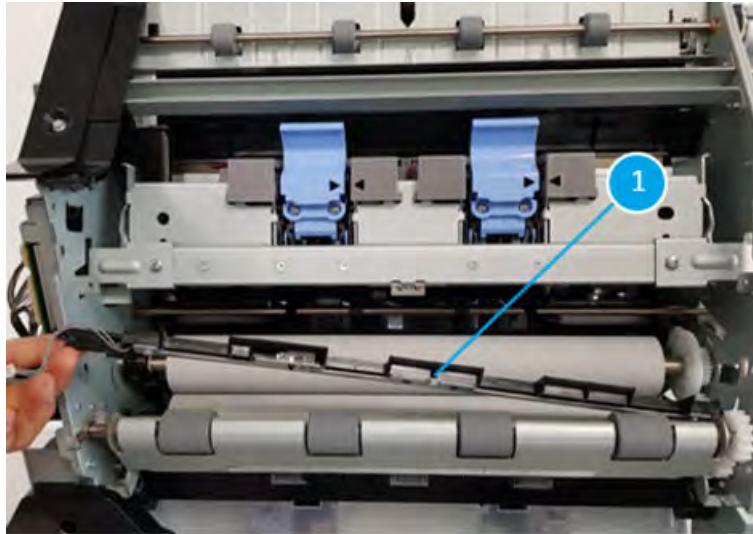
7. Remove the white bush (callout 1).

**Figure 5-1902** Remove the white bush



8. Pull the booklet diverter out from the booklet maker.

**Figure 5-1903** Pull the booklet diverter out from the booklet maker

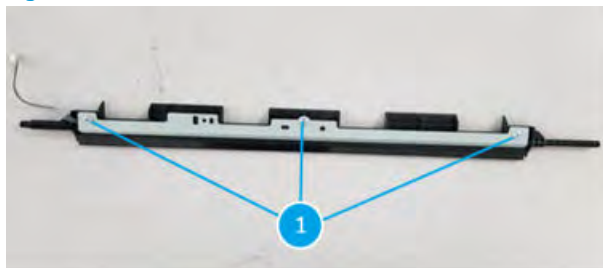


#### Remove the booklet exit sensor (S44)

Follow these steps to remove the booklet exit sensor (S44).

1. Remove three screws (callout 1)

**Figure 5-1904** Remove three screws



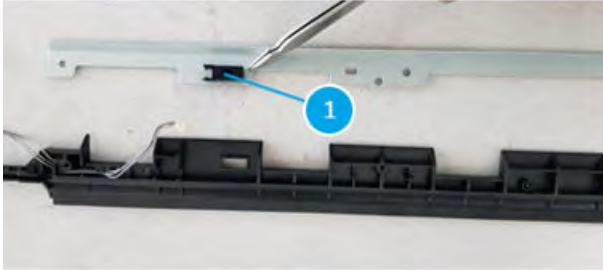
2. Unplug one connector (callout 1)

**Figure 5-1905** Unplug one connector



3. Remove the booklet exit sensor (S44, callout 1)

**Figure 5-1906** Remove the booklet exit sensor



### Unpack the replacement assembly



Follow these steps to unpack the replacement assembly.


1. Dispose of the defective part.


 **NOTE:** HP recommends responsible disposal of the defective part.

<http://www8.hp.com/us/en/hp-information/environment/product-recycling.html>


2. Unpack the replacement part from the packaging.

 **CAUTION:**  Some parts are sensitive to electrostatic discharge (ESD). Always perform service work at an ESD-protected workstation or mat. If an ESD workstation or mat is not available, touch the sheet-metal chassis to provide a static ground before touching an ESD-sensitive assembly. Protect the ESD-sensitive assemblies by placing them in ESD pouches when they are out of the printer.

 **IMPORTANT:** Make sure that all of the shipping materials (for example shipping tape) are removed from the replacement part prior to installation.

 **NOTE:** If the replacement part is a roller or pad, avoid touching the spongy part of it. Skin oils on the roller or pad can cause paper pickup and/or print-quality problems. HP recommends using disposable gloves when handling rollers or pads or washing your hands before touching rollers or pads.

3. To install an assembly, reverse the removal steps.

 **NOTE:** When applicable, special installation instructions are provided for an assembly at the end of the removal procedure. Always completely read the removal instructions and follow all special installation instructions.


## Booklet output tray unit

## Removal and replacement: Booklet output tray

Learn how to remove and replace the booklet output tray.

### Introduction

This document provides the procedures to remove and replace the booklet output tray on the finisher.

 **IMPORTANT:** When applicable, special installation instructions are provided for an assembly at the end of the removal procedure. Always completely read the removal instructions and follow all special installation instructions.

### Before performing service

- Turn the printer power off. A shutting-down message appears on the control-panel display.
- ⚠ **WARNING!** To avoid damage to the printer, turn the power off and wait until the printer shuts down before removing the power cable.
- Disconnect the printer power cable after the printer has completely shut down (the control-panel display is blank).
- Release the finisher from the printer by pulling out on the release latch inside the finisher door.
- Disconnect the cable from the bridge unit to the finisher.
- Disconnect the cable from the finisher to the printer.

Use the table below to identify the correct part number for your printer. To order the part, go to <https://parts.hp.com>.

**Table 5-169** Part information

Part number	Part description
JC61-07253B	Booklet output tray
JC63-04978B	Booklet output tray cover

### Required tools

- #2 JIS screwdriver with a magnetic tip

### After performing service

- Connect the cable from the finisher to the printer.
- Connect the cable from the bridge unit to the finisher.
- Attach the finisher to the printer, and then push in on the release latch inside the finisher door.
- Connect the printer power cable.
- Turn the printer power on.

### Post service test

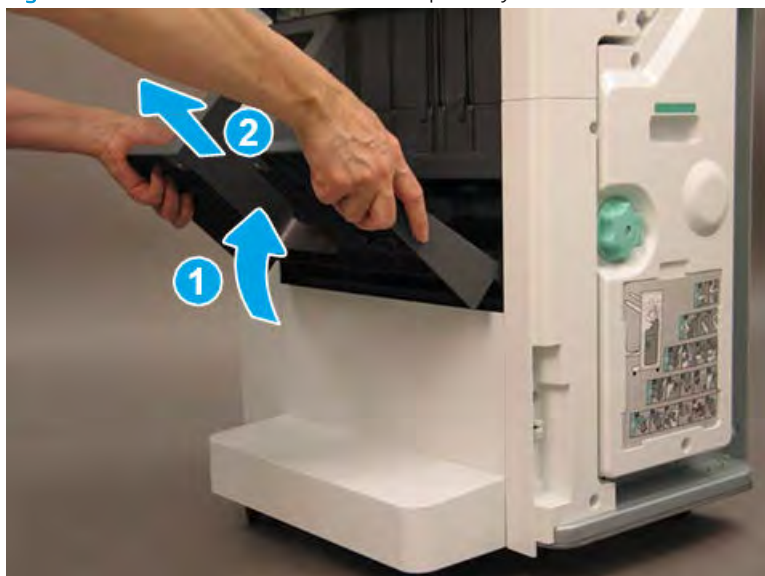
Process a job through the finisher and verify that the finisher works correctly.

## Remove the booklet output tray

Follow these steps to remove the booklet output tray.

1. Raise the booklet output tray up (callout 1), and then pull it away from the finisher (callout 2) to remove it.

Figure 5-1907 Remove the booklet output tray



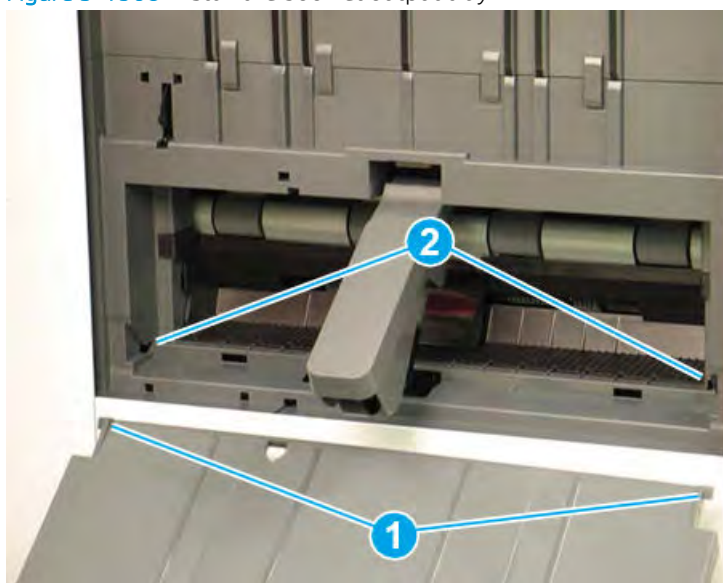
2. Reverse the removal steps to install the assembly. Also use the following special installation instructions.

 **NOTE:** Continue to reverse the removal steps to finish installing the assembly

Special installation instructions: booklet output tray

Position the tabs (callout 1) on the tray into the slots (callout 2) on the finisher.

Figure 5-1908 Install the booklet output tray



## Unpack the replacement assembly

Follow these steps to unpack the replacement assembly.

1. Dispose of the defective part.

---



 **NOTE:** HP recommends responsible disposal of the defective part.

<http://www8.hp.com/us/en/hp-information/environment/product-recycling.html>


---

2. Unpack the replacement part from the packaging.

---

 **CAUTION:**  Some parts are sensitive to electrostatic discharge (ESD). Always perform service work at an ESD-protected workstation or mat. If an ESD workstation or mat is not available, touch the sheet-metal chassis to provide a static ground before touching an ESD-sensitive assembly. Protect the ESD-sensitive assemblies by placing them in ESD pouches when they are out of the printer.


 **IMPORTANT:** Make sure that all of the shipping materials (for example shipping tape) are removed from the replacement part prior to installation.

 **NOTE:** If the replacement part is a roller or pad, avoid touching the spongy part of it. Skin oils on the roller or pad can cause paper pickup and/or print-quality problems. HP recommends using disposable gloves when handling rollers or pads or washing your hands before touching rollers or pads.

---

3. To install an assembly, reverse the removal steps.

---

 **NOTE:** When applicable, special installation instructions are provided for an assembly at the end of the removal procedure. Always completely read the removal instructions and follow all special installation instructions.

---




PCA

## Removal and replacement: Main PCA

Learn how to remove and replace the main PCA.

### Introduction

This document provides the procedures to remove and replace the main PCA on the finisher.

 **IMPORTANT:** When applicable, special installation instructions are provided for an assembly at the end of the removal procedure. Always completely read the removal instructions and follow all special installation instructions.

### Before performing service

- Turn the printer power off. A shutting-down message appears on the control-panel display.
- ⚠ **WARNING!** To avoid damage to the printer, turn the power off and wait until the printer shuts down before removing the power cable.
- Disconnect the printer power cable after the printer has completely shut down (the control-panel display is blank).
- Release the finisher from the printer by pulling out on the release latch inside the finisher door.
- Disconnect the cable from the bridge unit to the finisher.
- Disconnect the cable from the finisher to the printer.

Use the table below to identify the correct part number for your printer. To order the part, go to <https://parts.hp.com>.

**Table 5-170 Part information**

Part number	Part description
JC92-02968A	Finisher mainPCA

### Required tools

- #2 JIS screwdriver with a magnetic tip

### After performing service

- Connect the cable from the finisher to the printer.
- Connect the cable from the bridge unit to the finisher.
- Attach the finisher to the printer, and then push in on the release latch inside the finisher door.
- Connect the printer power cable.
- Turn the printer power on.

### Post service test

Process a job through the finisher and verify that the finisher works correctly.

### Remove the right upper cover (finisher)

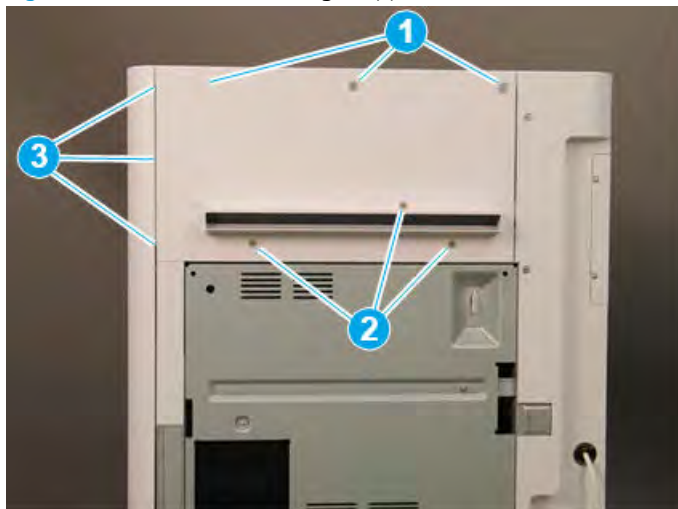
Follow these steps to remove the right upper cover (finisher).

- ▲ Remove one screw cap and three machine screws on the upper edge of the cover (callout 1). Remove three sheet metal screws (callout 2) on the lower portion of the cover. Rotate the right edge of the cover away from the finisher, and then slide the cover right to release three tabs (callout 3).

💡 **TIP:** The lower screws are shorter in length than the upper screws.

**TIP:** Reverse the removal steps to install the assembly.

Figure 5-1909 Remove the right upper cover

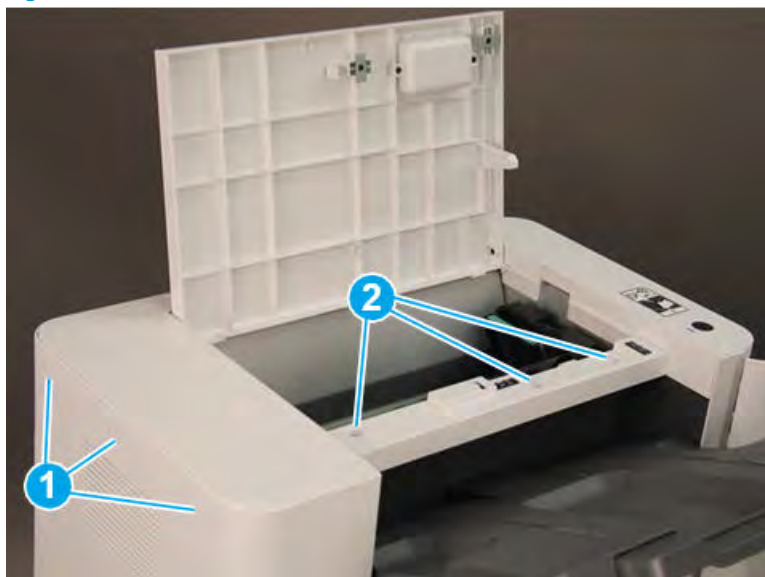


### Remove the top cover (finisher)

Follow these steps to remove the top cover (finisher).

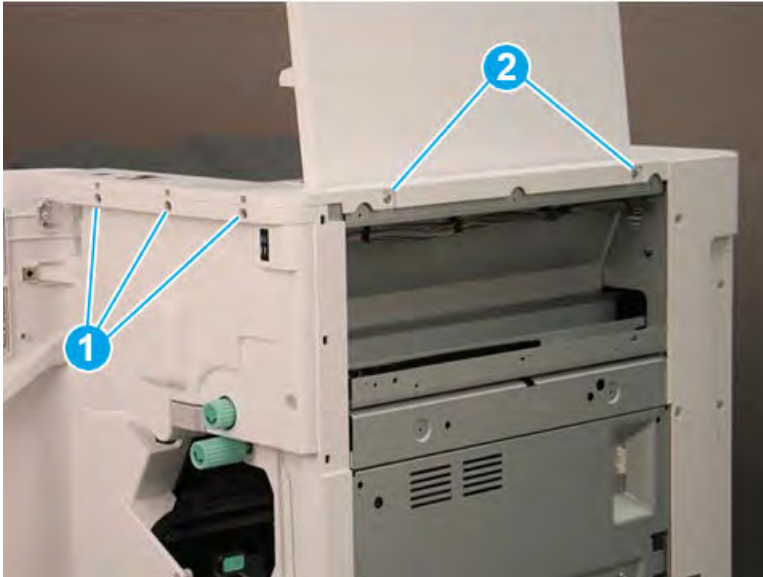
1. Remove three screw caps and three self-tapping screws at the top of the rear cover (callout 1), and then remove three machine screws (callout 2) on top of the cover.

Figure 5-1910 Remove six screws




2. Remove three self-tapping screws at the top of the front cover (callout 1), and then remove two machine screws (callout 2) at the top of the right side.

Figure 5-1911 Remove five screws



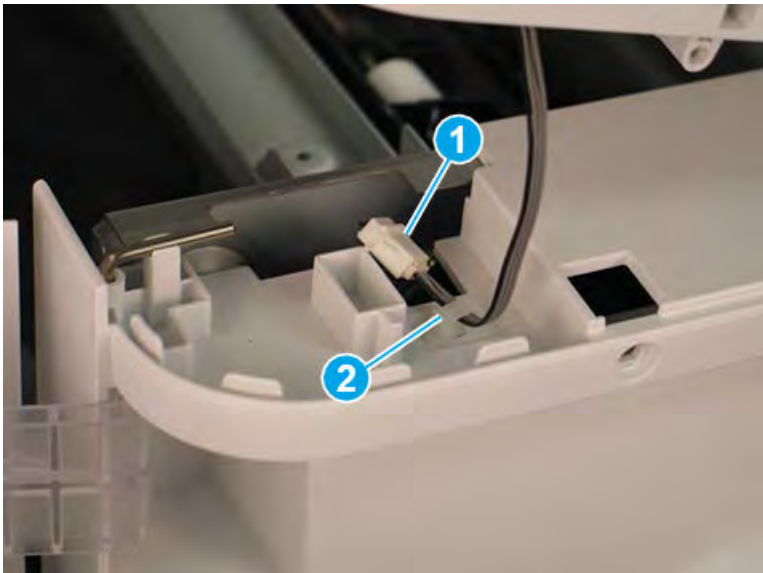
3. Lift the cover up slightly. Disconnect one in-line connector (callout 1), and then release one retainer (callout 2).

---

 **TIP:** Reverse the removal steps to install the assembly.

---

Figure 5-1912 Disconnect one connector and release retainer



### Remove the rear cover (finisher)


Follow these steps to remove the rear cover (finisher).

1. Remove two self-tapping screws (callout 1) on the top of the rear cover, and then remove five screw caps and five machine screws (callout 2) on the left side of the cover.

Figure 5-1913 Remove seven screws



2. Remove one screw cap and four machine screws (callout 1) Remove the rear cover.

 **NOTE:** Make sure to thread the power cable (callout 2) through the opening in the cover.


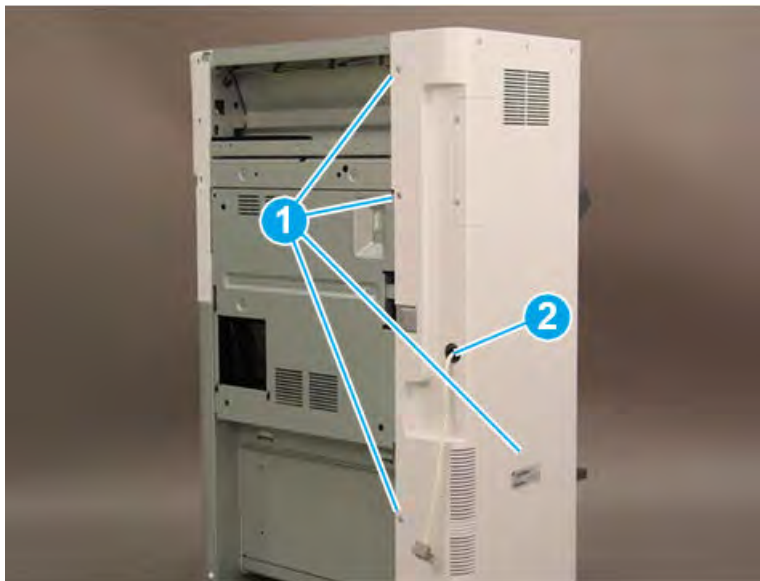
 **TIP:** Reverse the removal steps to install the assembly

Figure 5-1914 Remove the rear cover



### Remove the controller PCA

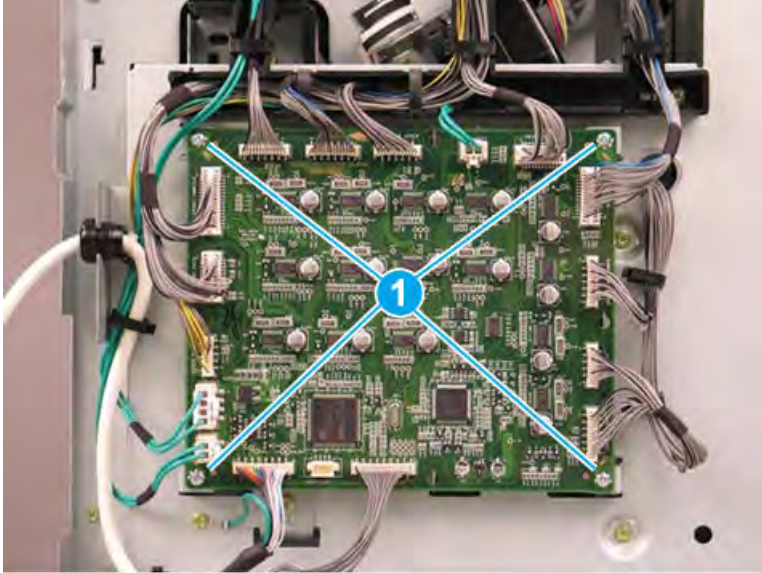
Follow these steps to remove the controller PCA.

- ▲ Disconnect all of the connectors, remove four screws (callout 1), and then remove the controller PCA.

 **TIP:** Refer to the figure below for correct positioning and connection of the cables.

**TIP:** Reverse the removal steps to install the assembly.

Figure 5-1915 Remove the controller PCA



### Unpack the replacement assembly

Follow these steps to unpack the replacement assembly.

1. Dispose of the defective part.

---



 **NOTE:** HP recommends responsible disposal of the defective part.

<http://www8.hp.com/us/en/hp-information/environment/product-recycling.html>


---

2. Unpack the replacement part from the packaging.

---

 **CAUTION:**  Some parts are sensitive to electrostatic discharge (ESD). Always perform service work at an ESD-protected workstation or mat. If an ESD workstation or mat is not available, touch the sheet-metal chassis to provide a static ground before touching an ESD-sensitive assembly. Protect the ESD-sensitive assemblies by placing them in ESD pouches when they are out of the printer.


 **IMPORTANT:** Make sure that all of the shipping materials (for example shipping tape) are removed from the replacement part prior to installation.

 **NOTE:** If the replacement part is a roller or pad, avoid touching the spongy part of it. Skin oils on the roller or pad can cause paper pickup and/or print-quality problems. HP recommends using disposable gloves when handling rollers or pads or washing your hands before touching rollers or pads.

---

3. To install an assembly, reverse the removal steps.

---

 **NOTE:** When applicable, special installation instructions are provided for an assembly at the end of the removal procedure. Always completely read the removal instructions and follow all special installation instructions.


---

## Removal and replacement: Booklet finisher PCA

Learn how to remove and replace the booklet maker PCA.

### Introduction

This document provides the procedures to remove and replace the booklet maker PCA on the finisher.

 **IMPORTANT:** When applicable, special installation instructions are provided for an assembly at the end of the removal procedure. Always completely read the removal instructions and follow all special installation instructions.

### Before performing service

- Turn the printer power off. A shutting-down message appears on the control-panel display.
- ⚠ **WARNING!** To avoid damage to the printer, turn the power off and wait until the printer shuts down before removing the power cable.
- Disconnect the printer power cable after the printer has completely shut down (the control-panel display is blank).
- Release the finisher from the printer by pulling out on the release latch inside the finisher door.
- Disconnect the cable from the bridge unit to the finisher.
- Disconnect the cable from the finisher to the printer.

Use the table below to identify the correct part number for your printer. To order the part, go to <https://parts.hp.com>.

**Table 5-171 Part information**

Part number	Part description
JC92-02789B	Booklet finisher PCA

### Required tools

- #2 JIS screwdriver with a magnetic tip

### After performing service

- Connect the cable from the finisher to the printer.
- Connect the cable from the bridge unit to the finisher.
- Attach the finisher to the printer, and then push in on the release latch inside the finisher door.
- Connect the printer power cable.
- Turn the printer power on.

### Post service test

Process a job through the finisher and verify that the finisher works correctly.

## Remove the right upper cover (finisher)

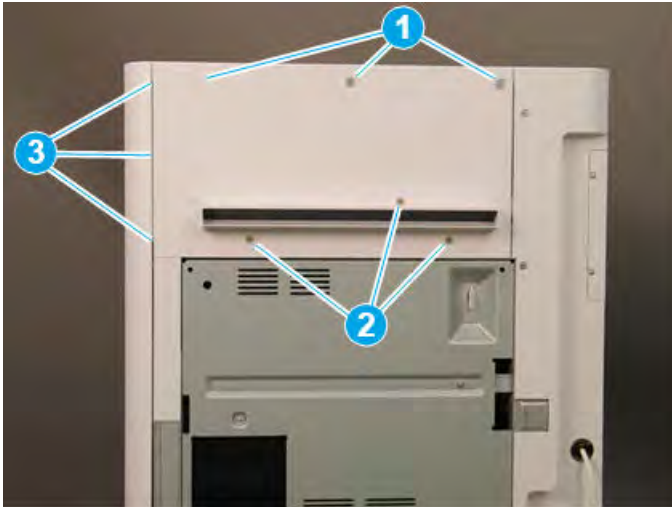
Follow these steps to remove the right upper cover (finisher).

- ▲ Remove one screw cap and three machine screws on the upper edge of the cover (callout 1). Remove three sheet metal screws (callout 2) on the lower portion of the cover. Rotate the right edge of the cover away from the finisher, and then slide the cover right to release three tabs (callout 3).

💡 **TIP:** The lower screws are shorter in length than the upper screws.

**TIP:** Reverse the removal steps to install the assembly.

**Figure 5-1916** Remove the right upper cover

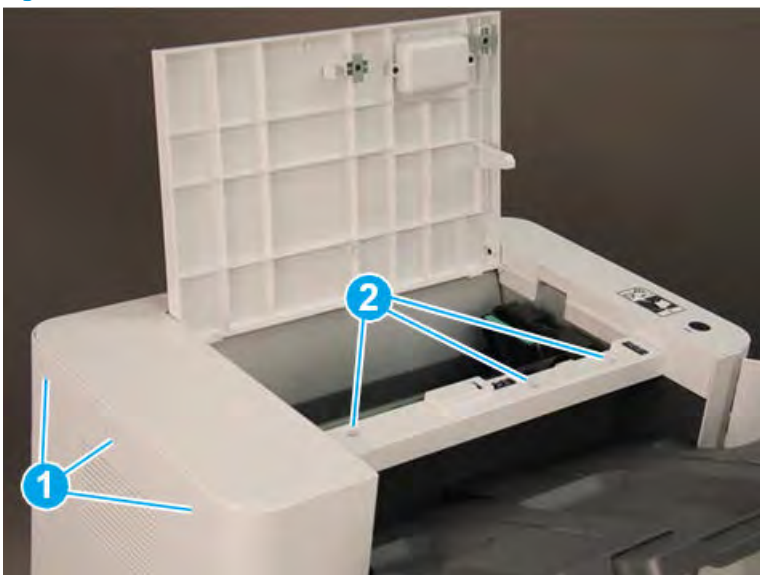


## Remove the top cover (finisher)

Follow these steps to remove the top cover (finisher).

1. Remove three screw caps and three self-tapping screws at the top of the rear cover (callout 1), and then remove three machine screws (callout 2) on top of the cover.

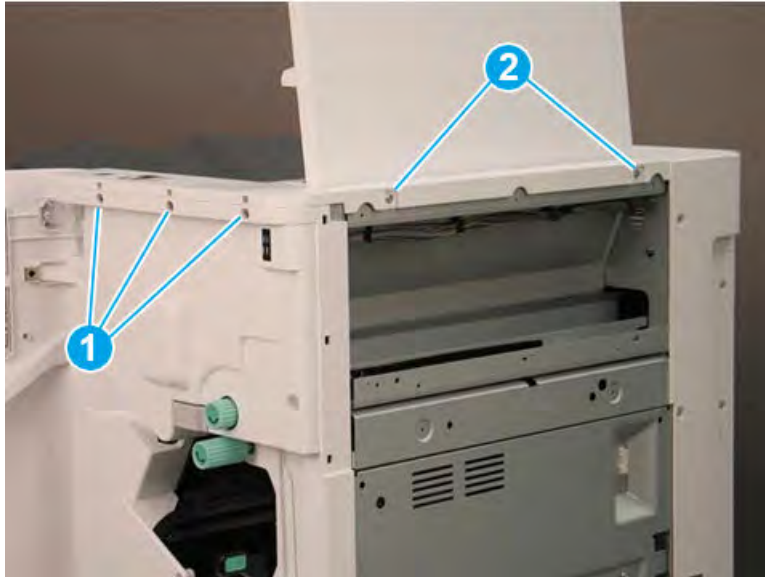
**Figure 5-1917** Remove six screws





2. Remove three self-tapping screws at the top of the front cover (callout 1), and then remove two machine screws (callout 2) at the top of the right side.

**Figure 5-1918** Remove five screws



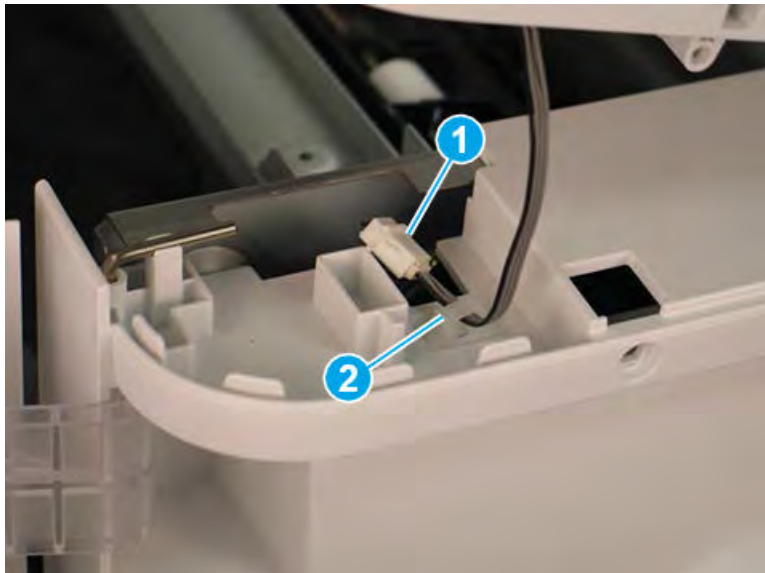
3. Lift the cover up slightly. Disconnect one in-line connector (callout 1), and then release one retainer (callout 2).

---

 **TIP:** Reverse the removal steps to install the assembly.

---

**Figure 5-1919** Disconnect one connector and release retainer

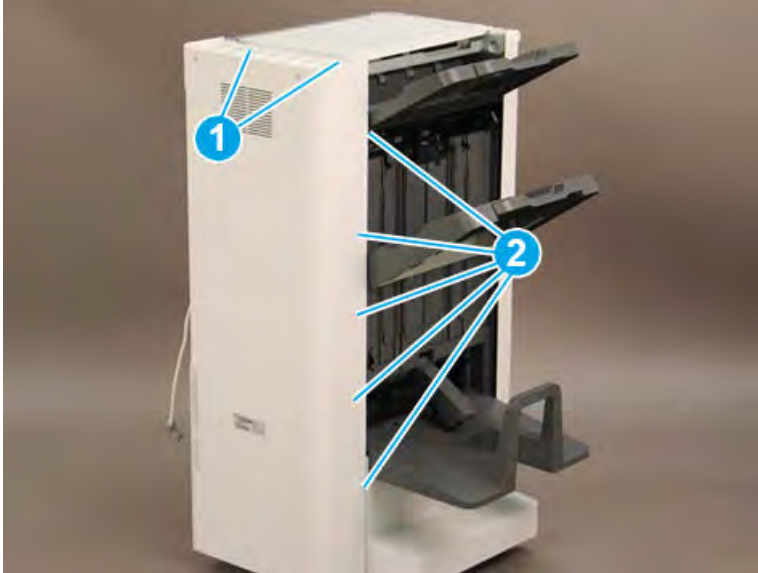


### Remove the rear cover (finisher)

Follow these steps to remove the rear cover (finisher).

1. Remove two self-tapping screws (callout 1) on the top of the rear cover, and then remove five screw caps and five machine screws (callout 2) on the left side of the cover.


Figure 5-1920 Remove seven screws



2. Remove one screw cap and four machine screws (callout 1) Remove the rear cover.

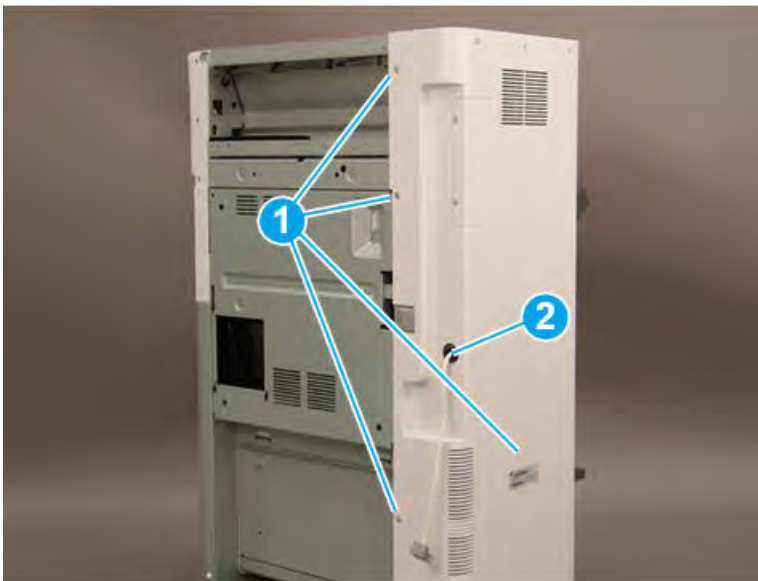
---

 **NOTE:** Make sure to thread the power cable (callout 2) through the opening in the cover.

 **TIP:** Reverse the removal steps to install the assembly

---

Figure 5-1921 Remove the rear cover



### Remove the booklet maker

Follow these steps to remove the booklet maker.

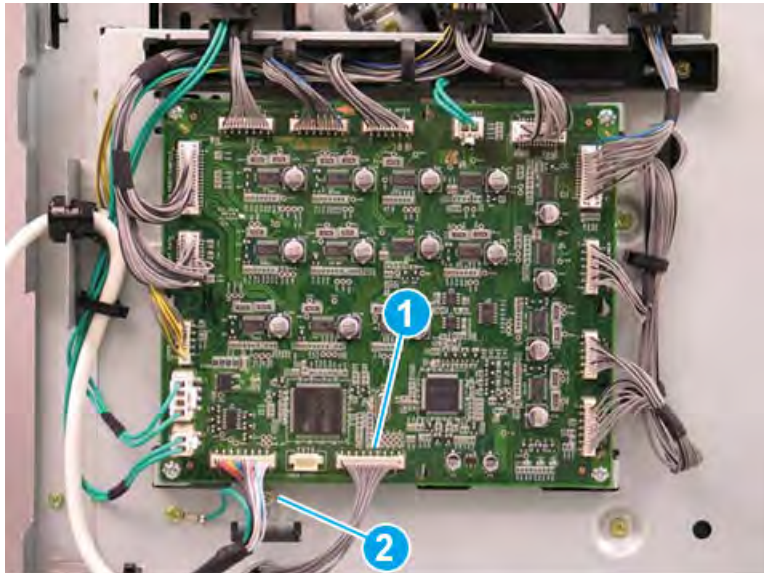
1. Slide the booklet maker away from the finisher.

Figure 5-1922 Slide the booklet maker away from the finisher



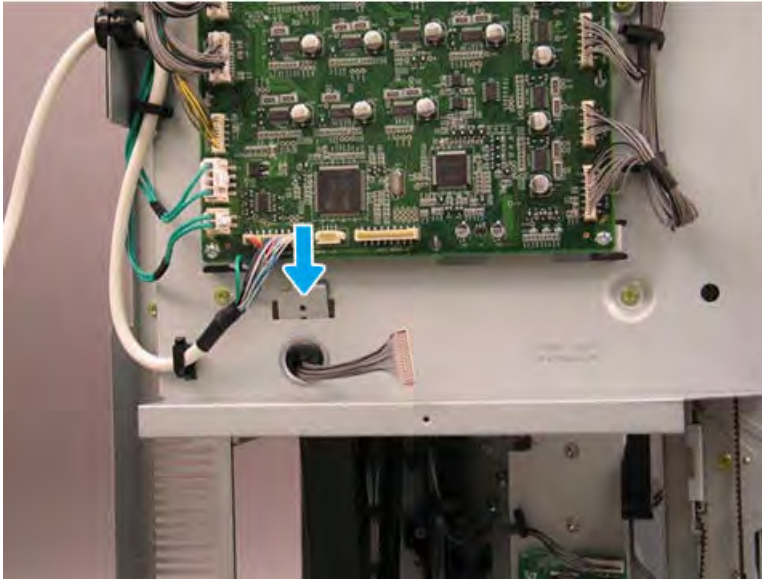
2. At the Disconnect one connector (callout 1), and then remove one screw (callout 2).

Figure 5-1923 Disconnect one connector and remove one screw



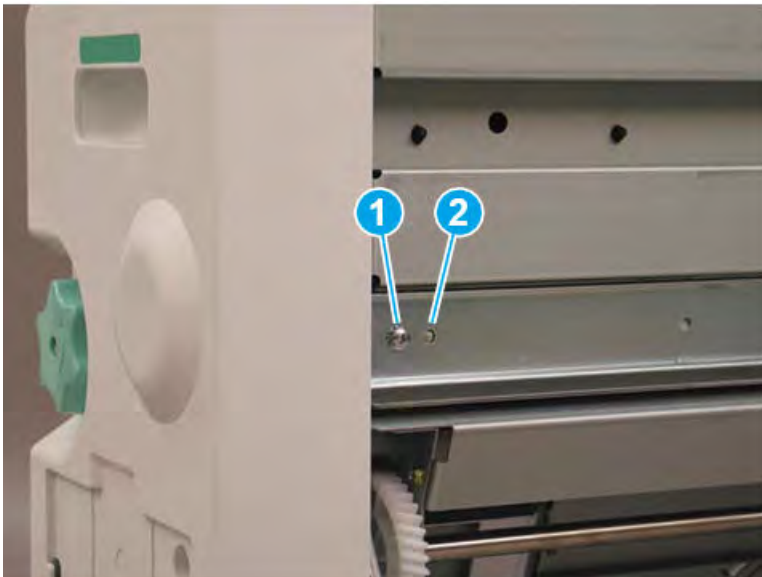
3. Release the metal bracket through the opening in the sheet metal.

Figure 5-1924 Release the metal bracket



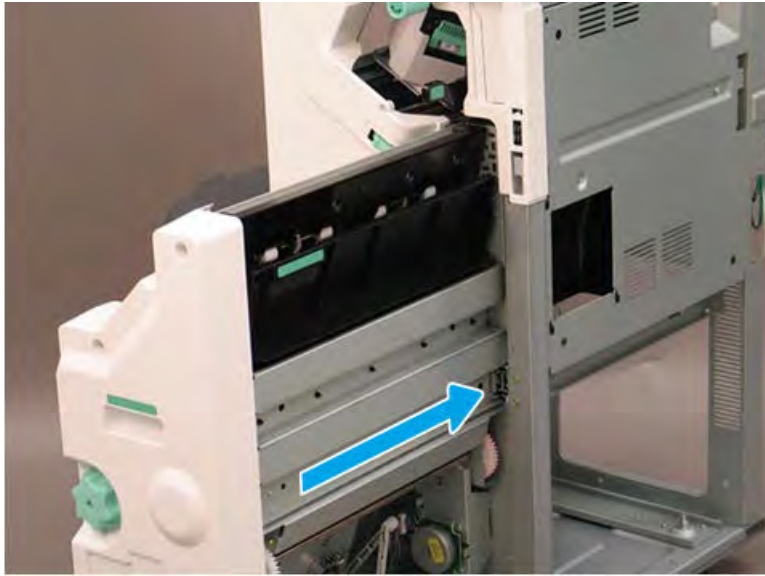
4. Remove one star-washer screw (callout 1), and then release the alignment pin (callout 2) on the right side of the booklet maker.

Figure 5-1925 Remove one screw



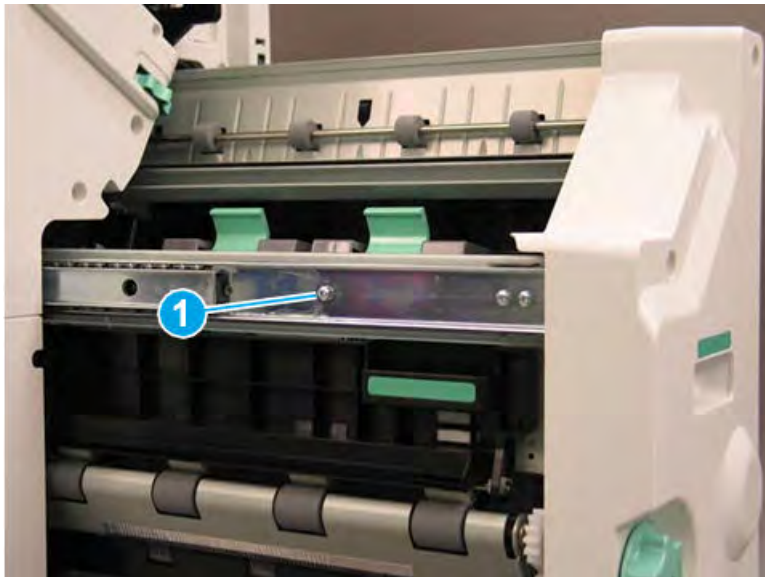
5. Slide the right rail toward the finisher.

Figure 5-1926 Slide the right rail



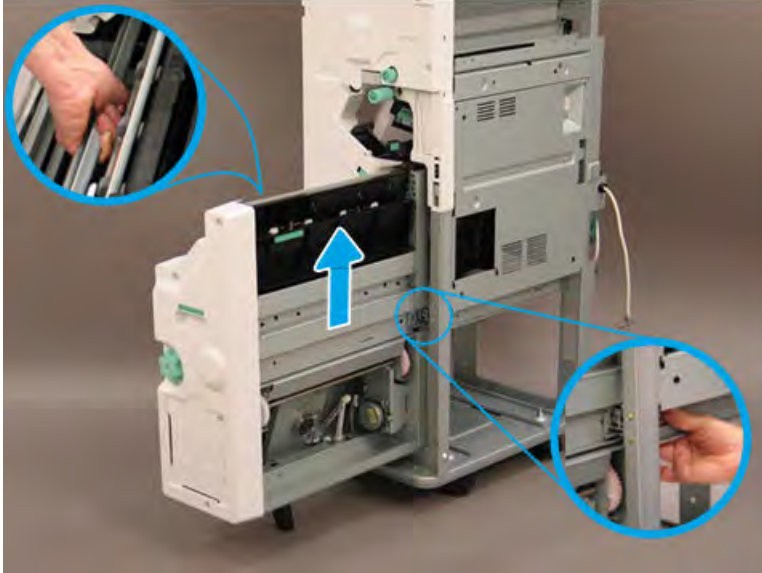
6. Remove one star-washer screw (callout 1) on the left side of the booklet maker.

Figure 5-1927 Remove one screw



7. Lift the booklet maker up on the left side while squeezing the right rail away from the finisher slightly to clear the sheet metal. Remove the booklet maker.

**Figure 5-1928** Remove the booklet maker



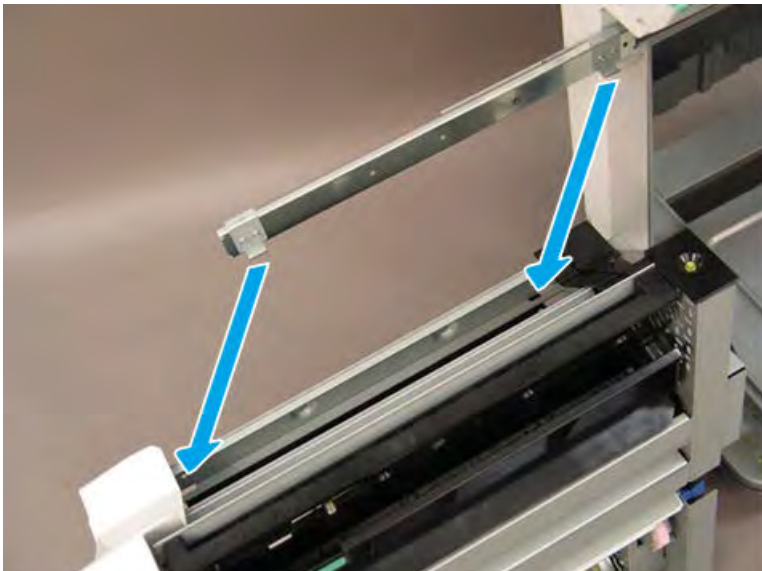
8. Reverse the removal steps to install the assembly. Also use the following special installation instructions.

 **NOTE:** Continue to reverse the removal steps to finish installing the assembly.

**Special installation instructions: booklet maker**

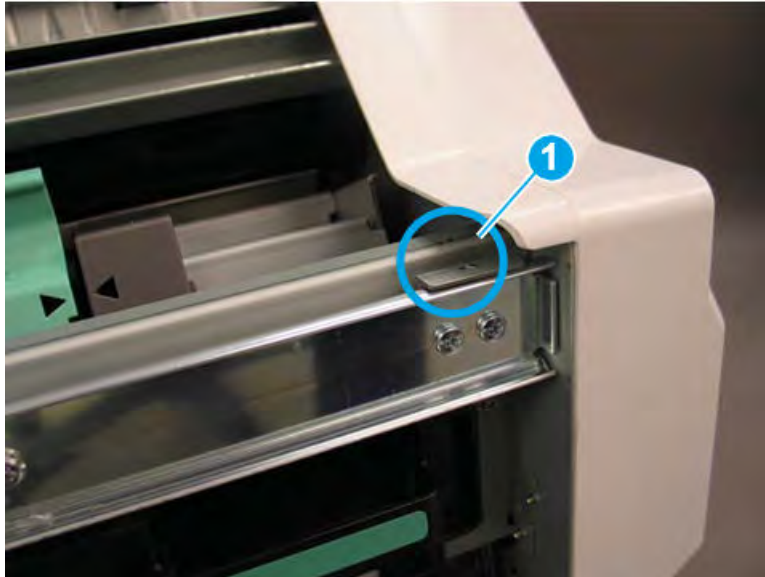
When installing the booklet maker, position the hooks on the rail under the slots on the booklet maker.

**Figure 5-1929** Position the hooks



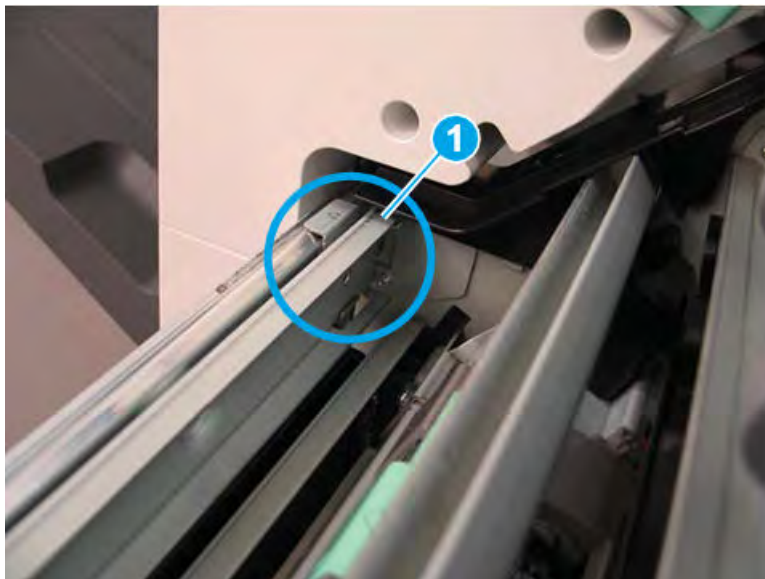
9. When installed correctly, the arrow on the front of the booklet maker aligns with the arrow on the finisher rail.

Figure 5-1930 Align arrows



10. When installed correctly, the arrow on the back of the booklet maker aligns with the arrow on the finisher rail.

Figure 5-1931 Align arrows



11. Extend the right rail away from the finisher and position it in the booklet maker slot.

Figure 5-1932 Extend the right rail

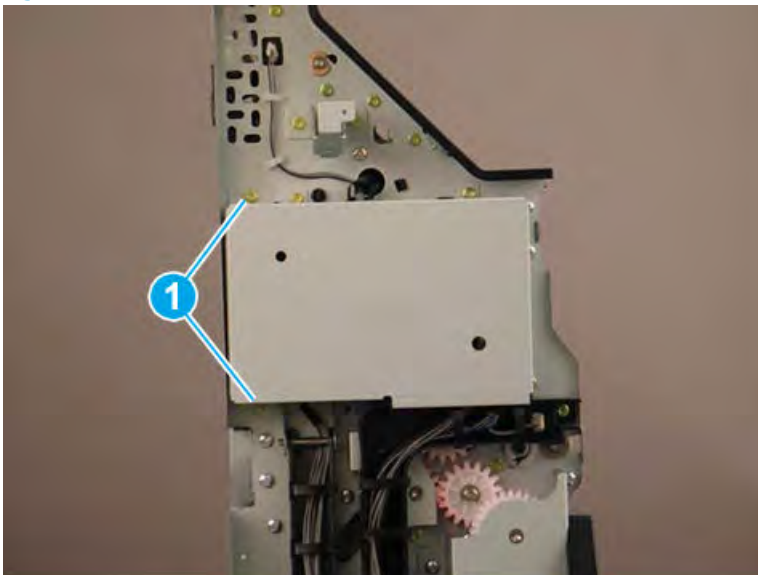


#### Remove the booklet maker PCA

Follow these steps to remove the booklet maker PCA.

1. Remove two screws (callout 1).

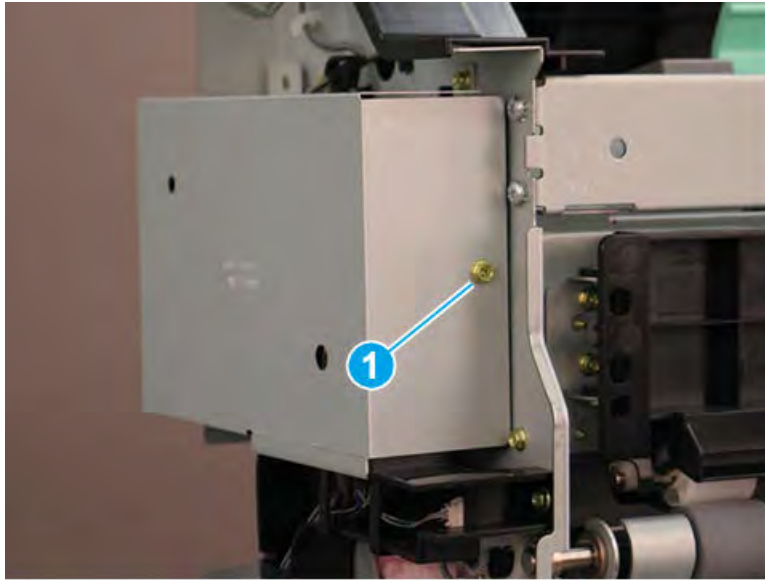
Figure 5-1933 Remove two screws





2. Remove one screw (callout 1), and then remove the metal cover.

Figure 5-1934 Remove one screw and the metal cover



3. Disconnect all of the connectors, remove four screws (callout 1), and then remove the booklet maker PCA.


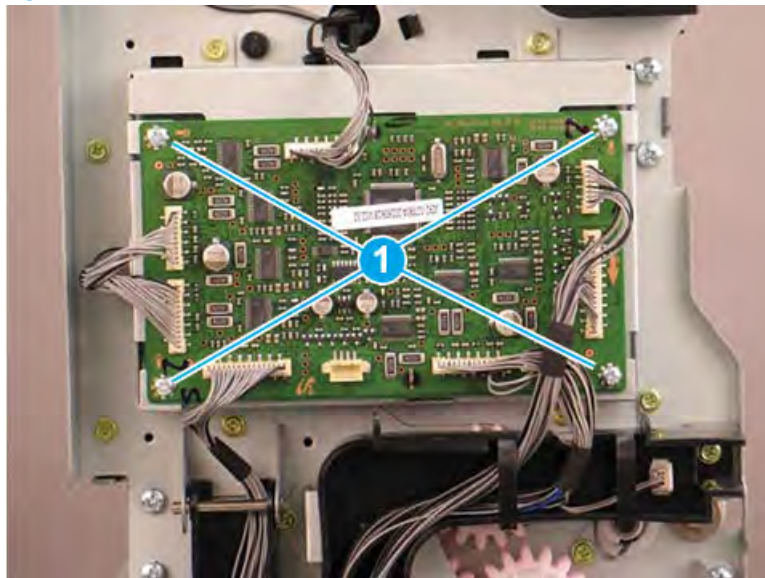
 **TIP:** Reverse the removal steps to install the assembly.

Figure 5-1935 Remove four screws and the PCA



### Unpack the replacement assembly

Follow these steps to unpack the replacement assembly.

1. Dispose of the defective part.

---

 **NOTE:** HP recommends responsible disposal of the defective part.

<http://www8.hp.com/us/en/hp-information/environment/product-recycling.html>

---

2. Unpack the replacement part from the packaging.


 **CAUTION:**  Some parts are sensitive to electrostatic discharge (ESD). Always perform service work at an ESD-protected workstation or mat. If an ESD workstation or mat is not available, touch the sheet-metal chassis to provide a static ground before touching an ESD-sensitive assembly. Protect the ESD-sensitive assemblies by placing them in ESD pouches when they are out of the printer.

 **IMPORTANT:** Make sure that all of the shipping materials (for example shipping tape) are removed from the replacement part prior to installation.

 **NOTE:** If the replacement part is a roller or pad, avoid touching the spongy part of it. Skin oils on the roller or pad can cause paper pickup and/or print-quality problems. HP recommends using disposable gloves when handling rollers or pads or washing your hands before touching rollers or pads.

---

3. To install an assembly, reverse the removal steps.

 **NOTE:** When applicable, special installation instructions are provided for an assembly at the end of the removal procedure. Always completely read the removal instructions and follow all special installation instructions.

---

## Problem solving

Learn about problem solving.

### Control panel message document (CPMD)

Learn about the control panel message document (CPMD).

Refer to [Error codes on page 760](#) for more details.

## Clear paper jams

Learn about clearing paper jams.

## Clear paper jams in the Booklet maker

Learn how to clear paper jams in the Booklet maker.

### Clear jams in the top output area

Learn how to clear jams in the top output area.

1. Open the top cover.



2. Lift the TF feeder, and then turn the knob while the TF feeder is lifted.

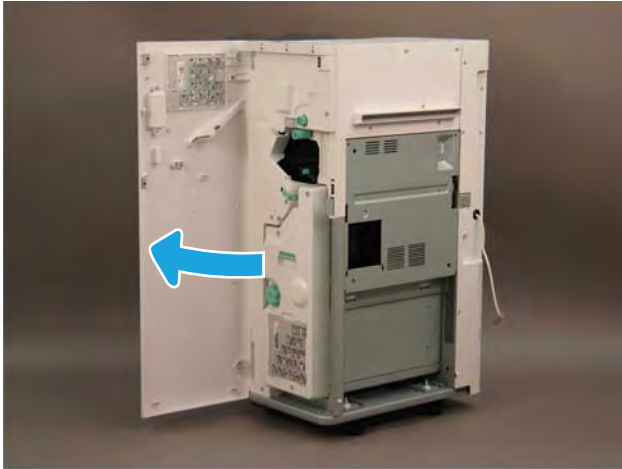


3. Remove any jammed paper.

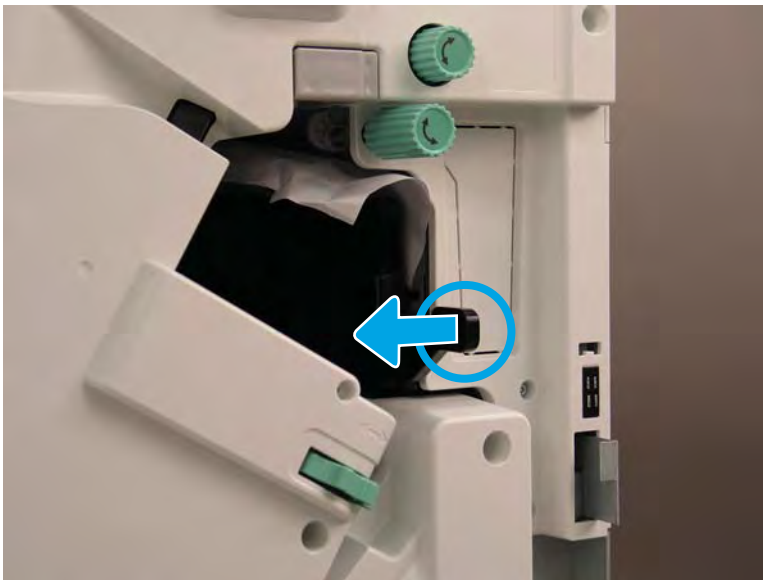
### Clear jams in the booklet maker paper path

Learn how to clear jams in the booklet maker paper path.

1. Open the booklet maker door.



2. Release the lever.



3. Turn the knob.



4. Remove the jammed paper.

#### Clear jams in the booklet maker booklet output area

Learn how to clear jams in the booklet maker booklet output area.

1. Open the booklet maker door.



2. Pull out the booklet maker assembly until it stops.



3. Turn the knob to advance the jammed paper.



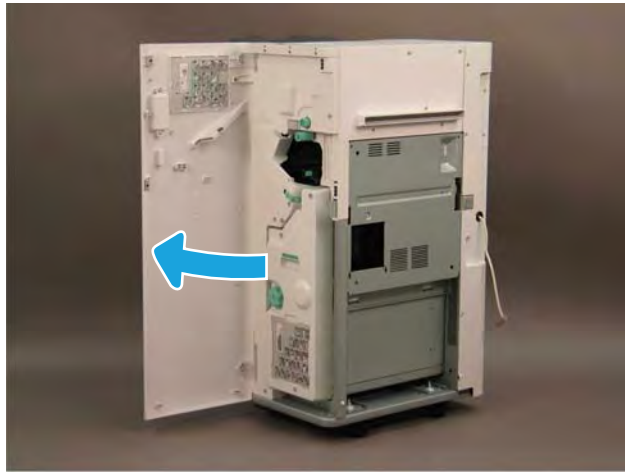
4. Remove the jammed paper/booklet from the output area.

#### Clear jams in the booklet maker assembly-right-upper area

Learn how to clear paper jams in the booklet maker assembly-right-upper-area.

1. Open the booklet maker door.

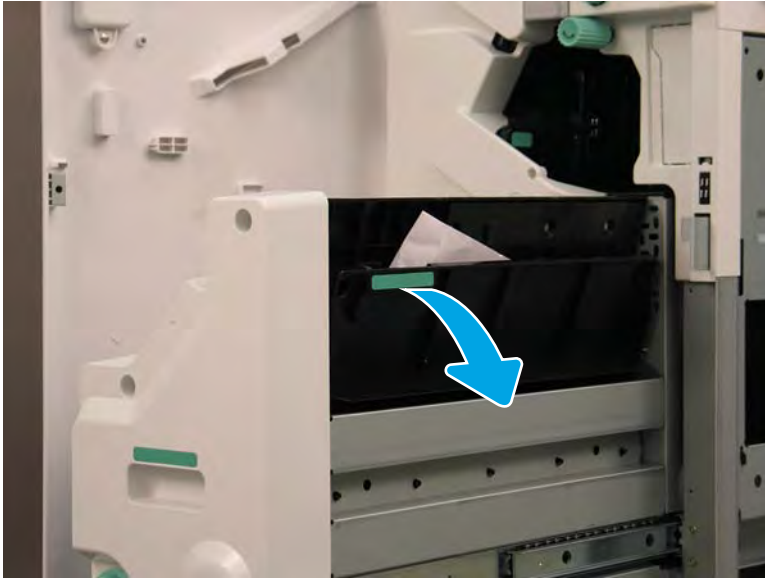




2. Pull out the booklet maker assembly until it stops.



3. Open the vertical tray by pulling outward on the green tab.

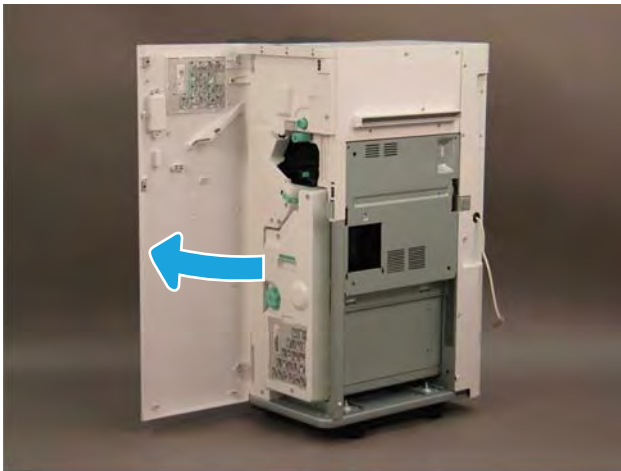


4. Remove the jammed paper.

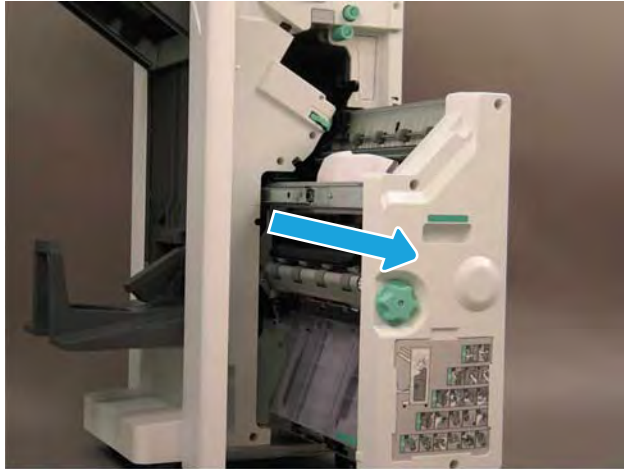
#### Clear jams in the booklet maker assembly left middle area

Learn how to clear jams in the booklet maker assembly left-middle-area.

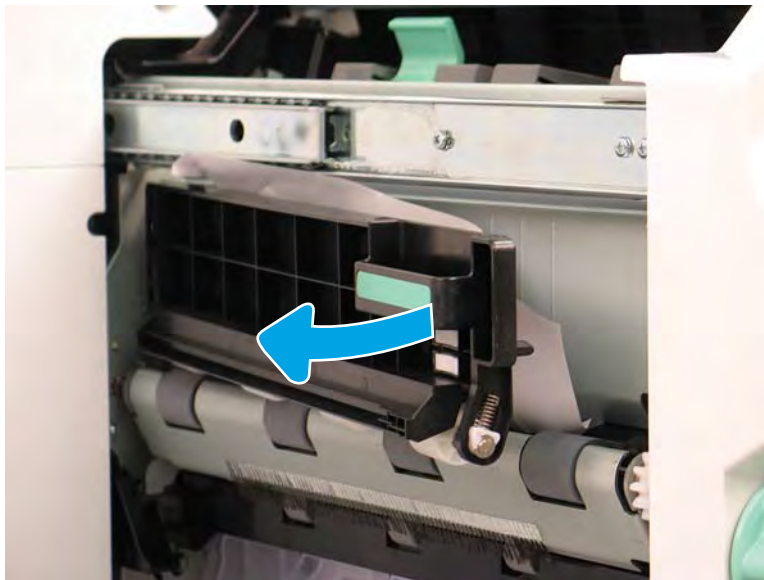
1. Open the booklet maker door.



2. Pull out the booklet maker assembly until it stops.



3. Pull the green tab.



4. Remove the jammed paper.

5. Open the clear plastic door at the left bottom.

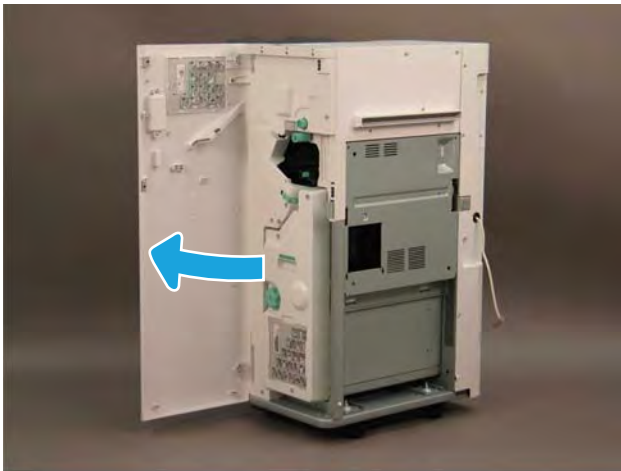


6. Remove the jammed paper.

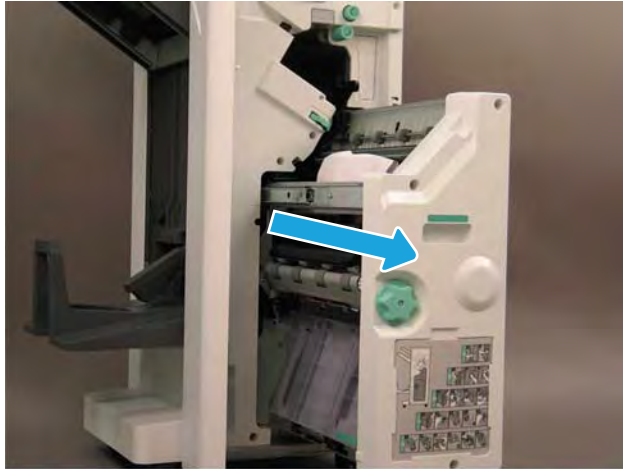
#### Clear jams in the booklet maker assembly left lower area

Learn how to clear jams in the booklet maker assembly left-lower area.

1. Open the booklet maker door.



2. Pull out the booklet maker assembly until it stops.



3. Open the roller door.
4. Remove the jammed paper.
5. Open the clear plastic door at the left bottom.



6. Remove the jammed paper.

### Clear jams in the IPTU

Learn how to clear jams in the IPTU.

1. Lift the IPTU cover and clear any jammed paper inside the IPTU.



2. Close the IPTU cover.

### Clear jams in the inner finisher (IF)

Learn how to clear jams in the inner finisher (IF).

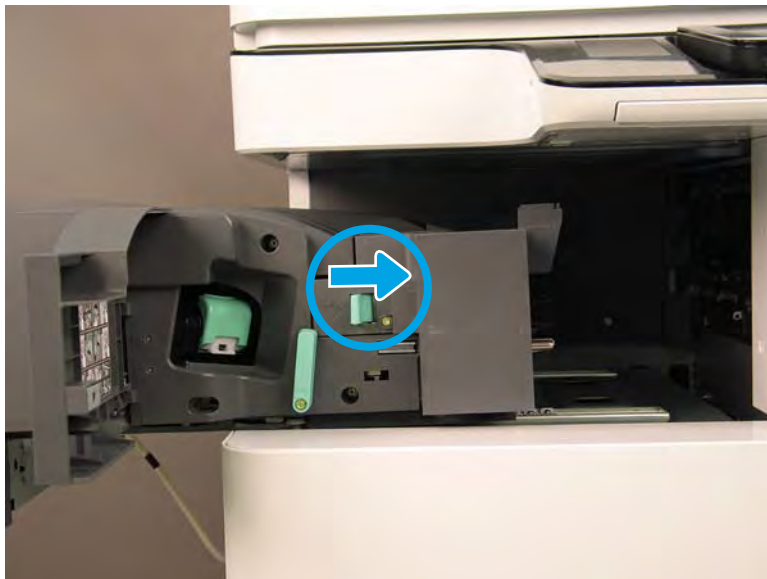
1. Open the staple cartridge access door.



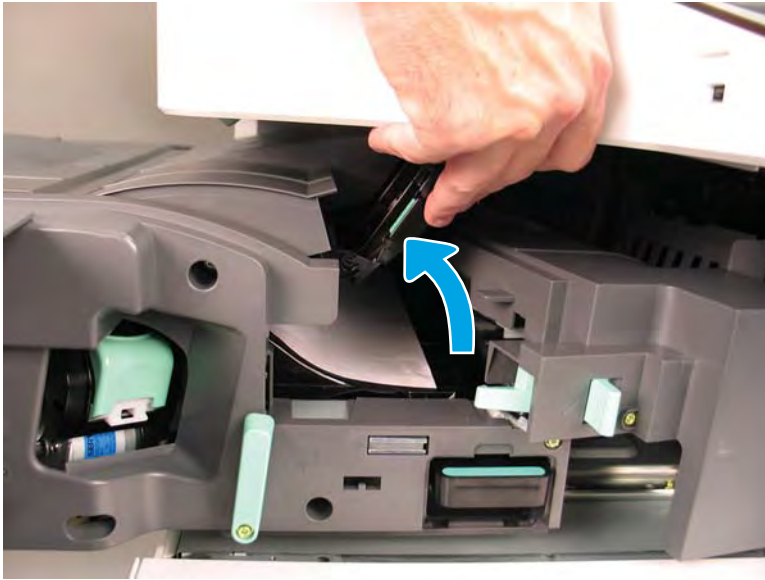
2. Rotate the lever to the left to release the hooks that secure the inner finisher (they hold the IF in place).



3. Slide the inner finisher partially out.
4. Release the lever to open the right cover on the inner finisher.



5. Lift the inner finisher jam access cover, and then remove any jammed paper inside the rear of the inner finisher.



6. Close the inner finisher jam access cover.
7. Close the inner finisher right cover.
8. Open the output side jam access cover, and then remove any jammed paper.



9. Close the output side jam access cover.
10. Slide the inner finisher in until it clicks into place.
11. Close the staple cartridge access door.

### Clear paper jams in the High-volume finisher

Learn how to clear paper jams in the High-volume finisher.



1. Open the top cover.



2. Lift the TF feeder, and then turn the knob while the TF feeder is lifted.



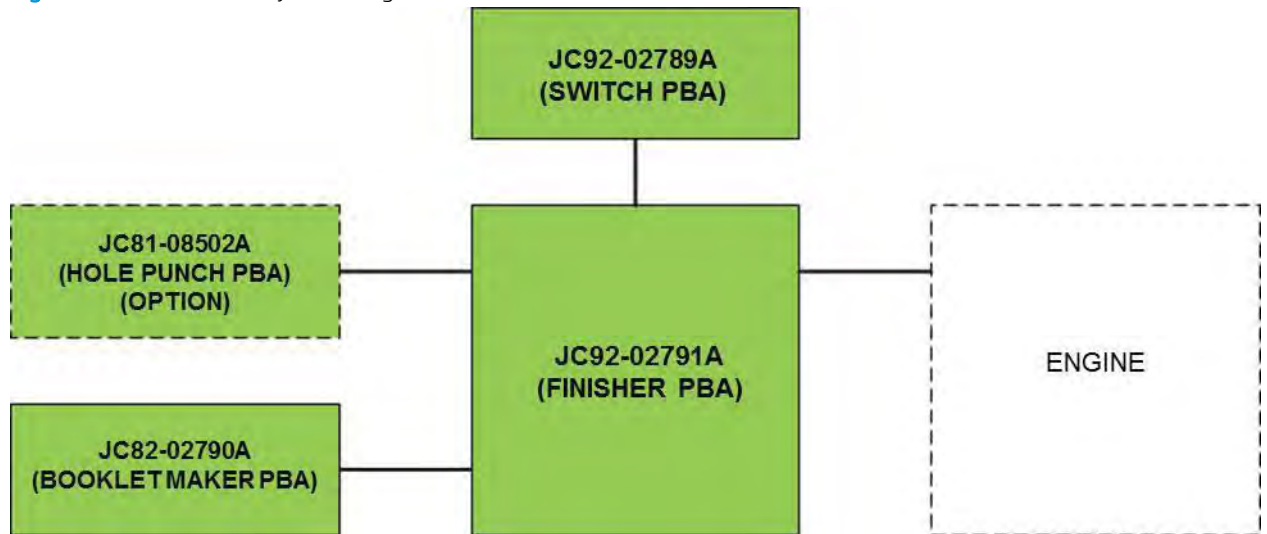
3. Remove any jammed paper.

## Finisher system diagram

Learn about the finisher system diagram.

Finisher system consists of the FINISHER PCA, BOOKLET MAKER PCA, SWITCH PCA, and HOLE PUNCH PCA.

Figure 5-1936 Finisher system diagram



#### PCA function

- **FINISHER PCA**  
This PCA controls the finisher modules and consists of the micro-controller and driver ICs.
- **SWITCH PCA**  
This PCA shows the manual stapling condition and accepts the button input for manual staple operation.
- **BOOKLET MAKER PCA**  
This PCA controls the booklet maker module and consists of the micro-controller and driver ICs.
- **HOLE PUNCH PCA**  
This PCA controls the hole punch module and consists of the micro-controller and driver ICs.

---

## 6 Inner finisher

Learn more about the inner finisher.

# Product specification and description

Learn about product specifications and descriptions.

## Inner finisher view

Learn about the front view and rear view of the inner finisher.

### Front & rear view

Figure 6-1 Inner finisher system - front view

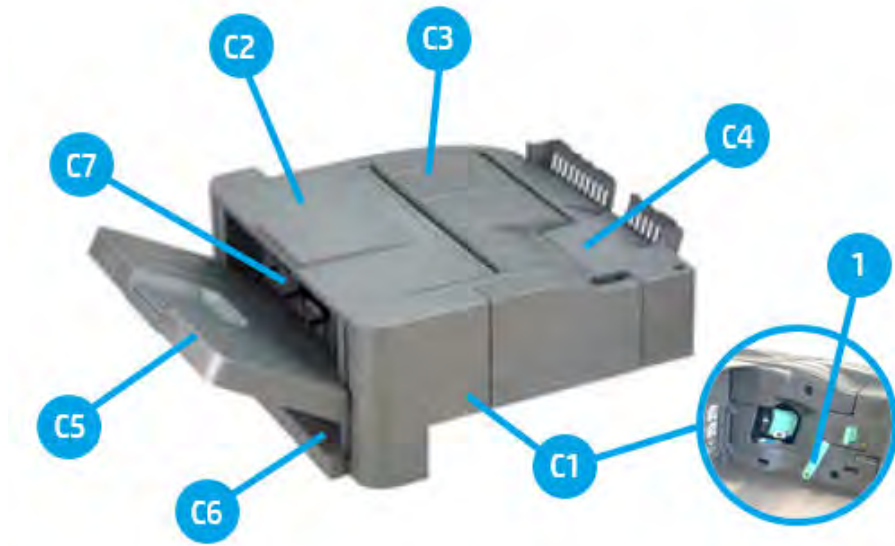


Figure 6-2 Inner finisher system - rear view



Table 6-1 Inner finisher system - entrance unit parts information

Item	Part name	Part number	Orderable <sup>(*)</sup>
C1	Front cover	JC90-01321B	(*)
C2	Top cover	JC90-01323B	(*)
C3	Middle cover	JC90-01322B	(*)
C4	Punch cover	JC90-01343B	(*)

**Table 6-1** Inner finisher system - entrance unit parts information (continued)

Item	Part name	Part number	Orderable <sup>(*)</sup>
C5	Output tray	JC90-01337B	(*)
C6	PCA cover	JC63-04792B	(*)
C7	Left cover	JC90-01324B	(*)
C8	Rear cover	JC63-04750B	(*)
1	Lock release handle	JC66-04233A	(*)
2	Main interface harness	JC39-02169A	(*)
Not shown	Exit bin full	JC90-01546A	(*)

(\*) This part is in ordering system.

 **NOTE:** Exit bin full is included in the box



## Specification

Learn about the specifications of the inner finisher.

**Table 6-2** General specifications

Item	Description
Capacity	550 Sheets (Main 500, Top 50) @ 80gsm
Sensing	Paper Jam/Tray Sensing/Stapler/Cover Open
Media Sizes	<ul style="list-style-type: none"> <li>Main: 98mm - 320mm x 139.7mm - 457.2mm (3.86in - 12.59in x 5.5in - 18in)</li> <li>Top: 98mm - 320mm x 148.0mm - 430.0mm(3.86in - 12.59in x 5.83in - 16.93in)</li> </ul>
Media types	Plain/Thick/Heavy weight/Thin/Cotton/Colored/Recycled/Bond/Archive/Pre-Punched/Cardstock/Glossy/Envelope
Media Weight	<ul style="list-style-type: none"> <li>Main: 52-256 gsm (13.9-68.3 lb.)</li> <li>Top: 52-325 gsm (13.9-86.7 lb.)</li> </ul>
Number of Bin	2 (Main/Top)
Dimension (W X D X H)	458 x 491 x 173 mm (18.0 X 19.3 X 6.8 inch)
Weight	15 kg (33 lb.)
Tray1 Finishing Capacity	50 Sheets @ 80gsm

**Table 6-2 General specifications (continued)**

Item	Description
Tray1 Finishing Mode	Stapling (Left, Right, Center)/Punch (2/3, 2/4, Swedish)
Tray2 Finishing Capacity	500 Sheets @ 80 gsm

**Table 6-3 Paper Size Specification**

Name	Paper size		Orientation n	Output			Staple position		
	mm	Inches		Direction	Main tray		Top tray	Corner	
			52-256 g		Offset	52-325 g	45°	Flat	
A5	210 x 148	8.3 x 5.8	LEF	0	0	0	X	F/R <sup>1</sup>	0
Statement	216 x 140	8.5 x 5.5	LEF	0	0	0	X	F/R <sup>1</sup>	0
Lt	279 x 216	11 x 8.5	LEF	0	0	0	F/R <sup>1</sup>	X	0
A4	297 x 210	8.3 x 11.7	LEF	0	0	0	F/R <sup>1</sup>	X	0
B5(JIS)	257 x 182	10.1 x 7.2	LEF	0	0	0	F/R <sup>1</sup>	X	0
B5(ISO)	250 x 176	9.8 x 6.9	LEF	0	0	0	F/R <sup>1</sup>	X	0
Executive	267 x 184	10.5 x 7.3	LEF	0	0	0	F/R <sup>1</sup>	X	0
No 9 Env	98 x 225	3.9 x 8.9	SEF	X	X	0	X	X	X
Monarch Env	98.4 x 190.5	3.9 x 7.5	SEF	X	X	0	X	X	X
PostCard 4X6	101.6 x 152.4	4.0 x 6.0	SEF	X	X	0	X	X	X
A6	105 x 148	4.1 x 5.8	SEF	X	X	0	X	X	X
No 10 Env	105 x 241	4.1 x 9.5	SEF	X	X	0	X	X	X
DL Env	110 x 220	4.3 x 8.7	SEF	X	X	0	X	X	X
C6 Env	114 x 162	4.5 x 6.4	SEF	X	X	0	X	X	X
B6	128 x 182	5.0 x 7.2	SEF	X	X	0	X	X	X
Statement	140 x 216	5.5 x 8.5	SEF	X	X	0	X	X	X
A5	148 x 210	5.8 x 8.3	SEF	0	X	0	X	X	X
C5 Env	162 x 229	6.4 x 9.0	SEF	X	X	0	X	X	X
B5(ISO)	176 x 250	6.9 x 9.8	SEF	0	0	0	X	F/R <sup>1</sup>	X
B5(JIS)	182 x 257	6.9 x 9.8	SEF	0	0	0	X	F/R <sup>1</sup>	X
Executive	184 x 267	7.3 x 10.5	SEF	0	0	0	X	F/R <sup>1</sup>	X
16k	195 x 270	7.7 x 10.6	SEF	0	0	0	X	F/R <sup>1</sup>	0
A4	210 x 297	8.3 x 11.7	SEF	0	0	0	X	F/R <sup>1</sup>	0
Legal	216 x 356	8.5 x 14	SEF	0	0	0	X	F/R <sup>1</sup>	0

**Table 6-3 Paper Size Specification (continued)**

Name	Paper size		Orientation	Output			Staple position		
	mm	Inches		Direction	Main tray		Top tray	Corner	
			52-256 g		Offset	52-325 g	45°	Flat	
Letter	216 x 279	8.5 x 11	SEF	0	0	0	X	F/R <sup>1</sup>	0
Folio	216 x 330	8.5 x 13	SEF	0	0	0	X	F/R <sup>1</sup>	0
Oficio	215.9 x 342.9	8.5 x 13.5	SEF	0	0	0	X	F/R <sup>1</sup>	0
C4	229 x 324	9.1 x 12.8	SEF	X	X	0	X	X	X
Tabloid	254 x 374	10 x 14.7	SEF	0	0	0	F/R <sup>1</sup>	X	0
B4	257 x 364	10 x 14.3	SEF	0	0	0	F/R <sup>1</sup>	X	0
8K	270 x 390	10.6 x 15.4	SEF	0	0	0	F/R <sup>1</sup>	X	0
Ledger	279 x 432	11 x 17	SEF	0	0	0	F/R <sup>1</sup>	X	0
A3	297 x 420	11.7 x 16.5	SEF	0	0	0	F/R <sup>1</sup>	X	0
Tabloid Extra	304.8 x 457.2	12 x 18	SEF	0	X	X	X	X	X
SRA3	320 x 450	12.6 x 17.7	SEF	0	0	X	X	X	X
Custom	W 98-320 ~ L 139.7-457. 2	W3.86-12. 59 ~ L 5.5-18	—	0	X	0	X	X	X

<sup>1</sup> "F/R" means front side and rear side can be supported.

**Table 6-4 Punch specifications**

Name	Paper size		Orientation	Punch				
	mm	Inches		Direction	NA 2/3		EU 2/4H	
			2H		3H	2H	4H	4H
A5	210 x 148	8.3 x 5.8	LEF	0	X	0	X	0
Statement	216 x 140	8.5 x 5.5	LEF	0	X	0	X	0
Lt	279 x 216	11 x 8.5	LEF	0	0	0	0	0
A4	297 x 210	8.3 x 11.7	LEF	0	0	0	0	0
B5 (JIS)	257 x 182	10.1 x 7.2	LEF	0	0	0	X	0
B5 (ISO)	250 x 176	9.8 x 6.9	LEF	0	0	0	X	0
Executive	267 x 184	10.5 x 7.3	LEF	0	0	0	0	0
No 9 Env	98 x 225	3.9 x 8.9	SEF	X	X	X	X	X
Monarch Env	98.4 x 190.5	3.9 x 7.5	SEF	X	X	X	X	X

**Table 6-4** Punch specifications (continued)

Name	Paper size		Orientation	Punch				
	mm	Inches		Direction	NA 2/3		EU 2/4H	
			2H		3H	2H	4H	4H
PostCard 4X6	101.6 x 152.4	4.0 x 6.0	SEF	X	X	X	X	X
A6	105 x 148	4.1 x 5.8	SEF	X	X	X	X	X
No 10 Env	105 x 241	4.1 x 9.5	SEF	X	X	X	X	X
DL Env	110 x 220	4.3 x 8.7	SEF	X	X	X	X	X
C6 Env	114 x 162	4.5 x 6.4	SEF	X	X	X	X	X
B6	128 x 182	5.0 x 7.2	SEF	X	X	X	X	X
Statement	140 x 216	5.5 x 8.5	SEF	X	X	X	X	X
A5	148 x 210	5.8 x 8.3	SEF	0	X	0	X	0
C5 Env	162 x 229	6.4 x 9.0	SEF	X	X	X	X	X
B5(ISO)	176 x 250	6.9 x 9.8	SEF	0	X	0	X	0
B5(JIS)	182 x 257	6.9 x 9.8	SEF	0	X	0	X	0
Executive	184 x 267	7.3 x 10.5	SEF	0	X	0	X	0
16k	195 x 270	7.7 x 10.6	SEF	0	X	0	X	0
A4	210 x 297	8.3 x 11.7	SEF	0	X	0	X	0
Legal	216 x 356	8.5 x 14	SEF	0	X	0	X	0
Letter	216 x 279	8.5 x 11	SEF	0	X	0	X	0
Folio	216 x 330	8.5 x 13	SEF	0	X	0	X	0
Oficio	215.9 x 342.9	8.5 x 13.5	SEF	0	X	0	X	0
C4	229 x 324	9.1 x 12.8	SEF	X	X	X	X	X
Tabloid	254 x 374	10 x 14.7	SEF	0	0	0	X	0
B4	257 x 364	10 x 14.3	SEF	0	0	0	X	0
8K	270 x 390	10.6 x 15.4	SEF	0		0	0	0
Ledger	279 x 432	11 x 17	SEF	0	0	0	0	0
A3	297 x 420	11.7 x 16.5	SEF	0	0	0	0	0
Tabloid Extra	304.8 x 457.2	12 x 18	SEF	X	X	X	X	X
SRA3	320 x 450	12.6 x 17.7	SEF	X	X	X	X	X
Custom	W 98-320 ~ L 140-1200	W3.9-12.6 ~ L 5.5-47	-	X	X	X	X	X



**Table 6-5 Media performance**

Paper Type	Function			
	Main Tray	Top Tray	Staple	Punch
Plain (71-90 g/m <sup>2</sup> )	0	0	0	0
Thick (91-105 g/m <sup>2</sup> )	0	0	0	0
Heavy weight (106-175 g/m <sup>2</sup> )	0	0	0	0
Extra Heavy weight 1 (176-216 g/m <sup>2</sup> )	0	0	0	0
Extra Heavy weight 2 (217-256 g/m <sup>2</sup> )	0	0	0	0
Extra Heavy weight 3 (257-300 g/m <sup>2</sup> )	X	0	X	X
Extra Heavy weight 4 (301-325 g/m <sup>2</sup> )	X	0	X	X
Thin (60-70 g/m <sup>2</sup> )	0	0	0	0
Cotton (75-90 g/m <sup>2</sup> )	0	0	0	0
Colored (75-90 g/m <sup>2</sup> )	0	0	0	0
Pre-Printed (75-90 g/m <sup>2</sup> )	0	0	0	0
Recycled (60-90 g/m <sup>2</sup> )	0	0	0	0
Bond	0	0	0	0
Archive (75-105 g/m <sup>2</sup> )	0	0	0	0
LetterHead	0	0	0	0
Pre-Punched	0	0	0	X
Thin Cardstock (105-163 g/m <sup>2</sup> )	0	0	0	0
Thick Cardstock (170-216 g/m <sup>2</sup> )	0	0	0	X
Heavy Cardstock (217-256 g/m <sup>2</sup> )	0	0	0	X
Extra Heavy Cardstock 1(257-300 g/m <sup>2</sup> )	X	0	X	X
Extra Heavy Cardstock 2(301-325 g/m <sup>2</sup> )	X	0	X	X
Thin Glossy (106-169 g/m <sup>2</sup> )	0	0	0	0
Thick Glossy (170-216 g/m <sup>2</sup> )	0	0	0	X
Heavy Glossy (217-256 g/m <sup>2</sup> )	0	X	X	X
Envelope (75-90 g/m <sup>2</sup> )	X	0	X	X
Thick Envelope (217-256 g/m <sup>2</sup> )	0	X	X	X
Tab	0	X	X	0
Perforated Paper (75-90 g/m <sup>2</sup> )	X	0	X	X

## Inner finisher system

Learn about the inner finisher system.

### Overview

Learn about the overview of the inner finisher.

### Work flow

Figure 6-3 Inner finisher system - work flow overview

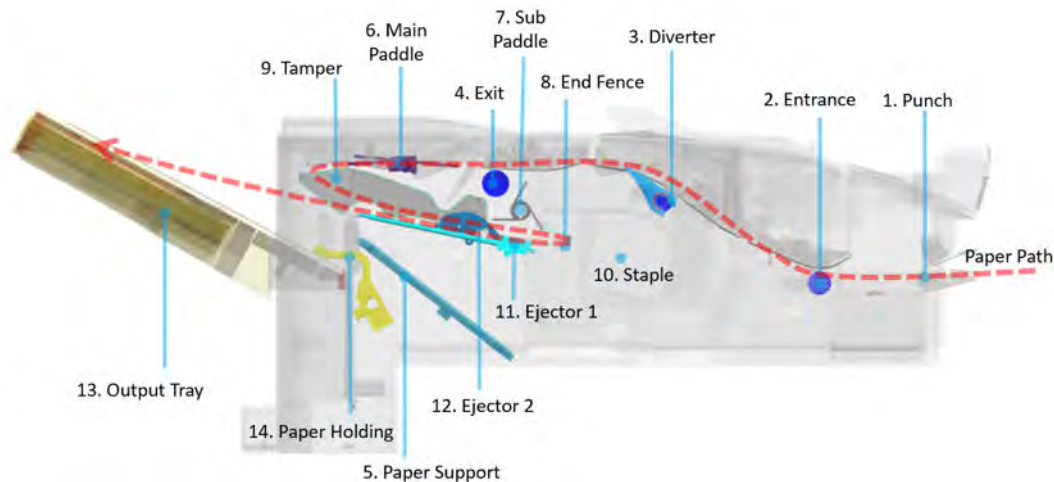


Table 6-6 Inner finisher system - work flow overview

Item	Unit	Description
1	Punch unit	holes in a specific location on a sheet of paper
2	Entrance unit	allows paper to move into the finisher
3	Diverter unit	holds paper so that the newly printed paper can stay out for seconds while the stapled bundle of paper moves to the output tray
4	Exit unit	moves paper from the diverter unit to the ejector unit
5	Paper support unit	prevents paper from being fallen down or bent when the long length paper such as A3 is ejected from the exit unit
6	Main paddle unit	moves paper to the sub paddle
7	Sub paddle unit	moves paper to the end fence
8	End fence unit	sets the standard position of the paper to be aligned towards top and bottom of the paper
9	Tamper unit	aligns the paper on the right and left side of the paper
10	Stapler unit	performs stapling to a bundle of aligned documents
11	Ejector 1 unit	transfers a stapled paper loaded at the end fence unit to the ejector2 unit
12	Ejector 2 unit	grips a stack of paper up and ejects it onto the output tray
13	Output tray unit	stacks the job ended paper
14	Paper holding unit	controls the output tray movement

## Sensor

Figure 6-4 Inner finisher system - sensor

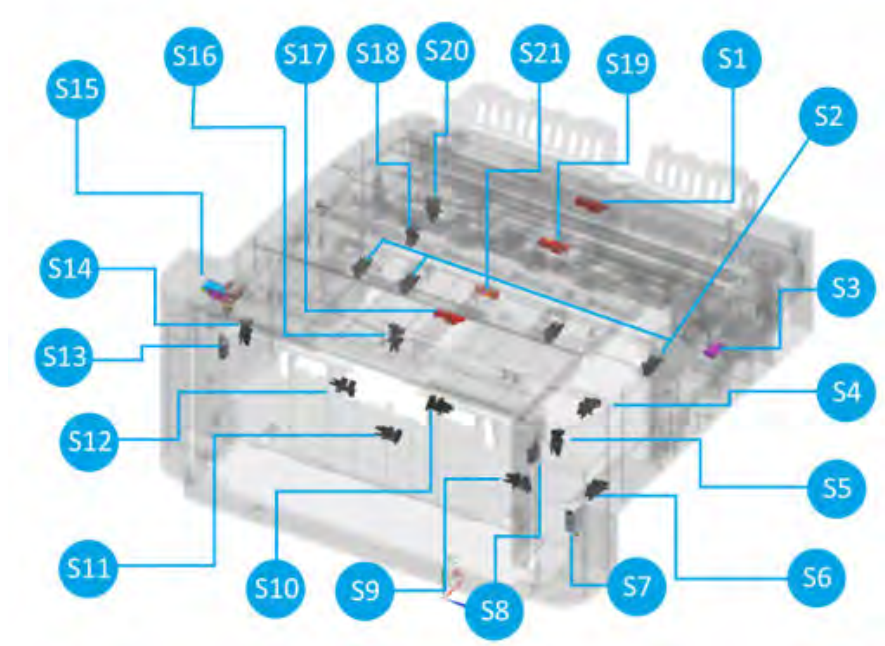


Table 6-7 Inner finisher system - sensor

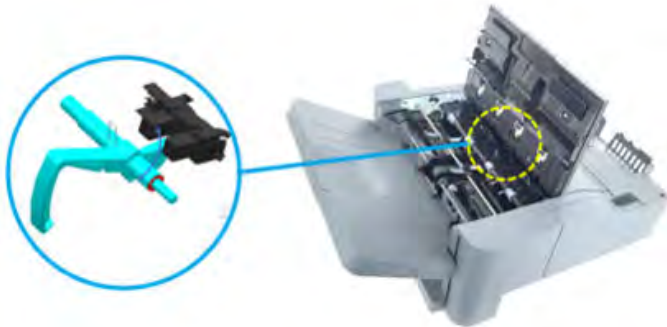
No	Name	Part number	Orderable <sup>(*)</sup>	Diagnostics	Type	Description
S1	Entrance sensor	0604-001381	(*)	113-0350	Photo emitter, detector	Checks paper comes into the entrance unit
S2	Stapler position sensor	0604-001393		113-0491 113-0492	Photo interrupter	Makes the stapler be positioned in the exact stapling position
S3	Front cover switch	JC39-01610A		113-0410	Cover open switch	Checks whether the front cover is closed or opened
S4	Main paddle home sensor	0604-001393		113-0370	Photo interrupter	Checks the main paddle locates at the home position
S5	Front tamper home sensor	0604-001393		113-0390	Photo interrupter	Checks the front tamper locates at the home position
S6	Output tray motor sensor	0604-001393		113-0473	Photo interrupter	Checks the output tray motor is operational
S7	Output tray lower limit switch	JC90-01320A	(*)	113-0472	Lower limit switch assembly	Checks the lower limit (=Output tray is full) of the output tray
S8	Output tray top of stack sensor (receiver)	0603-001309	(*)	113-0471	Photo TR	Checks the upper limit of output tray
S9	Paper holding sensor	0604-001393		113-0470	Photo interrupter	Checks the location of the paper holding actuator
S10	Ejector 2 home sensor	0604-001393		113-0462	Photo interrupter	Checks the ejector 2 locates at the home position.
S11	Ejector 2 motor sensor	0604-001393		113-0463	Photo interrupter	Checks the ejector 2 motor is operational

**Table 6-7** Inner finisher system - sensor (continued)

No	Name	Part number	Orderable <sup>(*)</sup>	Diagnostics	Type	Description
S12	Paper support home sensor	0604-001393		113-0481	Photo interrupter	Checks the paper support locates at the home position
S13	Output tray top of stack sensor (led)	0601-003440		113-0471	LED IR	Checks the upper limit of output tray
S14	Rear tamper home sensor	0604-001393		113-0380	Photo interrupter	Checks the rear tamper locates at the home position
S15	Top cover switch	JC39-01610A	(*)	113-0420	Cover open switch	Checks whether the top cover is closed or opened
S16	Ejector 1 home sensor	0604-001393		113-0461	Photo interrupter	Checks the ejector 1 locates at the home position
S17	End fence sensor	0604-001381	(*)	113-0361	Photo emitter, detector	Check paper comes into the end fence unit
S18	Punch waste box sensor	0604-001393		113-0620	Photo interrupter	Detects the punch waste box is installed
S19	Punch waste full sensor	0604-001381	(*)	113-0621	Photo emitter, detector	Checks the punch waste box is full
S20	Finisher docking sensor	0604-001393		113-0000	Photo interrupter	Checks the finisher is installed
S21	Exit sensor	0604-001415	(*)	113-0360	Photo interrupter	Checks paper comes into the exit unit

<sup>(\*)</sup> This part is in ordering system.

**Figure 6-5** Inner finisher system - Photo interrupter (0604-001393)



**Figure 6-6** Inner finisher system - Photo emitter, detector (0604-001381)



## Motor and solenoid

Figure 6-7 Inner finisher system - motor, solenoid

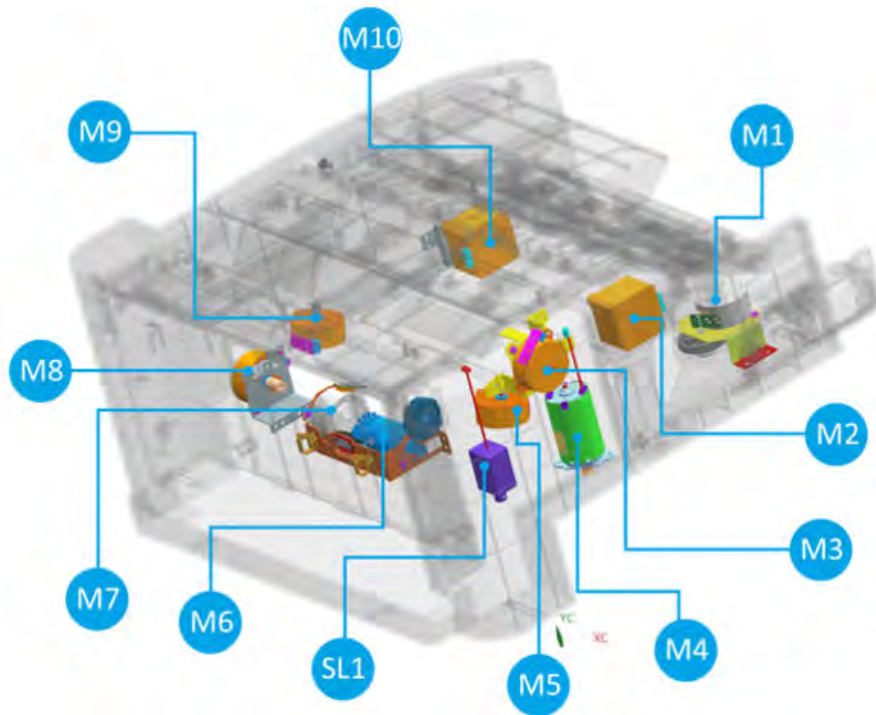


Table 6-8 Inner finisher system - motor, solenoid

No	Name	Part number	Orderable <sup>(*)</sup>	Diagnostics	Type	Motor sensor	Description
M1	Stapler position motor	JC93-00999A	(*)	113-0581	Step motor		Drives the stapler unit
M2	Exit motor	JC31-00169B	(*)	113-0502	Step motor		Drives the exit roller and the sub paddle unit
M3	Main paddle motor assembly	JC93-01001A	(*)	113-0510	Step motor	Home	Drives the main paddle unit
M4	Output tray motor assembly	JC90-01334B	(*)	113-0570	DC Motor	Encoder	Drives the output tray unit
M5	Rear tamper motor assembly	JC93-01001A	(*)	113-0520	Step motor	Home	Drives the rear tamper unit
M6	Ejector2 motor assembly	JC93-01168A		113-0562	DC Motor	Home, encoder	Drives the ejector 2 unit
M7	Ejector1 motor assembly	JC93-00998A		113-0561	Step Motor	Home	Drives the ejector 1 unit
M8	Paper support motor assembly	JC93-00802B		113-0571	Step Motor	Home	Drives paper support unit

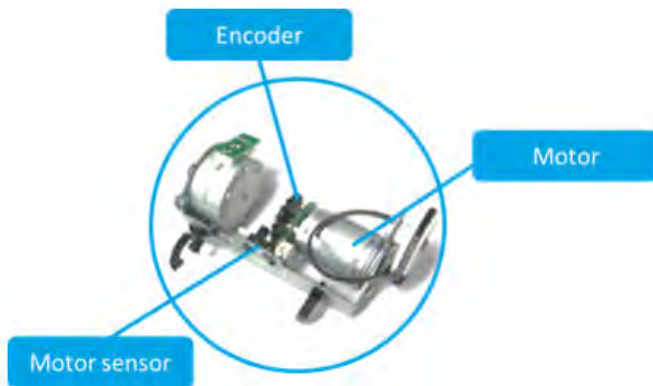
**Table 6-8** Inner finisher system - motor, solenoid (continued)

No	Name	Part number	Orderable <sup>(*)</sup>	Diagnostics	Type	Motor sensor	Description
M9	Front tamper motor assembly	JC93-01001A	(*)	113-0530	Step Motor	Home	Drives the front tamper unit
M10	Entrance motor assembly	JC90-01344A	(*)	113-0501	Step Motor		Drives the entrance roller and the middle roller
SL1	Paper holding solenoid	JC33-00037A	(*)	113-0591	Solenoid		Drives paper holding unit

<sup>(\*)</sup> This part is in ordering system.

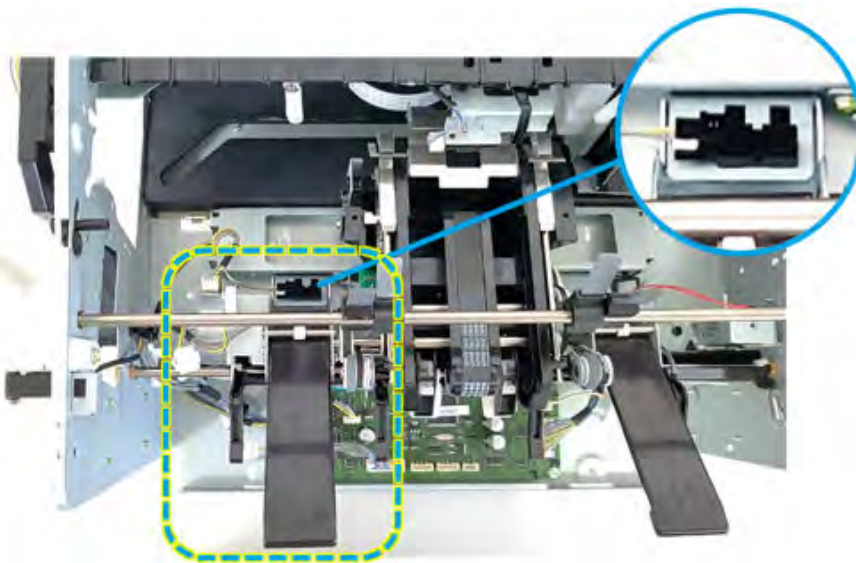
The sensor mounted at the driving motor detects motor operation. If a motor doesn't work properly, an event code only for the motor will pop up.

**Figure 6-8** Inner finisher system - motor sensor



The home position sensor is installed for the purpose of checking the reference point when the specific unit is operating.

**Figure 6-9** Inner finisher system - home sensor



## Roller

Figure 6-10 Inner finisher system - roller

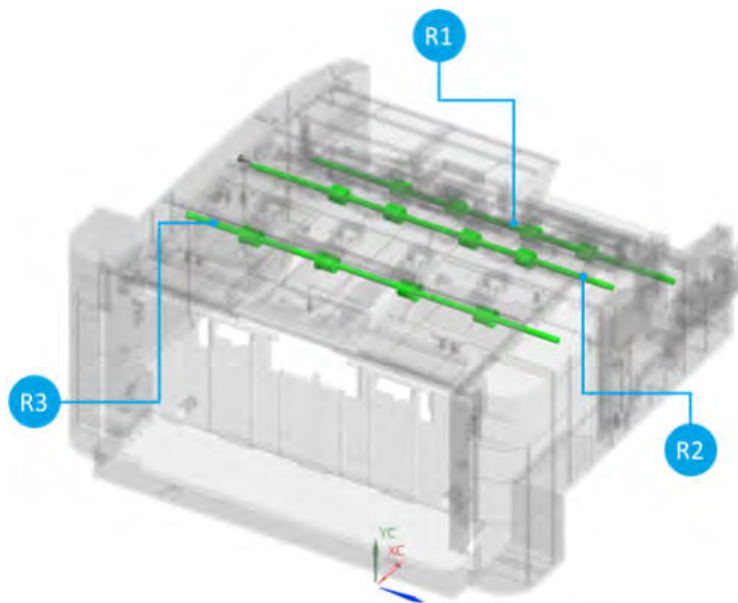


Table 6-9 Inner finisher system - roller

No	Name	Part number	Orderable <sup>(*)</sup>	Diagnostics	Type	Description
R1	Entrance roller	JC66-04243A	(*)		Roller	Moves paper forward
R2	Middle roller	JC66-04243A	(*)		Roller	Moves paper forward
R3	Exit roller	JC66-04244A	(*)		Roller	Moves paper forward

<sup>(\*)</sup> This part is in ordering system.

Figure 6-11 Inner finisher system - PCA

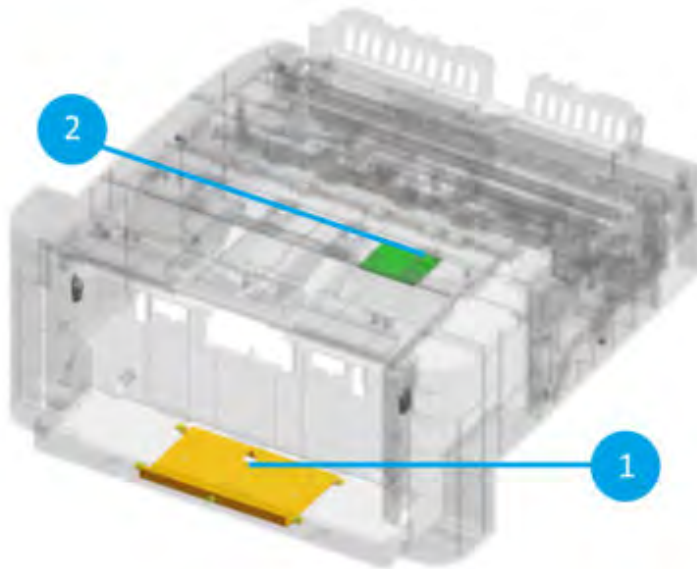


Table 6-10 Inner finisher system - roller

No	Name	Part number	Orderable <sup>(*)</sup>	Diagnostics	Type	Description
1	Main PCA	JC92-02774B	(*)			
2	Rear joint PCA	JC92-02780A	(*)			Joint PCA between main PCA and several parts punch, stapler, entrance, and front door

(\*) This part is in ordering system.

## Punch unit (optional)

Learn about the punch unit of the inner finisher.

The punch unit is a device that punches holes in a specific location on a sheet of paper. The punch unit is located immediately before the entrance unit and punches holes onto a paper.

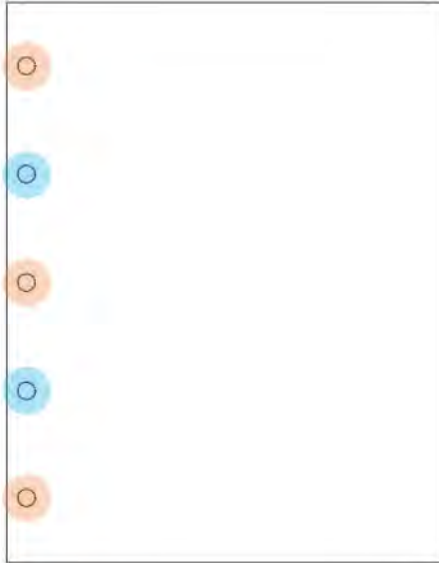
- HP LaserJet Inner Finisher Hole2/3 Punch : Y1G02-67901
- HP LaserJet Inner Finisher Hole2/4 Punch : Y1G03-67901
- HP LaserJet Inner Finisher Swedish Punch : Y1G04-67901

 **NOTE:** Puncher types vary depending on the country/region.

In case of 2/3 hole punch, the 5 hole-punches are mounted in the punch unit. As the punch motor rotates clockwise, the inner gear moves to the right and the 3 hole-punches are moved downward to make holes. When making 2 holes, the motor rotates in the counterclockwise direction and the inner gear rotates to the left to drill two holes. The travel distance and position of the motor are detected and controlled by the hole punch home sensor and the hole punch motor sensor.



**Figure 6-12** Inner finisher system - punched hole location and pair



For more information, go to the HP WISE support portal and search for *HP LaserJet Managed MFP - How to use the hole punch* (c05450959).

**Figure 6-13** Inner finisher system - punch unit overview

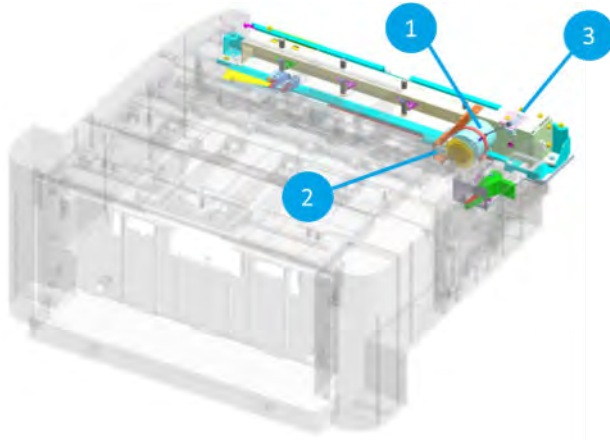


Figure 6-14 Inner finisher system - punch unit detail view

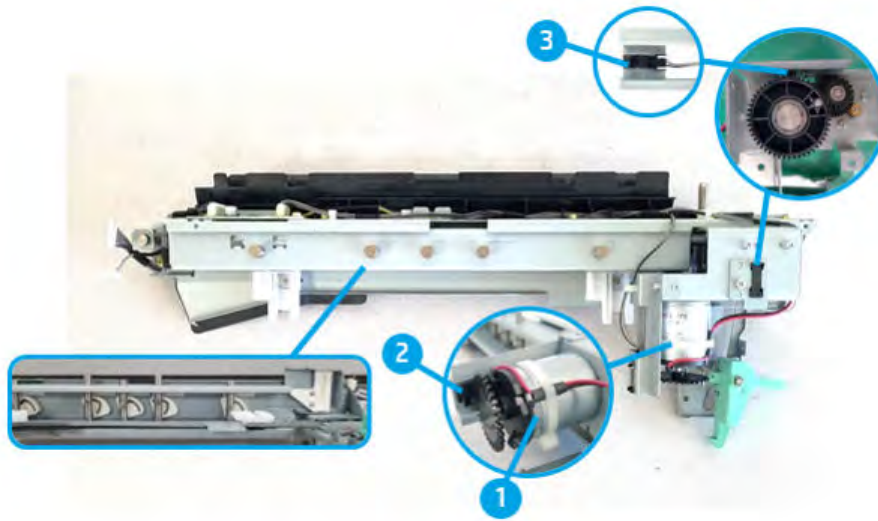


Table 6-11 Inner finisher system - punch unit parts information

Item	Part name	Part number	Orderable <sup>(*)</sup>	Diagnostics	Description
-	Hole 2/3 Punch	Y1G02-67901	(*)		Punch unit assembly for hole 2/3
	Hole 2/4 Punch	Y1G03-67901			Punch unit assembly for hole 2/4
	Swedish Punch	Y1G04-67901			Punch unit assembly for Swedish
	Punch cover	JC90-01343B			Punch cover (for the finisher punch is not installed)
1	Punch motor	-		113-0610	Drives the entrance roller connected by a belt
2	Punch motor sensor	-		113-0600	Detects punch motor operation
3	Punch home sensor	-		113-0612	Detects punchers' home position
Not shown	Punch PBA 2-4 hole	SS465-67001	(*)		
Not shown	Punch PBA 2-3 hole	SS467-67001	(*)		
Not shown	Punch PBA Swedish	SS466-67001	(*)		

(\*) This part is in system.

Figure 6-15 Inner finisher system - punch unit operation (3 holes)

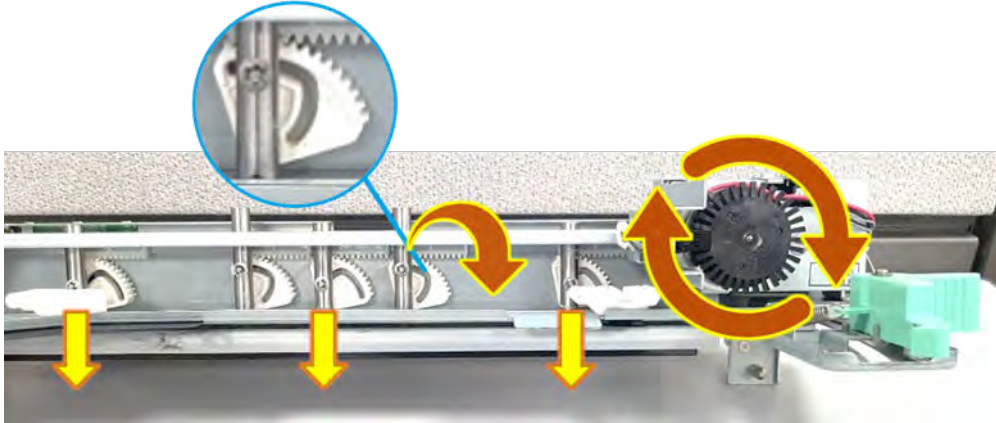
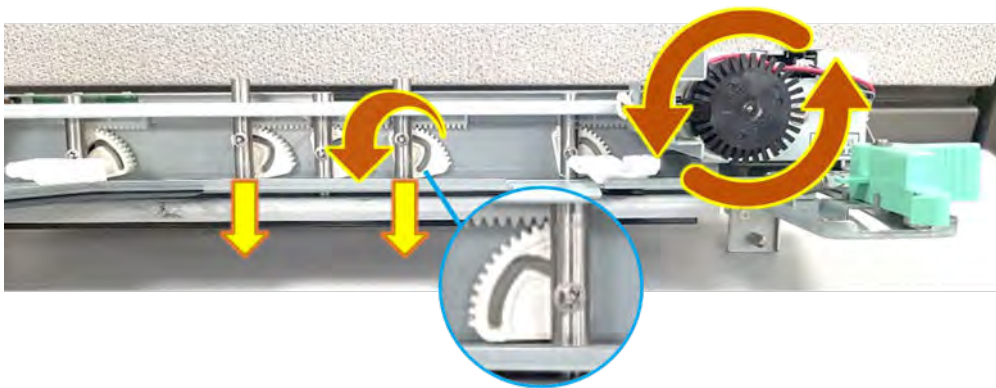


Figure 6-16 Inner finisher system - punch unit operation (2 holes)



## Entrance unit

Learn about the entrance unit of the inner finisher.

The entrance unit is located right after the punch unit. This unit is driven by entrance motor which is installed on the rear of the finisher. This motor is connected to the entrance roller by a belt, which transfers driving force to move paper from the printer to the finisher inside. If an error such as paper jam occurs in the entrance unit, the entrance sensor detects the error and generates an event code (13.60.xx).

Figure 6-17 Inner finisher system - entrance unit overview

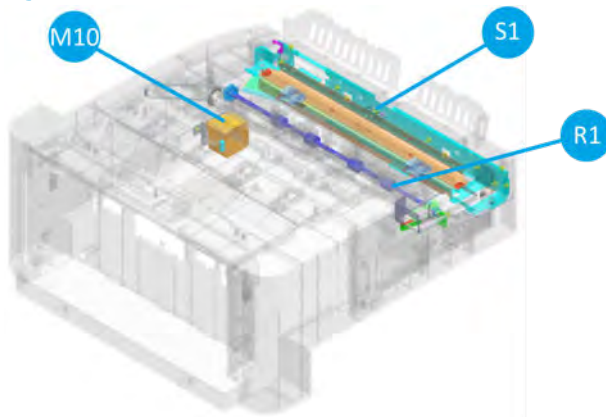


Figure 6-18 Inner finisher system - entrance unit detail view

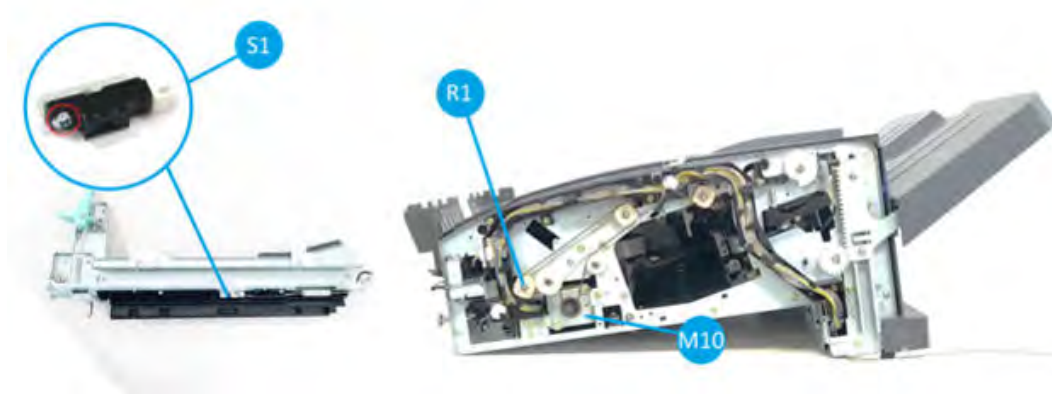


Table 6-12 Inner finisher system - entrance unit parts information

Item	Part name	Part number	Orderable <sup>(*)</sup>	Diagnostics	Description
S1	Entrance sensor	0604-001381	(*)	113-0350	Detects paper if it comes into the entrance unit
M10	Entrance motor assembly	JC90-01344A	(*)	113-0501	Drives the entrance roller connected by a belt
-	Entrance motor	JC31-00169B	(*)		
R1	Entrance roller	JC66-04243A	(*)		Moves paper forward

(\*) This part is in ordering system.

## Diverter unit

Learn about the diverter unit of the inner finisher.

The diverter unit holds paper so that the newly printed paper can wait for a few seconds until the stapled bundle moves to the output tray. The diverter unit is used to change paper path, which is done by a spring mounted on the diverter unit. When paper exit from the unit, it goes through the upper path of the diverter. When the paper rolls back, it passes the lower paper path created by the diverter. Here, the paper sits for a while until the next paper is ready to come out together.

Figure 6-19 Inner finisher system - diverter unit overview

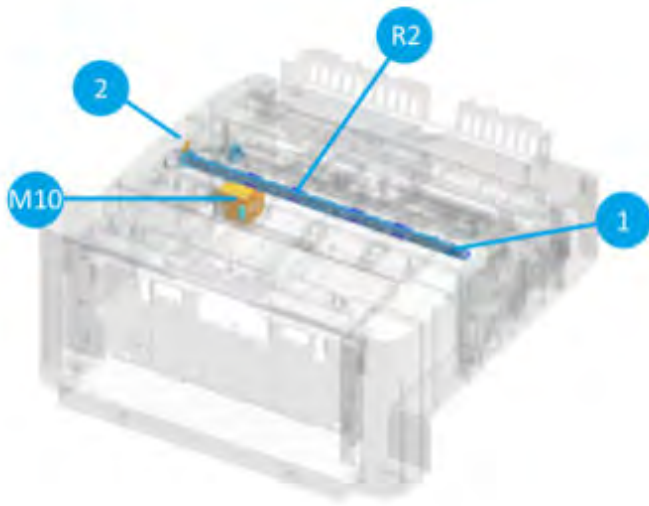


Figure 6-20 Inner finisher system - diverter unit detail view

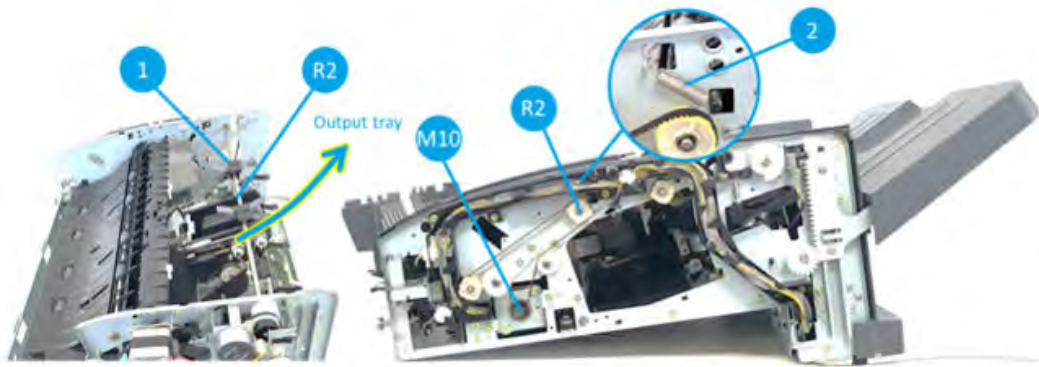


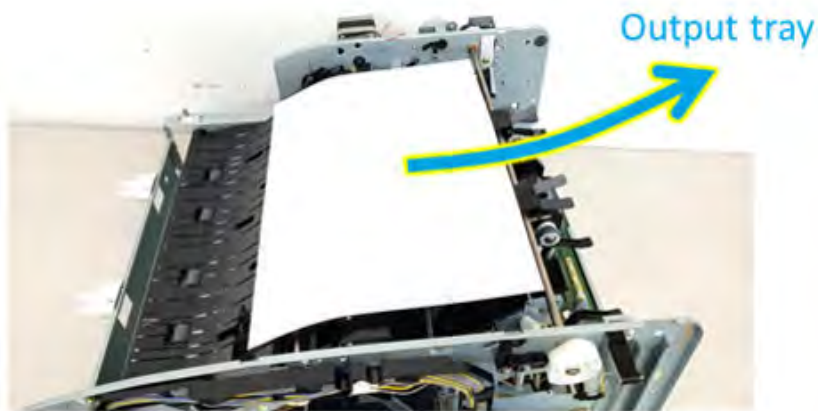
Table 6-13 Inner finisher system - diverter unit parts information

Item	Part name	Part number	Orderable <sup>(*)</sup>	Diagnostics	Description
M10	Entrance motor assembly	JC90-01344A	(*)	113-501	Drives the feed roller connected by a belt
	Entrance motor	JC31-00169B	(*)		
R2	Middle roller	JC66-04243A	(*)		Drives paper forward installed in front of the diverter
1	Diverter	JC61-06392A			Changes paper path when paper goes backward
2	Diverter spring	JC61-07269A			Pulls the diverter to upward so that it makes paper path to the lower of the diverter

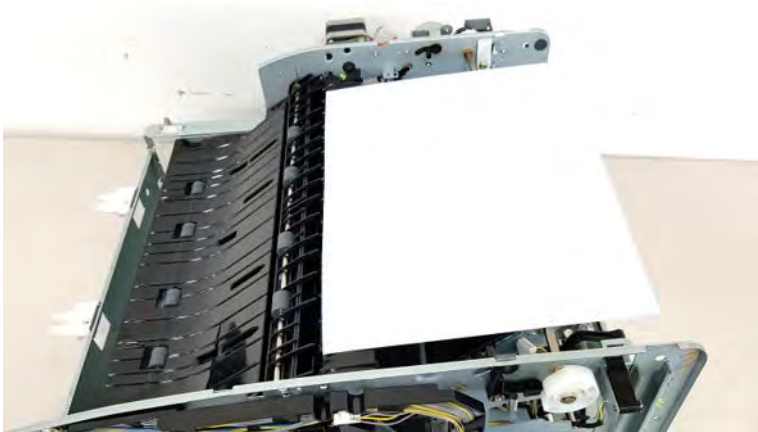
(\*) This part is in ordering system.

### Diverter unit operation

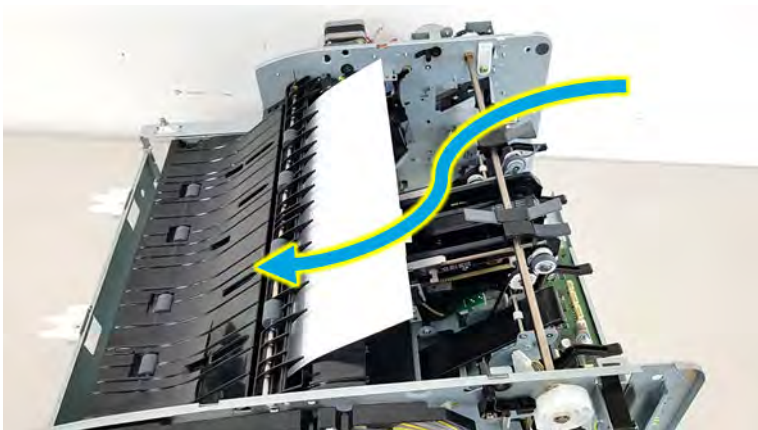
1. Paper goes forward to the output tray.



2. Exit roller stops after paper passes by the diverter unit.



3. Paper goes backward under the diverter unit.



## Exit unit

Learn about the exit unit of the inner finisher.

The exit unit is the part that moves paper from the diverter unit to the ejector unit. The exit unit is powered by an exit motor installed on the front of the finisher. The motor and the exit roller are connected by a single belt. The exit motor rotates in both the forward and reverse directions, since it serves to return paper to a new paper path

created by the diverter unit. The exit sensor is installed right in front of exit roller. It generates an event code when a paper jam occurred.

Figure 6-21 Inner finisher system - exit unit overview

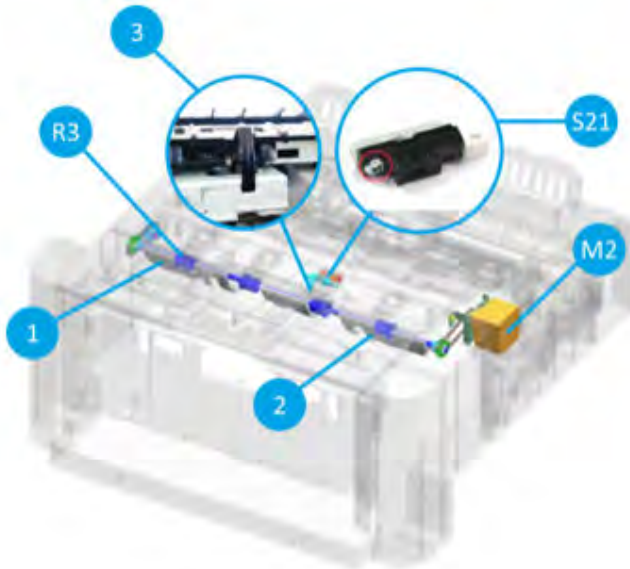


Figure 6-22 Inner finisher system - exit unit detail view

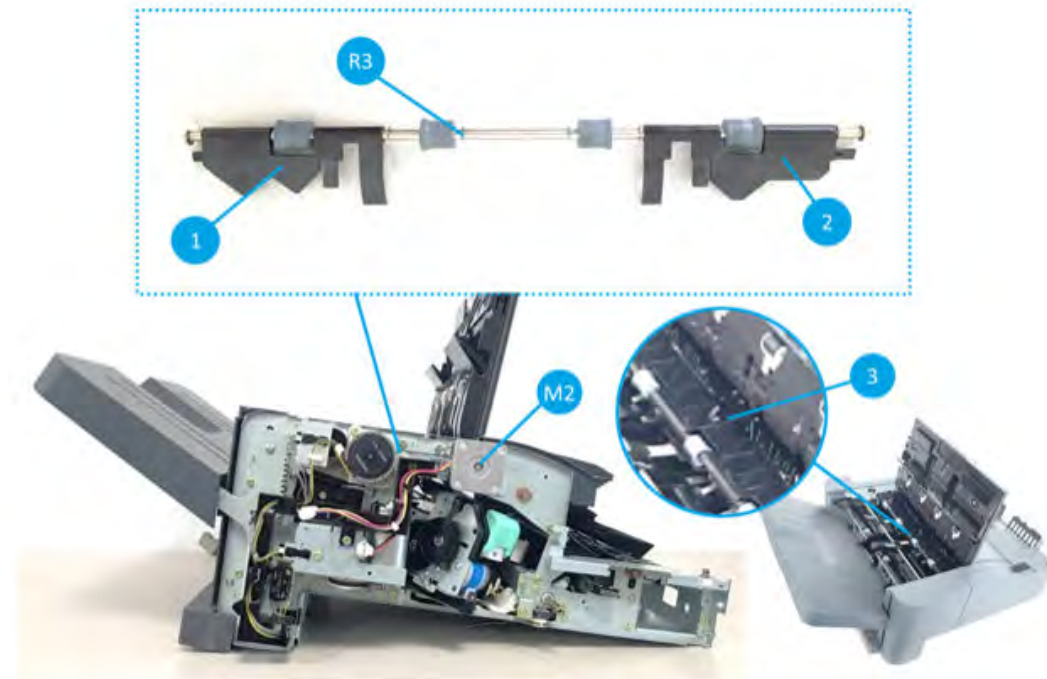


Table 6-14 Inner finisher system - exit unit parts information

Item	Part name	Part number	Orderable <sup>(*)</sup>	Diagnostics	Description
1	Rear compile guide	JC61-07450A	(*)		Guides to help paper move through the paper path
2	Front compile guide	JC61-07449A	(*)		Guides to help paper move through the paper path

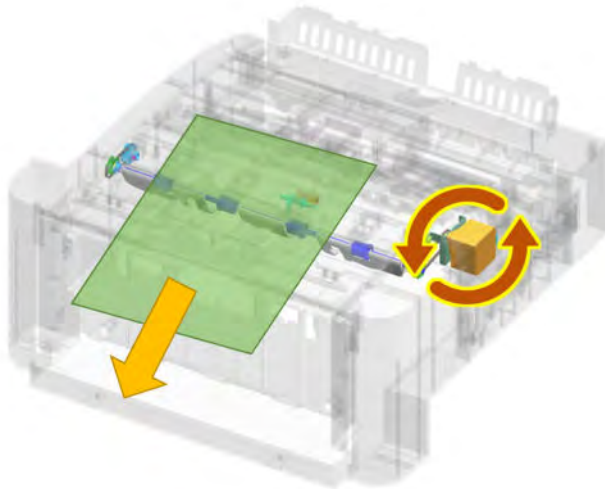
**Table 6-14** Inner finisher system - exit unit parts information (continued)

Item	Part name	Part number	Orderable <sup>(*)</sup>	Diagnostics	Description
3	Exit sensor actuator	JC66-04199A	(*)	113-0360	Makes the sensor on and off by checking paper
S21	Exit sensor	0604-001415	(*)	113-0360	Detects paper if it passes through the exit unit
M2	Exit motor assembly	JC90-01331A		113-0502	Drives the exit roller connected by a belt
	Exit motor	JC31-00169B	(*)		
R3	Exit roller	JC66-04244A	(*)		Moves paper to the ejector unit

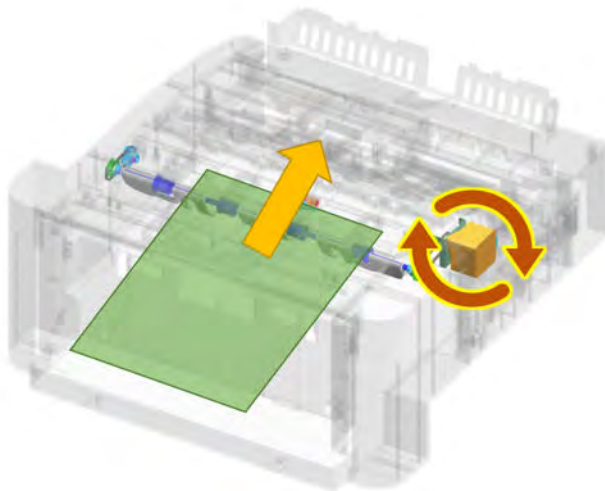
<sup>(\*)</sup> This part is in ordering system.

### Exit unit operation

1. When rotating the exit motor counter clockwise, paper goes forward to the output tray.



2. When rotating the exit motor clockwise, paper goes backward to the end fence unit.





## Paper support unit

Learn about the paper support unit of the inner finisher.

Paper support unit works to prevent the paper from falling out or being folded. Also, the newly printed paper will not scatter papers already sitting on the output tray. Paper guides are installed on each front and rear side of the finisher, these guides move towards the output tray when the paper exits, then the guides return to the original position after the support operation is completed. The paper support home sensor confirms the original position of the guide.

Figure 6-23 Inner finisher system - paper support unit overview

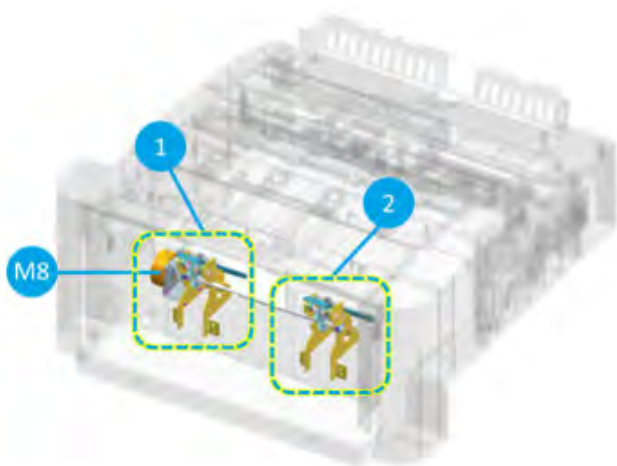


Figure 6-24 Inner finisher system - paper support unit detail view

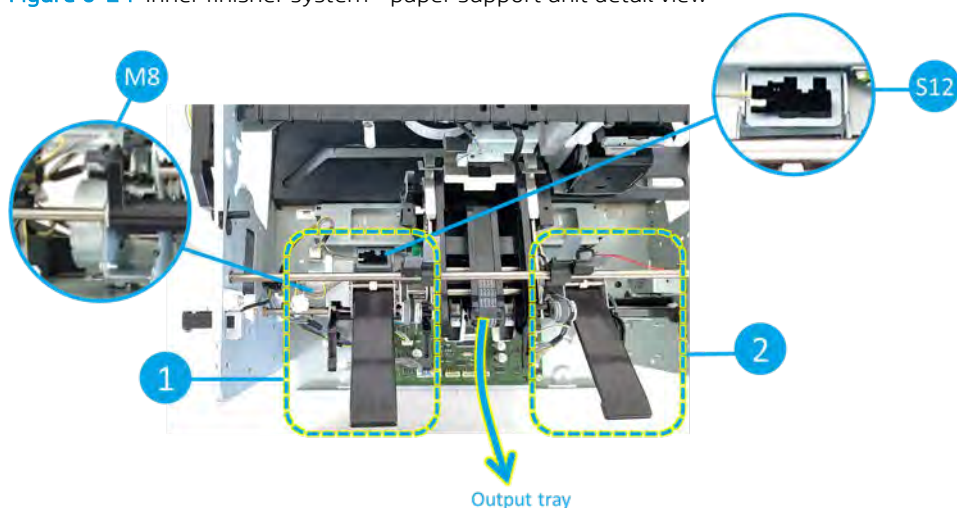


Table 6-15 Inner finisher system - paper support unit parts information

Item	Part name	Part number	Orderable <sup>(*)</sup>	Diagnostics	Description
1	Rear paper support	JC90-01311A	(*)		Supports paper not to be bended
2	Front paper support	JC90-01310A	(*)		Supports paper not to be bended
S12	Paper support home sensor	0604-001393		113-0481	Detects the paper support guides locate at the home position

Table 6-15 Inner finisher system - paper support unit parts information (continued)

Item	Part name	Part number	Orderable <sup>(*)</sup>	Diagnostics	Description
M8	Paper support motor assembly	JC93-00802B		113-0571	Drives paper support guides from the home position to the forward direction
	Paper support motor	JC31-00149A			

(\*) This part is in ordering system.

### Paper support unit operation

Paper support unit is extended to the arrow direction to help paper is bent of fallen to the output tray.

Figure 6-25 Inner finisher system - paper support unit operation



### Paddle unit

Learn about the paddle unit of the inner finisher.

The paddle unit consists of two paddle systems, a main paddle and a sub paddle. First, when paper is discharged from the exit unit, the main paddle unit moves paper to the sub paddle. Then the sub paddle unit moves paper to the end fence unit so that it can be ready to be stapled.

The main paddle unit is operated by the main paddle motor. The main paddle sensor detects the main paddle position. The sub paddle unit rotates by the exit motor.

Figure 6-26 Inner finisher system - paddle unit driving system overview (main paddle unit)

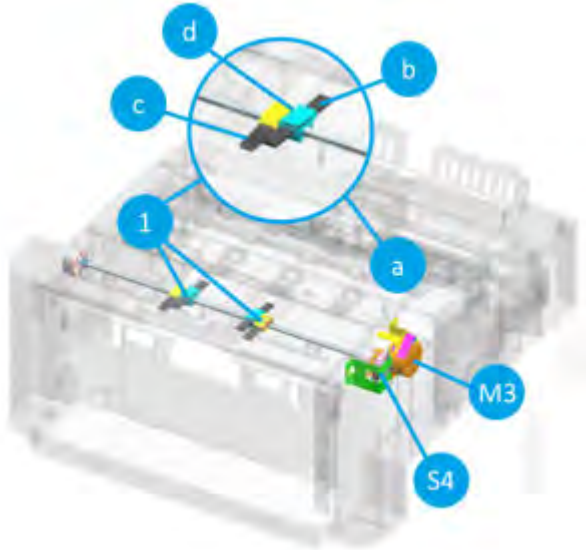


Figure 6-27 Inner finisher system - paddle unit driving system overview (sub paddle unit)

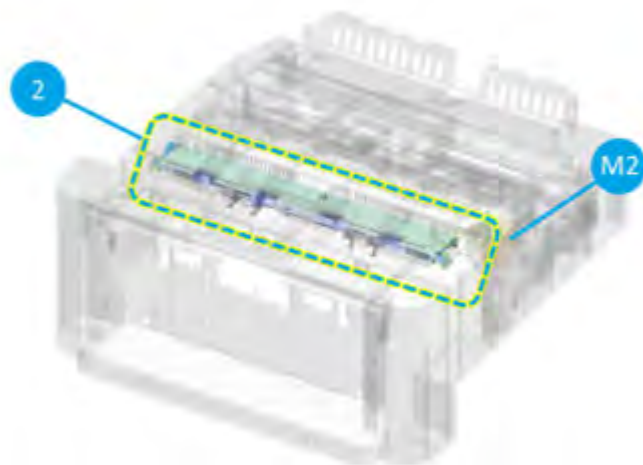


Figure 6-28 Inner finisher system - paddle unit driving system detail view (1/2)

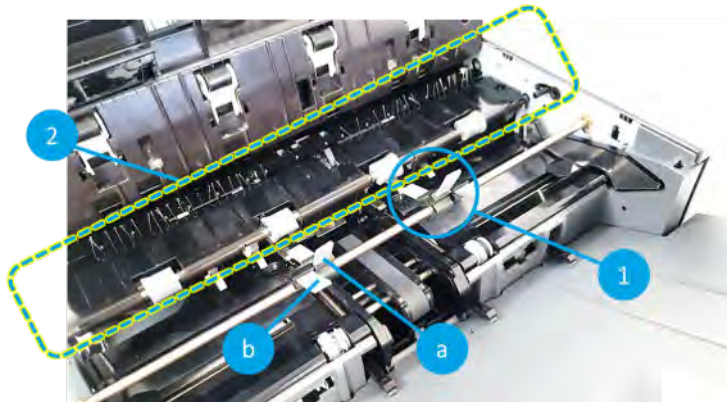


Figure 6-29 Inner finisher system - paddle unit driving system detail view (2/2)

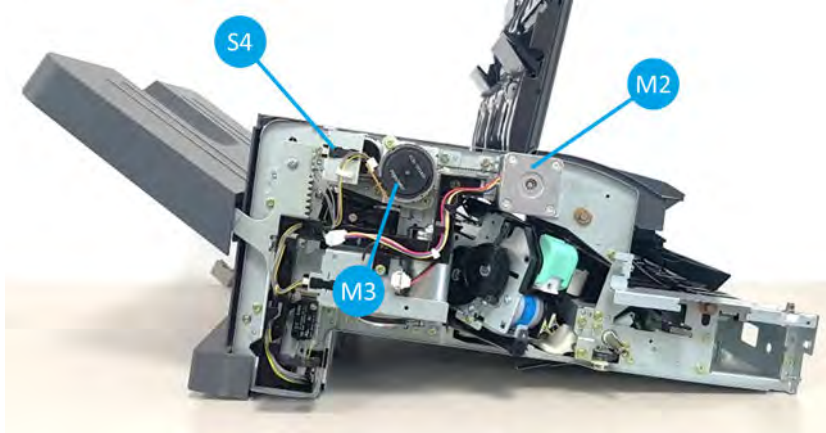


Table 6-16 Inner finisher system - paddle unit parts information

Item	Part name	Part number	Orderable <sup>(*)</sup>	Diagnostics	Description
1	Main paddle	JC90-01327A	(*)		Moves paper to the sub paddle unit
1-a	Main paddle kit	JC82-01038A	(*)		
1-b	Main paddle A	JC63-04957A	(*)		
1-c	Main paddle B	JC63-04958A	(*)		
1-d	Main paddle holder	JC81-07560A	(*)		
2	Sub paddle	JC90-01336A	(*)		Gets paper move to the end fence and arrange them to be stapled correctly
S4	Main paddle home sensor	0604-001393		113-0370	Detects the home position of the main paddle
M3	Main paddle motor assembly	JC90-01331A	(*)	113-0510	Drives the main paddle unit connected by a belt
	Main paddle motor	JC31-00149A			
M2	Exit motor	JC31-00169B	(*)	113-0502	Drives the sub paddle unit connected by a belt

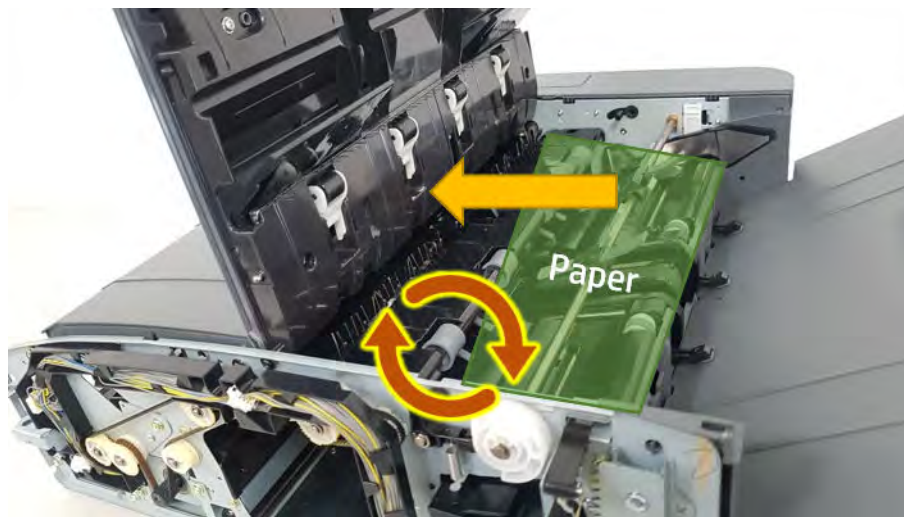
<sup>(\*)</sup> This part is in ordering system.

### Paddle unit operation

1. Main paddles get paper moves to the sub paddle unit.



2. Sub paddle unit gets paper goes to the end fence unit.



## Tamper unit

Learn about the tamper unit of the inner finisher.

The tamper unit functions to align the left and right sides of a bundle of paper in order to staple it to the correct position. When a certain amount of paper for stapling is collected after printing, the tamper unit hits the left and right ends of the paper to align the paper correctly.

Each temper has a motor on the back side that delivers driving force to move. The temper unit sensors are mounted on the back side of the unit, to check the position of the temper unit.

Figure 6-30 Inner finisher system - tamper unit overview

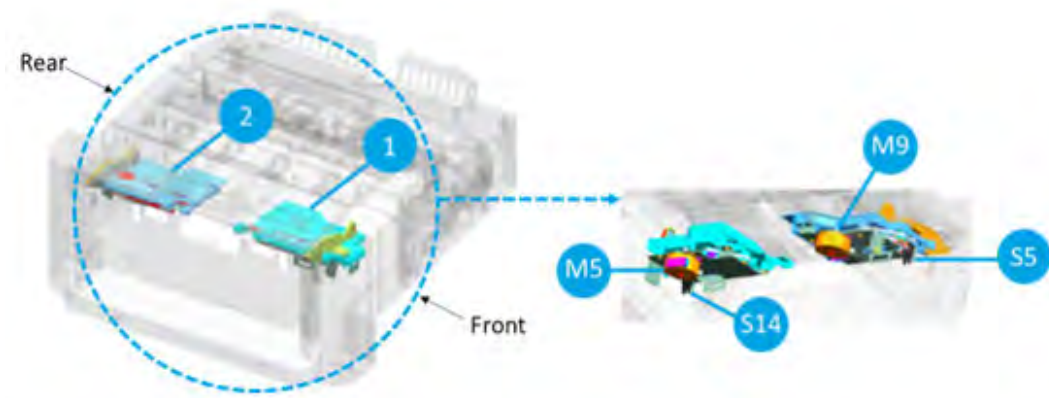


Figure 6-31 Inner finisher system - tamper unit detail view (1/3)

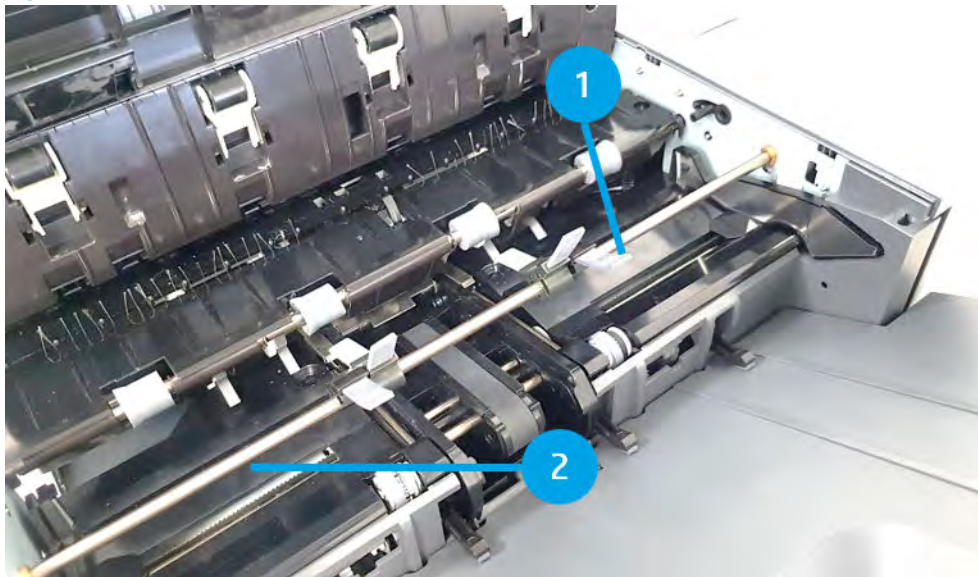


Figure 6-32 Inner finisher system - tamper unit detail view (rear) (2/3)

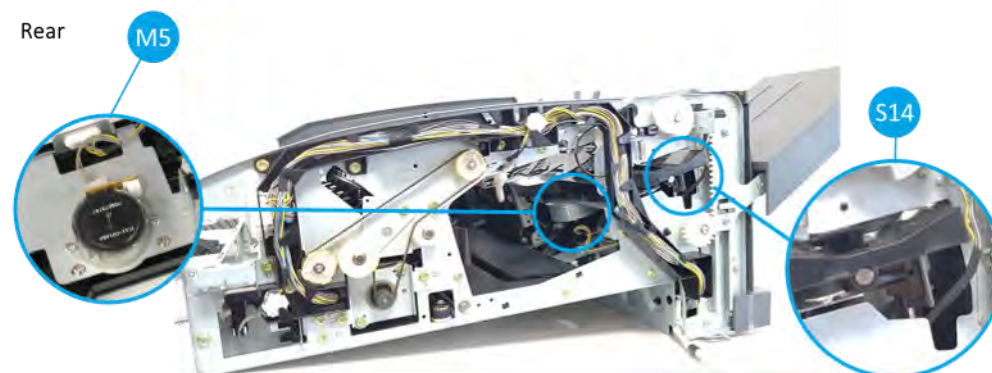


Figure 6-33 Inner finisher system - tamper unit detail view (front) (3/3)

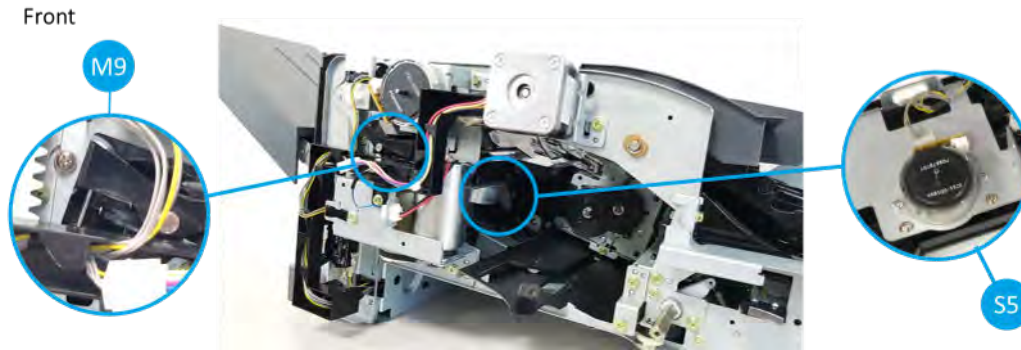


Table 6-17 Inner finisher system - tamper unit parts information

Item	Part name	Part number	Orderable <sup>(*)</sup>	Diagnostics	Description
1	Front tamper	JC82-00899A	(*)		Aligns left and right side of paper
2	Rear tamper	JC82-00900A	(*)		Aligns left and right side of paper
M5	Rear tamper motor assembly	JC93-01001A	(*)	113-0520	Drives the rear tamper unit
	Rear tamper motor	JC31-00149A			
S14	Rear tamper home sensor	0604-001393		113-0380	Detects the reference position of the tamper unit
M9	Front tamper motor assembly	JC93-01001A	(*)	113-0530	Drives the front tamper unit
	Front tamper motor	JC31-00149A			
S5	Front tamper home sensor	0604-001393		113-0390	Detects the reference position of the tamper unit

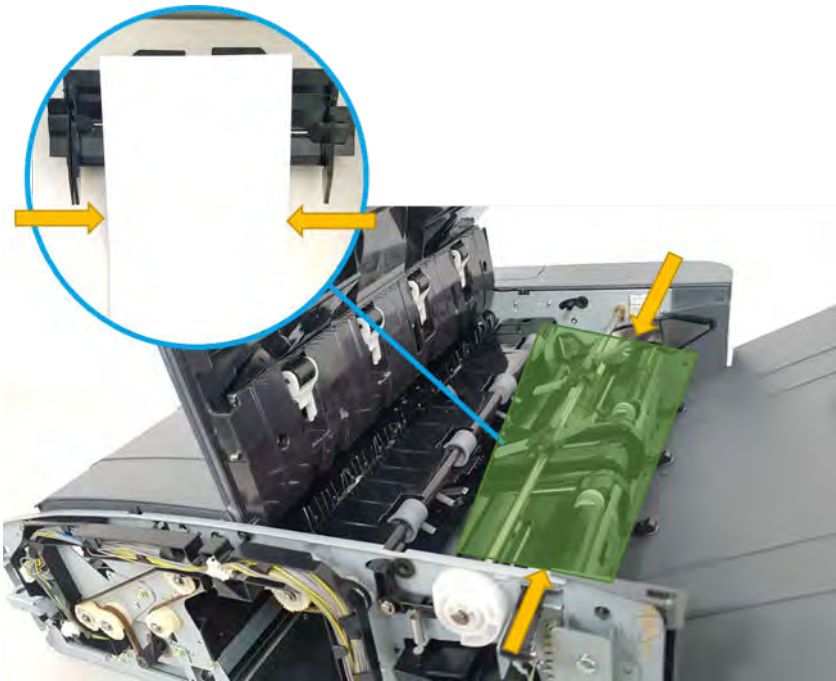
(\*) This part is in ordering system.

## Tamper unit operation

1. Paper is arranged at the end of the end fence unit.



2. The left and right tampers arrange a stack of paper.



## End fence unit

Learn about the end fence unit of the inner finisher.

The paddle unit moves paper to the end fence unit. The end fence unit sets the standard position of the paper to be aligned towards top and bottom of the paper. The end fence is fixed onto the finisher, and the end fence sensor can sense any paper entering the end fence unit.

**Figure 6-34** Inner finisher system - end fence unit overview

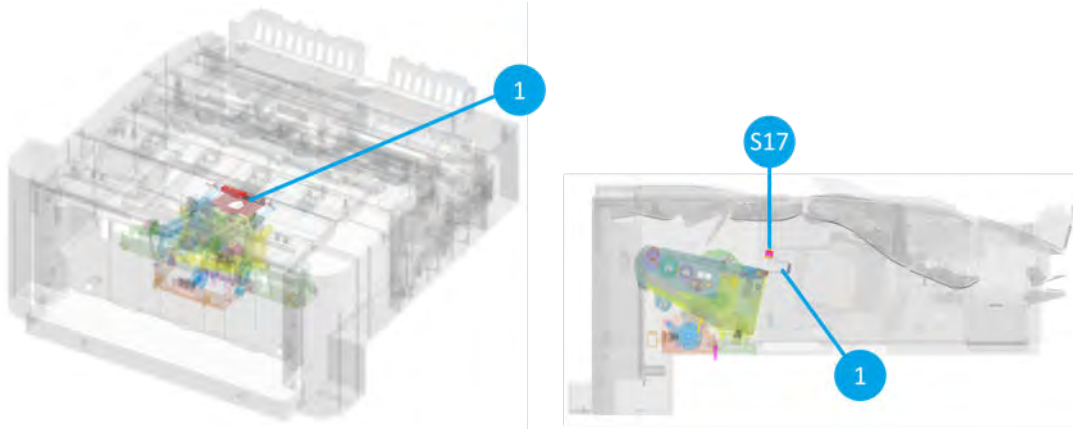




Figure 6-35 Inner finisher system - end fence unit detail view

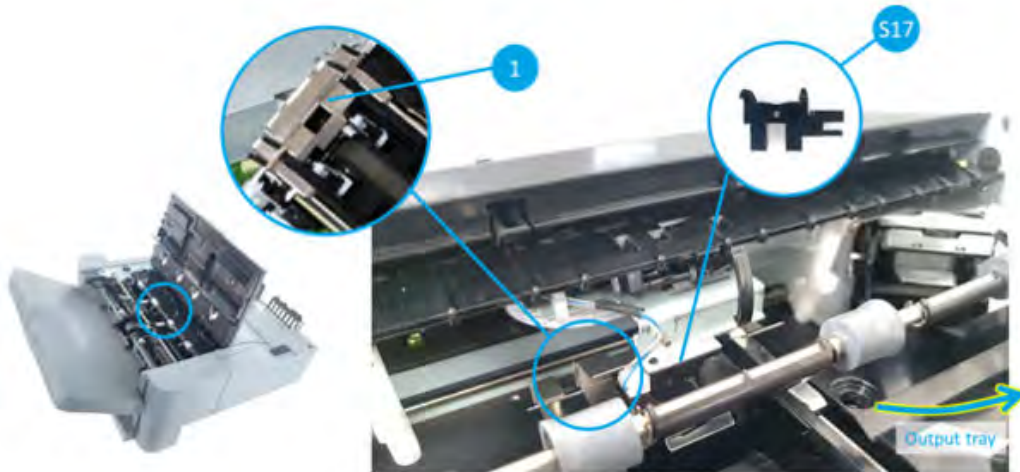


Table 6-18 Inner finisher system - end fence unit parts information

Item	Part name	Part number	Orderable <sup>(*)</sup>	Diagnostics	Description
1	End fence	JC61-06428A			Aligns paper toward top and bottom direction
2	End fence sensor	0604-001381	(*)	113-0361	Detects paper whether paper exists in the end fence unit

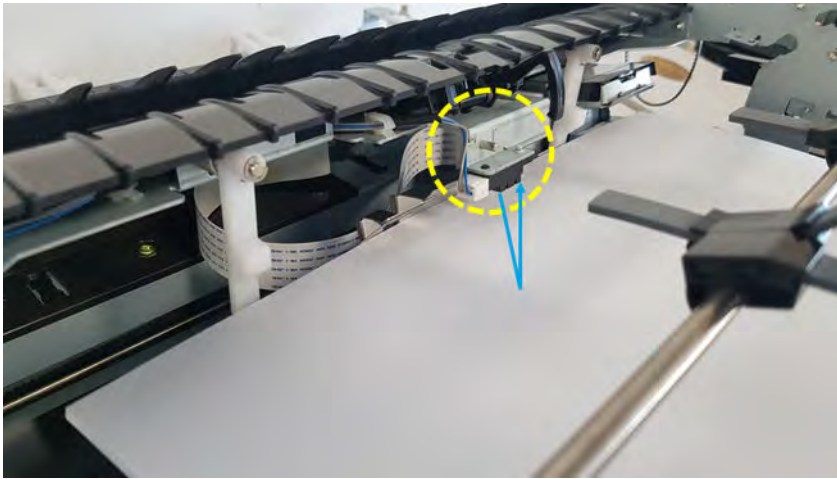
(\*) This part is in ordering system.

### End fence unit operation

1. Paper goes into the end fence unit through the main paddle unit and sub paddle unit. At the same time the end fence unit is aligned paper to the direction of yellow line.



2. The end fence sensor is checking whether paper goes into the end fence sensor.



## Stapler unit

Learn about the stapler unit of the inner finisher.

Stapler unit is a device installed inside the finisher that staples a bundle of aligned documents. Documents are collected as a bundle by the tamper unit and the end fence unit for stapling, then stapler assembly staples the bundle. There are 6 options to make a bundle.

**Figure 6-36** Inner finisher system - stapling options



The stapler unit moves using the stapler motor installed inside. The four stapler position sensors are mounted so that the stapler can be positioned in the exact stapling position whether it is stapled on the left, the right, or at the center of the document. Stapling is done by the motor inside the stapler assembly.

**Figure 6-37** Inner finisher system - stapler unit overview

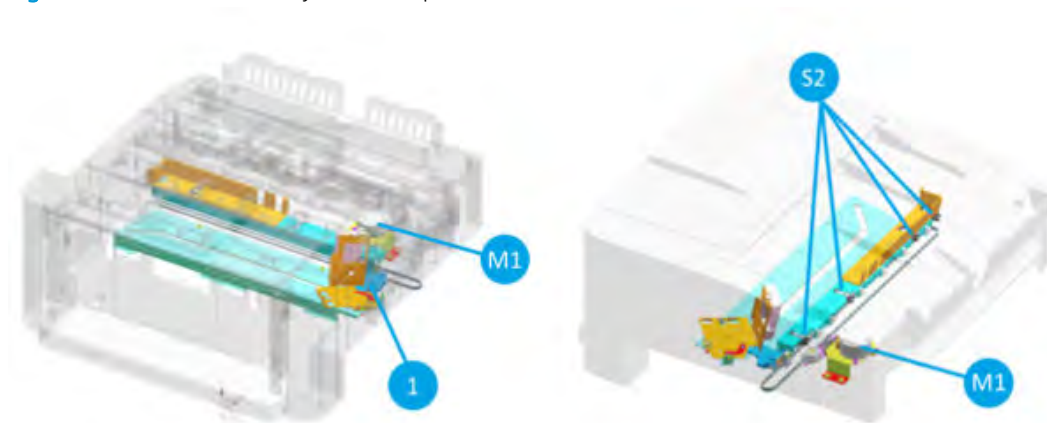


Figure 6-38 Inner finisher system - stapler unit detail view (1/2)

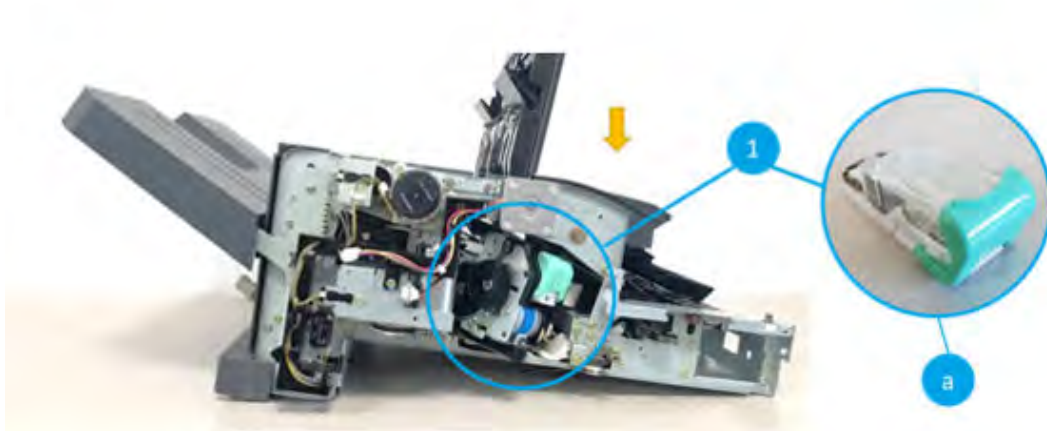


Figure 6-39 Inner finisher system - stapler unit detail view (2/2)

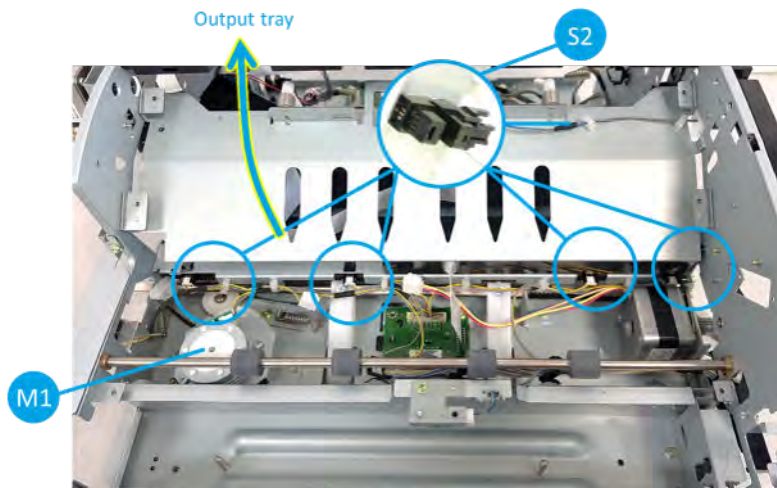


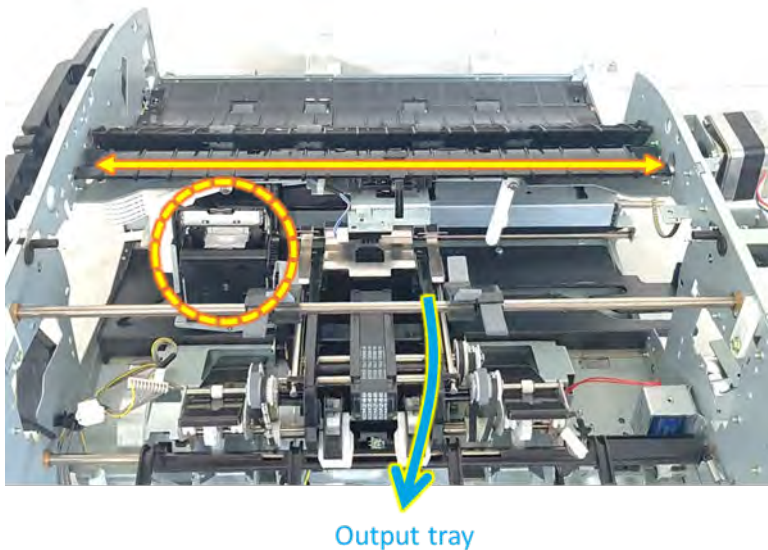
Table 6-19 Inner finisher system - stapler unit parts information

Item	Part name	Part number	Orderable <sup>(*)</sup>	Diagnostics	Description
1	Stapler assembly	JC59-00040A	(*)		Staples a bundle of paper
1-a	Staple cartridge	JC81-07408B	(*)		Staple cartridge
S2	Stapler position sensor	0604-001393	(*)	113-0491 113-0492	Detects and moves the staple assembly position to make a bundle of paper at the exact location
M1	Stapler position motor	JC93-00999A	(*)	113-0581	Gets the staple assembly move toward top and down direction of paper

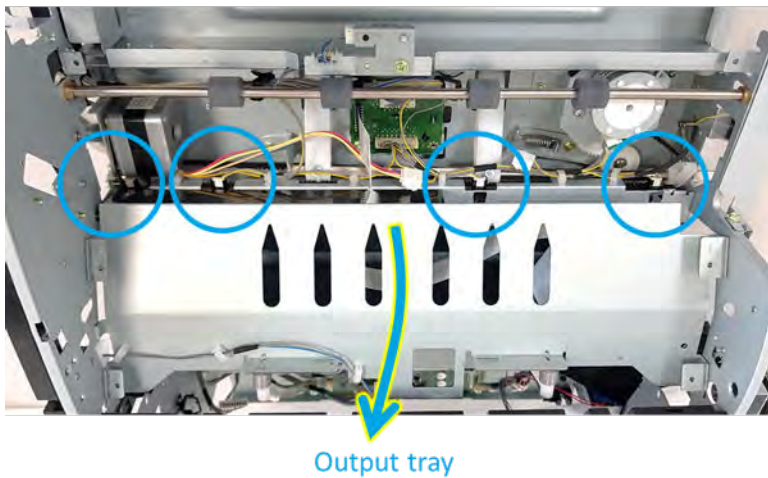
(\*) This part is in ordering system.

### Stapler unit operation

1. The stapler position motor delivers the stapler assembly to the horizontal direction (yellow line).



2. The stapler assembly checks front and rear home position and moves where the stapler position sensors are located depending on stapling types.



## Ejector unit

Learn about the ejector unit of the inner finisher.

The ejector unit moves a bundle of stapled paper out. The ejector unit consists of ejector1 and ejector2. The Ejector1 transfers a stapled paper loaded at the end fence unit to the ejector2 unit. During this process, the ejector1 motor transmits the driving force to the ejector1 unit. And the ejector1 home position sensor controls the movement of the ejector1. When the paper arrives at the ejector2 unit, the ejector2 grabs a stack of paper and ejects it onto the output tray. The ejector2 motor is responsible for this process, and the ejector2 motor sensor helps it to be controlled correctly. In addition, the ejector2 home position sensor is mounted to check the location of the ejector2.

Figure 6-40 Inner finisher system - ejector unit overview

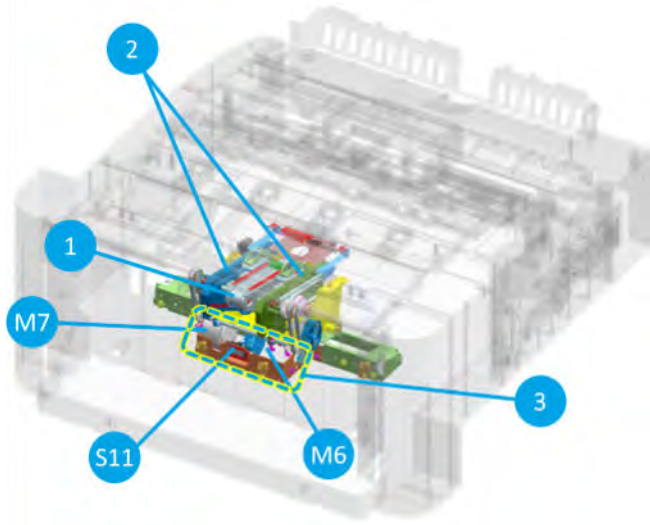


Figure 6-41 Inner finisher system - ejector unit detail view (1/3)

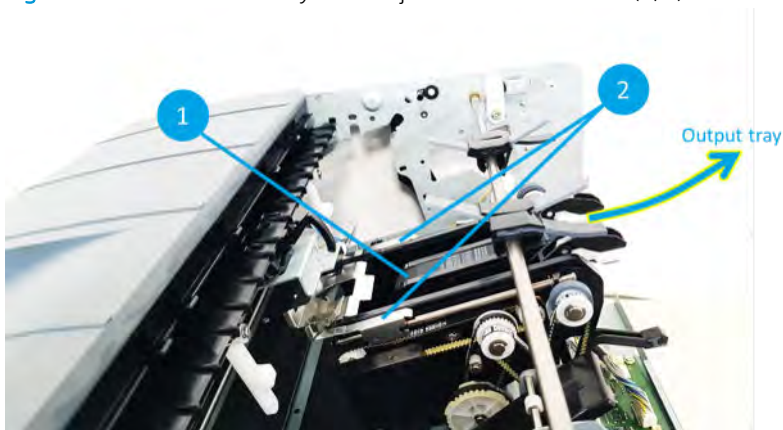


Figure 6-42 Inner finisher system - ejector unit detail view (2/3)



Figure 6-43 Inner finisher system - ejector unit detail view (3/3)

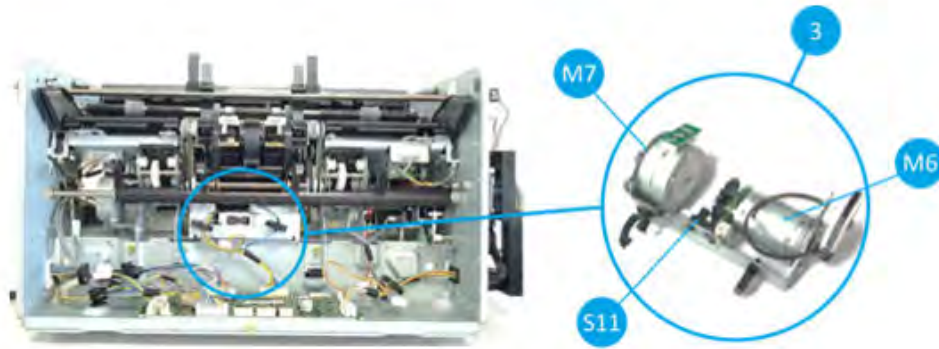


Table 6-20 Inner finisher system - ejector unit parts information

Item	Part name	Part number	Orderable <sup>(*)</sup>	Diagnostics	Description
NA	Ejector	SS456-61001	(*)		
1	Ejector2	Not applicable			Moves paper from the ejector 1 to the output tray
2	Ejector1	Not applicable			Moves the stack of paper from the end fence to the ejector2
S10	Ejector2 home sensor	0604-001393	(*)	113-0462	Detects the home position of the ejector2
S16	Ejector1 home sensor	0604-001393	(*)	113-0461	Detects the home position of the ejector1
3	Ejector motor assembly	JC90-01309A			Moves the ejector1 and ejector2
M6	Ejector2 motor assembly	JC93-01168A	(*)	113-0562	Moves the ejector2 forward and backward
	Ejector2 motor	JC31-00175A			Detects the ejector2 motor rotation
S11	Ejector2 motor sensor	0604-001393	(*)	113-0463	
M7	Ejector1 motor assembly	JC93-00998A	(*)	113-0561	Grabs a stack of paper, then move it to the output tray
	Ejector1 motor	JC31-00009C			

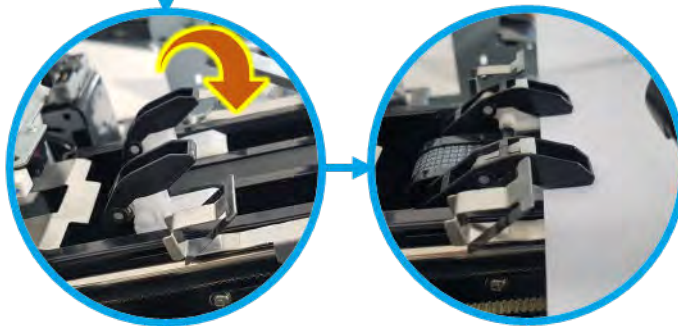
(\*) This part is in ordering system.

### Ejector unit operation

1. Ejector 1 pushes aligned paper at the end fence unit to ejector 2 unit.



2. Ejector 2 grabs paper, then moves forward to the output tray unit direction.



3. Ejector2 draws off paper on the output tray.



## Output tray & paper holding unit

Learn about the output tray & paper holding unit of the inner finisher.

The output tray moves up and down along the rails inside the finisher, and the output tray motor controls those movement according to the signals sent from the paper holding sensor. As paper stacks up on the output tray, the paper holding unit is lifted by papers. When the paper holding sensor is touched, the output tray moves downward.

The machine detects when the output tray is full as the output tray hits the lower limit switch. The output tray top of stack sensor is mounted on both left and right sides for the case that the paper holding sensor breaks down.

The paper holding solenoid lifts the paper holding actuator up when a new bundle of paper come to the output tray.

**Figure 6-44** Inner finisher system - output tray unit overview

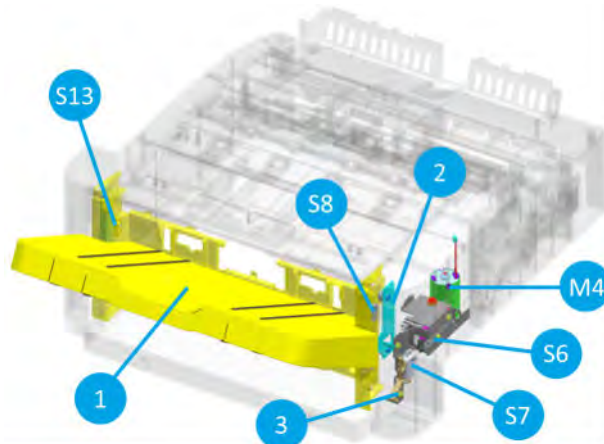




Figure 6-45 Inner finisher system - output tray unit detail view (1/2)

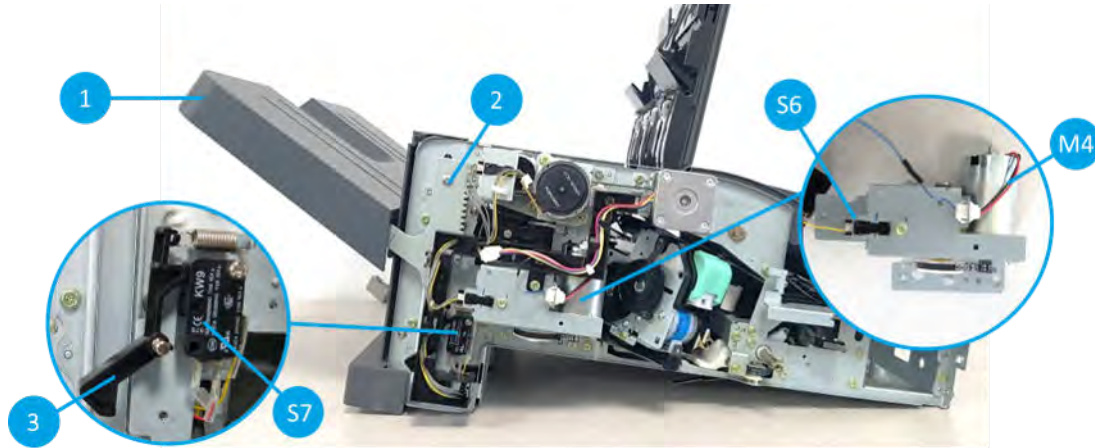


Figure 6-46 Inner finisher system - output tray unit detail view (2/2)

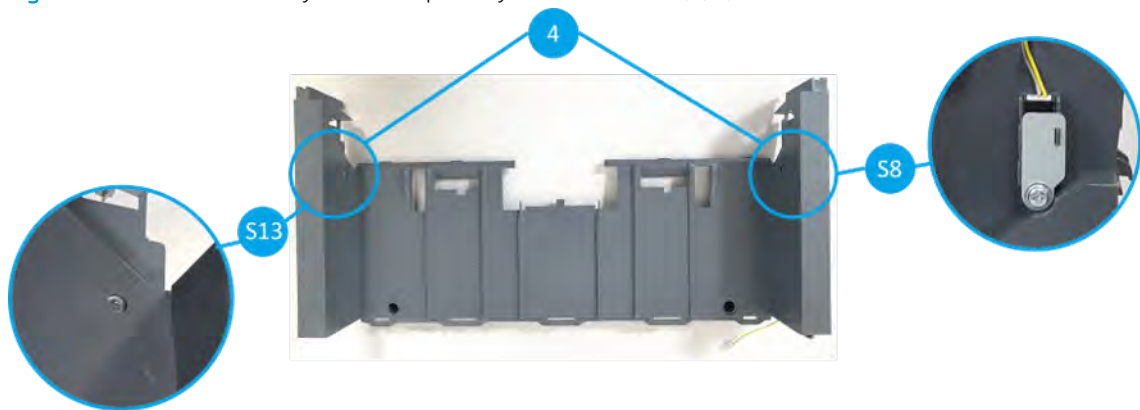


Table 6-21 Inner finisher system - output tray unit parts information

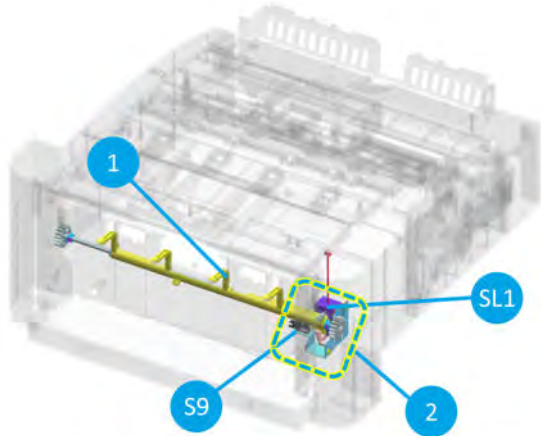
Item	Part name	Part number	Orderable <sup>(*)</sup>	Diagnostics	Description
1	Output tray	JC90-01337B	(*)		Stacking plate for ejected paper
M4	Output tray motor assembly	JC90-01334B	(*)	113-0570	Moves the output tray up and down
	Output tray motor	JC31-00178B	(*)		
S6	Output tray motor sensor	0604-001393		113-0473	Detects if the output tray motor is operational
2	Output tray frame	JC90-01319A	(*)		
S7	Output tray lower limit switch	JC90-01320A	(*)	113-0472	Detects the lowest position of the output tray
3	Output tray lower actuator	JC66-04200A	(*)	113-0472	Detects the lowest position of the output tray
4	Output tray top of stack sensor kit	JC82-01039A	(*)	113-0471	Detects abnormal movement of output tray (Output tray top of stack sensor receiver + led)
S8	Output tray top of stack sensor (receiver)	0603-001309	(*)		

**Table 6-21** Inner finisher system - output tray unit parts information (continued)

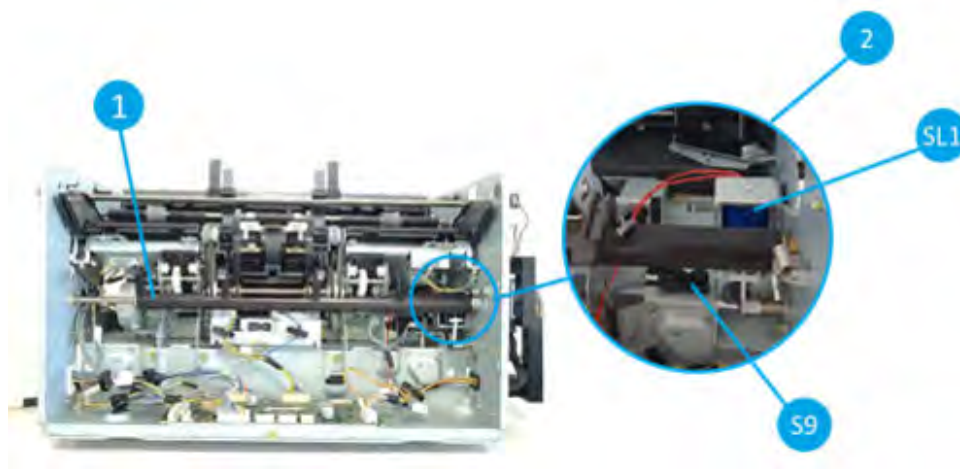
Item	Part name	Part number	Orderable <sup>(*)</sup>	Diagnostics	Description
S13	Output tray top of stack sensor (led)	0601-003440			

<sup>(\*)</sup> This part is in ordering system.

**Figure 6-47** Inner finisher system - paper holding unit overview



**Figure 6-48** Inner finisher system - paper holding unit detail view



**Table 6-22** Inner finisher system - output tray unit parts information

Item	Part name	Part number	Orderable <sup>(*)</sup>	Diagnostics	Description
1	Paper holding actuator	JC90-01313A	(*)		Controls the output tray height, and grabs stacked paper not to be scattered
2	Paper holding kit	JC90-01314A	(*)		Paper holding solenoid + Paper holding sensor
SL1	Paper holding solenoid	JC33-00037A	(*)	113-0591	Moves paper holding actuator up when paper goes out to the output tray

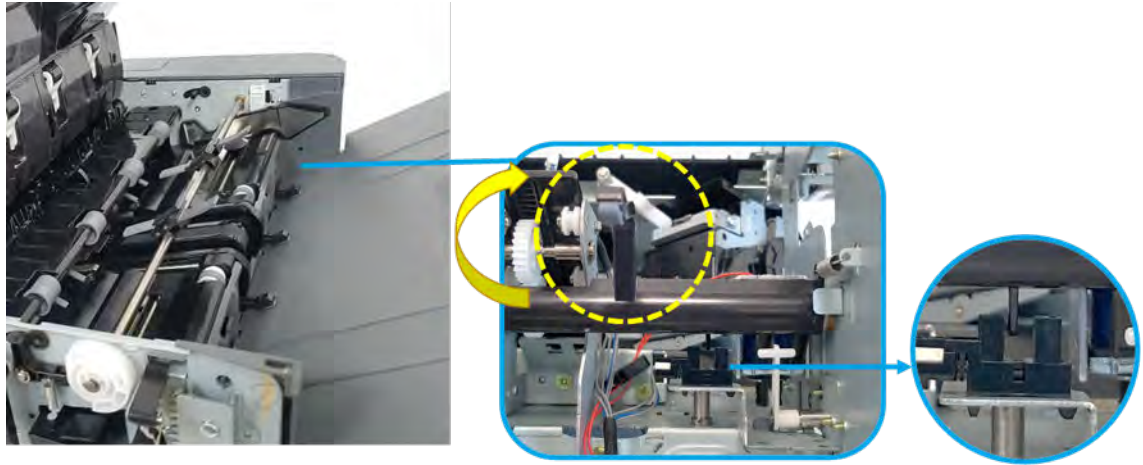
**Table 6-22 Inner finisher system - output tray unit parts information (continued)**

Item	Part name	Part number	Orderable <sup>(*)</sup>	Diagnostics	Description
S9	Paper holding sensor	0604-001393		113-0470	Detects stacked paper position

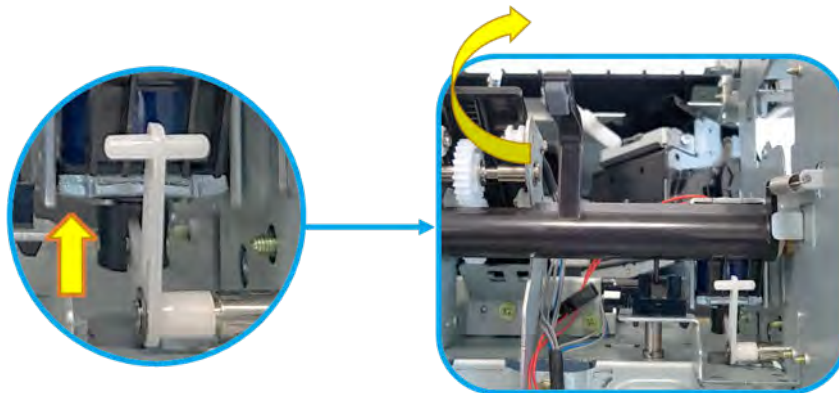
<sup>(\*)</sup> This part is in ordering system.

### Inner finisher system - output tray & paper holding unit operation

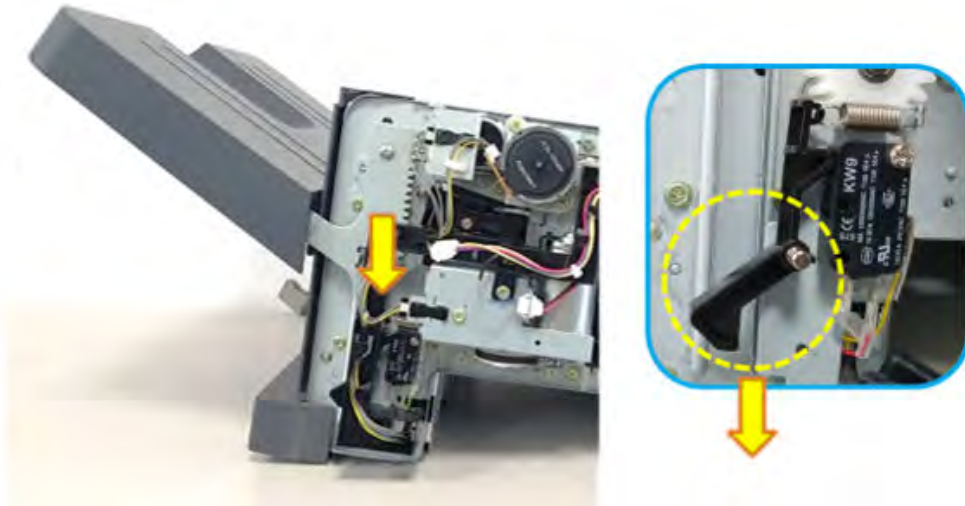
1. Paper holding unit helps paper stores stable on the output tray. Besides it detects amount of stacked paper and get the output tray moves downward.



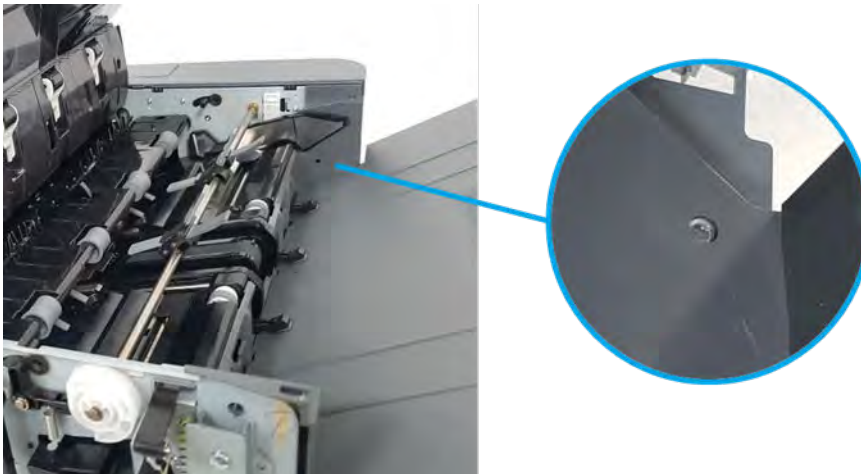
2. When paper goes out to the output tray, paper holding solenoid forcibly make paper holding actuator goes upward to create the paper passage not to be jammed by the paper holding actuator.



3. As the paper accumulates, output tray moves downward. When it reaches at the end of the moving range, output tray lower limit switch is pressed. The switch detects paper stacks full on the output tray.



4. In case of fatal error in the output tray unit and paper holding unit, output tray top of stack sensor makes the machine emergency stop so that output tray unit does not move upward.



## PCA connection information

Learn about the PCA connection information.

Figure 6-49 Inner finisher system - PCA connection information

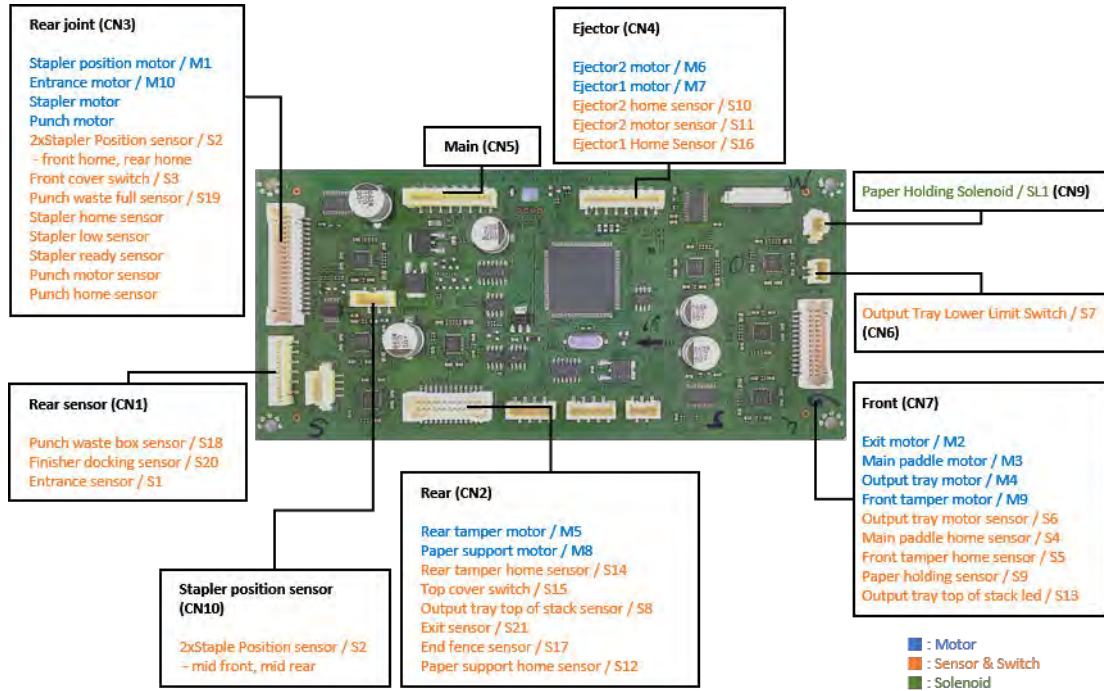


Table 6-23 Inner finisher system - PCA connectors, parts, and diagnostics information

CN No.	Connector name	Motor (Diagnostics)	Sensor (Diagnostics)	Switch & Solenoid (Diagnostics)
CN1	Rear sensor		<ul style="list-style-type: none"> <li>Punch waste box sensor (113-0620)</li> <li>Finisher docking sensor (113-0000)</li> <li>Entrance sensor (113-0350)</li> </ul>	
CN2	Rear	<ul style="list-style-type: none"> <li>Rear tamper motor (113-0520)</li> <li>Paper support motor (113-0571)</li> </ul>	<ul style="list-style-type: none"> <li>Rear tamper home sensor (113-0380)</li> <li>Output tray top of stack sensor (113-0471)</li> <li>Exit sensor (113-0360)</li> <li>End fence sensor (113-0361)</li> <li>Paper support home sensor (113-0481)</li> </ul>	<ul style="list-style-type: none"> <li>Top cover switch (113-0420)</li> </ul>

**Table 6-23** Inner finisher system - PCA connectors, parts, and diagnostics information (continued)

CN No.	Connector name	Motor (Diagnostics)	Sensor (Diagnostics)	Switch & Solenoid (Diagnostics)
CN3	Rear joint	<ul style="list-style-type: none"> <li>• Stapler motor (113-0550)</li> <li>• Stapler position motor (113-0581)</li> <li>• Entrance motor (113-0501)</li> <li>• Punch motor (113-0610)</li> </ul>	<ul style="list-style-type: none"> <li>• Stapler low sensor(113-0440)</li> <li>• Stapler ready sensor (113-0451)</li> <li>• Stapler home sensor(113-0430)</li> <li>• Stapler position sensor (front home) (113-0491)</li> <li>• Stapler position sensor (rear home) (113-0492)</li> <li>• Punch waste full sensor (113-0621)</li> <li>• Punch motor sensor(113-0600)</li> <li>• Punch home sensor (113-0612)</li> </ul>	<ul style="list-style-type: none"> <li>• Front cover switch (113-0420)</li> </ul>
CN4	Ejector	<ul style="list-style-type: none"> <li>• Ejector2 motor (113-0562)</li> <li>• Ejector1 motor (113-0561)</li> </ul>	<ul style="list-style-type: none"> <li>• Ejector2 motor sensor (113-0463)</li> <li>• Ejector2 home sensor (113-0462)</li> <li>• Ejector1 home sensor (113-0461)</li> </ul>	
CN5	Main (to the main PBA)			
CN6	Output tray lower limit switch			<ul style="list-style-type: none"> <li>• Output tray lower limit switch (113-0472)</li> </ul>
CN7	Front	<ul style="list-style-type: none"> <li>• Exit motor (113-0502)</li> <li>• Main paddle motor (113-0510)</li> <li>• Output tray motor (113-0570)</li> <li>• Front tamper motor (113-0530)</li> </ul>	<ul style="list-style-type: none"> <li>• Output tray motor sensor (113-0473)</li> <li>• Main paddle home sensor (113-0370)</li> <li>• Front tamper home sensor (113-0390)</li> <li>• Paper holding sensor (113-0470)</li> <li>• Output tray top of stack sensor (113-0471)</li> </ul>	


**Table 6-23** Inner finisher system - PCA connectors, parts, and diagnostics information (continued)

CN No.	Connector name	Motor (Diagnostics)	Sensor (Diagnostics)	Switch & Solenoid (Diagnostics)
CN9	Paper holding solenoid			<ul style="list-style-type: none"> <li>• Paper holding solenoid (113-0591)</li> </ul>
CN10	Stapler position sensor		<ul style="list-style-type: none"> <li>• Stapler position sensor (mid front) (-)</li> <li>• Stapler position sensor (mid rear) (-)</li> </ul>	

## Service approach

Learn about the service approach of the inner finisher.

---

 **CAUTION:** When working on the product, do not pick up the unit by the output tray, which will detach under the weight of the product.

---



## Precautions when replacing parts

Learn about precautions when replacing parts.

## Precautions when replacing parts

Learn about precautions when replacing parts.

## Precautions when assembling and disassembling

- Use only HP approved replacement parts. Make sure that the part number, product name, voltage, and current or temperature ratings are correct. Failure to do so might result in damage to the machine, circuit overload, fire, or electric shock.
- Do not make unauthorized changes or additions to the printer. Unauthorized changes might cause the printer to malfunction and create electric shock or fire hazards.
- Use caution when dismantling the unit. Take note of the location of each screw or other part. This printer contains different kinds of screws. Using the wrong screw might lead to system failure, short circuit or electric shock.
- Do not disassemble the laser scanner assembly. Once the laser scanner assembly is disassembled, dust might enter the mirror chamber and will seriously degrade print quality. There are no serviceable parts inside the laser scanner assembly.
- Regularly check the condition of the power cable, plug and socket. Bad contacts might lead to overheating and fire. Damaged cables might lead to electric shock or unit malfunction.

## Precautions when handling PCAs

Static electricity might damage a PCA. Use approved, anti-static precautions when handling or storing a PCA. Service personnel should use grounded ESD straps and/or mats when handling PCAs.

- Precautions when moving and storing a PCA
  - Keep PCA in a conductive case, anti-static bag, or wrapped in aluminum foil.
  - Do not store a PCA where it is exposed to direct sunlight.
- Precautions when replacing a PCA
  - Disconnect power cables before disconnecting other cables.
  - Do not touch any soldered connections, connector terminals, or other electronic parts when handling insulated parts.
- Precautions when checking a PCA
  - Touch a grounded area of the printer chassis to discharge static electric charge before touching a PCA.
  - Do not touch a PCA with bare hands or metal objects. Doing so might create a short circuit or cause electric shock. Use caution when handling a PCA with moving parts such as sensors, motors, or lamps, as they might become very hot.

- Use caution when fitting and removing screws. Watch for hidden screens. Make sure that the correct screw is used and make sure that when toothed washers are removed, they are refitted in their original positions.
- Place the product on an ESD workstation or mat, or use an ESD strap (if one is available). If an ESD workstation, mat, or strap is not available, ground yourself by touching the sheet-metal chassis *before* touching an ESD-sensitive part.

### Releasing plastic latches

Many of the parts are held in place with plastic latches. The latches might easily break. Be careful when releasing them. To remove such parts, press the hook end of the latch away from the part to which it is latched.

### Precautions when handling PCA

Static electric might damage a PCA. Use approved, anti-static precautions when handling or storing a PCA. Service personnel should use grounded ESD straps and/or mats when handling PCAs.

- Precautions when moving and storing a PCA
  - Keep PCA in a conductive case, anti-static bag, or wrapped in aluminum foil.
  - Do not store a PCA where it is exposed to direct sunlight.
- Precautions when replacing a PCA
  - Disconnect power cables before disconnecting other cables.
  - Do not touch any soldered connections, connector terminals, or other electronic parts when handling insulated parts.
- Precautions when checking a PCA
  - Touch a grounded area of the printer chassis to discharge static electric charge before touching a PCA.
  - Do not touch a PCA with bare hands or metal objects. Doing so might create a short circuit or cause electric shock. Use caution when handling a PCA with moving parts such as sensors, motors, or lamps, as they might become very hot.
  - Use caution when fitting and removing screws. Watch for hidden screens. Make sure that the correct screw is used and make sure that when toothed washers are removed, they are refitted in their original positions.
  - Place the product on an ESD workstation or mat, or use an ESD strap (if one is available). If an ESD workstation, mat, or strap is not available, ground yourself by touching the sheet-metal chassis *before* touching an ESD-sensitive part.

### Releasing plastic latches

Learn about releasing plastic latches.

Many of the parts are held in place with plastic latches. The latches can break easily; release them carefully. To remove such parts, press the hook end of the latch away from the part to which it is latched.





## Before performing service

Learn what to do before performing service.

- Remove all paper from the product.
- Turn off the power using the power button.
- Unplug the power cable and interface cable or cables.
- Place the product on an ESD workstation or mat, or use an ESD strap (if one is available). If an ESD workstation, mat, or strap is not available, ground yourself by touching the sheet-metal chassis *before* touching an ESD-sensitive part.
- Remove the toner cartridges.
- Remove the Tray 2 cassette.

## ESD precautions

Learn the importance of electrostatic discharge.

 **CAUTION:**  Some parts are sensitive to electrostatic discharge (ESD). Look for the ESD reminder when removing printer parts. Always perform service work at an ESD-protected workstation or mat. If an ESD workstation or mat is not available, touch the sheet-metal chassis to provide a static ground *before* touching an ESD-sensitive assembly.

Protect the ESD-sensitive assemblies by placing them in ESD pouches when they are out of the printer.

## After performing service

Learn what to do after performing service.

- Verify that the service performed was successful.
- Verify that the most recent firmware is installed on the printer.
- Verify that all parts are correctly reinstalled and are properly working.
- Print any pages necessary to verify that the repair resolved the issue and did not create any new issues.
- Verify that the printer is in better condition than when you arrived, cosmetically and electrically.

## Post-service test

Perform the following tests to verify that the repair or replacement was successful:

### Print-quality test

Learn about the print-quality test.

1. Verify that you have completed the necessary reassembly steps.
2. Make sure that the tray contains clean, unmarked paper.
3. Attach the power cord and interface cable or interface cables, and then turn on the product.
4. Print a configuration page.
5. Print a print quality page, and then verify that there are no lines, streaks, banding, or other print quality defects.
6. Send a print job from the host computer, and then verify that the output meets expectations.

## Order parts by authorized service providers

Find information about ordering parts and supplies for the printer.

### Ordering

Order parts by authorized service providers.

**Table 6-24 Ordering**

Item or provider	Description
Order supplies and paper	<a href="http://www.hp.com/go/suresupply">www.hp.com/go/suresupply</a>
Order parts from authorized service providers	<a href="http://www.hp.com/buy/parts">www.hp.com/buy/parts</a> or <a href="http://partsurfer.hp.com">partsurfer.hp.com</a>
Order through service or support providers	Contact an HP-authorized service or support provider.
Order using the HP Embedded Web Server (EWS)	To access, in a supported web browser on your computer, enter the printer IP address or host name in the address/URL field. The EWS contains a link to the HP SureSupply web site, which provides options for purchasing Original HP supplies.

### Orderable parts


Not all of the parts shown in the exploded assembly diagrams are orderable parts.

Refer to the tables following the diagrams or the alphabetical/numerical parts lists to determine if a part is orderable.

## Parts, diagrams, removal and replacement (inner finisher)

Learn about parts, diagrams, removal and replacement (inner finisher)



**NOTE:**  Some parts are sensitive to electrostatic discharge (ESD). Always perform service work at an ESD-protected workstation or mat. If an ESD workstation or mat is not available, touch the sheet-metal chassis to provide a static ground before touching an ESD-sensitive assembly. Protect the ESD-sensitive assemblies by placing them in ESD pouches when they are out of the printer.

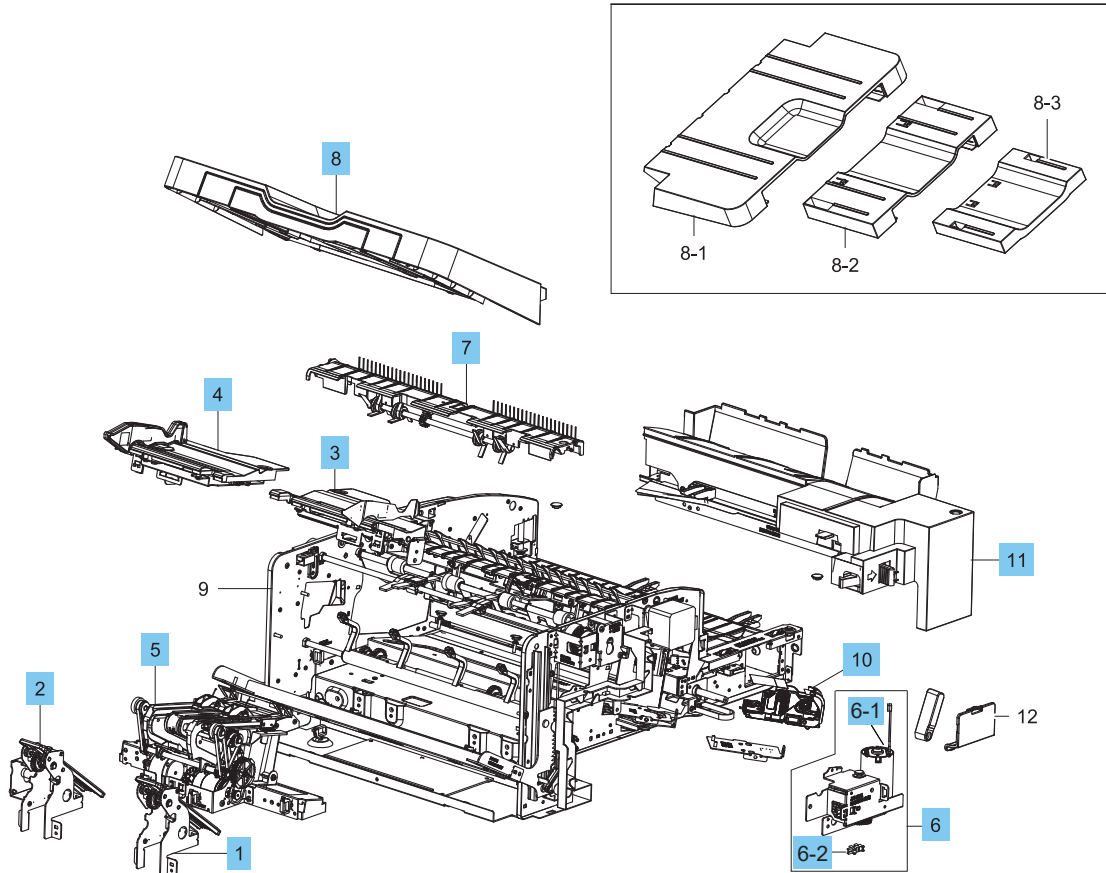
## Parts and diagrams (inner finisher)

View inner finisher exploded diagrams and parts lists.

### Inner finisher (main)

Parts diagram and parts list for the inner finisher (main).

Figure 6-50 Inner finisher (main)



**Table 6-25 Inner finisher (main)**

Ref	Part number	Description	Qty
Complete	Y1G00-67901	Inner finisher whole unit	1
1	JC90-01310A	Front paper support	1
2	JC90-01311A	Rear paper support	1
3	JC82-00899A	Front tamper unit assembly	1
4	JC82-00900A	Rear tamper unit assembly	1
5	SS456-61001	Ejector	1
6	JC90-01334B	Output tray motor assembly	1
6-1	JC31-00178B	Output tray motor	1
6-2	0604-001393	Output tray motor sensor	1
7	JC90-01336A	Sub paddle unit	1
8	JC90-01337B	Output tray	1
10	JC81-07408B	Staple cartridge	1
11	JC90-01343B	Punch cover	1
Not shown	JC39-02169A	Main interface harness	1

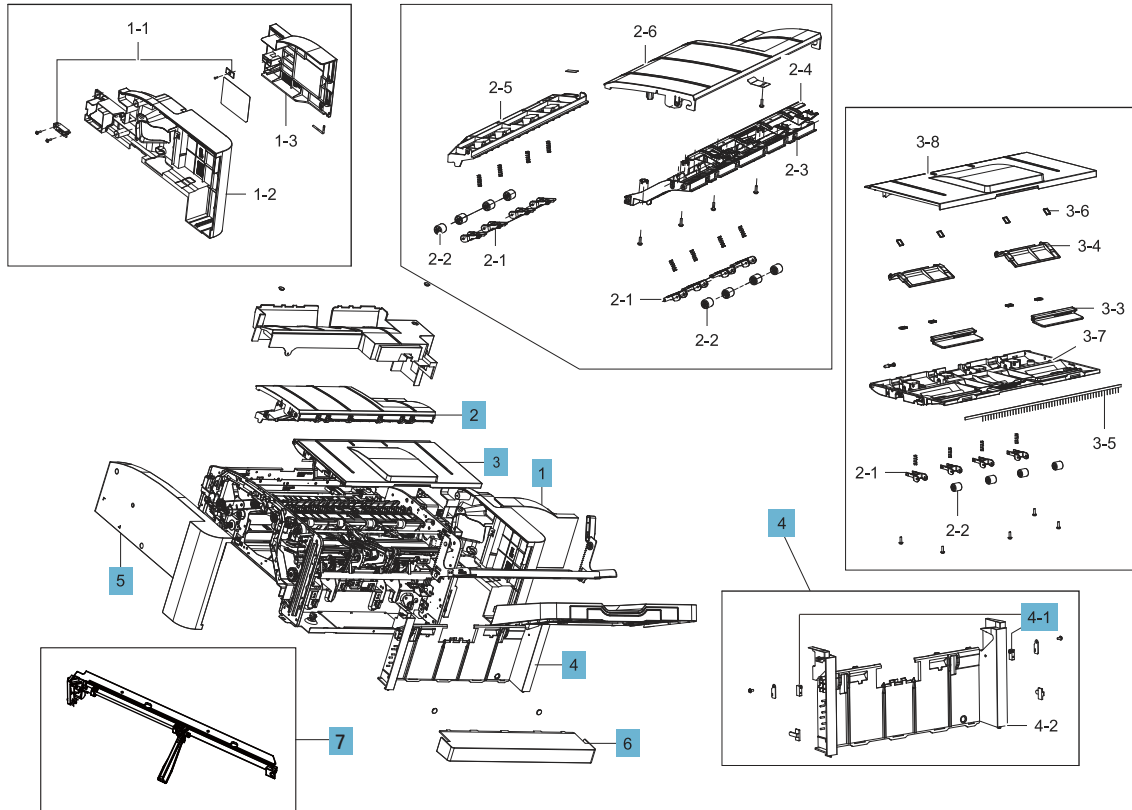




## Inner finisher (covers)

Parts diagram and parts list for the inner finisher (covers)

Figure 6-51 Inner finisher (covers)



**Table 6-26 Inner finisher (covers)**

Ref	Part number	Description	Qty
1	JC90-01321B	Front cover	1
2	JC90-01322B	Middle cover	1
3	JC90-01323B	Top cover	1
4	JC90-01324B	Left cover	1
4-1	JC82-01039A	Output tray top of stack sensor kit	1
5	JC63-04750B	Rear cover	1
6	JC63-04792B	PCA cover	1
7	JC90-01546A	Exit bin full	1



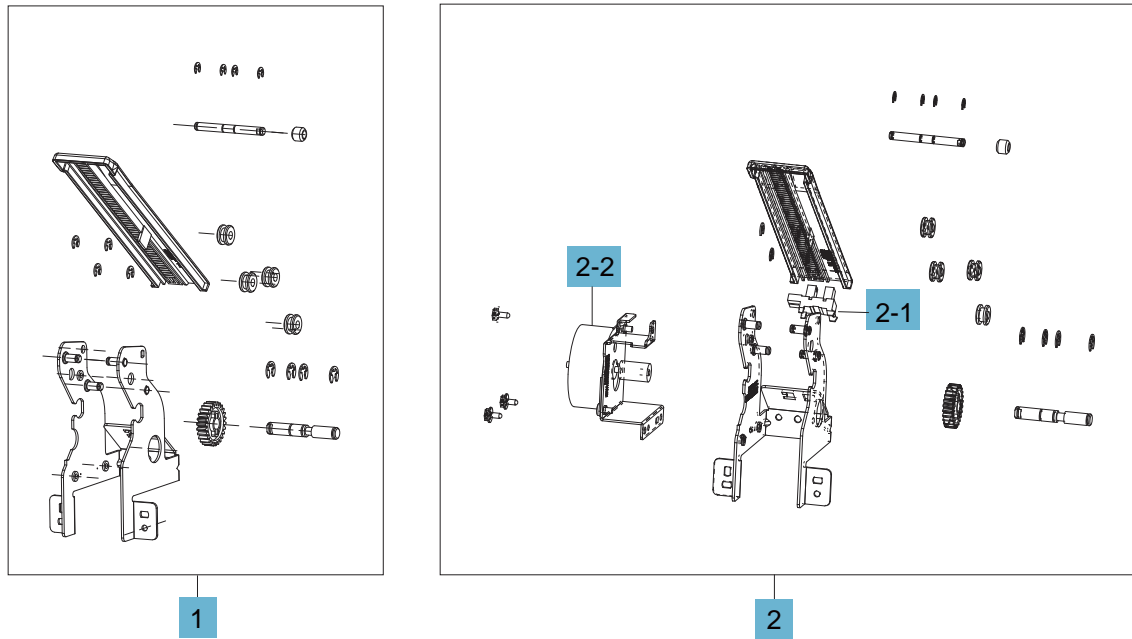
**Table 6-27 Inner finisher (main paddle unit, entrance unit, exit unit, paper holding unit, and output tray unit)**

Ref	Part number	Description	Qty
1	0604-001393	Main paddle home sensor	2
2	JC92-02774B	Main PCA	1
4	6602-003644	Entrance motor timing belt	1
5	JC82-01038A	Paddle kit	1
5-1	JC63-04957A	Paddle A	2
5-2	JC63-04958A	Paddle B	2
5-3	JC81-07560A	Paddle holder	4
8-1	JC66-04243A	Entrance roller	1
8-2	JC66-04243A	Middle roller	1
10	JC90-01344A	Entrance motor assembly	1
13	JC66-04199A	Exit sensor actuator	1
14	JC90-01313A	Paper holding actuator	1
15	JC90-01314A	Paper holding kit	1
15-1	JC33-00037A	Paper holding solenoid	1
15-2	0604-001393	Paper holding sensor	1
16	JC90-01320A	Output tray lower limit switch	1
16-3	JC66-04200A	Output tray lower limit switch actuator	1
17	JC93-01001A	Main paddle motor assembly	1
17-1	JC31-00149A	Main paddle motor	1
19-1	JC66-04244A	Exit roller	1
19-2	JC61-07449A	Front compile guide	1
19-3	JC61-07450A	Rear compile guide	1
20	JC90-01331A	Exit motor assembly	1
20-1	JC31-00169B	Exit motor	1
21	JC90-01319A	Output tray frame	1
22	JC92-02780A	Rear joint PCA	1
23 shown	JC90-01334B	Output tray motor assembly	1
23-1	JC31-00178B	Output tray motor	1
23-2	0604-001393	Output tray motor sensor	1
24	0604-001415	Exit sensor	1

## Inner finisher (paper support unit)

Parts diagram and parts list for the inner finisher (paper support unit).

Figure 6-53 Inner finisher (paper support unit)



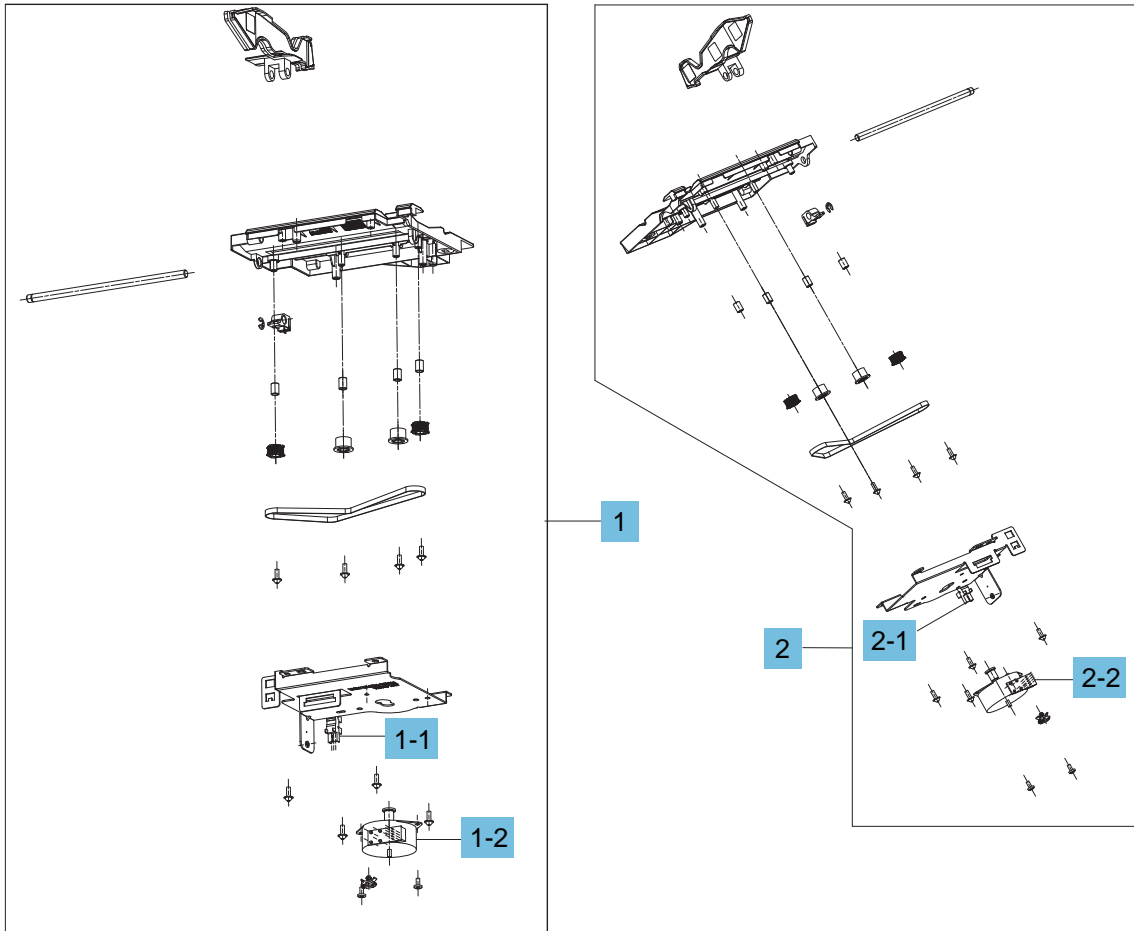
**Table 6-28** Inner finisher (paper support unit)

Ref	Part number	Description	Qty
1	JC90-01310A	Front paper support	1
2	JC90-01311A	Rear paper support	1
2-1	0604-001393	Paper support home sensor	1
2-2	JC93-00802B	Paper support motor assembly	1

## Inner finisher (tamper unit)

Parts diagram and parts list for the inner finisher (tamper unit).

Figure 6-54 Inner finisher (tamper unit)





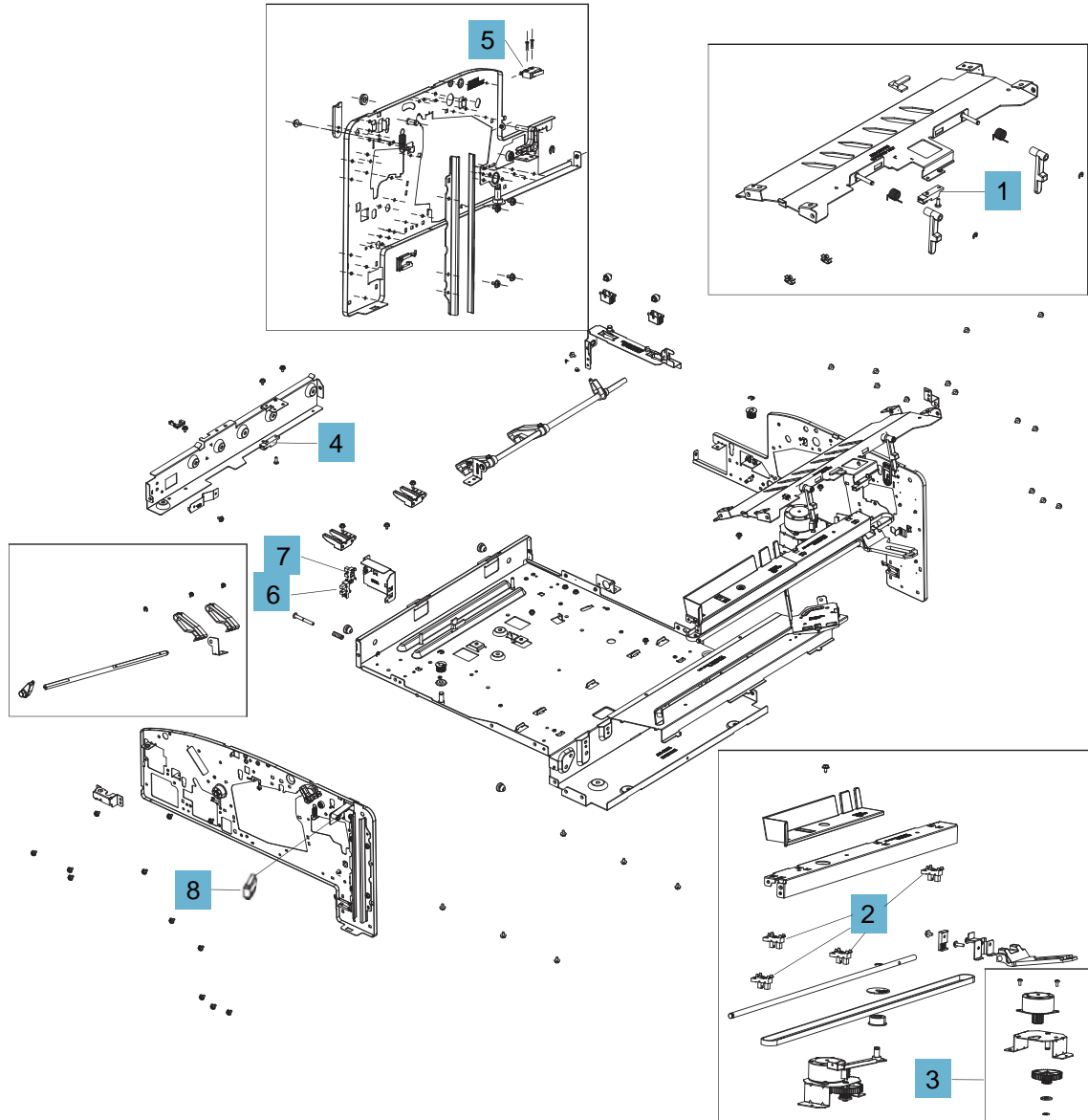
**Table 6-29 Inner finisher (tamper unit)**

Ref	Part number	Description	Qty
1	JC82-00900A	Rear tamper unit	1
1-1	0604-001393	Rear tamper home sensor	1
1-2	JC93-01001A	Rear tamper motor assembly	1
2	JC82-00899A	Front tamper unit	1
2-1	0604-001393	Front tamper home sensor	1
2-2	JC93-01001A	Front tamper motor assembly	1

## Inner finisher (stapler unit, end fence unit)

Parts diagram and parts list for the inner finisher (stapler unit, end fence unit).

Figure 6-55 Inner finisher (stapler unit, end fence unit)



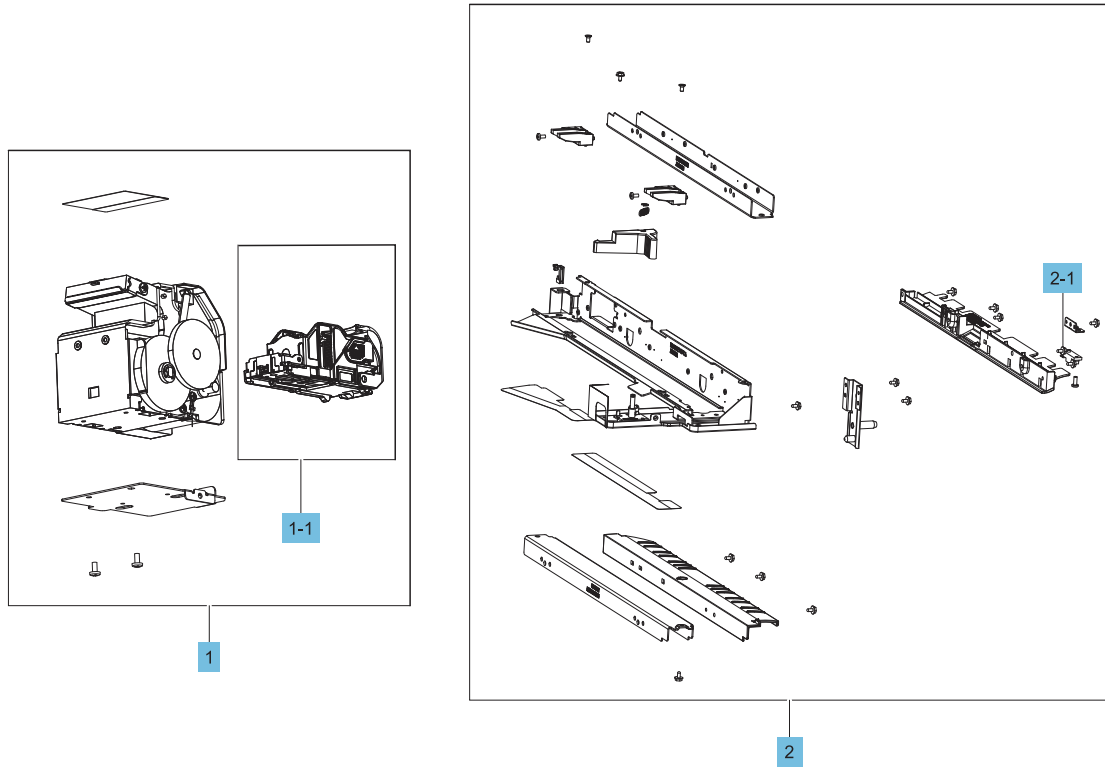
**Table 6-30** Inner finisher (stapler unit, end fence unit)

Ref	Part number	Description	Qty
1	0604-001381	End fence sensor	1
2	0604-001393	Stapler position sensor	1
3	JC93-00999A	Stapler position motor	1
4	0604-001381	Punch waste full sensor	1
5	JC39-01610A	Top cover switch	1
6	0604-001393	Finisher docking sensor	1
7	0604-001393	Punch waste box sensor	1
8	JC39-01610A	Compile cover switch	1

## Inner finisher (stapler assembly, entrance unit)

Parts diagram and parts list for the inner finisher (stapler assembly, entrance unit).

Figure 6-56 Inner finisher (stapler assembly, entrance unit)



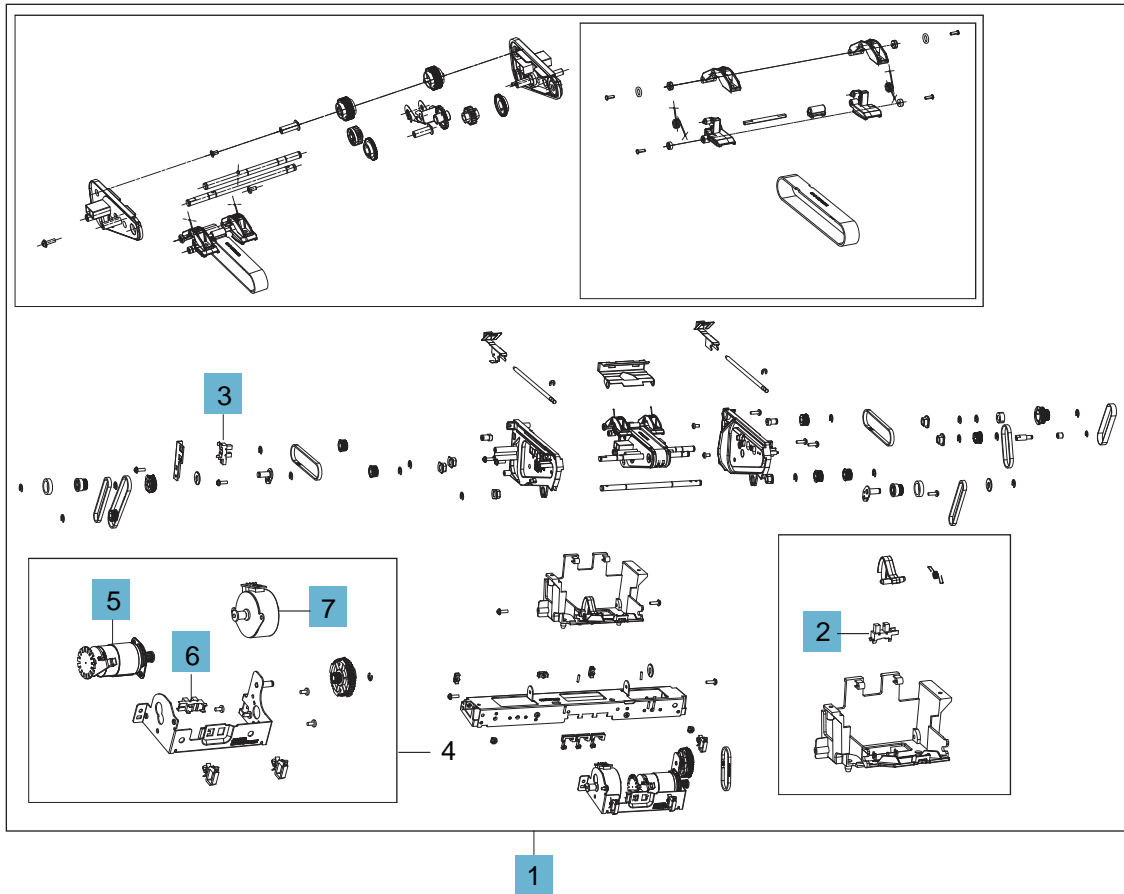
**Table 6-31** Inner finisher (stapler assembly, entrance unit)

Ref	Part number	Description	Qty
1	JC59-00040A	Stapler assembly	1
1-1	JC81-07408B	Staple cartridge	1
2	JC90-01343B	Punch cover	1
2-1	0604-001381	Entrance sensor	1
Not shown	SS465-67001	Punch PBA 2-4 hole	1
Not shown	SS467-67001	Punch PBA 2-3 hole	1
Not shown	SS466-67001	Punch PBA Swedish	1

## Inner finisher (ejector unit)

Parts diagram and parts list for the inner finisher (ejector unit).

Figure 6-57 Inner finisher (ejector unit)



**Table 6-32 Inner finisher (ejector unit)**

Ref	Part number	Description	Qty
1	SS456-61001	Ejector	1
2	0604-001393	Ejector2 home sensor	1
3	0604-001393	Ejector1 home sensor	1
4	JC90-01309A	Ejector motor assembly	1
5	JC93-01168A	Ejector2 motor assembly	1
6	0604-001393	Ejector2 motor sensor	1
7	JC93-00998A	Ejector1 motor assembly	1

## Covers




## Removal and replacement: Front cover (C1)

Learn how to remove and replace the front cover.

To view tear down and reassembling video of the inner finisher, click the link below.

 [View a tear down video of the inner finisher.](#)

 [View a reassembling video of the inner finisher.](#)

 **IMPORTANT:** When applicable, special installation instructions are provided for an assembly at the end of the removal procedure. Always completely read the removal instructions and follow all special installation instructions.

Mean time to repair:

Service level:

### Before performing service

#### Turn the printer power off

- Press the power button on the front of the printer, and then turn off the power switch next to the power cable.
- A shutting-down message appears on the control-panel display.

 **WARNING!** To avoid damage to the printer, turn the power off and wait until the printer shuts down before removing the power cable.

- Disconnect the printer power cable after the printer has completely shut down (the control-panel display is blank).

Use the table below to identify the correct part number for your printer. To order the part, go to <http://www.hp.com/buy/parts>.

Table 6-33 Part information

Part number	Part description
JC90-01321B	Front cover

### Required tools

- #2 JIS screwdriver with a magnetic tip

### After performing service

#### Turn the printer power on

- Connect the power cable.
- Use the power switch to turn the power on.

### Post service test

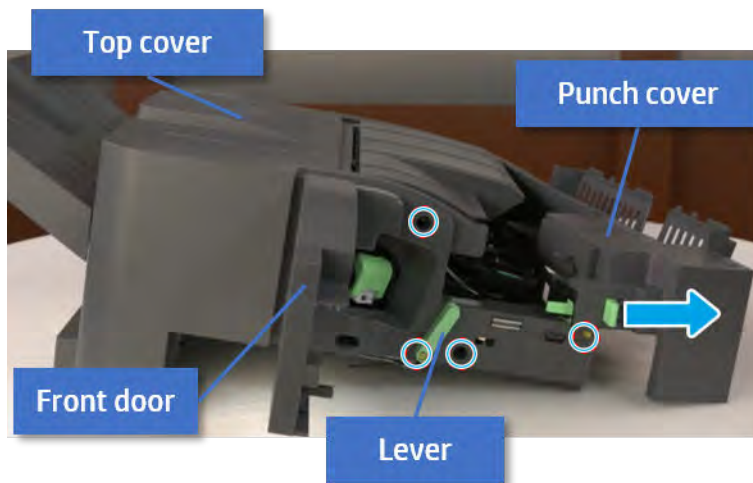
Print any pages necessary to verify that the repair resolved the issue and did not create any new issues.

## Remove the front cover

Follow these steps to remove the front cover.

1. Open the front door and open the punch cover.
2. Remove three screws in the front.
3. Remove the lever.
4. Open the top cover.
5. From the right side of the front cover, carefully lift and pry toward the top-left corner to remove the front cover.

Figure 6-58 Remove the front cover



## Unpack the replacement assembly

Follow these steps to unpack the replacement assembly.

1. Dispose of the defective part.



---

 **NOTE:** HP recommends responsible disposal of the defective part.


<http://www8.hp.com/us/en/hp-information/environment/product-recycling.html>

---

2. Unpack the replacement part from the packaging.


 **CAUTION:**  Some parts are sensitive to electrostatic discharge (ESD). Always perform service work at an ESD-protected workstation or mat. If an ESD workstation or mat is not available, touch the sheet-metal chassis to provide a static ground before touching an ESD-sensitive assembly. Protect the ESD-sensitive assemblies by placing them in ESD pouches when they are out of the printer.

 **IMPORTANT:** Make sure that all of the shipping materials (for example shipping tape) are removed from the replacement part prior to installation.

 **NOTE:** If the replacement part is a roller or pad, avoid touching the spongy part of it. Skin oils on the roller or pad can cause paper pickup and/or print-quality problems. HP recommends using disposable gloves when handling rollers or pads or washing your hands before touching rollers or pads.

---

3. To install an assembly, reverse the removal steps.

 **NOTE:** When applicable, special installation instructions are provided for an assembly at the end of the removal procedure. Always completely read the removal instructions and follow all special installation instructions.

---

## Removal and replacement: Rear cover (C8)


Learn how to remove and replace the rear cover.

To view teardown and reassembling video of the inner finisher, click the link below.

 [View a teardown video of the inner finisher.](#)

 [View a reassembling video of the inner finisher.](#)

---

 **IMPORTANT:** When applicable, special installation instructions are provided for an assembly at the end of the removal procedure. Always completely read the removal instructions and follow all special installation instructions.

---

Mean time to repair:


Service level:

### Before performing service

#### Turn the printer power off

- Press the power button on the front of the printer, and then turn off the power switch next to the power cable.
- A shutting-down message appears on the control-panel display.

---

 **WARNING!** To avoid damage to the printer, turn the power off and wait until the printer shuts down before removing the power cable.

---

- Disconnect the printer power cable after the printer has completely shut down (the control-panel display is blank).

Use the table below to identify the correct part number for your printer. To order the part, go to <http://www.hp.com/buy/parts>.

Table 6-34 Part information

Part number	Part description
JC63-04750B	Rear cover

### Required tools

- #2 JIS screwdriver with a magnetic tip

### After performing service

#### Turn the printer power on

- Connect the power cable.
- Use the power switch to turn the power on.

### Post service test

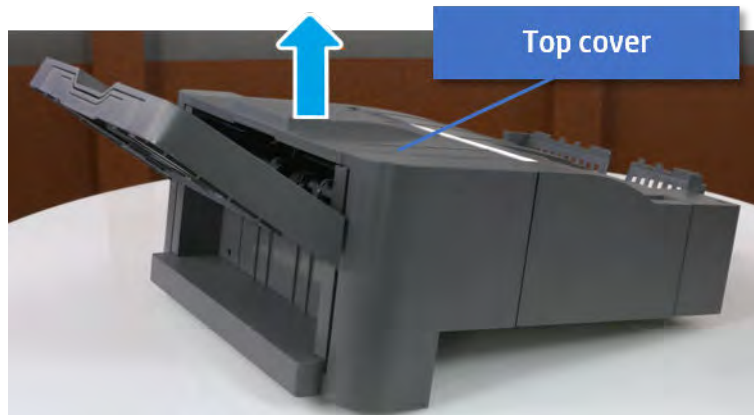
Print any pages necessary to verify that the repair resolved the issue and did not create any new issues.

## Remove the rear cover

Follow these steps to remove the rear cover.

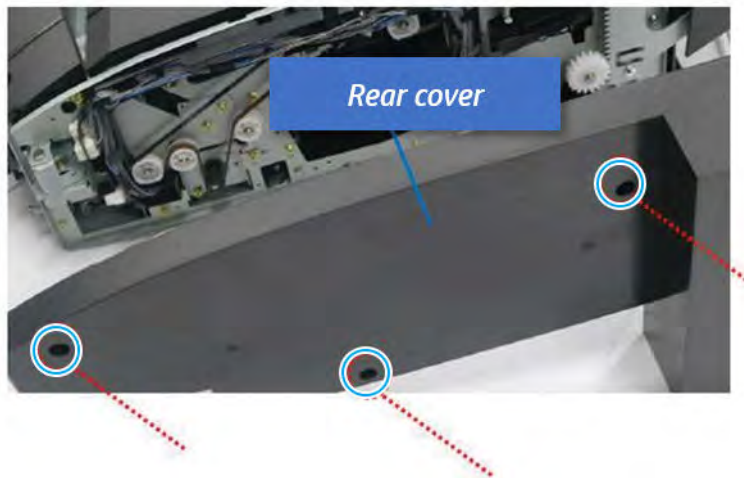
1. Open the top cover.

Figure 6-59 Open the top cover



2. Remove three screws.
3. Release hooks carefully and remove the rear cover.

Figure 6-60 Remove the rear cover



## Unpack the replacement assembly

Follow these steps to unpack the replacement assembly.

1. Dispose of the defective part.



---


 **NOTE:** HP recommends responsible disposal of the defective part.


<http://www8.hp.com/us/en/hp-information/environment/product-recycling.html>

---

2. Unpack the replacement part from the packaging.


 **CAUTION:**  Some parts are sensitive to electrostatic discharge (ESD). Always perform service work at an ESD-protected workstation or mat. If an ESD workstation or mat is not available, touch the sheet-metal chassis to provide a static ground before touching an ESD-sensitive assembly. Protect the ESD-sensitive assemblies by placing them in ESD pouches when they are out of the printer.

 **IMPORTANT:** Make sure that all of the shipping materials (for example shipping tape) are removed from the replacement part prior to installation.

 **NOTE:** If the replacement part is a roller or pad, avoid touching the spongy part of it. Skin oils on the roller or pad can cause paper pickup and/or print-quality problems. HP recommends using disposable gloves when handling rollers or pads or washing your hands before touching rollers or pads.

---

3. To install an assembly, reverse the removal steps.

 **NOTE:** When applicable, special installation instructions are provided for an assembly at the end of the removal procedure. Always completely read the removal instructions and follow all special installation instructions.

---

## Removal and replacement: Middle cover (C3)


Learn how to remove and replace the middle cover.

To view teardown and reassembling video of the inner finisher, click the link below.

 [View a teardown video of the inner finisher.](#)

 [View a reassembling video of the inner finisher.](#)

---

 **IMPORTANT:** When applicable, special installation instructions are provided for an assembly at the end of the removal procedure. Always completely read the removal instructions and follow all special installation instructions.

---

Mean time to repair:

Service level:

### Before performing service

#### Turn the printer power off

- Press the power button on the front of the printer, and then turn off the power switch next to the power cable.
- A shutting-down message appears on the control-panel display.

---

 **WARNING!** To avoid damage to the printer, turn the power off and wait until the printer shuts down before removing the power cable.

---

- Disconnect the printer power cable after the printer has completely shut down (the control-panel display is blank).

Use the table below to identify the correct part number for your printer. To order the part, go to <http://www.hp.com/buy/parts>.

**Table 6-35** Part information

Part number	Part description
JC90-01322B	Middle cover

### Required tools

- #2 JIS screwdriver with a magnetic tip

### After performing service

#### Turn the printer power on

- Connect the power cable.
- Use the power switch to turn the power on.

### Post service test

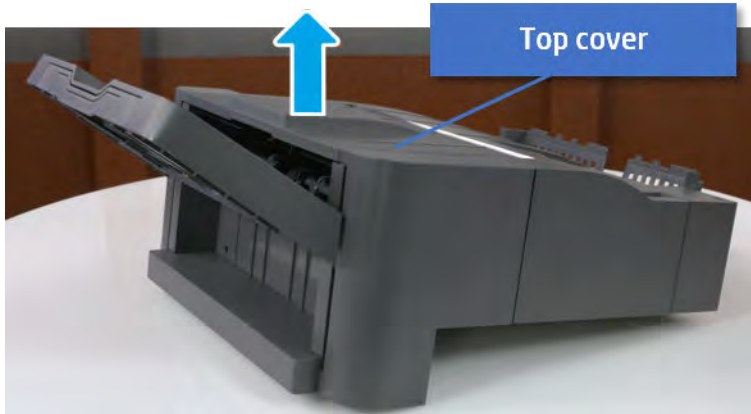
Print any pages necessary to verify that the repair resolved the issue and did not create any new issues.

## Remove the rear cover

Follow these steps to remove the rear cover.

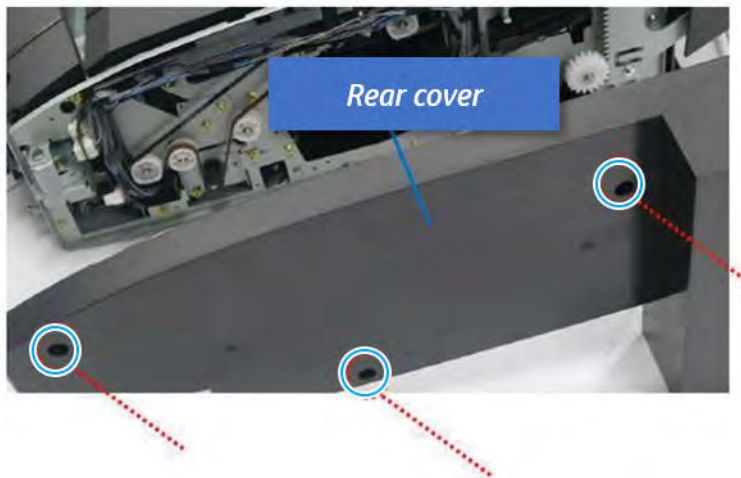
1. Open the top cover.

Figure 6-61 Open the top cover



2. Remove three screws.
3. Release hooks carefully and remove the rear cover.

Figure 6-62 Remove the rear cover



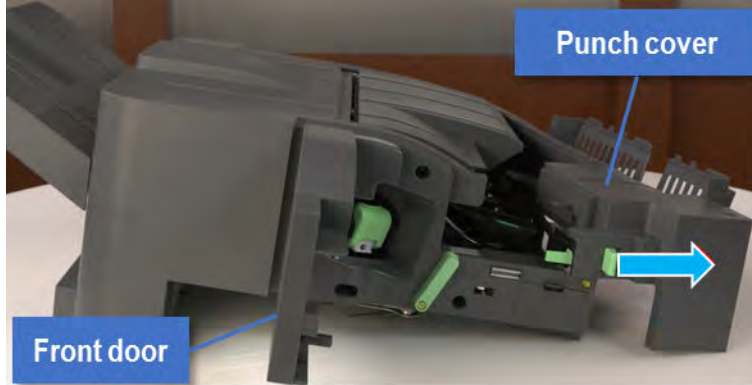
## Remove the middle cover

Follow these steps to remove the middle cover.

1. Open the front door and then open the punch cover.

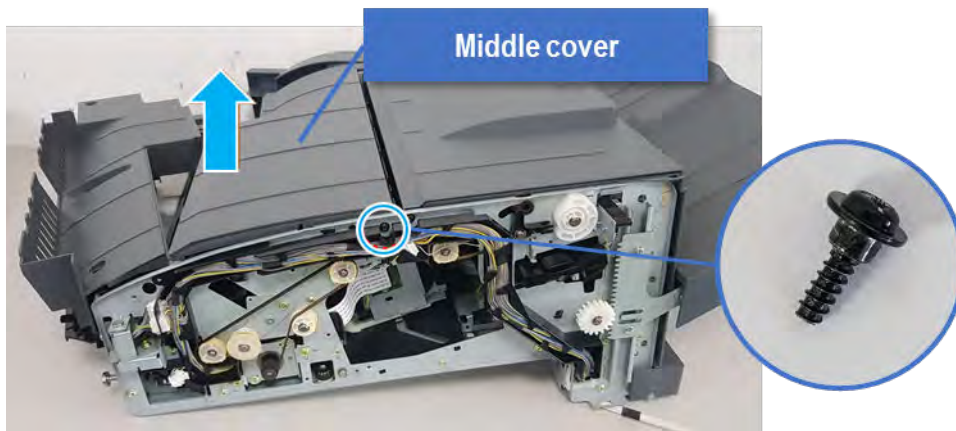


Figure 6-63 Open the front door and punch cover



2. Remove left-side one screw at the rear of the inner finisher, and then remove the middle cover by lifting off the hinge pins at the front.

Figure 6-64 Remove the middle cover



### Unpack the replacement assembly

Follow these steps to unpack the replacement assembly.

1. Dispose of the defective part.

---

 **NOTE:** HP recommends responsible disposal of the defective part.

<http://www8.hp.com/us/en/hp-information/environment/product-recycling.html>

---

2. Unpack the replacement part from the packaging.


 **CAUTION:**  Some parts are sensitive to electrostatic discharge (ESD). Always perform service work at an ESD-protected workstation or mat. If an ESD workstation or mat is not available, touch the sheet-metal chassis to provide a static ground before touching an ESD-sensitive assembly. Protect the ESD-sensitive assemblies by placing them in ESD pouches when they are out of the printer.

 **IMPORTANT:** Make sure that all of the shipping materials (for example shipping tape) are removed from the replacement part prior to installation.

 **NOTE:** If the replacement part is a roller or pad, avoid touching the spongy part of it. Skin oils on the roller or pad can cause paper pickup and/or print-quality problems. HP recommends using disposable gloves when handling rollers or pads or washing your hands before touching rollers or pads.

---

3. To install an assembly, reverse the removal steps.

 **NOTE:** When applicable, special installation instructions are provided for an assembly at the end of the removal procedure. Always completely read the removal instructions and follow all special installation instructions.

---


## Removal and replacement: Top cover (C2)

Learn how to remove and replace the top cover.

To view teardown and reassembling video of the inner finisher, click the link below.

 [View a teardown video of the inner finisher.](#)

 [View a reassembling video of the inner finisher.](#)

 **IMPORTANT:** When applicable, special installation instructions are provided for an assembly at the end of the removal procedure. Always completely read the removal instructions and follow all special installation instructions.

Mean time to repair:

Service level:

### Before performing service

#### Turn the printer power off

- Press the power button on the front of the printer, and then turn off the power switch next to the power cable.
- A shutting-down message appears on the control-panel display.

 **WARNING!** To avoid damage to the printer, turn the power off and wait until the printer shuts down before removing the power cable.

- Disconnect the printer power cable after the printer has completely shut down (the control-panel display is blank).

Use the table below to identify the correct part number for your printer. To order the part, go to <http://www.hp.com/buy/parts>.

Table 6-36 Part information

Part number	Part description
JC90-01323B	Top cover

### Required tools

- #2 JIS screwdriver with a magnetic tip

### After performing service

#### Turn the printer power on

- Connect the power cable.
- Use the power switch to turn the power on.

### Post service test

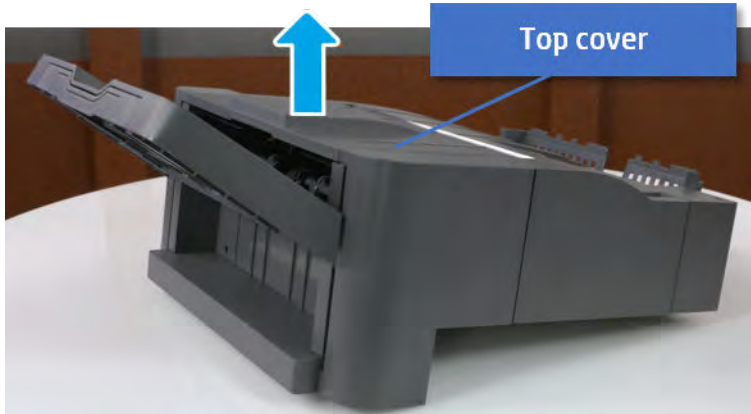
Print any pages necessary to verify that the repair resolved the issue and did not create any new issues.

## Remove the rear cover

Follow these steps to remove the rear cover.

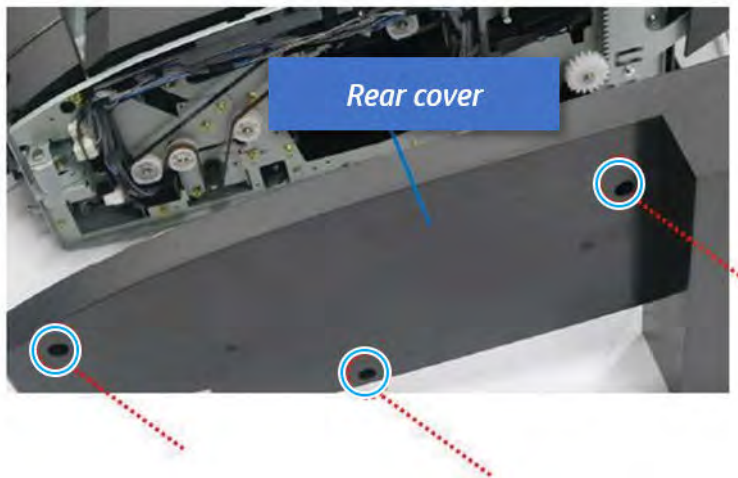
1. Open the top cover.

Figure 6-65 Open the top cover



2. Remove three screws.
3. Release hooks carefully and remove the rear cover.

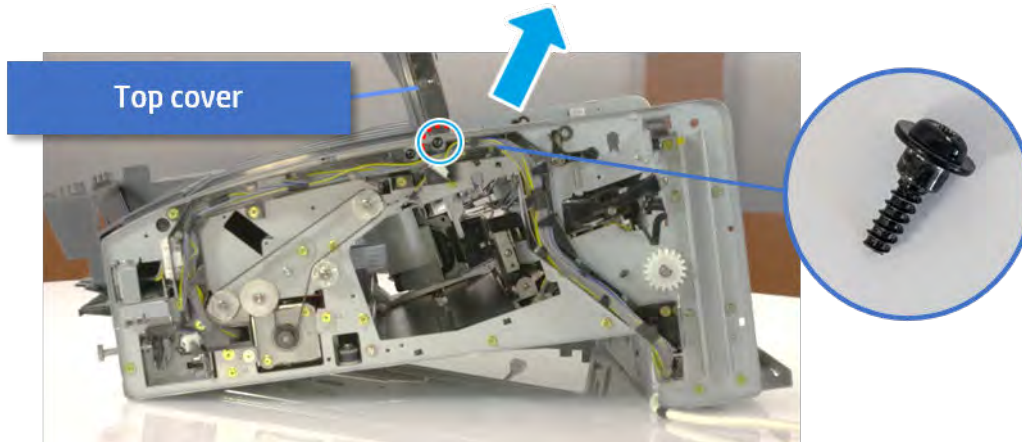
Figure 6-66 Remove the rear cover



## Remove the top cover

Follow these steps to remove the top cover.

Figure 6-67 Remove the top cover



- ▲ Remove one screw at the rear of the inner finisher, and then remove the top cover by lifting off the hinge pins at the front.

### Unpack the replacement assembly

Follow these steps to unpack the replacement assembly.

1. Dispose of the defective part.




**NOTE:** HP recommends responsible disposal of the defective part.

<http://www8.hp.com/us/en/hp-information/environment/product-recycling.html>

2. Unpack the replacement part from the packaging.



**CAUTION:**  Some parts are sensitive to electrostatic discharge (ESD). Always perform service work at an ESD-protected workstation or mat. If an ESD workstation or mat is not available, touch the sheet-metal chassis to provide a static ground before touching an ESD-sensitive assembly. Protect the ESD-sensitive assemblies by placing them in ESD pouches when they are out of the printer.



**IMPORTANT:** Make sure that all of the shipping materials (for example shipping tape) are removed from the replacement part prior to installation.



**NOTE:** If the replacement part is a roller or pad, avoid touching the spongy part of it. Skin oils on the roller or pad can cause paper pickup and/or print-quality problems. HP recommends using disposable gloves when handling rollers or pads or washing your hands before touching rollers or pads.

3. To install an assembly, reverse the removal steps.



**NOTE:** When applicable, special installation instructions are provided for an assembly at the end of the removal procedure. Always completely read the removal instructions and follow all special installation instructions.

## Removal and replacement: PCA cover (C6)


Learn how to remove and replace the PCA cover.

To view teardown and reassembling video of the inner finisher, click the link below.

 [View a teardown video of the inner finisher.](#)

 [View a reassembling video of the inner finisher.](#)

---

 **IMPORTANT:** When applicable, special installation instructions are provided for an assembly at the end of the removal procedure. Always completely read the removal instructions and follow all special installation instructions.

---

Mean time to repair:


Service level:

### Before performing service

#### Turn the printer power off

- Press the power button on the front of the printer, and then turn off the power switch next to the power cable.
- A shutting-down message appears on the control-panel display.

---

 **WARNING!** To avoid damage to the printer, turn the power off and wait until the printer shuts down before removing the power cable.

---

- Disconnect the printer power cable after the printer has completely shut down (the control-panel display is blank).

Use the table below to identify the correct part number for your printer. To order the part, go to <http://www.hp.com/buy/parts>.

Table 6-37 Part information

Part number	Part description
JC63-04792B	PCA cover

### Required tools

- #2 JIS screwdriver with a magnetic tip

### After performing service

#### Turn the printer power on

- Connect the power cable.
- Use the power switch to turn the power on.

### Post service test

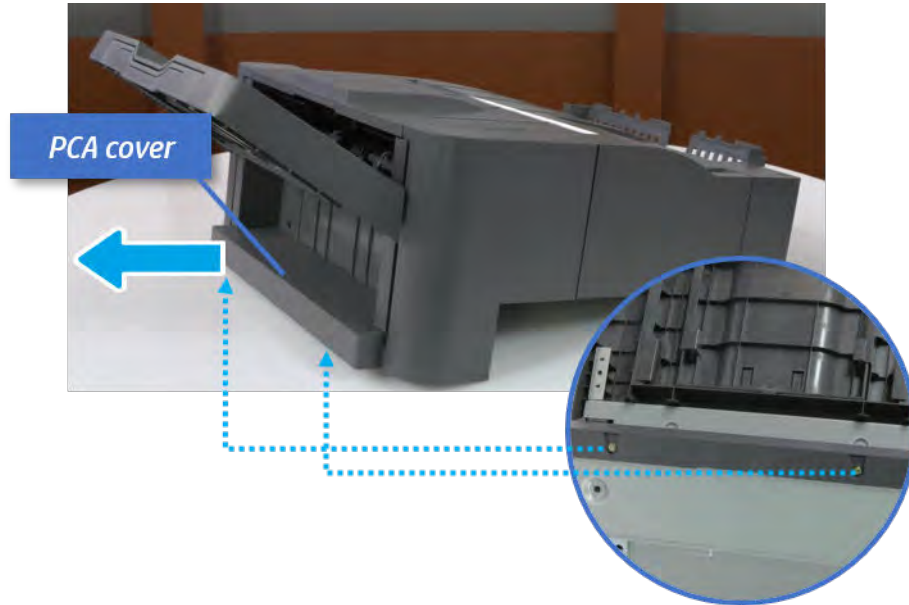
Print any pages necessary to verify that the repair resolved the issue and did not create any new issues.

## Remove the PCA cover

Follow these steps to remove the PCA cover.

- ▲ Remove two screws, and then remove the PCA cover.

Figure 6-68 Remove the PCA cover



## Unpack the replacement assembly



Follow these steps to unpack the replacement assembly.


1. Dispose of the defective part.


 **NOTE:** HP recommends responsible disposal of the defective part.

<http://www8.hp.com/us/en/hp-information/environment/product-recycling.html>


2. Unpack the replacement part from the packaging.

 **CAUTION:**  Some parts are sensitive to electrostatic discharge (ESD). Always perform service work at an ESD-protected workstation or mat. If an ESD workstation or mat is not available, touch the sheet-metal chassis to provide a static ground before touching an ESD-sensitive assembly. Protect the ESD-sensitive assemblies by placing them in ESD pouches when they are out of the printer.

 **IMPORTANT:** Make sure that all of the shipping materials (for example shipping tape) are removed from the replacement part prior to installation.

 **NOTE:** If the replacement part is a roller or pad, avoid touching the spongy part of it. Skin oils on the roller or pad can cause paper pickup and/or print-quality problems. HP recommends using disposable gloves when handling rollers or pads or washing your hands before touching rollers or pads.

3. To install an assembly, reverse the removal steps.

 **NOTE:** When applicable, special installation instructions are provided for an assembly at the end of the removal procedure. Always completely read the removal instructions and follow all special installation instructions.

## Removal and replacement: Left cover (C7)


Learn how to remove and replace the left cover.

To view teardown and reassembling video of the inner finisher, click the link below.

 [View a teardown video of the inner finisher.](#)

 [View a reassembling video of the inner finisher.](#)

---

 **IMPORTANT:** When applicable, special installation instructions are provided for an assembly at the end of the removal procedure. Always completely read the removal instructions and follow all special installation instructions.

---

Mean time to repair:


Service level:

### Before performing service

#### Turn the printer power off

- Press the power button on the front of the printer, and then turn off the power switch next to the power cable.
- A shutting-down message appears on the control-panel display.

---

 **WARNING!** To avoid damage to the printer, turn the power off and wait until the printer shuts down before removing the power cable.

---

- Disconnect the printer power cable after the printer has completely shut down (the control-panel display is blank).

Use the table below to identify the correct part number for your printer. To order the part, go to <http://www.hp.com/buy/parts>.

Table 6-38 Part information

Part number	Part description
JC90-01324B	Left cover

### Required tools

- #2 JIS screwdriver with a magnetic tip

### After performing service

#### Turn the printer power on

- Connect the power cable.
- Use the power switch to turn the power on.

### Post service test

Print any pages necessary to verify that the repair resolved the issue and did not create any new issues.

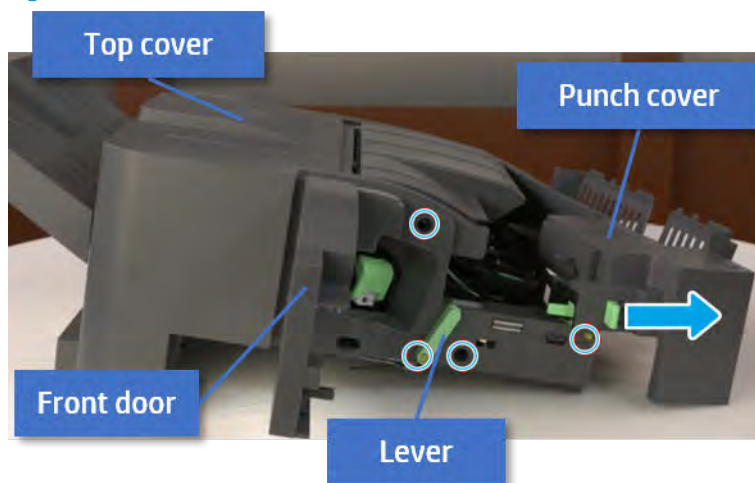


## Remove the front cover

Follow these steps to remove the front cover:

1. Open the front door and open the punch cover.
2. Remove three screws in the front.
3. Remove the lever.
4. Open the top cover.
5. From the right side of the front cover, carefully lift and pry toward the top-left corner to remove the front cover.

Figure 6-69 Remove the front cover

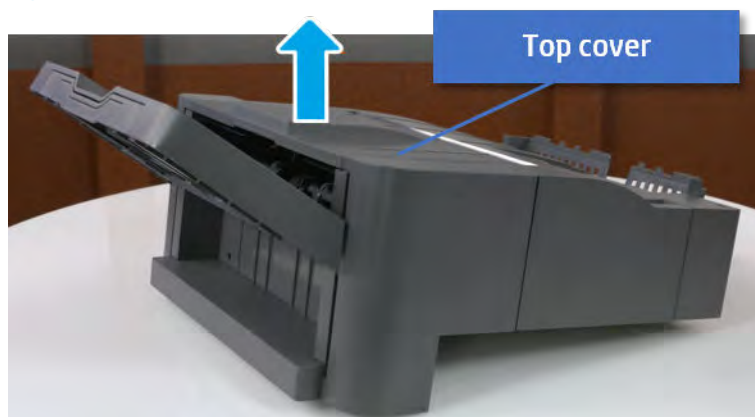


## Remove the rear cover

Follow these steps to remove the rear cover:

1. Open the top cover.

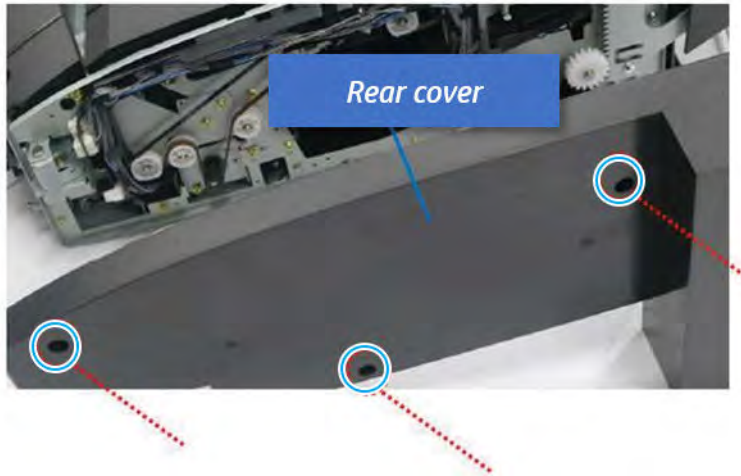
Figure 6-70 Open the top cover



2. Remove three screws.

3. Release hooks carefully and remove the rear cover.

**Figure 6-71** Remove the rear cover

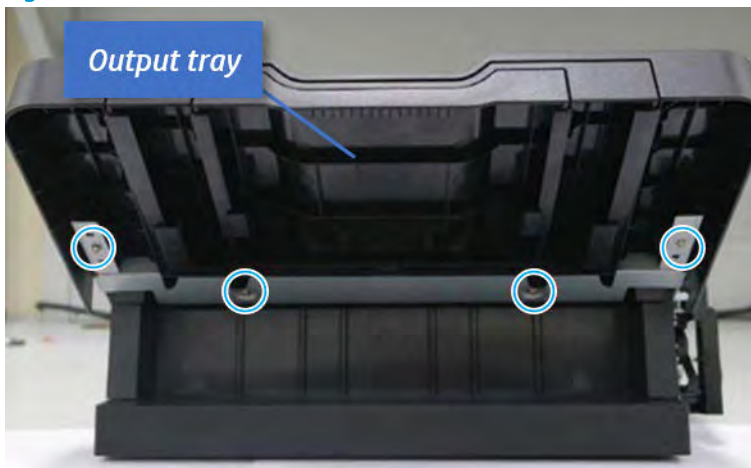


### Remove the output tray

Follow these steps to remove the output tray.

1. Remove four screws.

**Figure 6-72** Remove four screws



2. Push the paper holding actuator into the inner finisher, and then remove the output tray.

Figure 6-73 Remove the output tray.

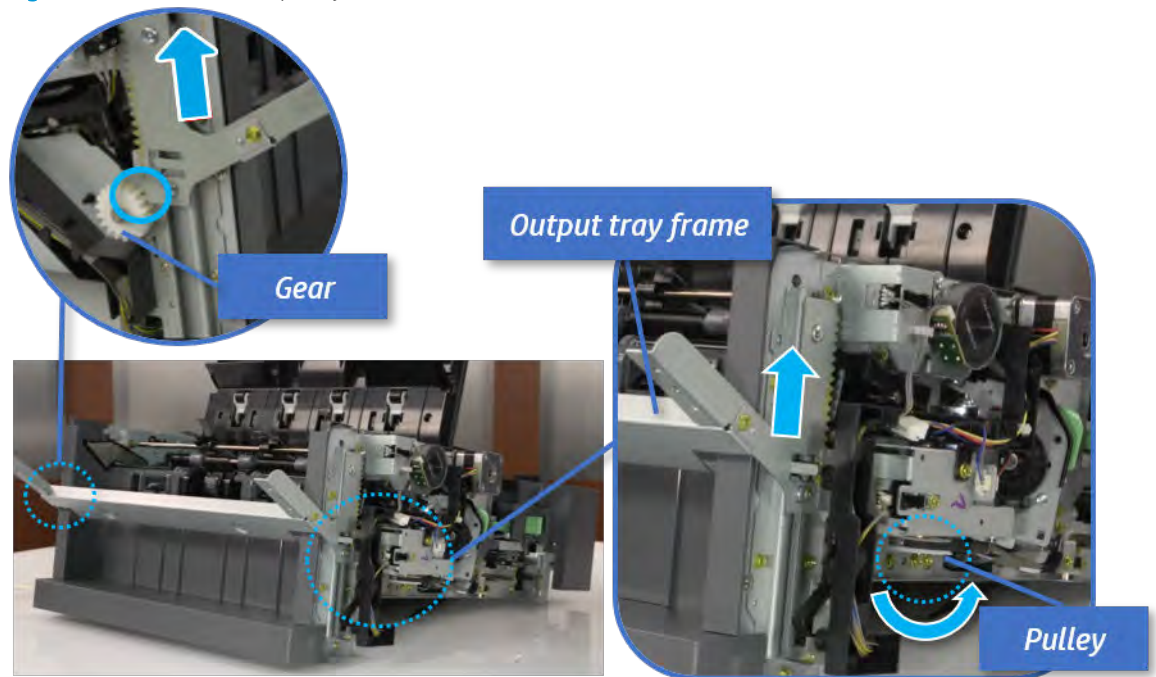


### Remove the output tray frame

Follow these steps to remove the output tray frame.

1. Rotate the pulley until the output tray frame depart from the gear.

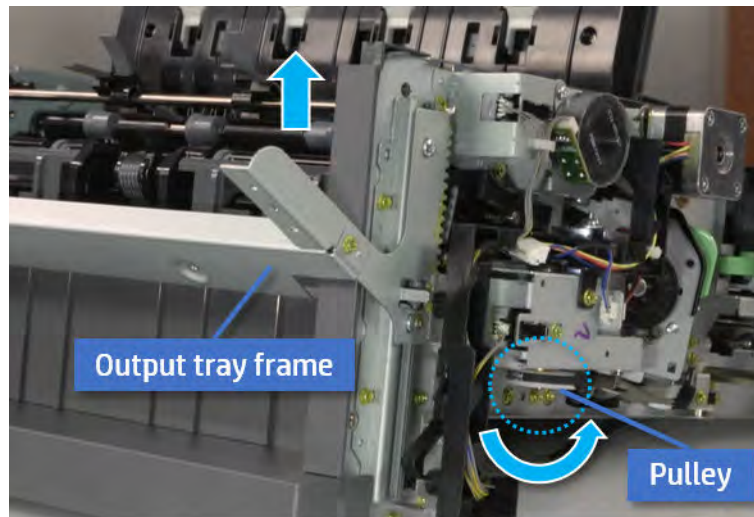
Figure 6-74 Remove the pulley



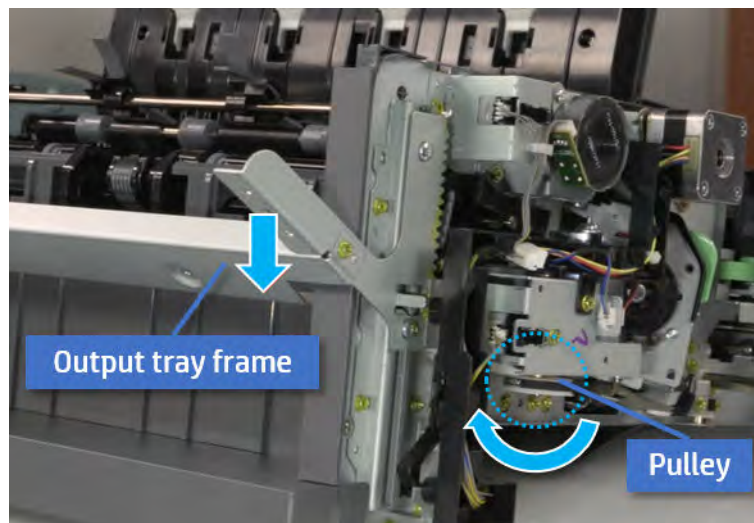
2. Push the paper holding actuator into the inner finisher, and then remove the output tray frame.



- d. Rotate the pulley until the output tray frame is no longer lifted. It can make to level the output tray frame.



- e. Rotate the pulley in the opposite direction.

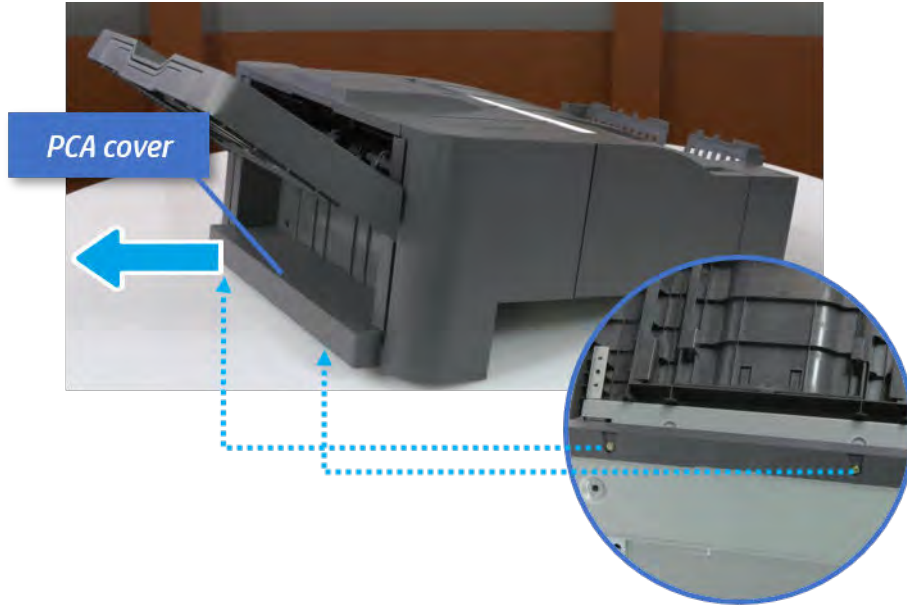


### Remove the PCA cover

Follow these steps to remove the PCA cover.

- ▲ Remove two screws, and then remove the PCA cover.

Figure 6-76 Remove the PCA cover

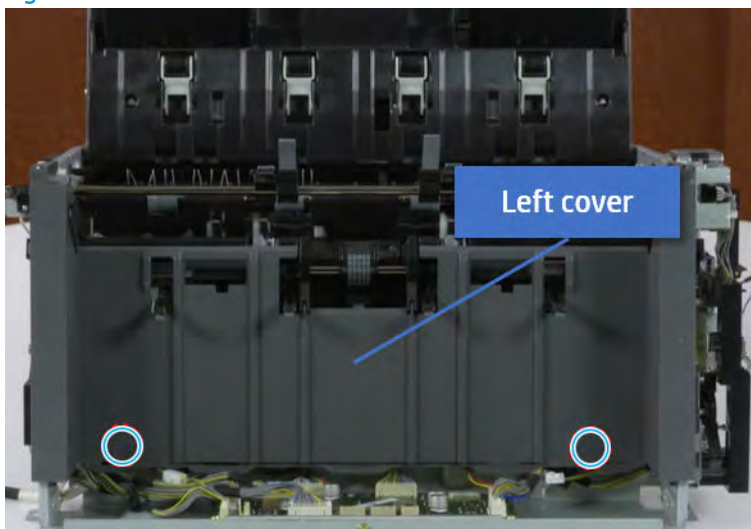


### Remove the left cover

Follow these steps to remove the left cover.

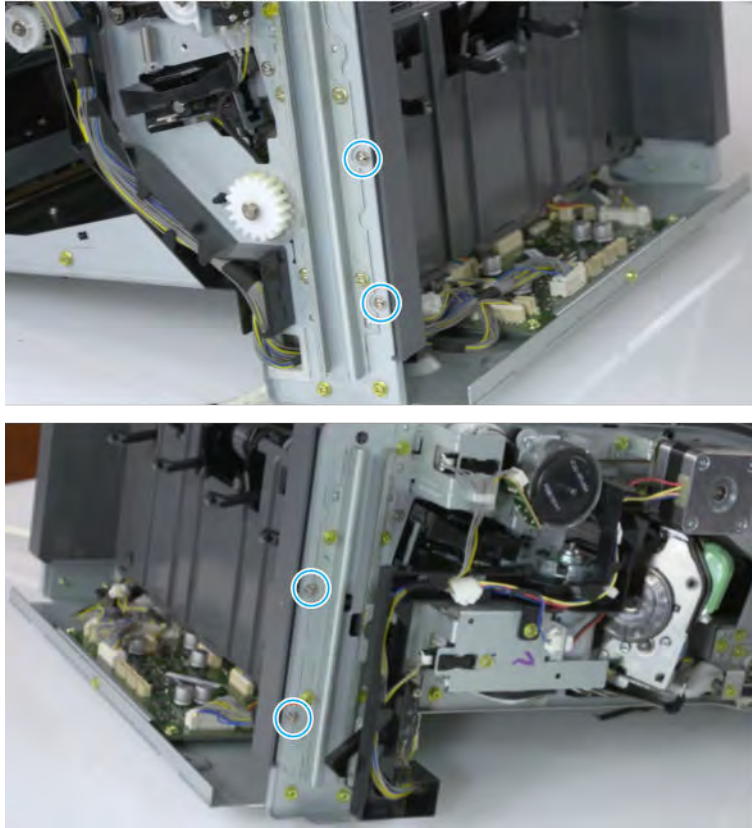
1. Remove two screws.

Figure 6-77 Remove two screws



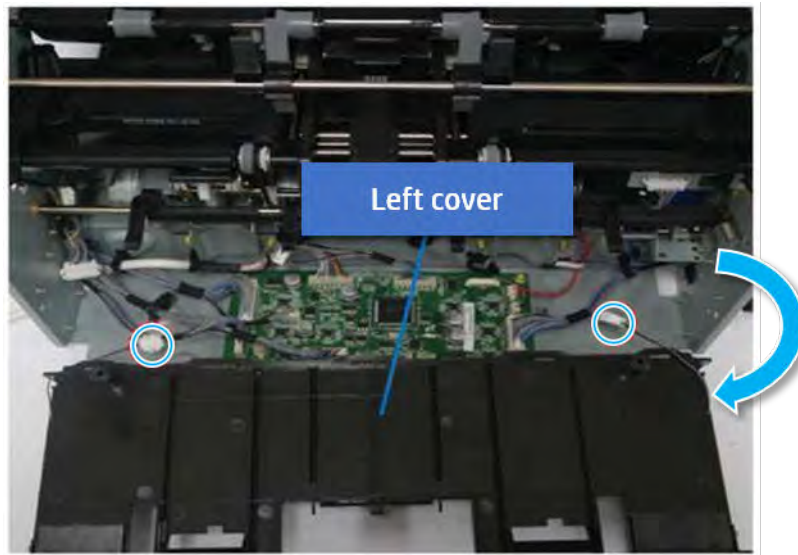
2. Remove four screws from both front and rear sides.


Figure 6-78 Remove four screws

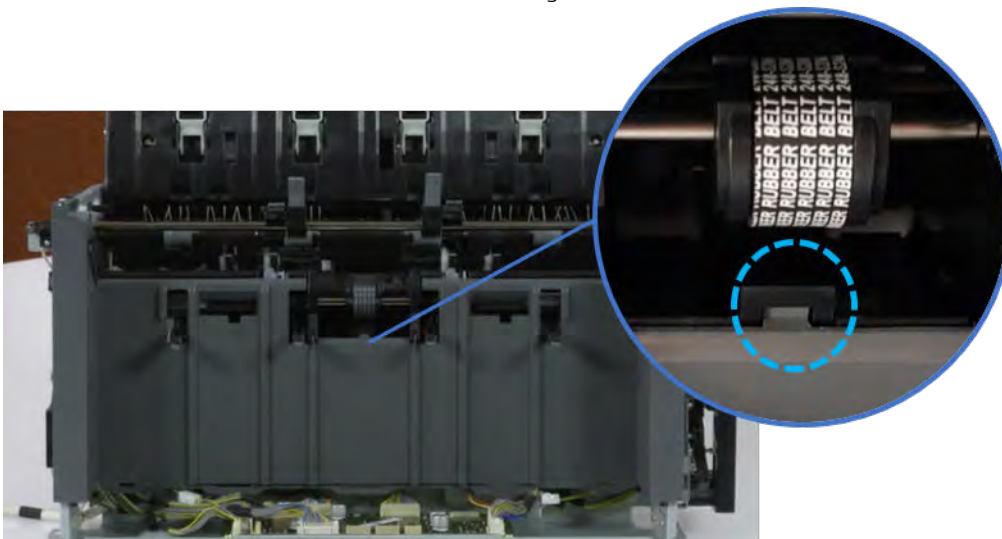


3. Unplug two inline connectors, and then remove the left cover.

Figure 6-79 Unplug two connectors



 **TIP:** Be sure to check the hook when reassembling.



### Unpack the replacement assembly

Follow these steps to unpack the replacement assembly.

1. Dispose of the defective part.





---

 **NOTE:** HP recommends responsible disposal of the defective part.


<http://www8.hp.com/us/en/hp-information/environment/product-recycling.html>

---

2. Unpack the replacement part from the packaging.


 **CAUTION:**  Some parts are sensitive to electrostatic discharge (ESD). Always perform service work at an ESD-protected workstation or mat. If an ESD workstation or mat is not available, touch the sheet-metal chassis to provide a static ground before touching an ESD-sensitive assembly. Protect the ESD-sensitive assemblies by placing them in ESD pouches when they are out of the printer.

 **IMPORTANT:** Make sure that all of the shipping materials (for example shipping tape) are removed from the replacement part prior to installation.

 **NOTE:** If the replacement part is a roller or pad, avoid touching the spongy part of it. Skin oils on the roller or pad can cause paper pickup and/or print-quality problems. HP recommends using disposable gloves when handling rollers or pads or washing your hands before touching rollers or pads.

---

3. To install an assembly, reverse the removal steps.

 **NOTE:** When applicable, special installation instructions are provided for an assembly at the end of the removal procedure. Always completely read the removal instructions and follow all special installation instructions.

---

## Entrance unit

## Removal and replacement: Entrance sensor (S1)


Learn how to remove and replace the entrance sensor.

To view teardown and reassembling video of the inner finisher, click the link below.

 [View a teardown video of the inner finisher.](#)

 [View a reassembling video of the inner finisher.](#)

---

 **IMPORTANT:** When applicable, special installation instructions are provided for an assembly at the end of the removal procedure. Always completely read the removal instructions and follow all special installation instructions.

---

Mean time to repair:


Service level:

### Before performing service

#### Turn the printer power off

- Press the power button on the front of the printer, and then turn off the power switch next to the power cable.
- A shutting-down message appears on the control-panel display.

---

 **WARNING!** To avoid damage to the printer, turn the power off and wait until the printer shuts down before removing the power cable.

---

- Disconnect the printer power cable after the printer has completely shut down (the control-panel display is blank).

Use the table below to identify the correct part number for your printer. To order the part, go to [www.hp.com/buy/parts](http://www.hp.com/buy/parts).

**Table 6-39** Part information

Part number	Part description
0604-001381	Entrance sensor

### Required tools

- #2 JIS screwdriver with a magnetic tip

### After performing service

#### Turn the printer power on

- Connect the power cable.
- Use the power switch to turn the power on.

### Post service test

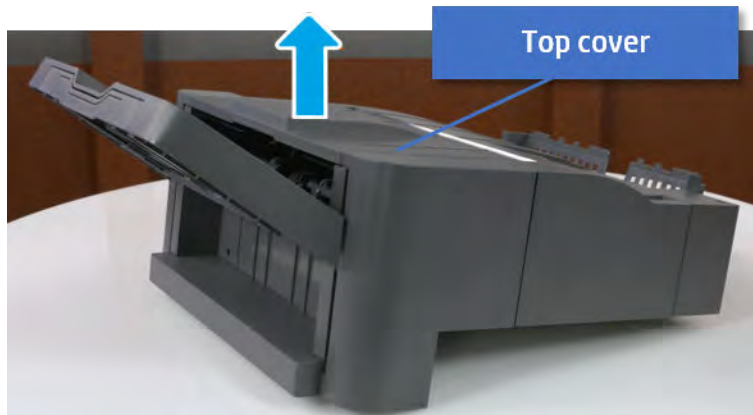
Print any pages necessary to verify that the repair resolved the issue and did not create any new issues.

## Remove the rear cover

Follow these steps to remove the rear cover.

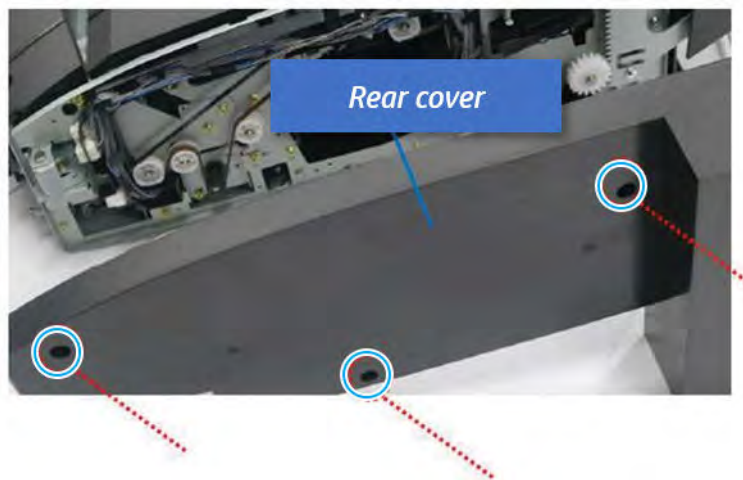
1. Open the top cover.

Figure 6-80 Open the top cover



2. Remove three screws.
3. Release hooks carefully and remove the rear cover.

Figure 6-81 Remove the rear cover

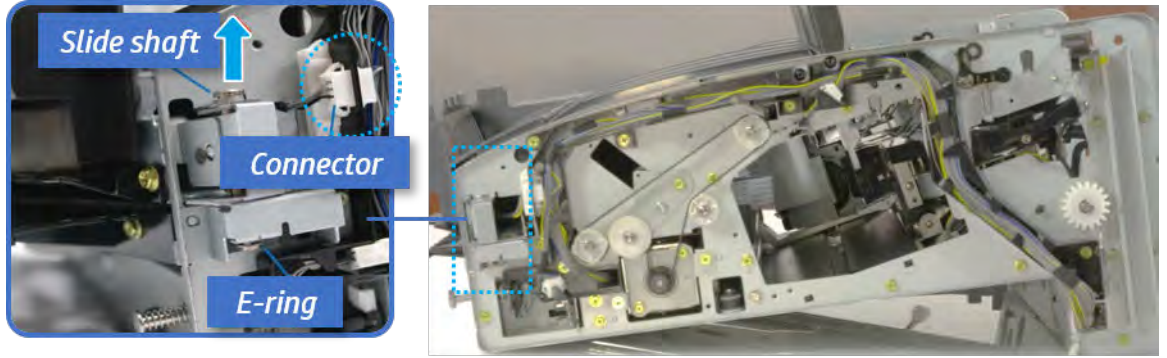


## Remove the punch cover

Follow these steps to remove the punch cover.

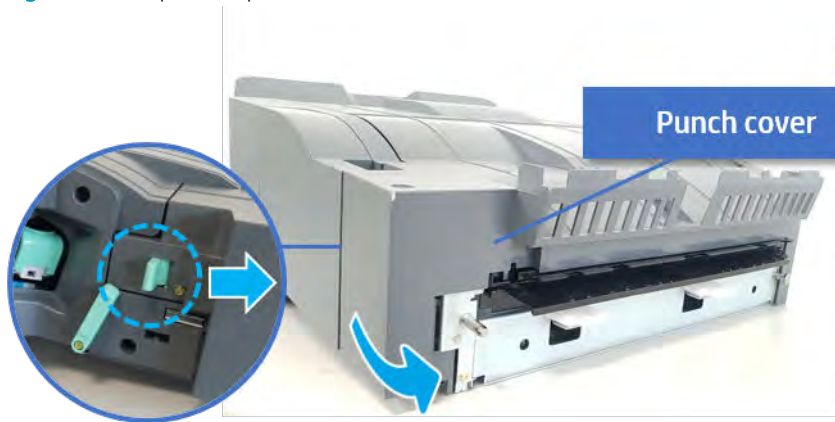
1. Unplug the connector. Remove the e-ring, and then remove the slide shaft at the rear of the inner finisher.

Figure 6-82 Remove the slide shaft



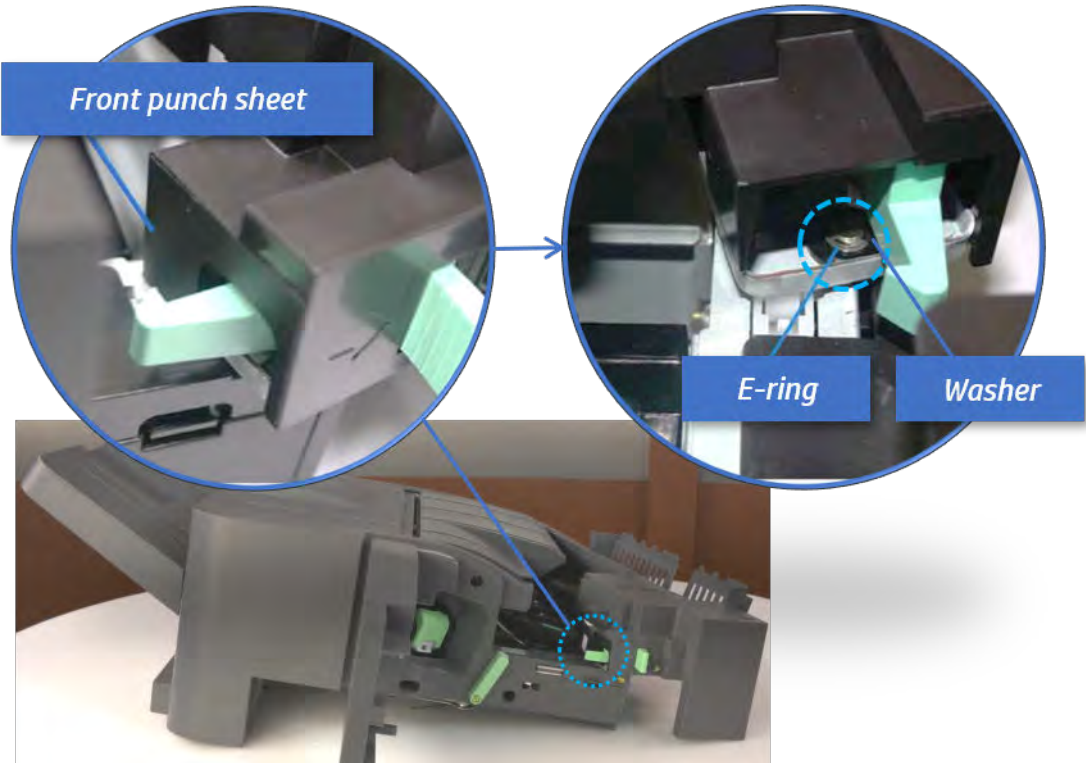
2. Open the punch cover.

Figure 6-83 Open the punch cover



3. Remove the front punch sheet, and then remove the e-ring and the washer. And then remove the punch cover.

Figure 6-84 Remove the punch cover

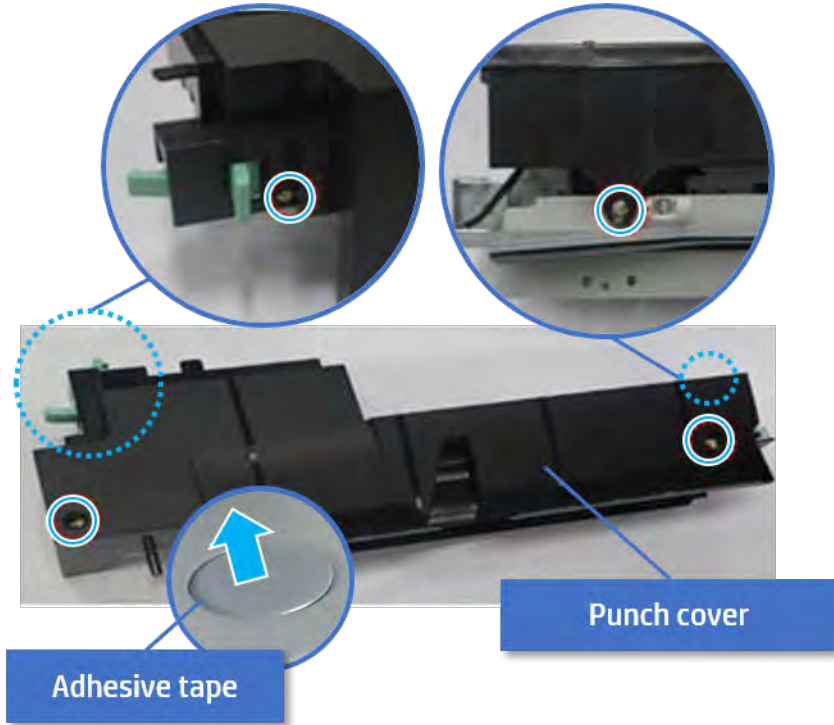


#### Remove the entrance sensor

Follow these steps to remove the entrance sensor.

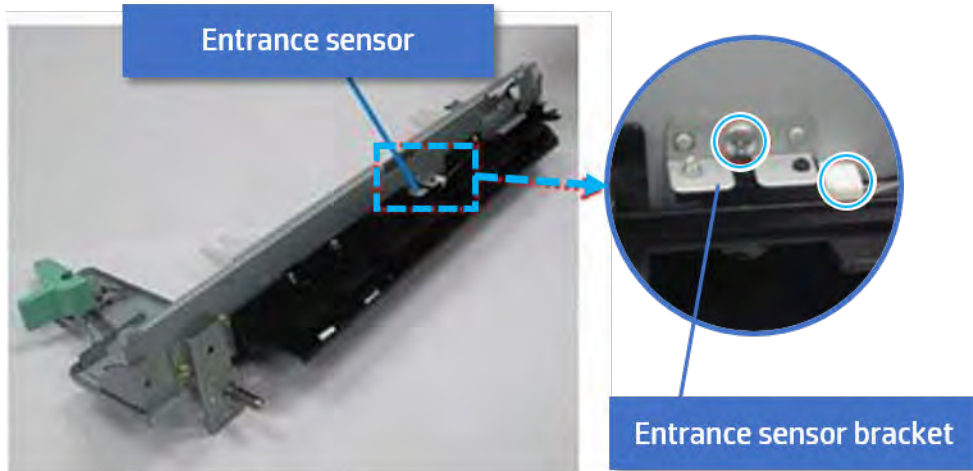
1. Loosen the adhesive tape around, and then remove four screws. And then remove the punch cover.

Figure 6-85 Remove the punch cover



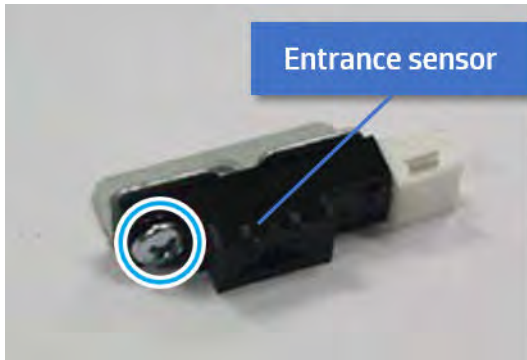
2. Remove one screw, unplug the connector, and then remove the entrance sensor bracket.

Figure 6-86 Remove the entrance sensor bracket



3. Remove one screw, and then remove the sensor.

**Figure 6-87** Remove the entrance sensor



### Unpack the replacement assembly

Follow these steps to unpack the replacement assembly.

1. Dispose of the defective part.

---



 **NOTE:** HP recommends responsible disposal of the defective part.

<http://www8.hp.com/us/en/hp-information/environment/product-recycling.html>


---

2. Unpack the replacement part from the packaging.

---

 **CAUTION:**  Some parts are sensitive to electrostatic discharge (ESD). Always perform service work at an ESD-protected workstation or mat. If an ESD workstation or mat is not available, touch the sheet-metal chassis to provide a static ground before touching an ESD-sensitive assembly. Protect the ESD-sensitive assemblies by placing them in ESD pouches when they are out of the printer.


 **IMPORTANT:** Make sure that all of the shipping materials (for example shipping tape) are removed from the replacement part prior to installation.

 **NOTE:** If the replacement part is a roller or pad, avoid touching the spongy part of it. Skin oils on the roller or pad can cause paper pickup and/or print-quality problems. HP recommends using disposable gloves when handling rollers or pads or washing your hands before touching rollers or pads.

---

3. To install an assembly, reverse the removal steps.

---

 **NOTE:** When applicable, special installation instructions are provided for an assembly at the end of the removal procedure. Always completely read the removal instructions and follow all special installation instructions.

---



## Removal and replacement: Entrance motor (M10)


Learn how to remove and replace the entrance motor.

To view teardown and reassembling video of the inner finisher, click the link below.

 [View a teardown video of the inner finisher.](#)

 [View a reassembling video of the inner finisher.](#)

---

 **IMPORTANT:** When applicable, special installation instructions are provided for an assembly at the end of the removal procedure. Always completely read the removal instructions and follow all special installation instructions.

---

Mean time to repair:


Service level:

### Before performing service

#### Turn the printer power off

- Press the power button on the front of the printer, and then turn off the power switch next to the power cable.
- A shutting-down message appears on the control-panel display.

---

 **WARNING!** To avoid damage to the printer, turn the power off and wait until the printer shuts down before removing the power cable.

---

- Disconnect the printer power cable after the printer has completely shut down (the control-panel display is blank).

Use the table below to identify the correct part number for your printer. To order the part, go to [www.hp.com/buy/parts](http://www.hp.com/buy/parts).

Table 6-40 Part information

Part number	Part description
JC90-01344A	Entrance motor assembly

### Required tools

- #2 JIS screwdriver with a magnetic tip

### After performing service

#### Turn the printer power on

- Connect the power cable.
- Use the power switch to turn the power on.

### Post service test

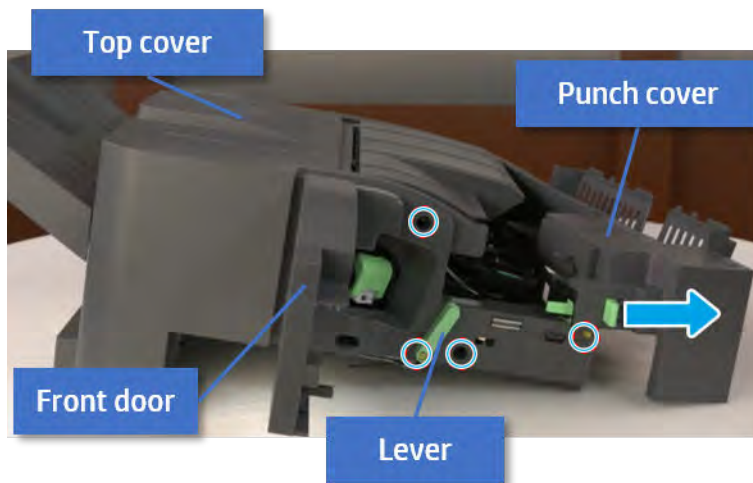
Print any pages necessary to verify that the repair resolved the issue and did not create any new issues.

## Remove the front cover

Follow these steps to remove the front cover.

1. Open the front door and open the punch cover.
2. Remove three screws in the front.
3. Remove the lever.
4. Open the top cover.
5. From the right side of the front cover, carefully lift and pry toward the top-left corner to remove the front cover.

Figure 6-88 Remove the front cover

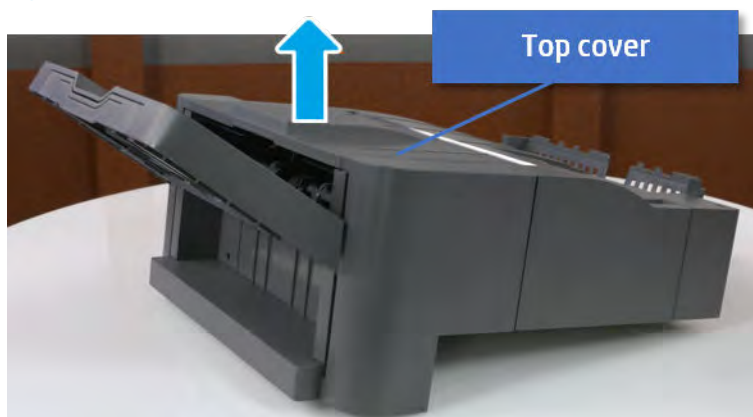


## Remove the rear cover

Follow these steps to remove the rear cover.

1. Open the top cover.

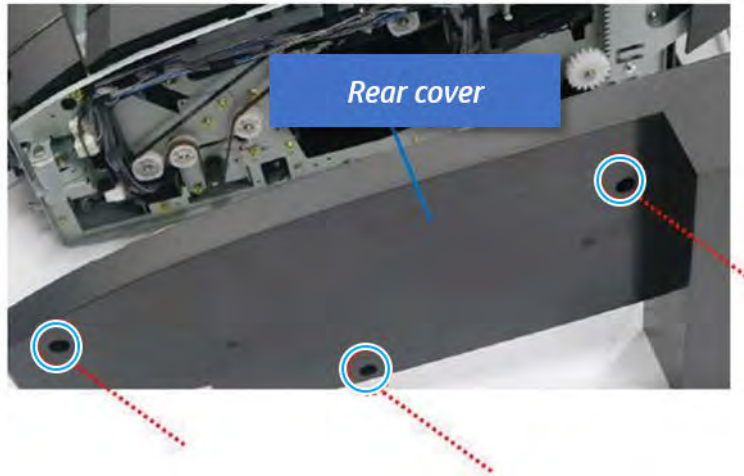
Figure 6-89 Open the top cover



2. Remove three screws.

3. Release hooks carefully and remove the rear cover.

Figure 6-90 Remove the rear cover



### Remove the middle cover

Follow these steps to remove the middle cover.

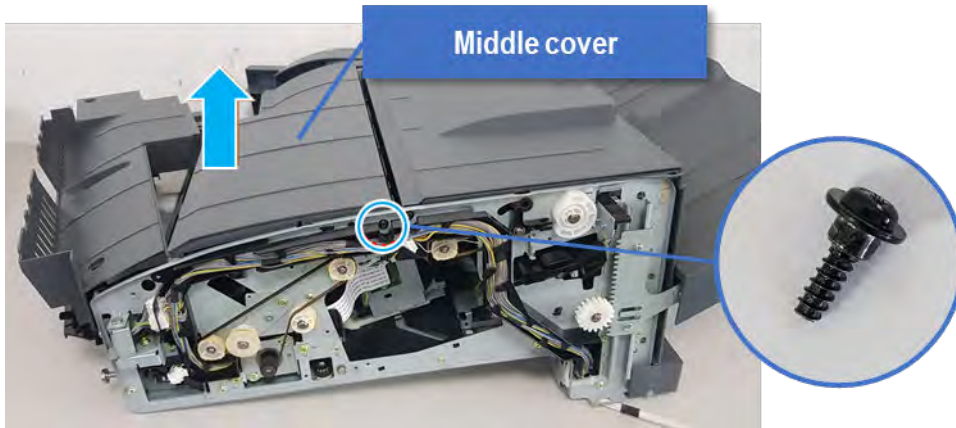
1. Open the front door and then open the punch cover.

Figure 6-91 Open the front door and punch cover



2. Remove left-side one screw at the rear of the inner finisher, and then remove the middle cover by lifting off the hinge pins at the front.

Figure 6-92 Remove the middle cover

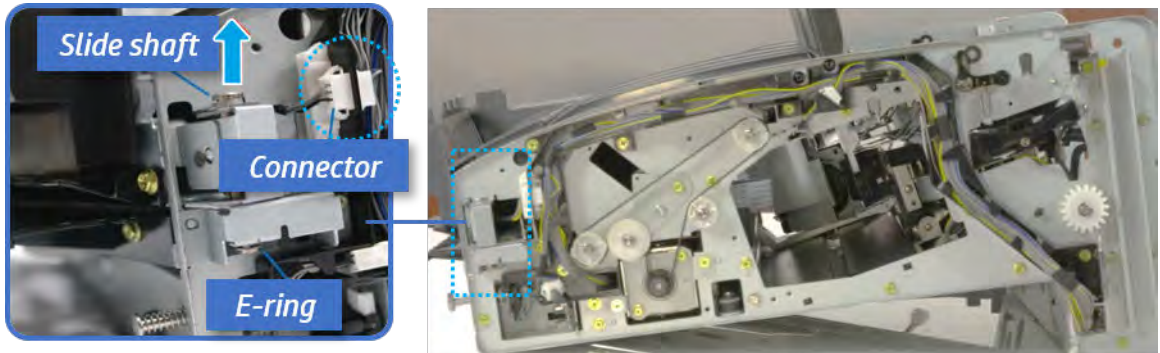


### Remove the punch cover

Follow these steps to remove the punch cover.

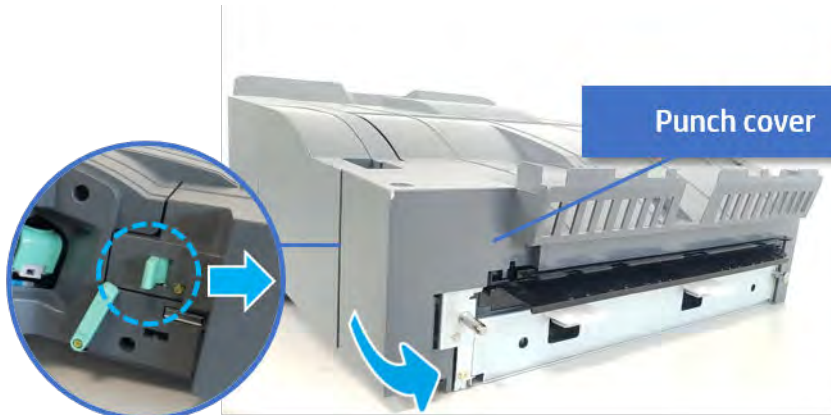
1. Unplug the connector. Remove the e-ring, and then remove the slide shaft at the rear of the inner finisher.

Figure 6-93 Remove the slide shaft



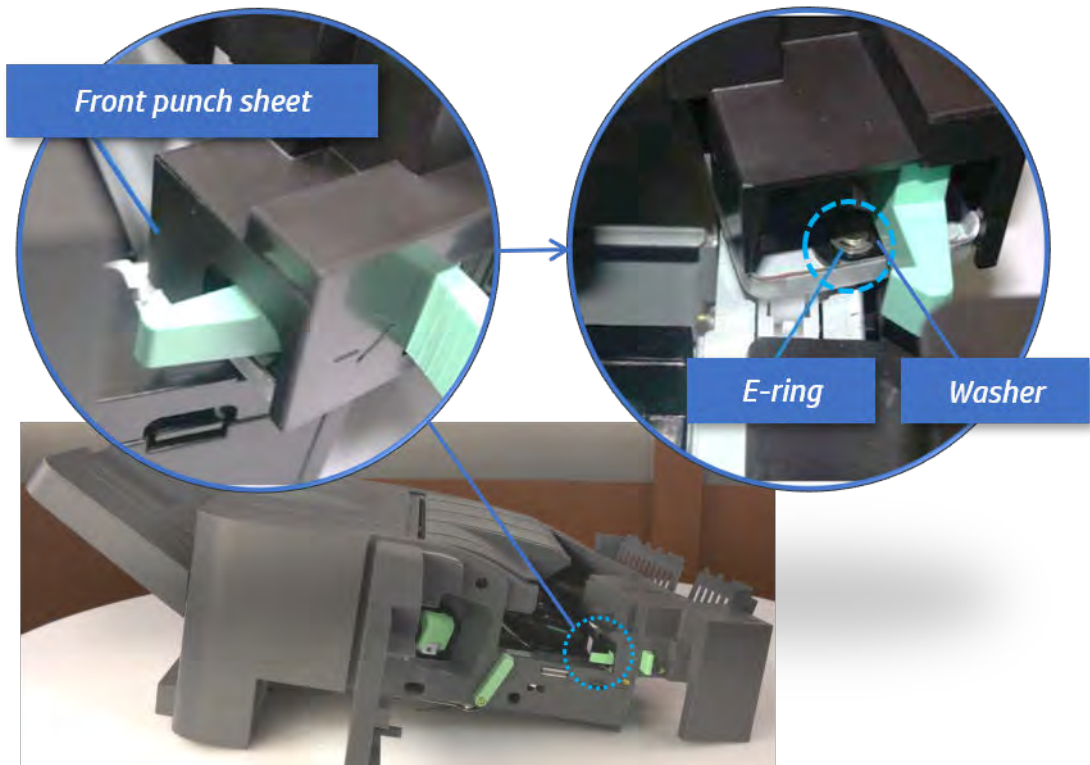
2. Open the punch cover.

Figure 6-94 Open the punch cover



3. Remove the front punch sheet, and then remove the e-ring and the washer. And then remove the punch cover.

Figure 6-95 Remove the punch cover

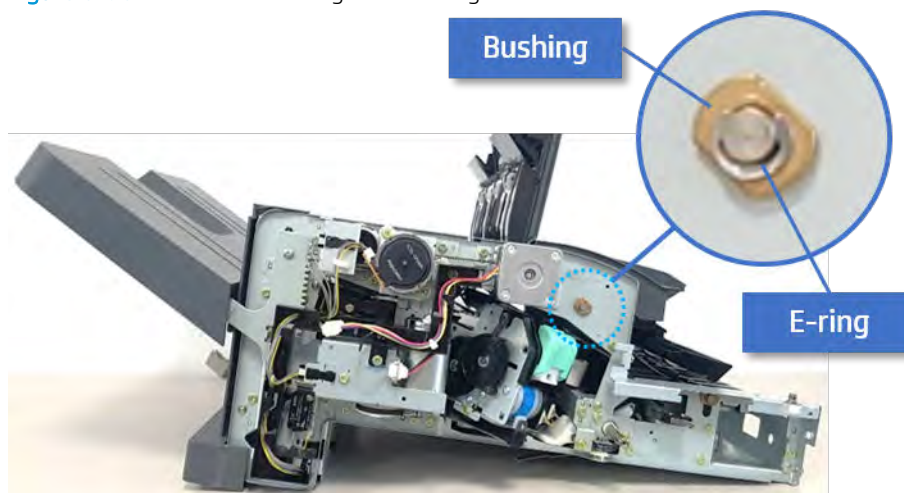


#### Remove the diverter guide and the middle roller

Follow these steps to remove the diverter guide and the middle roller.

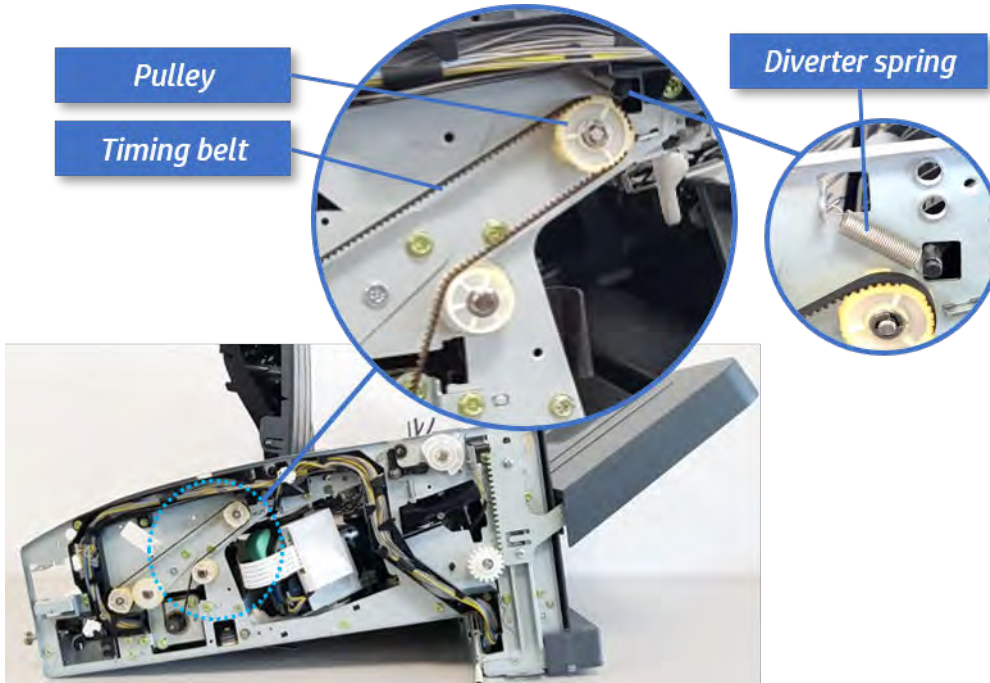
1. On the front of the inner finisher, remove the e-ring and bushing.

Figure 6-96 Remove the e-ring and bushing



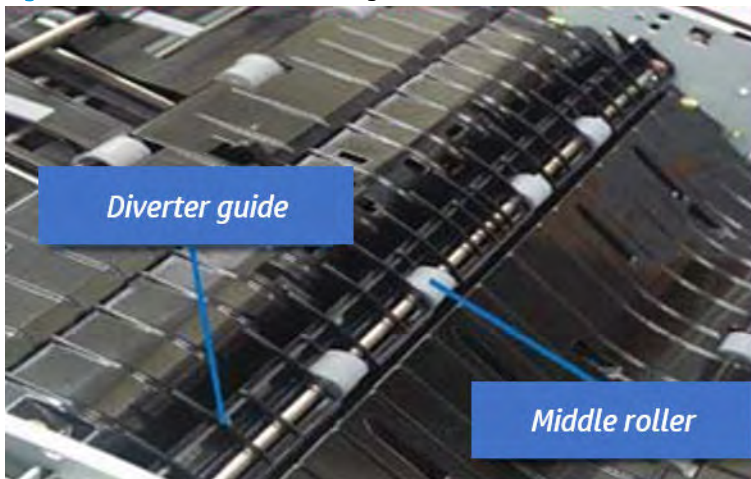
2. On the rear of the inner finisher, remove the e-ring, pulley, bushing, belt, and spring (slightly hidden from view).

**Figure 6-97** Remove the e-ring, pulley, bushing, belt, and spring



3. Remove the diverter guide and the middle roller.

**Figure 6-98** Remove the diverter guide and the middle roller




### Remove the middle paper guide

Follow these steps to remove the middle paper guide.

1. Remove six screws, and then open the middle paper guide in the direction of the arrow.

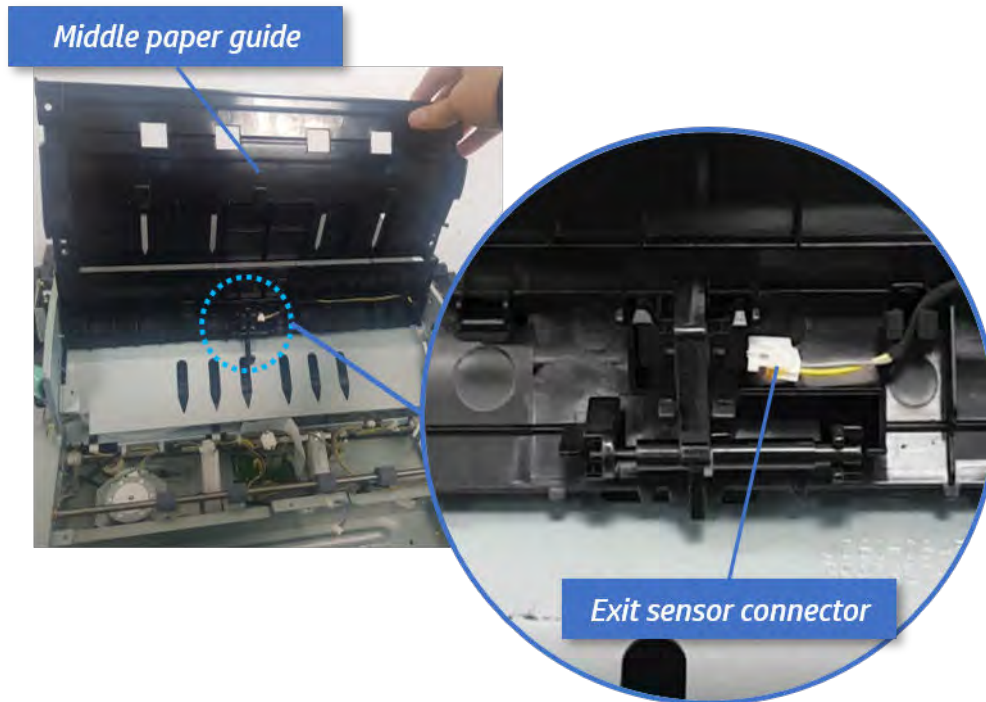
Figure 6-99 Open the middle paper guide



 **NOTE:** Be careful not to damage the sensor connector.

2. Unplug the connector under the middle paper guide. And then, remove the middle paper guide.

Figure 6-100 Remove the middle paper guide

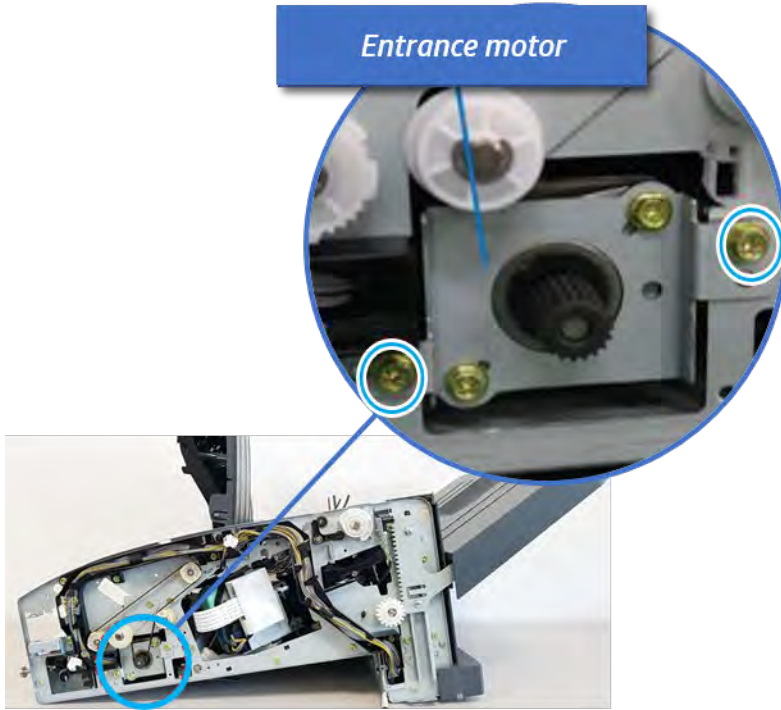


### Remove the entrance motor

Follow these steps to remove the entrance motor.

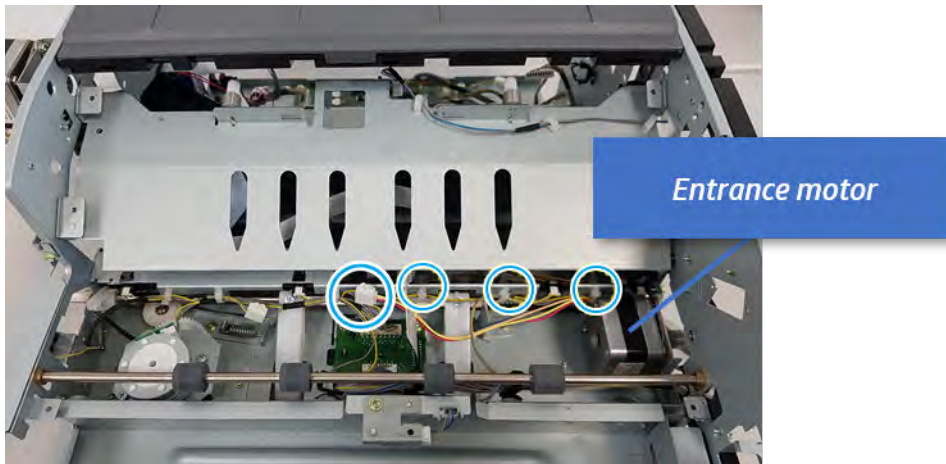
1. Remove two screws.

Figure 6-101 Remove two screws



2. Open the clamps, and then unplug the connector.

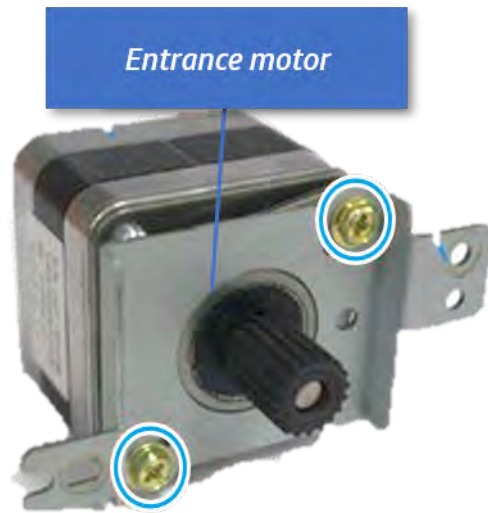
Figure 6-102 Unplug the connector





3. Remove two screws, and then remove the motor.

Figure 6-103 Remove the entrance motor



### Unpack the replacement assembly



Follow these steps to unpack the replacement assembly.

1. Dispose of the defective part.


 **NOTE:** HP recommends responsible disposal of the defective part.

<http://www8.hp.com/us/en/hp-information/environment/product-recycling.html>


2. Unpack the replacement part from the packaging.

 **CAUTION:**  Some parts are sensitive to electrostatic discharge (ESD). Always perform service work at an ESD-protected workstation or mat. If an ESD workstation or mat is not available, touch the sheet-metal chassis to provide a static ground before touching an ESD-sensitive assembly. Protect the ESD-sensitive assemblies by placing them in ESD pouches when they are out of the printer.

 **IMPORTANT:** Make sure that all of the shipping materials (for example shipping tape) are removed from the replacement part prior to installation.

 **NOTE:** If the replacement part is a roller or pad, avoid touching the spongy part of it. Skin oils on the roller or pad can cause paper pickup and/or print-quality problems. HP recommends using disposable gloves when handling rollers or pads or washing your hands before touching rollers or pads.

3. To install an assembly, reverse the removal steps.

 **NOTE:** When applicable, special installation instructions are provided for an assembly at the end of the removal procedure. Always completely read the removal instructions and follow all special installation instructions.

## Exit unit


## Removal and replacement: Exit roller (R3)

Learn how to remove and replace the exit roller.

To view teardown and reassembling video of the inner finisher, click the link below.

 [View a teardown video of the inner finisher.](#)

 [View a reassembling video of the inner finisher.](#)

 **IMPORTANT:** When applicable, special installation instructions are provided for an assembly at the end of the removal procedure. Always completely read the removal instructions and follow all special installation instructions.


Mean time to repair:

Service level:

### Before performing service

#### Turn the printer power off

- Press the power button on the front of the printer, and then turn off the power switch next to the power cable.
- A shutting-down message appears on the control-panel display.

 **WARNING!** To avoid damage to the printer, turn the power off and wait until the printer shuts down before removing the power cable.

- Disconnect the printer power cable after the printer has completely shut down (the control-panel display is blank).

Use the table below to identify the correct part number for your printer. To order the part, go to <http://www.hp.com/buy/parts>.

Table 6-41 Part information

Part number	Part description
JC66-04244A	Exit roller
JC61-07449A	Front compile guide
JC61-07450A	Rear compile guide

### Required tools

- #2 JIS screwdriver with a magnetic tip

### After performing service

#### Turn the printer power on

- Connect the power cable.
- Use the power switch to turn the power on.

## Post service test

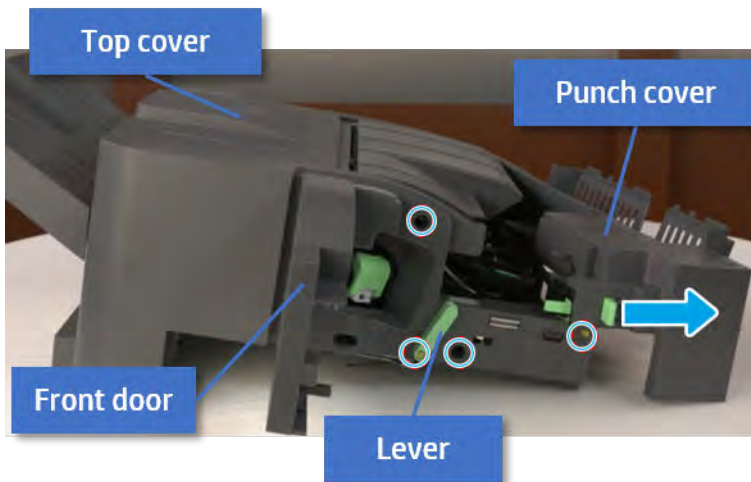
Print any pages necessary to verify that the repair resolved the issue and did not create any new issues.

## Remove the front cover

Follow these steps to remove the front cover.

1. Open the front door and open the punch cover.
2. Remove three screws in the front.
3. Remove the lever.
4. Open the top cover.
5. From the right side of the front cover, carefully lift and pry toward the top-left corner to remove the front cover.

Figure 6-104 Remove the front cover

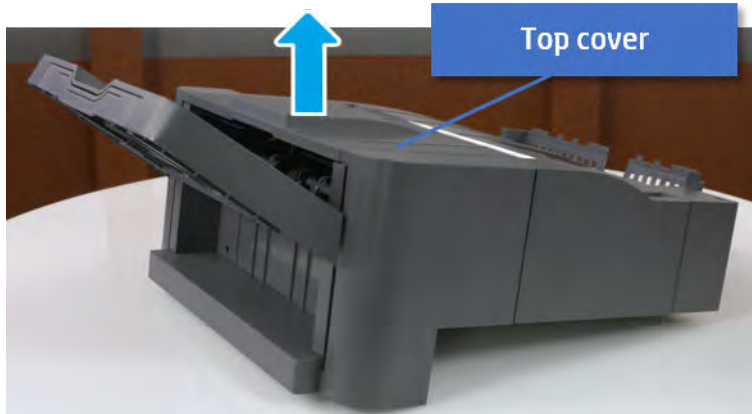


## Remove the rear cover

Follow these steps to remove the rear cover.

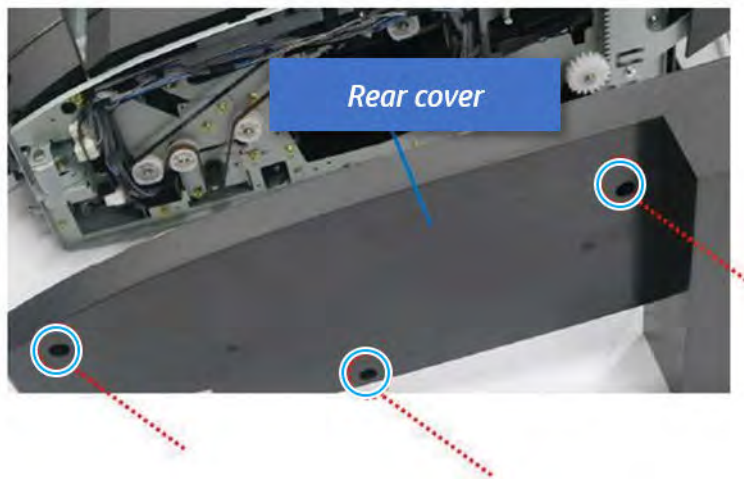
1. Open the top cover.

Figure 6-105 Open the top cover



2. Remove three screws.
3. Release hooks carefully and remove the rear cover.

Figure 6-106 Remove the rear cover

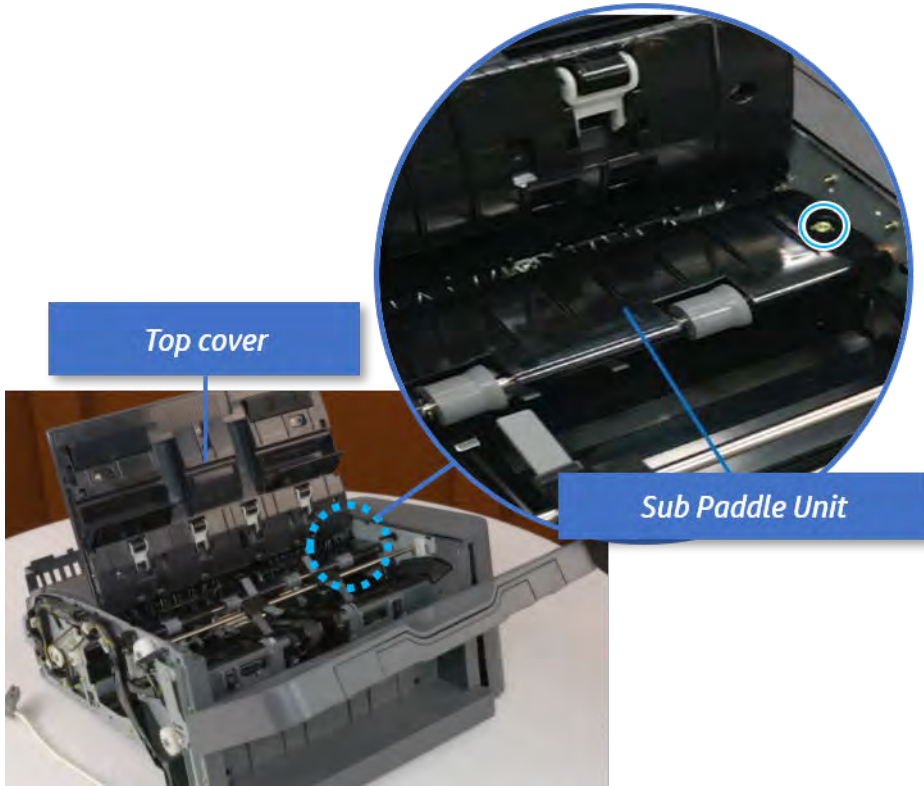


### Remove the sub paddle unit

Follow these steps to remove the sub paddle unit.

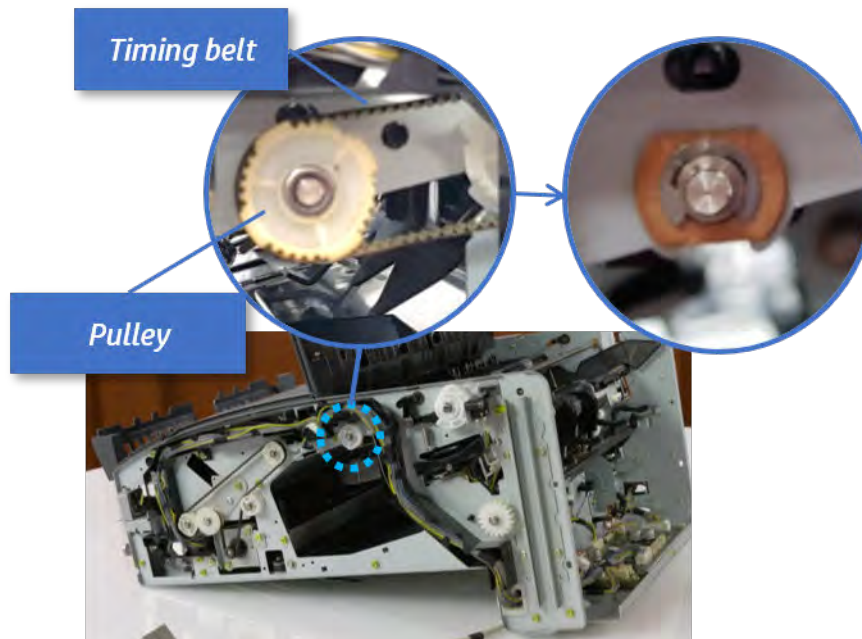
1. Open the top cover, and then remove one screw securing the sub paddle unit.

Figure 6-107 Remove one screw



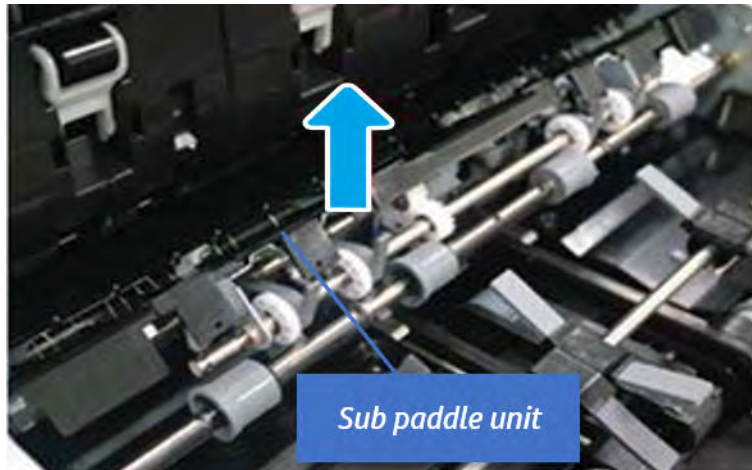
2. Remove the e-ring, and then remove the pulley and timing belt. And then remove the e-ring and the bushing.

Figure 6-108 Remove the e-ring, pulley, timing belt, and bushing



3. Lift up and remove the sub paddle unit.

Figure 6-109 Remove the sub paddle unit

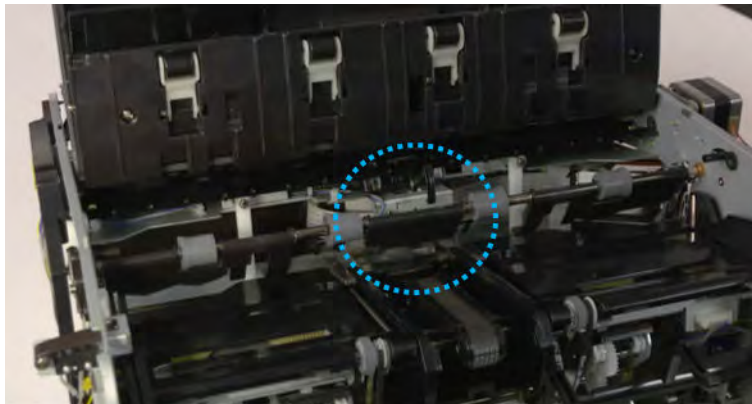


### Remove the exit roller

Follow these steps to remove the exit roller.

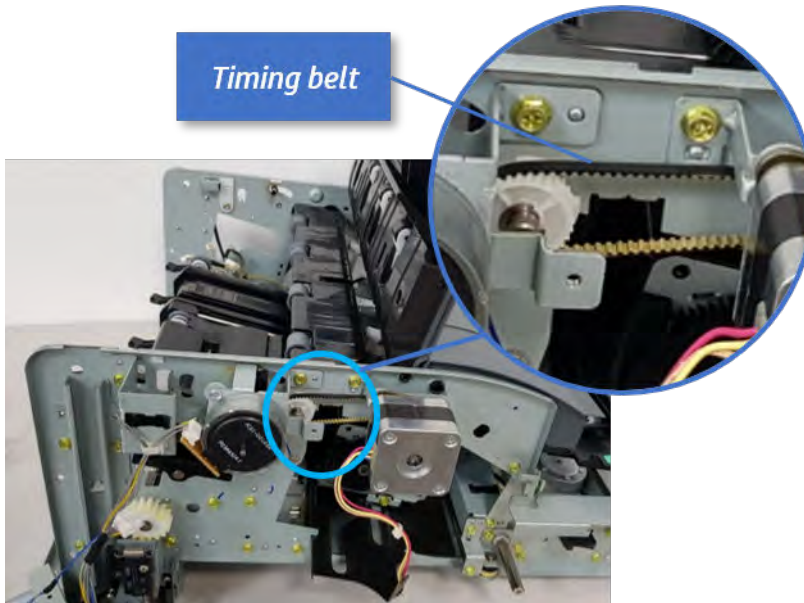
1. Remove the guide on the center of the exit roller.

Figure 6-110 Remove the guide



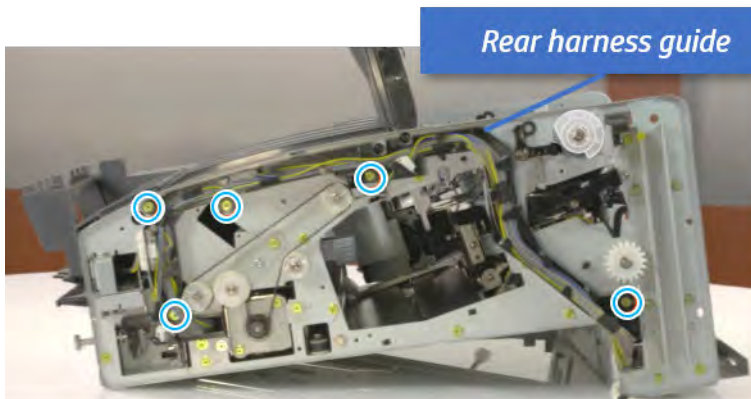
2. On the front of the inner finisher, release the timing belt connected to the exit motor.

Figure 6-111 Release the timing belt



3. Remove five screws securing the rear harness guide.

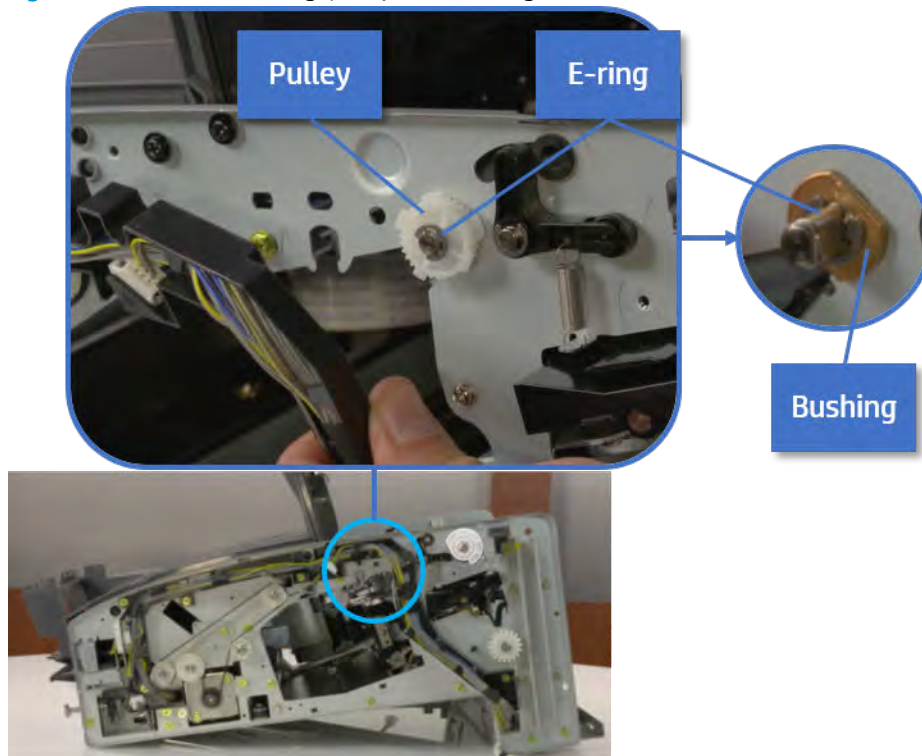
Figure 6-112 Remove five screws





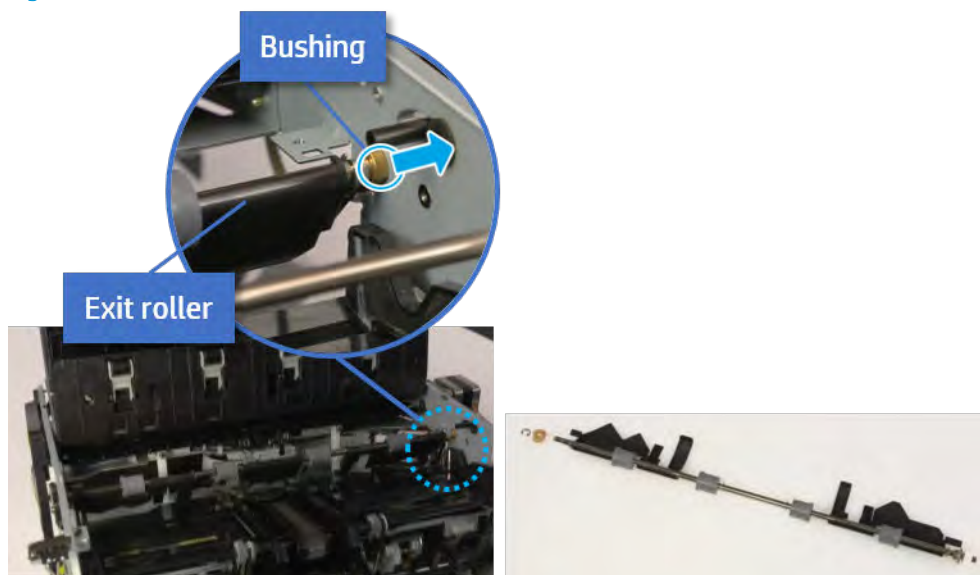
4. On the rear of the inner finisher, remove the e-ring and the pulley and then remove the e-ring and the bushing.

Figure 6-113 Remove e-ring, pulley, and bushing



5. Push the bushing to detach it, and then remove the exit roller.

Figure 6-114 Remove the exit roller



### Unpack the replacement assembly

Follow these steps to unpack the replacement assembly.

1. Dispose of the defective part.

---

 **NOTE:** HP recommends responsible disposal of the defective part.

<http://www8.hp.com/us/en/hp-information/environment/product-recycling.html>

---

2. Unpack the replacement part from the packaging.


 **CAUTION:**  Some parts are sensitive to electrostatic discharge (ESD). Always perform service work at an ESD-protected workstation or mat. If an ESD workstation or mat is not available, touch the sheet-metal chassis to provide a static ground before touching an ESD-sensitive assembly. Protect the ESD-sensitive assemblies by placing them in ESD pouches when they are out of the printer.

 **IMPORTANT:** Make sure that all of the shipping materials (for example shipping tape) are removed from the replacement part prior to installation.

 **NOTE:** If the replacement part is a roller or pad, avoid touching the spongy part of it. Skin oils on the roller or pad can cause paper pickup and/or print-quality problems. HP recommends using disposable gloves when handling rollers or pads or washing your hands before touching rollers or pads.

---

3. To install an assembly, reverse the removal steps.

 **NOTE:** When applicable, special installation instructions are provided for an assembly at the end of the removal procedure. Always completely read the removal instructions and follow all special installation instructions.

---


## Removal and replacement: Exit sensor (S21)

Learn how to remove and replace the exit sensor.

To view teardown and reassembling video of the inner finisher, click the link below.

 [View a teardown video of the inner finisher.](#)

 [View a reassembling video of the inner finisher.](#)

 **IMPORTANT:** When applicable, special installation instructions are provided for an assembly at the end of the removal procedure. Always completely read the removal instructions and follow all special installation instructions.


Mean time to repair:

Service level:

### Before performing service

#### Turn the printer power off

- Press the power button on the front of the printer, and then turn off the power switch next to the power cable.
- A shutting-down message appears on the control-panel display.

 **WARNING!** To avoid damage to the printer, turn the power off and wait until the printer shuts down before removing the power cable.

- Disconnect the printer power cable after the printer has completely shut down (the control-panel display is blank).

Use the table below to identify the correct part number for your printer. To order the part, go to [www.hp.com/buy/parts](http://www.hp.com/buy/parts).

Table 6-42 Part information

Part number	Part description
0604-001415	Exit sensor

### Required tools

- #2 JIS screwdriver with a magnetic tip

### After performing service

#### Turn the printer power on

- Connect the power cable.
- Use the power switch to turn the power on.

### Post service test

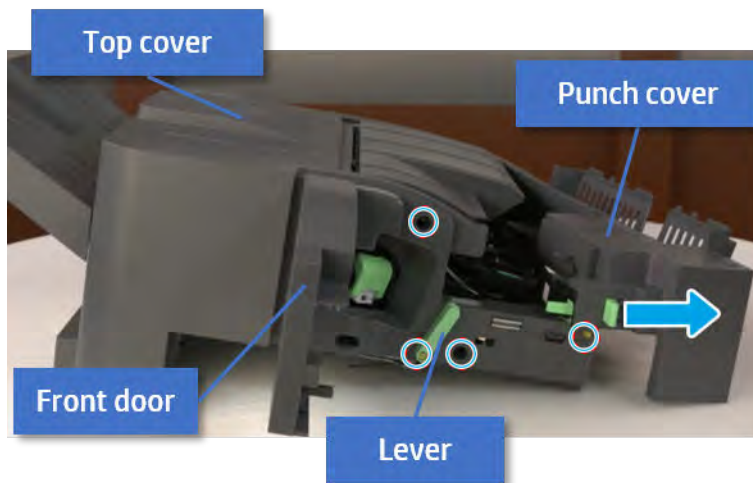
Print any pages necessary to verify that the repair resolved the issue and did not create any new issues.

## Remove the front cover

Follow these steps to remove the front cover.

1. Open the front door and open the punch cover.
2. Remove three screws in the front.
3. Remove the lever.
4. Open the top cover.
5. From the right side of the front cover, carefully lift and pry toward the top-left corner to remove the front cover.

Figure 6-115 Remove the front cover

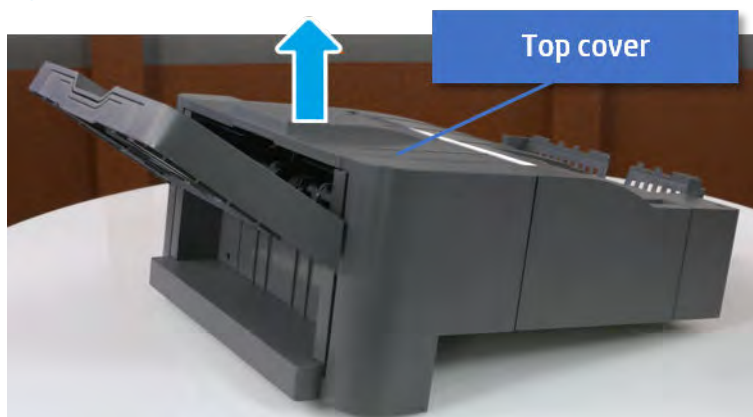


## Remove the rear cover

Follow these steps to remove the rear cover.

1. Open the top cover.

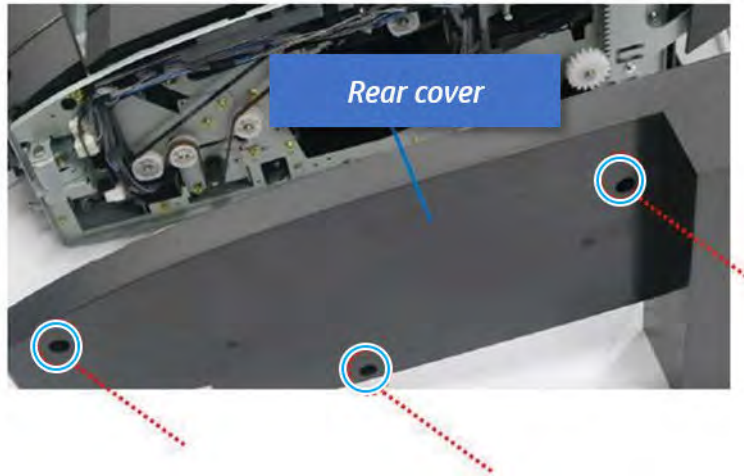
Figure 6-116 Open the top cover



2. Remove three screws.

3. Release hooks carefully and remove the rear cover.

Figure 6-117 Remove the rear cover



### Remove the middle cover

Follow these steps to remove the middle cover.

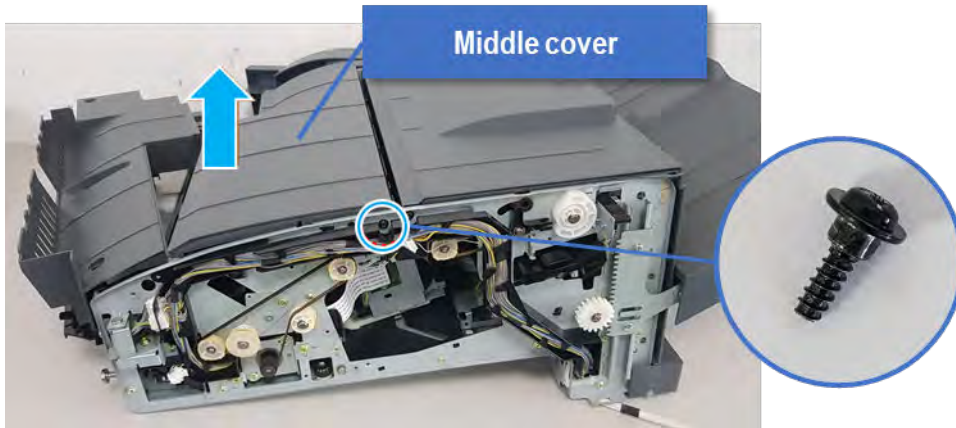
1. Open the front door and then open the punch cover.

Figure 6-118 Open the front door and punch cover



2. Remove left-side one screw at the rear of the inner finisher, and then remove the middle cover by lifting off the hinge pins at the front.

Figure 6-119 Remove the middle cover

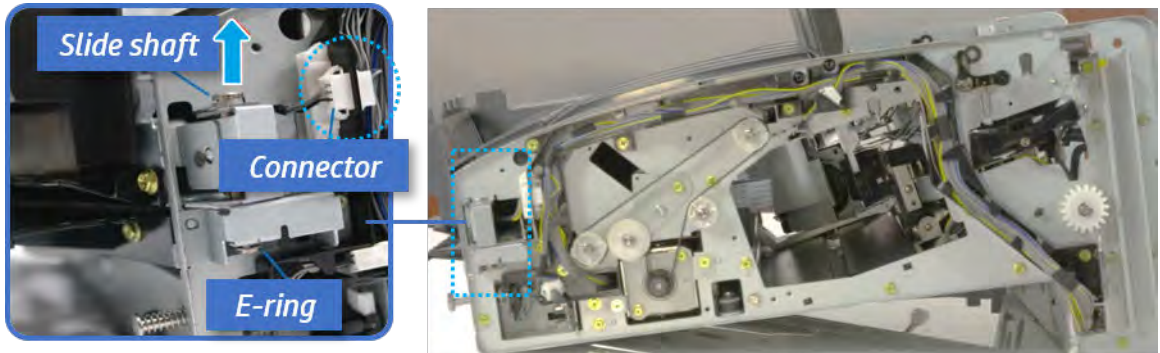


### Remove the punch cover

Follow these steps to remove the punch cover.

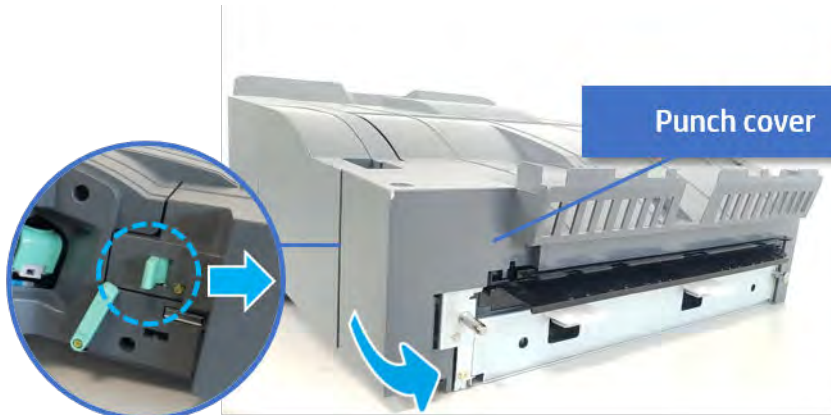
1. Unplug the connector. Remove the e-ring, and then remove the slide shaft at the rear of the inner finisher.

Figure 6-120 Remove the slide shaft



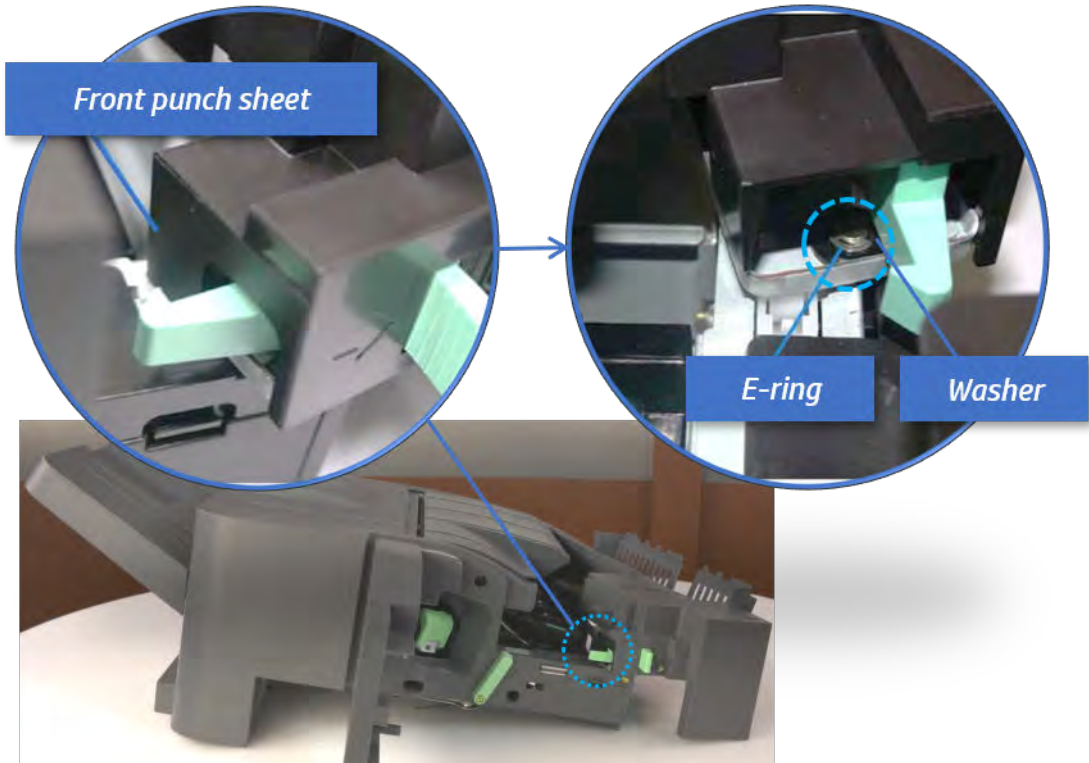
2. Open the punch cover.

Figure 6-121 Open the punch cover



3. Remove the front punch sheet, and then remove the e-ring and the washer. And then remove the punch cover.

Figure 6-122 Remove the punch cover

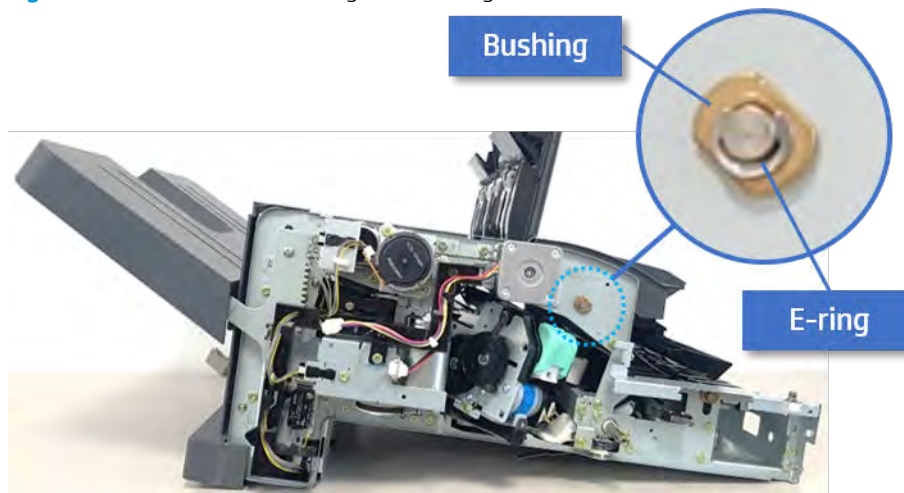


#### Remove the diverter guide and the middle roller

Follow these steps to remove the diverter guide and the middle roller.

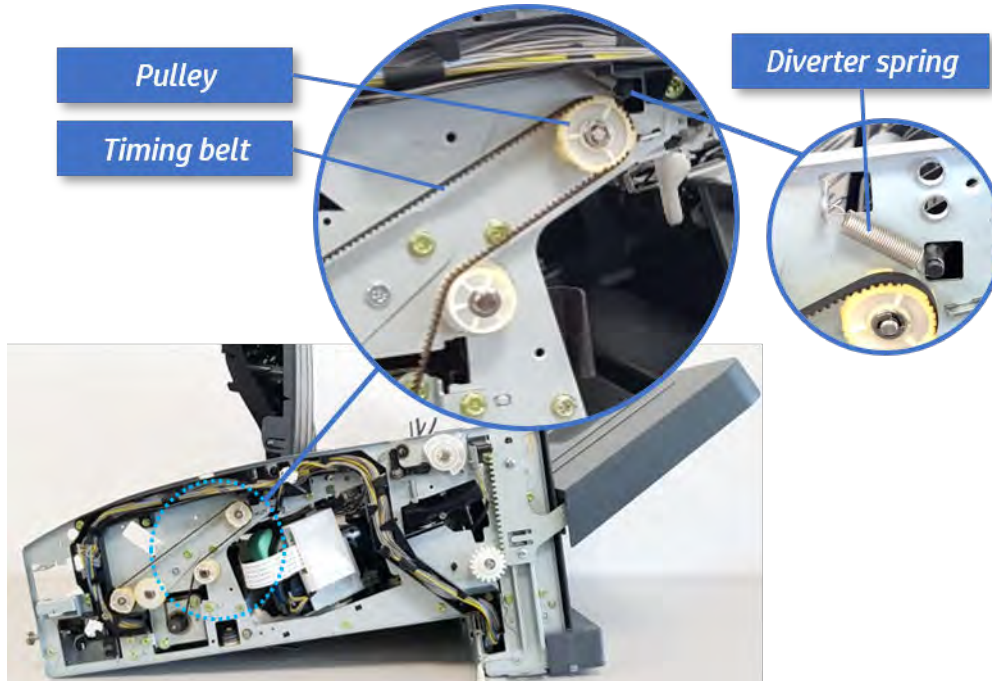
1. On the front of the inner finisher, remove the e-ring and bushing.

Figure 6-123 Remove the e-ring and bushing



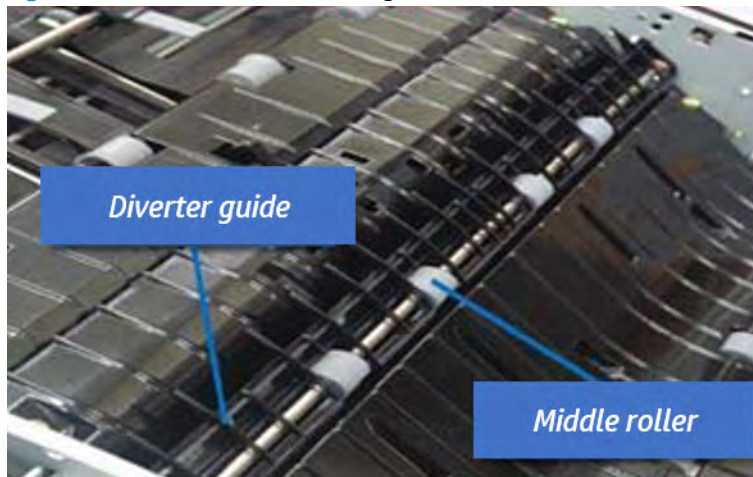
2. On the rear of the inner finisher, remove the e-ring, pulley, bushing, belt, and spring (slightly hidden from view).

**Figure 6-124** Remove the e-ring, pulley, bushing, belt, and spring



3. Remove the diverter guide and the middle roller.

**Figure 6-125** Remove the diverter guide and the middle roller



### Remove the middle paper guide


Follow these steps to remove the middle paper guide.

1. Remove six screws, and then open the middle paper guide in the direction of the arrow.



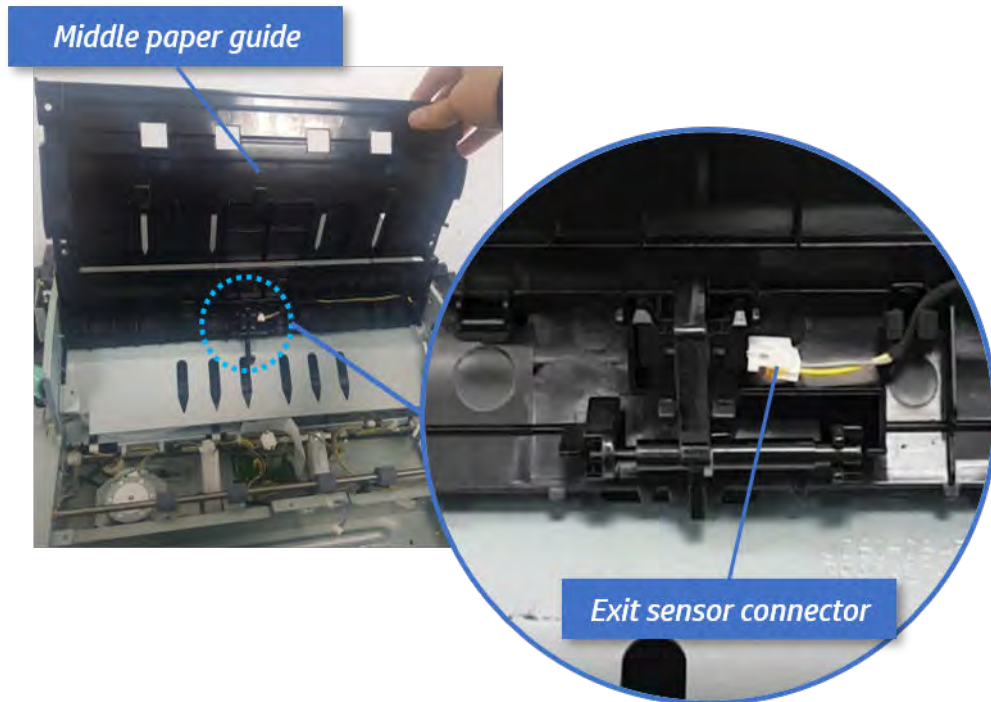
Figure 6-126 Open the middle paper guide



 **NOTE:** Be careful not to damage the sensor connector.

2. Unplug the connector under the middle paper guide. And then, remove the middle paper guide.

Figure 6-127 Remove the middle paper guide

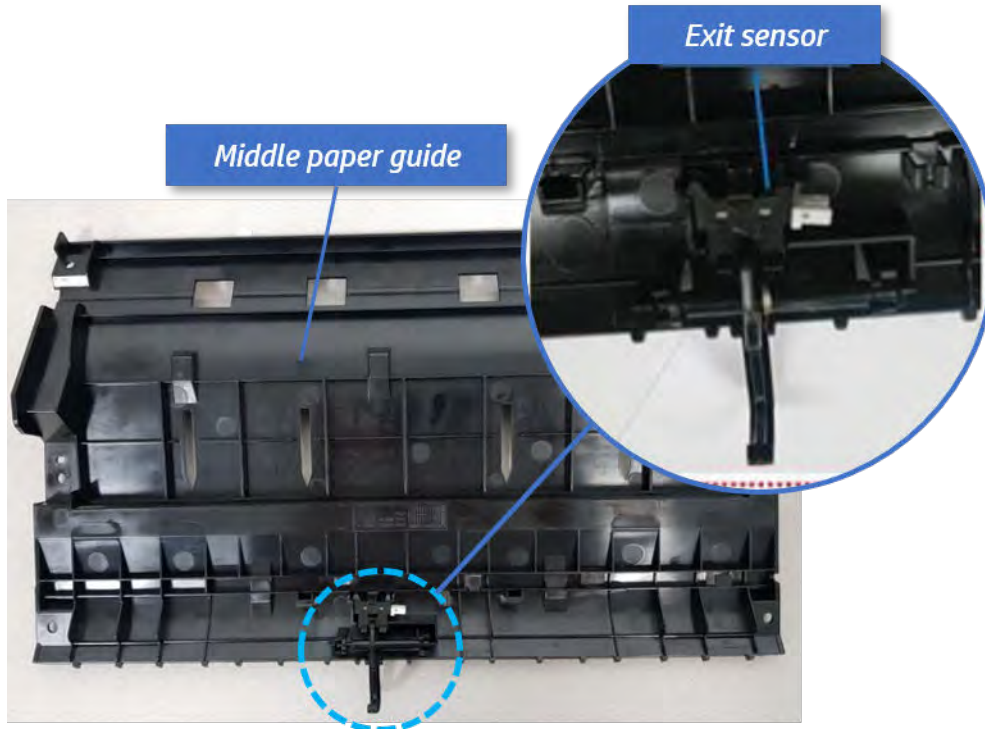


### Remove the exit sensor

Follow these steps to remove the exit sensor.

- ▲ Remove the exit sensor from the middle paper guide.

Figure 6-128 Remove the exit sensor



### Unpack the replacement assembly



Follow these steps to unpack the replacement assembly.


1. Dispose of the defective part.


 **NOTE:** HP recommends responsible disposal of the defective part.

<http://www8.hp.com/us/en/hp-information/environment/product-recycling.html>


2. Unpack the replacement part from the packaging.

 **CAUTION:**  Some parts are sensitive to electrostatic discharge (ESD). Always perform service work at an ESD-protected workstation or mat. If an ESD workstation or mat is not available, touch the sheet-metal chassis to provide a static ground before touching an ESD-sensitive assembly. Protect the ESD-sensitive assemblies by placing them in ESD pouches when they are out of the printer.

 **IMPORTANT:** Make sure that all of the shipping materials (for example shipping tape) are removed from the replacement part prior to installation.

 **NOTE:** If the replacement part is a roller or pad, avoid touching the spongy part of it. Skin oils on the roller or pad can cause paper pickup and/or print-quality problems. HP recommends using disposable gloves when handling rollers or pads or washing your hands before touching rollers or pads.

3. To install an assembly, reverse the removal steps.

 **NOTE:** When applicable, special installation instructions are provided for an assembly at the end of the removal procedure. Always completely read the removal instructions and follow all special installation instructions.

## Removal and replacement: Exit motor (M2)


Learn how to remove and replace the exit motor.

To view teardown and reassembling video of the inner finisher, click the link below.

 [View a teardown video of the inner finisher.](#)

 [View a reassembling video of the inner finisher.](#)

---

 **IMPORTANT:** When applicable, special installation instructions are provided for an assembly at the end of the removal procedure. Always completely read the removal instructions and follow all special installation instructions.

---

Mean time to repair:


Service level:

### Before performing service

#### Turn the printer power off

- Press the power button on the front of the printer, and then turn off the power switch next to the power cable.
- A shutting-down message appears on the control-panel display.

---

 **WARNING!** To avoid damage to the printer, turn the power off and wait until the printer shuts down before removing the power cable.

---

- Disconnect the printer power cable after the printer has completely shut down (the control-panel display is blank).

Use the table below to identify the correct part number for your printer. To order the part, go to [www.hp.com/buy/parts](http://www.hp.com/buy/parts).

Table 6-43 Part information

Part number	Part description
JC31-00169B	Exit motor

### Required tools

- #2 JIS screwdriver with a magnetic tip

### After performing service

#### Turn the printer power on

- Connect the power cable.
- Use the power switch to turn the power on.

### Post service test

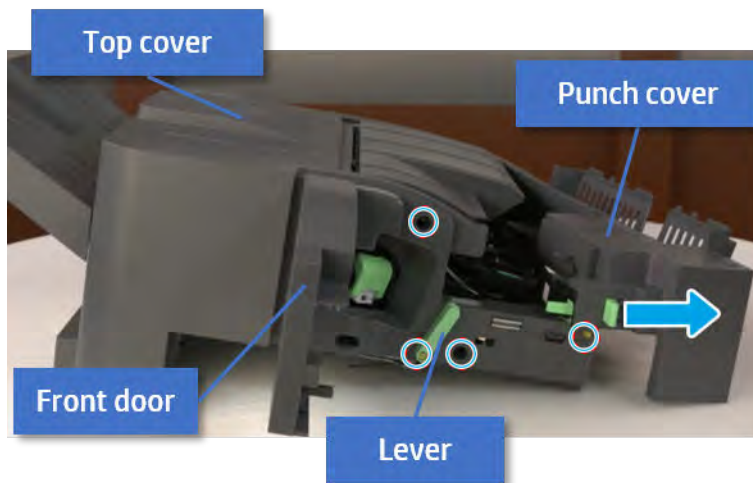
Print any pages necessary to verify that the repair resolved the issue and did not create any new issues.

## Remove the front cover

Follow these steps to remove the front cover.

1. Open the front door and open the punch cover.
2. Remove three screws in the front.
3. Remove the lever.
4. Open the top cover.
5. From the right side of the front cover, carefully lift and pry toward the top-left corner to remove the front cover.

Figure 6-129 Remove the front cover

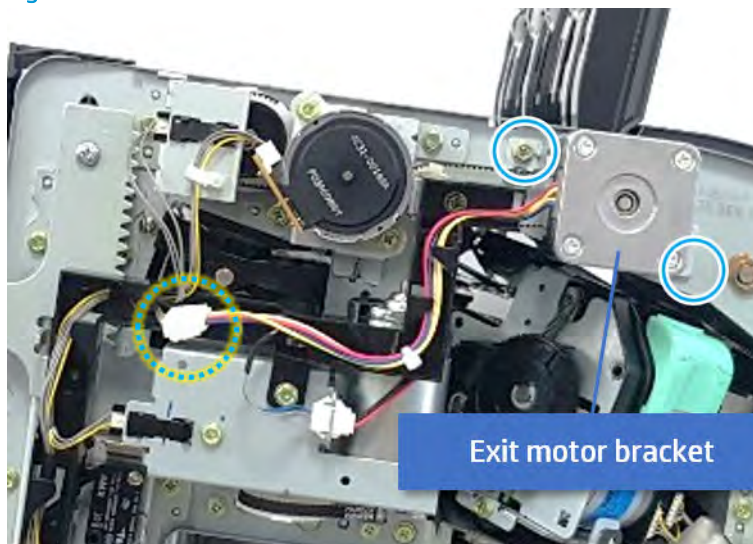


## Remove the exit motor bracket

Follow these steps to remove the exit motor bracket.

- ▲ Remove two screws, unplug the motor connector. And then remove exit motor bracket.

Figure 6-130 Remove the exit motor bracket

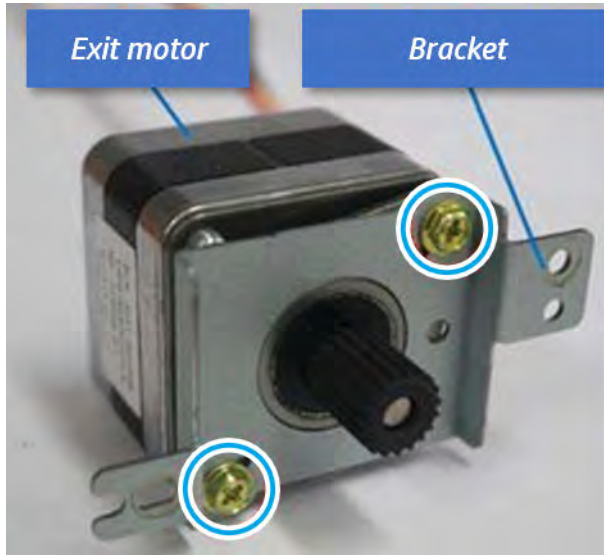


## Remove the exit motor

Follow these steps to remove the exit motor.

- ▲ Remove two screws, and then remove the exit motor from the bracket.

Figure 6-131 Remove the exit motor



## Unpack the replacement assembly



Follow these steps to unpack the replacement assembly.


1. Dispose of the defective part.


 **NOTE:** HP recommends responsible disposal of the defective part.

<http://www8.hp.com/us/en/hp-information/environment/product-recycling.html>


2. Unpack the replacement part from the packaging.

 **CAUTION:**  Some parts are sensitive to electrostatic discharge (ESD). Always perform service work at an ESD-protected workstation or mat. If an ESD workstation or mat is not available, touch the sheet-metal chassis to provide a static ground before touching an ESD-sensitive assembly. Protect the ESD-sensitive assemblies by placing them in ESD pouches when they are out of the printer.

 **IMPORTANT:** Make sure that all of the shipping materials (for example shipping tape) are removed from the replacement part prior to installation.

 **NOTE:** If the replacement part is a roller or pad, avoid touching the spongy part of it. Skin oils on the roller or pad can cause paper pickup and/or print-quality problems. HP recommends using disposable gloves when handling rollers or pads or washing your hands before touching rollers or pads.

3. To install an assembly, reverse the removal steps.

 **NOTE:** When applicable, special installation instructions are provided for an assembly at the end of the removal procedure. Always completely read the removal instructions and follow all special installation instructions.

## Paper support unit

## Removal and replacement: Front paper support


Learn how to remove and replace the front paper support.

To view teardown and reassembling video of the inner finisher, click the link below.

 [View a teardown video of the inner finisher.](#)

 [View a reassembling video of the inner finisher.](#)

---

 **IMPORTANT:** When applicable, special installation instructions are provided for an assembly at the end of the removal procedure. Always completely read the removal instructions and follow all special installation instructions.

---

Mean time to repair:

Service level:

### Before performing service

#### Turn the printer power off

- Press the power button on the front of the printer, and then turn off the power switch next to the power cable.
- A shutting-down message appears on the control-panel display.

---

 **WARNING!** To avoid damage to the printer, turn the power off and wait until the printer shuts down before removing the power cable.

---

- Disconnect the printer power cable after the printer has completely shut down (the control-panel display is blank).

Use the table below to identify the correct part number for your printer. To order the part, go to <http://www.hp.com/buy/parts>.

**Table 6-44** Part information

Part number	Part description
JC90-01310A	Front paper support

### Required tools

- #2 JIS screwdriver with a magnetic tip

### After performing service

#### Turn the printer power on

- Connect the power cable.
- Use the power switch to turn the power on.

### Post service test

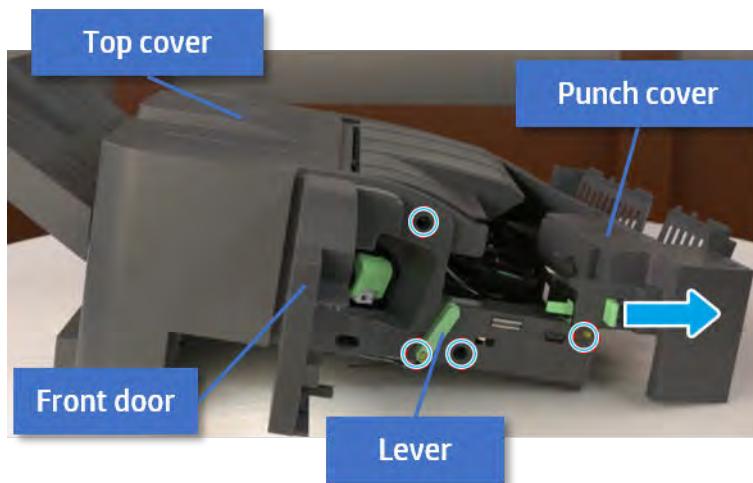
Print any pages necessary to verify that the repair resolved the issue and did not create any new issues.

## Remove the front cover

Follow these steps to remove the front cover.

1. Open the front door and open the punch cover.
2. Remove three screws in the front.
3. Remove the lever.
4. Open the top cover.
5. From the right side of the front cover, carefully lift and pry toward the top-left corner to remove the front cover.

Figure 6-132 Remove the front cover

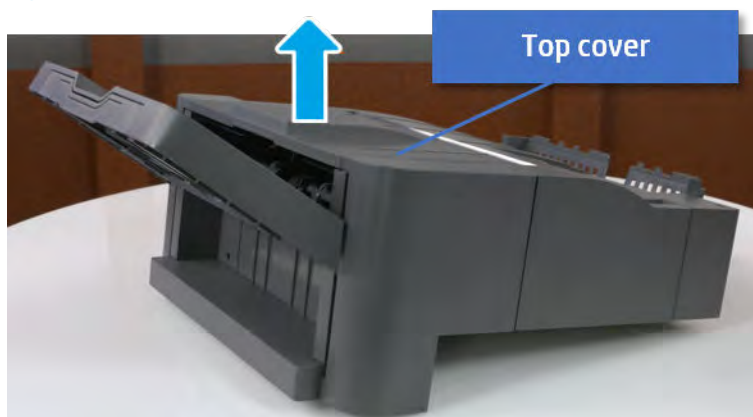


## Remove the rear cover

Follow these steps to remove the rear cover.

1. Open the top cover.

Figure 6-133 Open the top cover

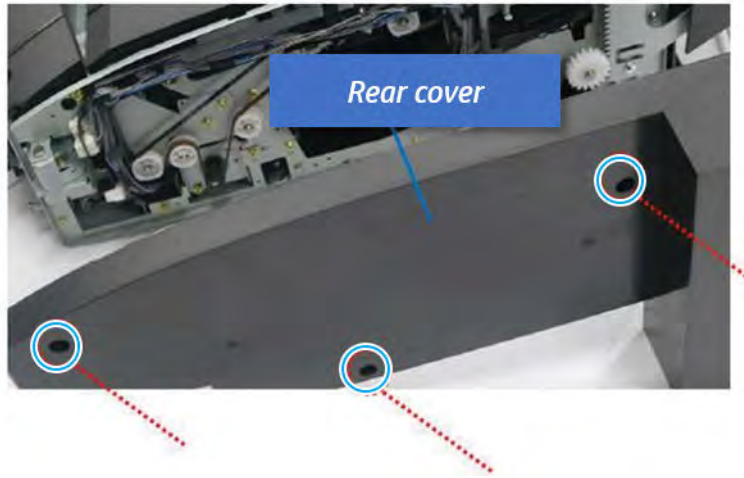


2. Remove three screws.



3. Release hooks carefully and remove the rear cover.

Figure 6-134 Remove the rear cover

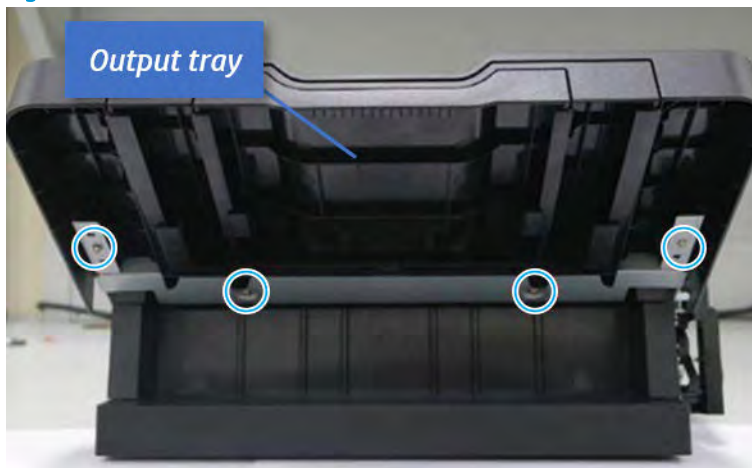


### Remove the output tray

Follow these steps to remove the output tray.

1. Remove four screws.

Figure 6-135 Remove four screws



2. Push the paper holding actuator into the inner finisher, and then remove the output tray.

Figure 6-136 Remove the output tray.

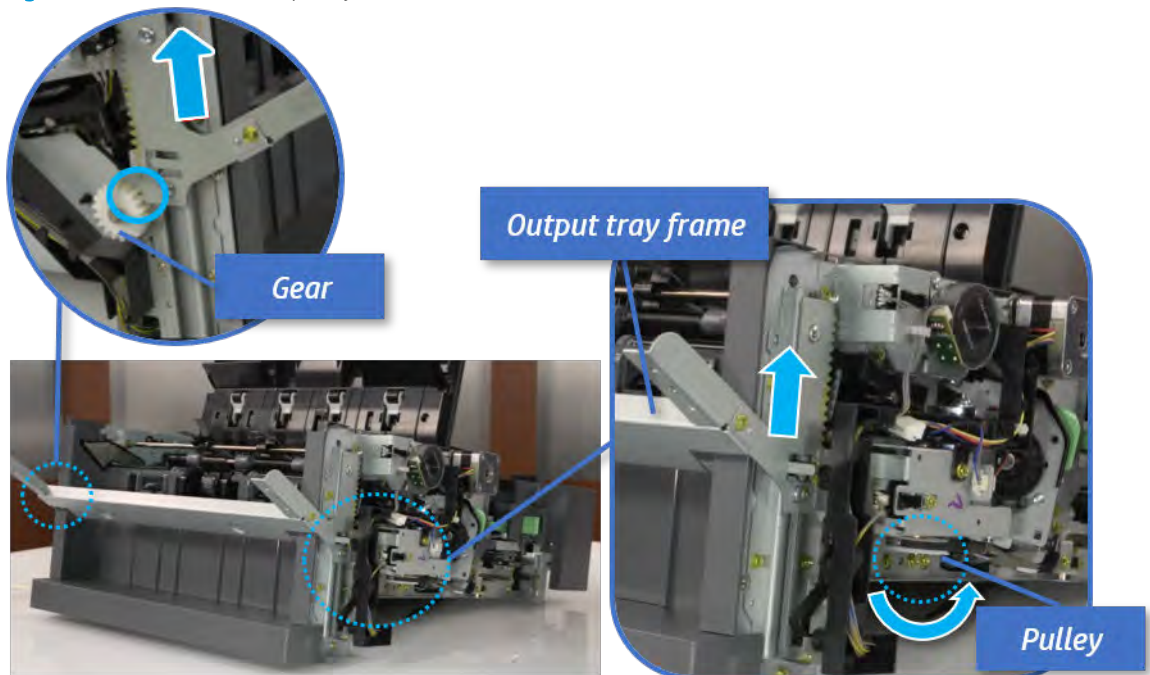


### Remove the output tray frame

Follow these steps to remove the output tray frame.

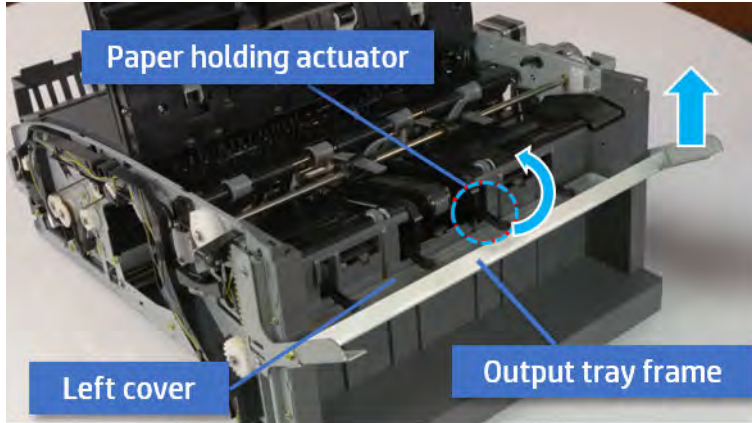
1. Rotate the pulley until the output tray frame depart from the gear.

Figure 6-137 Remove the pulley



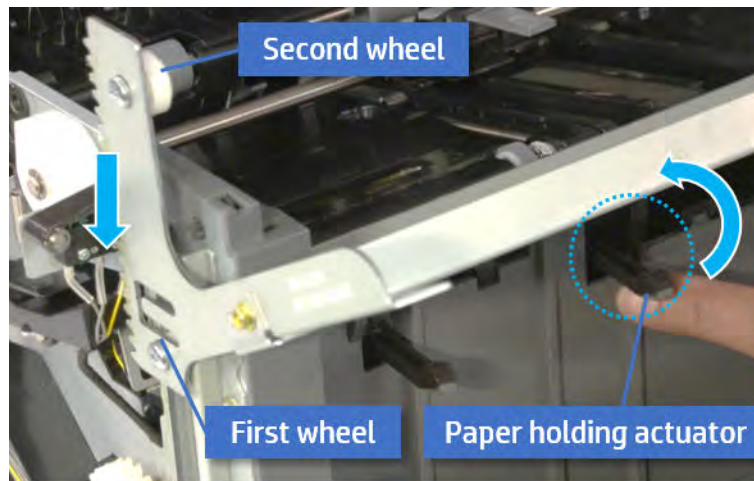
2. Push the paper holding actuator into the inner finisher, and then remove the output tray frame.

Figure 6-138 Remove the output tray frame

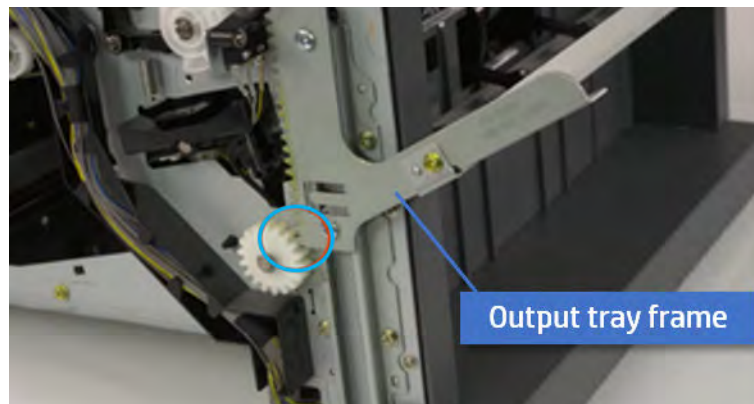


**TIP:** Push the paper holding actuator into the inner finisher when reassembling. Be sure to level the output tray.

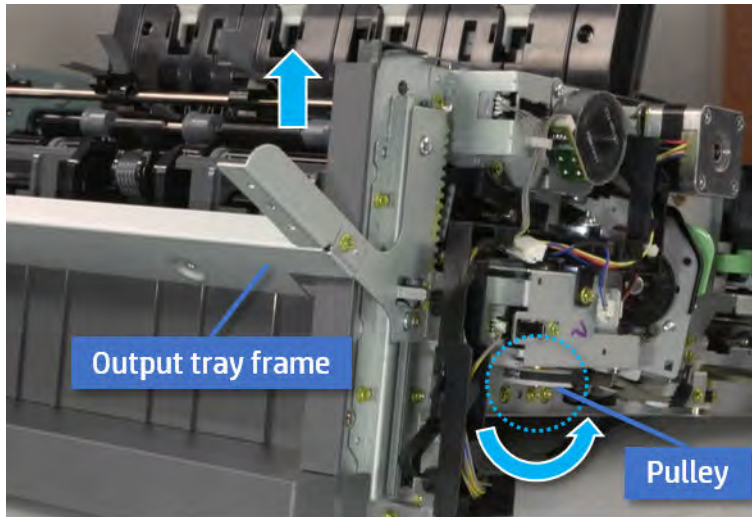
- a. Position the first wheel into the channel on both sides while pushing the paper holding actuator.



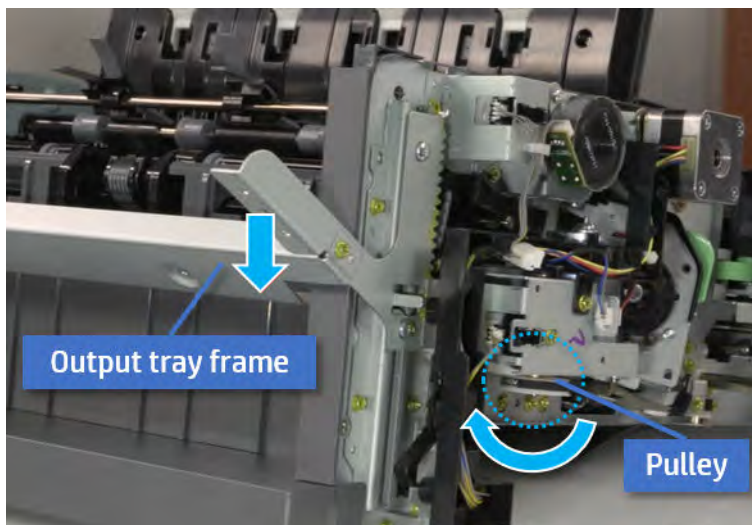
- b. Let the second wheel rest on the channel on both sides simultaneously.
- c. Gently squeeze the wheels into channel until the output tray frame meet the gear.



- d. Rotate the pulley until the output tray frame is no longer lifted. It can make to level the output tray frame.



- e. Rotate the pulley in the opposite direction.

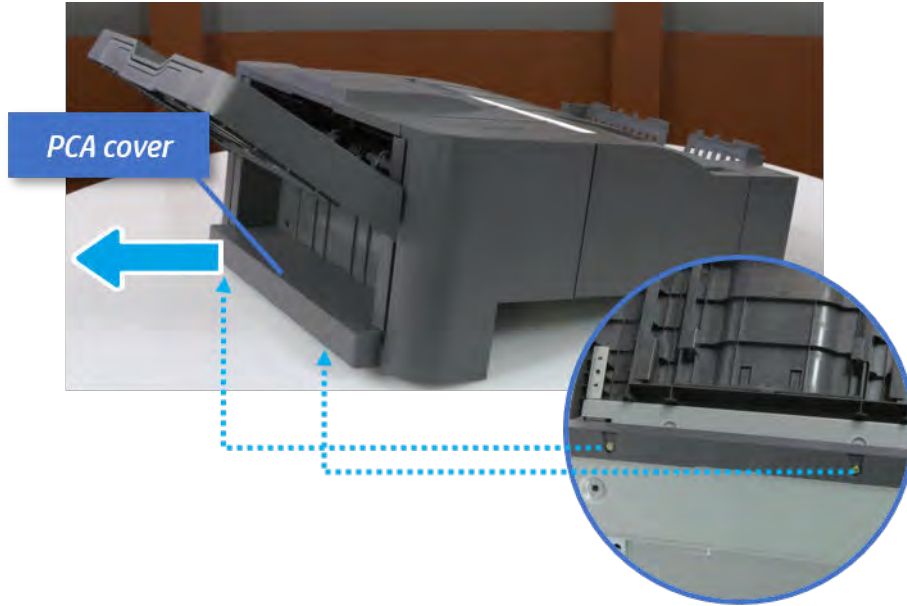


### Remove the PCA cover

Follow these steps to remove the PCA cover.

- ▲ Remove two screws, and then remove the PCA cover.

Figure 6-139 Remove the PCA cover

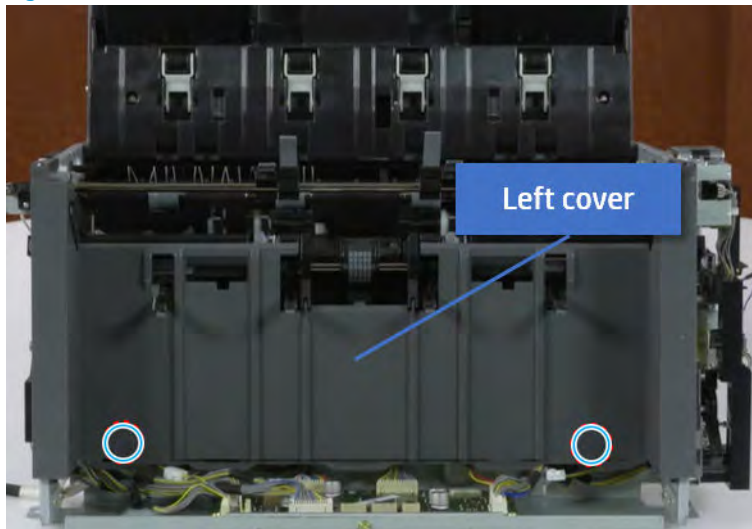


### Remove the left cover

Follow these steps to remove the left cover.

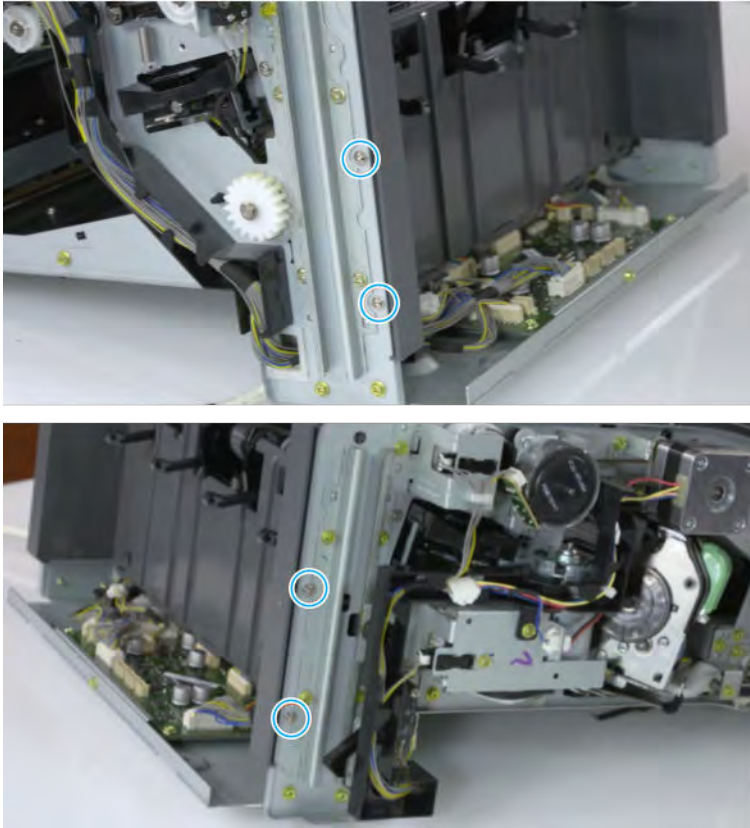
1. Remove two screws.

Figure 6-140 Remove two screws



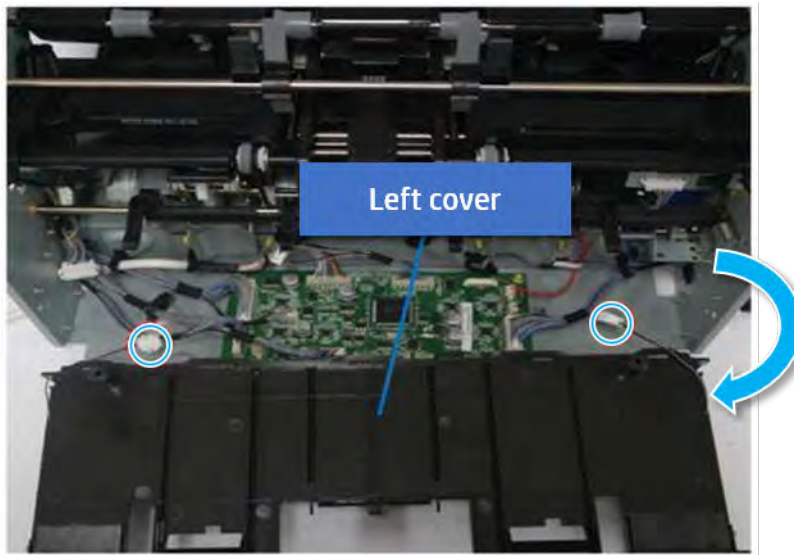
2. Remove four screws from both front and rear sides.


Figure 6-141 Remove four screws

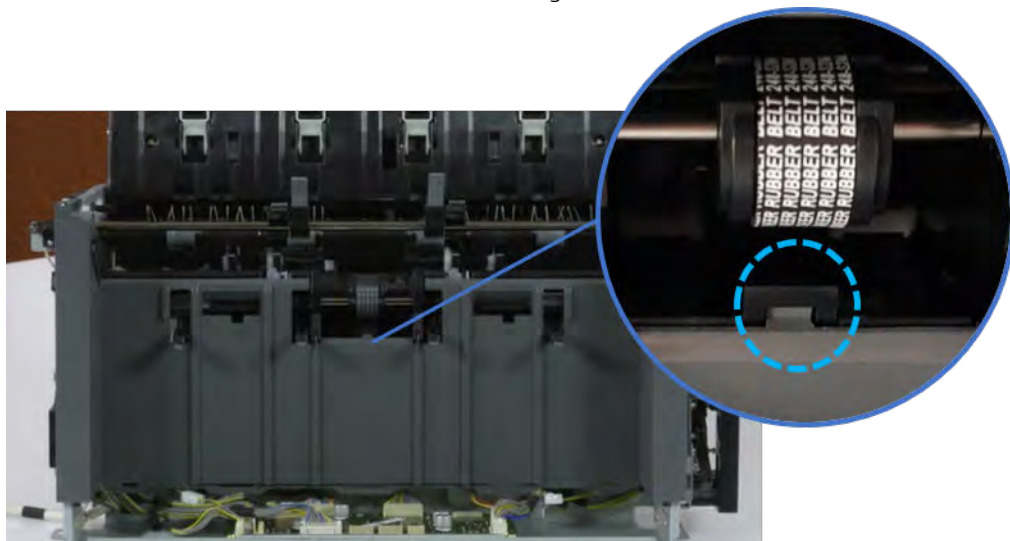


3. Unplug two inline connectors, and then remove the left cover.

Figure 6-142 Unplug two connectors



 **TIP:** Be sure to check the hook when reassembling.



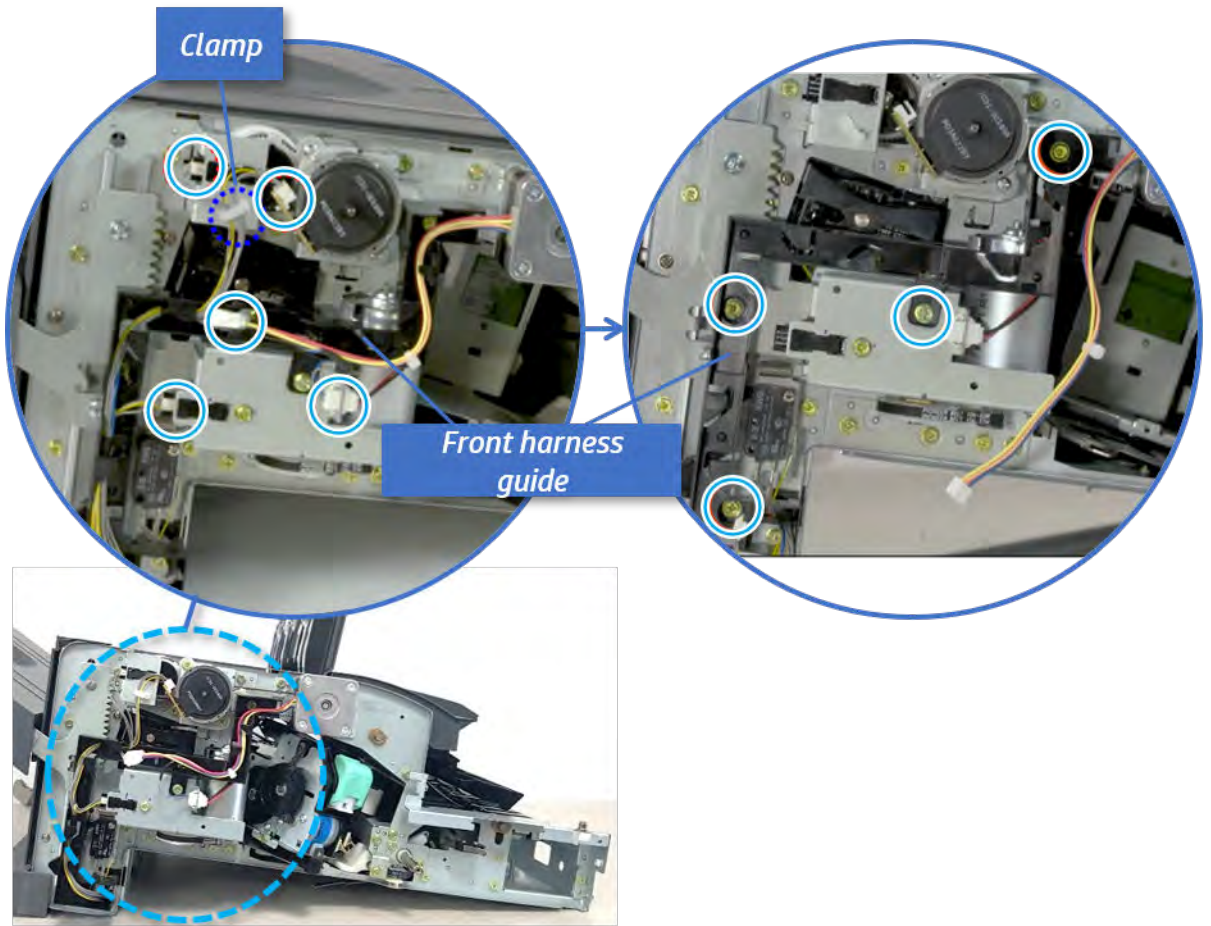
### Remove the front harness guide

Follow these steps to remove the front harness guide.

1. Open one clamp and unplug five connectors, and then remove the wire harness from the front harness guide.

2. Remove four screws, and then remove the front harness guide.

Figure 6-143 Remove the front harness guide

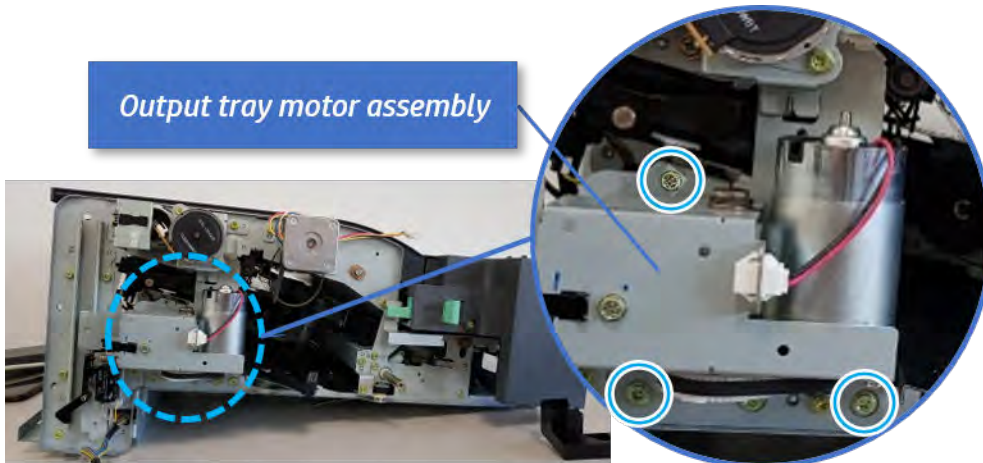


### Remove the output tray motor assembly

Follow these steps to remove the output tray motor assembly.

- ▲ Remove three screws, and then remove the output tray motor assembly.

Figure 6-144 Remove the output tray motor assembly



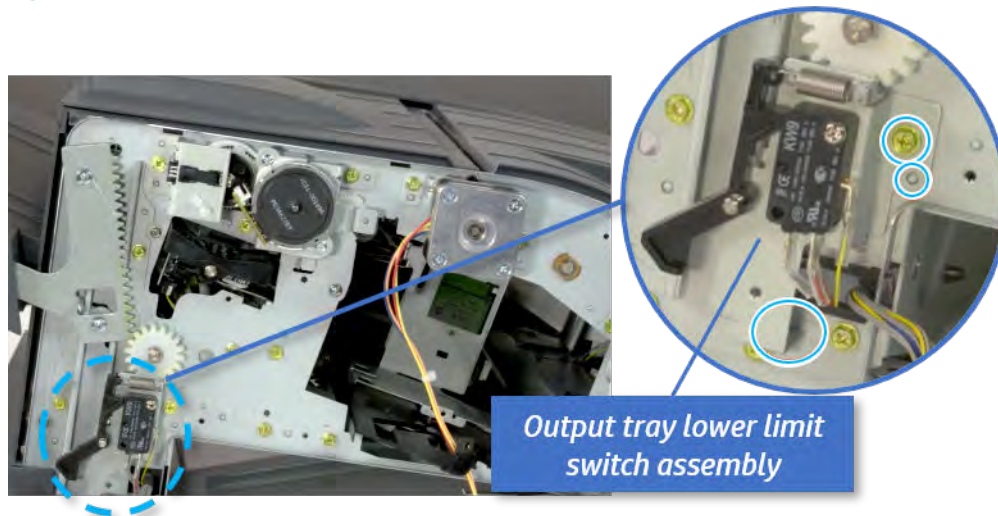


## Remove the output tray lower limit switch

Follow these steps to remove the output tray lower limit switch.

- ▲ Remove one screw, and then remove the output tray lower limit switch.

Figure 6-145 Remove the output tray lower limit switch

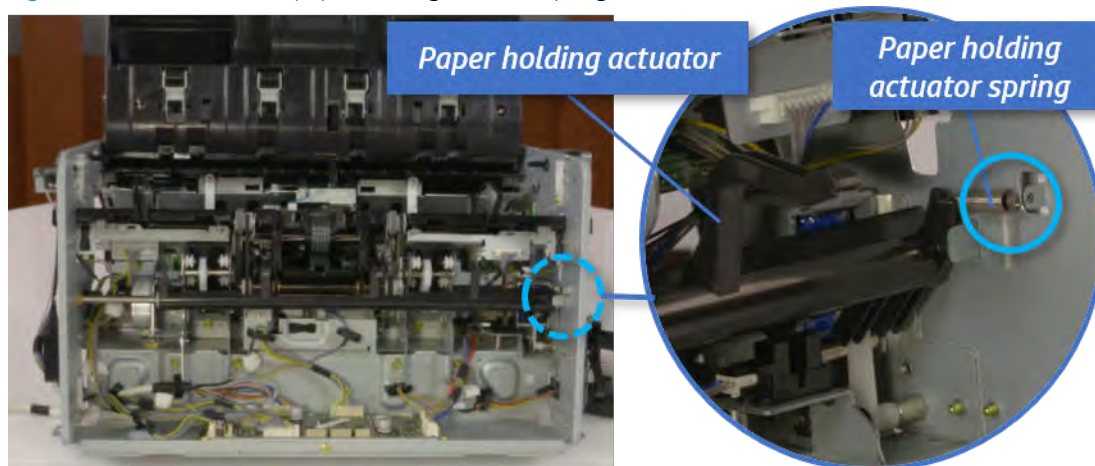


## Remove the paper holding

Follow these steps to remove the paper holding.

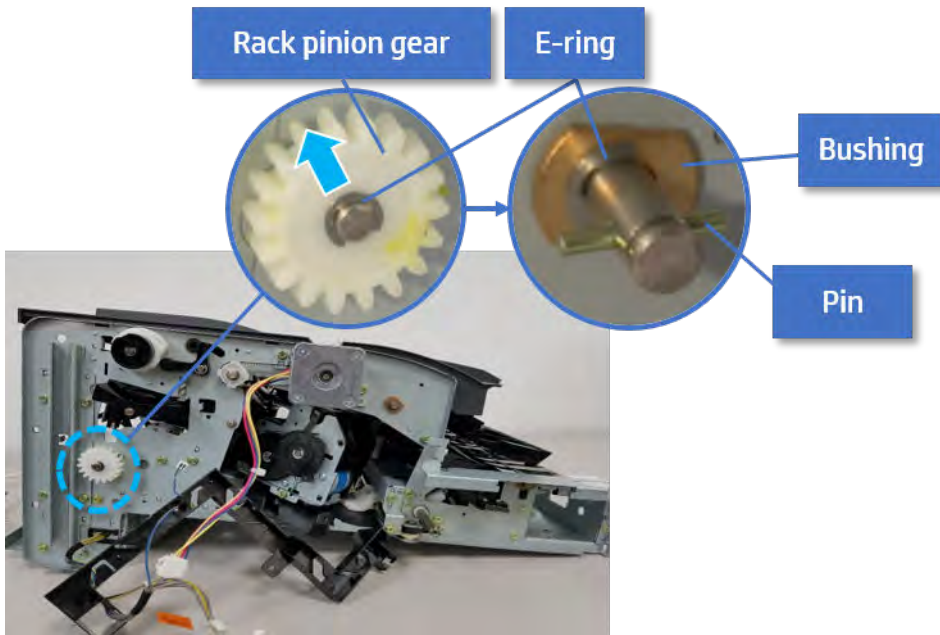
1. Remove the paper holding actuator spring.


Figure 6-146 Remove the paper holding actuator spring



2. Remove the e-ring and the rack pinion gear. And then remove the pin and the e-ring, and then remove the bushing.

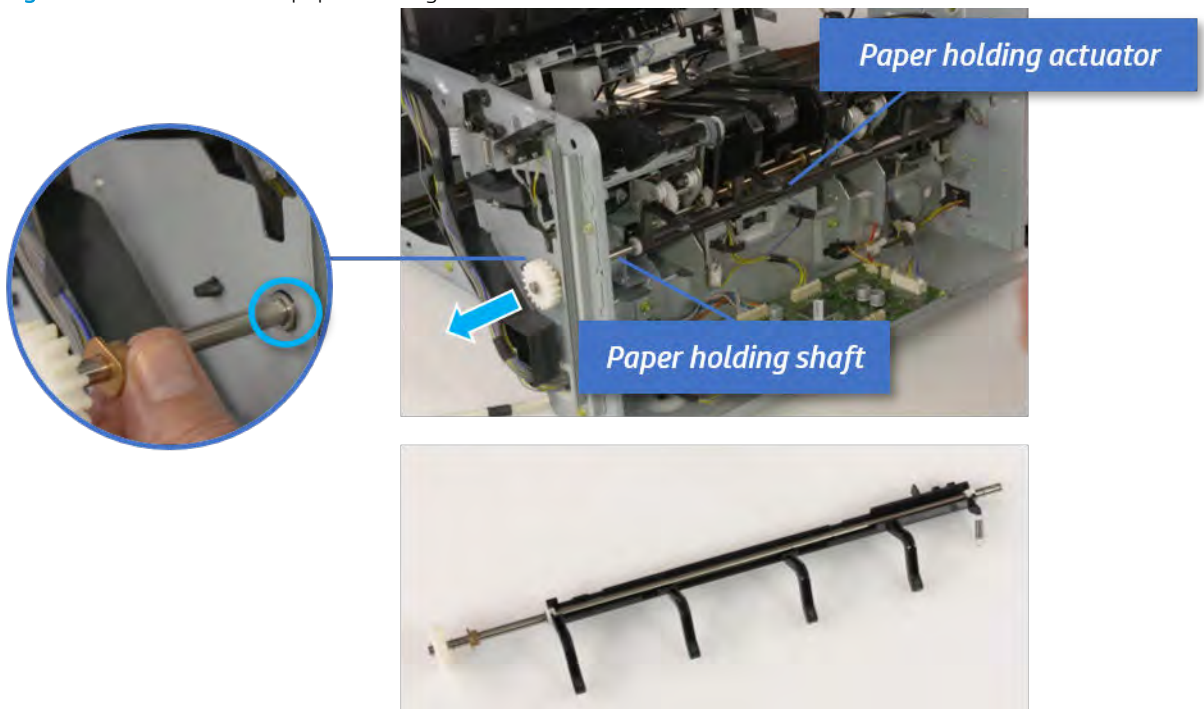
**Figure 6-147** Remove e-ring, rack pinion gear, pin, and bushing



 **NOTE:** Be sure not to lose the pin.

3. Carefully remove the paper holding shaft and the actuator.

**Figure 6-148** Remove the paper holding shaft and the actuator

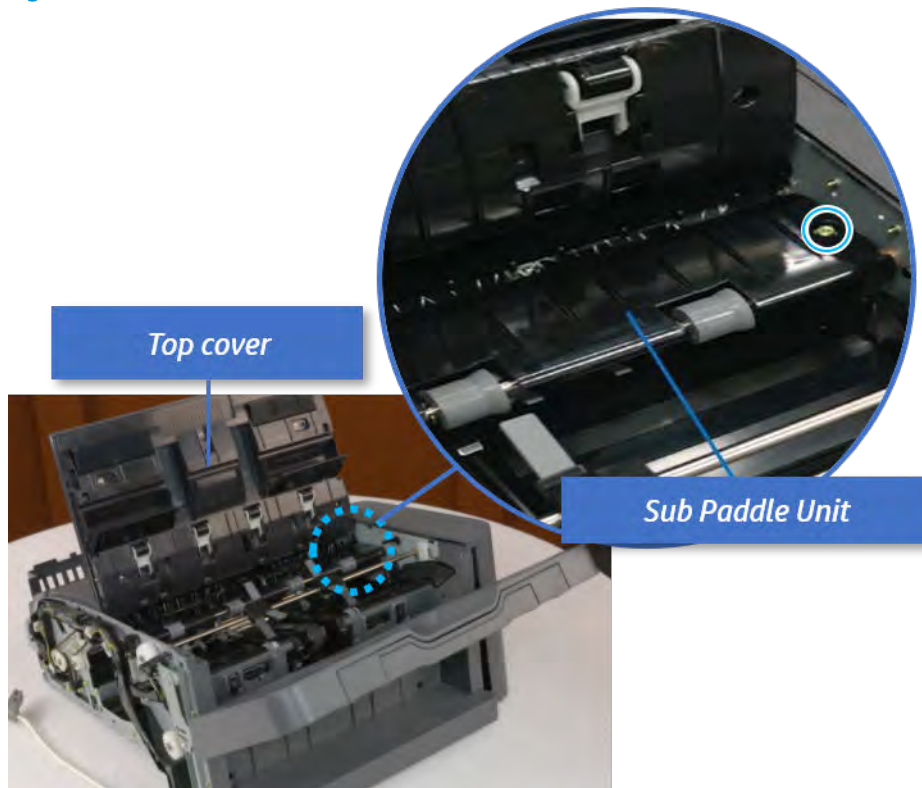


### Remove the sub paddle unit

Follow these steps to remove the sub paddle unit.

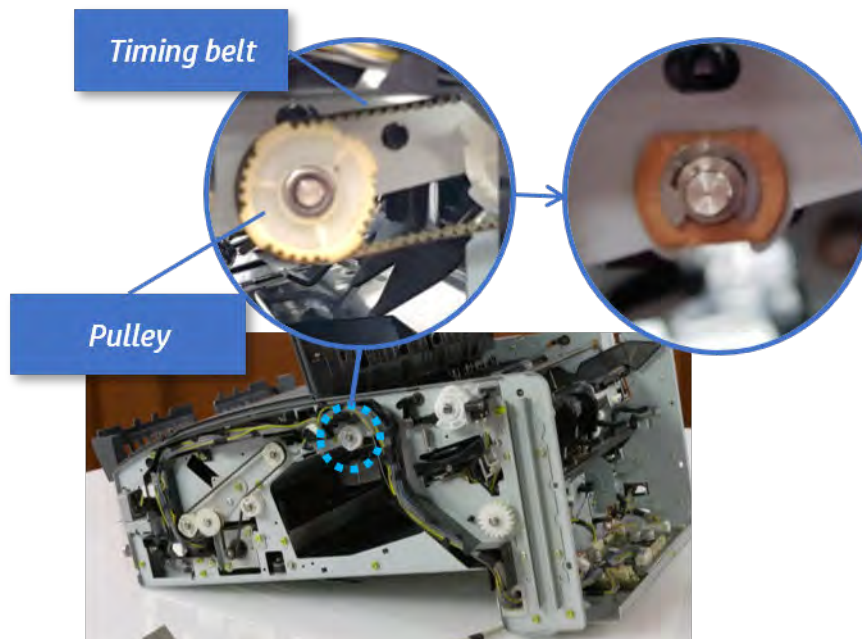
1. Open the top cover, and then remove one screw securing the sub paddle unit.

Figure 6-149 Remove one screw



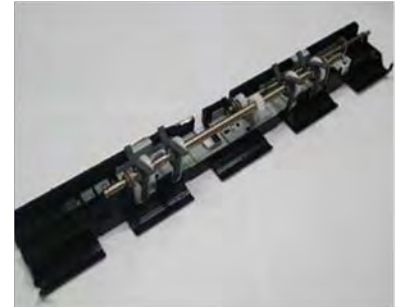
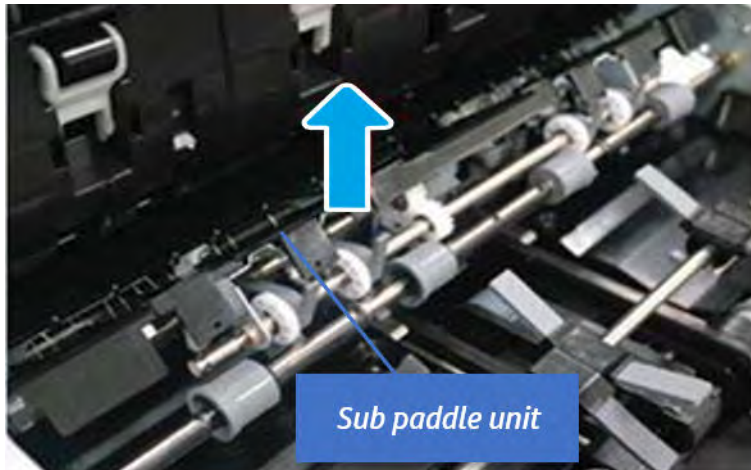
2. Remove the e-ring, and then remove the pulley and timing belt. And then remove the e-ring and the bushing.

Figure 6-150 Remove the e-ring, pulley, timing belt, and bushing



3. Lift up and remove the sub paddle unit.

Figure 6-151 Remove the sub paddle unit

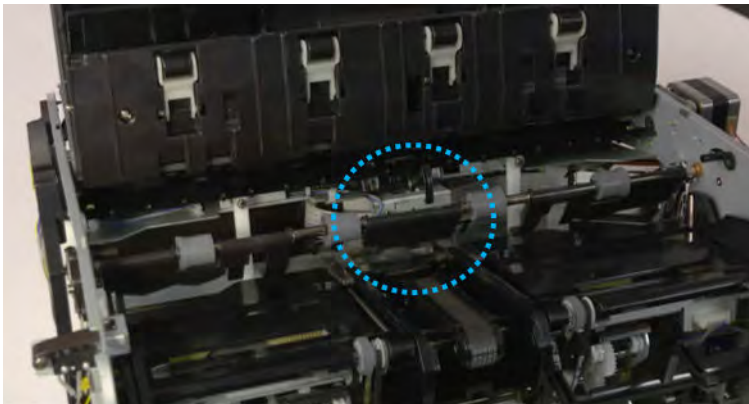


### Remove the exit roller

Follow these steps to remove the exit roller.

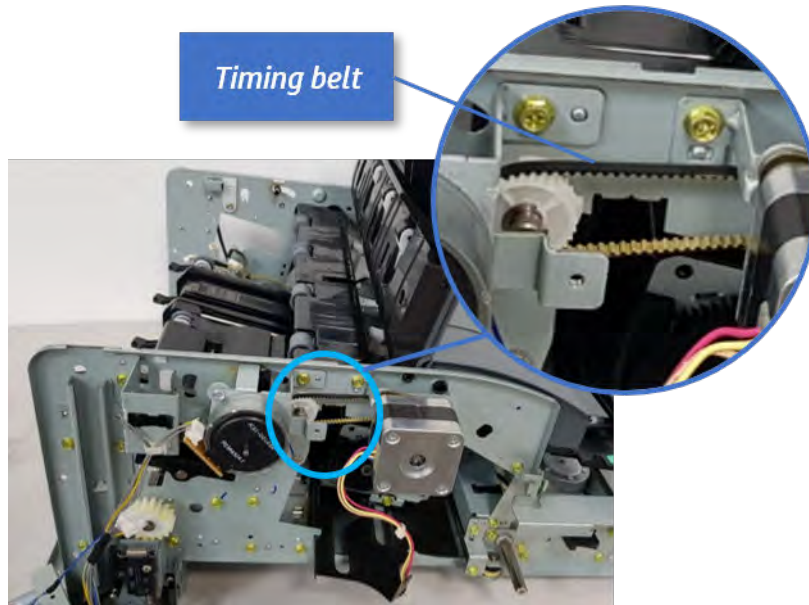
1. Remove the guide on the center of the exit roller.

Figure 6-152 Remove the guide



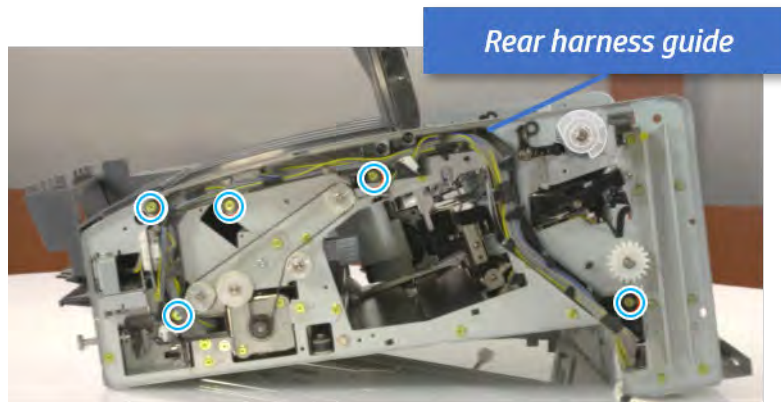
2. On the front of the inner finisher, release the timing belt connected to the exit motor.

Figure 6-153 Release the timing belt



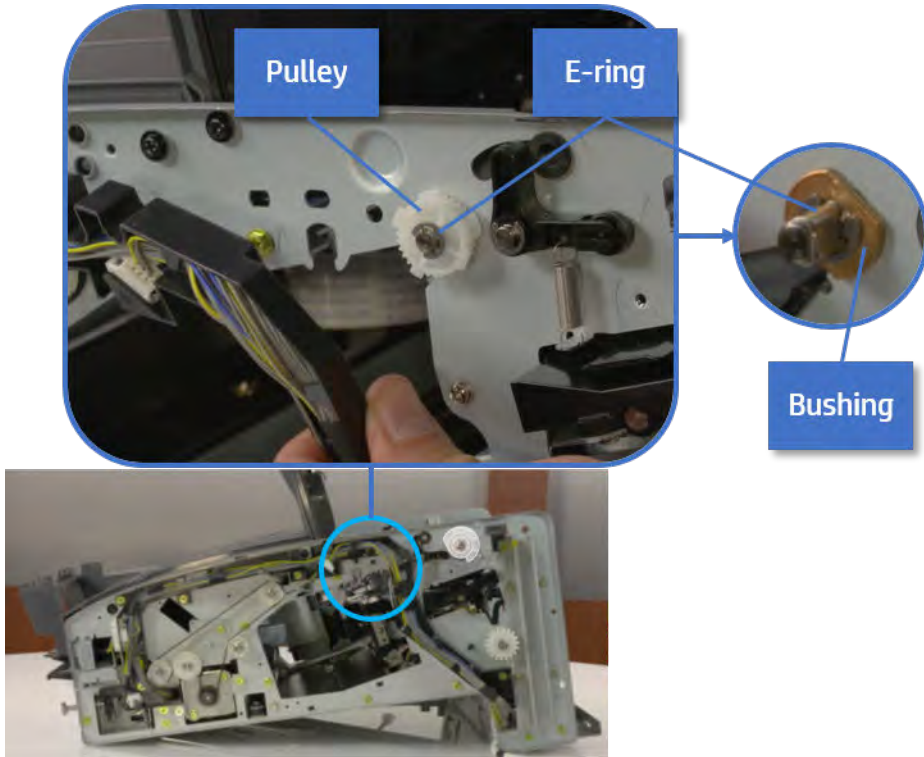
3. Remove five screws securing the rear harness guide.

Figure 6-154 Remove five screws



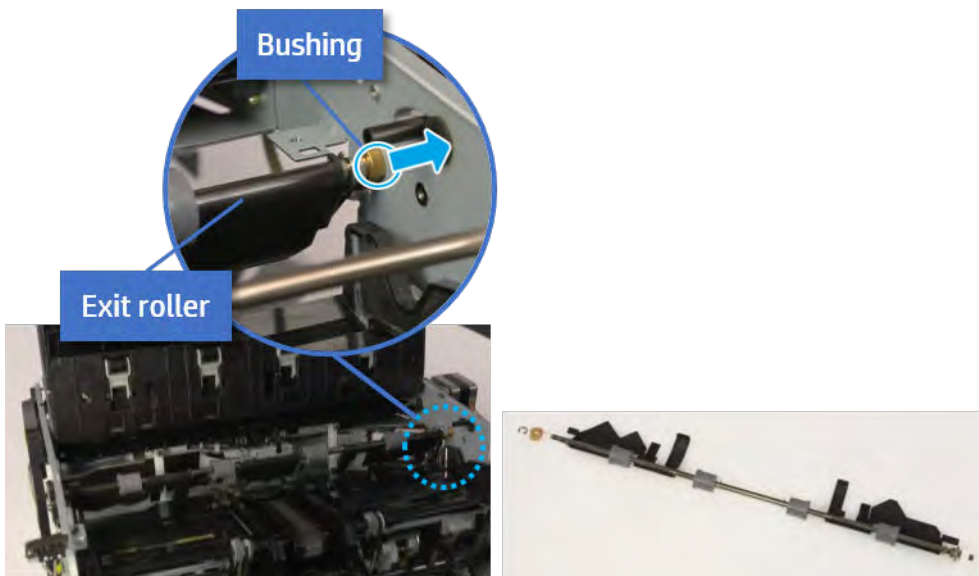
4. On the rear of the inner finisher, remove the e-ring and the pulley and then remove the e-ring and the bushing.

Figure 6-155 Remove e-ring, pulley, and bushing



5. Push the bushing to detach it, and then remove the exit roller.

Figure 6-156 Remove the exit roller

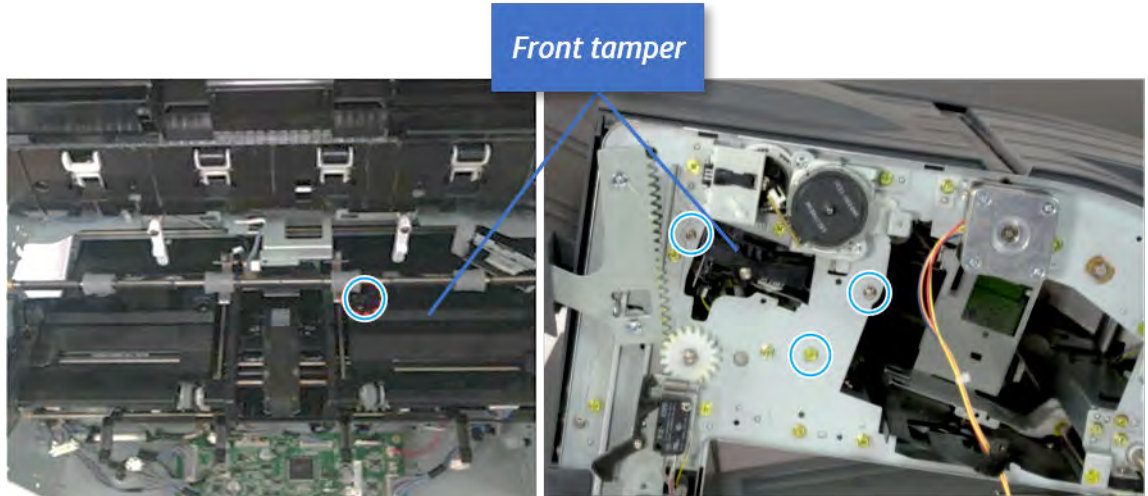


### Remove the front tamper

Follow these steps to remove the front tamper.

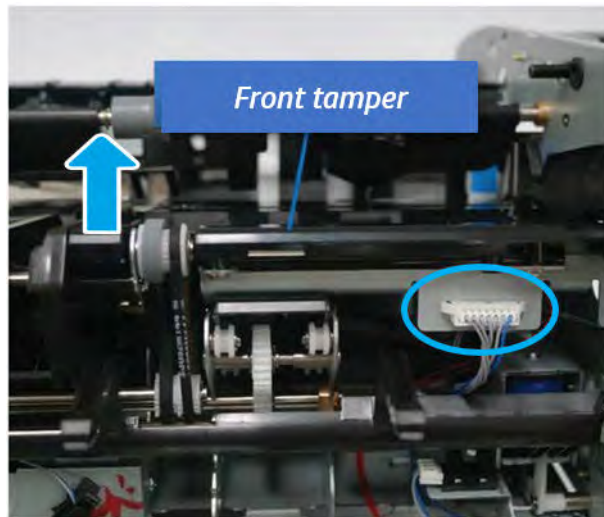
1. Remove four screws.

Figure 6-157 Remove four screws



2. Unplug the connector and release the hook, and then pull the front tamper up to remove.

Figure 6-158 Remove the front tamper



### Remove the rear tamper

Follow these steps to remove the rear tamper.

1. Remove four screws.


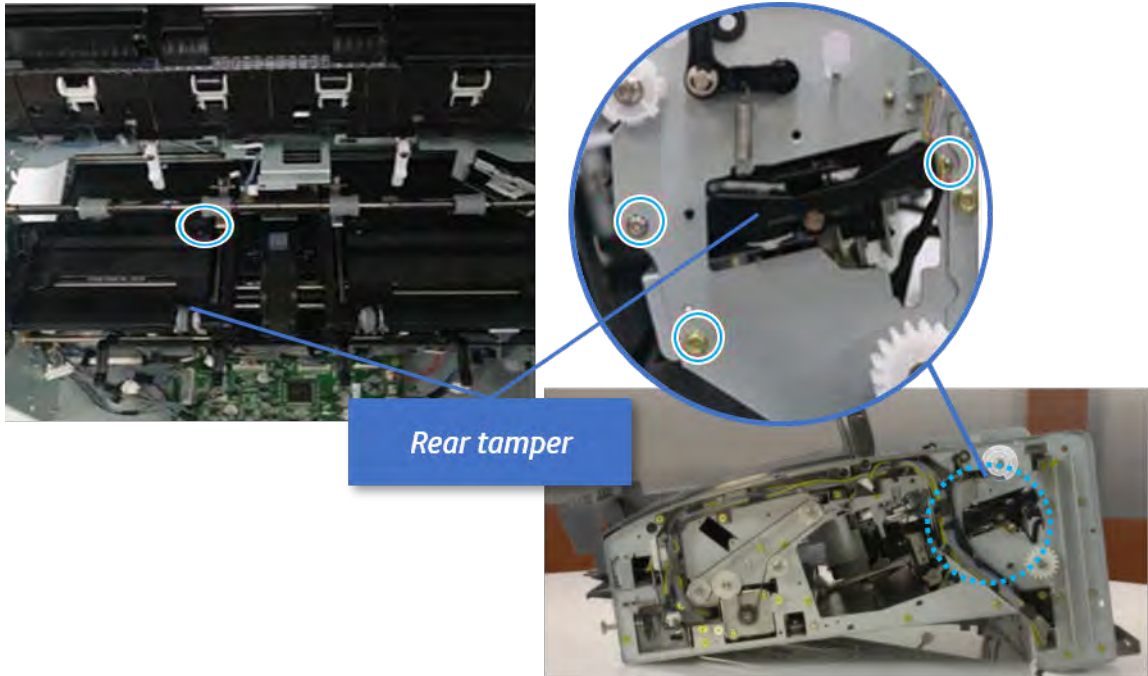
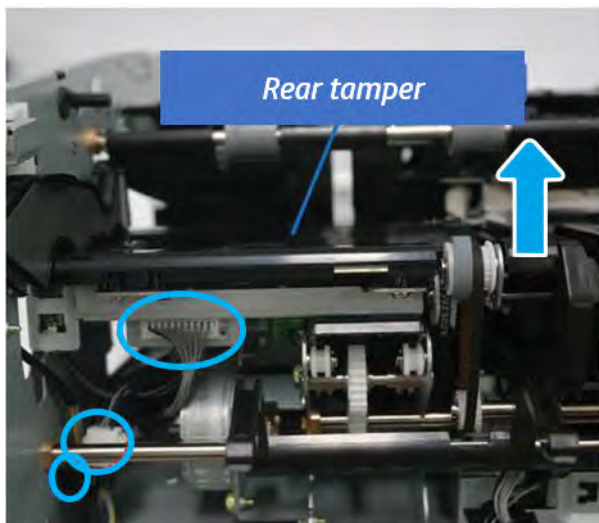
 **NOTE:** Move cable guideout of position to access the screws.

Figure 6-159 Remove four screws



2. Unplug two connectors and release the hook, and then remove the rear tamper.

Figure 6-160 Remove the rear tamper



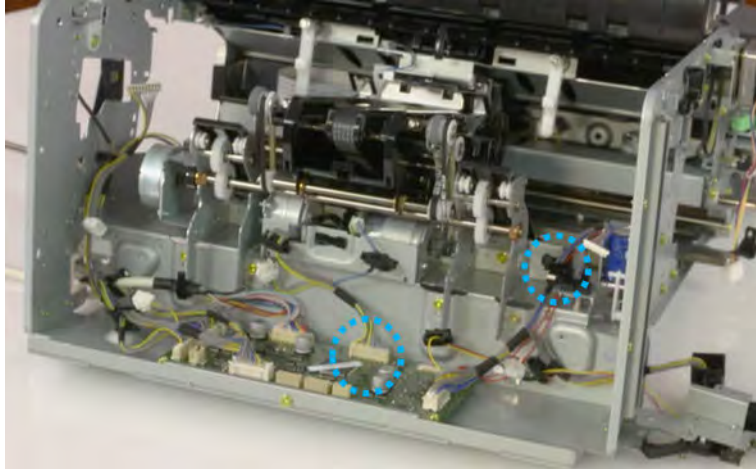
### Remove the ejector & paper support assembly

Follow these steps to remove the ejector & paper support assembly.

1. Open one clamp, disconnect one connector.

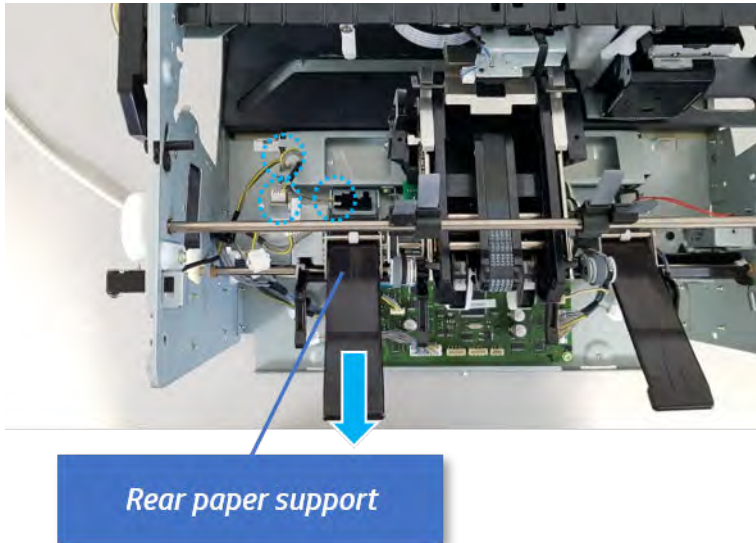


Figure 6-161 Disconnect one connector



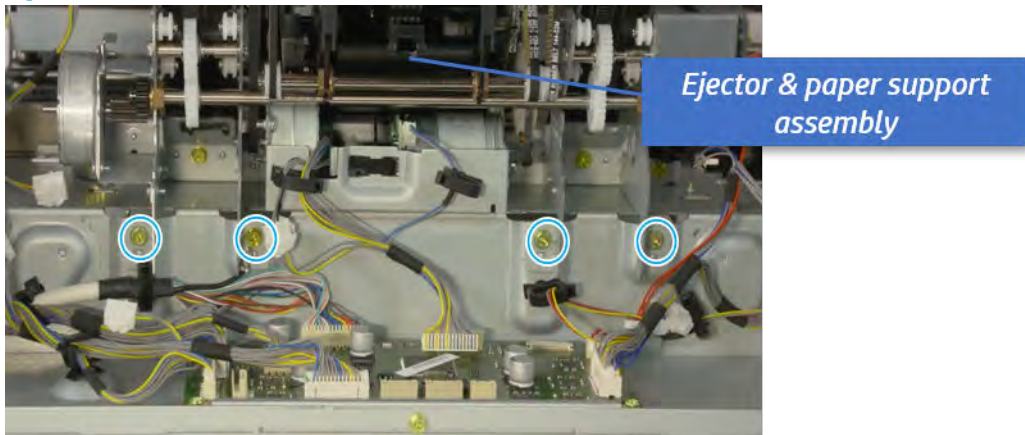
2. Pull the rear paper support up, and then release one clamp and disconnect two connectors.

Figure 6-162 Disconnect two connector



3. Remove four screws, and then remove the ejector & paper support assembly.

Figure 6-163 Remove the ejector & paper support assembly

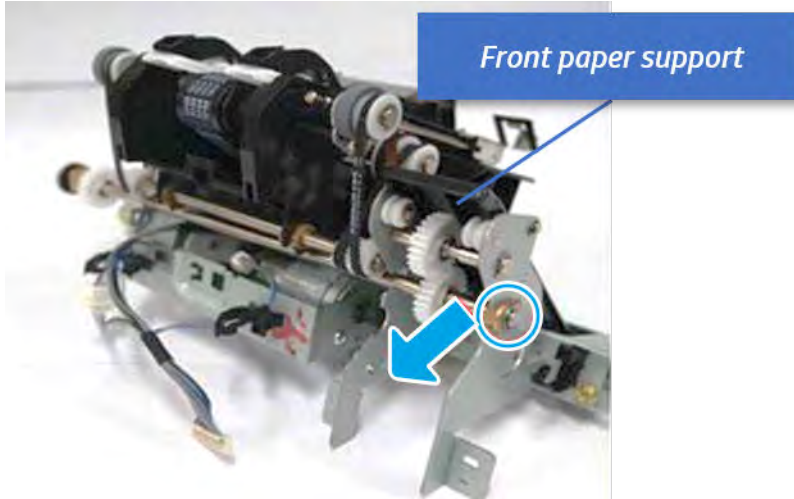


## Remove the front paper support

Follow these steps to remove the front paper support.

1. Remove the e-ring and the bushing, and then pull and remove the drive shaft.

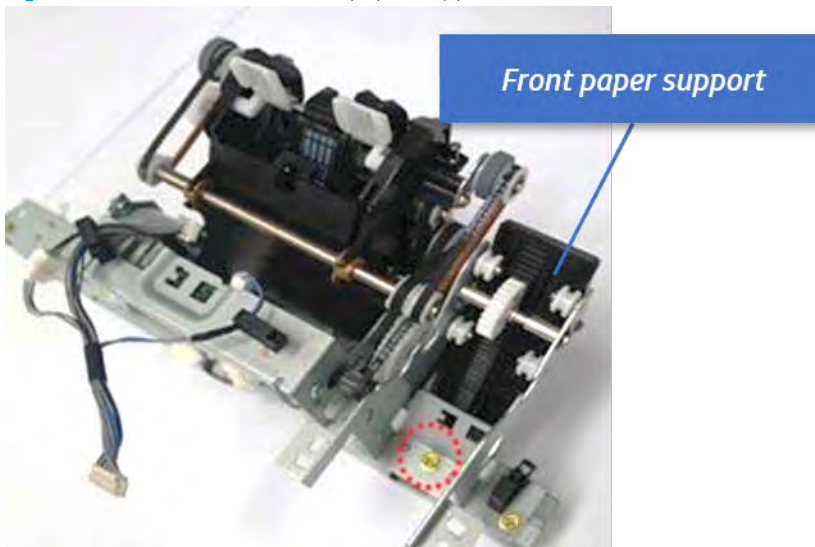
**Figure 6-164** Remove the drive shaft



**TIP:** When reassembling the drive shaft, ensure the paper supports are in the full down position (against the stops).

2. Remove one screw, and then remove the front paper support.

**Figure 6-165** Remove the front paper support



## Unpack the replacement assembly

Follow these steps to unpack the replacement assembly.

1. Dispose of the defective part.



---

 **NOTE:** HP recommends responsible disposal of the defective part.


<http://www8.hp.com/us/en/hp-information/environment/product-recycling.html>

---

2. Unpack the replacement part from the packaging.


 **CAUTION:**  Some parts are sensitive to electrostatic discharge (ESD). Always perform service work at an ESD-protected workstation or mat. If an ESD workstation or mat is not available, touch the sheet-metal chassis to provide a static ground before touching an ESD-sensitive assembly. Protect the ESD-sensitive assemblies by placing them in ESD pouches when they are out of the printer.

 **IMPORTANT:** Make sure that all of the shipping materials (for example shipping tape) are removed from the replacement part prior to installation.

 **NOTE:** If the replacement part is a roller or pad, avoid touching the spongy part of it. Skin oils on the roller or pad can cause paper pickup and/or print-quality problems. HP recommends using disposable gloves when handling rollers or pads or washing your hands before touching rollers or pads.

---

3. To install an assembly, reverse the removal steps.

 **NOTE:** When applicable, special installation instructions are provided for an assembly at the end of the removal procedure. Always completely read the removal instructions and follow all special installation instructions.

---

Rear paper support


## Removal and replacement: Rear paper support

Learn how to remove and replace the rear paper support.

To view teardown and reassembling video of the inner finisher, click the link below.

 [View a teardown video of the inner finisher.](#)

 [View a reassembling video of the inner finisher.](#)

 **IMPORTANT:** When applicable, special installation instructions are provided for an assembly at the end of the removal procedure. Always completely read the removal instructions and follow all special installation instructions.


Mean time to repair:

Service level:

## Before performing service

### Turn the printer power off

- Press the power button on the front of the printer, and then turn off the power switch next to the power cable.
- A shutting-down message appears on the control-panel display.

 **WARNING!** To avoid damage to the printer, turn the power off and wait until the printer shuts down before removing the power cable.

- Disconnect the printer power cable after the printer has completely shut down (the control-panel display is blank).

Use the table below to identify the correct part number for your printer. To order the part, go to <http://www.hp.com/buy/parts>.

**Table 6-45 Part information**

Part number	Part description
JC90-01311A	Rear paper support

## Required tools

- #2 JIS screwdriver with a magnetic tip

## After performing service

### Turn the printer power on

- Connect the power cable.
- Use the power switch to turn the power on.

## Post service test

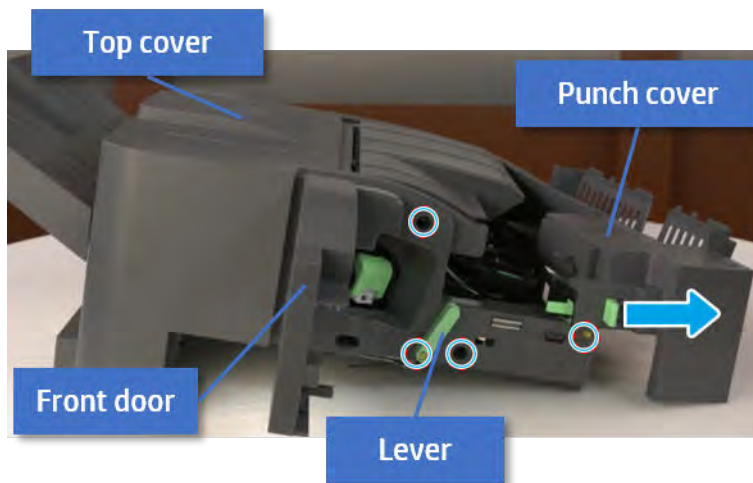
Print any pages necessary to verify that the repair resolved the issue and did not create any new issues.

## Remove the front cover

Follow these steps to remove the front cover.

1. Open the front door and open the punch cover.
2. Remove three screws in the front.
3. Remove the lever.
4. Open the top cover.
5. From the right side of the front cover, carefully lift and pry toward the top-left corner to remove the front cover.

Figure 6-166 Remove the front cover

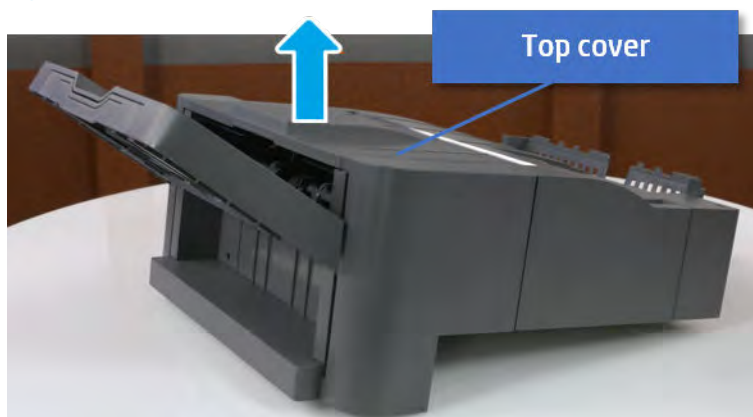


## Remove the rear cover

Follow these steps to remove the rear cover.

1. Open the top cover.

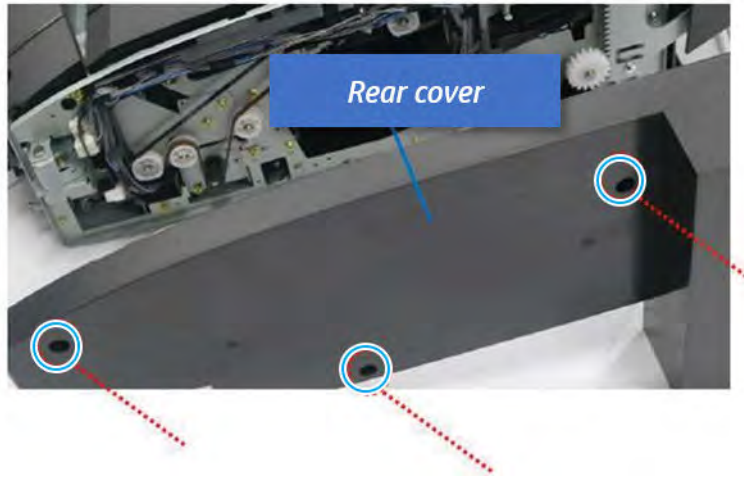
Figure 6-167 Open the top cover



2. Remove three screws.

3. Release hooks carefully and remove the rear cover.

Figure 6-168 Remove the rear cover

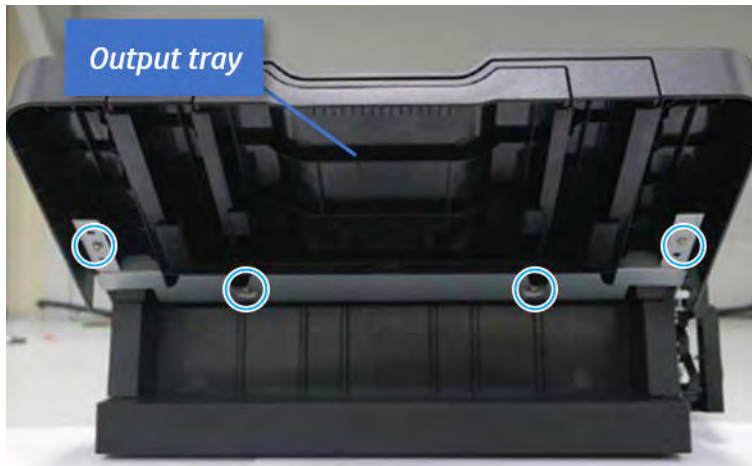


### Remove the output tray

Follow these steps to remove the output tray.

1. Remove four screws.

Figure 6-169 Remove four screws



2. Push the paper holding actuator into the inner finisher, and then remove the output tray.

Figure 6-170 Remove the output tray.

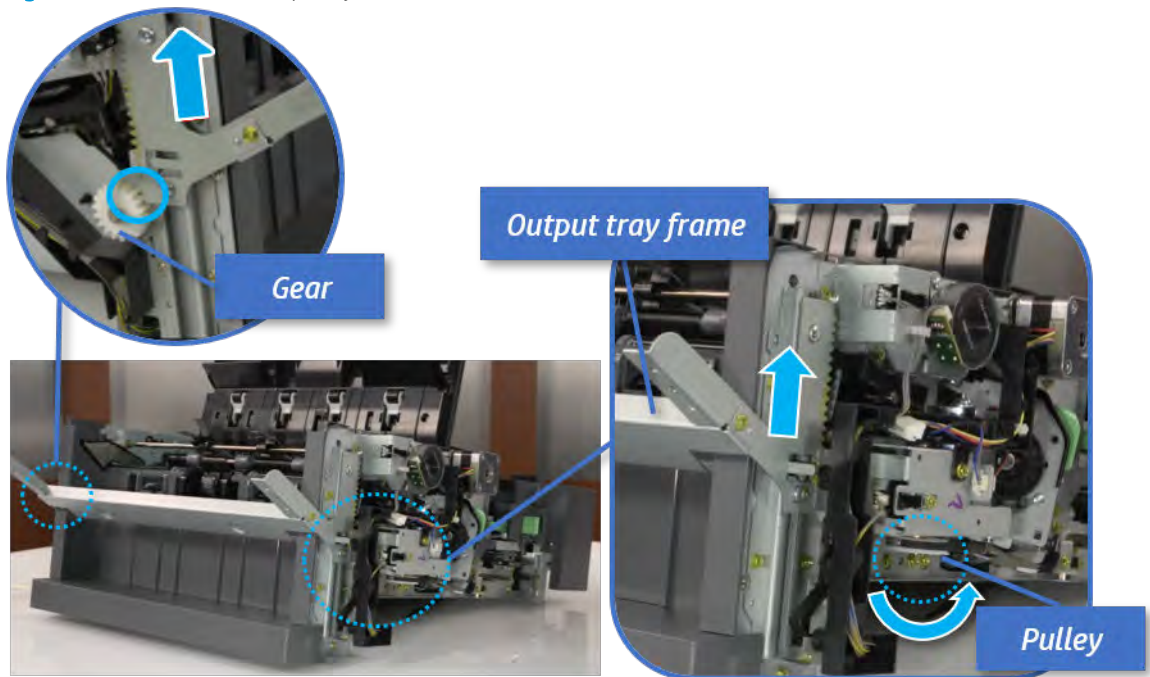


### Remove the output tray frame

Follow these steps to remove the output tray frame.

1. Rotate the pulley until the output tray frame depart from the gear.

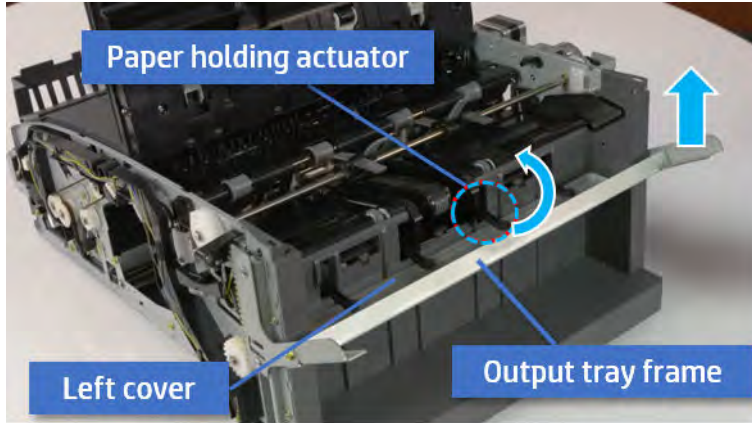
Figure 6-171 Remove the pulley



2. Push the paper holding actuator into the inner finisher, and then remove the output tray frame.

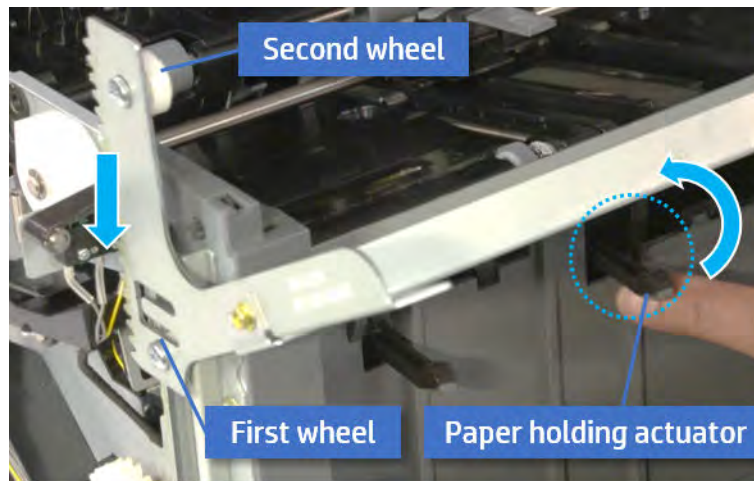


Figure 6-172 Remove the output tray frame

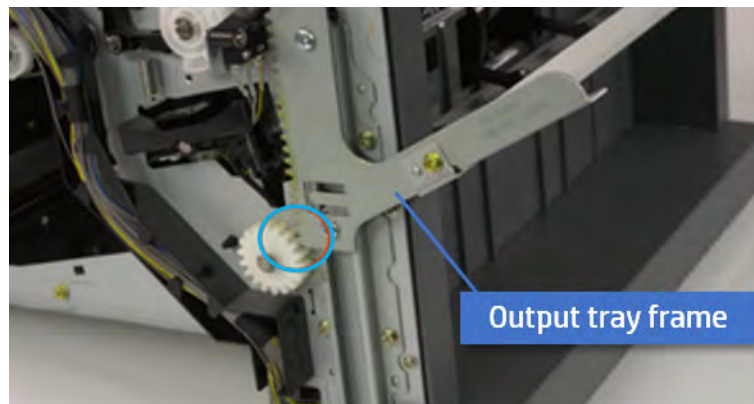


**TIP:** Push the paper holding actuator into the inner finisher when reassembling. Be sure to level the output tray.

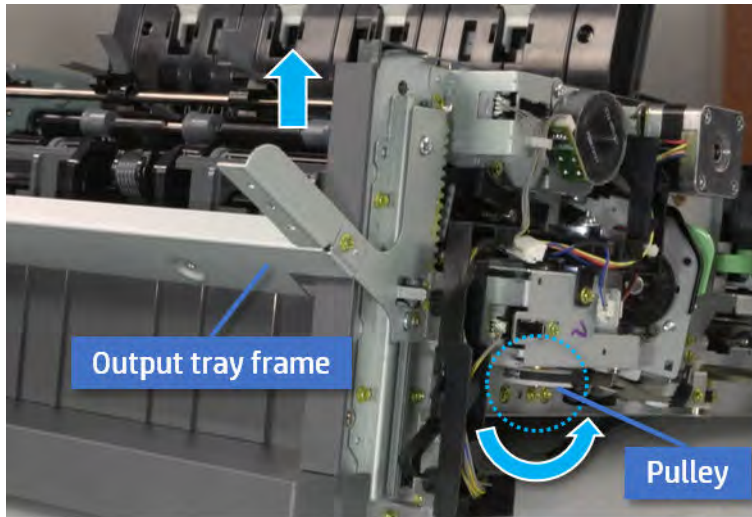
- a. Position the first wheel into the channel on both sides while pushing the paper holding actuator.



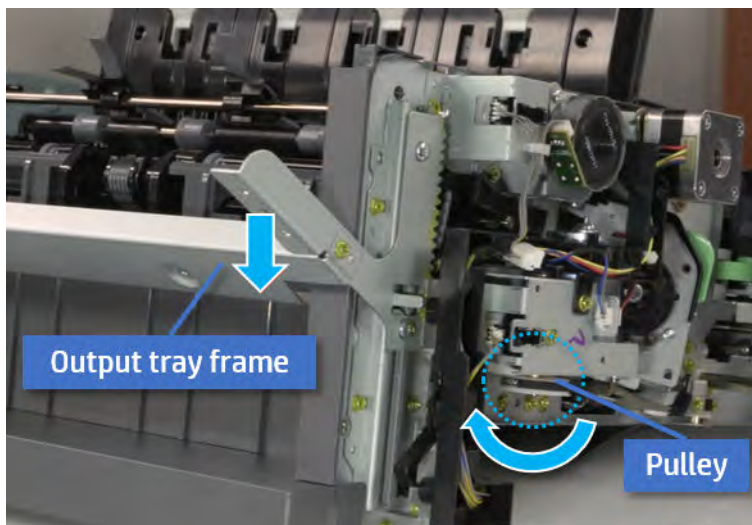
- b. Let the second wheel rest on the channel on both sides simultaneously.
- c. Gently squeeze the wheels into channel until the output tray frame meet the gear.



- d. Rotate the pulley until the output tray frame is no longer lifted. It can make to level the output tray frame.



- e. Rotate the pulley in the opposite direction.

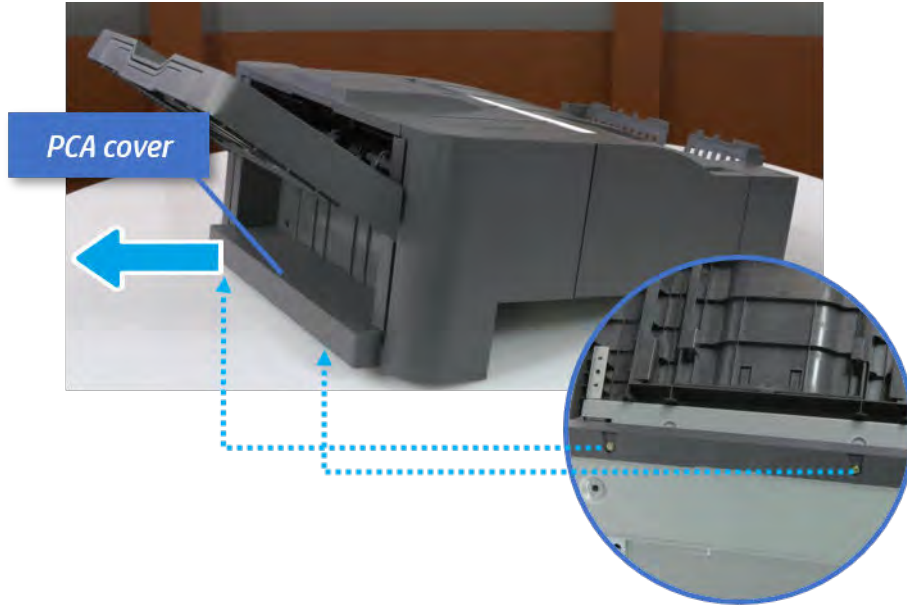


### Remove the PCA cover

Follow these steps to remove the PCA cover.

- ▲ Remove two screws, and then remove the PCA cover.

Figure 6-173 Remove the PCA cover

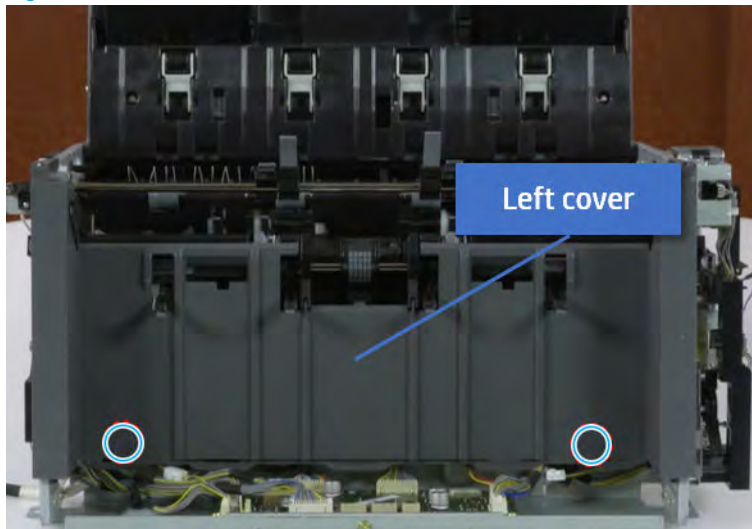


### Remove the left cover

Follow these steps to remove the left cover.

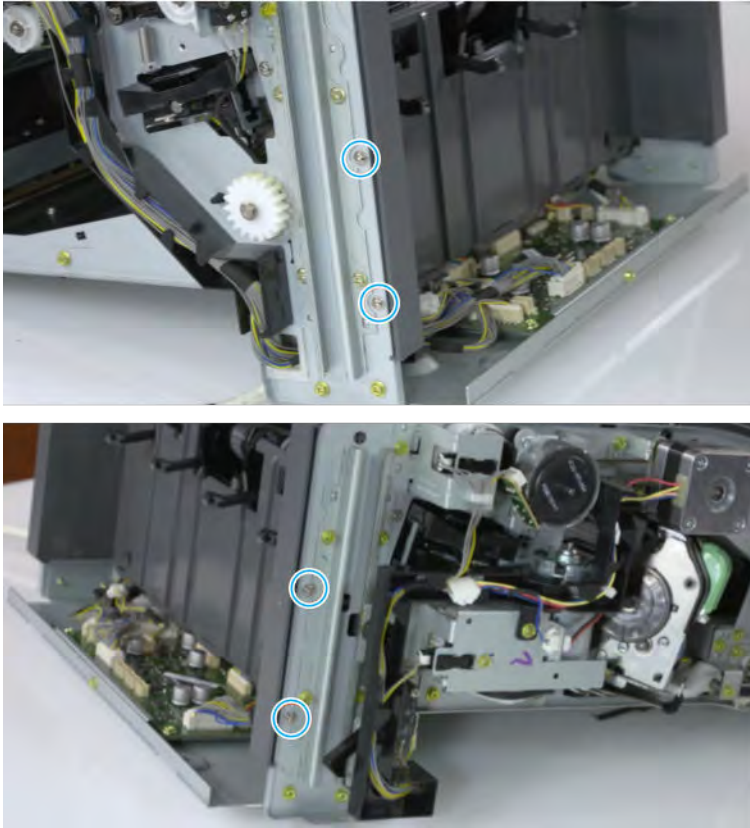
1. Remove two screws.

Figure 6-174 Remove two screws



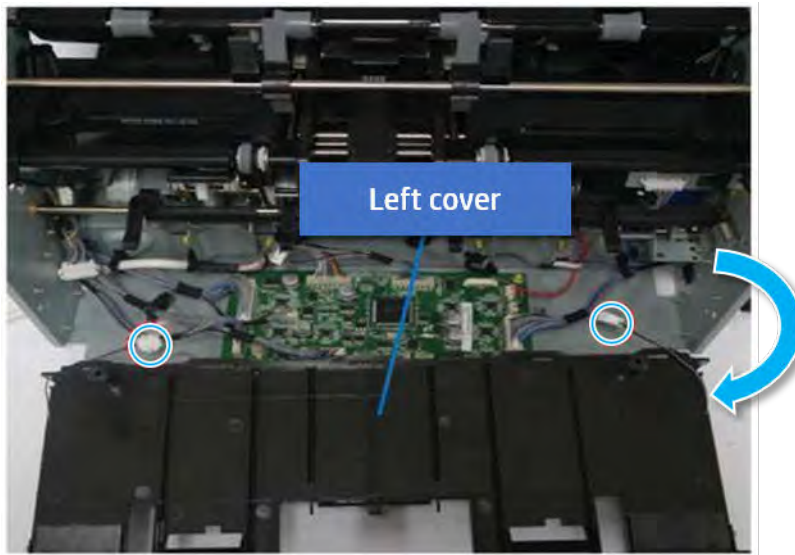
2. Remove four screws from both front and rear sides.


Figure 6-175 Remove four screws

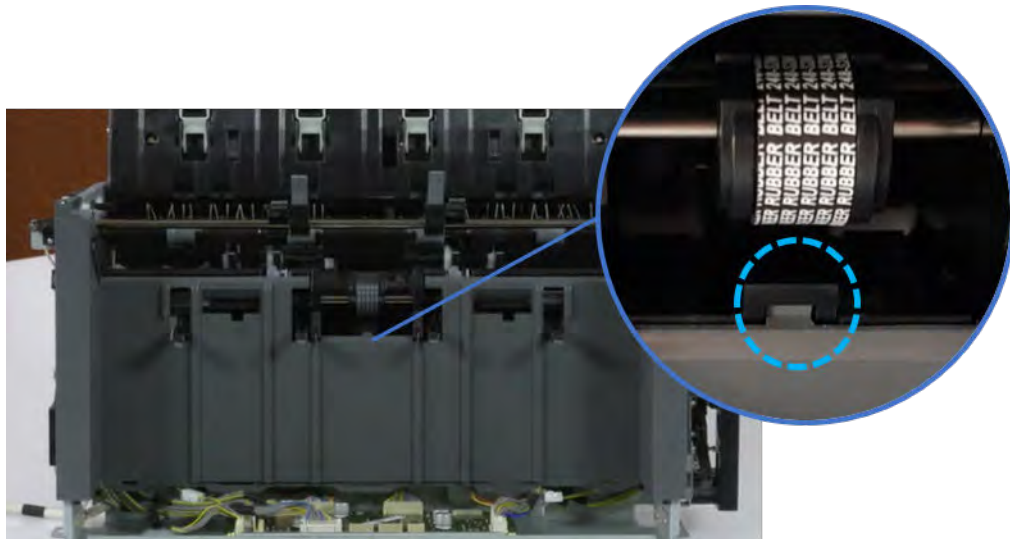


3. Unplug two inline connectors, and then remove the left cover.

Figure 6-176 Unplug two connectors



 **TIP:** Be sure to check the hook when reassembling.



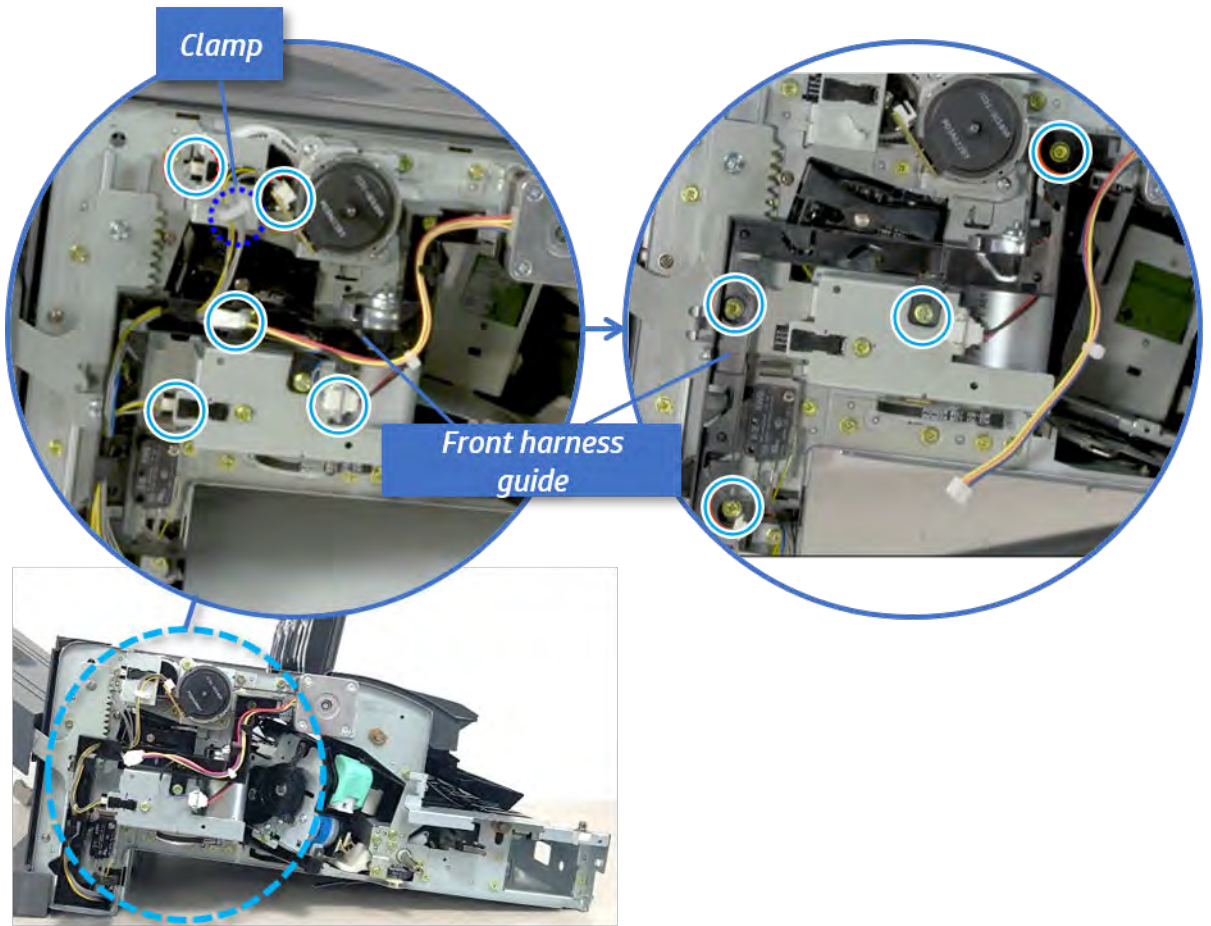
### Remove the front harness guide

Follow these steps to remove the front harness guide.

1. Open one clamp and unplug five connectors, and then remove the wire harness from the front harness guide.

2. Remove four screws, and then remove the front harness guide.

Figure 6-177 Remove the front harness guide

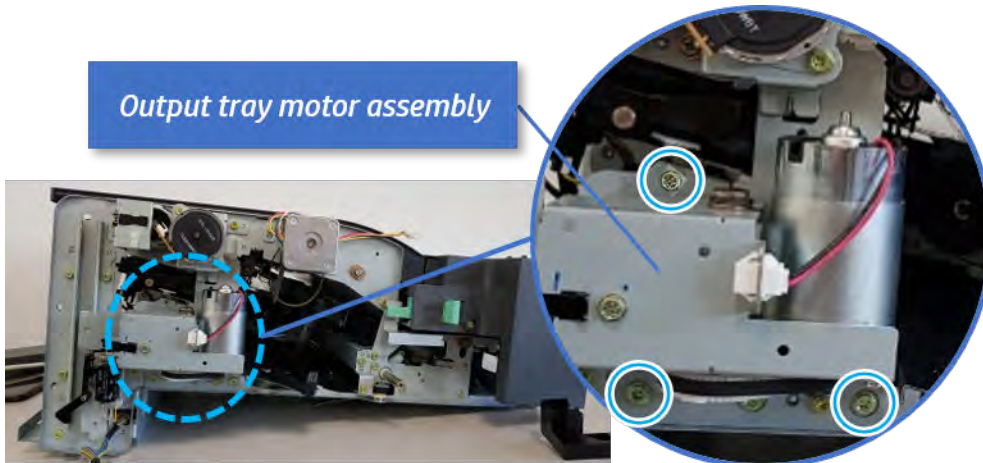


### Remove the output tray motor assembly

Follow these steps to remove the output tray motor assembly.

- ▲ Remove three screws, and then remove the output tray motor assembly.

Figure 6-178 Remove the output tray motor assembly

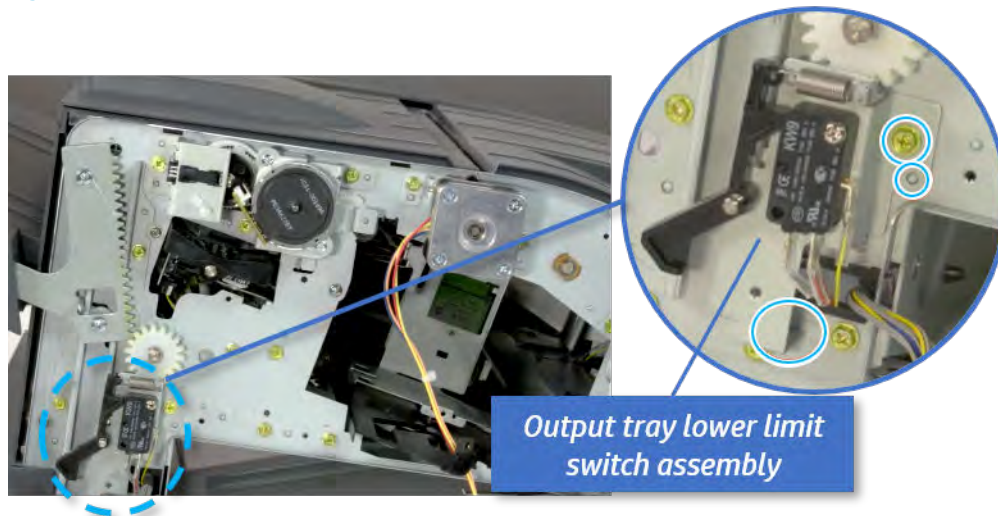


### Remove the output tray lower limit switch

Follow these steps to remove the output tray lower limit switch.

- ▲ Remove one screw, and then remove the output tray lower limit switch.

Figure 6-179 Remove the output tray lower limit switch

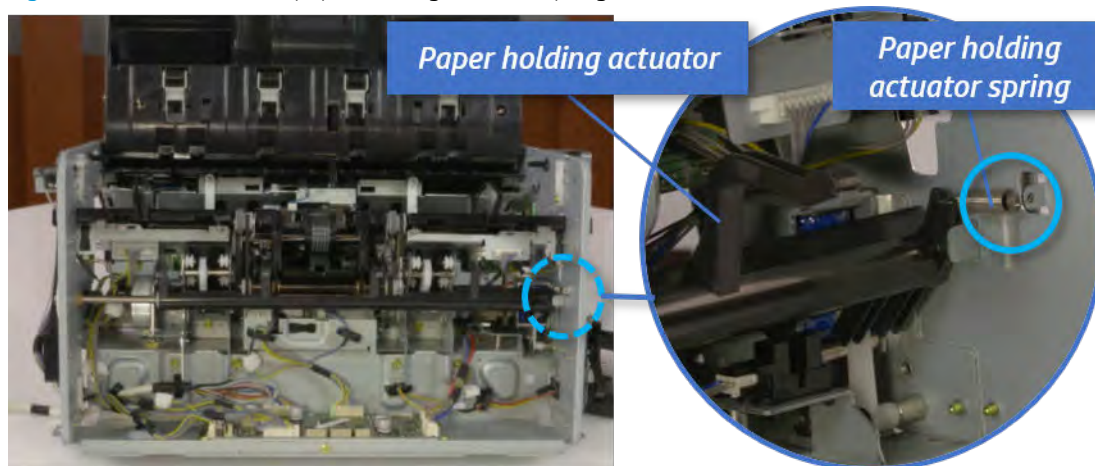


### Remove the paper holding

Follow these steps to remove the paper holding.

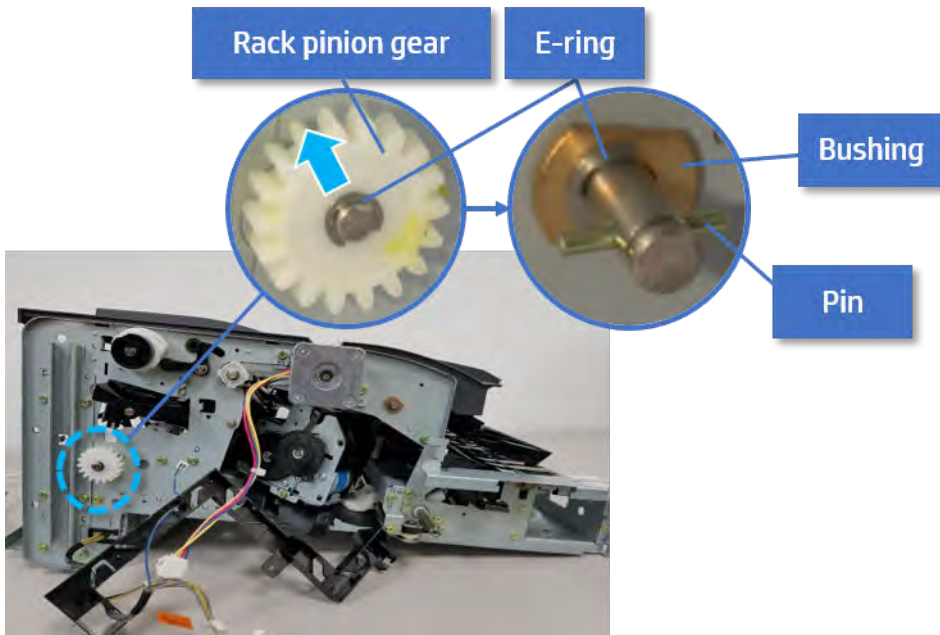
1. Remove the paper holding actuator spring.


Figure 6-180 Remove the paper holding actuator spring



2. Remove the e-ring and the rack pinion gear. And then remove the pin and the e-ring, and then remove the bushing.

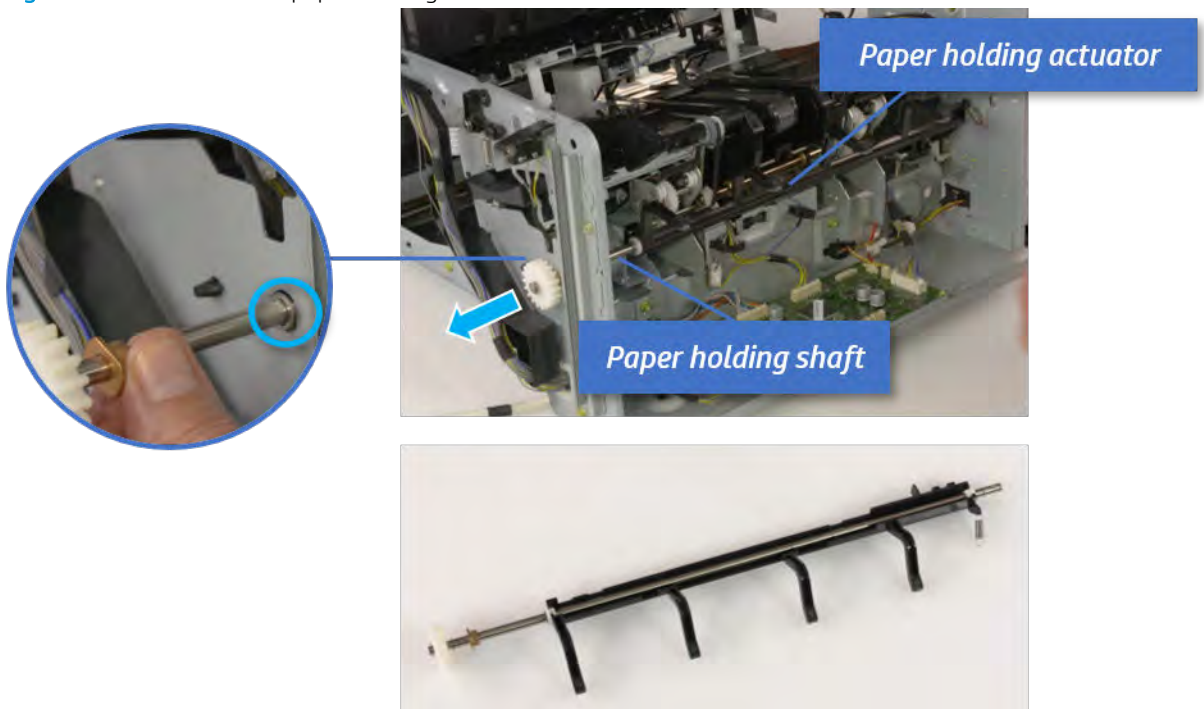
**Figure 6-181** Remove e-ring, rack pinion gear, pin, and bushing



 **NOTE:** Be sure not to lose the pin.

3. Carefully remove the paper holding shaft and the actuator.

**Figure 6-182** Remove the paper holding shaft and the actuator



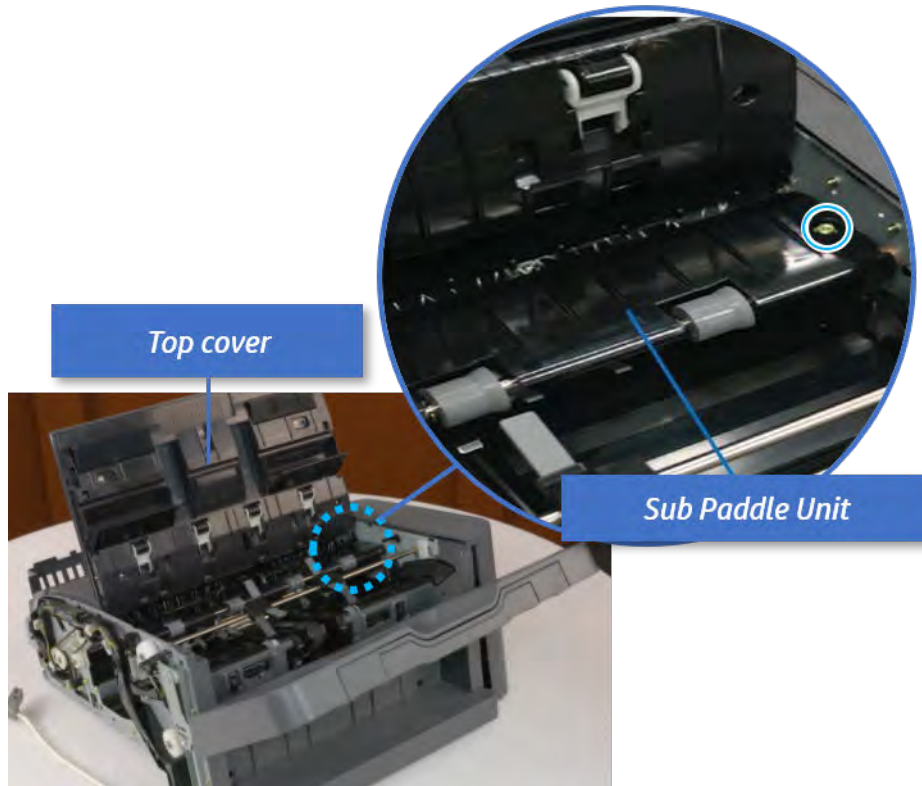
### Remove the sub paddle unit

Follow these steps to remove the sub paddle unit.



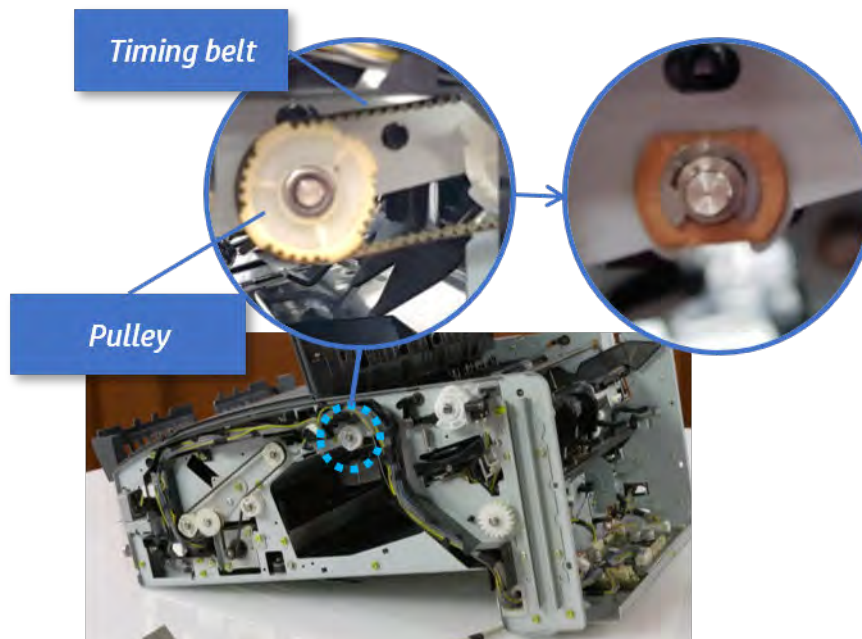
1. Open the top cover, and then remove one screw securing the sub paddle unit.

Figure 6-183 Remove one screw



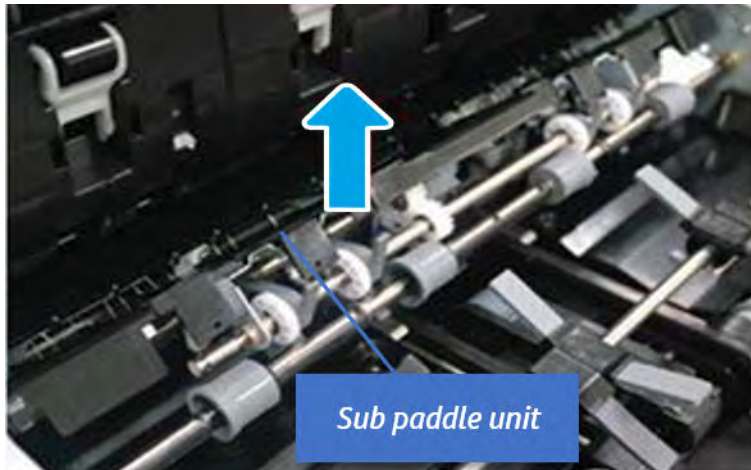
2. Remove the e-ring, and then remove the pulley and timing belt. And then remove the e-ring and the bushing.

Figure 6-184 Remove the e-ring, pulley, timing belt, and bushing



3. Lift up and remove the sub paddle unit.

Figure 6-185 Remove the sub paddle unit

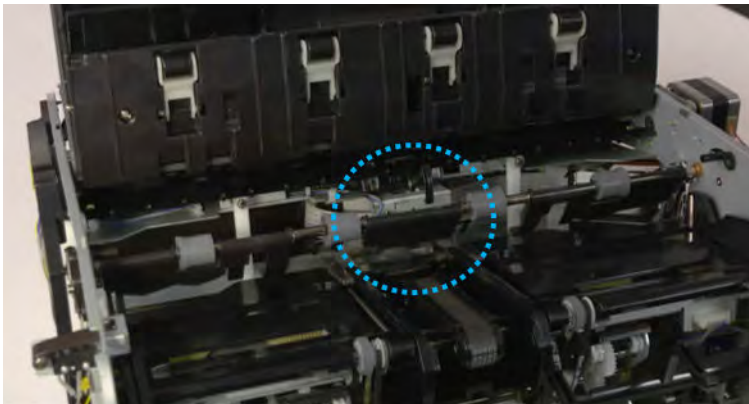


### Remove the exit roller

Follow these steps to remove the exit roller.

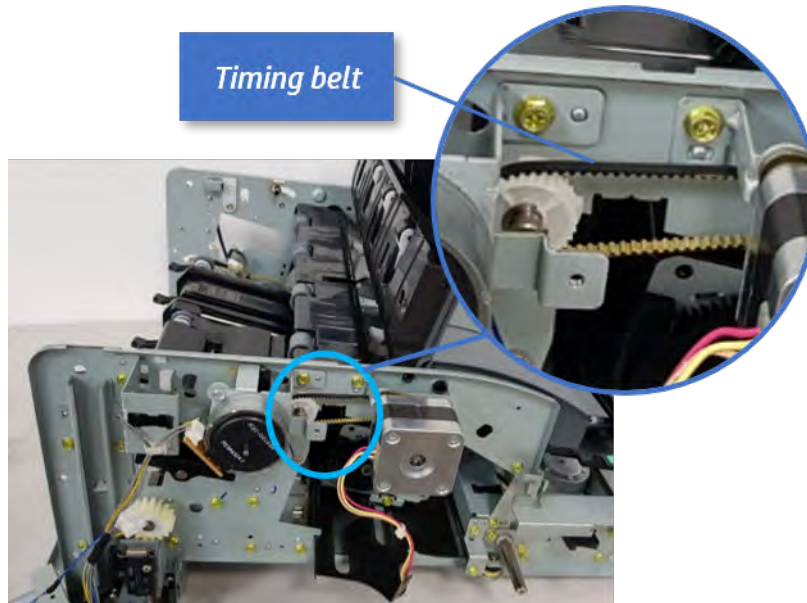
1. Remove the guide on the center of the exit roller.

Figure 6-186 Remove the guide



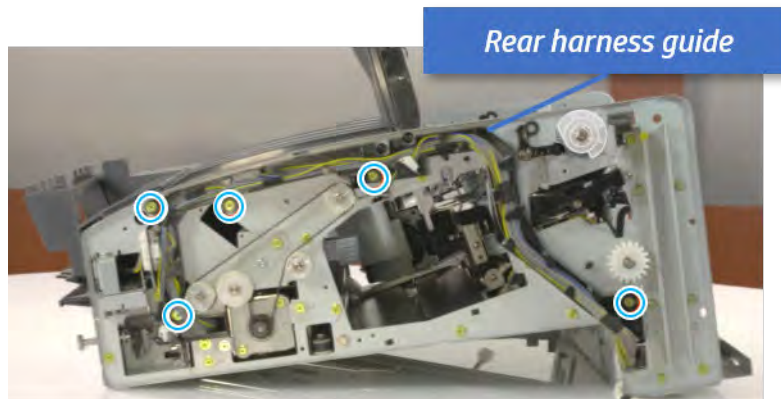
2. On the front of the inner finisher, release the timing belt connected to the exit motor.

Figure 6-187 Release the timing belt



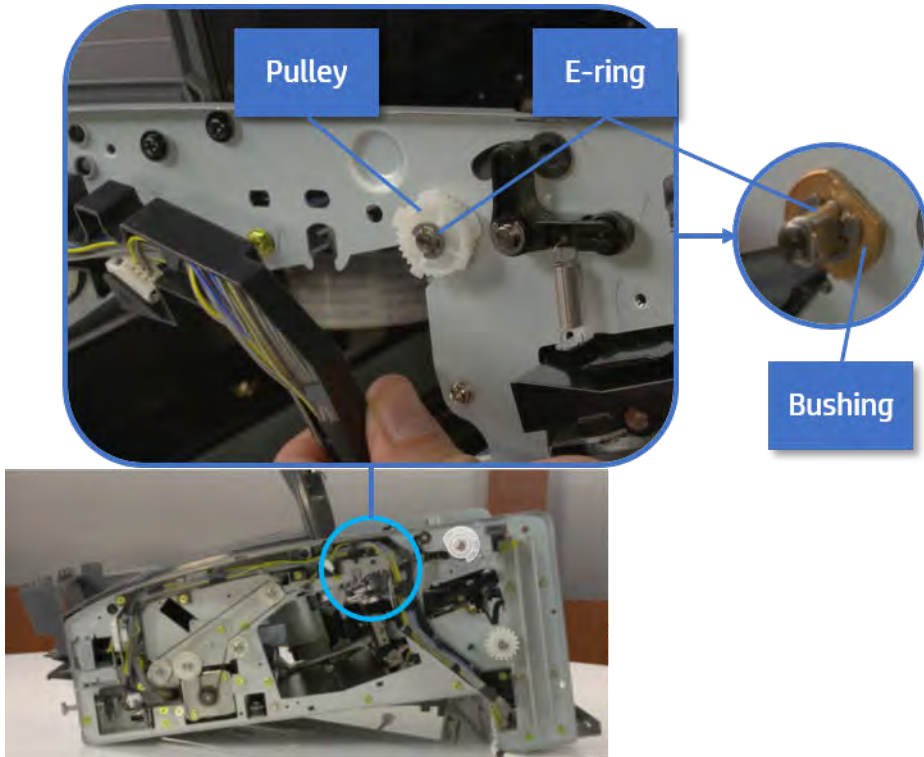
3. Remove five screws securing the rear harness guide.

Figure 6-188 Remove five screws



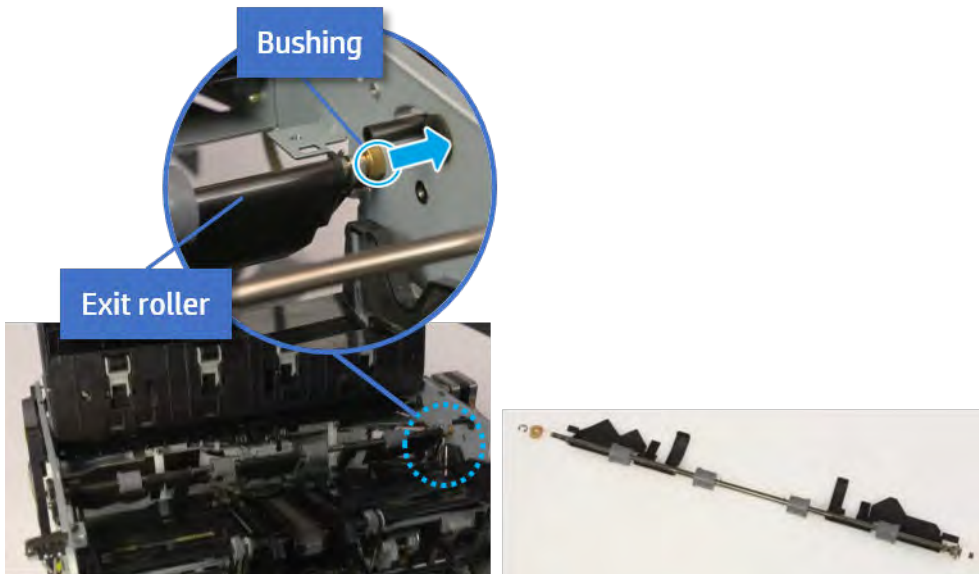
4. On the rear of the inner finisher, remove the e-ring and the pulley and then remove the e-ring and the bushing.

Figure 6-189 Remove e-ring, pulley, and bushing



5. Push the bushing to detach it, and then remove the exit roller.

Figure 6-190 Remove the exit roller

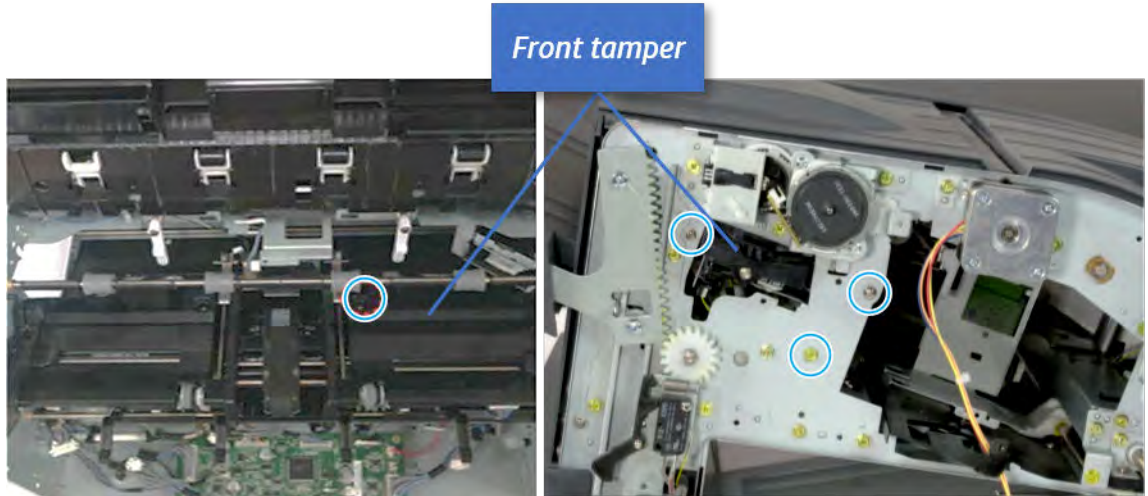


### Remove the front tamper

Follow these steps to remove the front tamper.

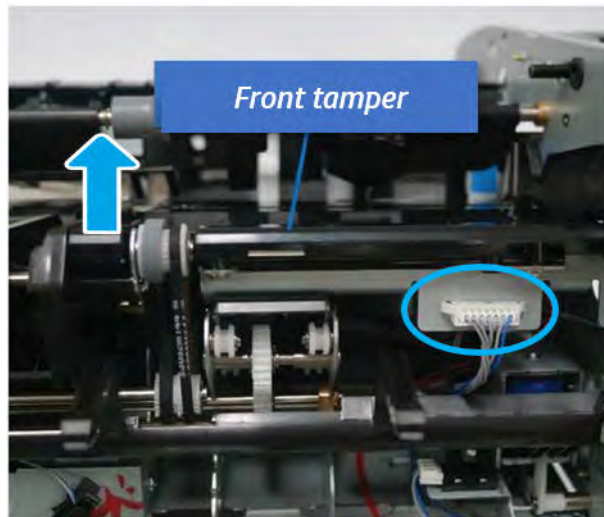
1. Remove four screws.

Figure 6-191 Remove four screws



2. Unplug the connector and release the hook, and then pull the front tamper up to remove.

Figure 6-192 Remove the front tamper



### Remove the rear tamper

Follow these steps to remove the rear tamper.

1. Remove four screws.


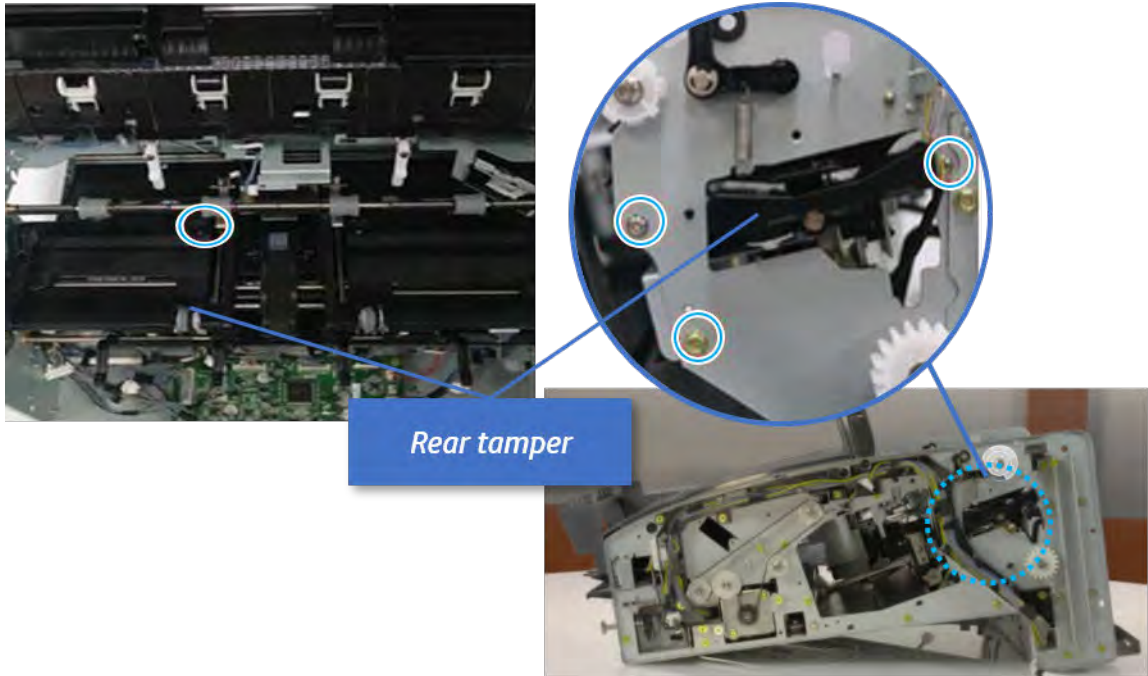
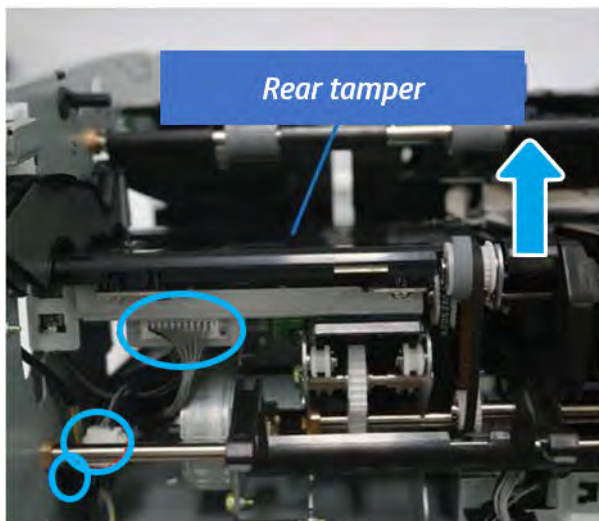
 **NOTE:** Move cable guideout of position to access the screws.

Figure 6-193 Remove four screws



2. Unplug two connectors and release the hook, and then remove the rear tamper.

Figure 6-194 Remove the rear tamper

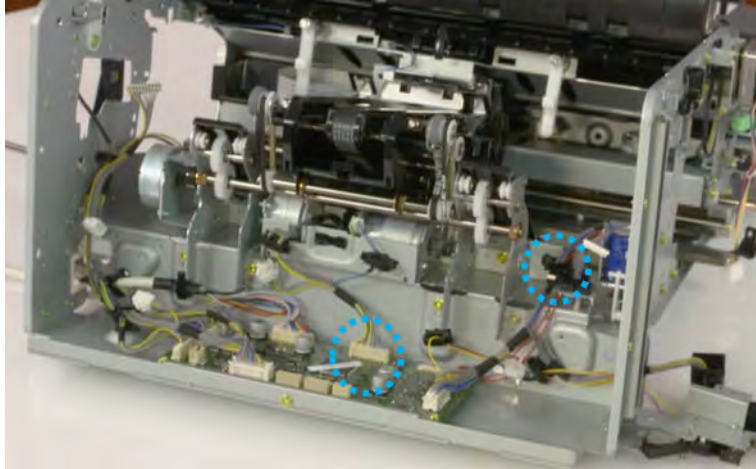


### Remove the ejector & paper support assembly

Follow these steps to remove the ejector & paper support assembly.

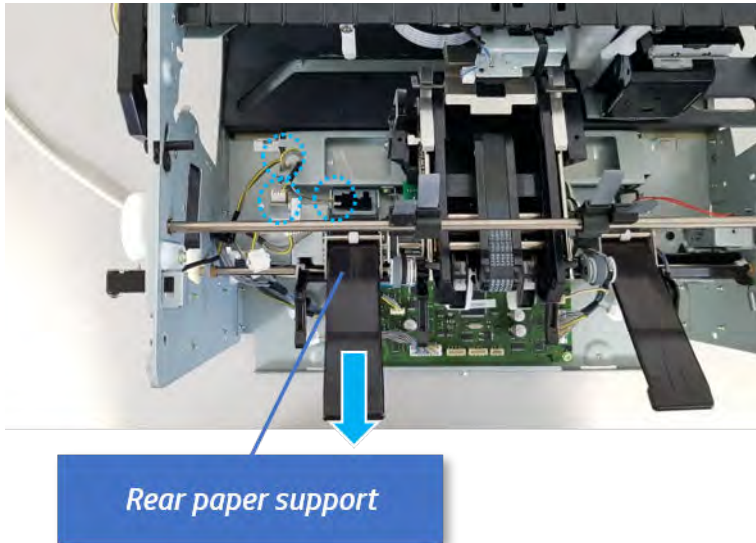
1. Open one clamp, disconnect one connector.

Figure 6-195 Disconnect one connector



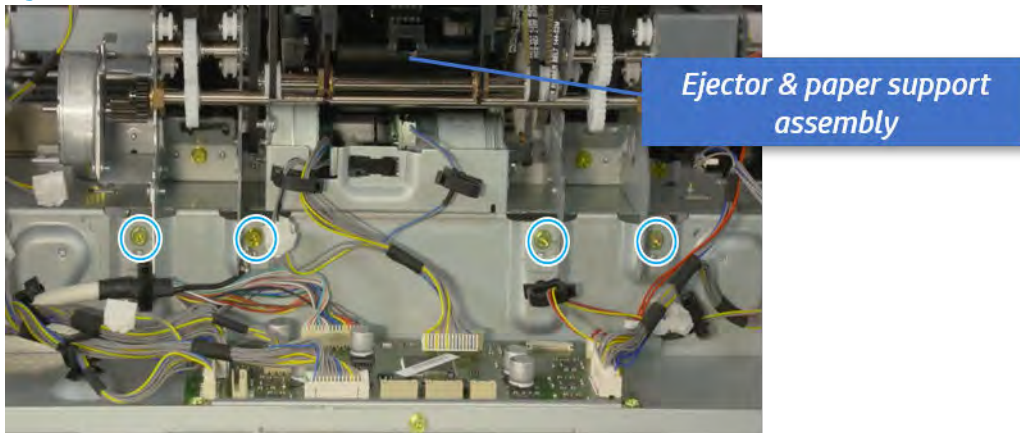
2. Pull the rear paper support up, and then release one clamp and disconnect two connectors.

Figure 6-196 Disconnect two connector



3. Remove four screws, and then remove the ejector & paper support assembly.

Figure 6-197 Remove the ejector & paper support assembly

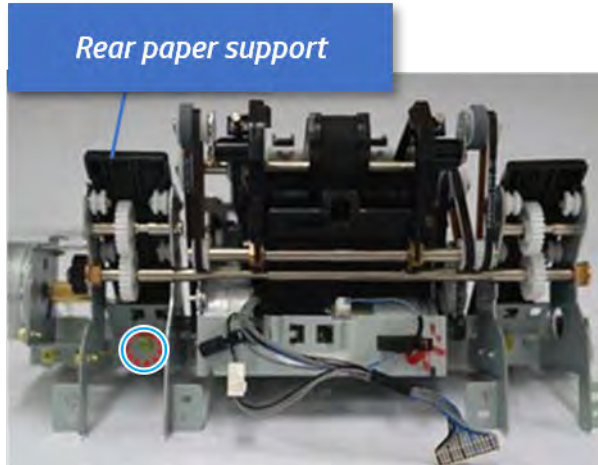


## Remove the rear paper support

Follow these steps to remove the rear paper support.

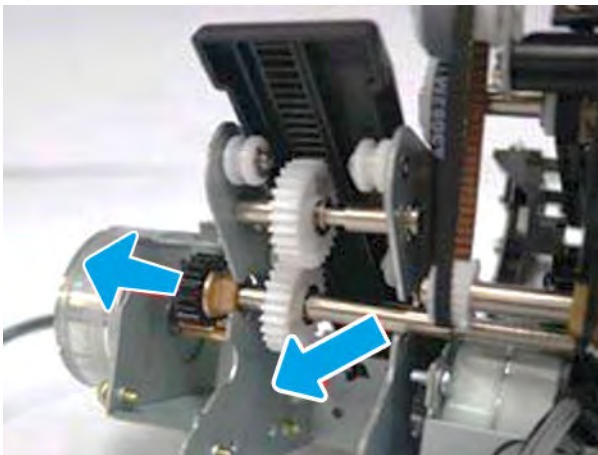
1. Remove one screw.

**Figure 6-198** Remove one screw



2. Remove the shaft while pulling the bushing in the direction of the arrow.

**Figure 6-199** Remove the shaft





3. Remove the rear paper support with attention for pinion.

Figure 6-200 Remove the rear paper support



### Unpack the replacement assembly



Follow these steps to unpack the replacement assembly.

1. Dispose of the defective part.


 **NOTE:** HP recommends responsible disposal of the defective part.

<http://www8.hp.com/us/en/hp-information/environment/product-recycling.html>


2. Unpack the replacement part from the packaging.

 **CAUTION:**  Some parts are sensitive to electrostatic discharge (ESD). Always perform service work at an ESD-protected workstation or mat. If an ESD workstation or mat is not available, touch the sheet-metal chassis to provide a static ground before touching an ESD-sensitive assembly. Protect the ESD-sensitive assemblies by placing them in ESD pouches when they are out of the printer.

 **IMPORTANT:** Make sure that all of the shipping materials (for example shipping tape) are removed from the replacement part prior to installation.

 **NOTE:** If the replacement part is a roller or pad, avoid touching the spongy part of it. Skin oils on the roller or pad can cause paper pickup and/or print-quality problems. HP recommends using disposable gloves when handling rollers or pads or washing your hands before touching rollers or pads.

3. To install an assembly, reverse the removal steps.

 **NOTE:** When applicable, special installation instructions are provided for an assembly at the end of the removal procedure. Always completely read the removal instructions and follow all special installation instructions.


## Removal and replacement: Paper support home sensor (S12)

Learn how to remove and replace the paper support home sensor.

To view teardown and reassembling video of the inner finisher, click the link below.

 [View a teardown video of the inner finisher.](#)

 [View a reassembling video of the inner finisher.](#)

 **IMPORTANT:** When applicable, special installation instructions are provided for an assembly at the end of the removal procedure. Always completely read the removal instructions and follow all special installation instructions.


Mean time to repair:

Service level:

### Before performing service

#### Turn the printer power off

- Press the power button on the front of the printer, and then turn off the power switch next to the power cable.
- A shutting-down message appears on the control-panel display.

 **WARNING!** To avoid damage to the printer, turn the power off and wait until the printer shuts down before removing the power cable.

- Disconnect the printer power cable after the printer has completely shut down (the control-panel display is blank).

Use the table below to identify the correct part number for your printer. To order the part, go to [www.hp.com/buy/parts](http://www.hp.com/buy/parts).

Table 6-46 Part information

Part number	Part description
0604-001393	Paper support home sensor

### Required tools

- #2 JIS screwdriver with a magnetic tip

### After performing service

#### Turn the printer power on

- Connect the power cable.
- Use the power switch to turn the power on.

### Post service test

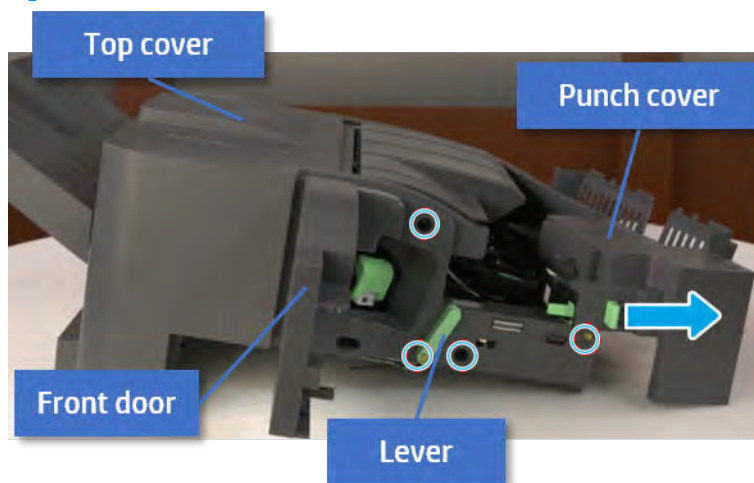
Print any pages necessary to verify that the repair resolved the issue and did not create any new issues.

## Remove the front cover

Follow these steps to remove the front cover:

1. Open the front door and open the punch cover.
2. Remove three screws in the front.
3. Remove the lever.
4. Open the top cover.
5. From the right side of the front cover, carefully lift and pry toward the top-left corner to remove the front cover.

Figure 6-201 Remove the front cover

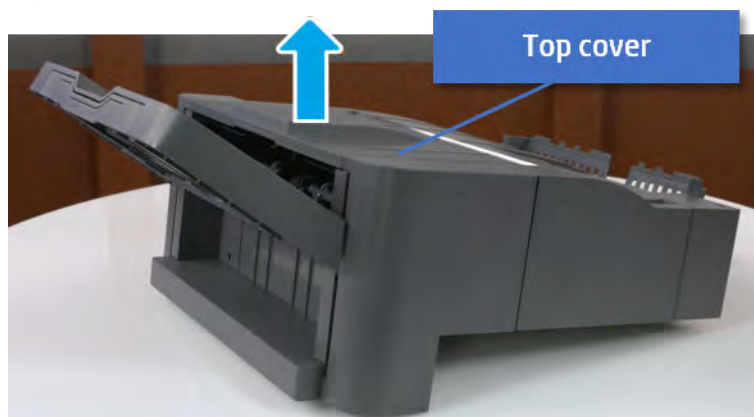


## Remove the rear cover

Follow these steps to remove the rear cover:

1. Open the top cover.

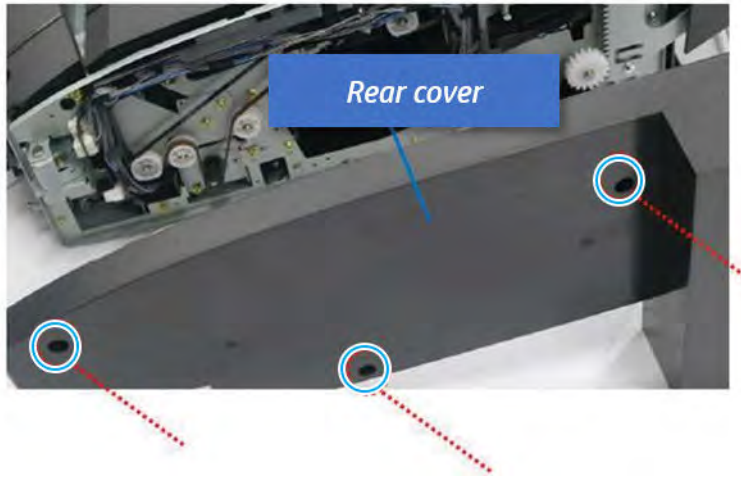
Figure 6-202 Open the top cover



2. Remove three screws.

3. Release hooks carefully and remove the rear cover.

Figure 6-203 Remove the rear cover

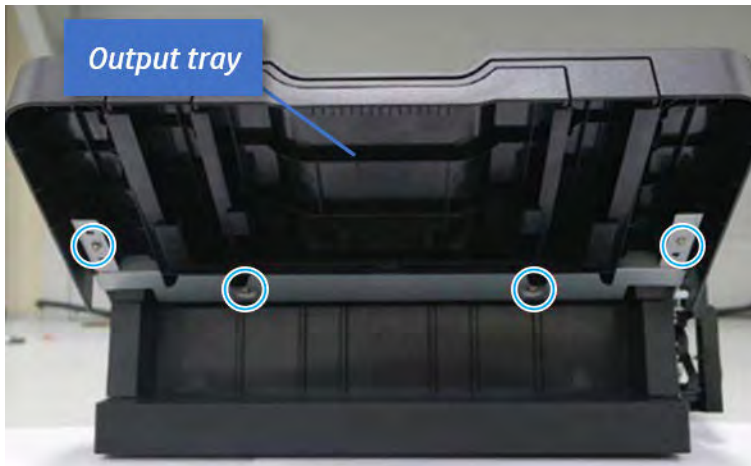


### Remove the output tray

Follow these steps to remove the output tray.

1. Remove four screws.

Figure 6-204 Remove four screws



2. Push the paper holding actuator into the inner finisher, and then remove the output tray.

Figure 6-205 Remove the output tray.

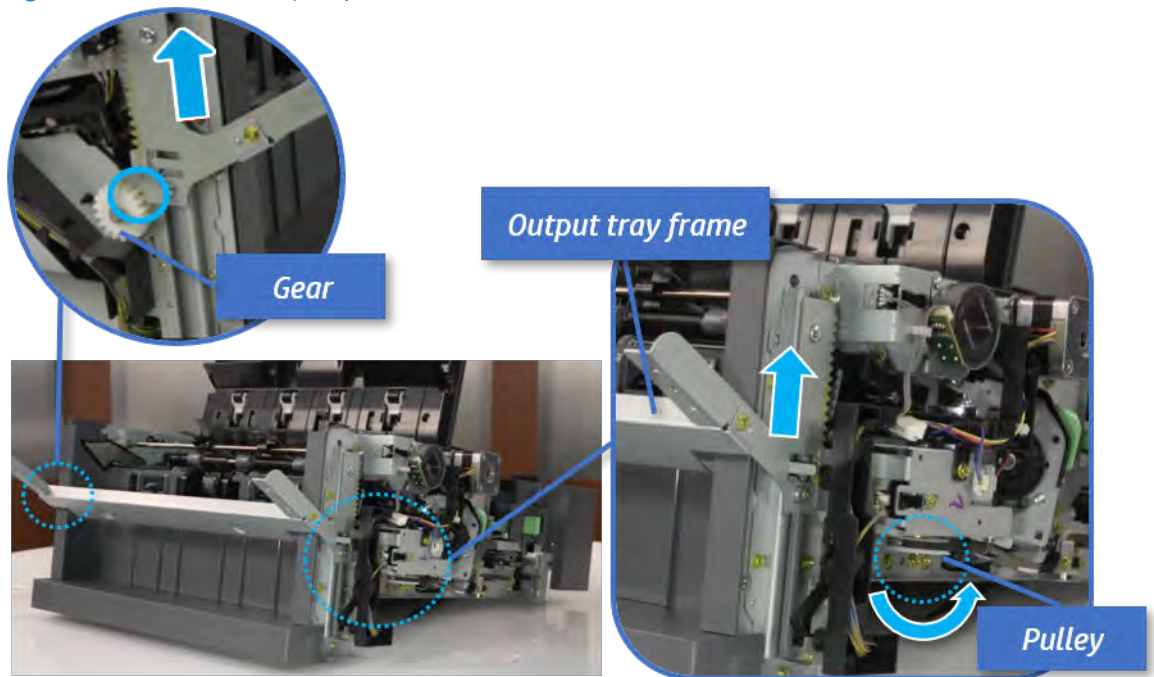


### Remove the output tray frame

Follow these steps to remove the output tray frame.

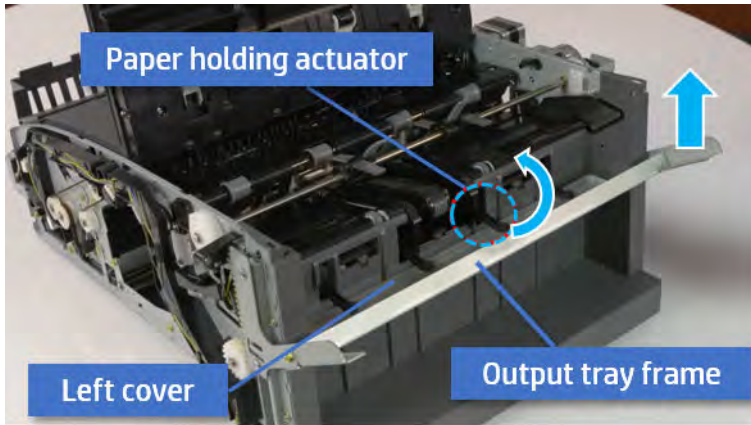
1. Rotate the pulley until the output tray frame depart from the gear.

Figure 6-206 Remove the pulley



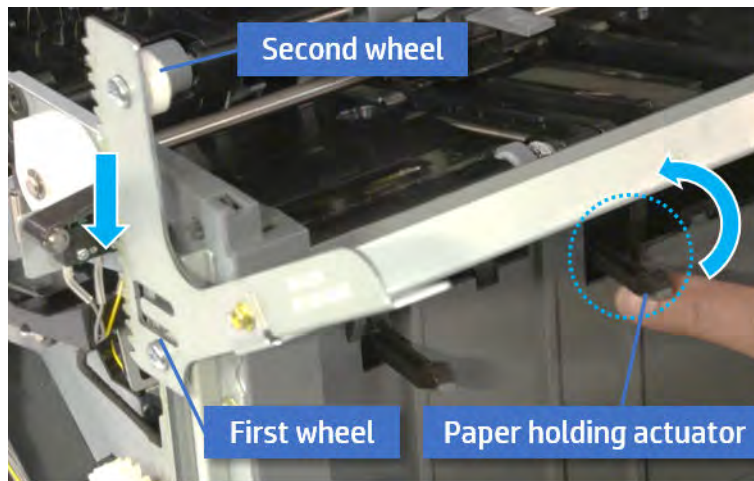
2. Push the paper holding actuator into the inner finisher, and then remove the output tray frame.

Figure 6-207 Remove the output tray frame

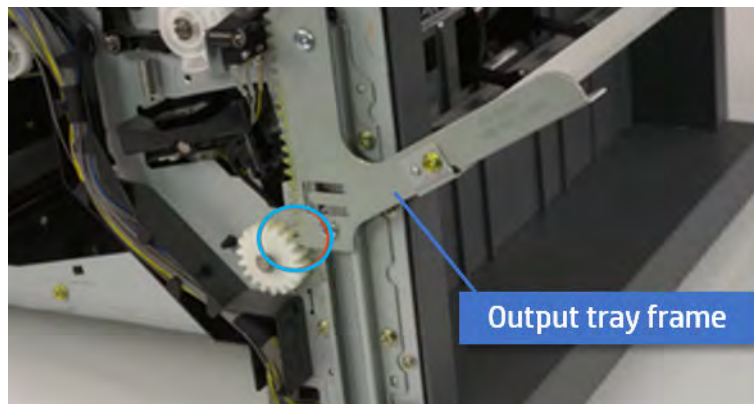


**TIP:** Push the paper holding actuator into the inner finisher when reassembling. Be sure to level the output tray.

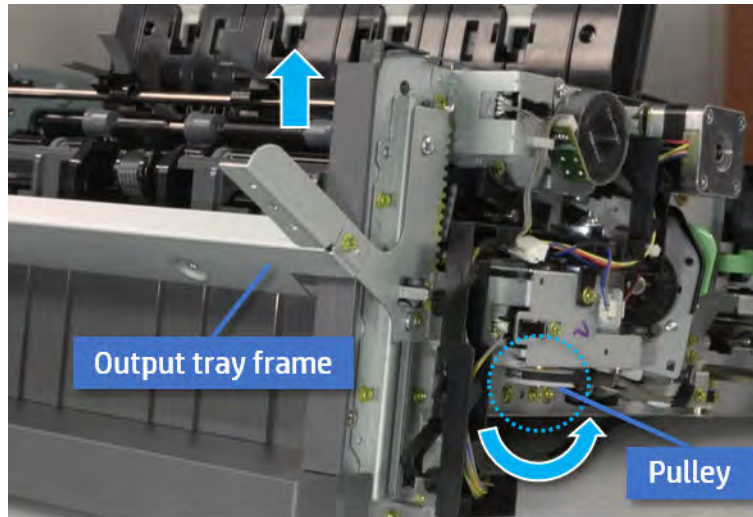
- a. Position the first wheel into the channel on both sides while pushing the paper holding actuator.



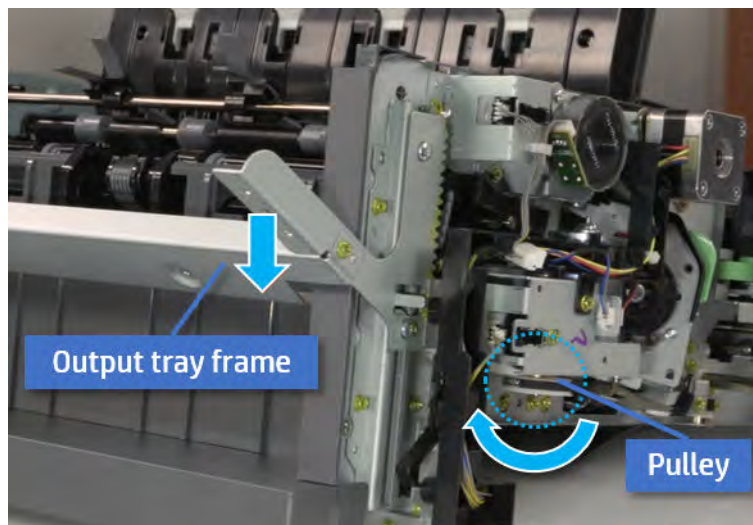
- b. Let the second wheel rest on the channel on both sides simultaneously.
- c. Gently squeeze the wheels into channel until the output tray frame meet the gear.



- d. Rotate the pulley until the output tray frame is no longer lifted. It can make to level the output tray frame.



- e. Rotate the pulley in the opposite direction.

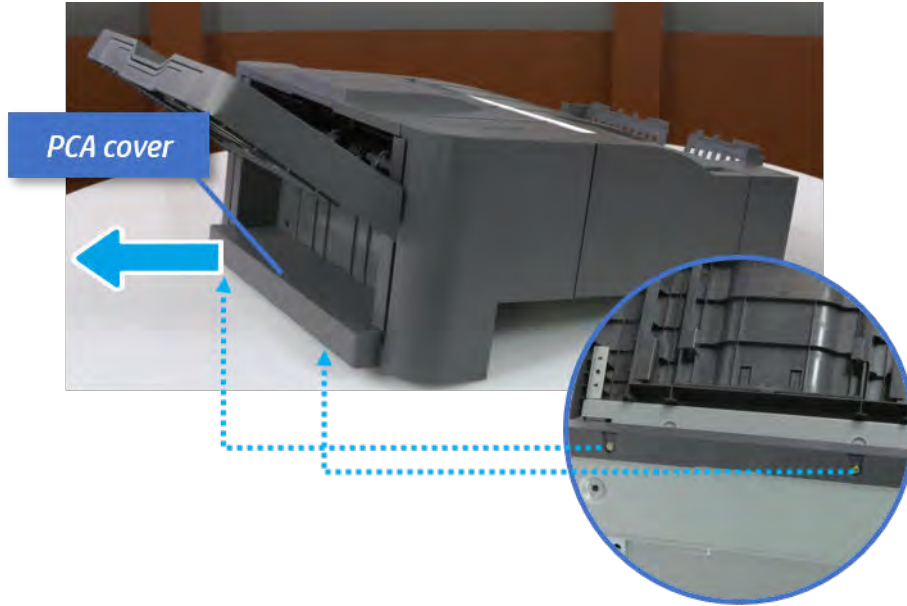


### Remove the PCA cover

Follow these steps to remove the PCA cover.

- ▲ Remove two screws, and then remove the PCA cover.

Figure 6-208 Remove the PCA cover

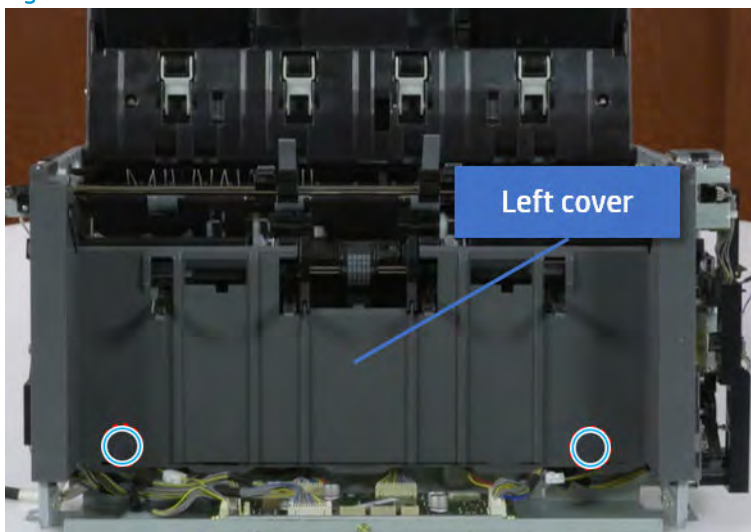


### Remove the left cover

Follow these steps to remove the left cover.

1. Remove two screws.

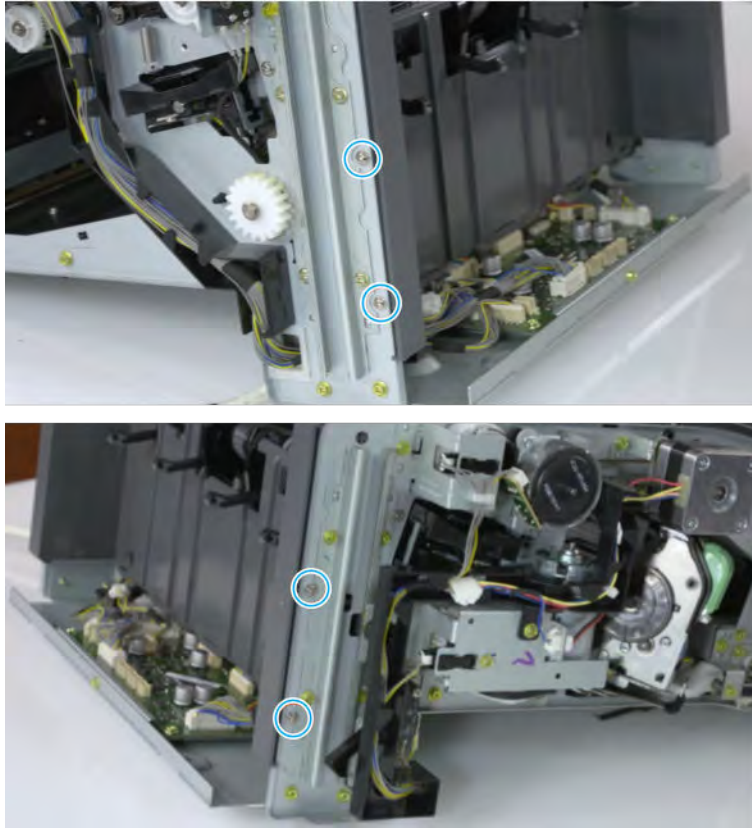
Figure 6-209 Remove two screws





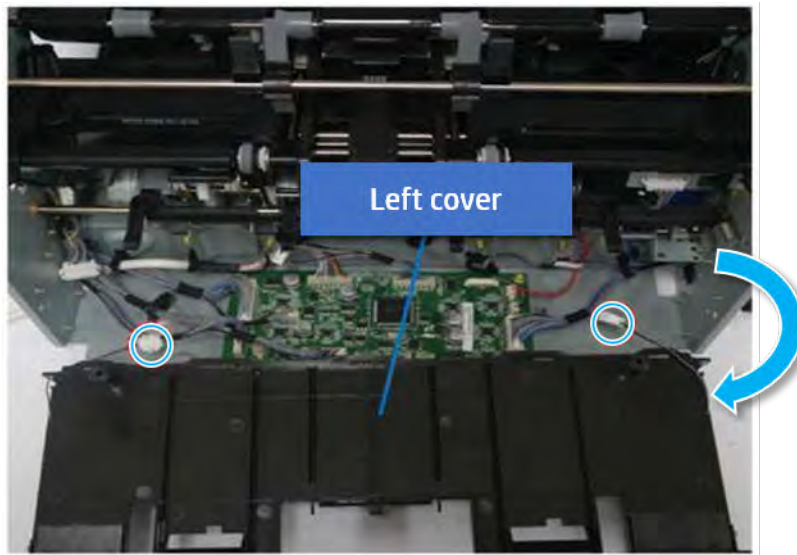
2. Remove four screws from both front and rear sides.


Figure 6-210 Remove four screws

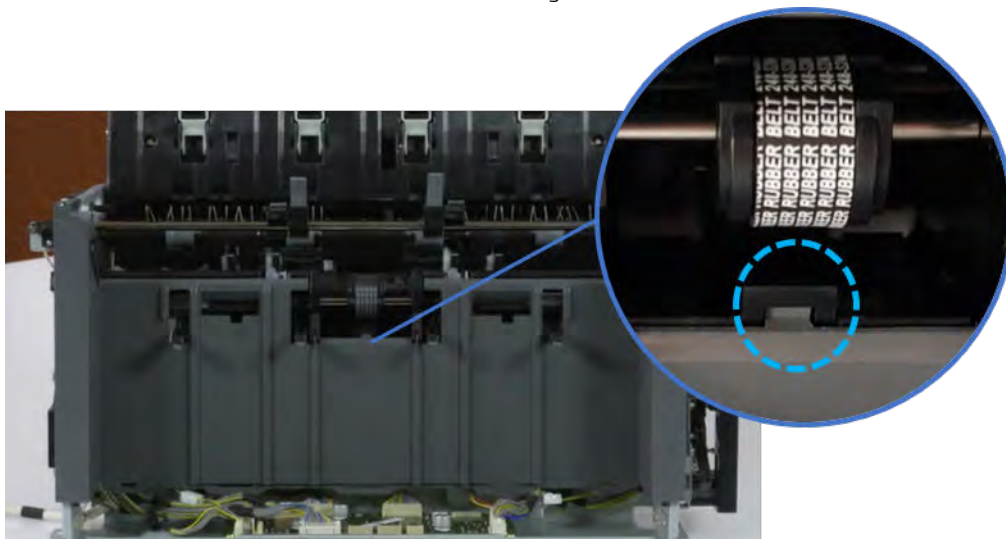


3. Unplug two inline connectors, and then remove the left cover.

Figure 6-211 Unplug two connectors



 **TIP:** Be sure to check the hook when reassembling.



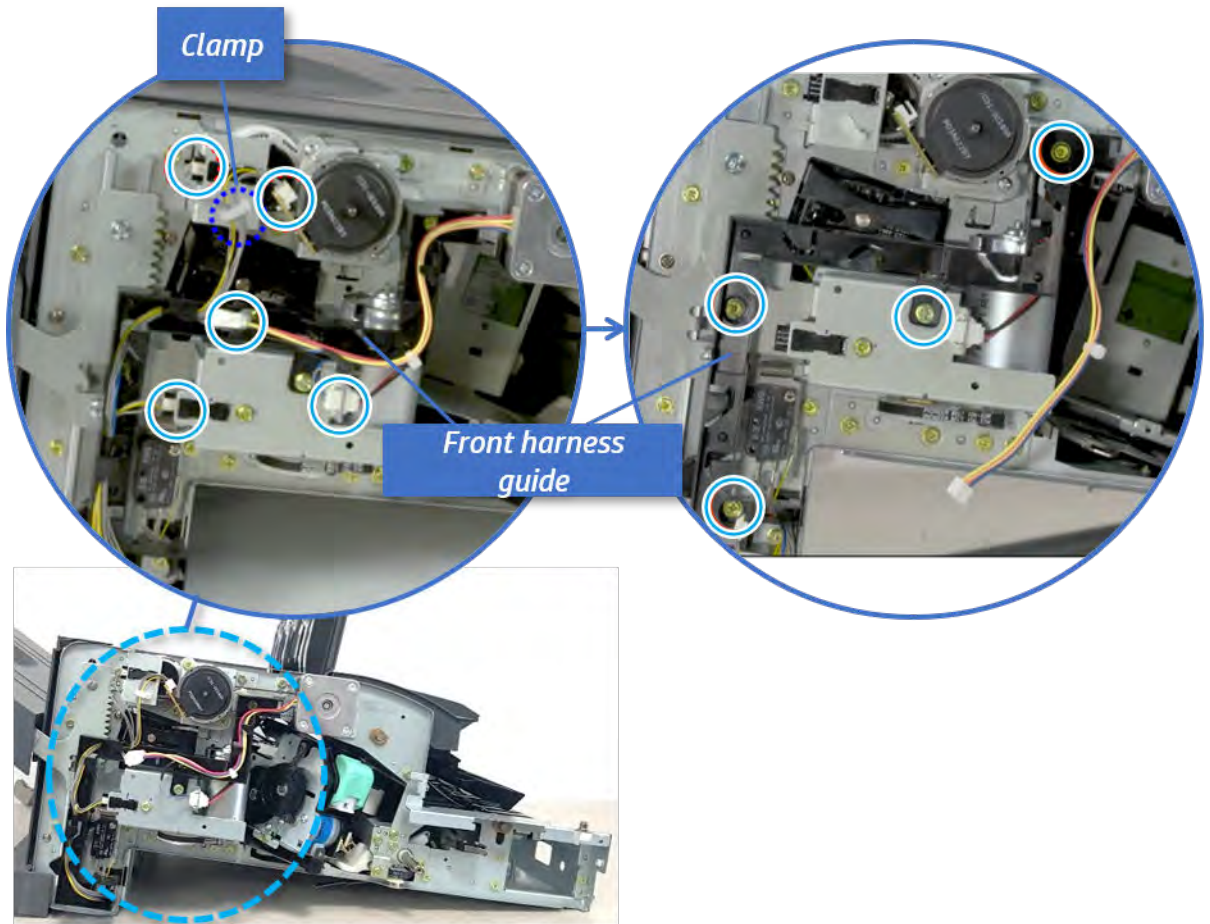
### Remove the front harness guide

Follow these steps to remove the front harness guide.

1. Open one clamp and unplug five connectors, and then remove the wire harness from the front harness guide.

2. Remove four screws, and then remove the front harness guide.

Figure 6-212 Remove the front harness guide

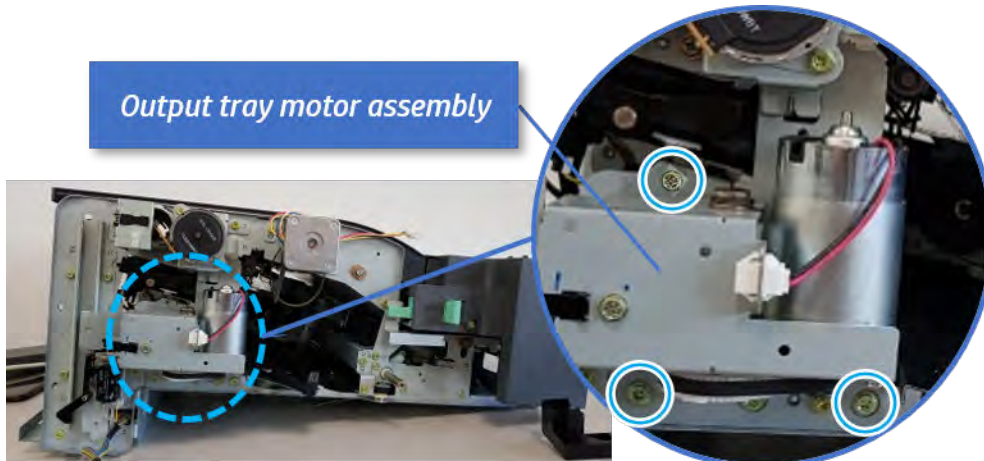


### Remove the output tray motor assembly

Follow these steps to remove the output tray motor assembly.

- ▲ Remove three screws, and then remove the output tray motor assembly.

Figure 6-213 Remove the output tray motor assembly

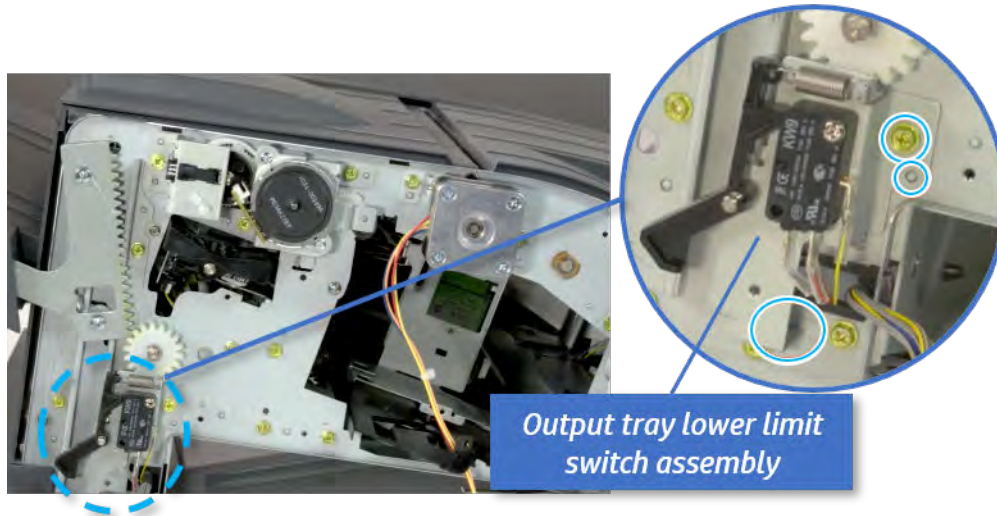


## Remove the output tray lower limit switch

Follow these steps to remove the output tray lower limit switch.

- ▲ Remove one screw, and then remove the output tray lower limit switch.

**Figure 6-214** Remove the output tray lower limit switch

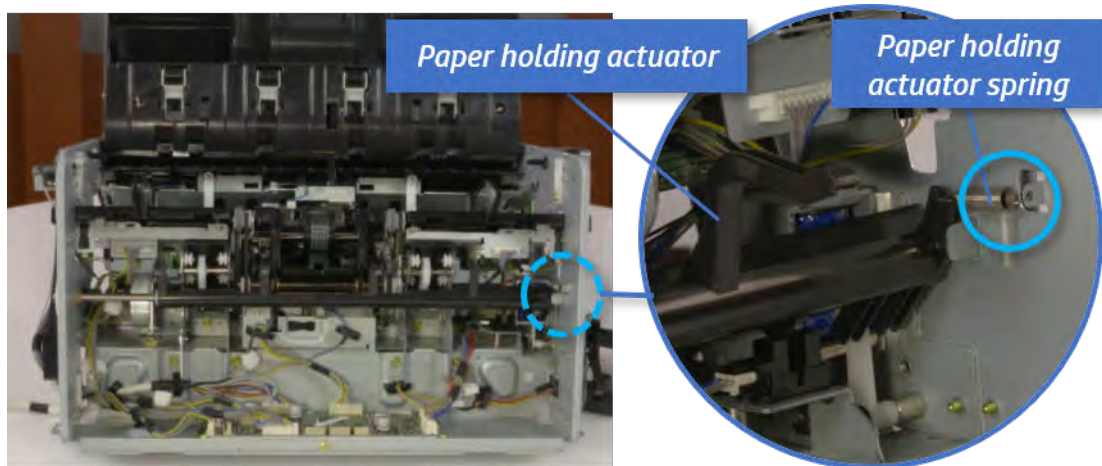


## Remove the paper holding

Follow these steps to remove the paper holding.

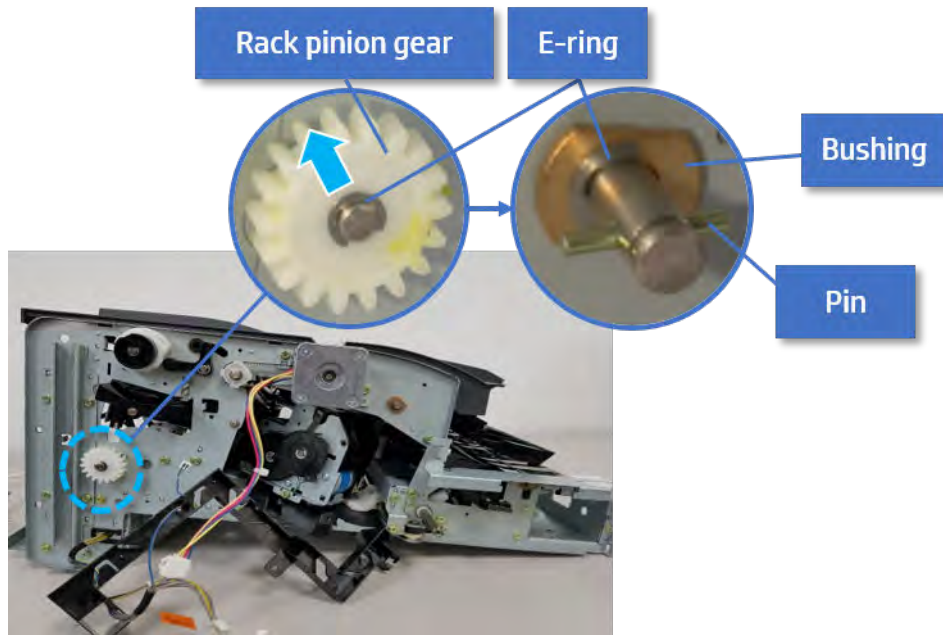
1. Remove the paper holding actuator spring.


**Figure 6-215** Remove the paper holding actuator spring



2. Remove the e-ring and the rack pinion gear. And then remove the pin and the e-ring, and then remove the bushing.

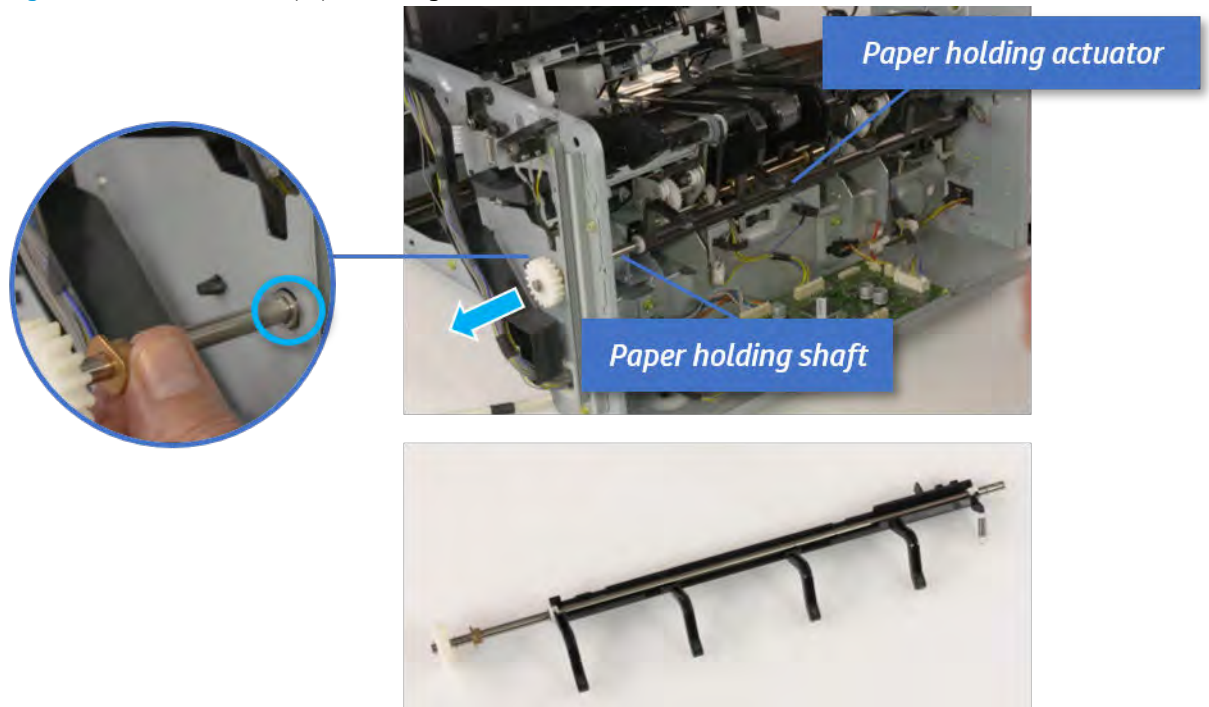
Figure 6-216 Remove e-ring, rack pinion gear, pin, and bushing



 **NOTE:** Be sure not to lose the pin.

3. Carefully remove the paper holding shaft and the actuator.

Figure 6-217 Remove the paper holding shaft and the actuator

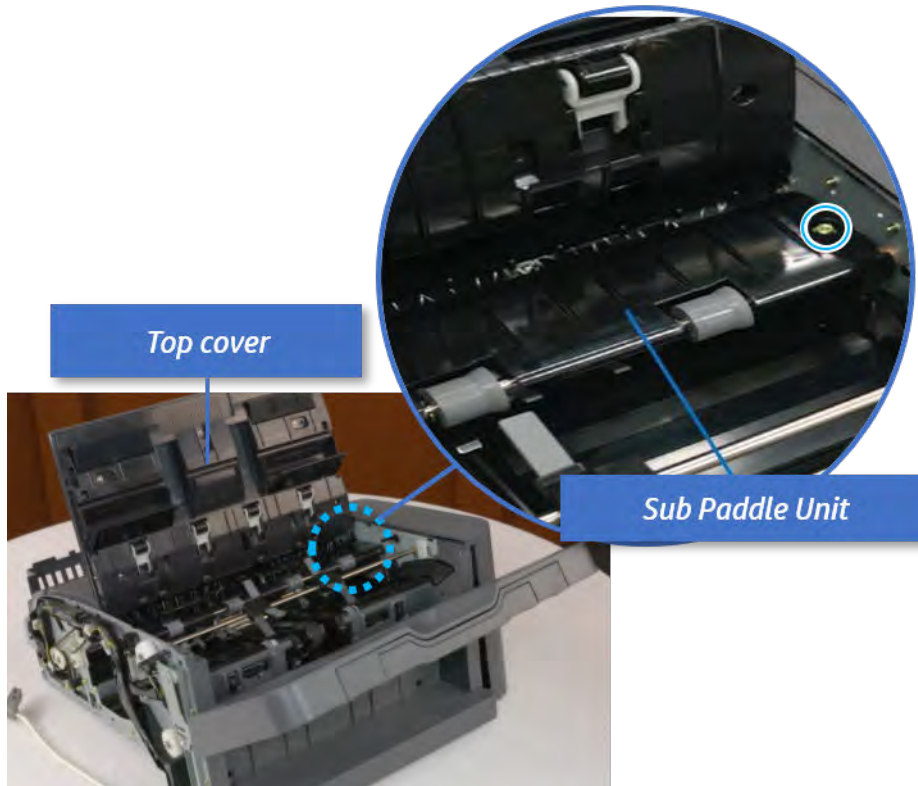


### Remove the sub paddle unit

Follow these steps to remove the sub paddle unit.

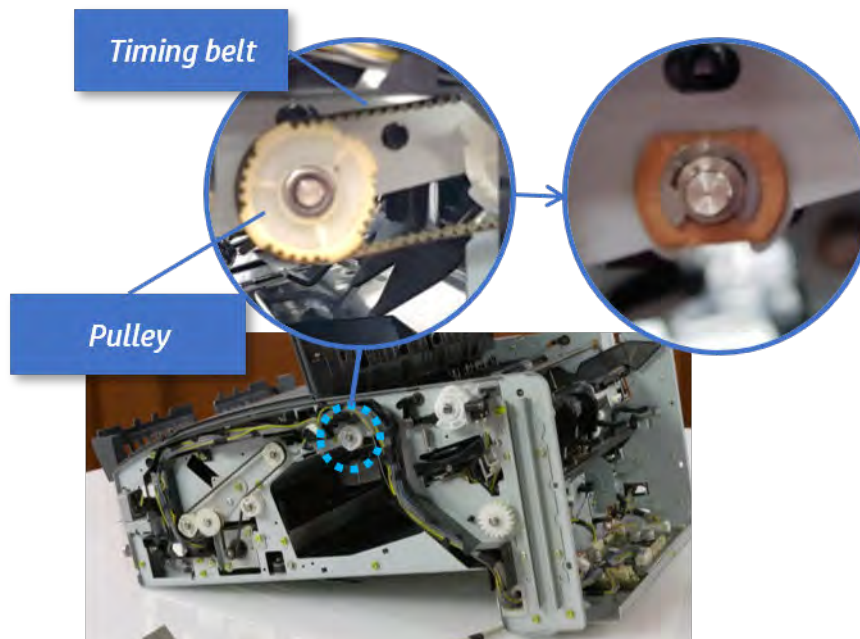
1. Open the top cover, and then remove one screw securing the sub paddle unit.

Figure 6-218 Remove one screw



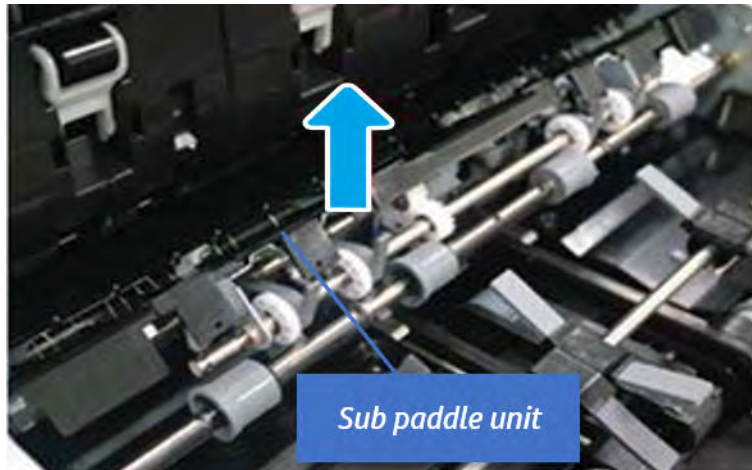
2. Remove the e-ring, and then remove the pulley and timing belt. And then remove the e-ring and the bushing.

Figure 6-219 Remove the e-ring, pulley, timing belt, and bushing



3. Lift up and remove the sub paddle unit.

Figure 6-220 Remove the sub paddle unit

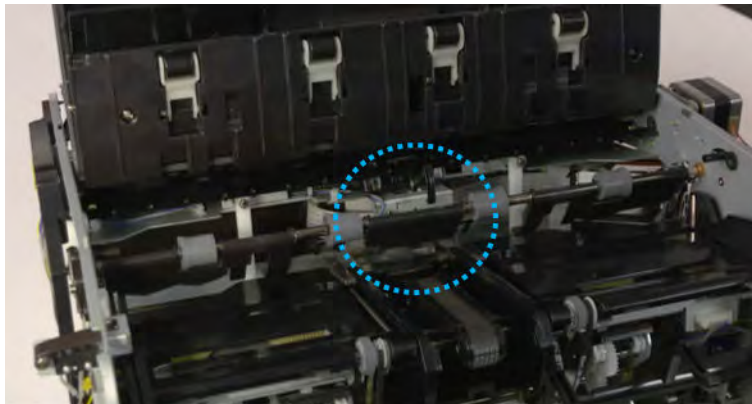


### Remove the exit roller

Follow these steps to remove the exit roller.

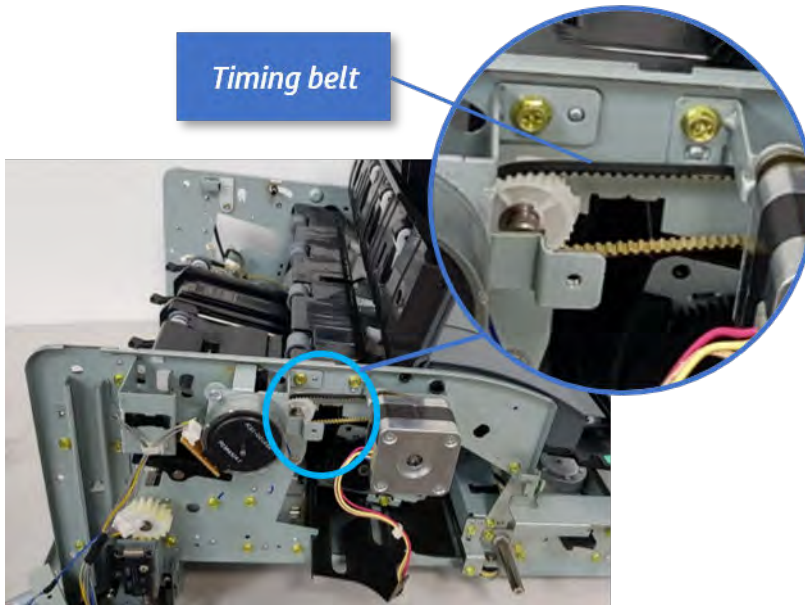
1. Remove the guide on the center of the exit roller.

Figure 6-221 Remove the guide



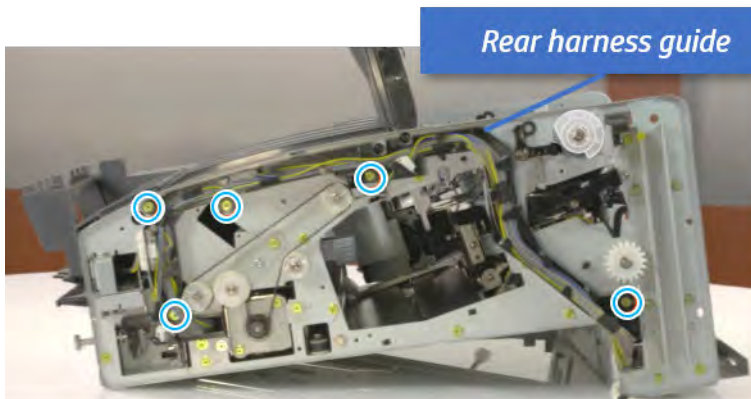
2. On the front of the inner finisher, release the timing belt connected to the exit motor.

Figure 6-222 Release the timing belt



3. Remove five screws securing the rear harness guide.

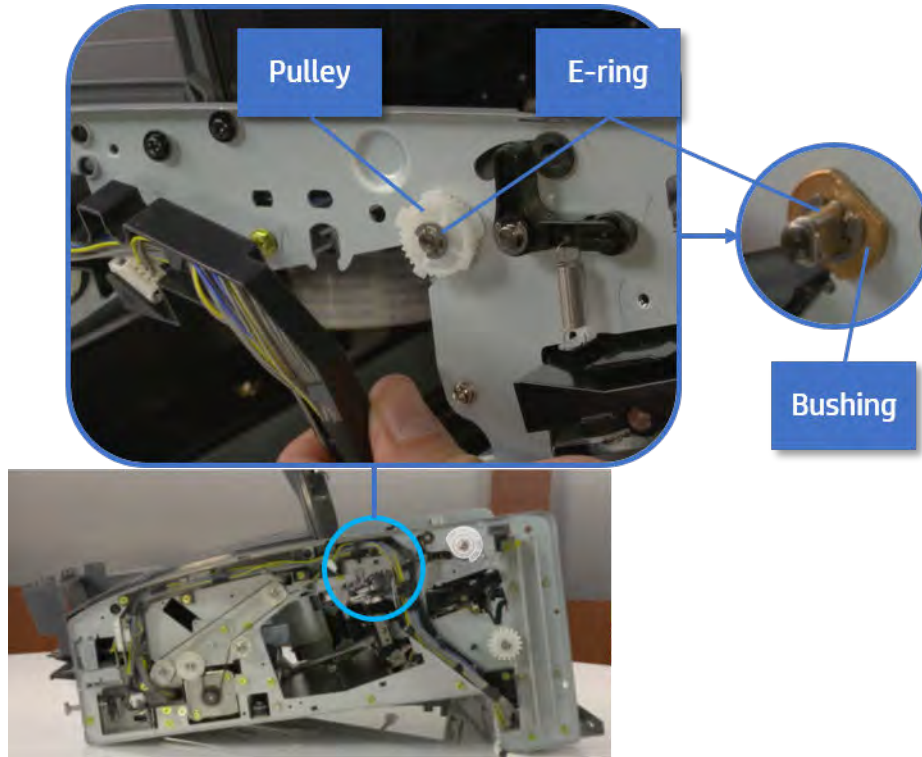
Figure 6-223 Remove five screws





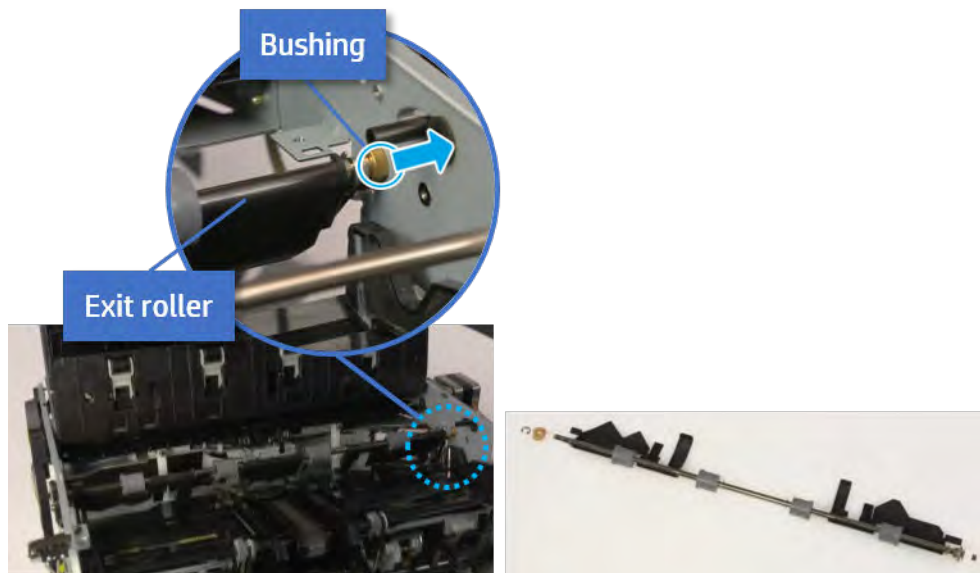
4. On the rear of the inner finisher, remove the e-ring and the pulley and then remove the e-ring and the bushing.

Figure 6-224 Remove e-ring, pulley, and bushing



5. Push the bushing to detach it, and then remove the exit roller.

Figure 6-225 Remove the exit roller

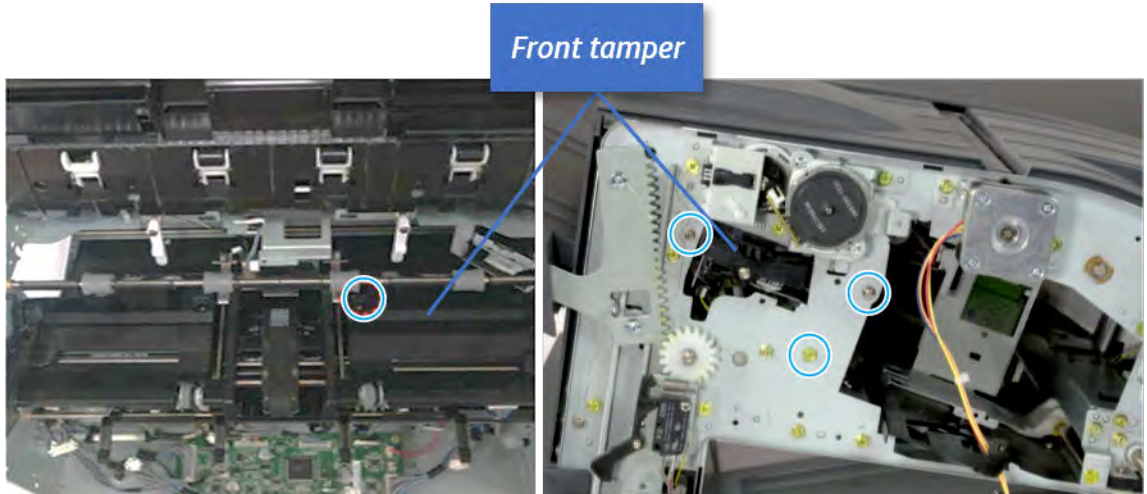


### Remove the front tamper

Follow these steps to remove the front tamper.

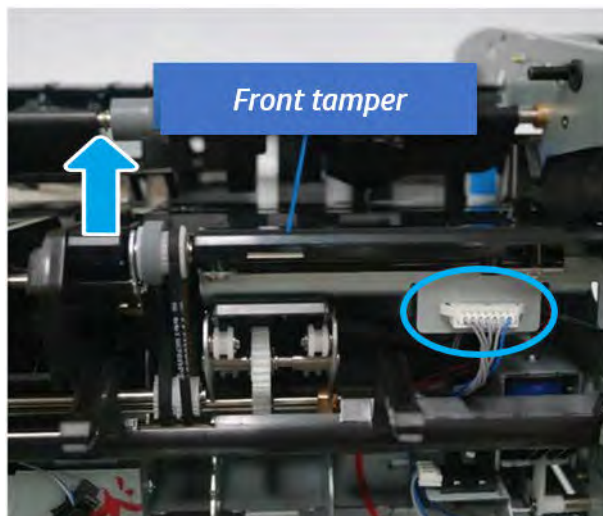
1. Remove four screws.

Figure 6-226 Remove four screws



2. Unplug the connector and release the hook, and then pull the front tamper up to remove.

Figure 6-227 Remove the front tamper



### Remove the rear tamper

Follow these steps to remove the rear tamper.

1. Remove four screws.


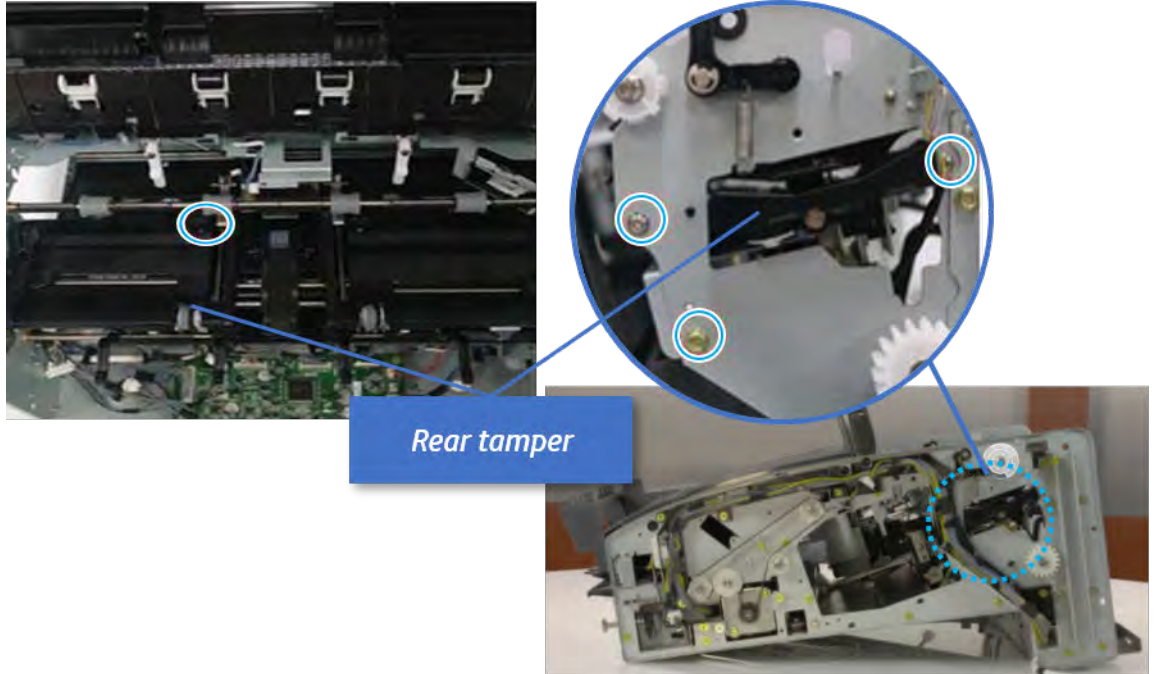
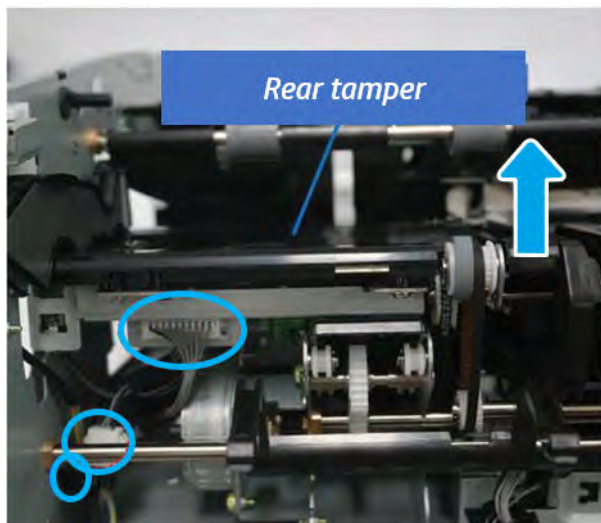
 **NOTE:** Move cable guide out of position to access the screws.

Figure 6-228 Remove four screws



2. Unplug two connectors and release the hook, and then remove the rear tamper.

Figure 6-229 Remove the rear tamper

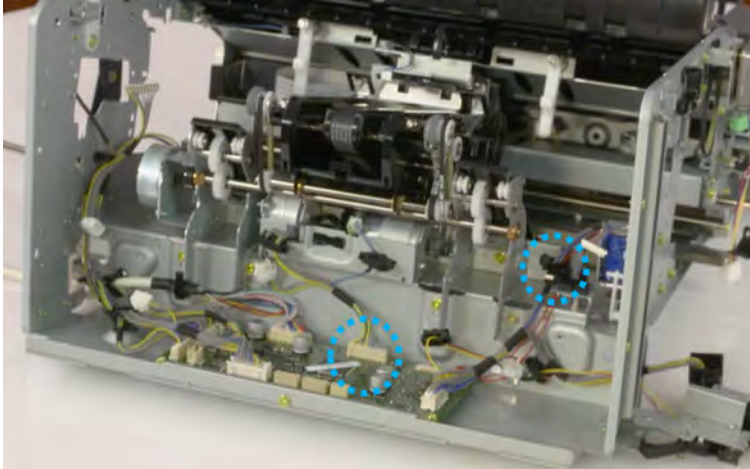


### Remove the ejector & paper support assembly

Follow these steps to remove the ejector & paper support assembly.

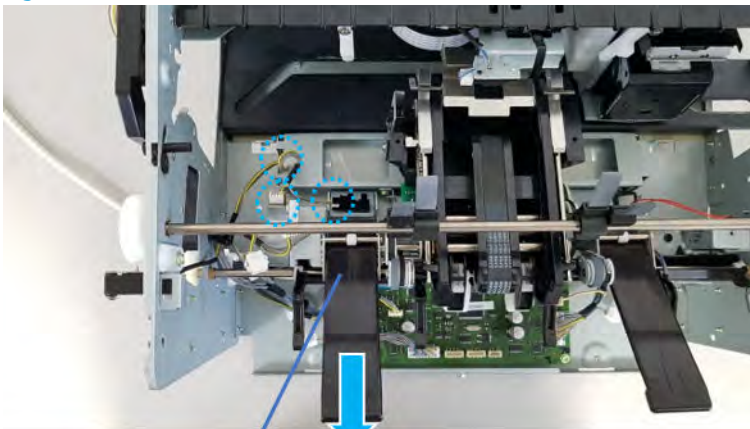
1. Open one clamp, disconnect one connector.

Figure 6-230 Disconnect one connector



2. Pull the rear paper support up, and then release one clamp and disconnect two connectors.

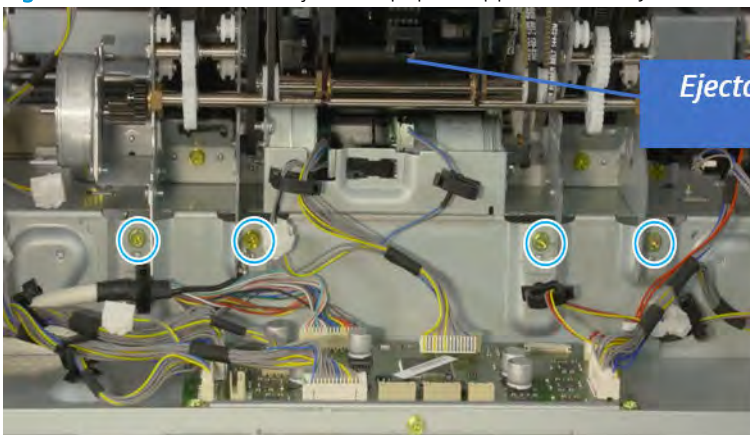
Figure 6-231 Disconnect two connector



*Rear paper support*

3. Remove four screws, and then remove the ejector & paper support assembly.

Figure 6-232 Remove the ejector & paper support assembly



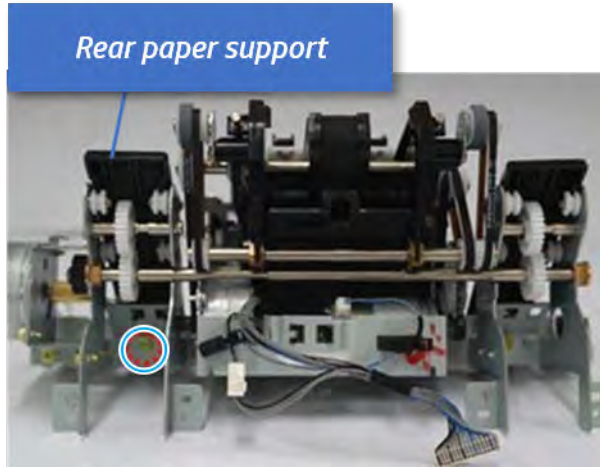
*Ejector & paper support assembly*

## Remove the rear paper support

Follow these steps to remove the rear paper support.

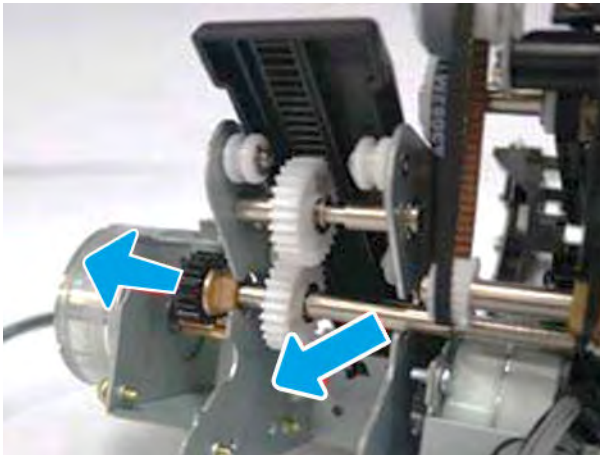
1. Remove one screw.

Figure 6-233 Remove one screw



2. Remove the shaft while pulling the bushing in the direction of the arrow.

Figure 6-234 Remove the shaft



3. Remove the rear paper support with attention for pinion.

**Figure 6-235** Remove the rear paper support



#### Remove the paper support home sensor

Follow these steps to remove the paper support home sensor.

- ▲ Remove the sensor from the rear paper support.

**Figure 6-236** Remove the paper support home sensor



#### Unpack the replacement assembly

Follow these steps to unpack the replacement assembly.

1. Dispose of the defective part.



---


 **NOTE:** HP recommends responsible disposal of the defective part.


<http://www8.hp.com/us/en/hp-information/environment/product-recycling.html>

---

2. Unpack the replacement part from the packaging.


 **CAUTION:**  Some parts are sensitive to electrostatic discharge (ESD). Always perform service work at an ESD-protected workstation or mat. If an ESD workstation or mat is not available, touch the sheet-metal chassis to provide a static ground before touching an ESD-sensitive assembly. Protect the ESD-sensitive assemblies by placing them in ESD pouches when they are out of the printer.

 **IMPORTANT:** Make sure that all of the shipping materials (for example shipping tape) are removed from the replacement part prior to installation.

 **NOTE:** If the replacement part is a roller or pad, avoid touching the spongy part of it. Skin oils on the roller or pad can cause paper pickup and/or print-quality problems. HP recommends using disposable gloves when handling rollers or pads or washing your hands before touching rollers or pads.

---

3. To install an assembly, reverse the removal steps.

 **NOTE:** When applicable, special installation instructions are provided for an assembly at the end of the removal procedure. Always completely read the removal instructions and follow all special installation instructions.

---


## Removal and replacement: Paper support motor (M8)

Learn how to remove and replace the paper support motor.

To view teardown and reassembling video of the inner finisher, click the link below.

 [View a teardown video of the inner finisher.](#)

 [View a reassembling video of the inner finisher.](#)

 **IMPORTANT:** When applicable, special installation instructions are provided for an assembly at the end of the removal procedure. Always completely read the removal instructions and follow all special installation instructions.


Mean time to repair:

Service level:

### Before performing service

#### Turn the printer power off

- Press the power button on the front of the printer, and then turn off the power switch next to the power cable.
- A shutting-down message appears on the control-panel display.

 **WARNING!** To avoid damage to the printer, turn the power off and wait until the printer shuts down before removing the power cable.

- Disconnect the printer power cable after the printer has completely shut down (the control-panel display is blank).

Use the table below to identify the correct part number for your printer. To order the part, go to [www.hp.com/buy/parts](http://www.hp.com/buy/parts).

Table 6-47 Part information

Part number	Part description
JC93-00802B (not orderable)	Paper support motor assembly
JC31-00149A (not orderable)	Paper support motor

### Required tools

- #2 JIS screwdriver with a magnetic tip

### After performing service

#### Turn the printer power on

- Connect the power cable.
- Use the power switch to turn the power on.



## Post service test

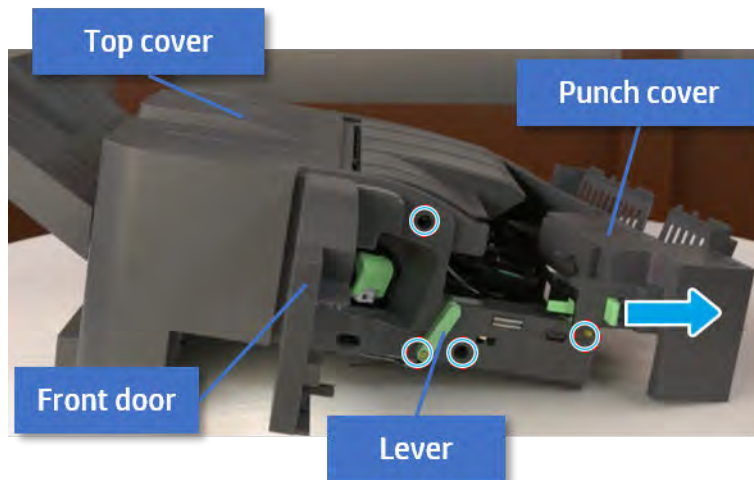
Print any pages necessary to verify that the repair resolved the issue and did not create any new issues.

## Remove the front cover

Follow these steps to remove the front cover.

1. Open the front door and open the punch cover.
2. Remove three screws in the front.
3. Remove the lever.
4. Open the top cover.
5. From the right side of the front cover, carefully lift and pry toward the top-left corner to remove the front cover.

Figure 6-237 Remove the front cover

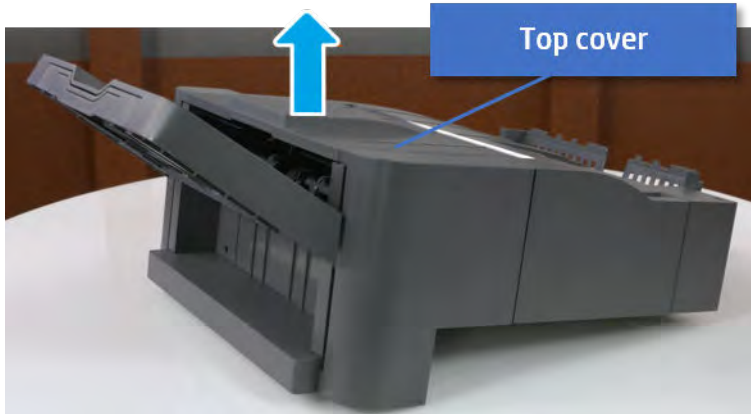


## Remove the rear cover

Follow these steps to remove the rear cover.

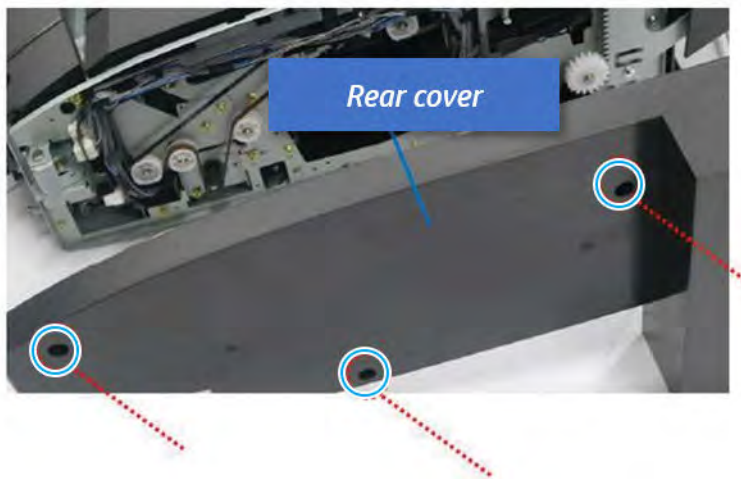
1. Open the top cover.

Figure 6-238 Open the top cover



2. Remove three screws.
3. Release hooks carefully and remove the rear cover.

Figure 6-239 Remove the rear cover

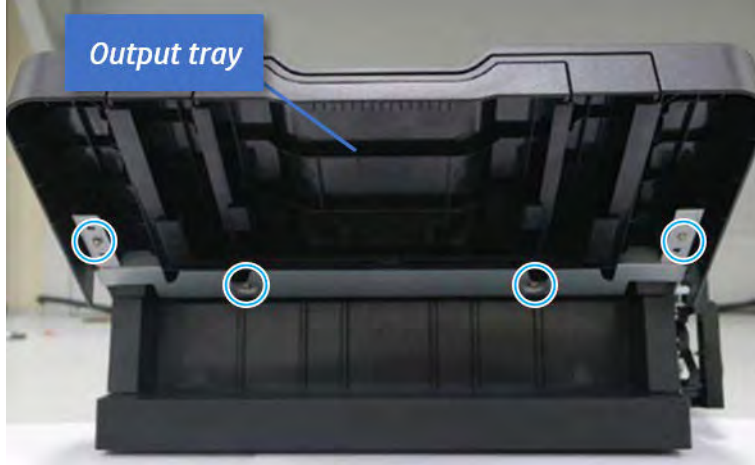


### Remove the output tray

Follow these steps to remove the output tray.

1. Remove four screws.

Figure 6-240 Remove four screws



2. Push the paper holding actuator into the inner finisher, and then remove the output tray.

Figure 6-241 Remove the output tray.

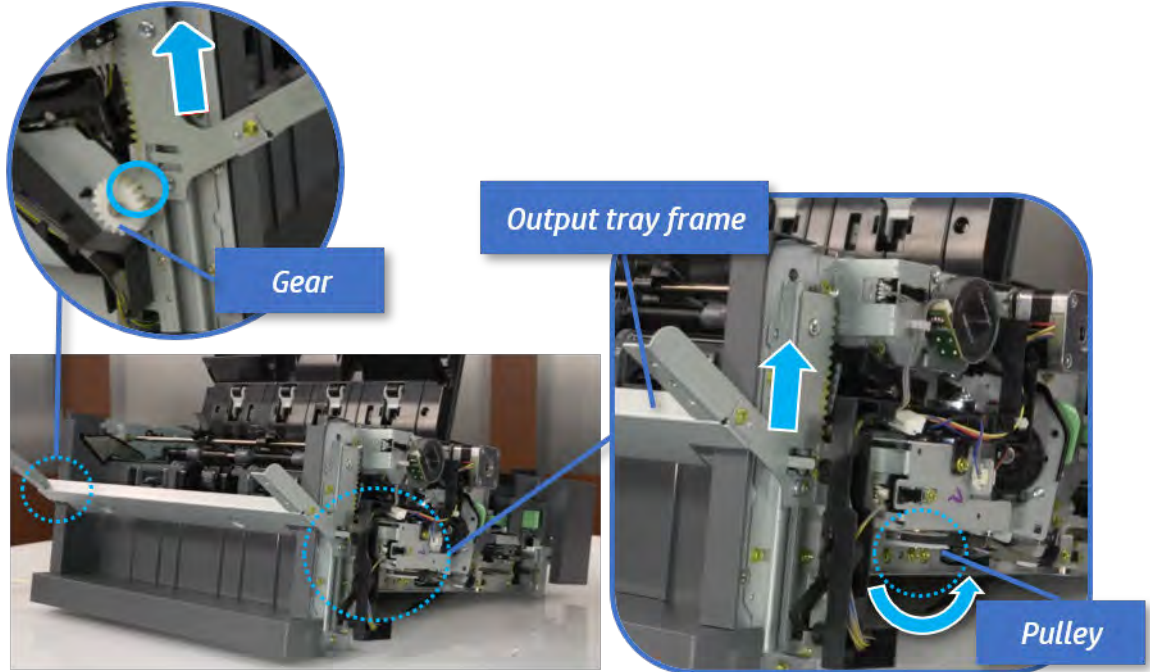


### Remove the output tray frame

Follow these steps to remove the output tray frame.

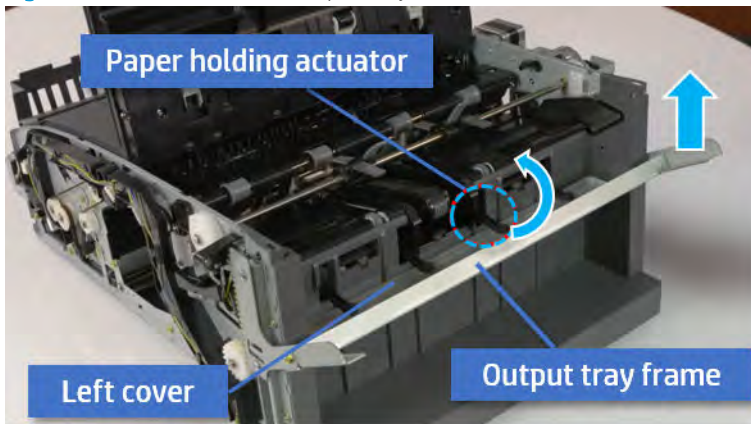
1. Rotate the pulley until the output tray frame depart from the gear.

Figure 6-242 Remove the pulley




2. Push the paper holding actuator into the inner finisher, and then remove the output tray frame.

Figure 6-243 Remove the output tray frame

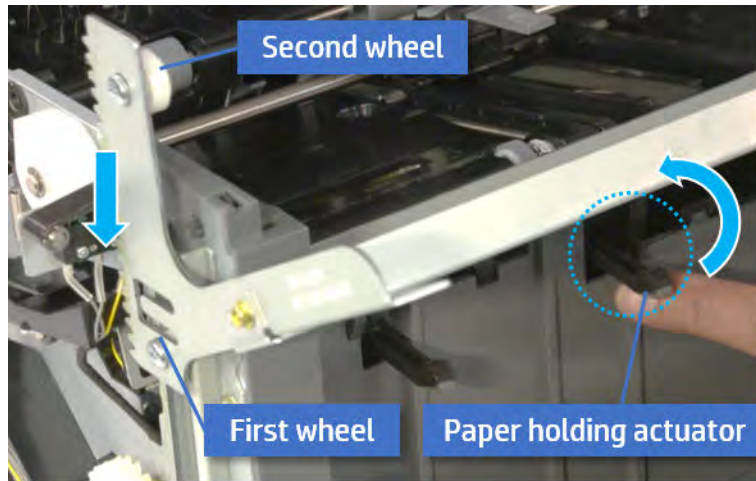


---

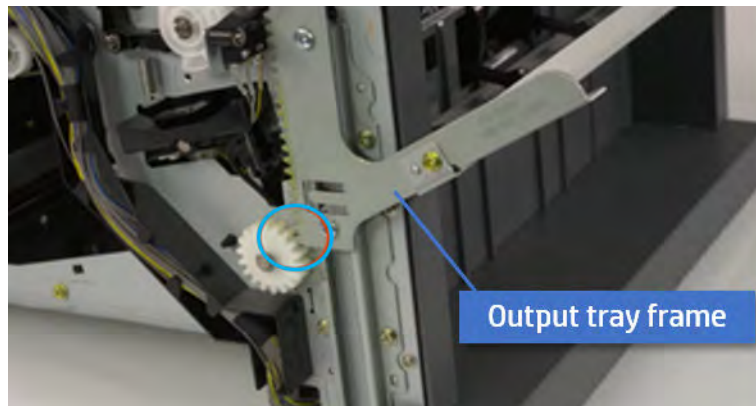
 **TIP:** Push the paper holding actuator into the inner finisher when reassembling. Be sure to level the output tray.

---

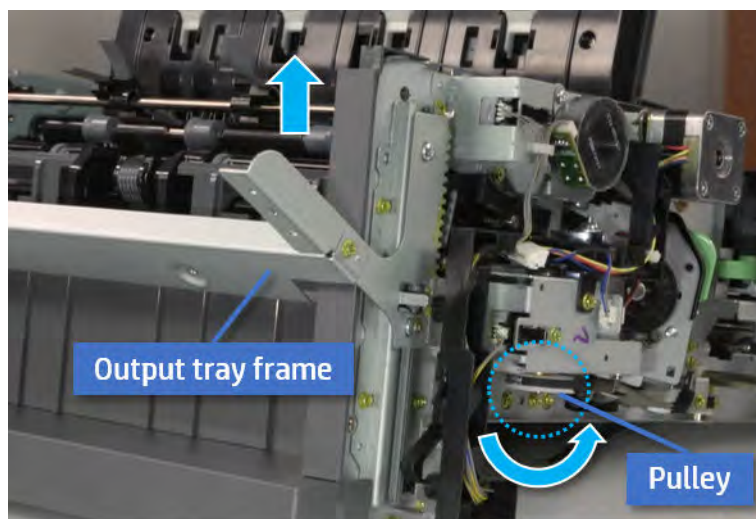
- a. Position the first wheel into the channel on both sides while pushing the paper holding actuator.



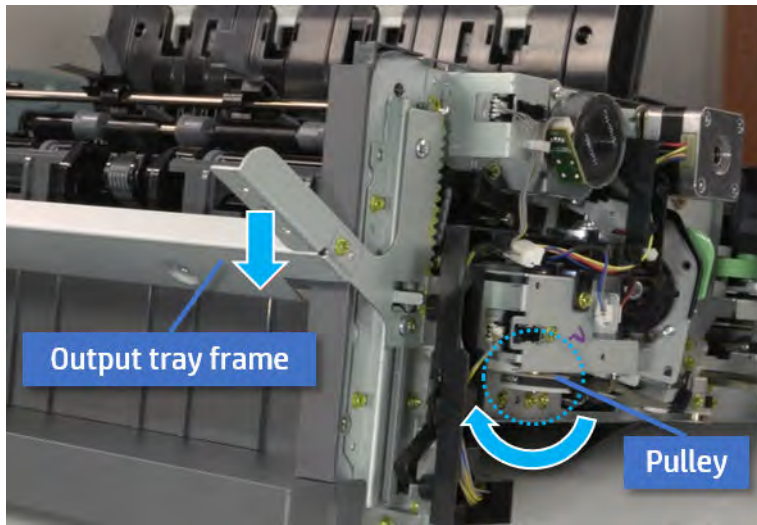
- b. Let the second wheel rest on the channel on both sides simultaneously.
- c. Gently squeeze the wheels into channel until the output tray frame meet the gear.



- d. Rotate the pulley until the output tray frame is no longer lifted. It can make to level the output tray frame.



- e. Rotate the pulley in the opposite direction.

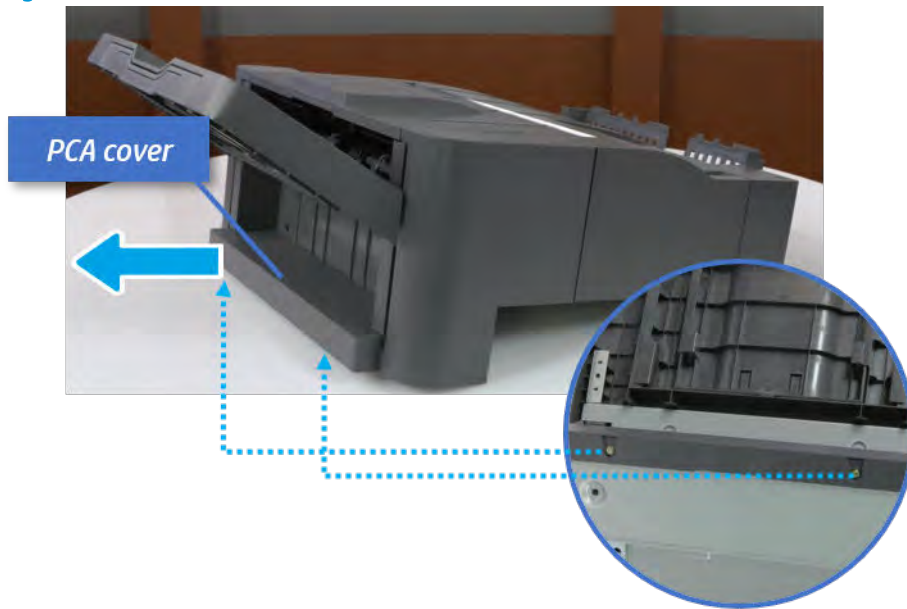


### Remove the PCA cover

Follow these steps to remove the PCA cover.

- ▲ Remove two screws, and then remove the PCA cover.

Figure 6-244 Remove the PCA cover

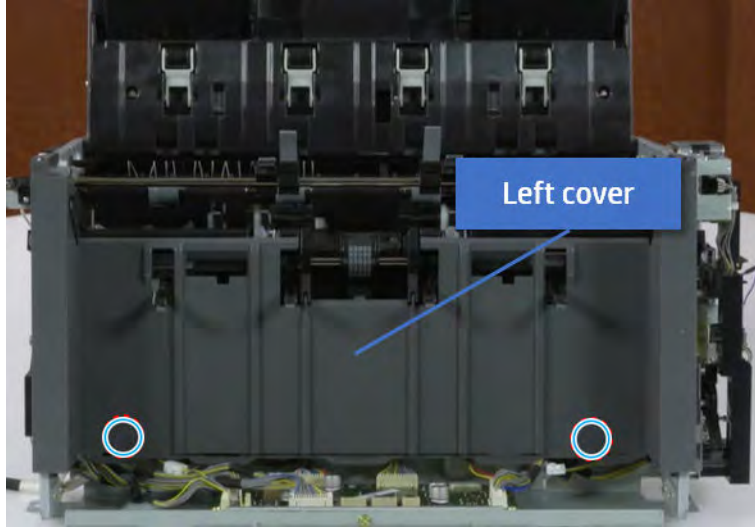


### Remove the left cover

Follow these steps to remove the left cover.

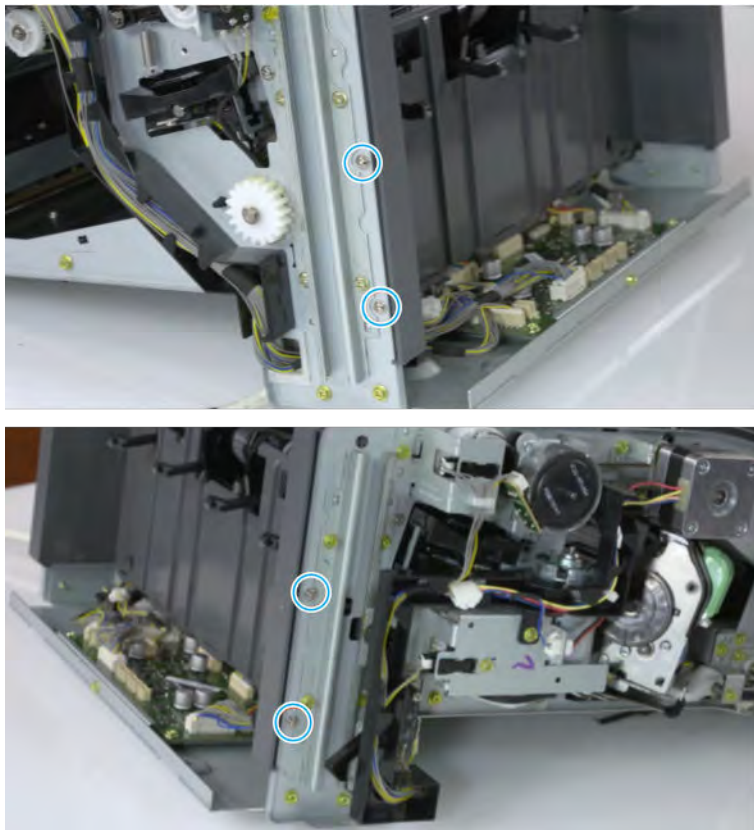
1. Remove two screws.

Figure 6-245 Remove two screws



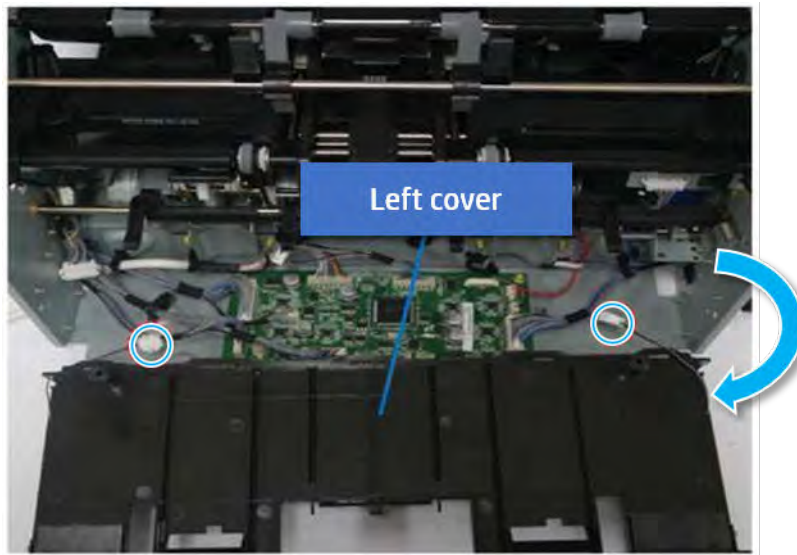
2. Remove four screws from both front and rear sides.


Figure 6-246 Remove four screws

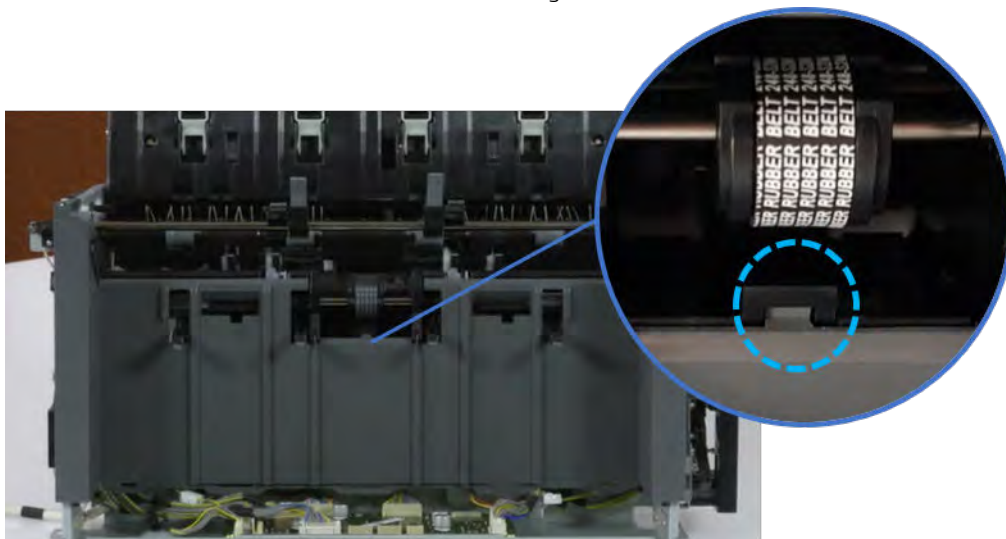


3. Unplug two inline connectors, and then remove the left cover.

Figure 6-247 Unplug two connectors



 **TIP:** Be sure to check the hook when reassembling.



### Remove the front harness guide

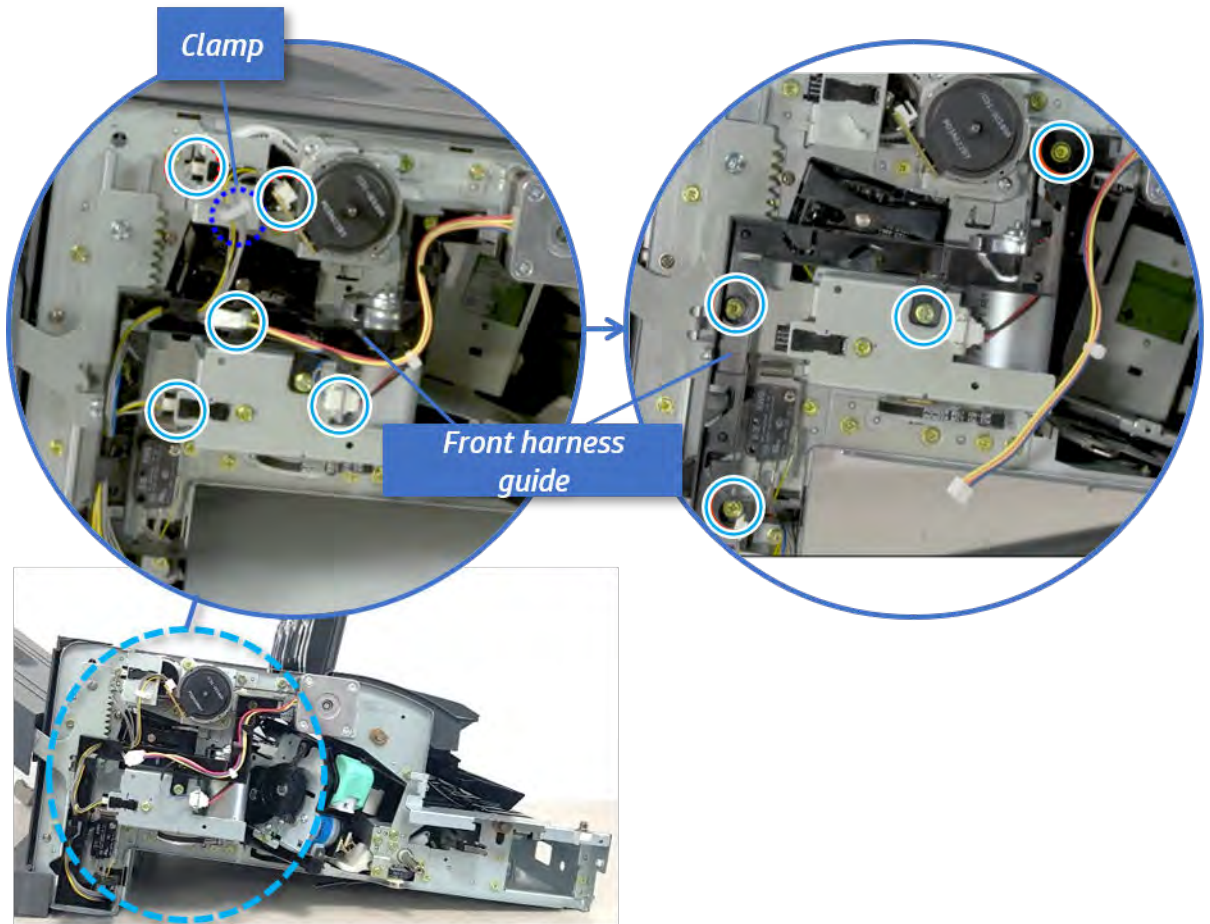
Follow these steps to remove the front harness guide.

1. Open one clamp and unplug five connectors, and then remove the wire harness from the front harness guide.



2. Remove four screws, and then remove the front harness guide.

Figure 6-248 Remove the front harness guide

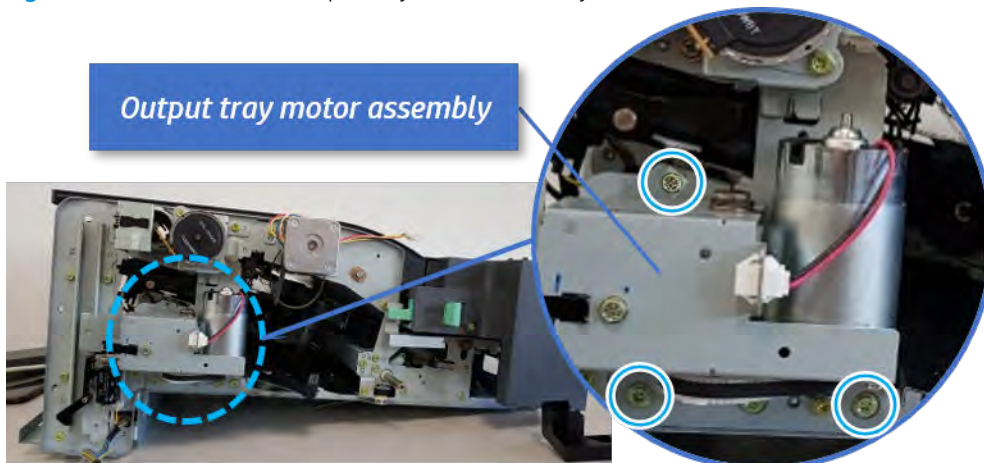


### Remove the output tray motor assembly

Follow these steps to remove the output tray motor assembly.

- ▲ Remove three screws, and then remove the output tray motor assembly.

Figure 6-249 Remove the output tray motor assembly

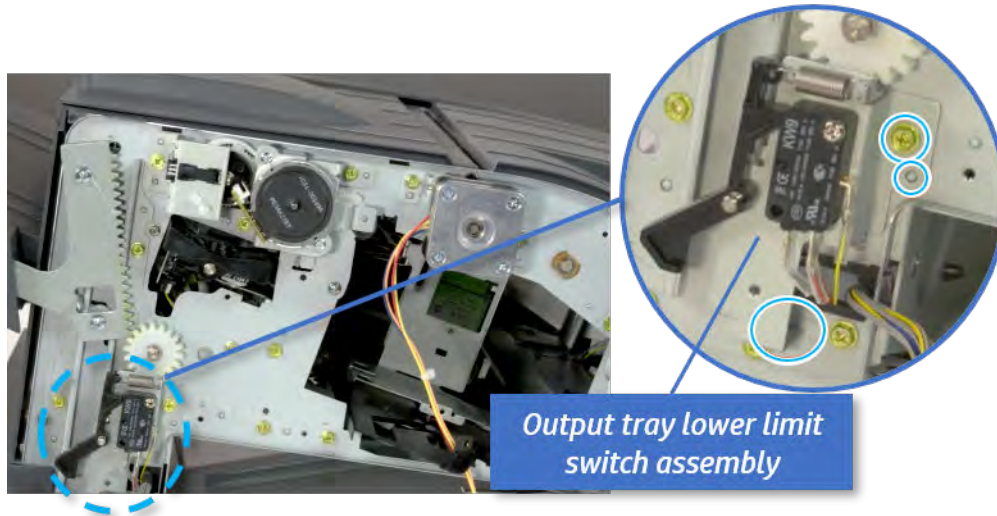


## Remove the output tray lower limit switch

Follow these steps to remove the output tray lower limit switch.

- ▲ Remove one screw, and then remove the output tray lower limit switch.

**Figure 6-250** Remove the output tray lower limit switch

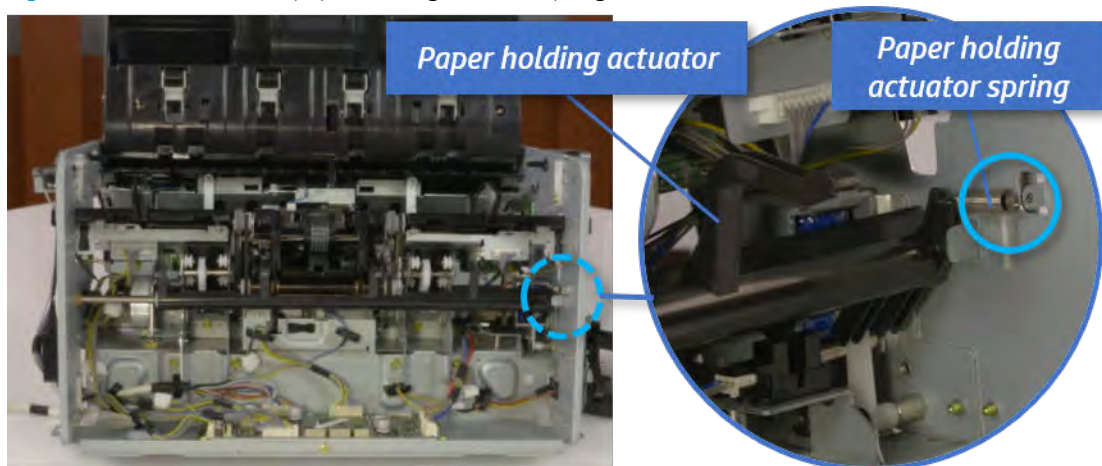


## Remove the paper holding

Follow these steps to remove the paper holding.

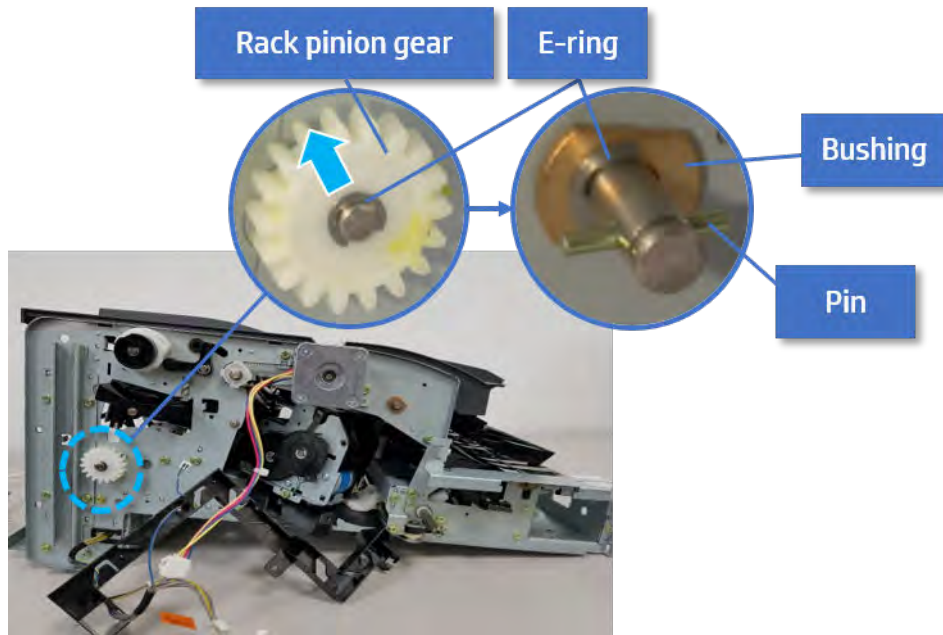
1. Remove the paper holding actuator spring.


**Figure 6-251** Remove the paper holding actuator spring



2. Remove the e-ring and the rack pinion gear. And then remove the pin and the e-ring, and then remove the bushing.

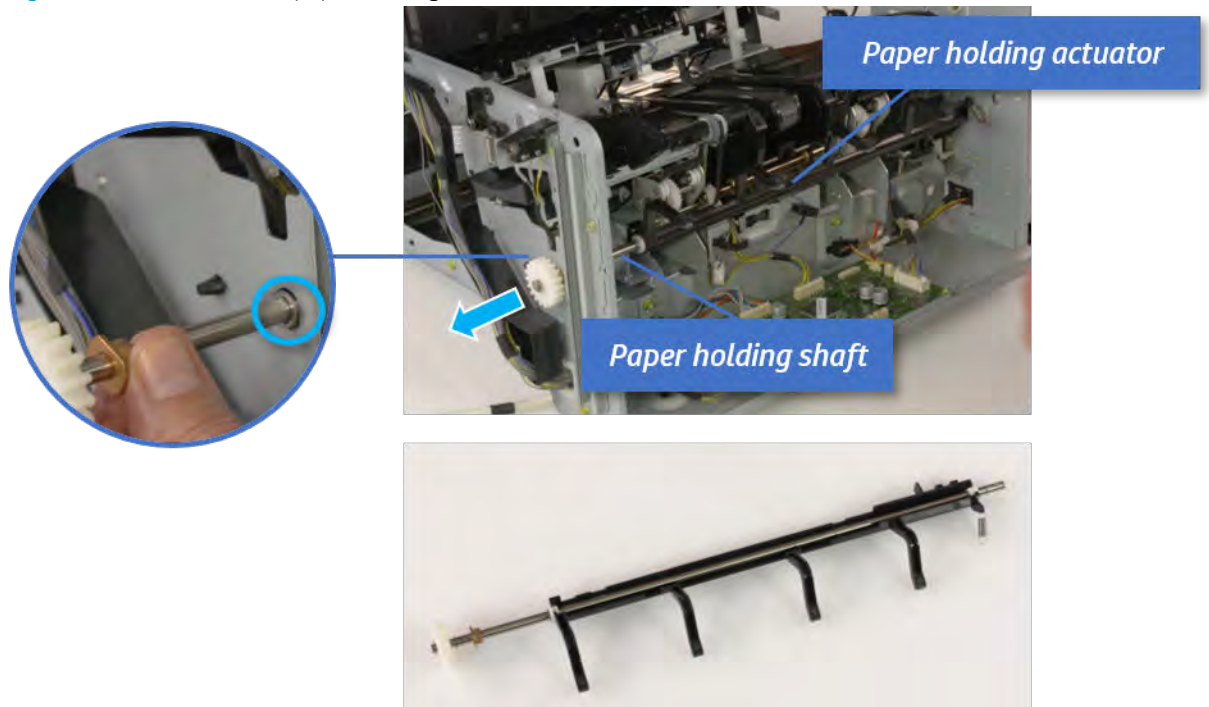
**Figure 6-252** Remove e-ring, rack pinion gear, pin, and bushing



 **NOTE:** Be sure not to lose the pin.

3. Carefully remove the paper holding shaft and the actuator.

**Figure 6-253** Remove the paper holding shaft and the actuator

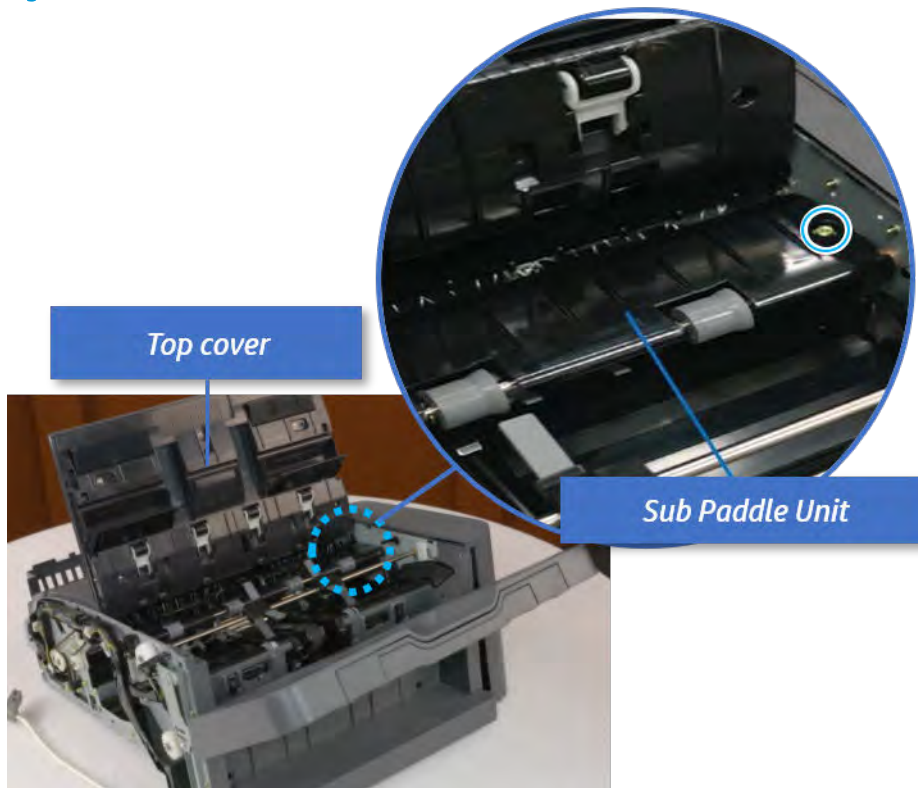


### Remove the sub paddle unit

Follow these steps to remove the sub paddle unit.

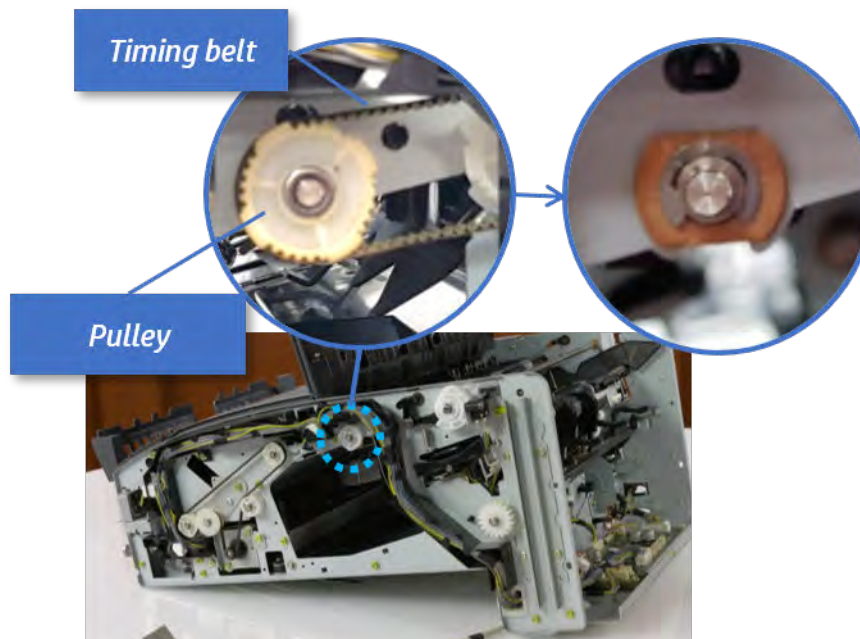
1. Open the top cover, and then remove one screw securing the sub paddle unit.

Figure 6-254 Remove one screw



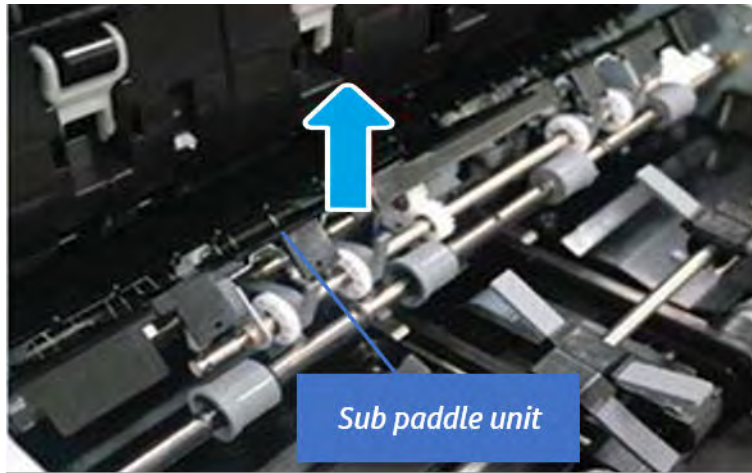
2. Remove the e-ring, and then remove the pulley and timing belt. And then remove the e-ring and the bushing.

Figure 6-255 Remove the e-ring, pulley, timing belt, and bushing



3. Lift up and remove the sub paddle unit.

Figure 6-256 Remove the sub paddle unit

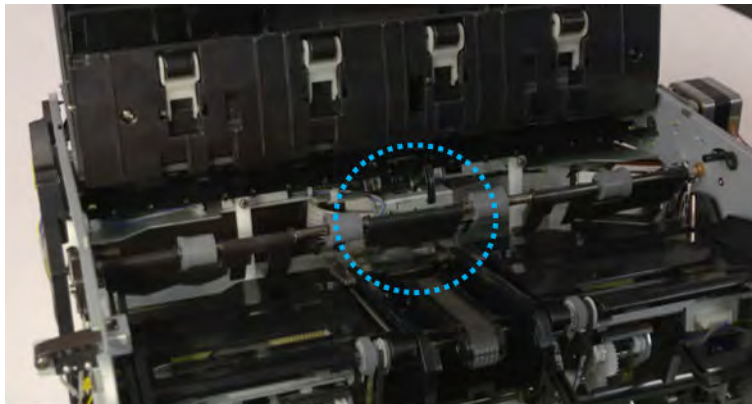


### Remove the exit roller

Follow these steps to remove the exit roller.

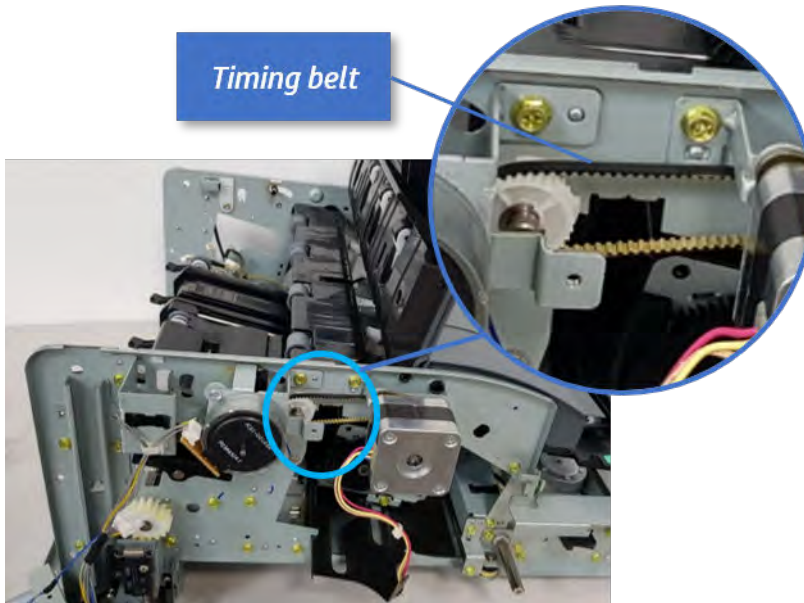
1. Remove the guide on the center of the exit roller.

Figure 6-257 Remove the guide



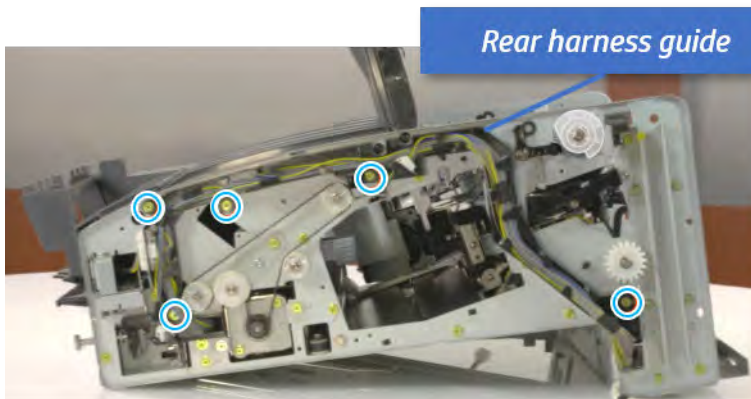
2. On the front of the inner finisher, release the timing belt connected to the exit motor.

Figure 6-258 Release the timing belt



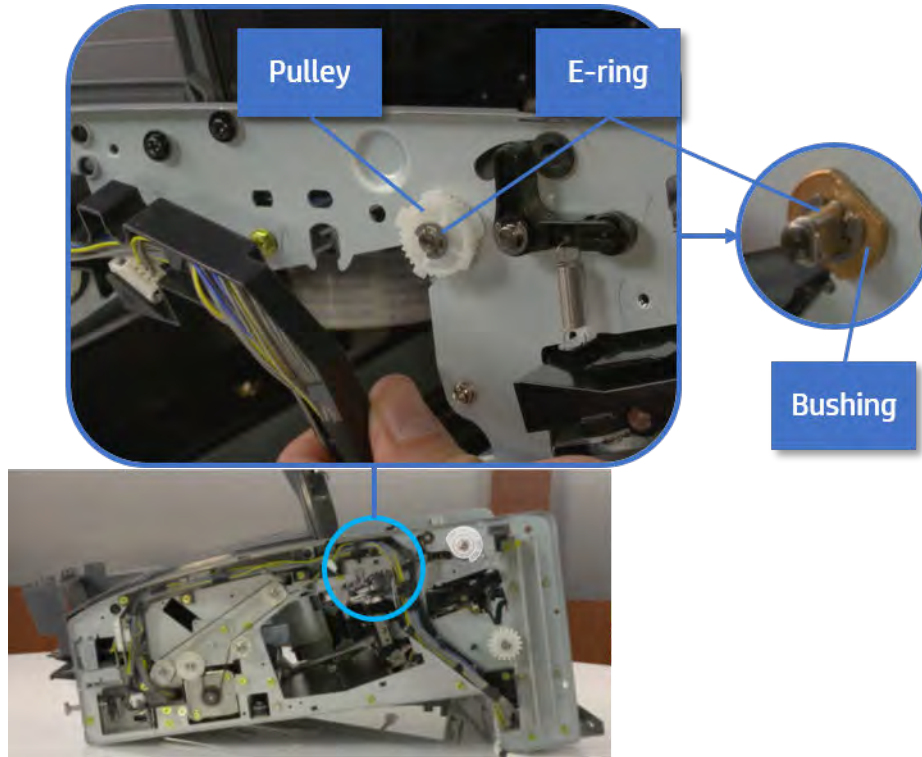
3. Remove five screws securing the rear harness guide.

Figure 6-259 Remove five screws



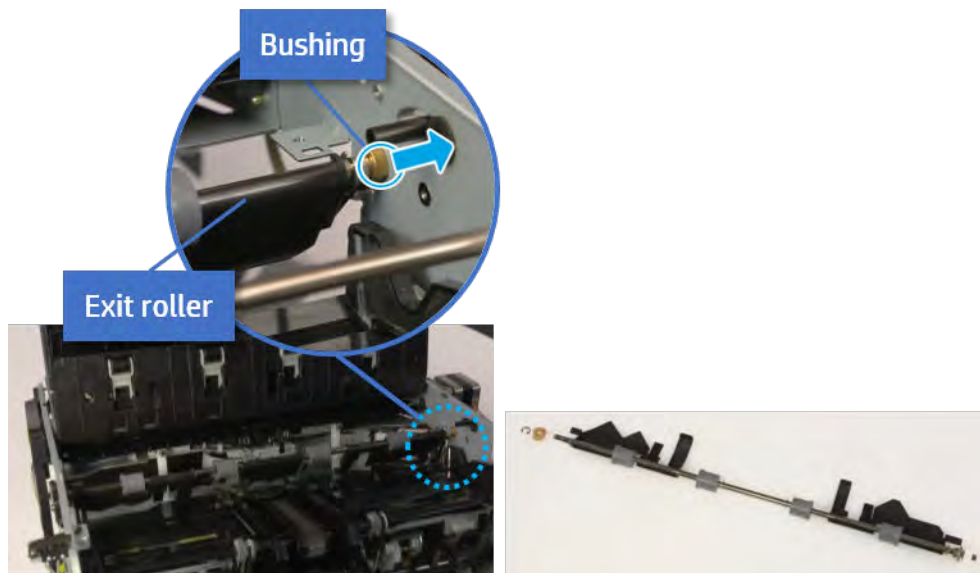
4. On the rear of the inner finisher, remove the e-ring and the pulley and then remove the e-ring and the bushing.

Figure 6-260 Remove e-ring, pulley, and bushing



5. Push the bushing to detach it, and then remove the exit roller.

Figure 6-261 Remove the exit roller

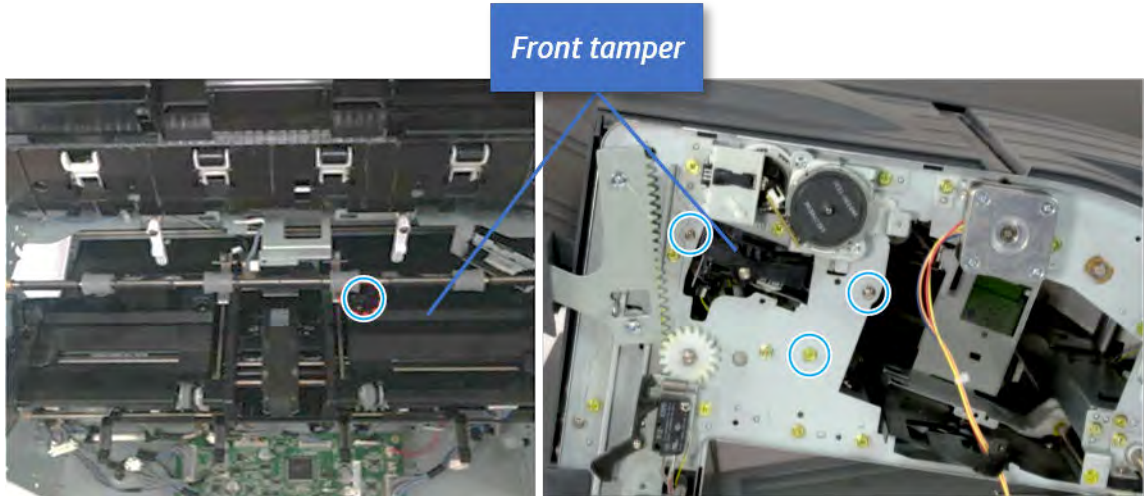


### Remove the front tamper

Follow these steps to remove the front tamper.

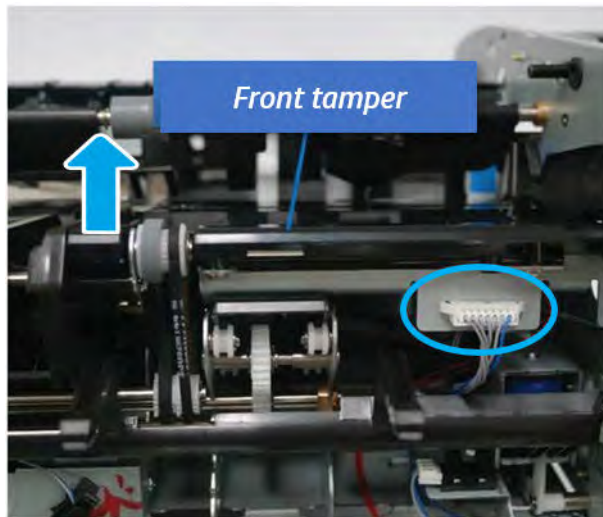
1. Remove four screws.

Figure 6-262 Remove four screws



2. Unplug the connector and release the hook, and then pull the front tamper up to remove.

Figure 6-263 Remove the front tamper



### Remove the rear tamper

Follow these steps to remove the rear tamper.

1. Remove four screws.


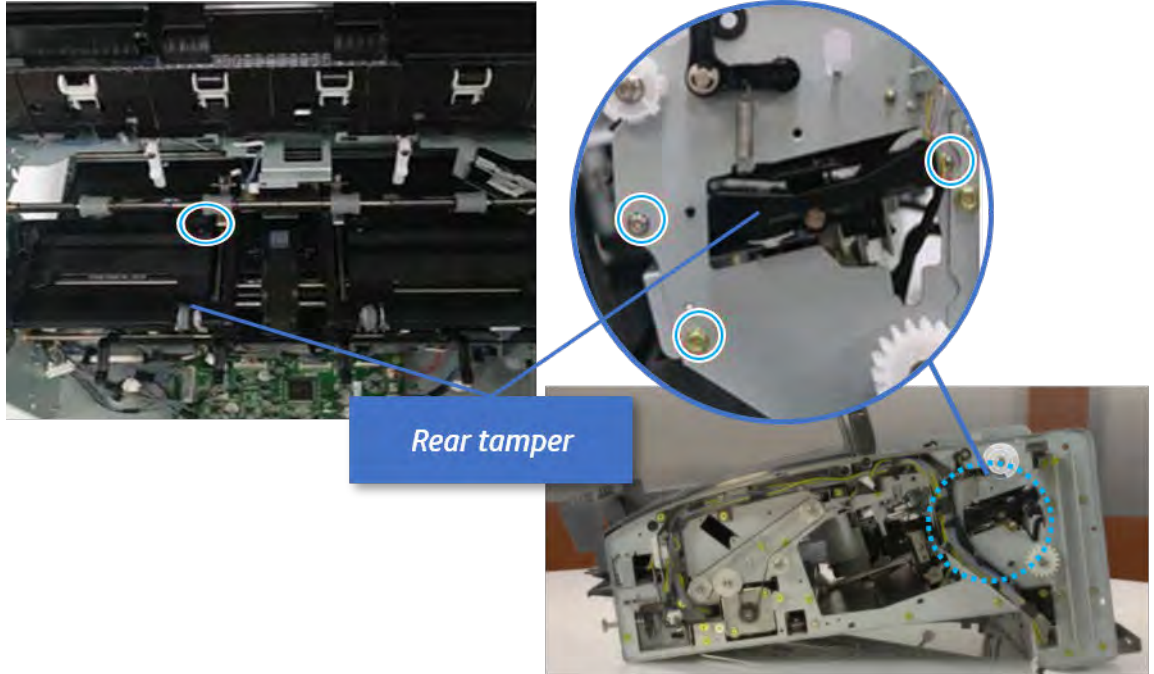
 **NOTE:** Move cable guide out of position to access the screws.

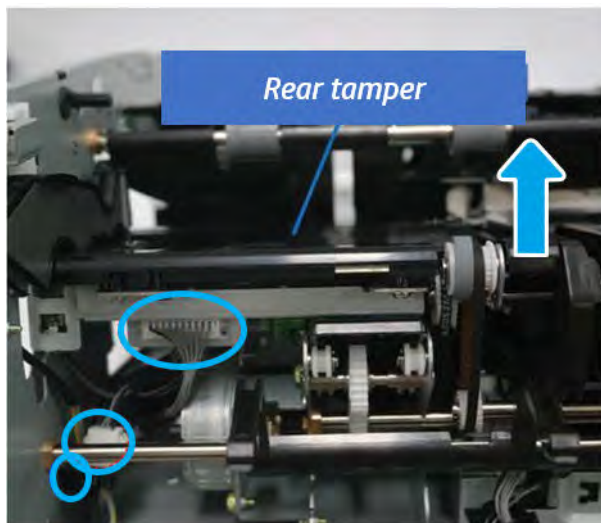


Figure 6-264 Remove four screws



2. Unplug two connectors and release the hook, and then remove the rear tamper.

Figure 6-265 Remove the rear tamper

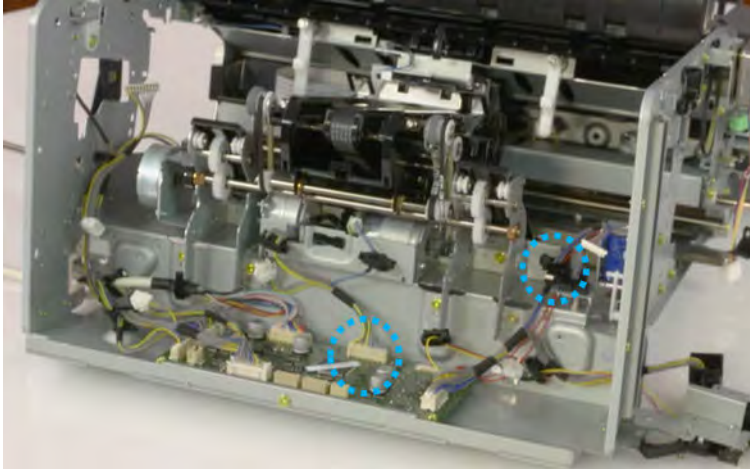


### Remove the ejector & paper support assembly

Follow these steps to remove the ejector & paper support assembly.

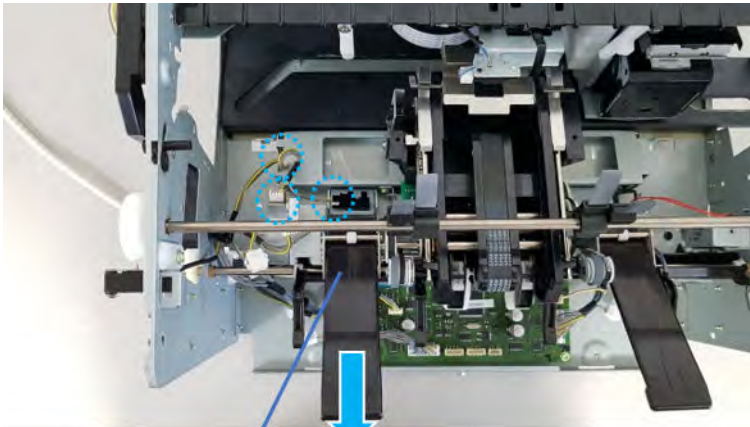
1. Open one clamp, disconnect one connector.

Figure 6-266 Disconnect one connector



2. Pull the rear paper support up, and then release one clamp and disconnect two connectors.

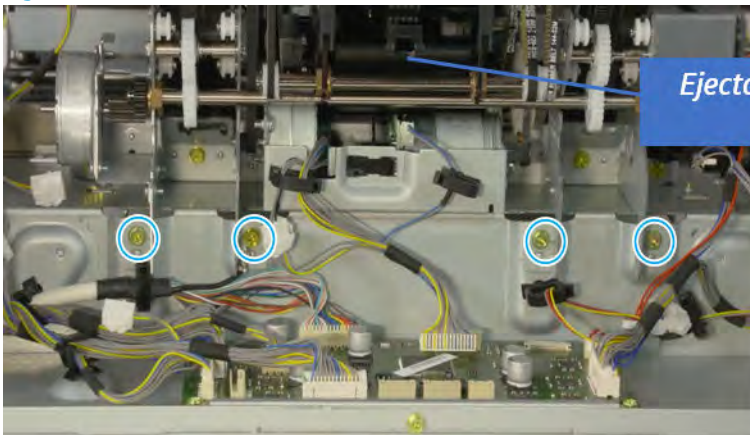
Figure 6-267 Disconnect two connector



*Rear paper support*

3. Remove four screws, and then remove the ejector & paper support assembly.

Figure 6-268 Remove the ejector & paper support assembly

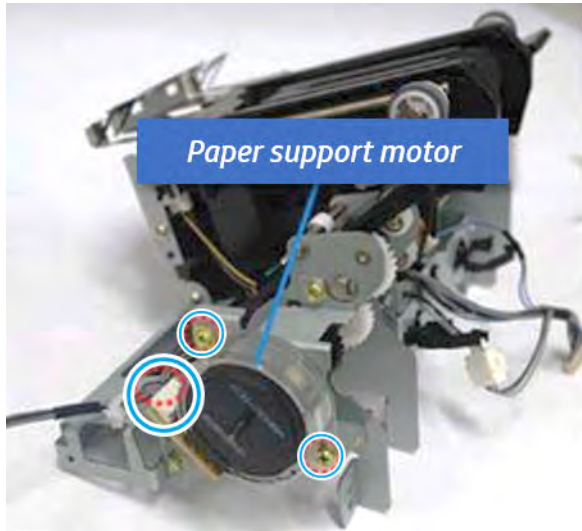


## Remove the paper support motor

Follow these steps to remove the paper support motor.

- ▲ Remove two screws, disconnect one connect, and then remove the paper support motor.

Figure 6-269 Remove the paper support motor



## Unpack the replacement assembly



Follow these steps to unpack the replacement assembly.


1. Dispose of the defective part.


 **NOTE:** HP recommends responsible disposal of the defective part.

<http://www8.hp.com/us/en/hp-information/environment/product-recycling.html>


2. Unpack the replacement part from the packaging.

 **CAUTION:**  Some parts are sensitive to electrostatic discharge (ESD). Always perform service work at an ESD-protected workstation or mat. If an ESD workstation or mat is not available, touch the sheet-metal chassis to provide a static ground before touching an ESD-sensitive assembly. Protect the ESD-sensitive assemblies by placing them in ESD pouches when they are out of the printer.

 **IMPORTANT:** Make sure that all of the shipping materials (for example shipping tape) are removed from the replacement part prior to installation.

 **NOTE:** If the replacement part is a roller or pad, avoid touching the spongy part of it. Skin oils on the roller or pad can cause paper pickup and/or print-quality problems. HP recommends using disposable gloves when handling rollers or pads or washing your hands before touching rollers or pads.

3. To install an assembly, reverse the removal steps.

 **NOTE:** When applicable, special installation instructions are provided for an assembly at the end of the removal procedure. Always completely read the removal instructions and follow all special installation instructions.

## Paddle unit


## Removal and replacement: Main paddle

Learn how to remove and replace the main paddle.

To view teardown and reassembling video of the inner finisher, click the link below.

 [View a teardown video of the inner finisher.](#)

 [View a reassembling video of the inner finisher.](#)

 **IMPORTANT:** When applicable, special installation instructions are provided for an assembly at the end of the removal procedure. Always completely read the removal instructions and follow all special installation instructions.


Mean time to repair:

Service level:

### Before performing service

#### Turn the printer power off

- Press the power button on the front of the printer, and then turn off the power switch next to the power cable.
- A shutting-down message appears on the control-panel display.

 **WARNING!** To avoid damage to the printer, turn the power off and wait until the printer shuts down before removing the power cable.

- Disconnect the printer power cable after the printer has completely shut down (the control-panel display is blank).

Use the table below to identify the correct part number for your printer. To order the part, go to [www.hp.com/buy/parts](http://www.hp.com/buy/parts).

Table 6-48 Part information

Part number	Part description
JC90-01327A	Main paddle
JC82-01038A	Main paddle kit
JC63-04957A	Main paddle A
JC63-04958A	Main paddle B
JC81-07560A	Main paddle holder

### Required tools

- #2 JIS screwdriver with a magnetic tip

### After performing service

Turn the printer power on

- Connect the power cable.
- Use the power switch to turn the power on.

### Post service test

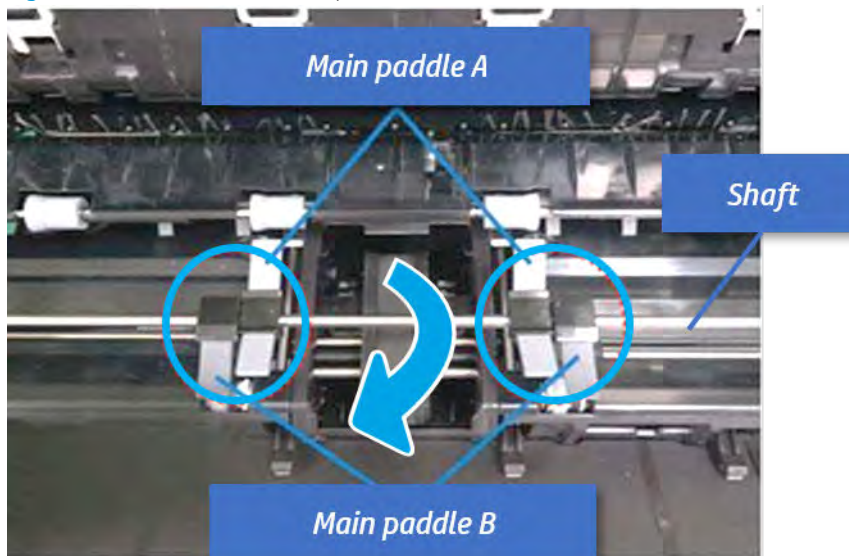
Print any pages necessary to verify that the repair resolved the issue and did not create any new issues.

### Remove the main paddle

Follow these steps to remove the main paddle.

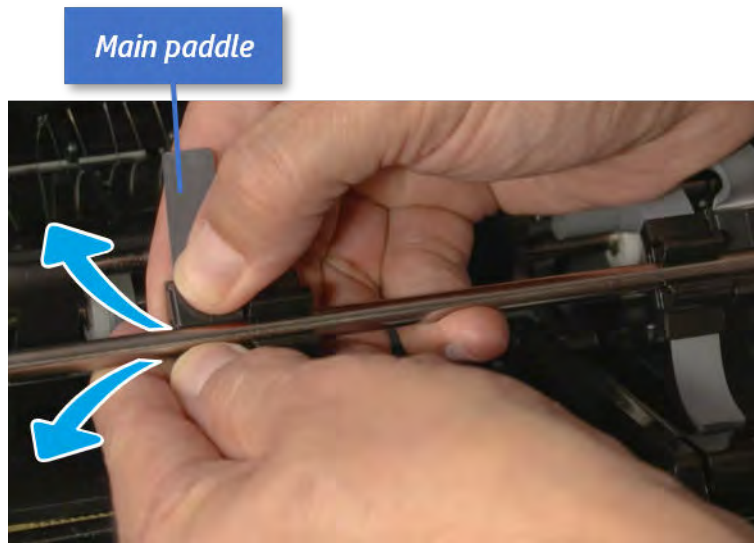
1. Open the top cover.
2. Rotate the main paddle shaft to see the lower side of the main paddle.

**Figure 6-270** Rotate the main paddle shaft

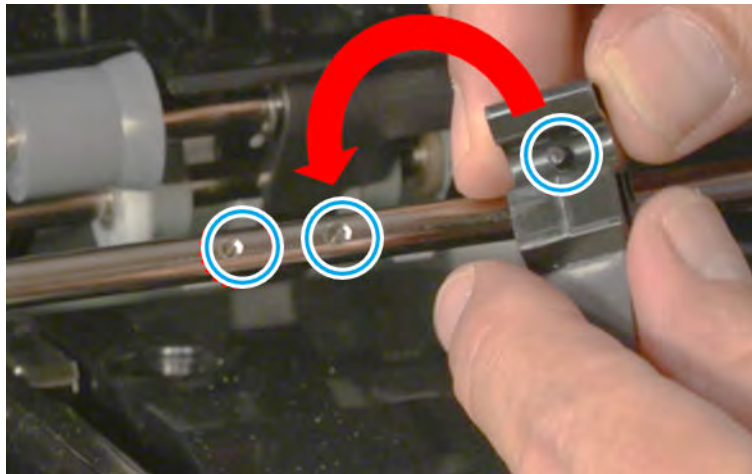


3. Remove the main paddle by pushing both sides.

Figure 6-271 Remove the main paddle



 **TIP:** When reassembling the main paddle, check the pin position of the paddle and the hole position of the shaft, and then assemble them.



### Unpack the replacement assembly

Follow these steps to unpack the replacement assembly.

1. Dispose of the defective part.



---


 **NOTE:** HP recommends responsible disposal of the defective part.


<http://www8.hp.com/us/en/hp-information/environment/product-recycling.html>

---

2. Unpack the replacement part from the packaging.


 **CAUTION:**  Some parts are sensitive to electrostatic discharge (ESD). Always perform service work at an ESD-protected workstation or mat. If an ESD workstation or mat is not available, touch the sheet-metal chassis to provide a static ground before touching an ESD-sensitive assembly. Protect the ESD-sensitive assemblies by placing them in ESD pouches when they are out of the printer.

 **IMPORTANT:** Make sure that all of the shipping materials (for example shipping tape) are removed from the replacement part prior to installation.

 **NOTE:** If the replacement part is a roller or pad, avoid touching the spongy part of it. Skin oils on the roller or pad can cause paper pickup and/or print-quality problems. HP recommends using disposable gloves when handling rollers or pads or washing your hands before touching rollers or pads.

---

3. To install an assembly, reverse the removal steps.

 **NOTE:** When applicable, special installation instructions are provided for an assembly at the end of the removal procedure. Always completely read the removal instructions and follow all special installation instructions.

---



## Removal and replacement: Main paddle home sensor (S4)


Learn how to remove and replace the main paddle home sensor.

To view teardown and reassembling video of the inner finisher, click the link below.

 [View a teardown video of the inner finisher.](#)

 [View a reassembling video of the inner finisher.](#)

---

 **IMPORTANT:** When applicable, special installation instructions are provided for an assembly at the end of the removal procedure. Always completely read the removal instructions and follow all special installation instructions.

---

Mean time to repair:

Service level:

### Before performing service

#### Turn the printer power off

- Press the power button on the front of the printer, and then turn off the power switch next to the power cable.
- A shutting-down message appears on the control-panel display.

---

 **WARNING!** To avoid damage to the printer, turn the power off and wait until the printer shuts down before removing the power cable.

---

- Disconnect the printer power cable after the printer has completely shut down (the control-panel display is blank).

Use the table below to identify the correct part number for your printer. To order the part, go to [www.hp.com/buy/parts](http://www.hp.com/buy/parts).

Table 6-49 Part information

Part number	Part description
0604-001393	Main paddle home sensor

### Required tools

- #2 JIS screwdriver with a magnetic tip

### After performing service

#### Turn the printer power on

- Connect the power cable.
- Use the power switch to turn the power on.

### Post service test

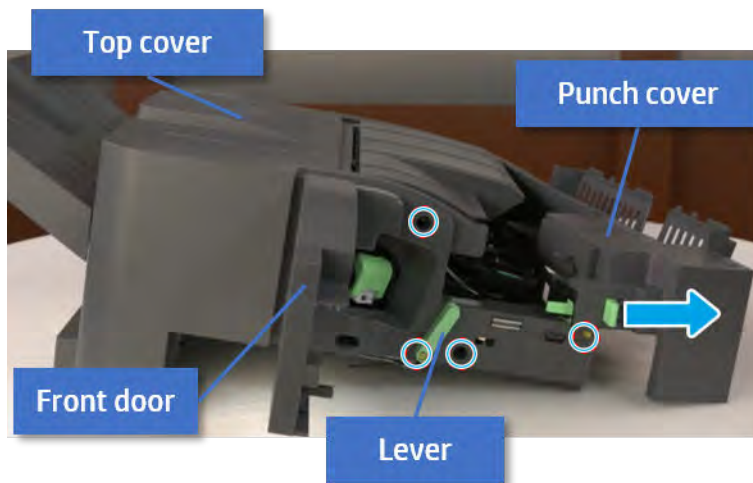
Print any pages necessary to verify that the repair resolved the issue and did not create any new issues.

## Remove the front cover

Follow these steps to remove the front cover.

1. Open the front door and open the punch cover.
2. Remove three screws in the front.
3. Remove the lever.
4. Open the top cover.
5. From the right side of the front cover, carefully lift and pry toward the top-left corner to remove the front cover.

Figure 6-272 Remove the front cover

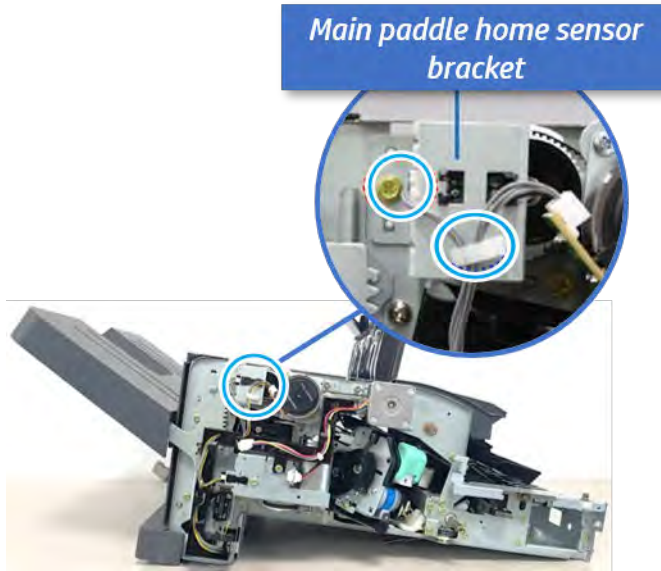


## Remove the main paddle home sensor

Follow these steps to remove the main paddle home sensor.

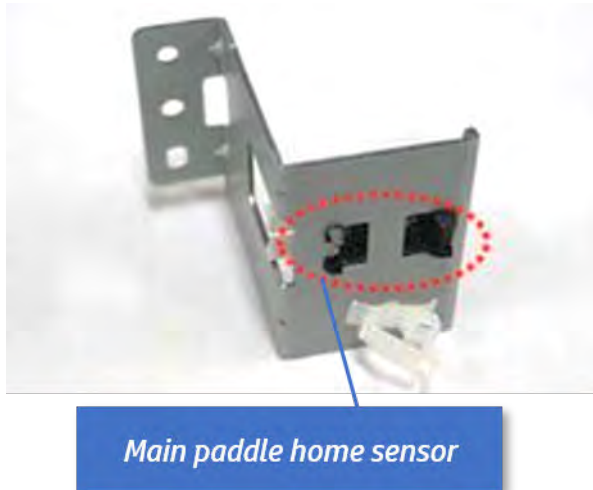
1. Remove one screw. Open the clamp and unplug one connector, and then remove the main paddle home sensor bracket.

Figure 6-273 Remove the main paddle home sensor bracket



2. Remove the main paddle home sensor from the bracket.

Figure 6-274 Remove the main paddle home sensor



### Unpack the replacement assembly

Follow these steps to unpack the replacement assembly.

1. Dispose of the defective part.



---


 **NOTE:** HP recommends responsible disposal of the defective part.


<http://www8.hp.com/us/en/hp-information/environment/product-recycling.html>

---

2. Unpack the replacement part from the packaging.


 **CAUTION:**  Some parts are sensitive to electrostatic discharge (ESD). Always perform service work at an ESD-protected workstation or mat. If an ESD workstation or mat is not available, touch the sheet-metal chassis to provide a static ground before touching an ESD-sensitive assembly. Protect the ESD-sensitive assemblies by placing them in ESD pouches when they are out of the printer.

 **IMPORTANT:** Make sure that all of the shipping materials (for example shipping tape) are removed from the replacement part prior to installation.

 **NOTE:** If the replacement part is a roller or pad, avoid touching the spongy part of it. Skin oils on the roller or pad can cause paper pickup and/or print-quality problems. HP recommends using disposable gloves when handling rollers or pads or washing your hands before touching rollers or pads.

---

3. To install an assembly, reverse the removal steps.

 **NOTE:** When applicable, special installation instructions are provided for an assembly at the end of the removal procedure. Always completely read the removal instructions and follow all special installation instructions.

---


## Removal and replacement: Main paddle motor (M3)

Learn how to remove and replace the main paddle motor.

To view teardown and reassembling video of the inner finisher, click the link below.

 [View a teardown video of the inner finisher.](#)

 [View a reassembling video of the inner finisher.](#)

 **IMPORTANT:** When applicable, special installation instructions are provided for an assembly at the end of the removal procedure. Always completely read the removal instructions and follow all special installation instructions.


Mean time to repair:

Service level:

### Before performing service

#### Turn the printer power off

- Press the power button on the front of the printer, and then turn off the power switch next to the power cable.
- A shutting-down message appears on the control-panel display.

 **WARNING!** To avoid damage to the printer, turn the power off and wait until the printer shuts down before removing the power cable.

- Disconnect the printer power cable after the printer has completely shut down (the control-panel display is blank).

Use the table below to identify the correct part number for your printer. To order the part, go to [www.hp.com/buy/parts](http://www.hp.com/buy/parts).

Table 6-50 Part information

Part number	Part description
JC93-01001A	Main paddle motor assembly

### Required tools

- #2 JIS screwdriver with a magnetic tip

### After performing service

#### Turn the printer power on

- Connect the power cable.
- Use the power switch to turn the power on.

### Post service test

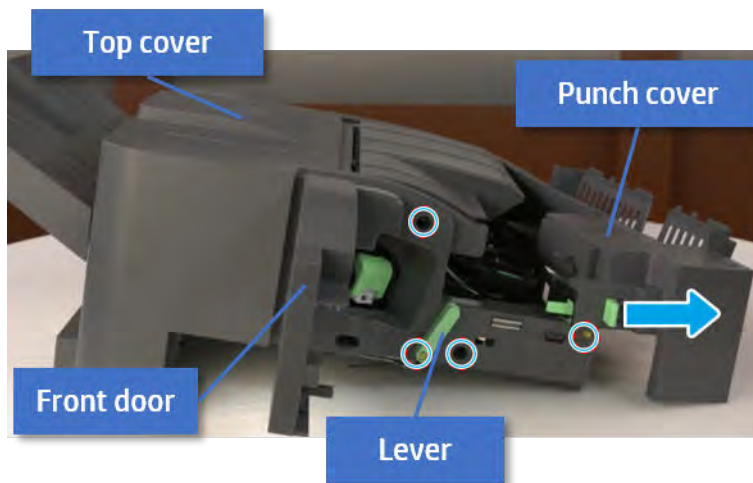
Print any pages necessary to verify that the repair resolved the issue and did not create any new issues.

## Remove the front cover

Follow these steps to remove the front cover.

1. Open the front door and open the punch cover.
2. Remove three screws in the front.
3. Remove the lever.
4. Open the top cover.
5. From the right side of the front cover, carefully lift and pry toward the top-left corner to remove the front cover.

Figure 6-275 Remove the front cover

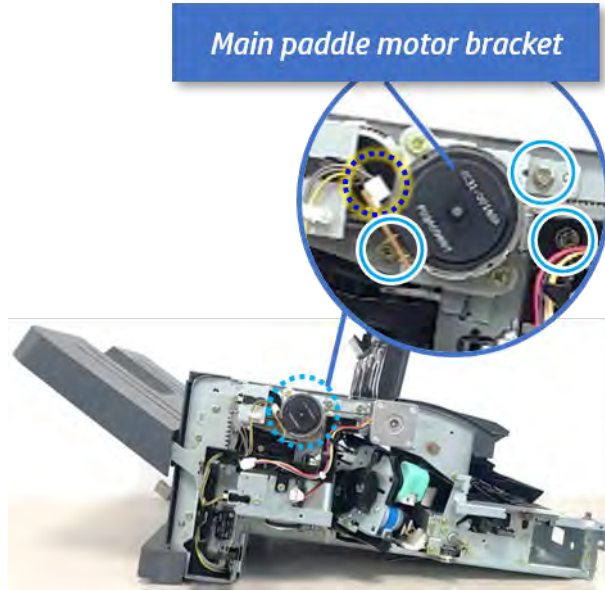


## Remove the main paddle motor

Follow these steps to remove the main paddle motor.

1. Remove three screws, unplug the connector, and then remove the main paddle motor bracket.

Figure 6-276 Remove the main paddle motor bracket



2. Remove two screws, and then remove the motor from the bracket.

Figure 6-277 Remove the main paddle motor



### Unpack the replacement assembly

Follow these steps to unpack the replacement assembly.

1. Dispose of the defective part.



---


 **NOTE:** HP recommends responsible disposal of the defective part.


<http://www8.hp.com/us/en/hp-information/environment/product-recycling.html>

---

2. Unpack the replacement part from the packaging.


 **CAUTION:**  Some parts are sensitive to electrostatic discharge (ESD). Always perform service work at an ESD-protected workstation or mat. If an ESD workstation or mat is not available, touch the sheet-metal chassis to provide a static ground before touching an ESD-sensitive assembly. Protect the ESD-sensitive assemblies by placing them in ESD pouches when they are out of the printer.

 **IMPORTANT:** Make sure that all of the shipping materials (for example shipping tape) are removed from the replacement part prior to installation.

 **NOTE:** If the replacement part is a roller or pad, avoid touching the spongy part of it. Skin oils on the roller or pad can cause paper pickup and/or print-quality problems. HP recommends using disposable gloves when handling rollers or pads or washing your hands before touching rollers or pads.

---

3. To install an assembly, reverse the removal steps.

 **NOTE:** When applicable, special installation instructions are provided for an assembly at the end of the removal procedure. Always completely read the removal instructions and follow all special installation instructions.

---



## Removal and replacement: Main paddle assembly


Learn how to remove and replace the main paddle assembly.

To view teardown and reassembling video of the inner finisher, click the link below.

 [View a teardown video of the inner finisher.](#)

 [View a reassembling video of the inner finisher.](#)

---

 **IMPORTANT:** When applicable, special installation instructions are provided for an assembly at the end of the removal procedure. Always completely read the removal instructions and follow all special installation instructions.

---

Mean time to repair:


Service level:

### Before performing service

#### Turn the printer power off

- Press the power button on the front of the printer, and then turn off the power switch next to the power cable.
- A shutting-down message appears on the control-panel display.

---

 **WARNING!** To avoid damage to the printer, turn the power off and wait until the printer shuts down before removing the power cable.

---

- Disconnect the printer power cable after the printer has completely shut down (the control-panel display is blank).

Use the table below to identify the correct part number for your printer. To order the part, go to <http://www.hp.com/buy/parts>.

**Table 6-51** Part information

Part number	Part description
JC90-01327A (not orderable)	Main paddle assembly

### Required tools

- #2 JIS screwdriver with a magnetic tip

### After performing service

#### Turn the printer power on

- Connect the power cable.
- Use the power switch to turn the power on.

### Post service test

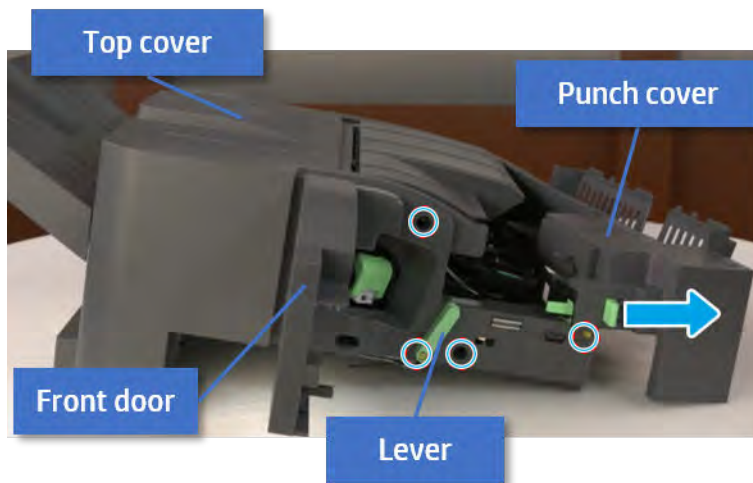
Print any pages necessary to verify that the repair resolved the issue and did not create any new issues.

## Remove the front cover

Follow these steps to remove the front cover.

1. Open the front door and open the punch cover.
2. Remove three screws in the front.
3. Remove the lever.
4. Open the top cover.
5. From the right side of the front cover, carefully lift and pry toward the top-left corner to remove the front cover.

Figure 6-278 Remove the front cover

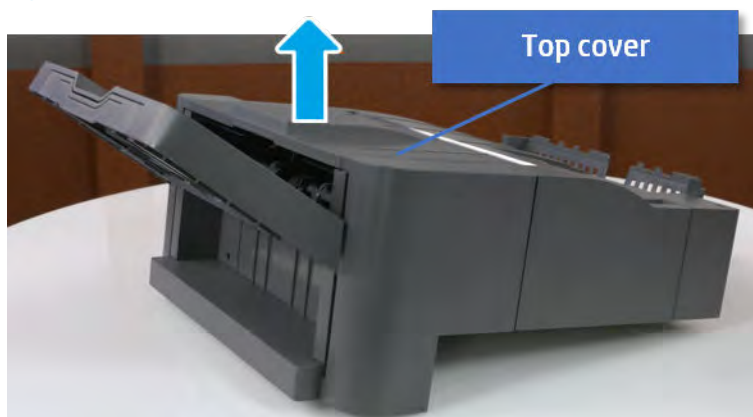


## Remove the rear cover

Follow these steps to remove the rear cover.

1. Open the top cover.

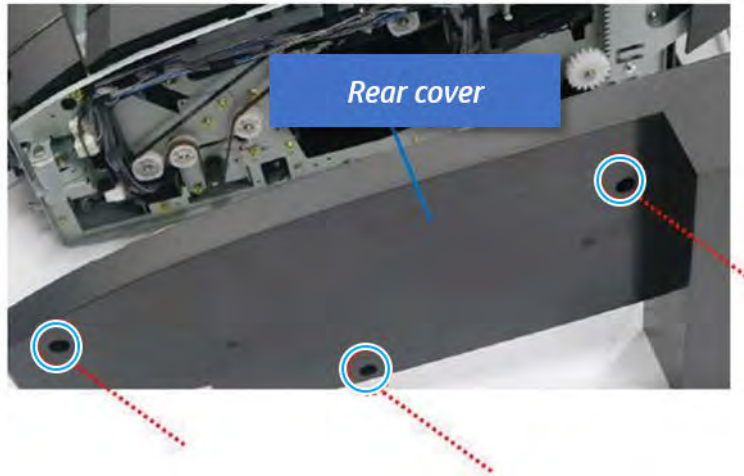
Figure 6-279 Open the top cover



2. Remove three screws.

3. Release hooks carefully and remove the rear cover.

Figure 6-280 Remove the rear cover

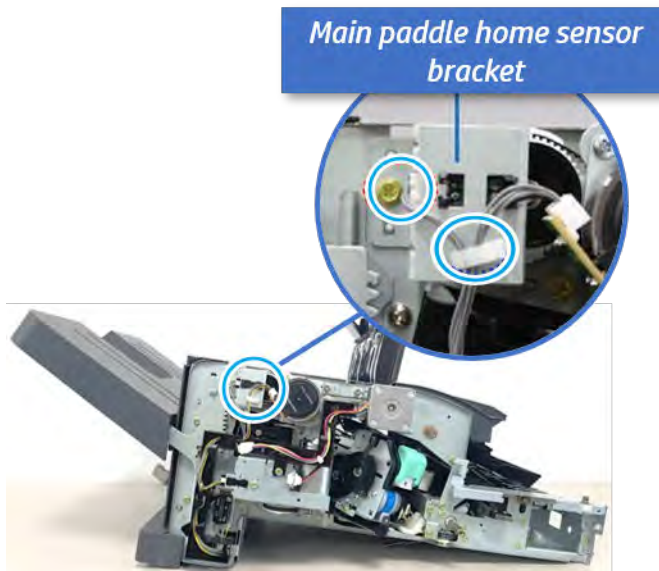


### Remove the main paddle home sensor bracket

Follow these steps to remove the main paddle home sensor bracket.

- ▲ Remove one screw. Open the clamp and unplug one connector, and then remove the main paddle home sensor bracket.

Figure 6-281 Remove the main paddle home sensor bracket

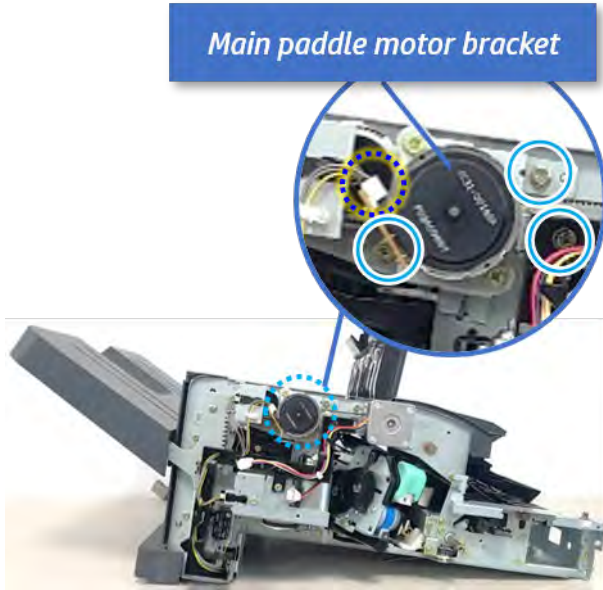


### Remove the main paddle motor bracket

Follow these steps to remove the main paddle motor bracket.

- ▲ Remove three screws, unplug the connector, and then remove the main paddle motor bracket.

Figure 6-282 Remove the main paddle motor bracket

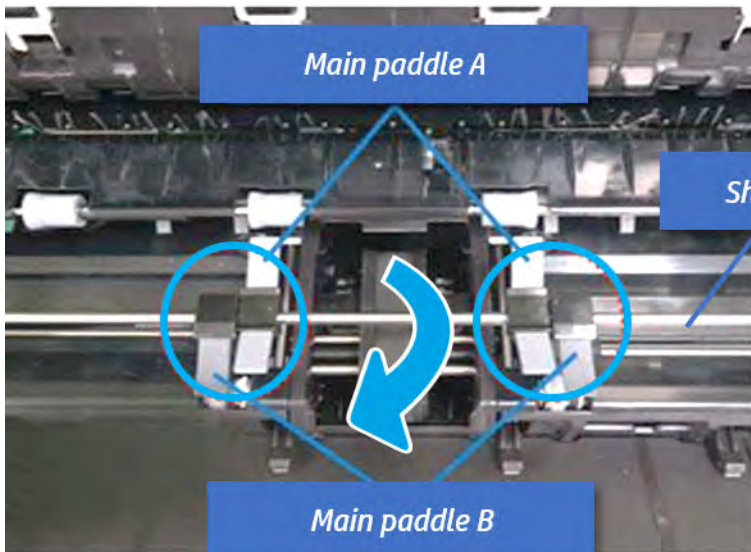


### Remove the main paddle

Follow these steps to remove the main paddle.

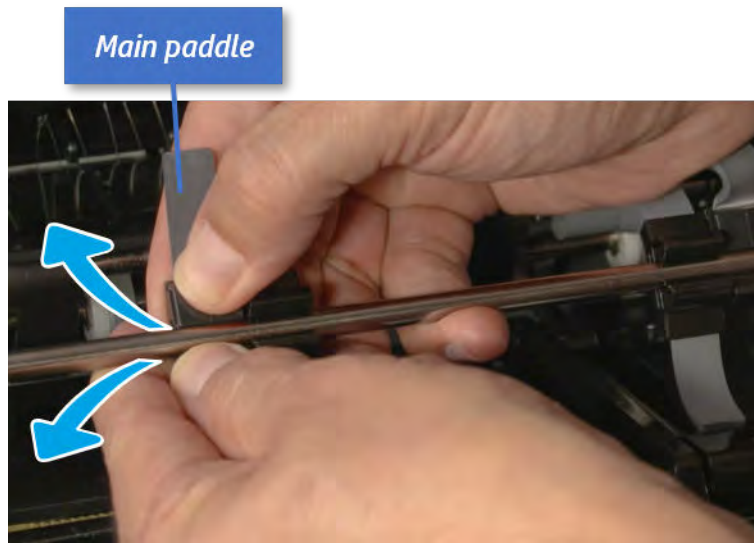
1. Open the top cover.
2. Rotate the main paddle shaft to see the lower side of the main paddle.


Figure 6-283 Rotate the main paddle shaft

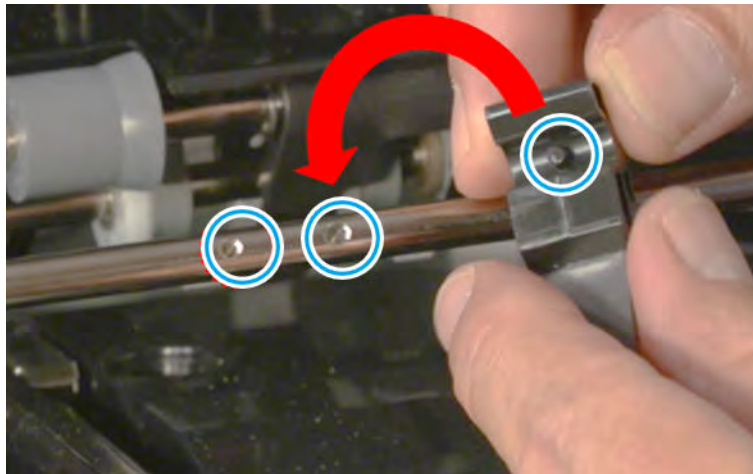


3. Remove the main paddle by pushing both sides.

Figure 6-284 Remove the main paddle



 **TIP:** When reassembling the main paddle, check the pin position of the paddle and the hole position of the shaft, and then assemble them.

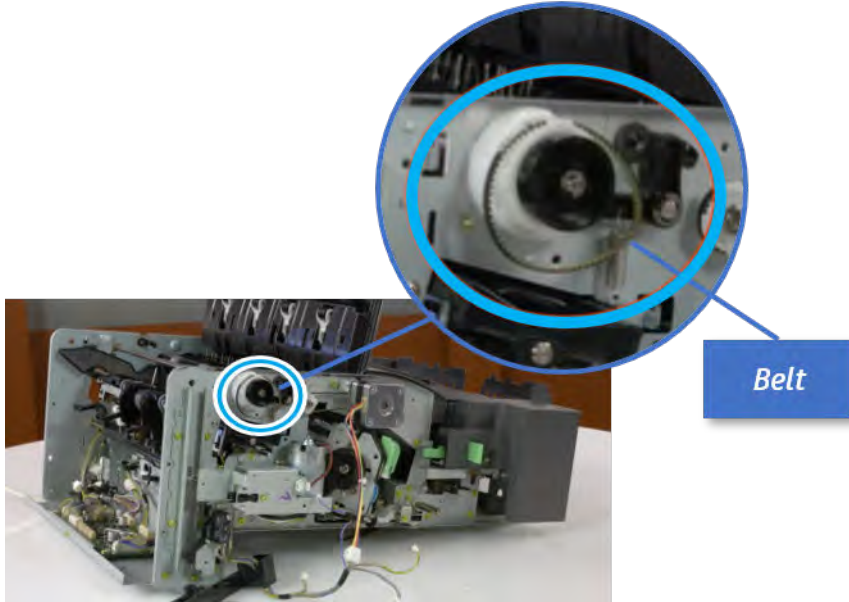


### Remove the main paddle assembly

Follow these steps to remove the main paddle assembly.

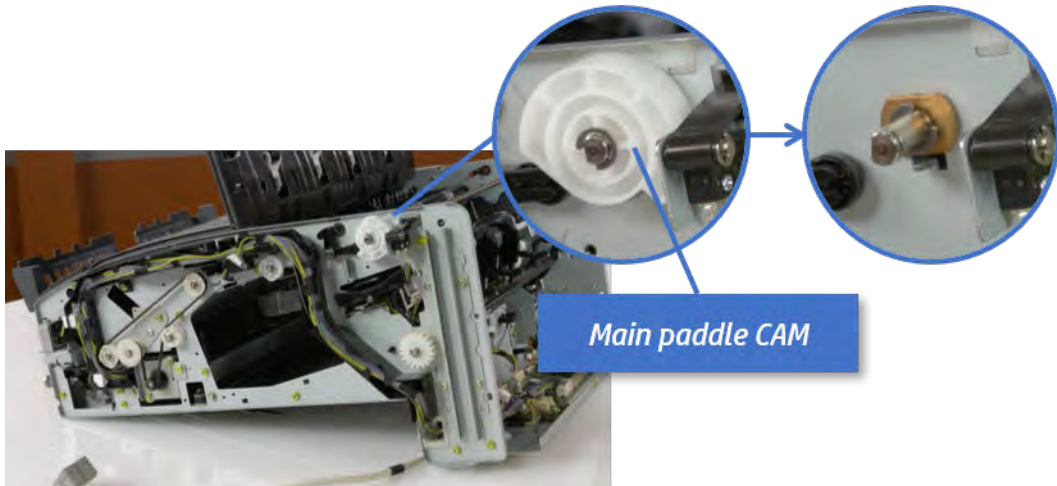
1. Remove the belt in the front.

Figure 6-285 Remove the belt



2. Remove the e-ring and the main paddle CAM in the rear. And then remove the e-ring and the bushing.

Figure 6-286 Remove the e-ring, cam, and bushing



3. Push the shaft to remove the main paddle shaft.

Figure 6-287 Remove the main paddle shaft



Main paddle shaft



### Unpack the replacement assembly

Follow these steps to unpack the replacement assembly.

1. Dispose of the defective part.




**NOTE:** HP recommends responsible disposal of the defective part.

<http://www8.hp.com/us/en/hp-information/environment/product-recycling.html>

2. Unpack the replacement part from the packaging.



**CAUTION:**  Some parts are sensitive to electrostatic discharge (ESD). Always perform service work at an ESD-protected workstation or mat. If an ESD workstation or mat is not available, touch the sheet-metal chassis to provide a static ground before touching an ESD-sensitive assembly. Protect the ESD-sensitive assemblies by placing them in ESD pouches when they are out of the printer.



**IMPORTANT:** Make sure that all of the shipping materials (for example shipping tape) are removed from the replacement part prior to installation.



**NOTE:** If the replacement part is a roller or pad, avoid touching the spongy part of it. Skin oils on the roller or pad can cause paper pickup and/or print-quality problems. HP recommends using disposable gloves when handling rollers or pads or washing your hands before touching rollers or pads.

3. To install an assembly, reverse the removal steps.



**NOTE:** When applicable, special installation instructions are provided for an assembly at the end of the removal procedure. Always completely read the removal instructions and follow all special installation instructions.

## Removal and replacement: Sub paddle unit


Learn how to remove and replace the sub paddle unit.

To view teardown and reassembling video of the inner finisher, click the link below.

 [View a teardown video of the inner finisher.](#)

 [View a reassembling video of the inner finisher.](#)

---

 **IMPORTANT:** When applicable, special installation instructions are provided for an assembly at the end of the removal procedure. Always completely read the removal instructions and follow all special installation instructions.

---

Mean time to repair:


Service level:

### Before performing service

#### Turn the printer power off

- Press the power button on the front of the printer, and then turn off the power switch next to the power cable.
- A shutting-down message appears on the control-panel display.

---

 **WARNING!** To avoid damage to the printer, turn the power off and wait until the printer shuts down before removing the power cable.

---

- Disconnect the printer power cable after the printer has completely shut down (the control-panel display is blank).

Use the table below to identify the correct part number for your printer. To order the part, go to <http://www.hp.com/buy/parts>.

Table 6-52 Part information

Part number	Part description
JC90-01336A	Sub paddle unit

### Required tools

- #2 JIS screwdriver with a magnetic tip

### After performing service

#### Turn the printer power on

- Connect the power cable.
- Use the power switch to turn the power on.

### Post service test

Print any pages necessary to verify that the repair resolved the issue and did not create any new issues.

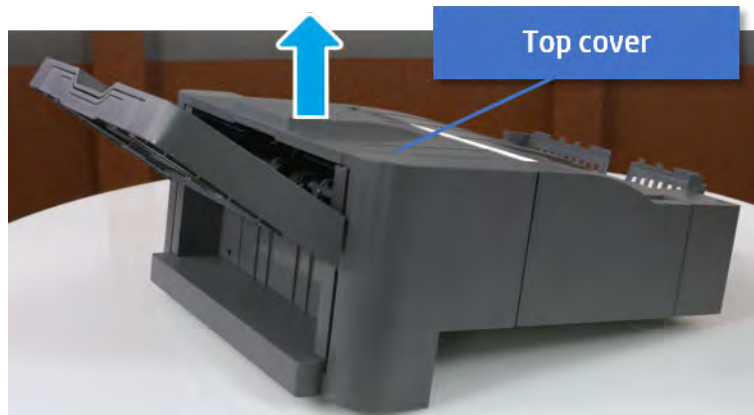


## Remove the rear cover

Follow these steps to remove the rear cover.

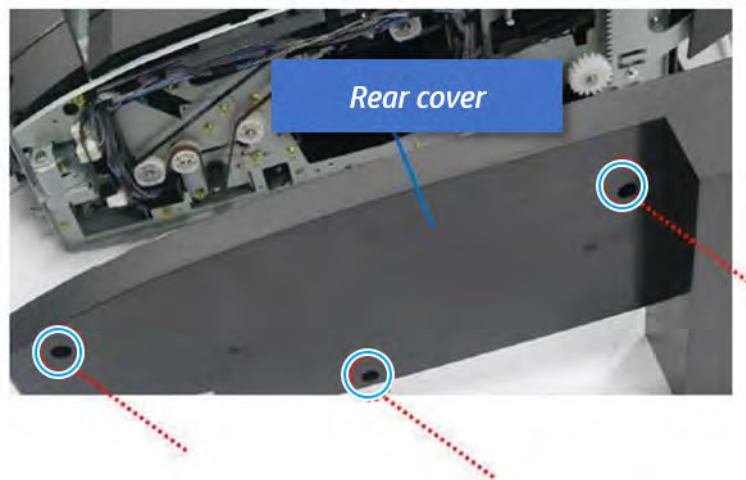
1. Open the top cover.

Figure 6-288 Open the top cover



2. Remove three screws.
3. Release hooks carefully and remove the rear cover.

Figure 6-289 Remove the rear cover

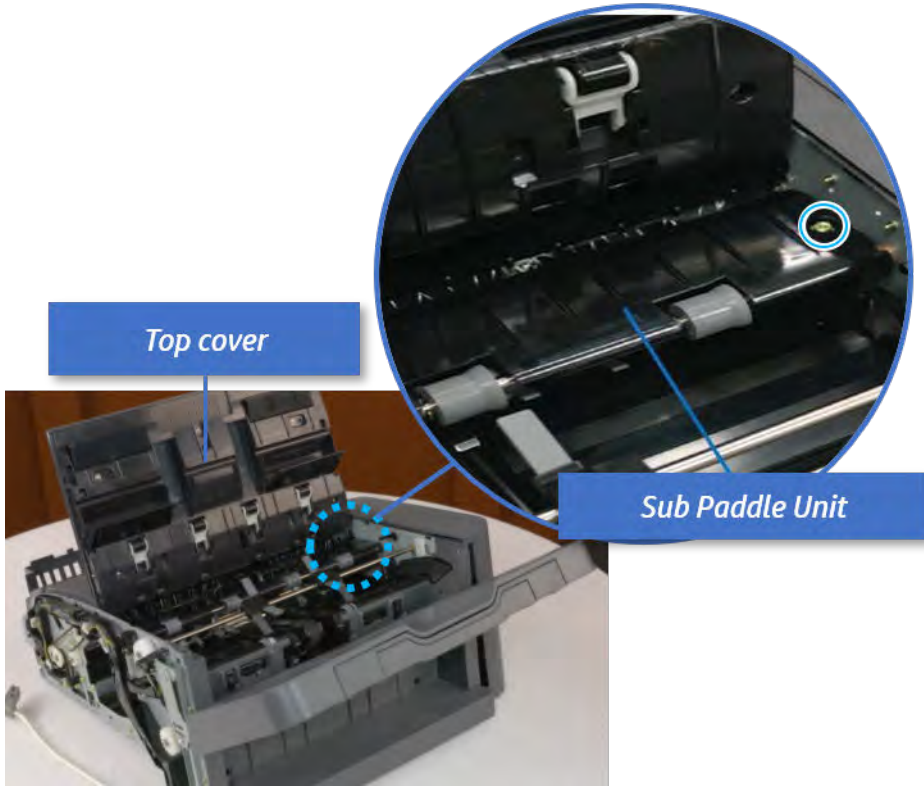


## Remove the sub paddle unit

Follow these steps to remove the sub paddle unit.

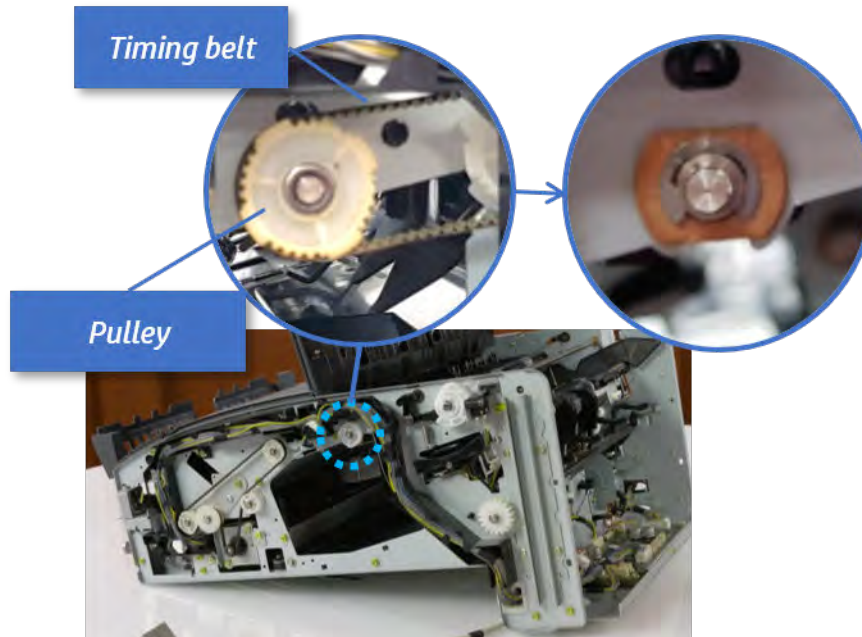
1. Open the top cover, and then remove one screw securing the sub paddle unit.

Figure 6-290 Remove one screw



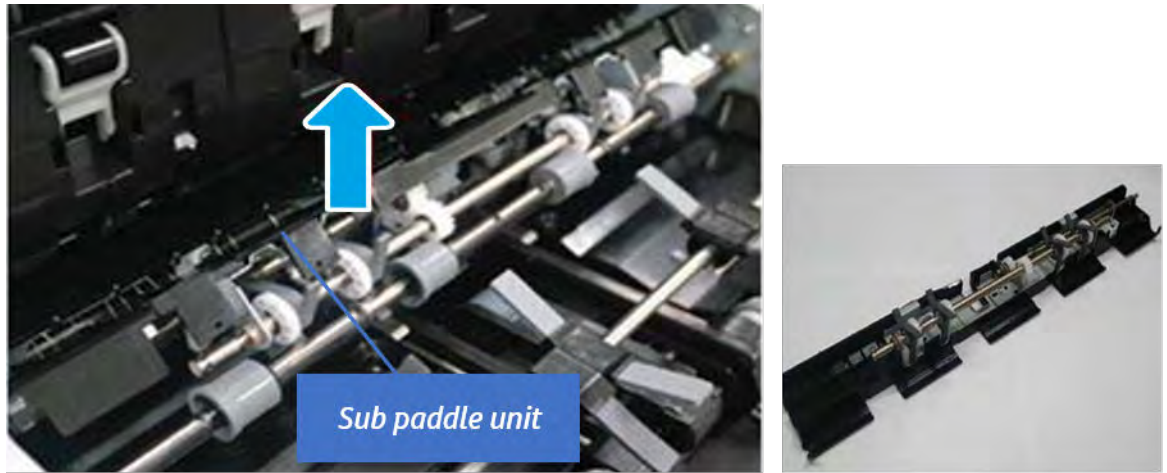
2. Remove the e-ring, and then remove the pulley and timing belt. And then remove the e-ring and the bushing.

Figure 6-291 Remove the e-ring, pulley, timing belt, and bushing



3. Lift up and remove the sub paddle unit.

Figure 6-292 Remove the sub paddle unit



### Unpack the replacement assembly



Follow these steps to unpack the replacement assembly.


1. Dispose of the defective part.


 **NOTE:** HP recommends responsible disposal of the defective part.

<http://www8.hp.com/us/en/hp-information/environment/product-recycling.html>


2. Unpack the replacement part from the packaging.

 **CAUTION:**  Some parts are sensitive to electrostatic discharge (ESD). Always perform service work at an ESD-protected workstation or mat. If an ESD workstation or mat is not available, touch the sheet-metal chassis to provide a static ground before touching an ESD-sensitive assembly. Protect the ESD-sensitive assemblies by placing them in ESD pouches when they are out of the printer.

 **IMPORTANT:** Make sure that all of the shipping materials (for example shipping tape) are removed from the replacement part prior to installation.

 **NOTE:** If the replacement part is a roller or pad, avoid touching the spongy part of it. Skin oils on the roller or pad can cause paper pickup and/or print-quality problems. HP recommends using disposable gloves when handling rollers or pads or washing your hands before touching rollers or pads.

3. To install an assembly, reverse the removal steps.

 **NOTE:** When applicable, special installation instructions are provided for an assembly at the end of the removal procedure. Always completely read the removal instructions and follow all special installation instructions.

## Tamper unit

Front tamper


## Removal and replacement: Front tamper

Learn how to remove and replace the front tamper.

To view teardown and reassembling video of the inner finisher, click the link below.

 [View a teardown video of the inner finisher.](#)

 [View a reassembling video of the inner finisher.](#)

 **IMPORTANT:** When applicable, special installation instructions are provided for an assembly at the end of the removal procedure. Always completely read the removal instructions and follow all special installation instructions.


Mean time to repair:

Service level:

## Before performing service

### Turn the printer power off

- Press the power button on the front of the printer, and then turn off the power switch next to the power cable.
- A shutting-down message appears on the control-panel display.

 **WARNING!** To avoid damage to the printer, turn the power off and wait until the printer shuts down before removing the power cable.

- Disconnect the printer power cable after the printer has completely shut down (the control-panel display is blank).

Use the table below to identify the correct part number for your printer. To order the part, go to <http://www.hp.com/buy/parts>.

**Table 6-53** Part information

Part number	Part description
JC82-00899A	Front tamper

## Required tools

- #2 JIS screwdriver with a magnetic tip

## After performing service

### Turn the printer power on

- Connect the power cable.
- Use the power switch to turn the power on.

## Post service test

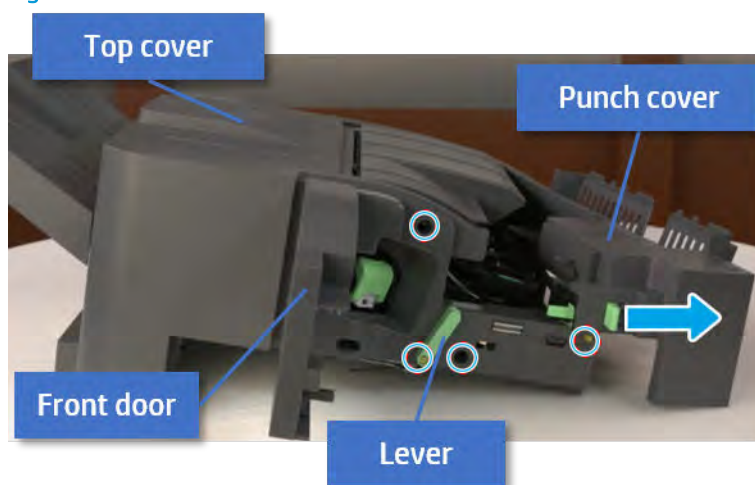
Print any pages necessary to verify that the repair resolved the issue and did not create any new issues.

## Remove the front cover

Follow these steps to remove the front cover:

1. Open the front door and open the punch cover.
2. Remove three screws in the front.
3. Remove the lever.
4. Open the top cover.
5. From the right side of the front cover, carefully lift and pry toward the top-left corner to remove the front cover.

Figure 6-293 Remove the front cover

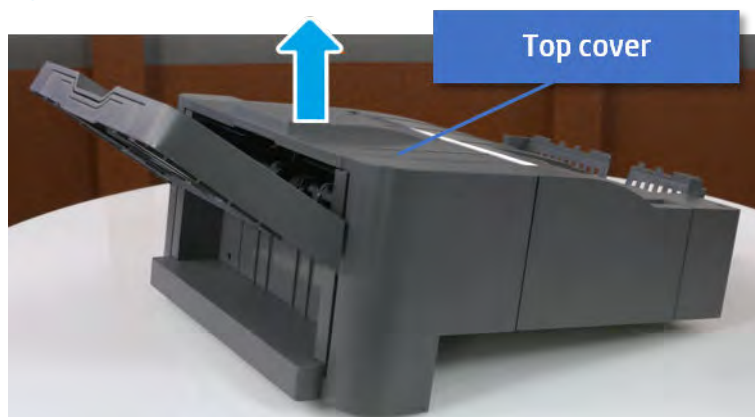


## Remove the rear cover

Follow these steps to remove the rear cover:

1. Open the top cover.

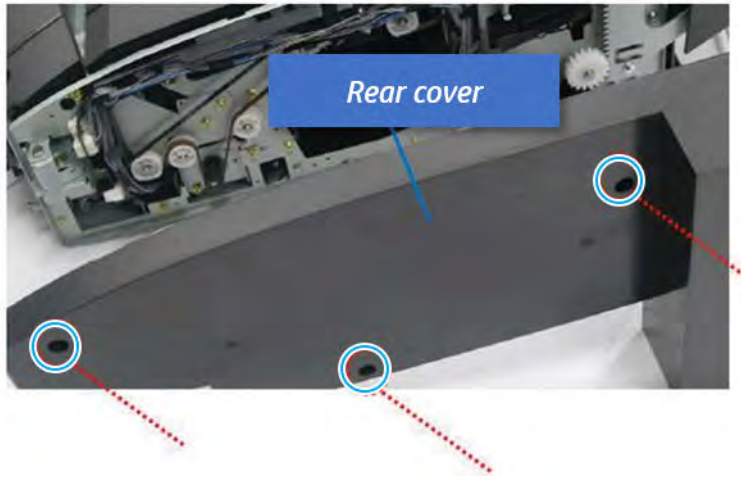
Figure 6-294 Open the top cover



2. Remove three screws.

3. Release hooks carefully and remove the rear cover.

Figure 6-295 Remove the rear cover

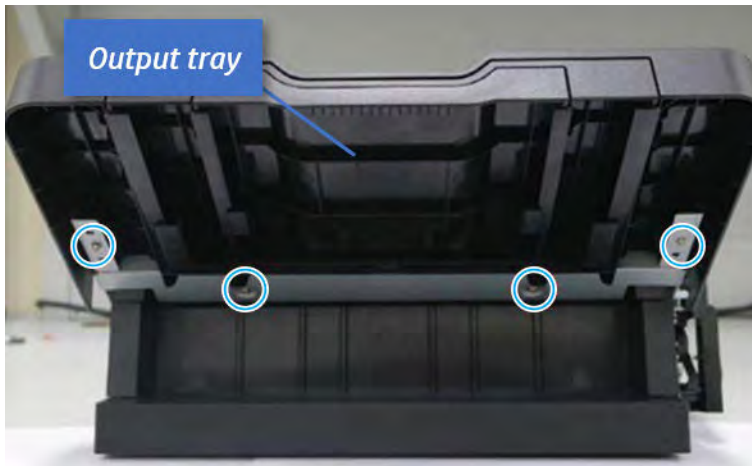


### Remove the output tray

Follow these steps to remove the output tray.

1. Remove four screws.

Figure 6-296 Remove four screws





2. Push the paper holding actuator into the inner finisher, and then remove the output tray.

Figure 6-297 Remove the output tray.

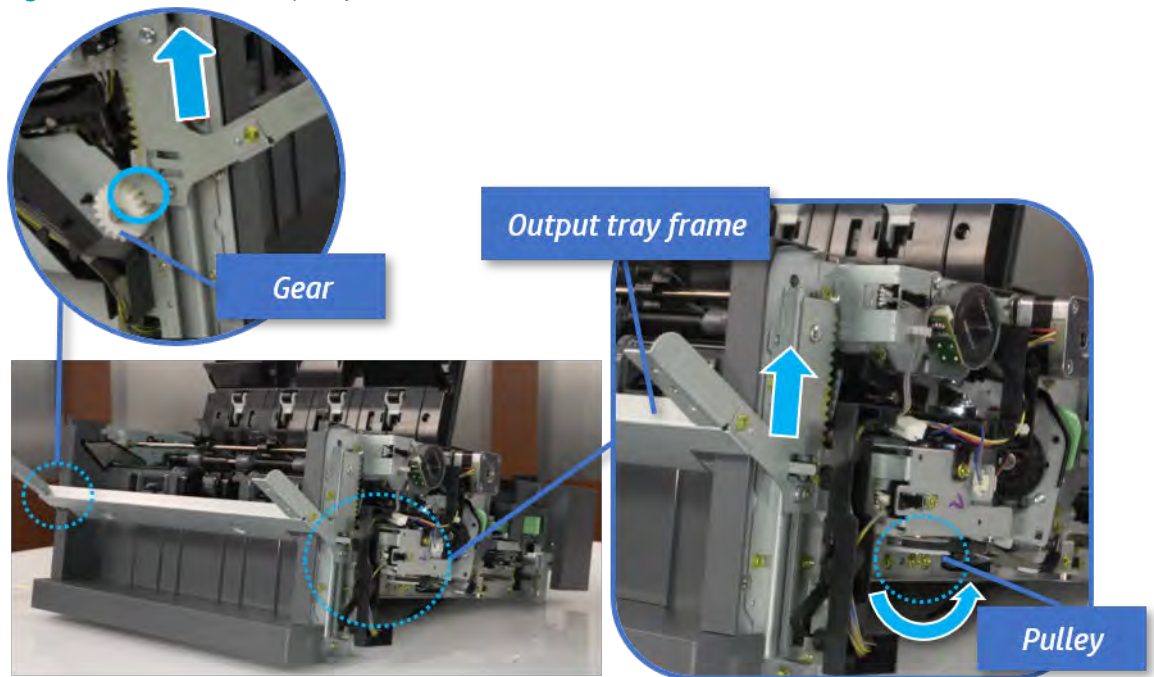


### Remove the output tray frame

Follow these steps to remove the output tray frame.

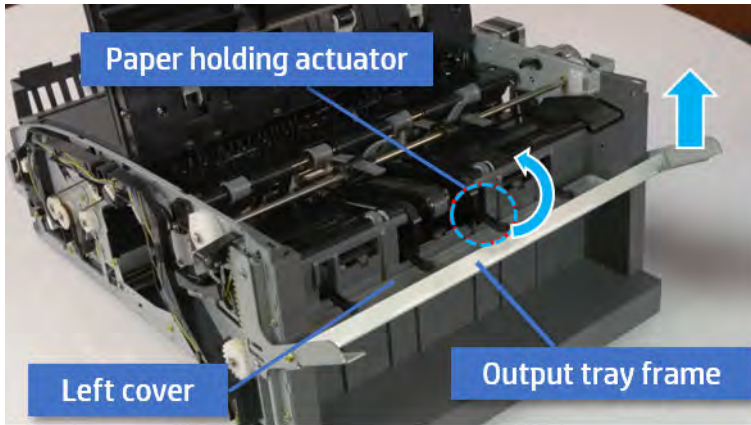
1. Rotate the pulley until the output tray frame depart from the gear.

Figure 6-298 Remove the pulley



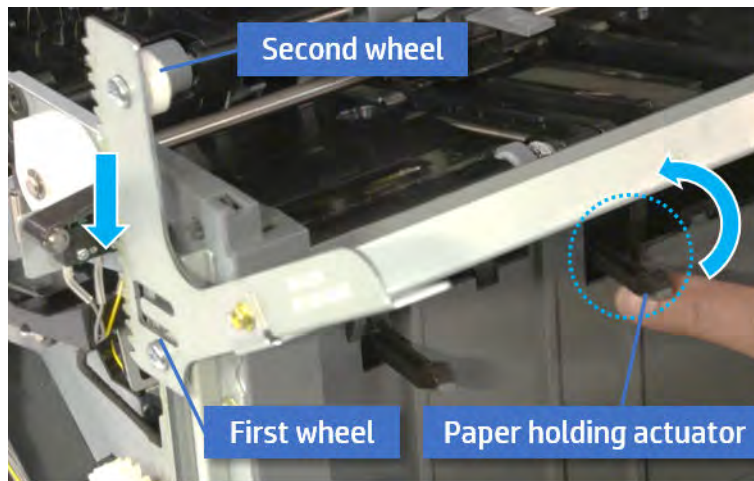
2. Push the paper holding actuator into the inner finisher, and then remove the output tray frame.

Figure 6-299 Remove the output tray frame

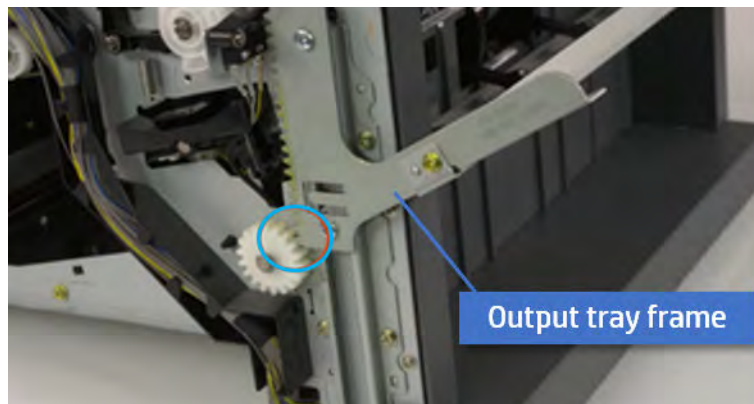


**TIP:** Push the paper holding actuator into the inner finisher when reassembling. Be sure to level the output tray.

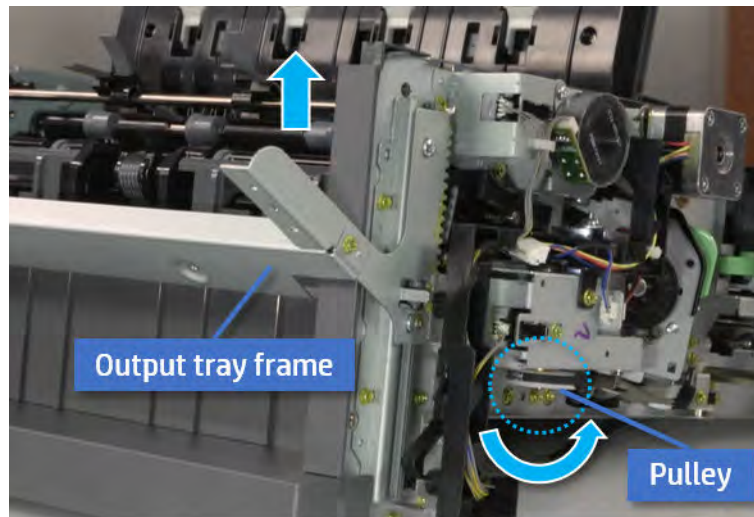
- a. Position the first wheel into the channel on both sides while pushing the paper holding actuator.



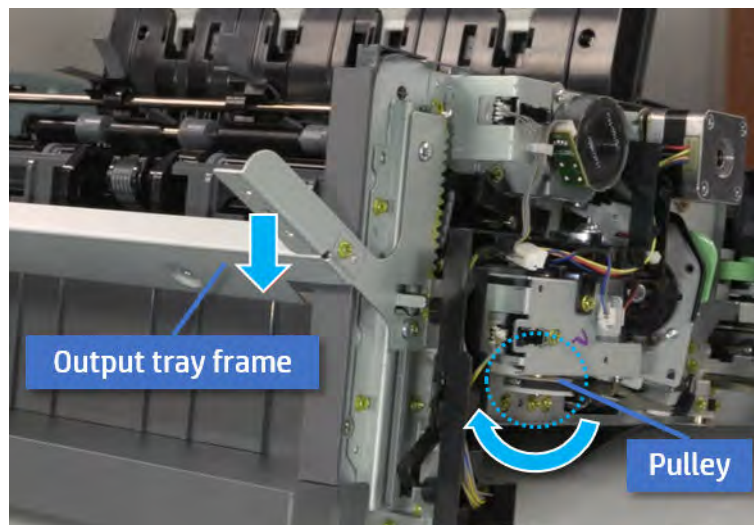
- b. Let the second wheel rest on the channel on both sides simultaneously.
- c. Gently squeeze the wheels into channel until the output tray frame meet the gear.



- d. Rotate the pulley until the output tray frame is no longer lifted. It can make to level the output tray frame.



- e. Rotate the pulley in the opposite direction.

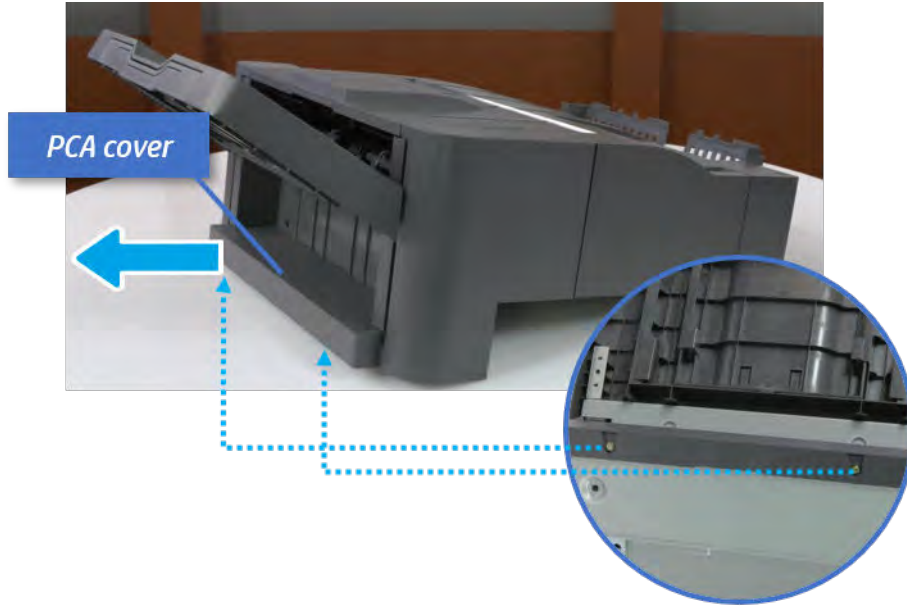


### Remove the PCA cover

Follow these steps to remove the PCA cover.

- ▲ Remove two screws, and then remove the PCA cover.

Figure 6-300 Remove the PCA cover

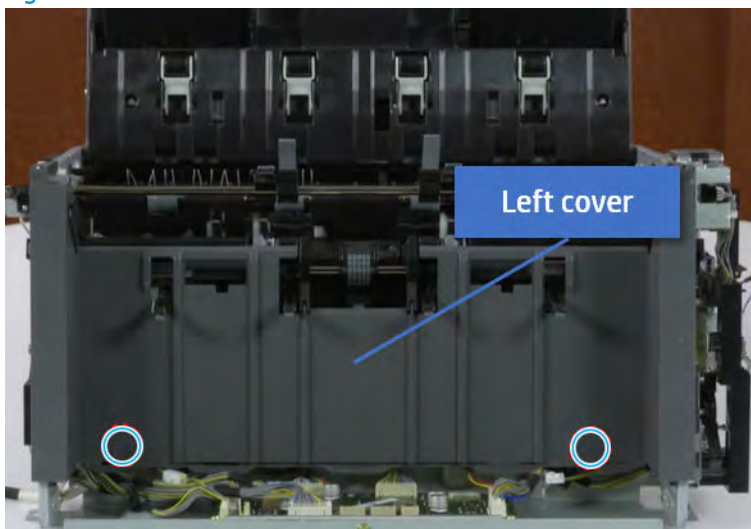


### Remove the left cover

Follow these steps to remove the left cover.

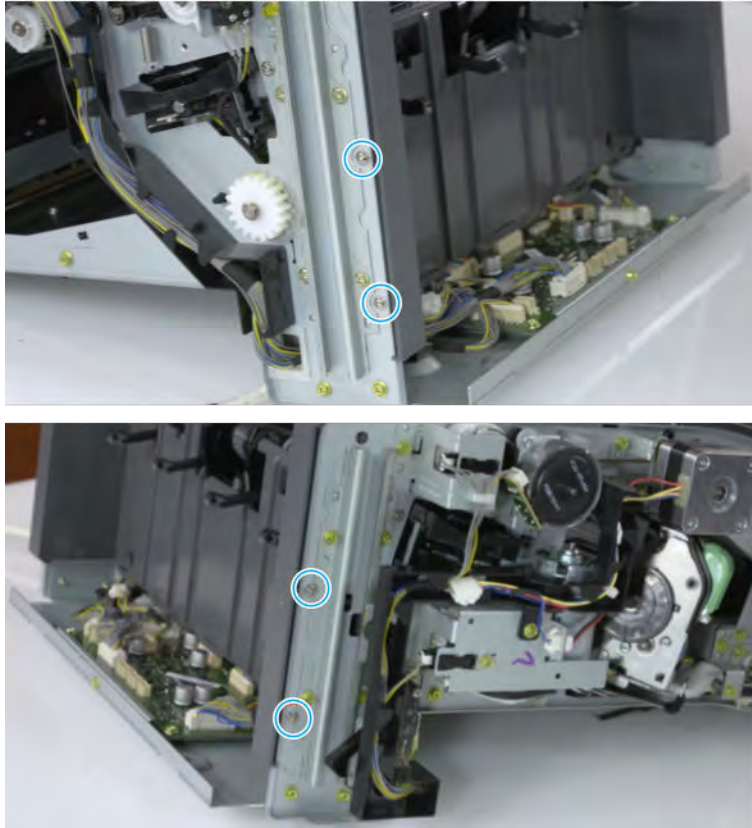
1. Remove two screws.

Figure 6-301 Remove two screws



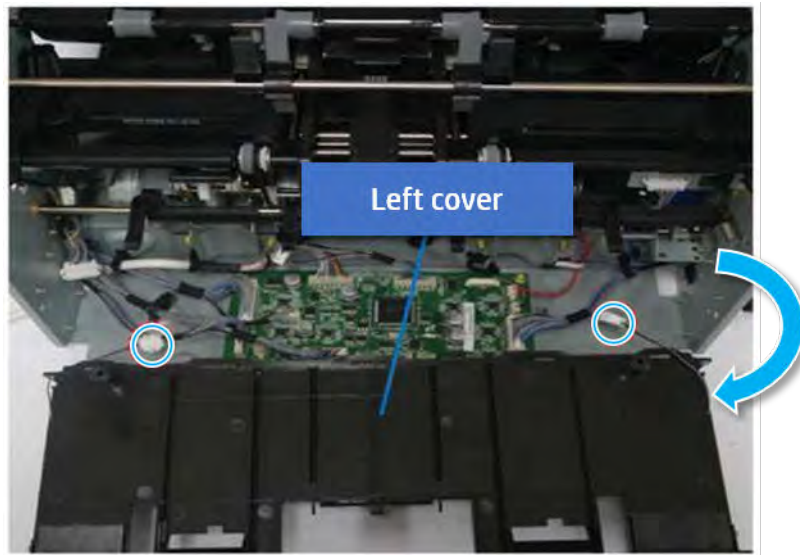
2. Remove four screws from both front and rear sides.


Figure 6-302 Remove four screws

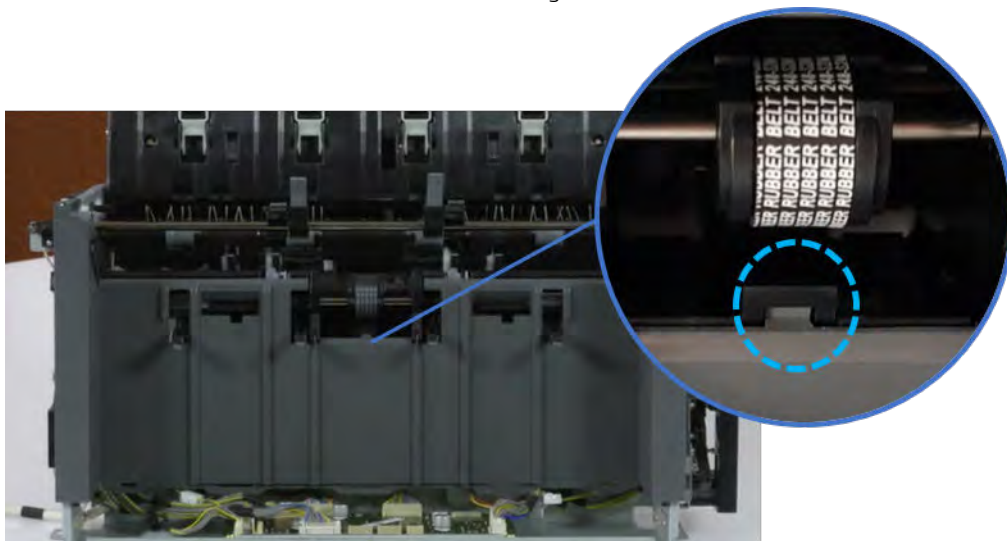


3. Unplug two inline connectors, and then remove the left cover.

**Figure 6-303** Unplug two connectors



 **TIP:** Be sure to check the hook when reassembling.



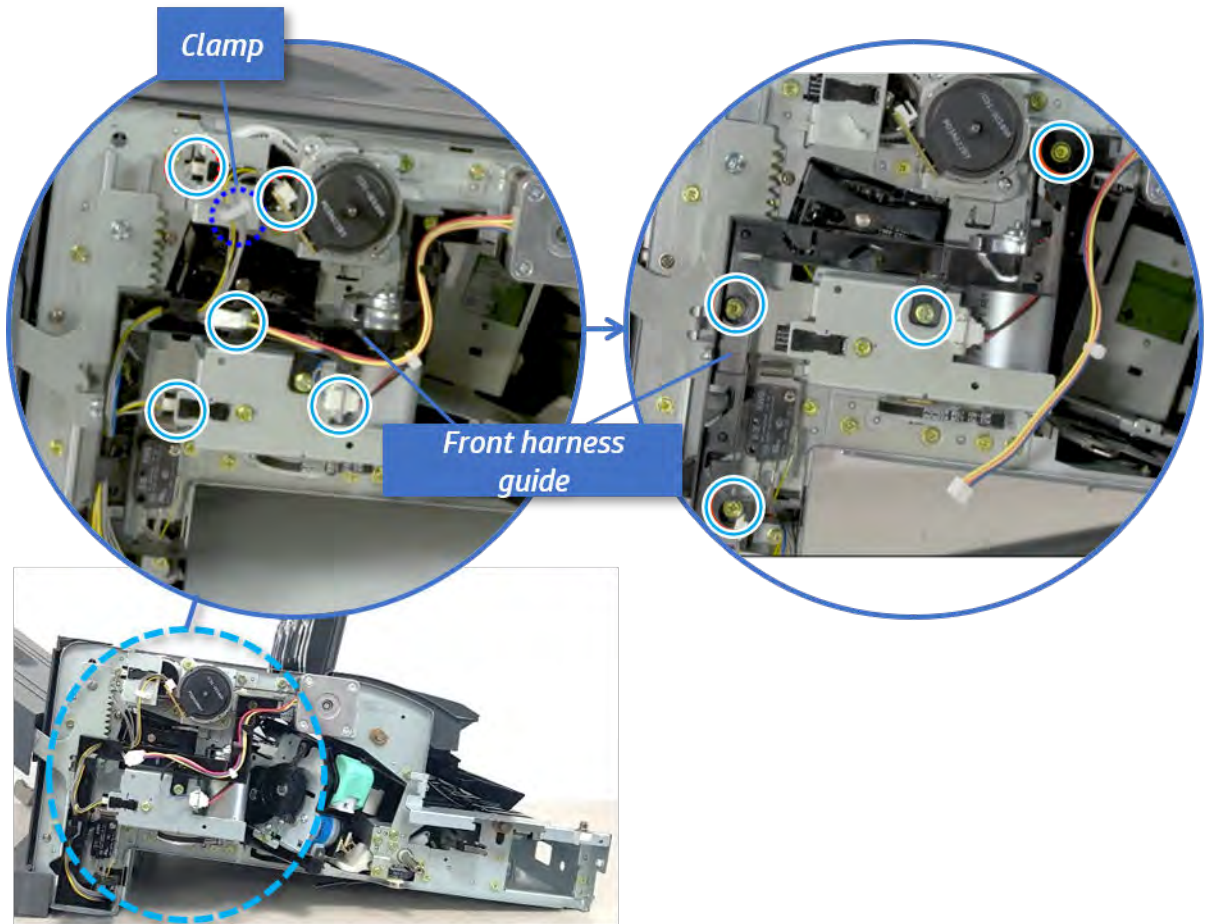
### Remove the front harness guide

Follow these steps to remove the front harness guide.

1. Open one clamp and unplug five connectors, and then remove the wire harness from the front harness guide.

2. Remove four screws, and then remove the front harness guide.

Figure 6-304 Remove the front harness guide

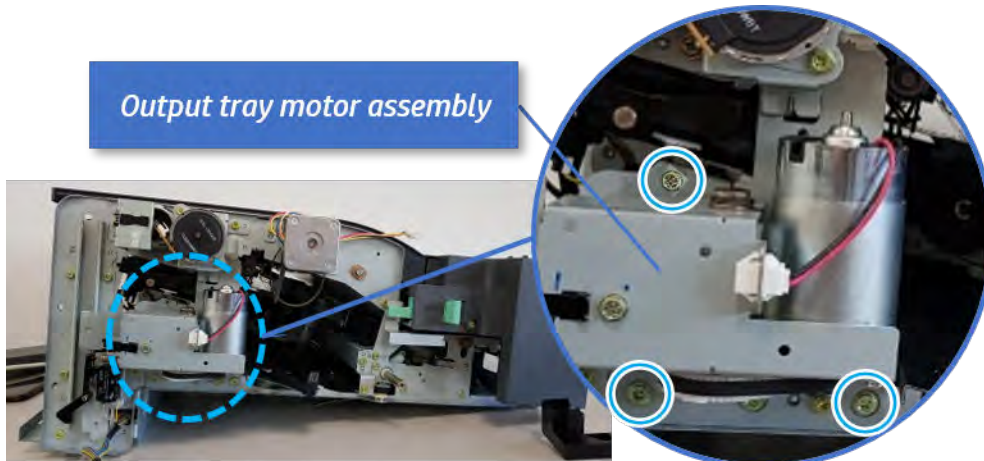


### Remove the output tray motor assembly

Follow these steps to remove the output tray motor assembly.

- ▲ Remove three screws, and then remove the output tray motor assembly.

Figure 6-305 Remove the output tray motor assembly

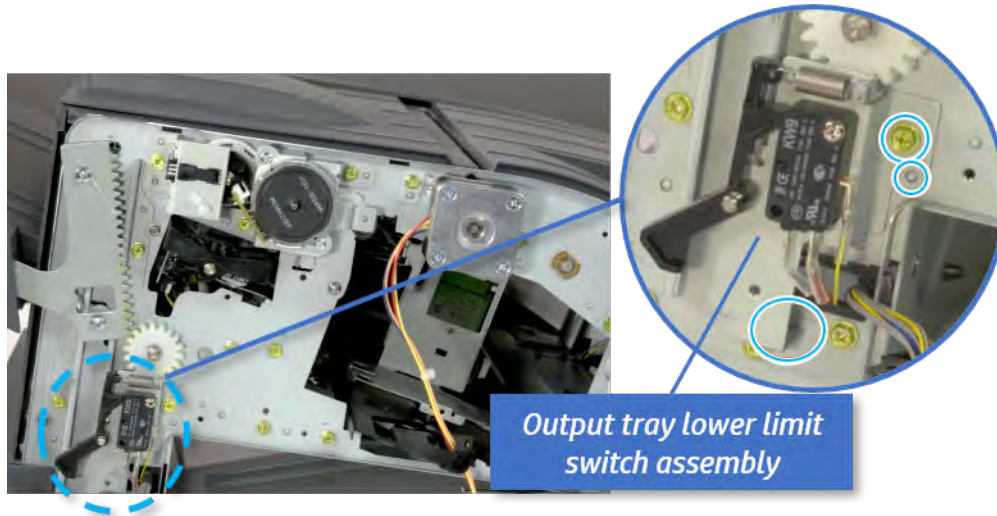


## Remove the output tray lower limit switch

Follow these steps to remove the output tray lower limit switch.

- ▲ Remove one screw, and then remove the output tray lower limit switch.

**Figure 6-306** Remove the output tray lower limit switch

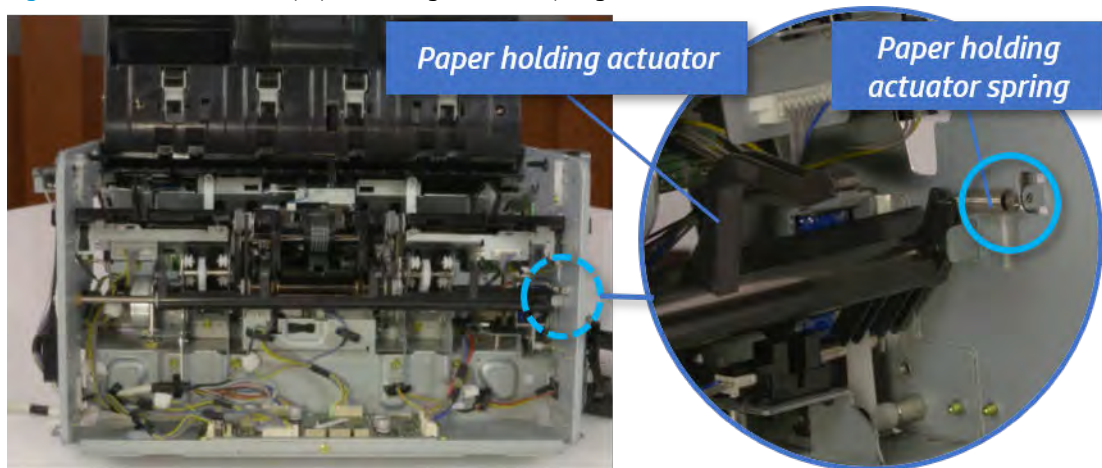


## Remove the paper holding

Follow these steps to remove the paper holding.

1. Remove the paper holding actuator spring.

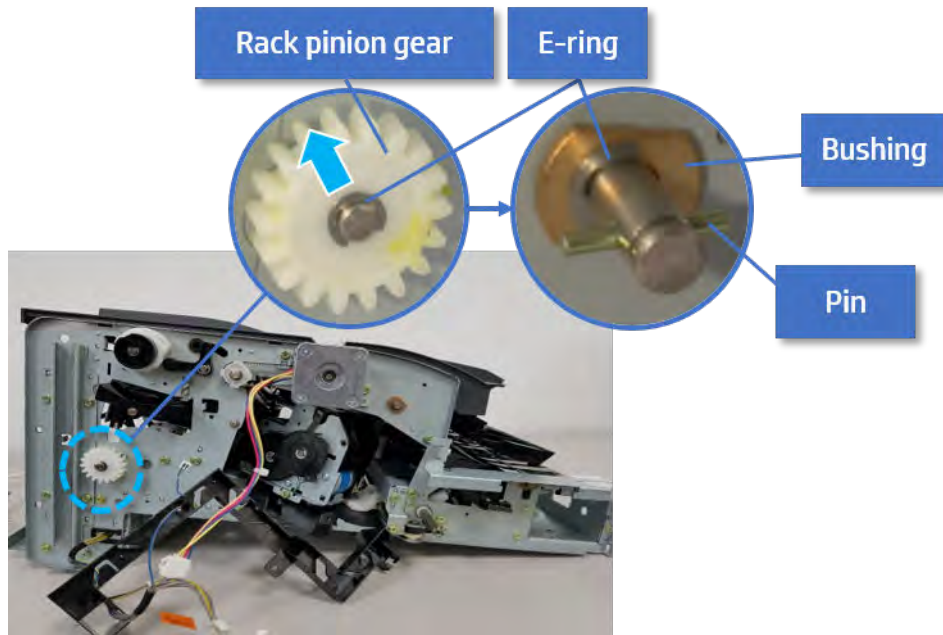
**Figure 6-307** Remove the paper holding actuator spring






2. Remove the e-ring and the rack pinion gear. And then remove the pin and the e-ring, and then remove the bushing.

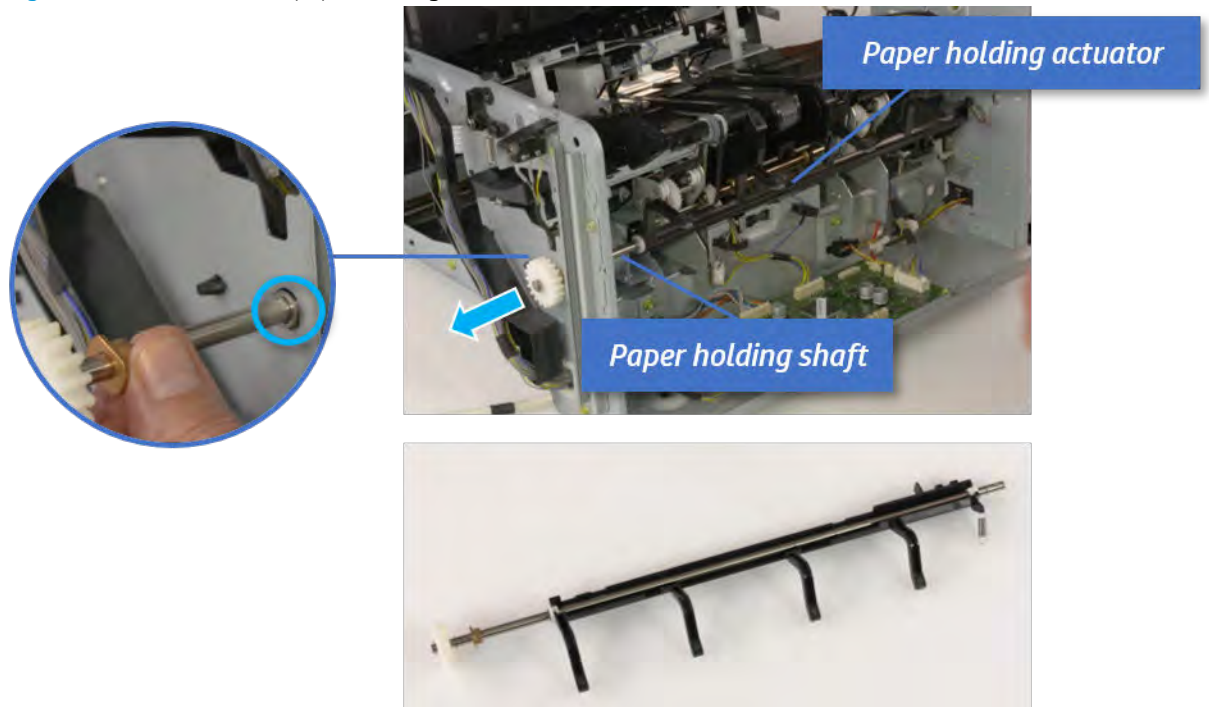
**Figure 6-308** Remove e-ring, rack pinion gear, pin, and bushing



 **NOTE:** Be sure not to lose the pin.

3. Carefully remove the paper holding shaft and the actuator.

**Figure 6-309** Remove the paper holding shaft and the actuator

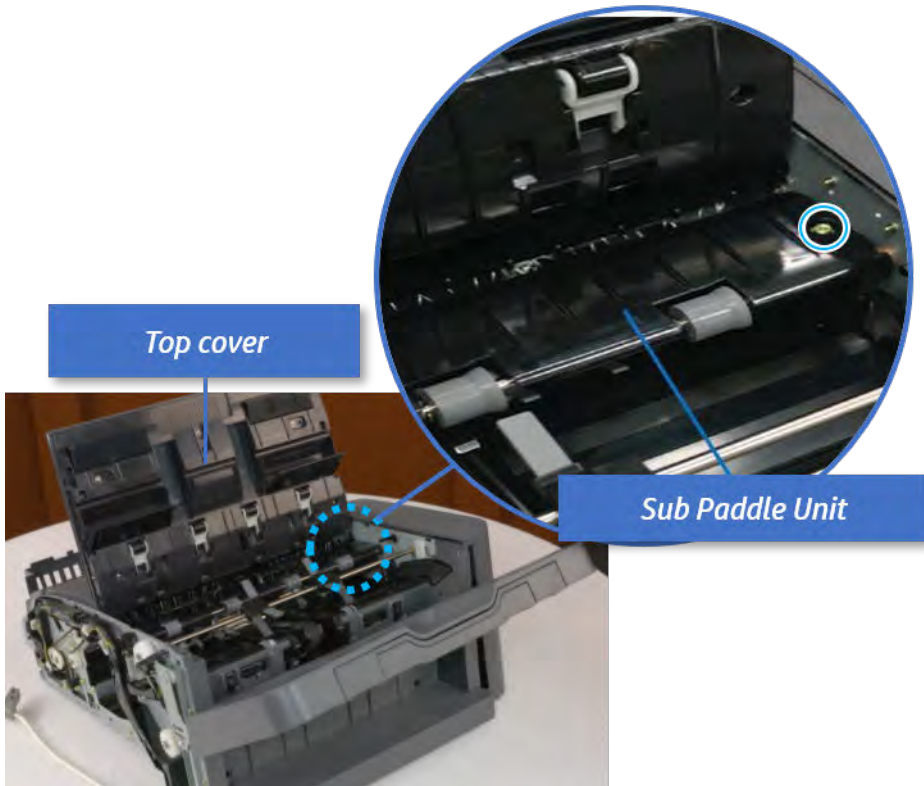


### Remove the sub paddle unit

Follow these steps to remove the sub paddle unit.

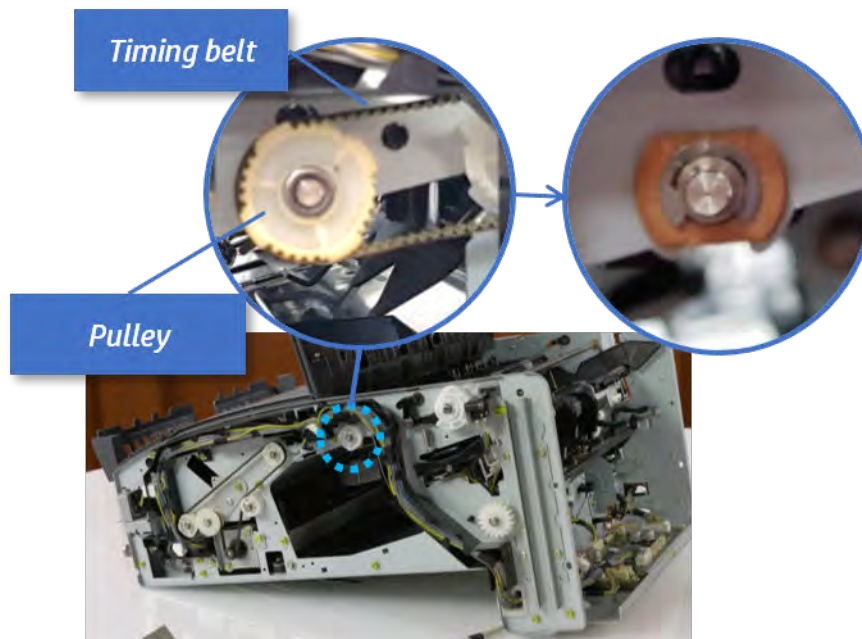
1. Open the top cover, and then remove one screw securing the sub paddle unit.

Figure 6-310 Remove one screw



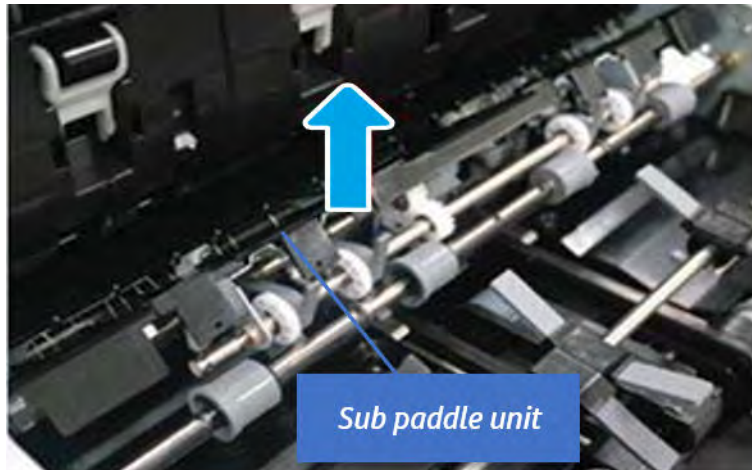
2. Remove the e-ring, and then remove the pulley and timing belt. And then remove the e-ring and the bushing.

Figure 6-311 Remove the e-ring, pulley, timing belt, and bushing



3. Lift up and remove the sub paddle unit.

Figure 6-312 Remove the sub paddle unit

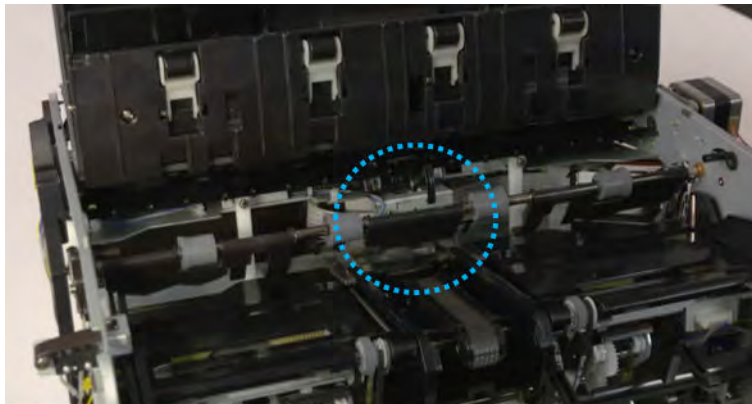


### Remove the exit roller

Follow these steps to remove the exit roller.

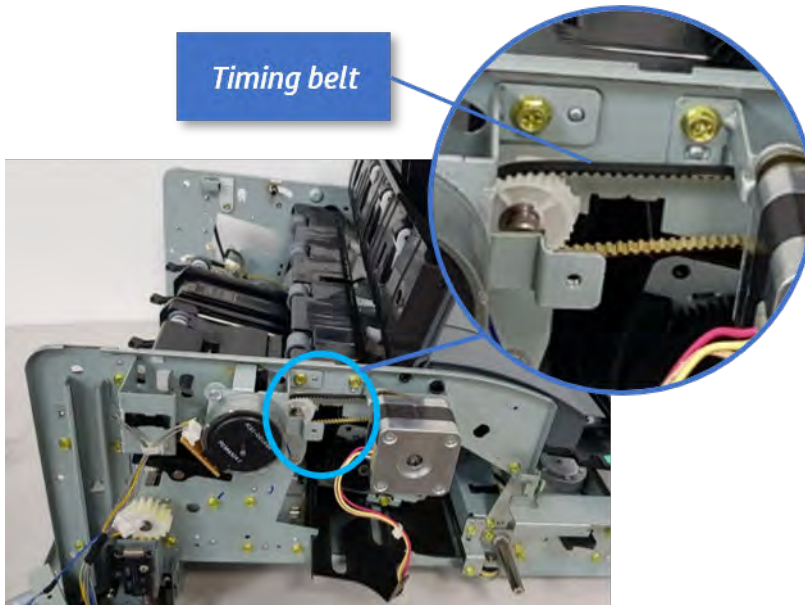
1. Remove the guide on the center of the exit roller.

Figure 6-313 Remove the guide



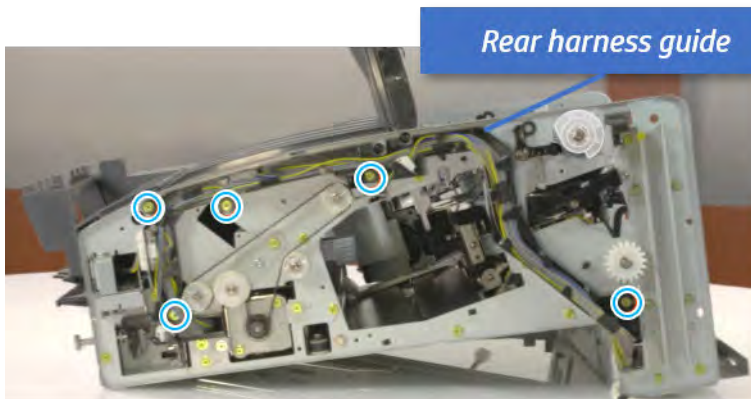
2. On the front of the inner finisher, release the timing belt connected to the exit motor.

Figure 6-314 Release the timing belt



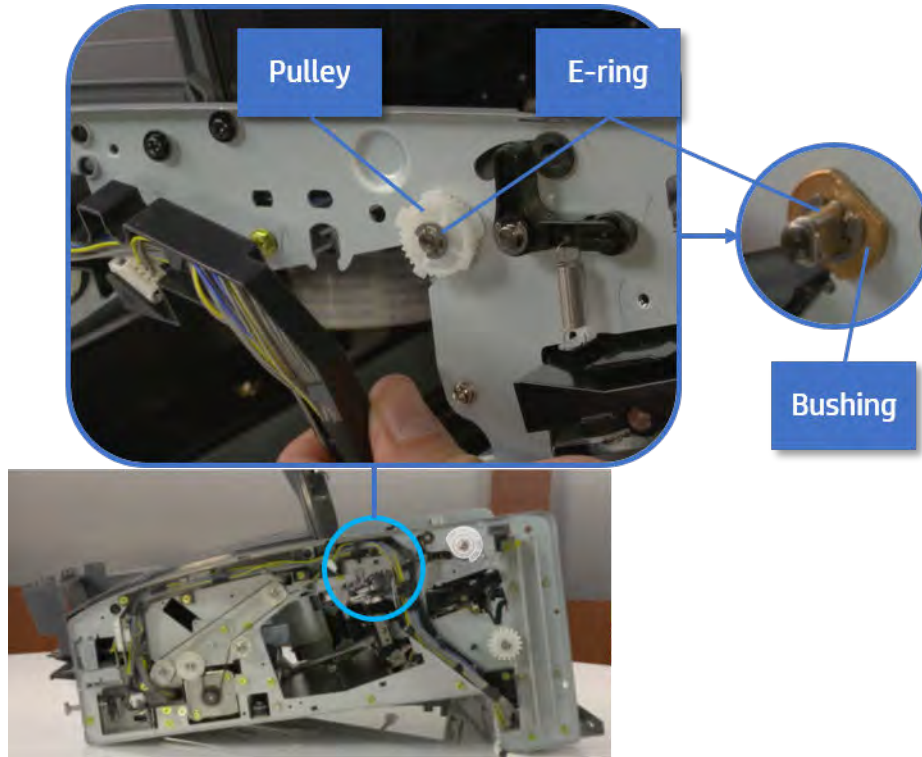
3. Remove five screws securing the rear harness guide.

Figure 6-315 Remove five screws



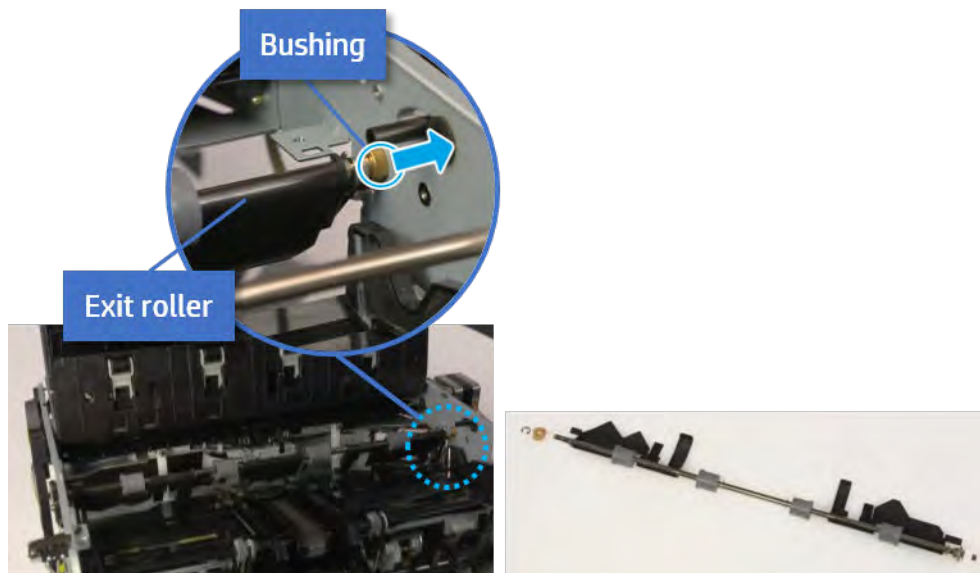
4. On the rear of the inner finisher, remove the e-ring and the pulley and then remove the e-ring and the bushing.

Figure 6-316 Remove e-ring, pulley, and bushing



5. Push the bushing to detach it, and then remove the exit roller.

Figure 6-317 Remove the exit roller

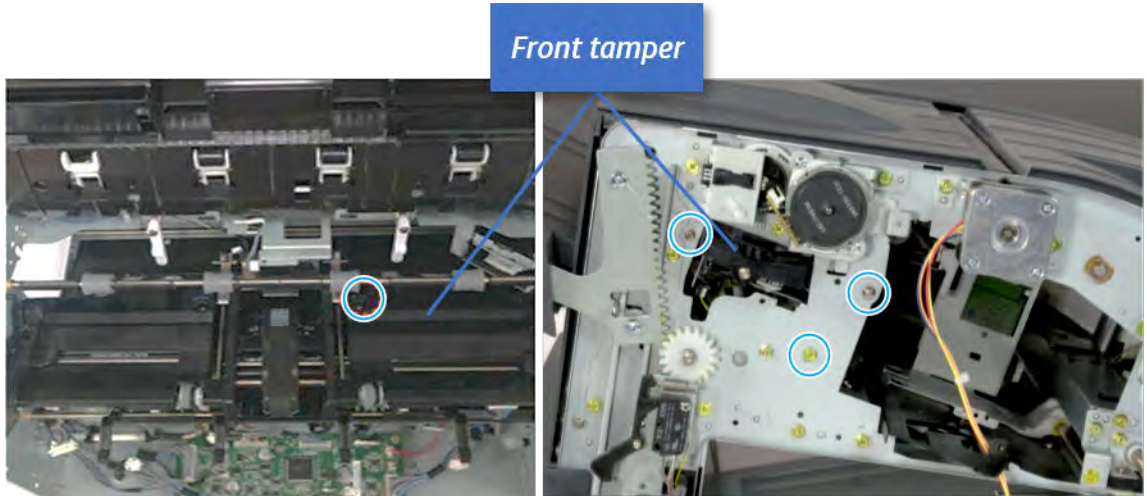


### Remove the front tamper

Follow these steps to remove the front tamper.

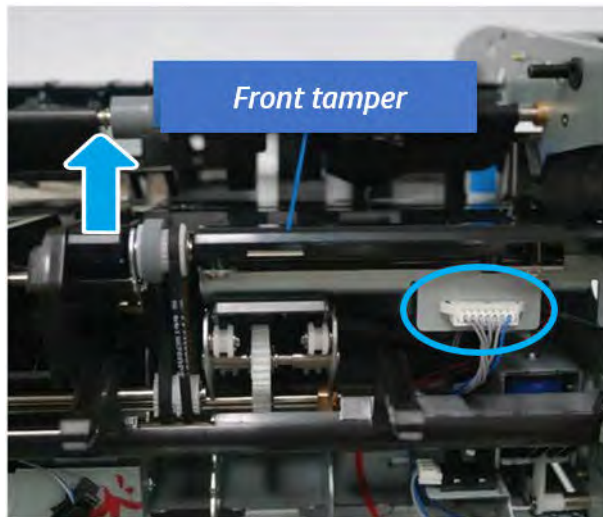
1. Remove four screws.

Figure 6-318 Remove four screws



2. Unplug the connector and release the hook, and then pull the front tamper up to remove.

Figure 6-319 Remove the front tamper



### Unpack the replacement assembly

Follow these steps to unpack the replacement assembly.

1. Dispose of the defective part.



---


 **NOTE:** HP recommends responsible disposal of the defective part.


<http://www8.hp.com/us/en/hp-information/environment/product-recycling.html>

---

2. Unpack the replacement part from the packaging.


 **CAUTION:**  Some parts are sensitive to electrostatic discharge (ESD). Always perform service work at an ESD-protected workstation or mat. If an ESD workstation or mat is not available, touch the sheet-metal chassis to provide a static ground before touching an ESD-sensitive assembly. Protect the ESD-sensitive assemblies by placing them in ESD pouches when they are out of the printer.

 **IMPORTANT:** Make sure that all of the shipping materials (for example shipping tape) are removed from the replacement part prior to installation.

 **NOTE:** If the replacement part is a roller or pad, avoid touching the spongy part of it. Skin oils on the roller or pad can cause paper pickup and/or print-quality problems. HP recommends using disposable gloves when handling rollers or pads or washing your hands before touching rollers or pads.

---

3. To install an assembly, reverse the removal steps.

 **NOTE:** When applicable, special installation instructions are provided for an assembly at the end of the removal procedure. Always completely read the removal instructions and follow all special installation instructions.

---

## Removal and replacement: Front tamper home sensor (S5)


Learn how to remove and replace the front tamper home sensor.

To view teardown and reassembling video of the inner finisher, click the link below.

 [View a teardown video of the inner finisher.](#)

 [View a reassembling video of the inner finisher.](#)

---

 **IMPORTANT:** When applicable, special installation instructions are provided for an assembly at the end of the removal procedure. Always completely read the removal instructions and follow all special installation instructions.

---

Mean time to repair:


Service level:

### Before performing service

#### Turn the printer power off

- Press the power button on the front of the printer, and then turn off the power switch next to the power cable.
- A shutting-down message appears on the control-panel display.

---

 **WARNING!** To avoid damage to the printer, turn the power off and wait until the printer shuts down before removing the power cable.

---

- Disconnect the printer power cable after the printer has completely shut down (the control-panel display is blank).

Use the table below to identify the correct part number for your printer. To order the part, go to [www.hp.com/buy/parts](http://www.hp.com/buy/parts).

**Table 6-54** Part information

Part number	Part description
0604-001393	Front tamper home sensor

### Required tools

- #2 JIS screwdriver with a magnetic tip

### After performing service

#### Turn the printer power on

- Connect the power cable.
- Use the power switch to turn the power on.

### Post service test

Print any pages necessary to verify that the repair resolved the issue and did not create any new issues.

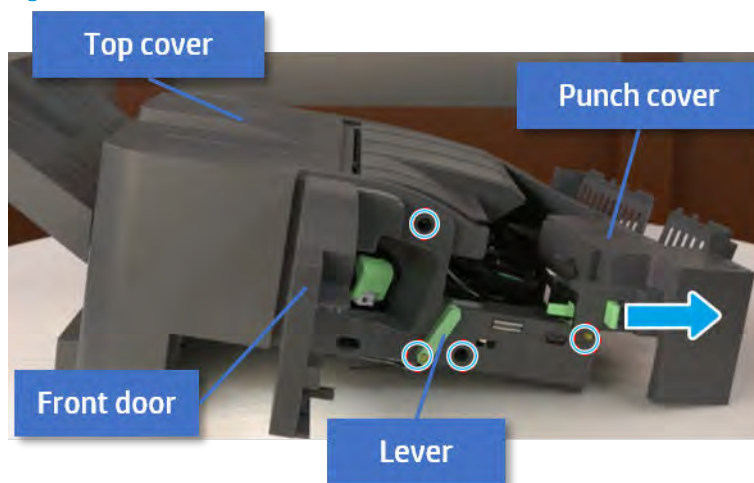


## Remove the front cover

Follow these steps to remove the front cover:

1. Open the front door and open the punch cover.
2. Remove three screws in the front.
3. Remove the lever.
4. Open the top cover.
5. From the right side of the front cover, carefully lift and pry toward the top-left corner to remove the front cover.

Figure 6-320 Remove the front cover

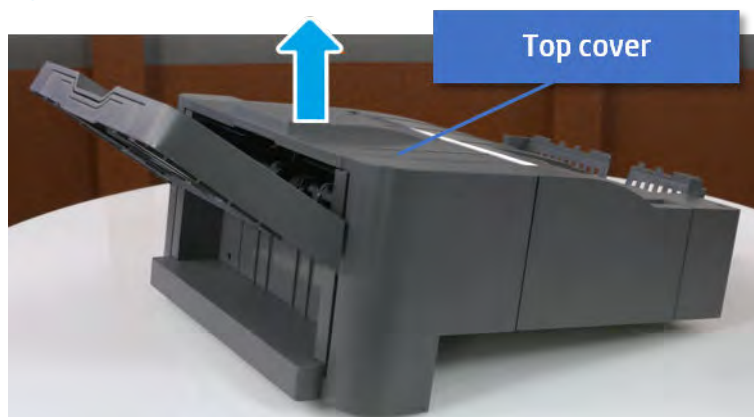


## Remove the rear cover

Follow these steps to remove the rear cover:

1. Open the top cover.

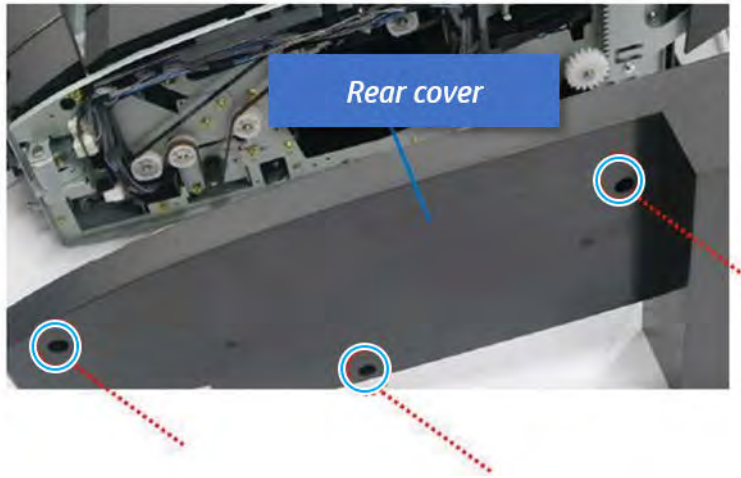
Figure 6-321 Open the top cover



2. Remove three screws.

3. Release hooks carefully and remove the rear cover.

Figure 6-322 Remove the rear cover

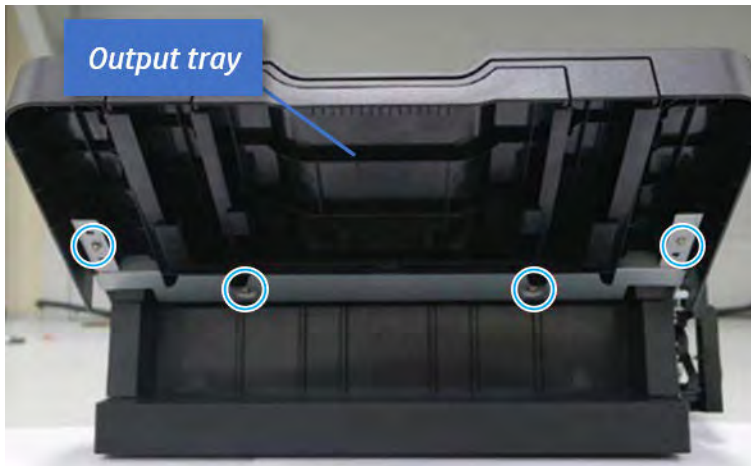


### Remove the output tray

Follow these steps to remove the output tray.

1. Remove four screws.

Figure 6-323 Remove four screws



2. Push the paper holding actuator into the inner finisher, and then remove the output tray.

Figure 6-324 Remove the output tray.

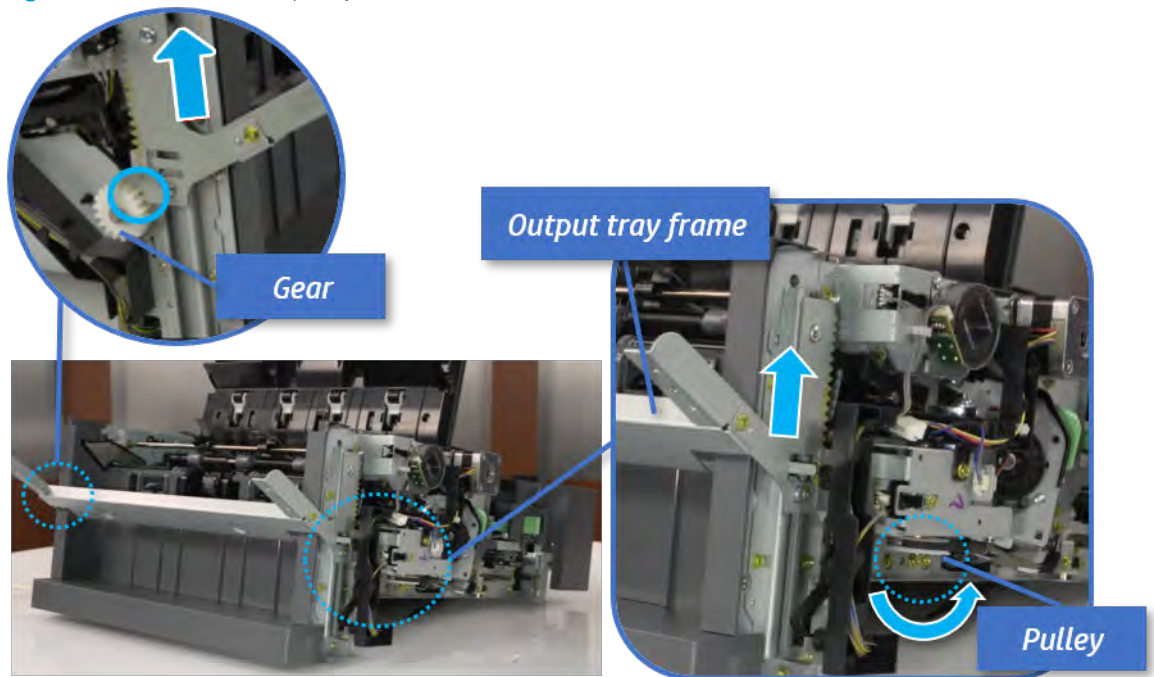


### Remove the output tray frame

Follow these steps to remove the output tray frame.

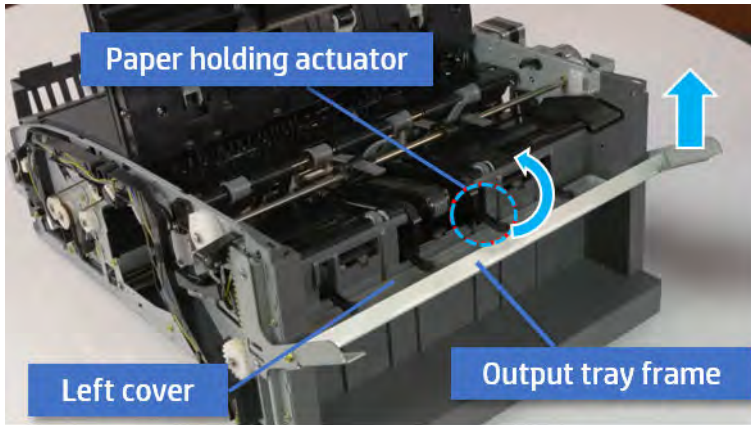
1. Rotate the pulley until the output tray frame depart from the gear.

Figure 6-325 Remove the pulley



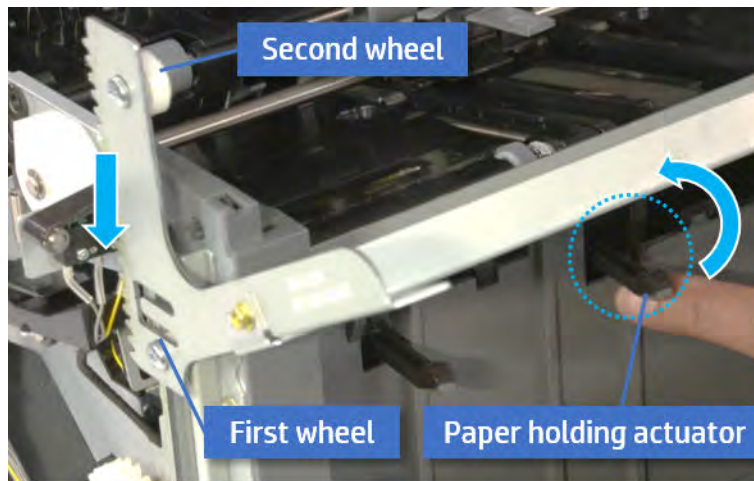
2. Push the paper holding actuator into the inner finisher, and then remove the output tray frame.

Figure 6-326 Remove the output tray frame

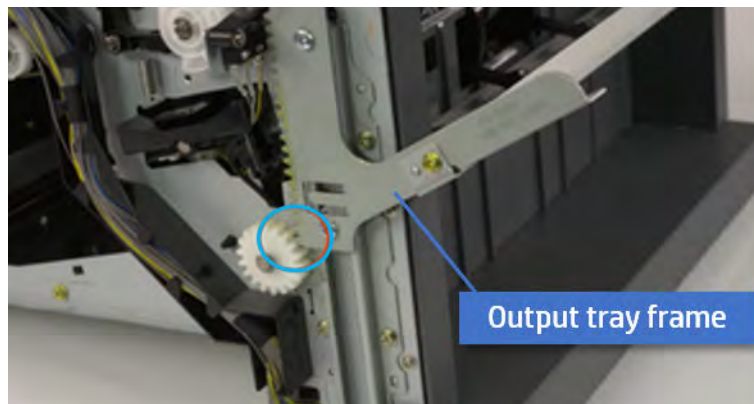


**TIP:** Push the paper holding actuator into the inner finisher when reassembling. Be sure to level the output tray.

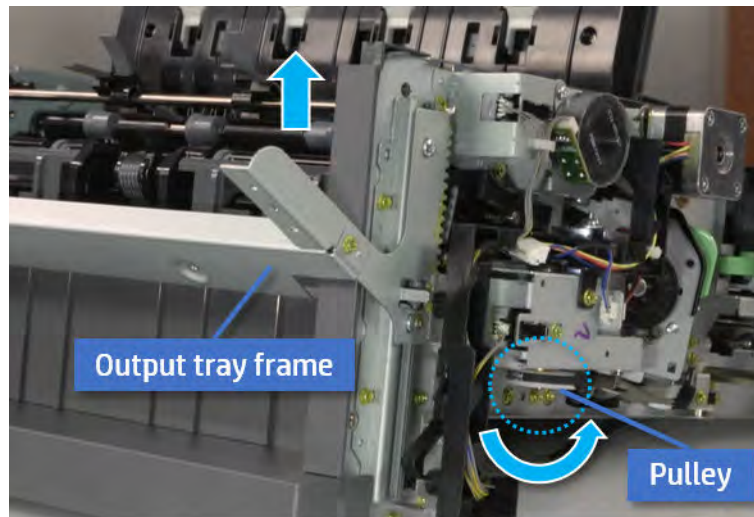
- a. Position the first wheel into the channel on both sides while pushing the paper holding actuator.



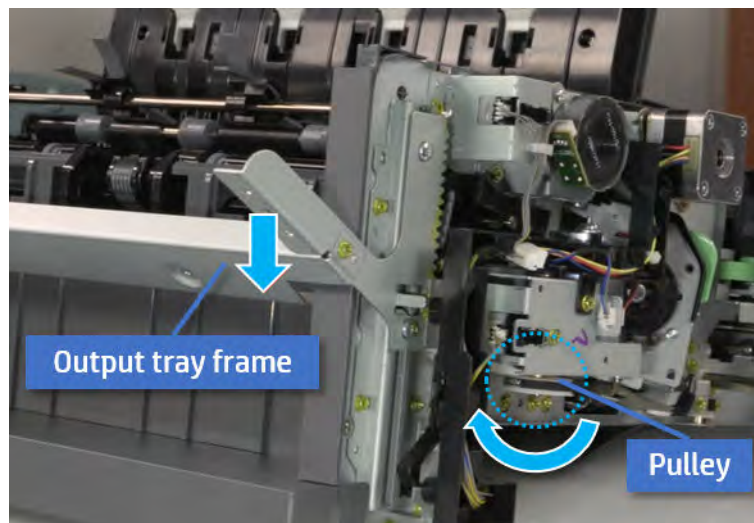
- b. Let the second wheel rest on the channel on both sides simultaneously.
- c. Gently squeeze the wheels into channel until the output tray frame meet the gear.



- d. Rotate the pulley until the output tray frame is no longer lifted. It can make to level the output tray frame.



- e. Rotate the pulley in the opposite direction.

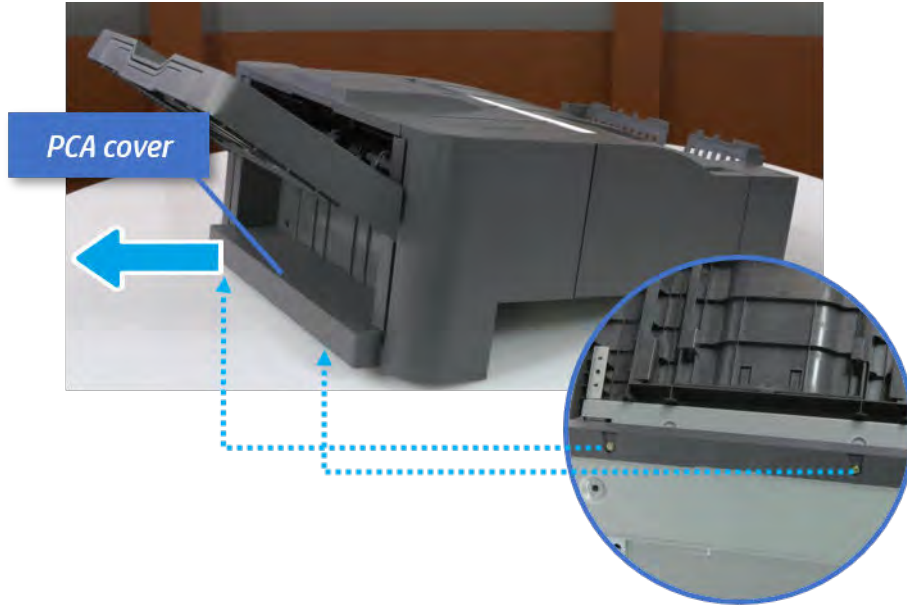


### Remove the PCA cover

Follow these steps to remove the PCA cover.

- ▲ Remove two screws, and then remove the PCA cover.

Figure 6-327 Remove the PCA cover

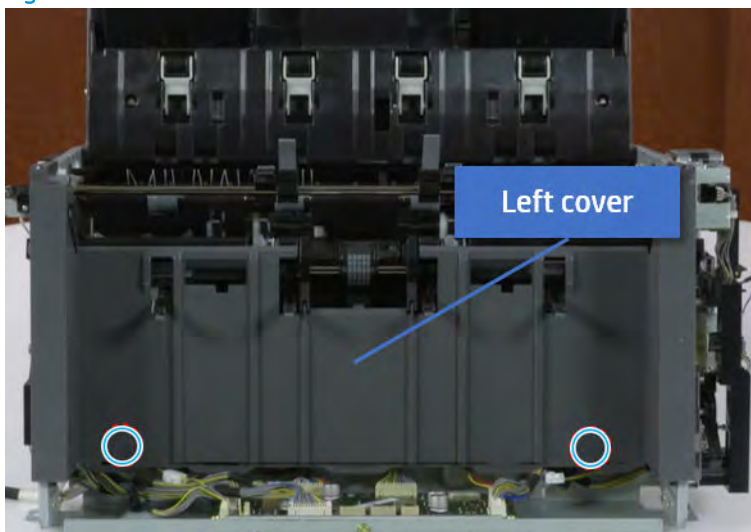


### Remove the left cover

Follow these steps to remove the left cover.

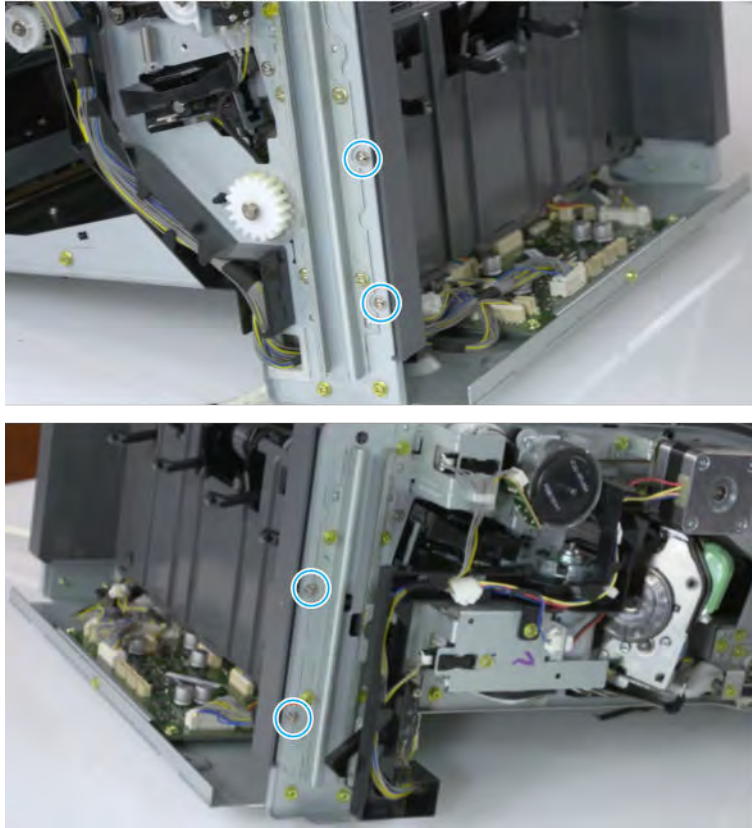
1. Remove two screws.

Figure 6-328 Remove two screws



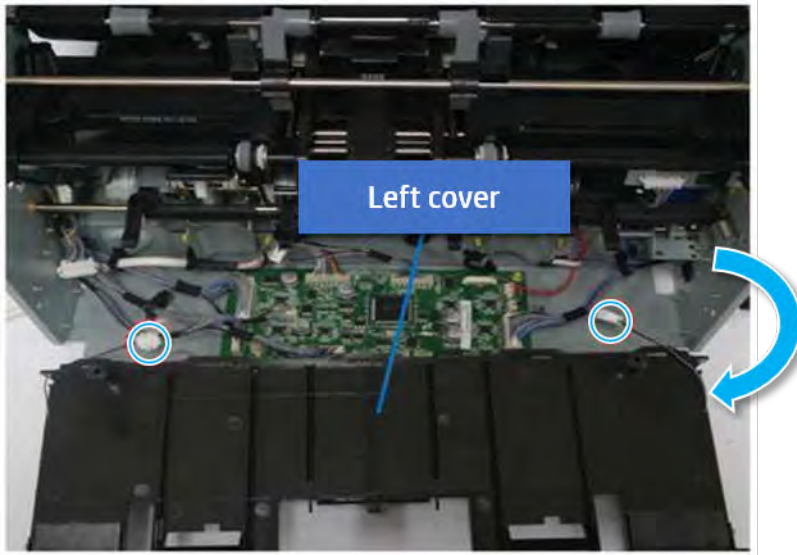
2. Remove four screws from both front and rear sides.


Figure 6-329 Remove four screws

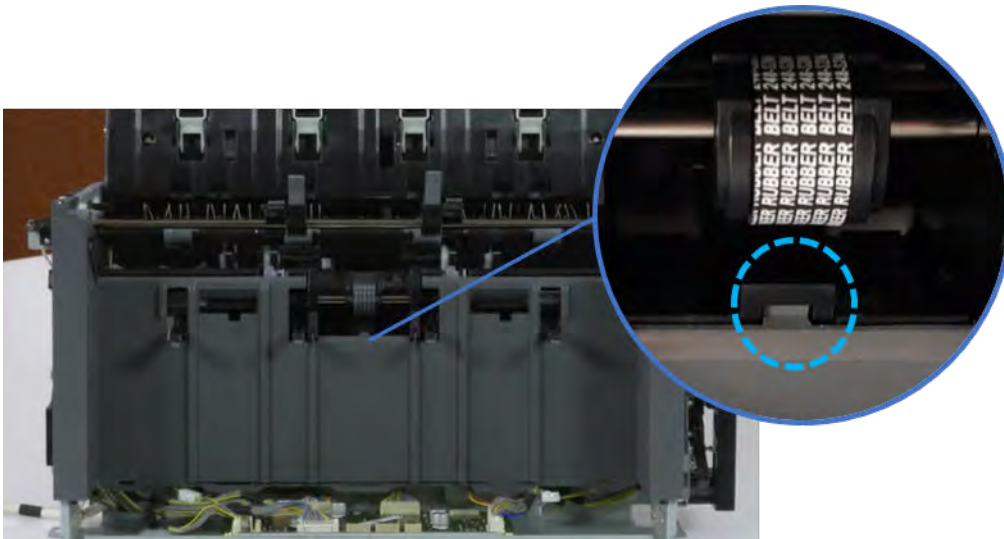


3. Unplug two inline connectors, and then remove the left cover.

Figure 6-330 Unplug two connectors



 **TIP:** Be sure to check the hook when reassembling.



### Remove the front harness guide

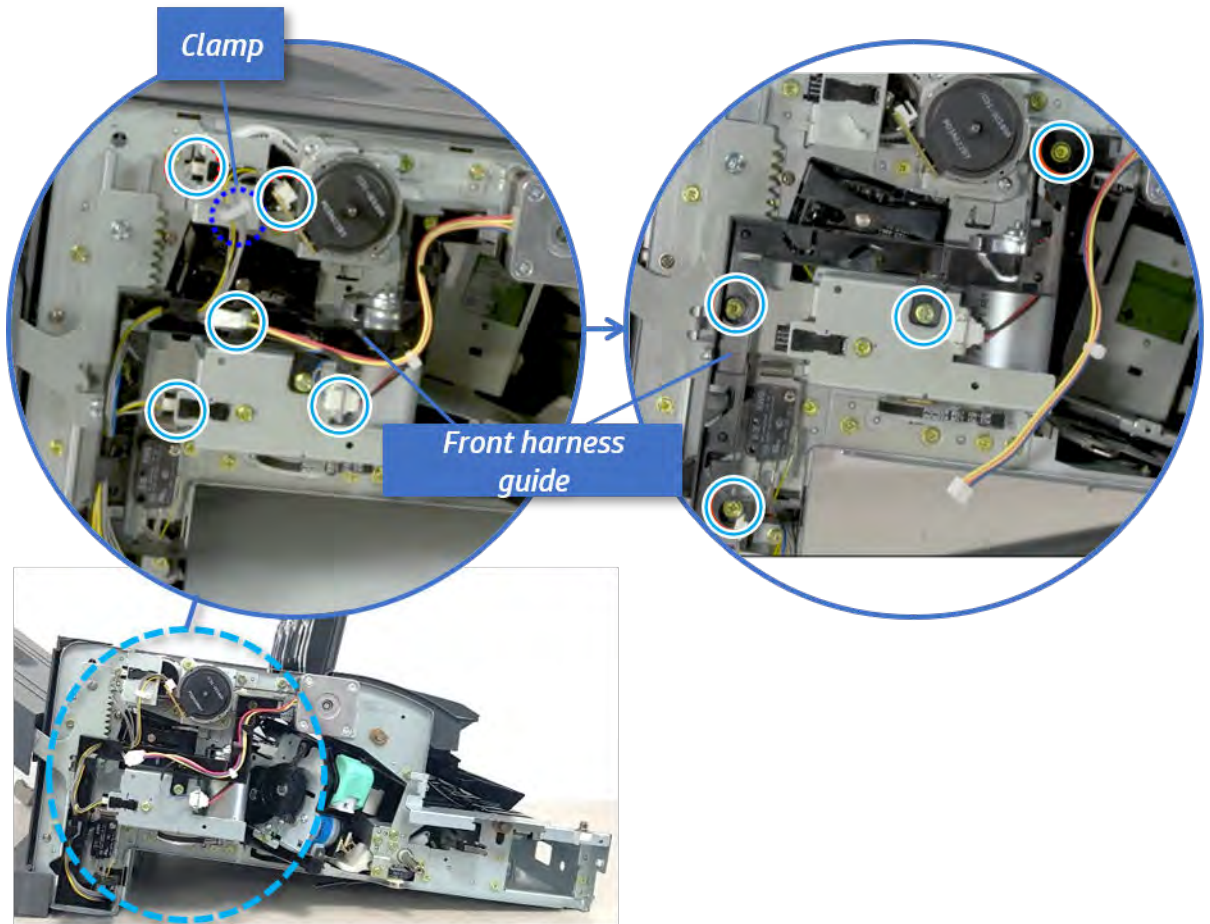
Follow these steps to remove the front harness guide.

1. Open one clamp and unplug five connectors, and then remove the wire harness from the front harness guide.



2. Remove four screws, and then remove the front harness guide.

Figure 6-331 Remove the front harness guide

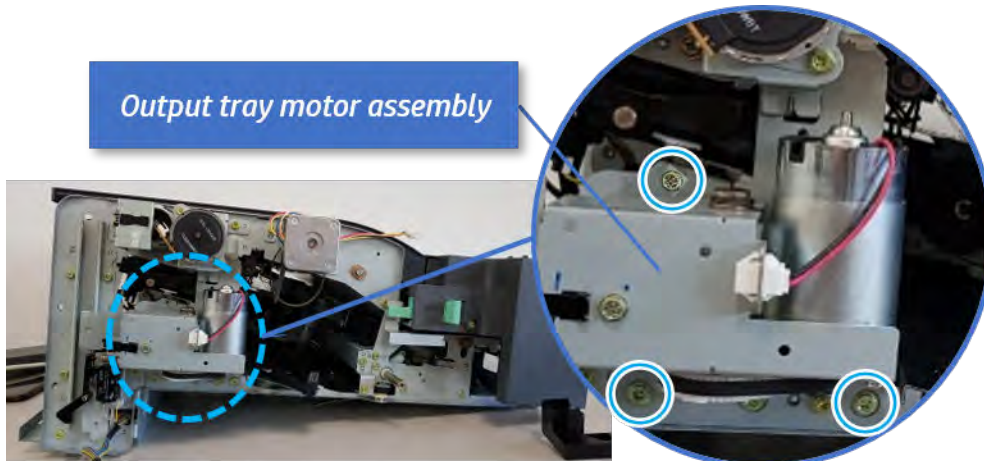


### Remove the output tray motor assembly

Follow these steps to remove the output tray motor assembly.

- ▲ Remove three screws, and then remove the output tray motor assembly.

Figure 6-332 Remove the output tray motor assembly

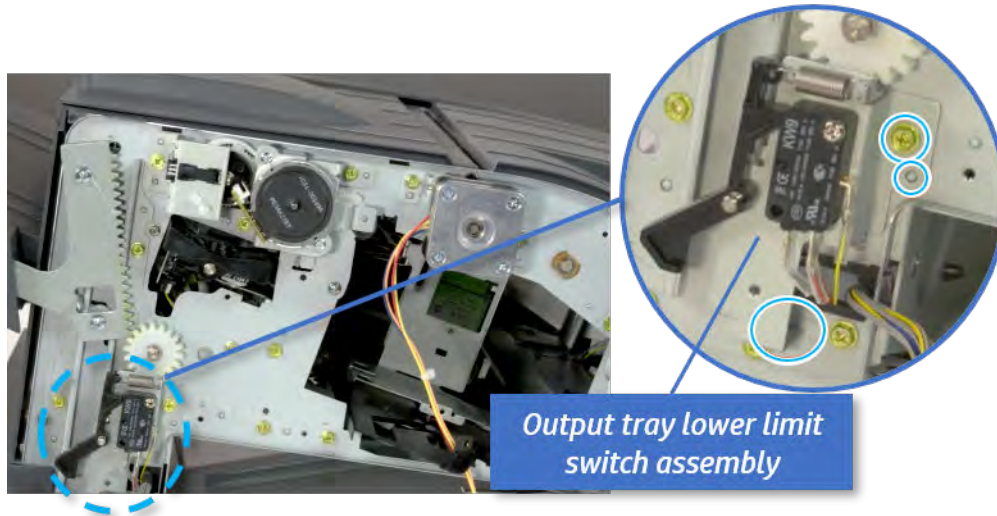


## Remove the output tray lower limit switch

Follow these steps to remove the output tray lower limit switch.

- ▲ Remove one screw, and then remove the output tray lower limit switch.

**Figure 6-333** Remove the output tray lower limit switch

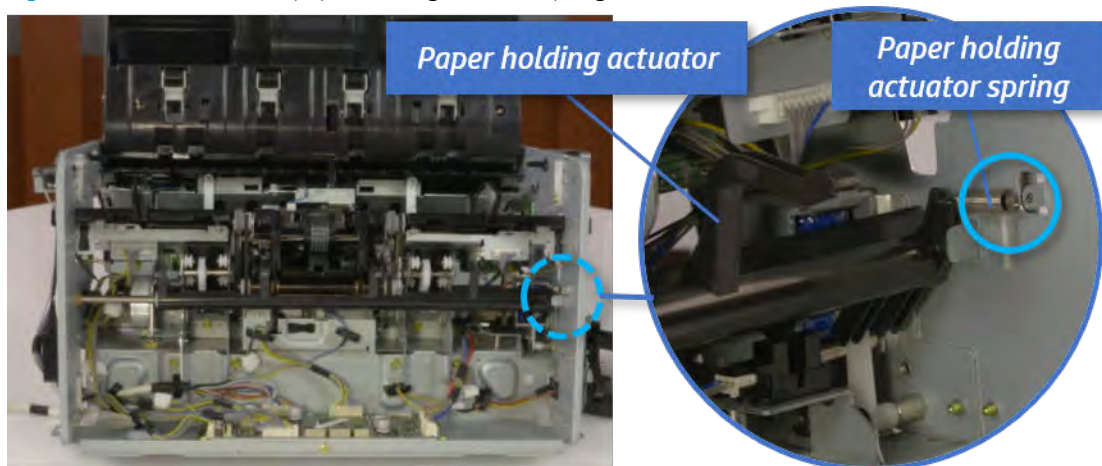


## Remove the paper holding

Follow these steps to remove the paper holding.

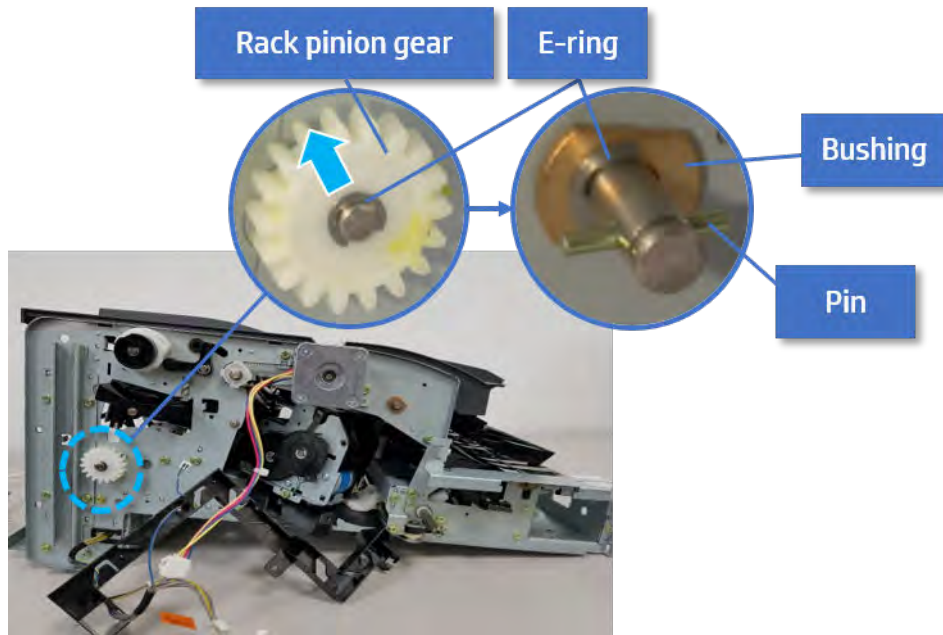
1. Remove the paper holding actuator spring.


**Figure 6-334** Remove the paper holding actuator spring



2. Remove the e-ring and the rack pinion gear. And then remove the pin and the e-ring, and then remove the bushing.

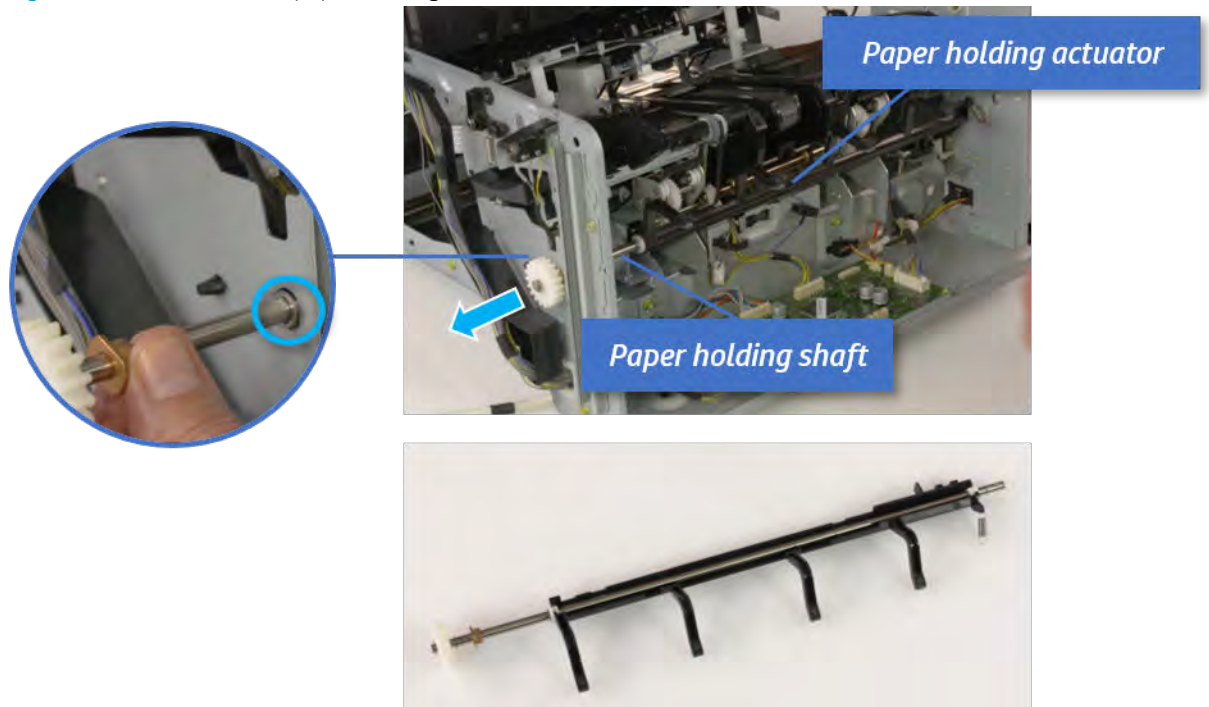
**Figure 6-335** Remove e-ring, rack pinion gear, pin, and bushing



 **NOTE:** Be sure not to lose the pin.

3. Carefully remove the paper holding shaft and the actuator.

**Figure 6-336** Remove the paper holding shaft and the actuator

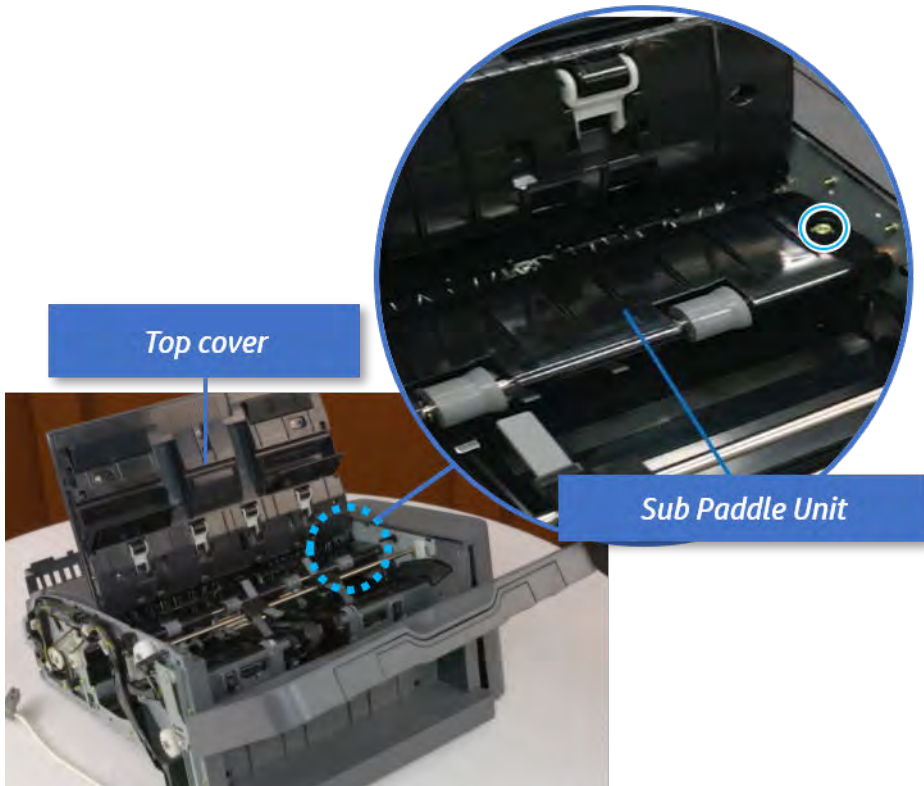


### Remove the sub paddle unit

Follow these steps to remove the sub paddle unit.

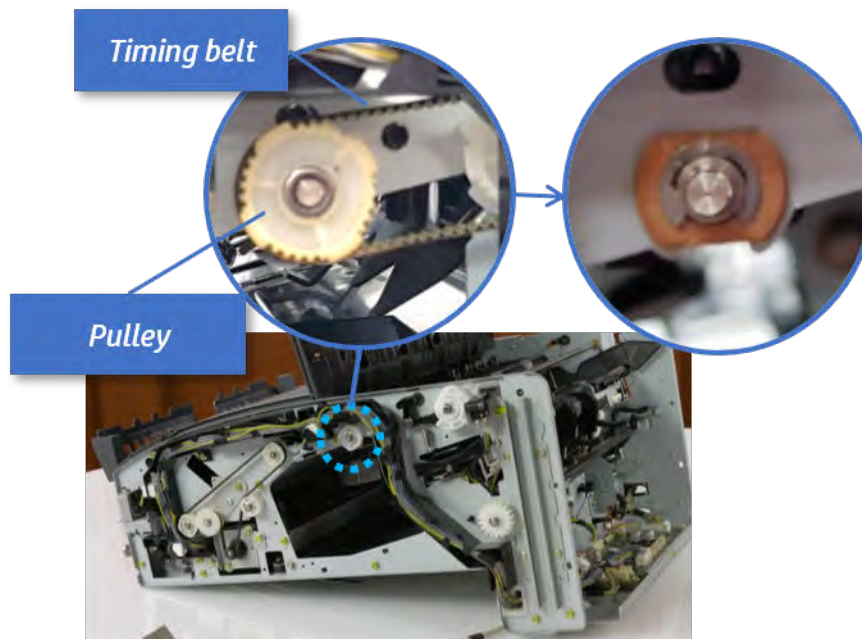
1. Open the top cover, and then remove one screw securing the sub paddle unit.

Figure 6-337 Remove one screw



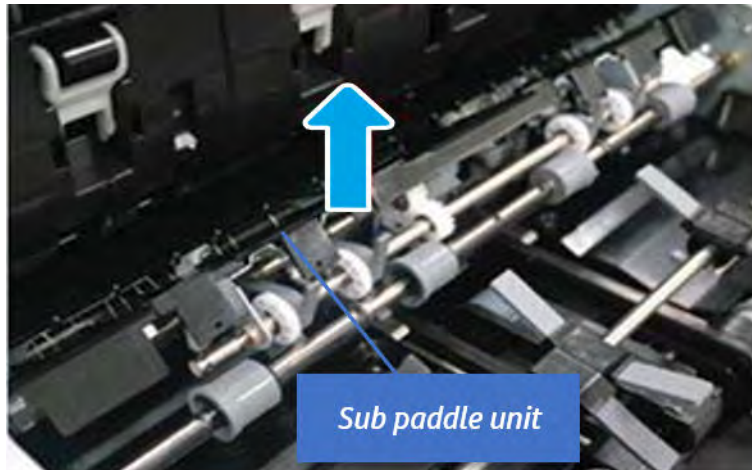
2. Remove the e-ring, and then remove the pulley and timing belt. And then remove the e-ring and the bushing.

Figure 6-338 Remove the e-ring, pulley, timing belt, and bushing



3. Lift up and remove the sub paddle unit.

Figure 6-339 Remove the sub paddle unit

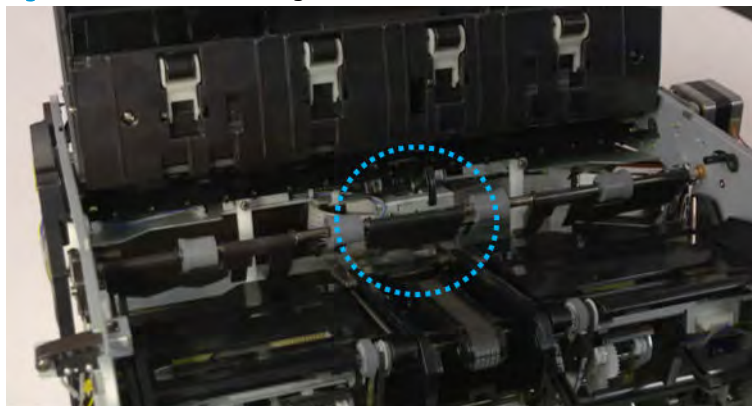


### Remove the exit roller

Follow these steps to remove the exit roller.

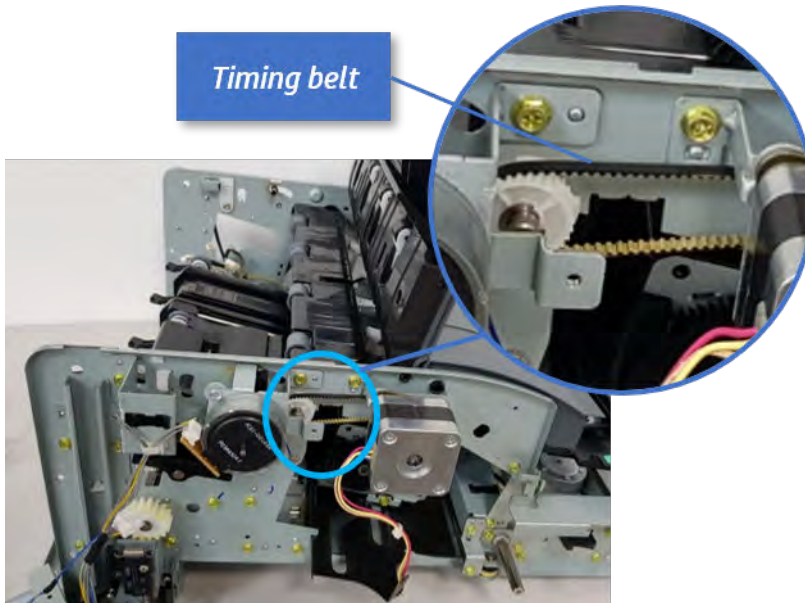
1. Remove the guide on the center of the exit roller.

Figure 6-340 Remove the guide



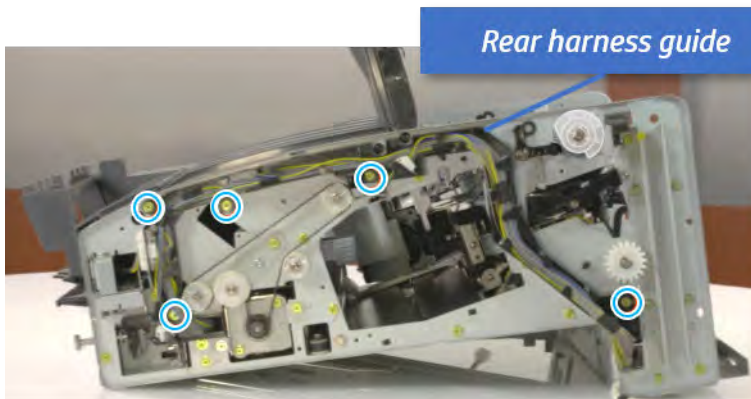
2. On the front of the inner finisher, release the timing belt connected to the exit motor.

Figure 6-341 Release the timing belt



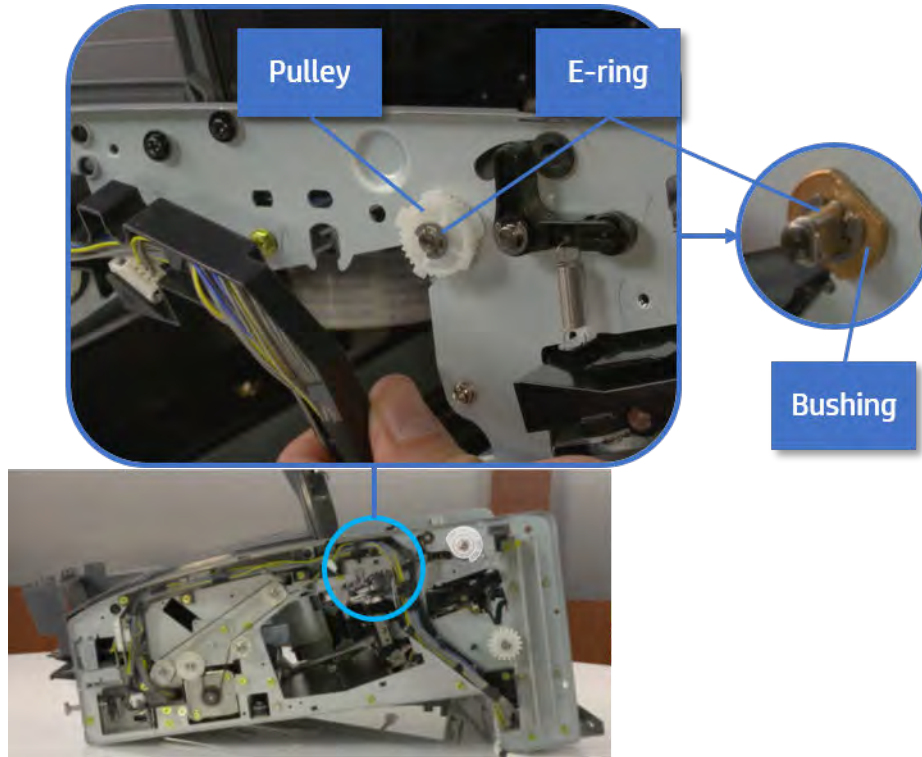
3. Remove five screws securing the rear harness guide.

Figure 6-342 Remove five screws



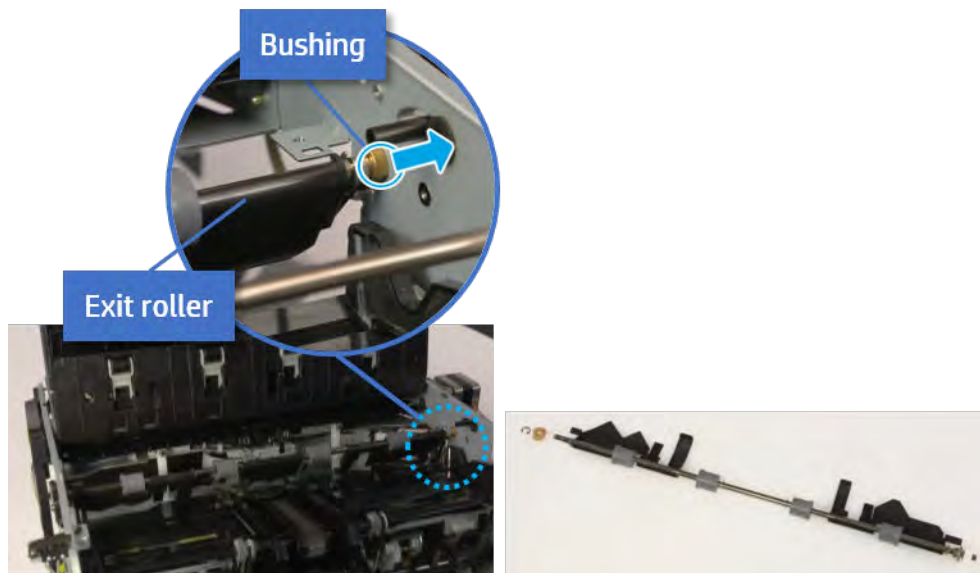
4. On the rear of the inner finisher, remove the e-ring and the pulley and then remove the e-ring and the bushing.

Figure 6-343 Remove e-ring, pulley, and bushing



5. Push the bushing to detach it, and then remove the exit roller.

Figure 6-344 Remove the exit roller

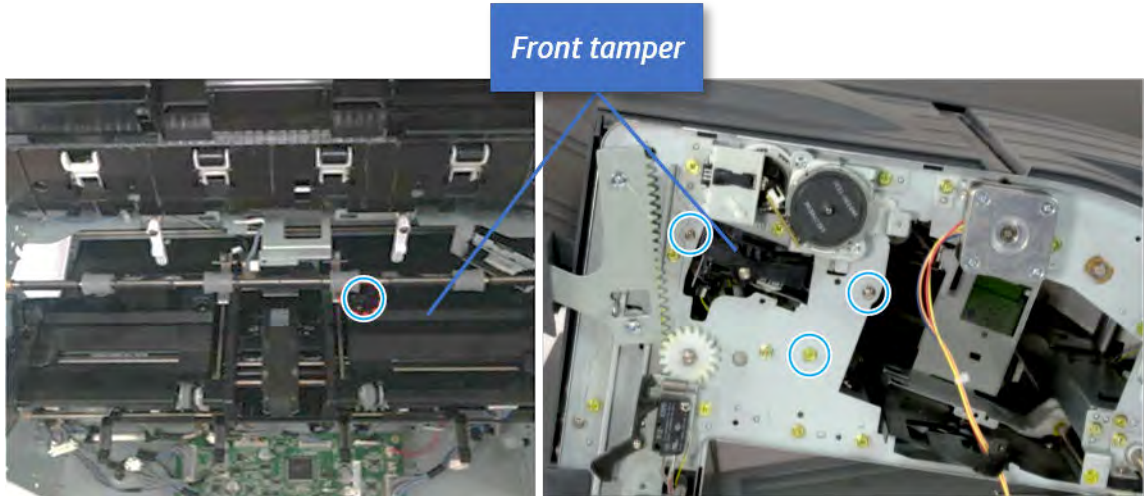


### Remove the front tamper

Follow these steps to remove the front tamper.

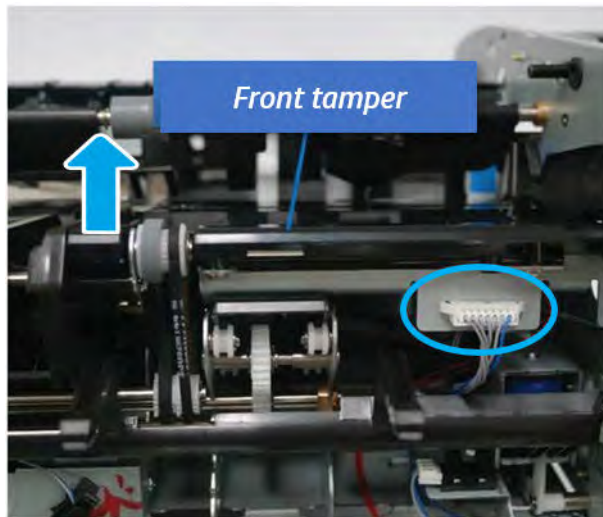
1. Remove four screws.

Figure 6-345 Remove four screws



2. Unplug the connector and release the hook, and then pull the front tamper up to remove.

Figure 6-346 Remove the front tamper



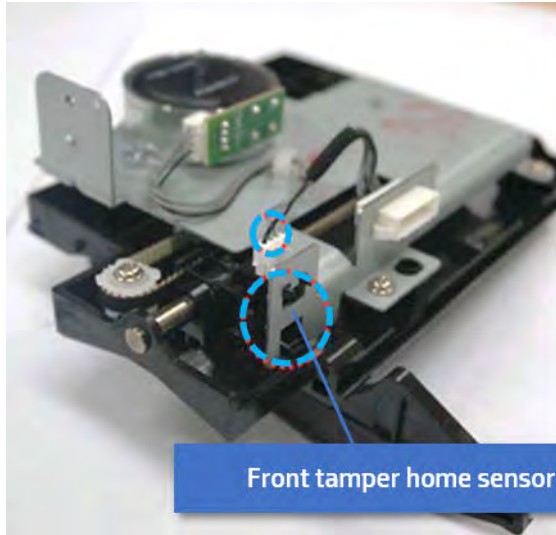
### Remove the front tamper home sensor

Follow these steps to remove the front tamper home sensor.

- ▲ Unplug the connector, and then remove the front tamper home sensor.



Figure 6-347 Remove the front tamper home sensor



### Unpack the replacement assembly



Follow these steps to unpack the replacement assembly.


1. Dispose of the defective part.


 **NOTE:** HP recommends responsible disposal of the defective part.

<http://www8.hp.com/us/en/hp-information/environment/product-recycling.html>


2. Unpack the replacement part from the packaging.

 **CAUTION:**  Some parts are sensitive to electrostatic discharge (ESD). Always perform service work at an ESD-protected workstation or mat. If an ESD workstation or mat is not available, touch the sheet-metal chassis to provide a static ground before touching an ESD-sensitive assembly. Protect the ESD-sensitive assemblies by placing them in ESD pouches when they are out of the printer.

 **IMPORTANT:** Make sure that all of the shipping materials (for example shipping tape) are removed from the replacement part prior to installation.

 **NOTE:** If the replacement part is a roller or pad, avoid touching the spongy part of it. Skin oils on the roller or pad can cause paper pickup and/or print-quality problems. HP recommends using disposable gloves when handling rollers or pads or washing your hands before touching rollers or pads.

3. To install an assembly, reverse the removal steps.

 **NOTE:** When applicable, special installation instructions are provided for an assembly at the end of the removal procedure. Always completely read the removal instructions and follow all special installation instructions.


## Removal and replacement: Front tamper motor (M9)

Learn how to remove and replace the front tamper motor.

To view teardown and reassembling video of the inner finisher, click the link below.

 [View a teardown video of the inner finisher.](#)

 [View a reassembling video of the inner finisher.](#)

 **IMPORTANT:** When applicable, special installation instructions are provided for an assembly at the end of the removal procedure. Always completely read the removal instructions and follow all special installation instructions.


Mean time to repair:

Service level:

### Before performing service

#### Turn the printer power off

- Press the power button on the front of the printer, and then turn off the power switch next to the power cable.
- A shutting-down message appears on the control-panel display.

 **WARNING!** To avoid damage to the printer, turn the power off and wait until the printer shuts down before removing the power cable.

- Disconnect the printer power cable after the printer has completely shut down (the control-panel display is blank).

Use the table below to identify the correct part number for your printer. To order the part, go to [www.hp.com/buy/parts](http://www.hp.com/buy/parts).

Table 6-55 Part information

Part number	Part description
JC93-01001A	Front tamper motor assembly

### Required tools

- #2 JIS screwdriver with a magnetic tip

### After performing service

#### Turn the printer power on

- Connect the power cable.
- Use the power switch to turn the power on.

### Post service test

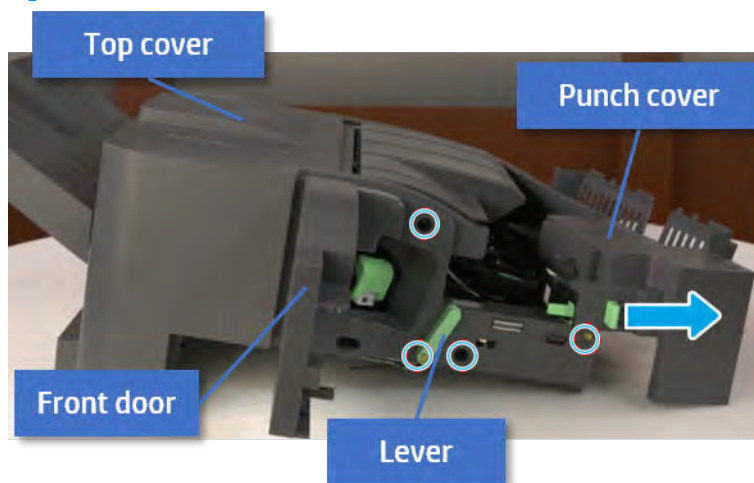
Print any pages necessary to verify that the repair resolved the issue and did not create any new issues.

## Remove the front cover

Follow these steps to remove the front cover:

1. Open the front door and open the punch cover.
2. Remove three screws in the front.
3. Remove the lever.
4. Open the top cover.
5. From the right side of the front cover, carefully lift and pry toward the top-left corner to remove the front cover.

Figure 6-348 Remove the front cover

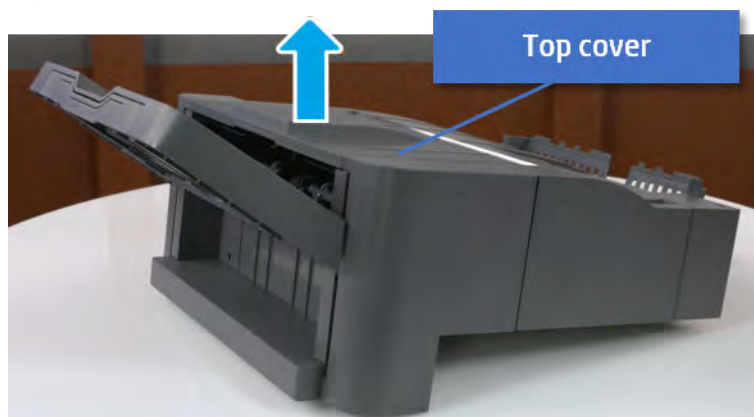


## Remove the rear cover

Follow these steps to remove the rear cover:

1. Open the top cover.

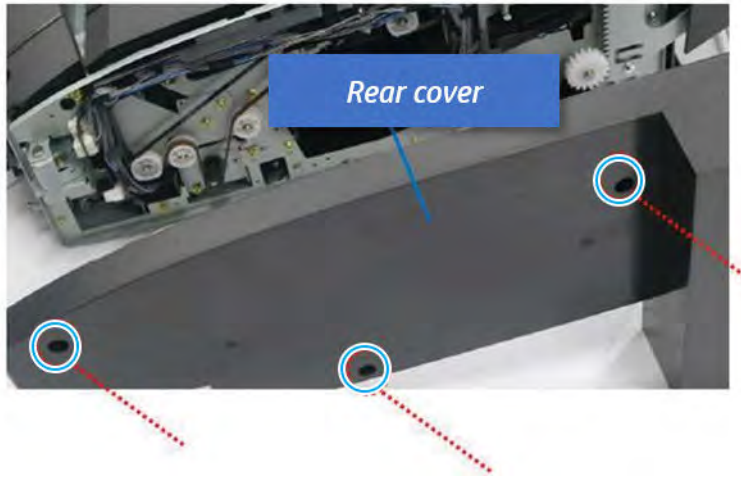
Figure 6-349 Open the top cover



2. Remove three screws.

3. Release hooks carefully and remove the rear cover.

**Figure 6-350** Remove the rear cover

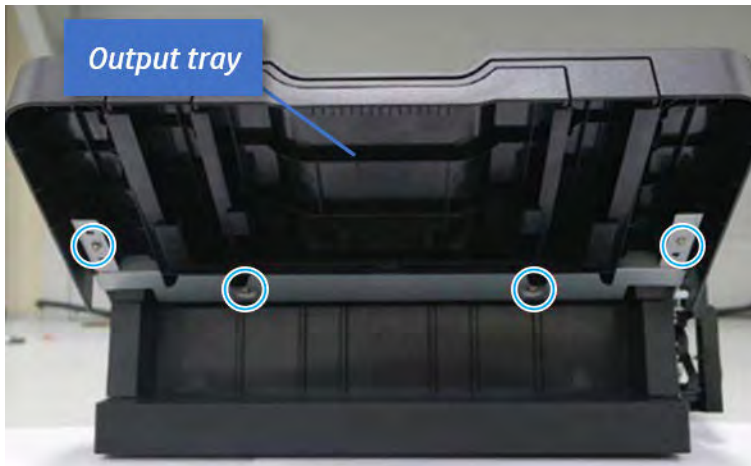


### Remove the output tray

Follow these steps to remove the output tray.

1. Remove four screws.

**Figure 6-351** Remove four screws



2. Push the paper holding actuator into the inner finisher, and then remove the output tray.

Figure 6-352 Remove the output tray.

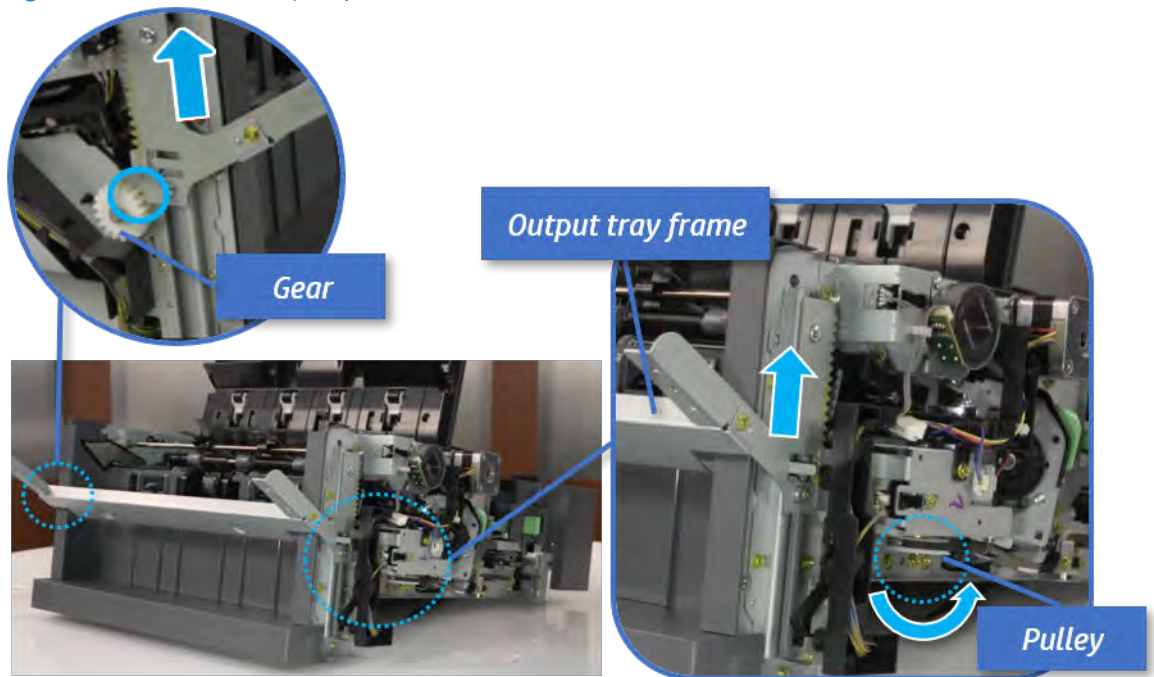


### Remove the output tray frame

Follow these steps to remove the output tray frame.

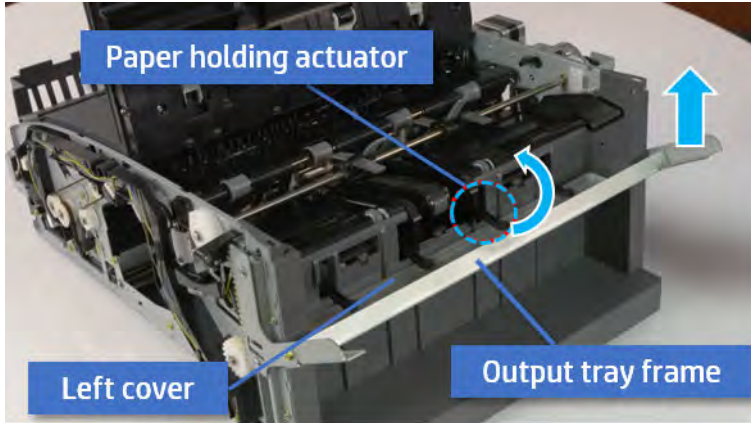
1. Rotate the pulley until the output tray frame depart from the gear.

Figure 6-353 Remove the pulley



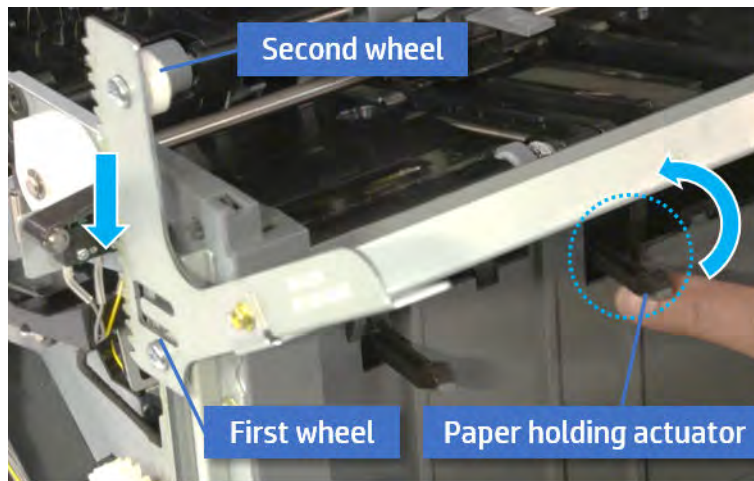
2. Push the paper holding actuator into the inner finisher, and then remove the output tray frame.

Figure 6-354 Remove the output tray frame

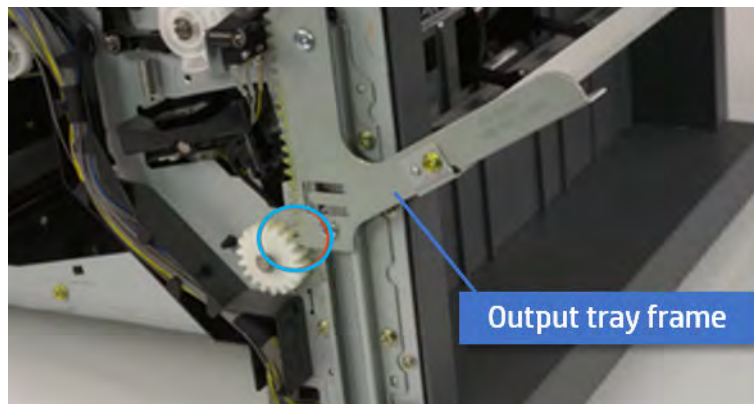


**TIP:** Push the paper holding actuator into the inner finisher when reassembling. Be sure to level the output tray.

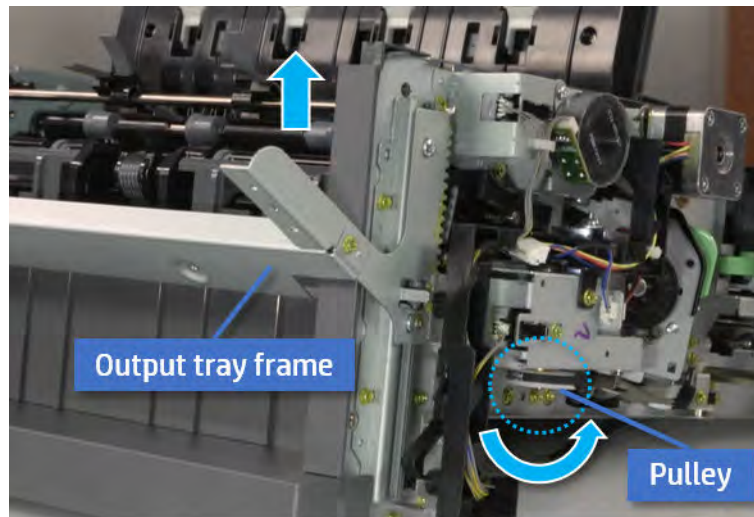
- a. Position the first wheel into the channel on both sides while pushing the paper holding actuator.



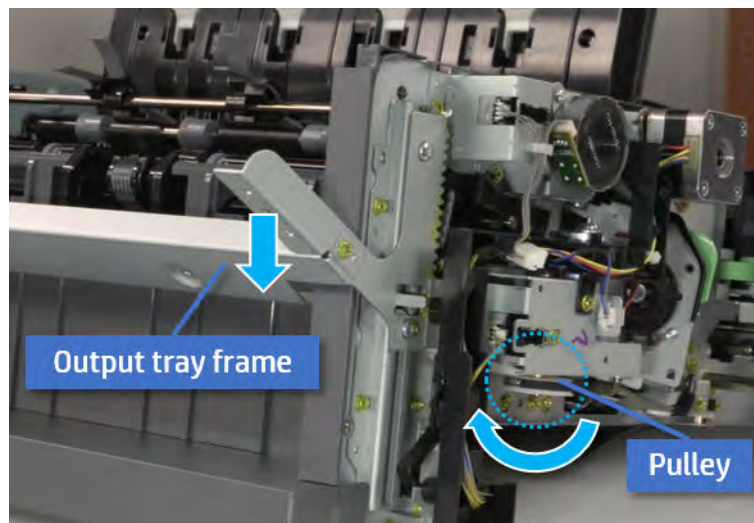
- b. Let the second wheel rest on the channel on both sides simultaneously.
- c. Gently squeeze the wheels into channel until the output tray frame meet the gear.



- d. Rotate the pulley until the output tray frame is no longer lifted. It can make to level the output tray frame.



- e. Rotate the pulley in the opposite direction.

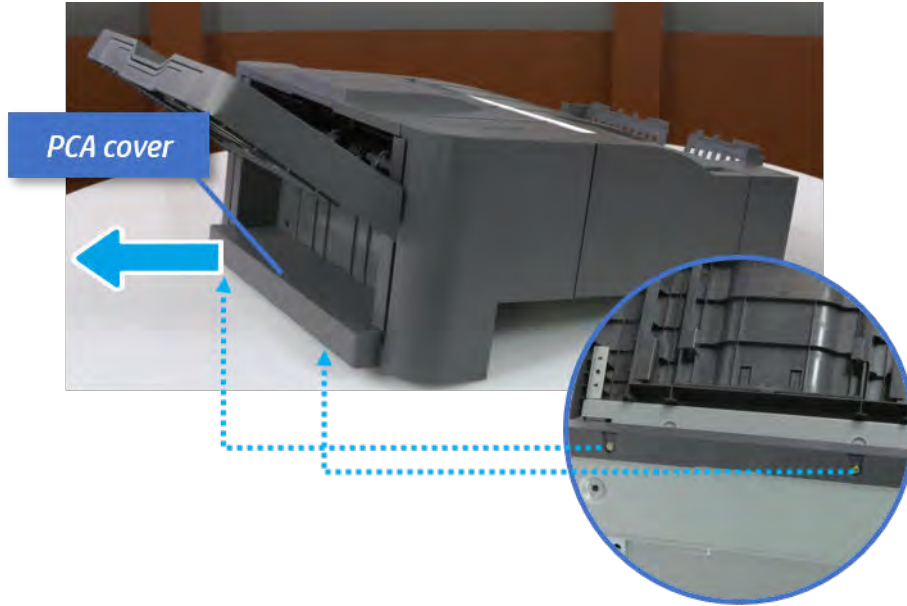


### Remove the PCA cover

Follow these steps to remove the PCA cover.

- ▲ Remove two screws, and then remove the PCA cover.

Figure 6-355 Remove the PCA cover

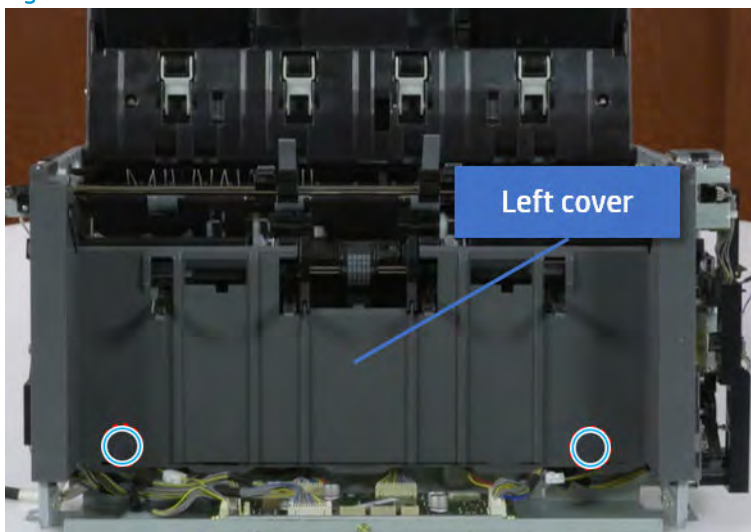


### Remove the left cover

Follow these steps to remove the left cover.

1. Remove two screws.

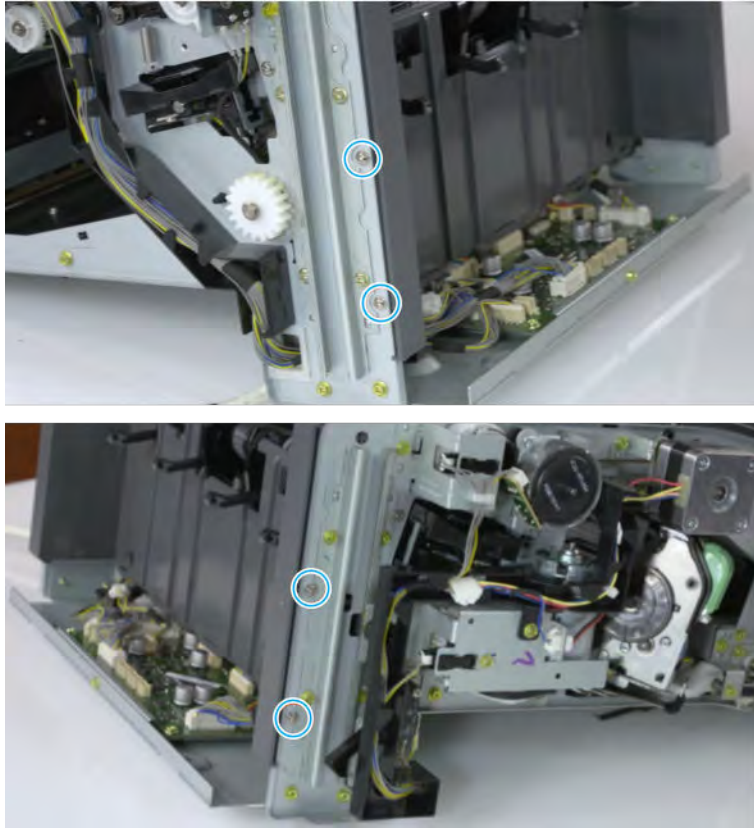
Figure 6-356 Remove two screws





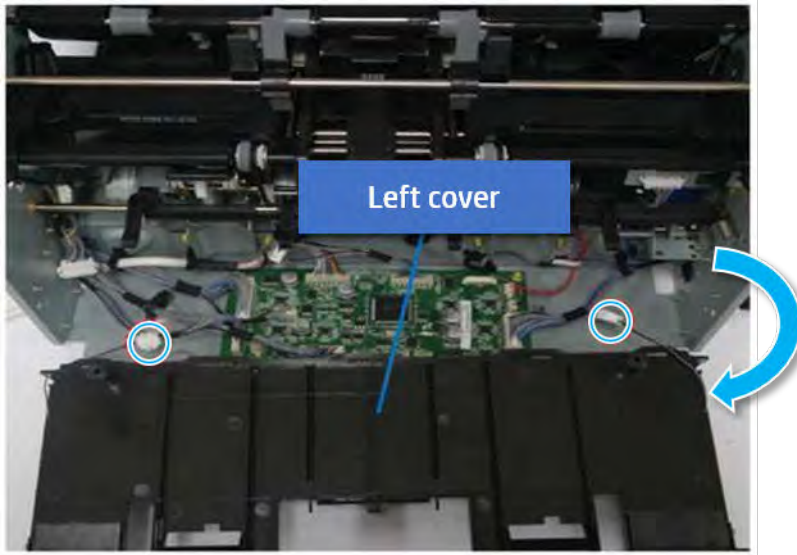
2. Remove four screws from both front and rear sides.


Figure 6-357 Remove four screws

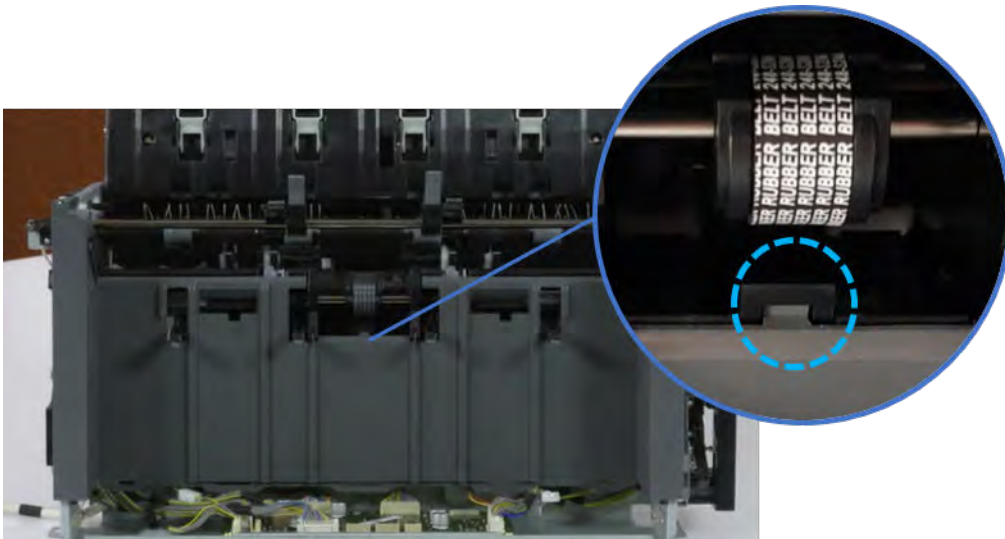


3. Unplug two inline connectors, and then remove the left cover.

**Figure 6-358** Unplug two connectors



 **TIP:** Be sure to check the hook when reassembling.



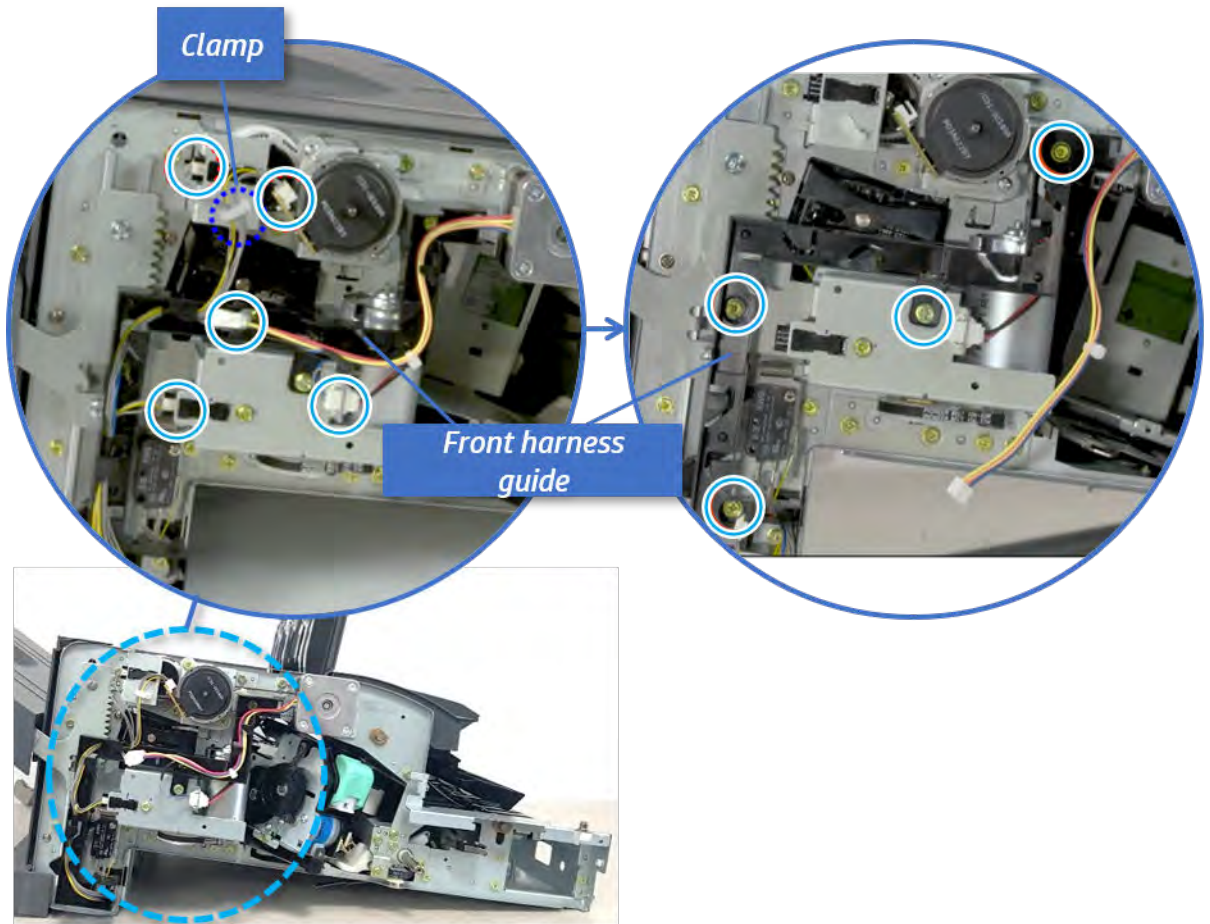
### Remove the front harness guide

Follow these steps to remove the front harness guide.

1. Open one clamp and unplug five connectors, and then remove the wire harness from the front harness guide.

2. Remove four screws, and then remove the front harness guide.

Figure 6-359 Remove the front harness guide

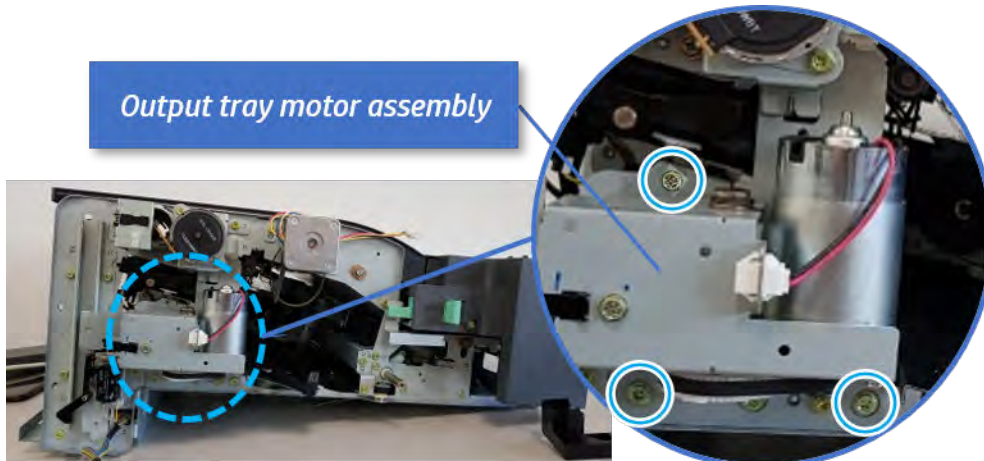


### Remove the output tray motor assembly

Follow these steps to remove the output tray motor assembly.

- ▲ Remove three screws, and then remove the output tray motor assembly.

Figure 6-360 Remove the output tray motor assembly

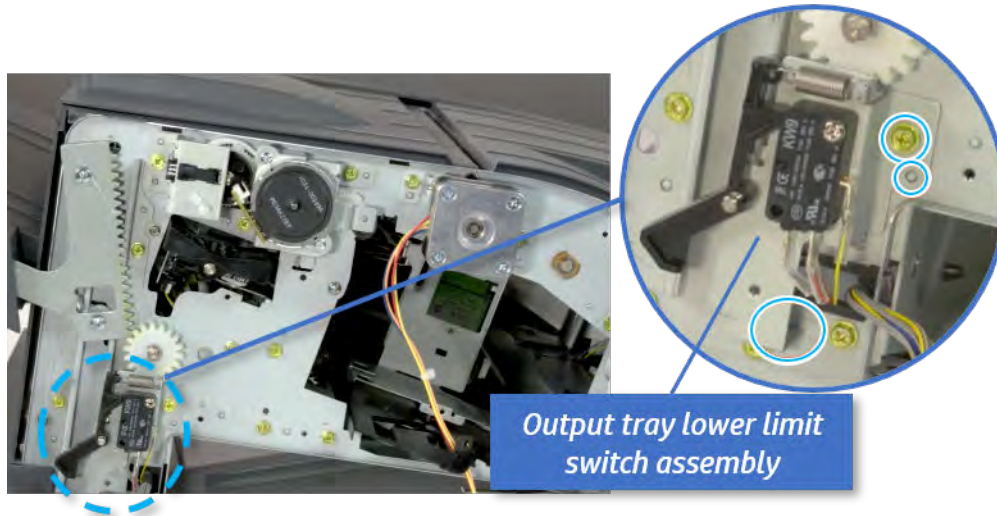


## Remove the output tray lower limit switch

Follow these steps to remove the output tray lower limit switch.

- ▲ Remove one screw, and then remove the output tray lower limit switch.

**Figure 6-361** Remove the output tray lower limit switch

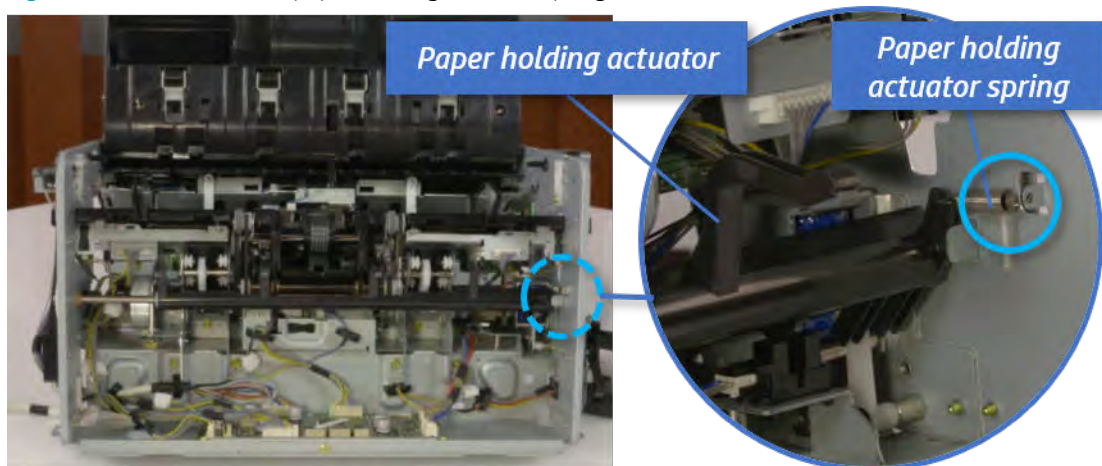


## Remove the paper holding

Follow these steps to remove the paper holding.

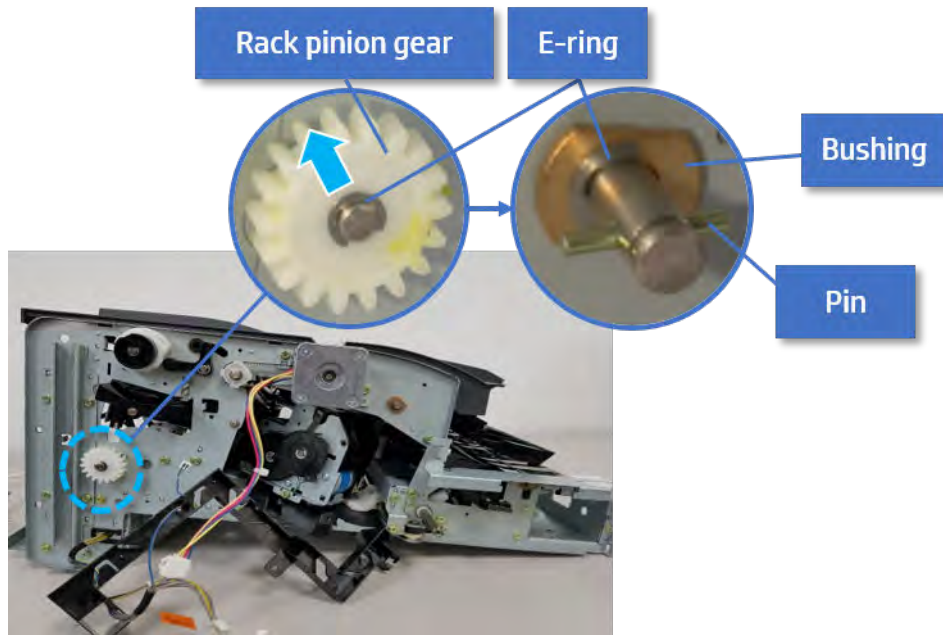
1. Remove the paper holding actuator spring.


**Figure 6-362** Remove the paper holding actuator spring



2. Remove the e-ring and the rack pinion gear. And then remove the pin and the e-ring, and then remove the bushing.

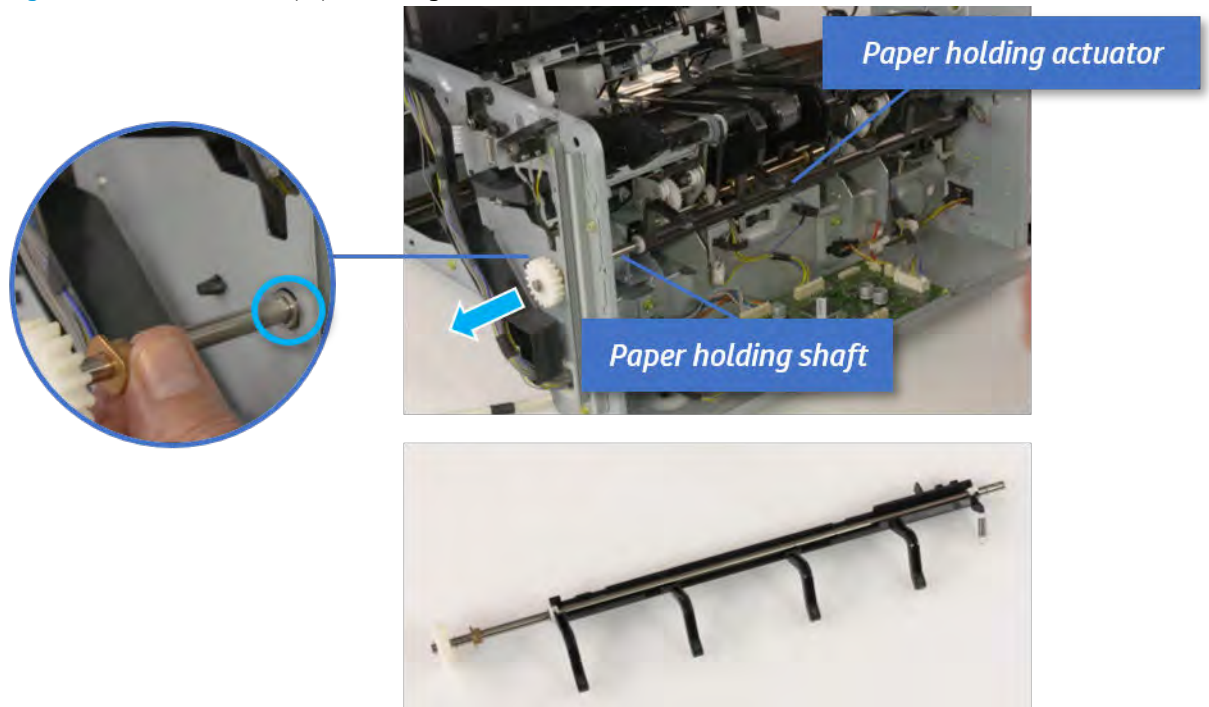
**Figure 6-363** Remove e-ring, rack pinion gear, pin, and bushing



 **NOTE:** Be sure not to lose the pin.

3. Carefully remove the paper holding shaft and the actuator.

**Figure 6-364** Remove the paper holding shaft and the actuator

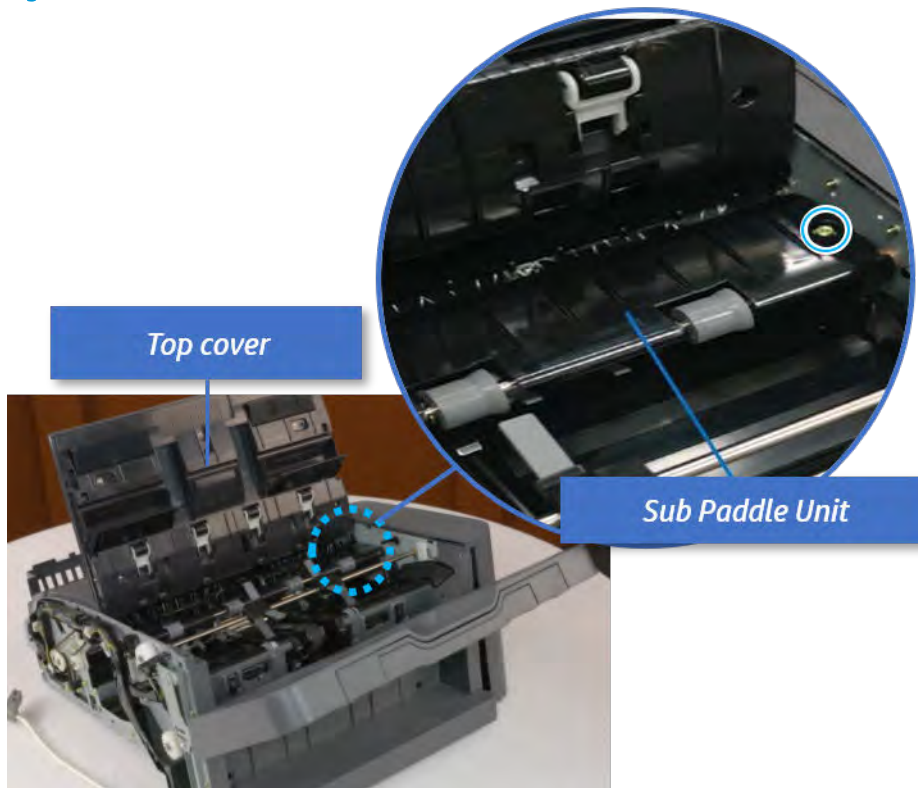


### Remove the sub paddle unit

Follow these steps to remove the sub paddle unit.

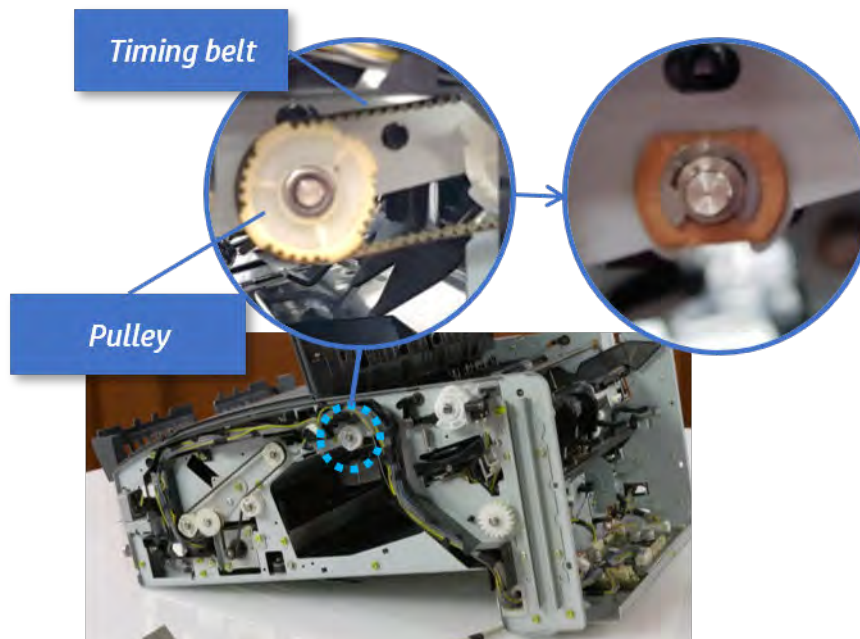
1. Open the top cover, and then remove one screw securing the sub paddle unit.

Figure 6-365 Remove one screw



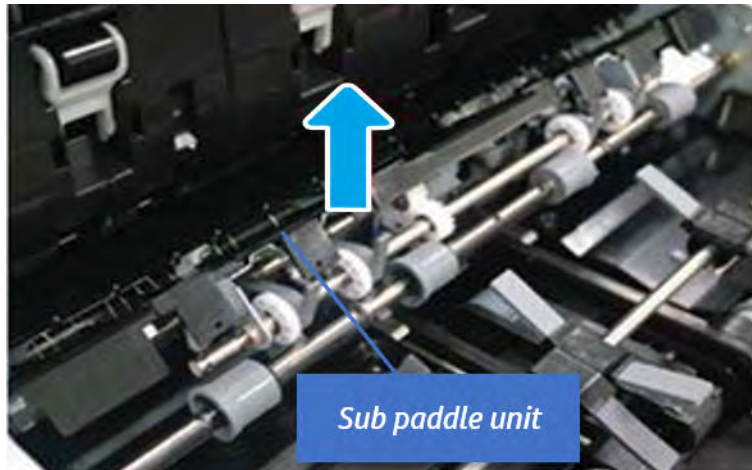
2. Remove the e-ring, and then remove the pulley and timing belt. And then remove the e-ring and the bushing.

Figure 6-366 Remove the e-ring, pulley, timing belt, and bushing



3. Lift up and remove the sub paddle unit.

Figure 6-367 Remove the sub paddle unit

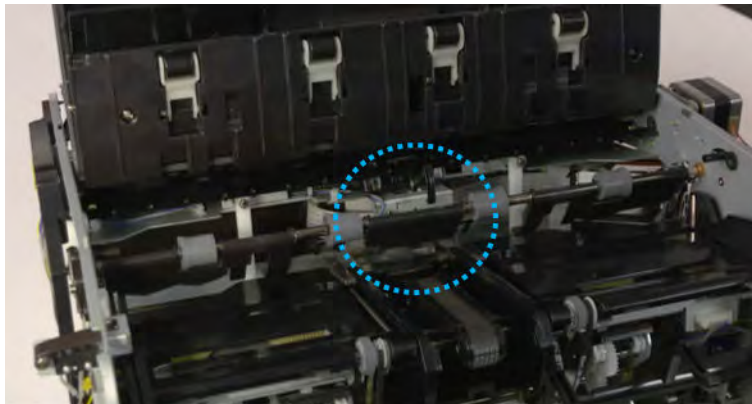


### Remove the exit roller

Follow these steps to remove the exit roller.

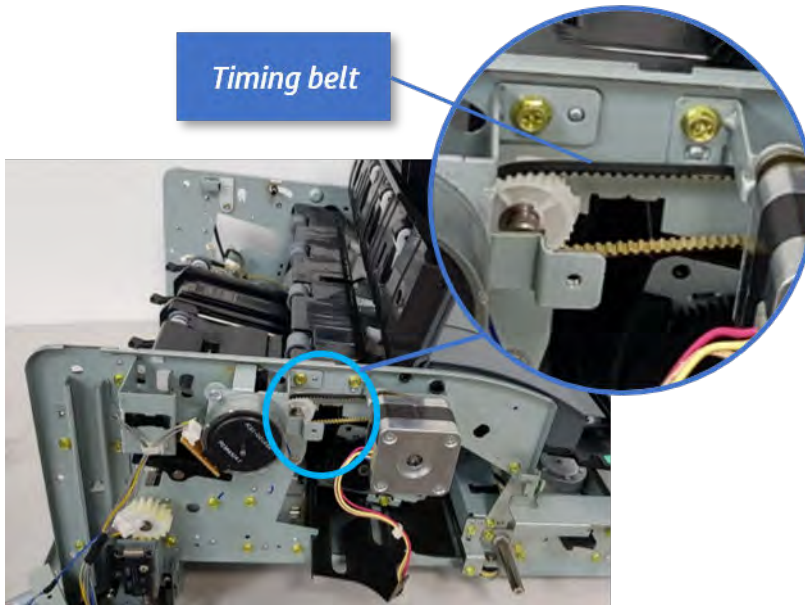
1. Remove the guide on the center of the exit roller.

Figure 6-368 Remove the guide



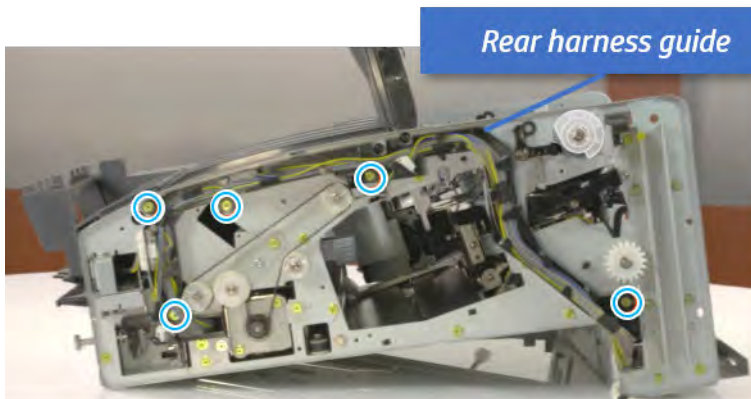
2. On the front of the inner finisher, release the timing belt connected to the exit motor.

Figure 6-369 Release the timing belt



3. Remove five screws securing the rear harness guide.

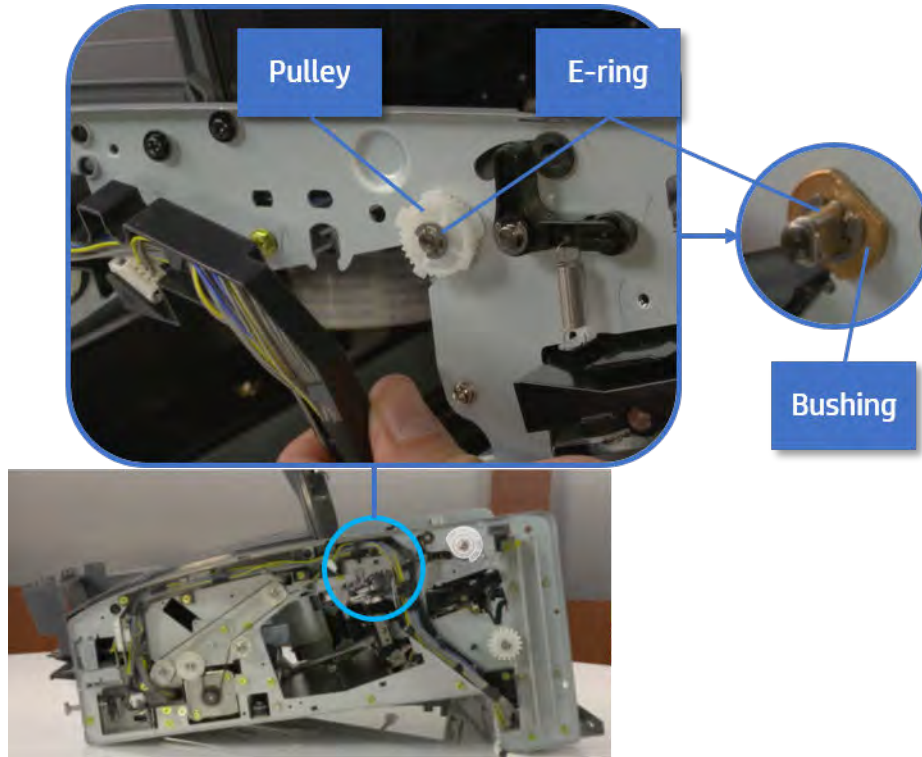
Figure 6-370 Remove five screws





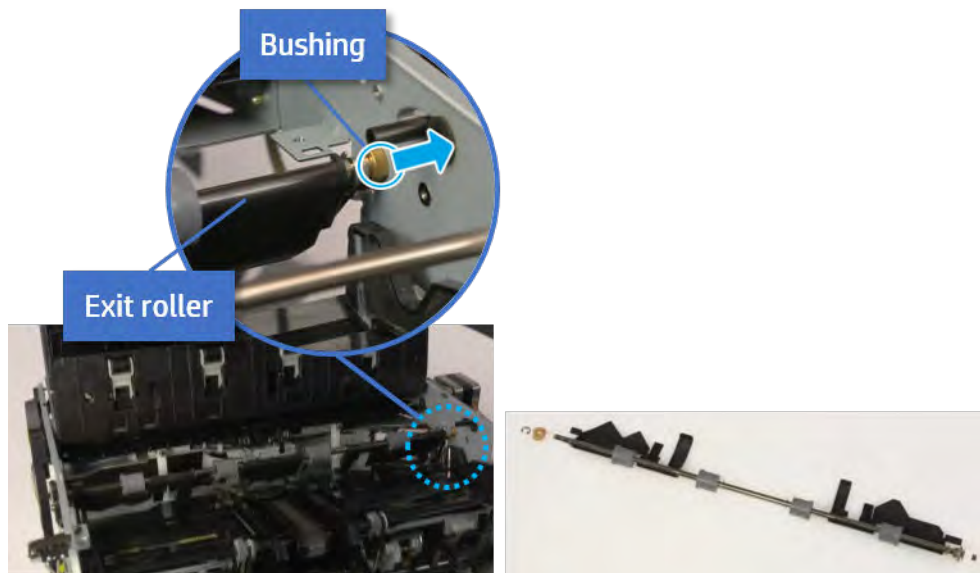
4. On the rear of the inner finisher, remove the e-ring and the pulley and then remove the e-ring and the bushing.

Figure 6-371 Remove e-ring, pulley, and bushing



5. Push the bushing to detach it, and then remove the exit roller.

Figure 6-372 Remove the exit roller

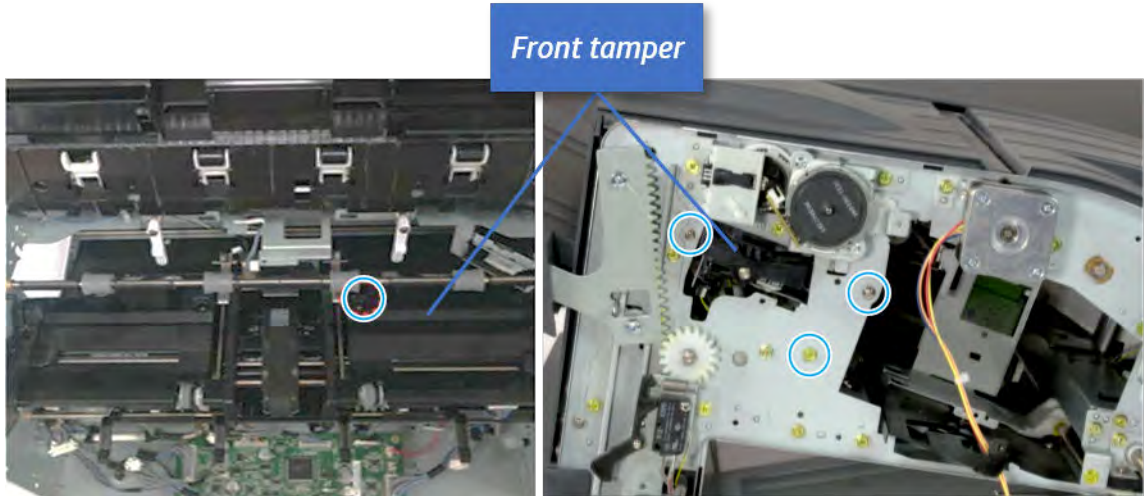


### Remove the front tamper

Follow these steps to remove the front tamper.

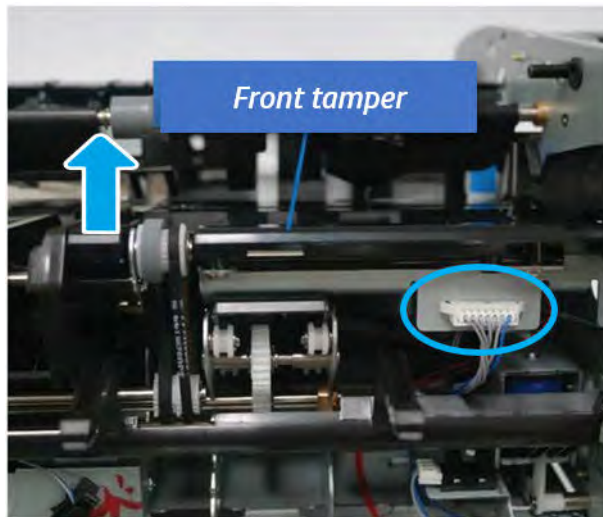
1. Remove four screws.

Figure 6-373 Remove four screws



2. Unplug the connector and release the hook, and then pull the front tamper up to remove.

Figure 6-374 Remove the front tamper

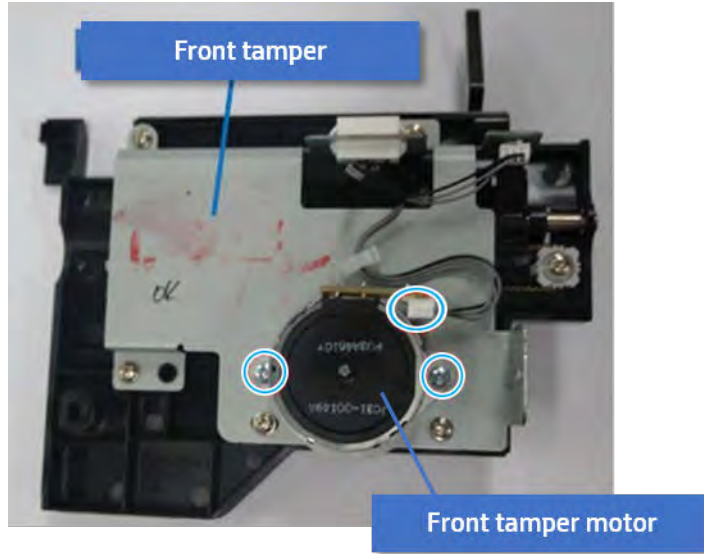


### Remove the front tamper motor

Follow these steps to remove the front tamper motor.

- ▲ Remove two screws, unplug the connector, and then remove the motor.

Figure 6-375 Remove the front tamper motor



### Unpack the replacement assembly



Follow these steps to unpack the replacement assembly.


1. Dispose of the defective part.


 **NOTE:** HP recommends responsible disposal of the defective part.

<http://www8.hp.com/us/en/hp-information/environment/product-recycling.html>


2. Unpack the replacement part from the packaging.

 **CAUTION:**  Some parts are sensitive to electrostatic discharge (ESD). Always perform service work at an ESD-protected workstation or mat. If an ESD workstation or mat is not available, touch the sheet-metal chassis to provide a static ground before touching an ESD-sensitive assembly. Protect the ESD-sensitive assemblies by placing them in ESD pouches when they are out of the printer.

 **IMPORTANT:** Make sure that all of the shipping materials (for example shipping tape) are removed from the replacement part prior to installation.

 **NOTE:** If the replacement part is a roller or pad, avoid touching the spongy part of it. Skin oils on the roller or pad can cause paper pickup and/or print-quality problems. HP recommends using disposable gloves when handling rollers or pads or washing your hands before touching rollers or pads.

3. To install an assembly, reverse the removal steps.

 **NOTE:** When applicable, special installation instructions are provided for an assembly at the end of the removal procedure. Always completely read the removal instructions and follow all special installation instructions.

Rear tamper


## Removal and replacement: Rear tamper

Learn how to remove and replace the rear tamper.

To view teardown and reassembling video of the inner finisher, click the link below.

 [View a teardown video of the inner finisher.](#)

 [View a reassembling video of the inner finisher.](#)

 **IMPORTANT:** When applicable, special installation instructions are provided for an assembly at the end of the removal procedure. Always completely read the removal instructions and follow all special installation instructions.


Mean time to repair:

Service level:

## Before performing service

### Turn the printer power off

- Press the power button on the front of the printer, and then turn off the power switch next to the power cable.
- A shutting-down message appears on the control-panel display.

 **WARNING!** To avoid damage to the printer, turn the power off and wait until the printer shuts down before removing the power cable.

- Disconnect the printer power cable after the printer has completely shut down (the control-panel display is blank).

Use the table below to identify the correct part number for your printer. To order the part, go to <http://www.hp.com/buy/parts>.

**Table 6-56** Part information

Part number	Part description
JC82-00900A	Rear tamper

## Required tools

- #2 JIS screwdriver with a magnetic tip

## After performing service

### Turn the printer power on

- Connect the power cable.
- Use the power switch to turn the power on.

## Post service test

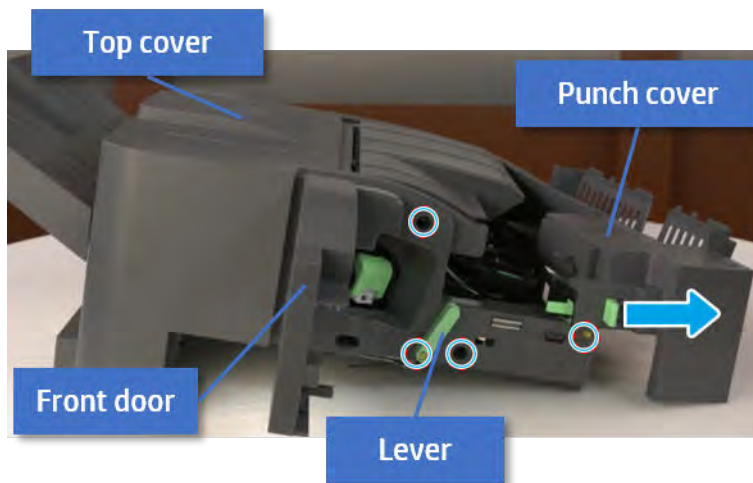
Print any pages necessary to verify that the repair resolved the issue and did not create any new issues.

## Remove the front cover

Follow these steps to remove the front cover.

1. Open the front door and open the punch cover.
2. Remove three screws in the front.
3. Remove the lever.
4. Open the top cover.
5. From the right side of the front cover, carefully lift and pry toward the top-left corner to remove the front cover.

Figure 6-376 Remove the front cover

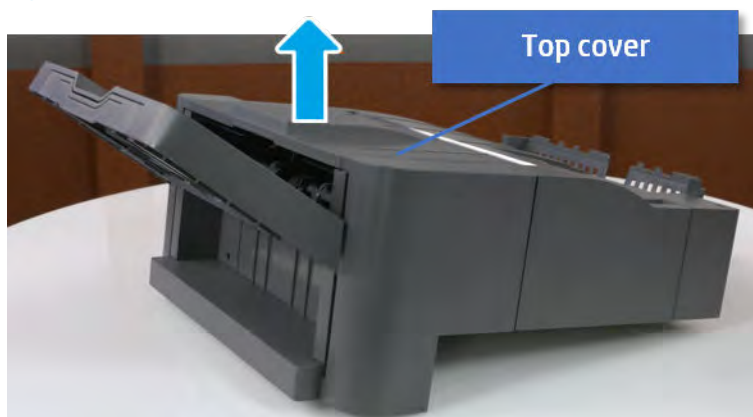


## Remove the rear cover

Follow these steps to remove the rear cover.

1. Open the top cover.

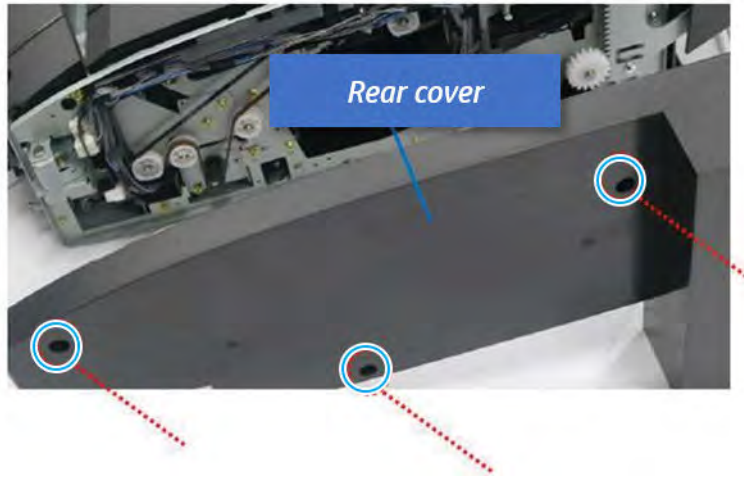
Figure 6-377 Open the top cover



2. Remove three screws.

3. Release hooks carefully and remove the rear cover.

Figure 6-378 Remove the rear cover

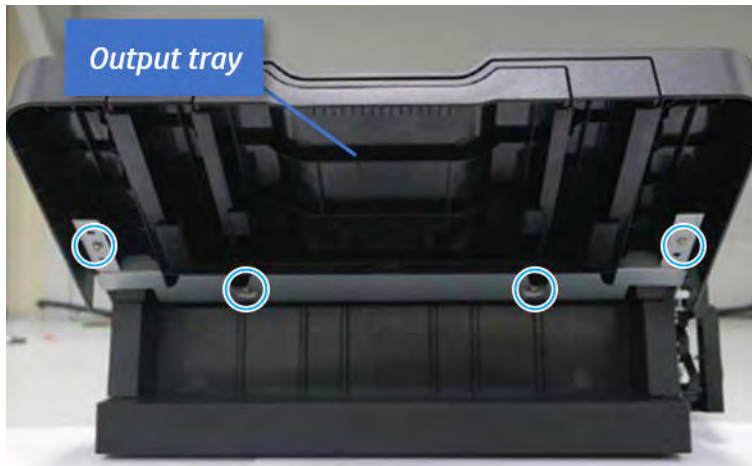


### Remove the output tray

Follow these steps to remove the output tray.

1. Remove four screws.

Figure 6-379 Remove four screws



2. Push the paper holding actuator into the inner finisher, and then remove the output tray.

Figure 6-380 Remove the output tray.

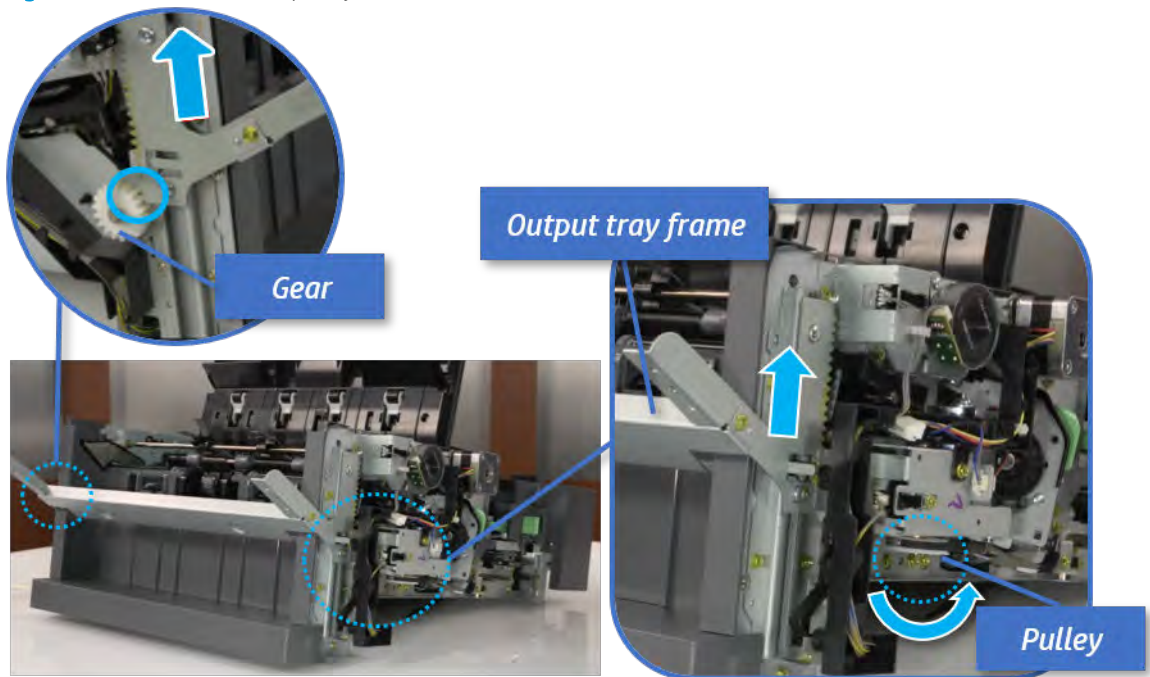


### Remove the output tray frame

Follow these steps to remove the output tray frame.

1. Rotate the pulley until the output tray frame depart from the gear.

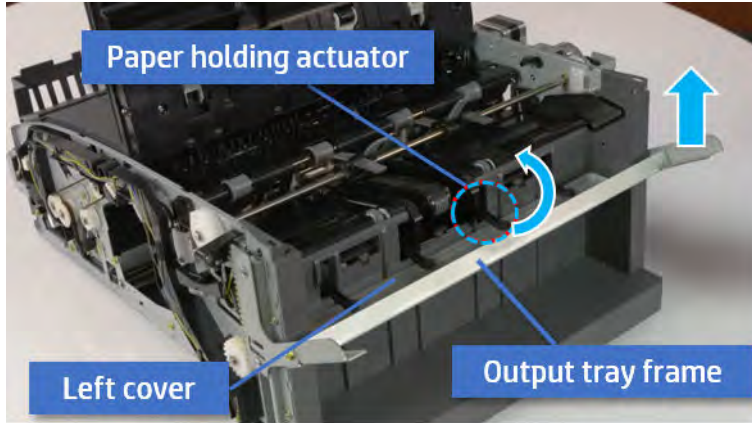
Figure 6-381 Remove the pulley



2. Push the paper holding actuator into the inner finisher, and then remove the output tray frame.

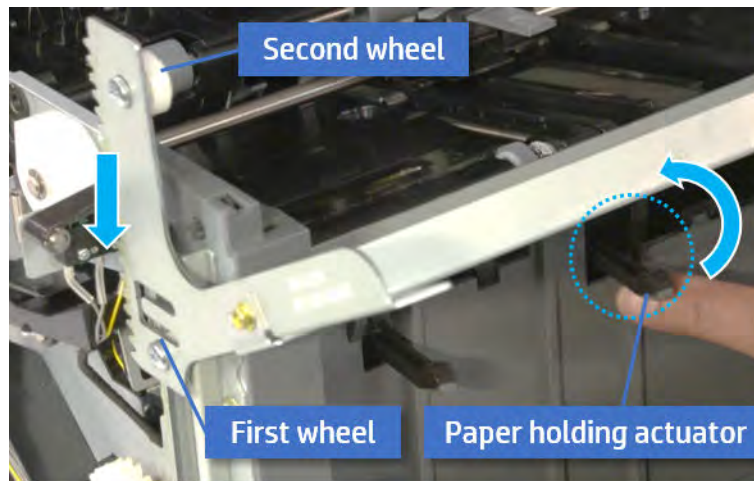


Figure 6-382 Remove the output tray frame

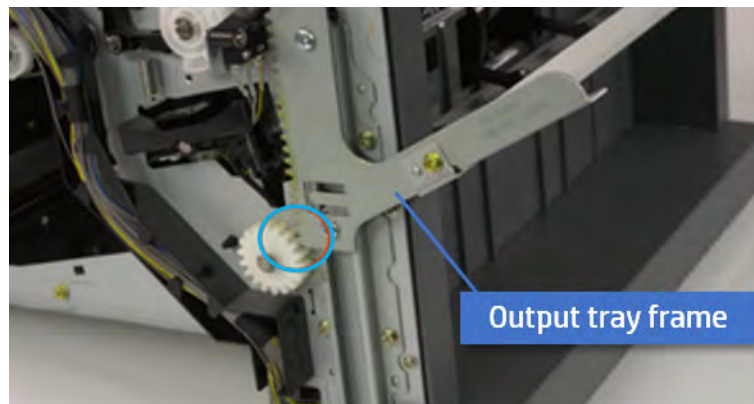


**TIP:** Push the paper holding actuator into the inner finisher when reassembling. Be sure to level the output tray.

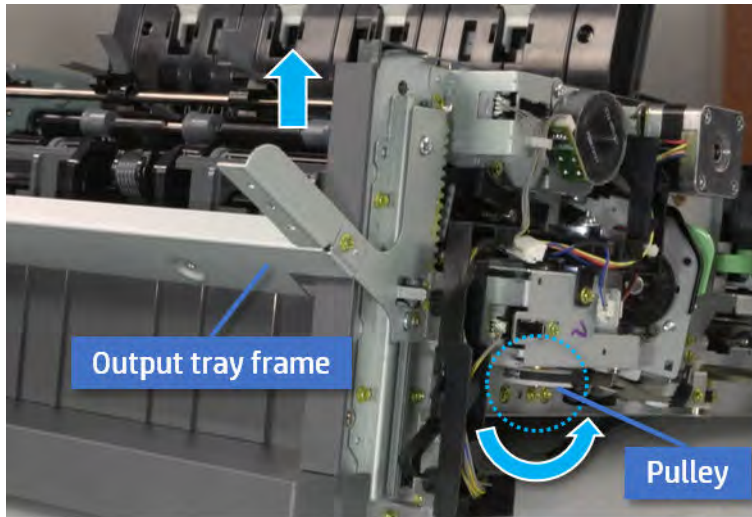
- a. Position the first wheel into the channel on both sides while pushing the paper holding actuator.



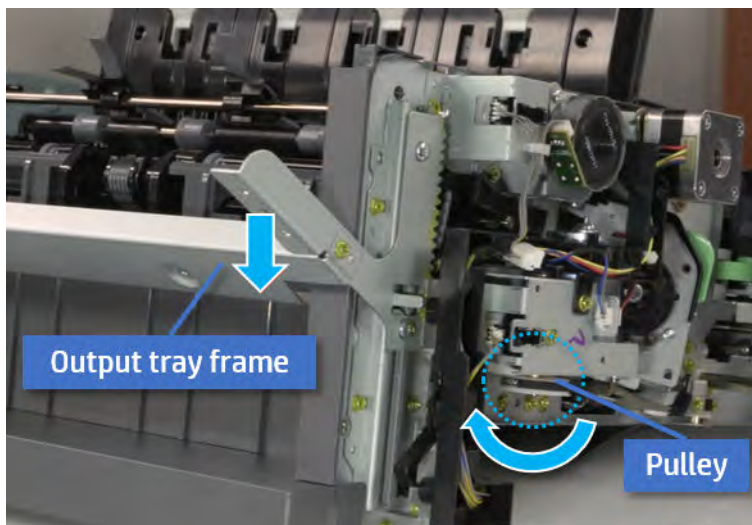
- b. Let the second wheel rest on the channel on both sides simultaneously.
- c. Gently squeeze the wheels into channel until the output tray frame meet the gear.



- d. Rotate the pulley until the output tray frame is no longer lifted. It can make to level the output tray frame.



- e. Rotate the pulley in the opposite direction.

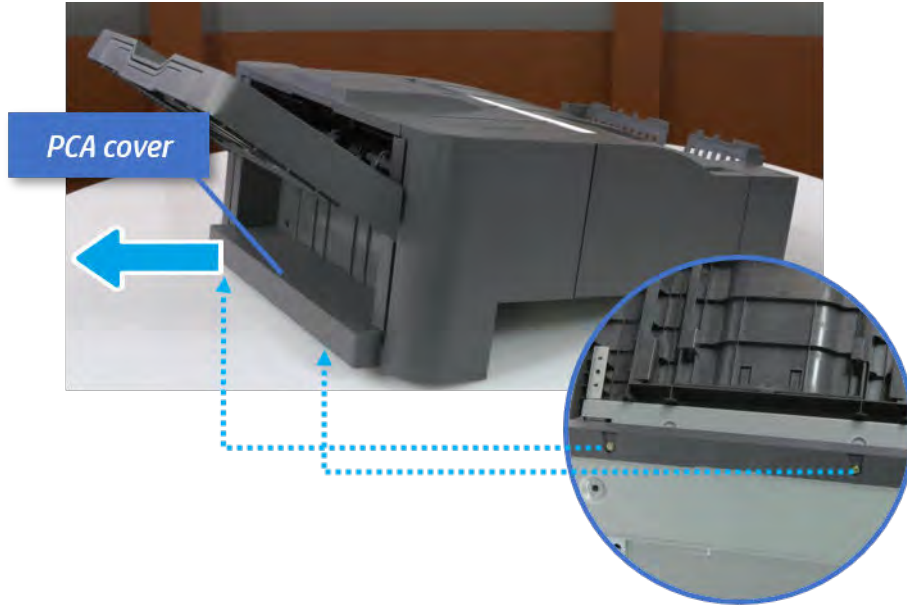


### Remove the PCA cover

Follow these steps to remove the PCA cover.

- ▲ Remove two screws, and then remove the PCA cover.

Figure 6-383 Remove the PCA cover

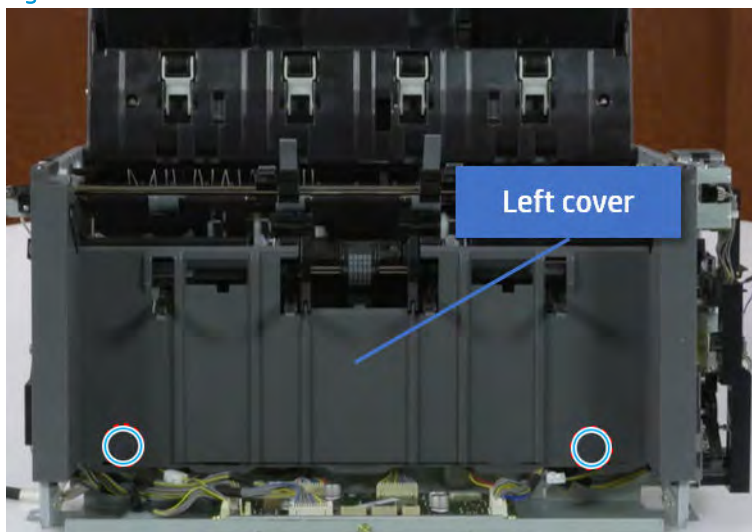


### Remove the left cover

Follow these steps to remove the left cover.

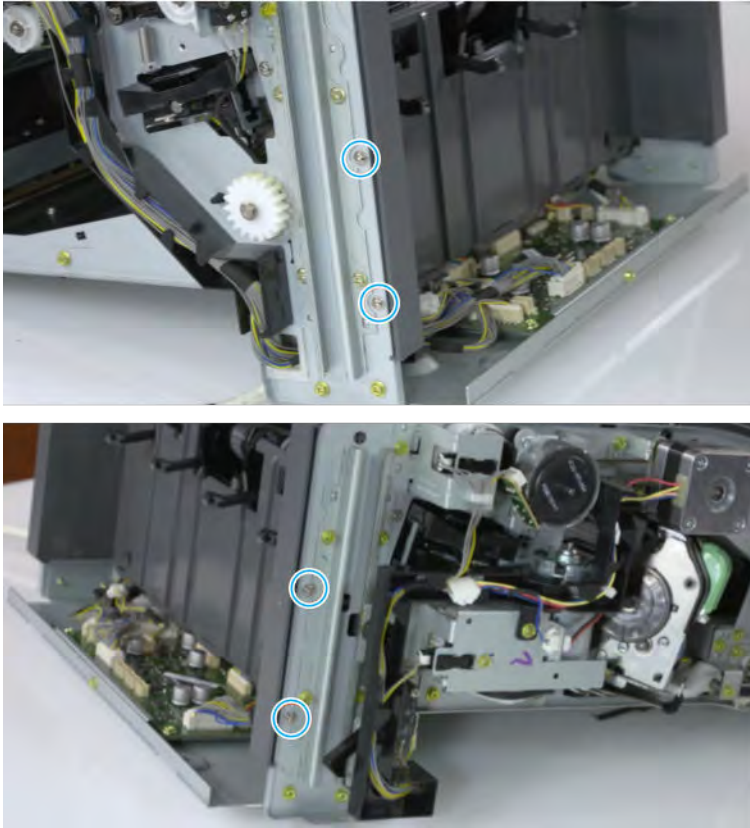
1. Remove two screws.

Figure 6-384 Remove two screws



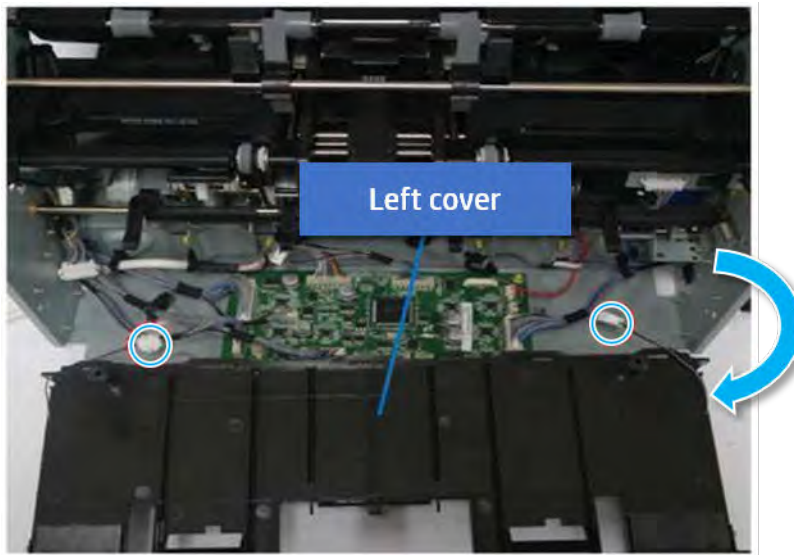
2. Remove four screws from both front and rear sides.


Figure 6-385 Remove four screws

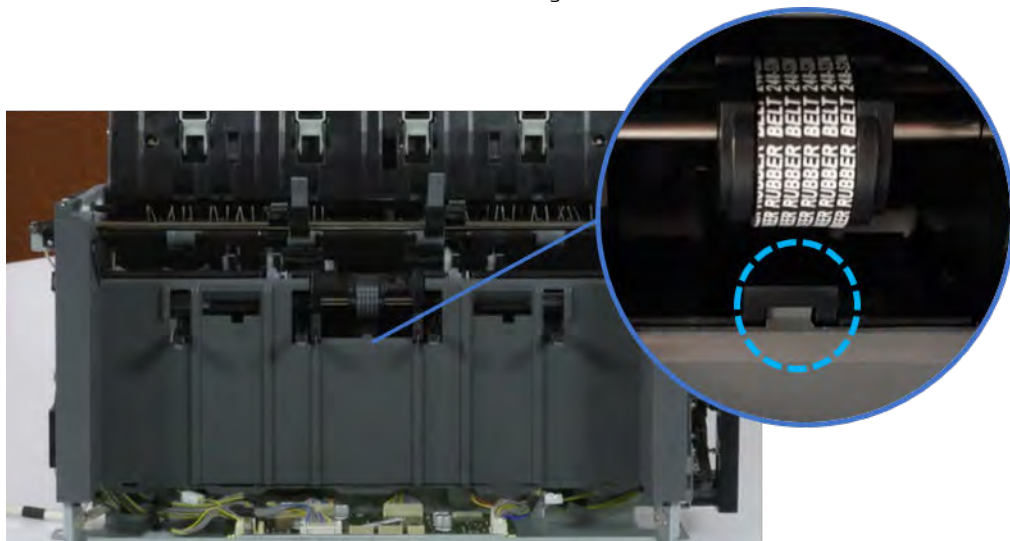


3. Unplug two inline connectors, and then remove the left cover.

Figure 6-386 Unplug two connectors



 **TIP:** Be sure to check the hook when reassembling.



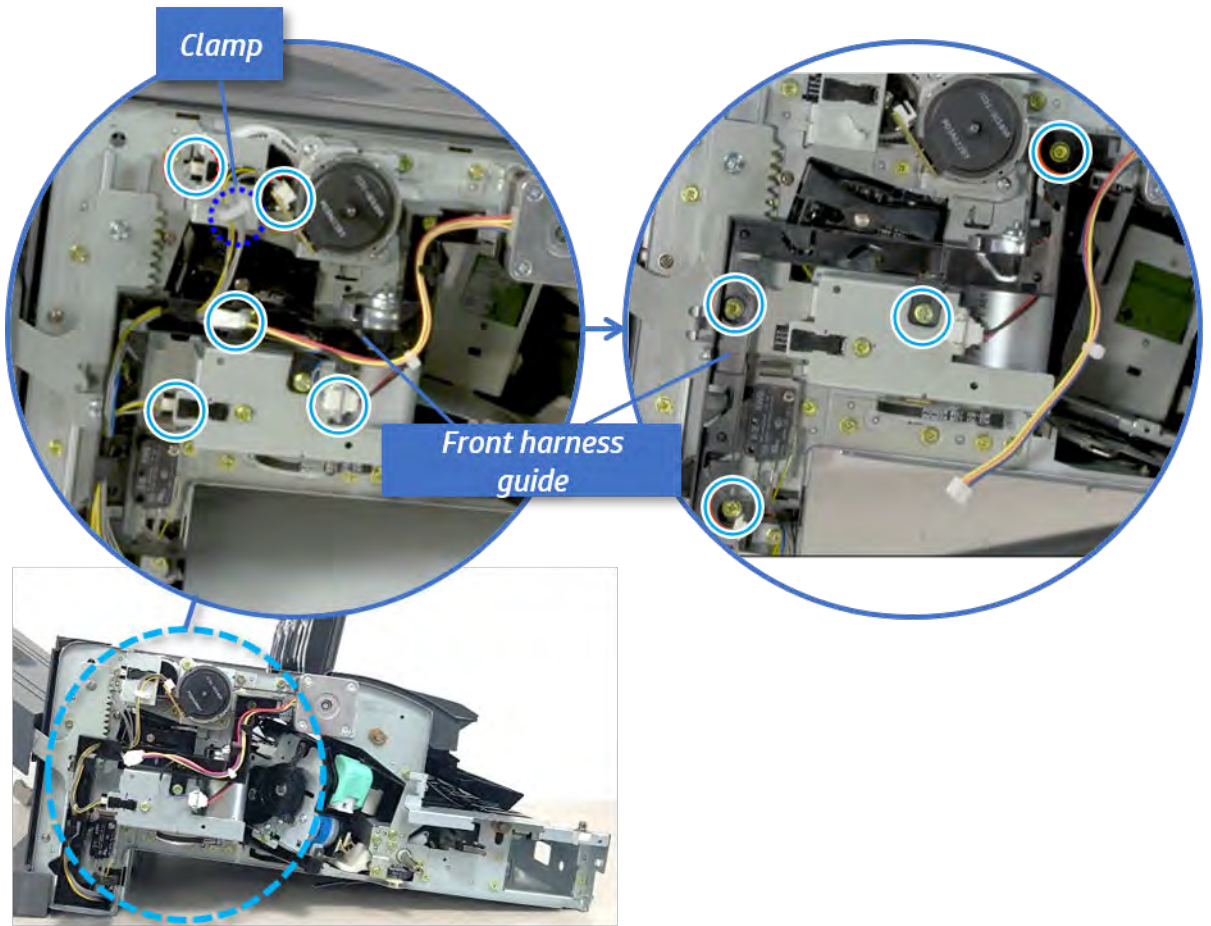
### Remove the front harness guide

Follow these steps to remove the front harness guide.

1. Open one clamp and unplug five connectors, and then remove the wire harness from the front harness guide.

2. Remove four screws, and then remove the front harness guide.

Figure 6-387 Remove the front harness guide

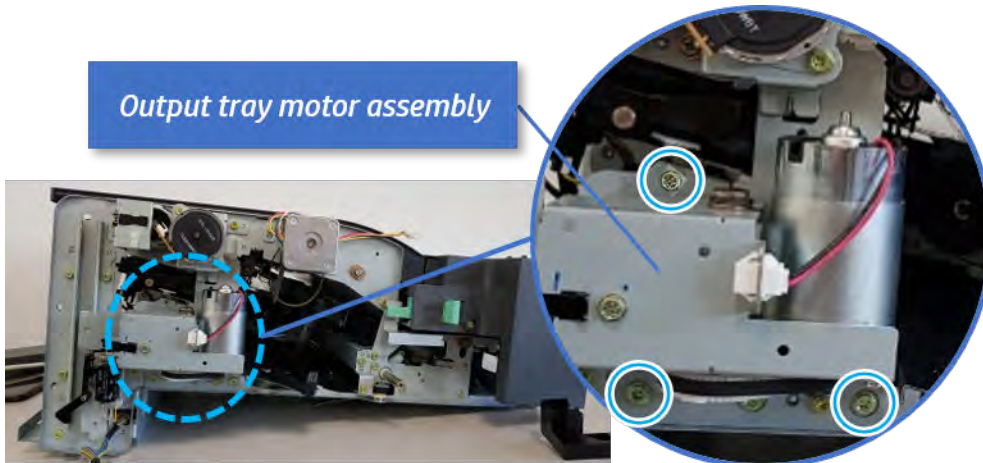


### Remove the output tray motor assembly

Follow these steps to remove the output tray motor assembly.

- ▲ Remove three screws, and then remove the output tray motor assembly.

Figure 6-388 Remove the output tray motor assembly

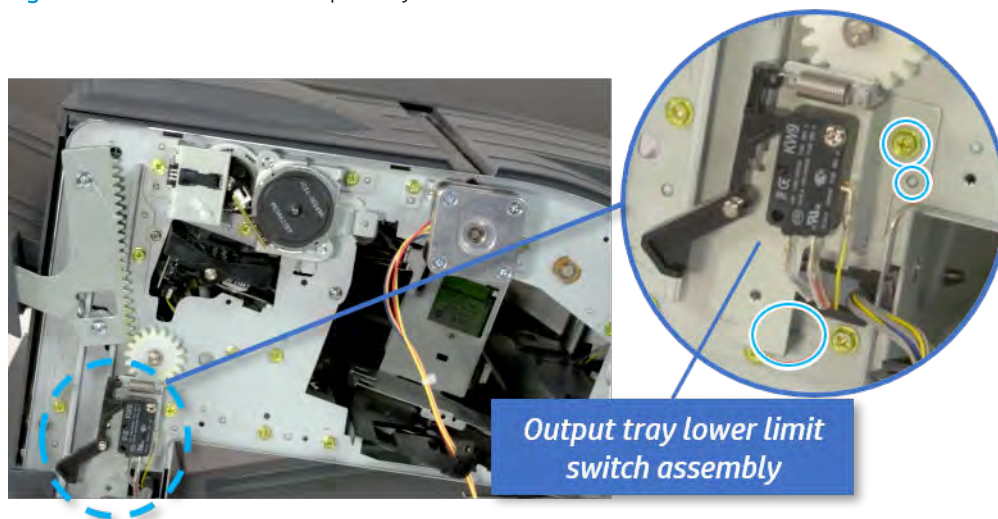


## Remove the output tray lower limit switch

Follow these steps to remove the output tray lower limit switch.

- ▲ Remove one screw, and then remove the output tray lower limit switch.

**Figure 6-389** Remove the output tray lower limit switch

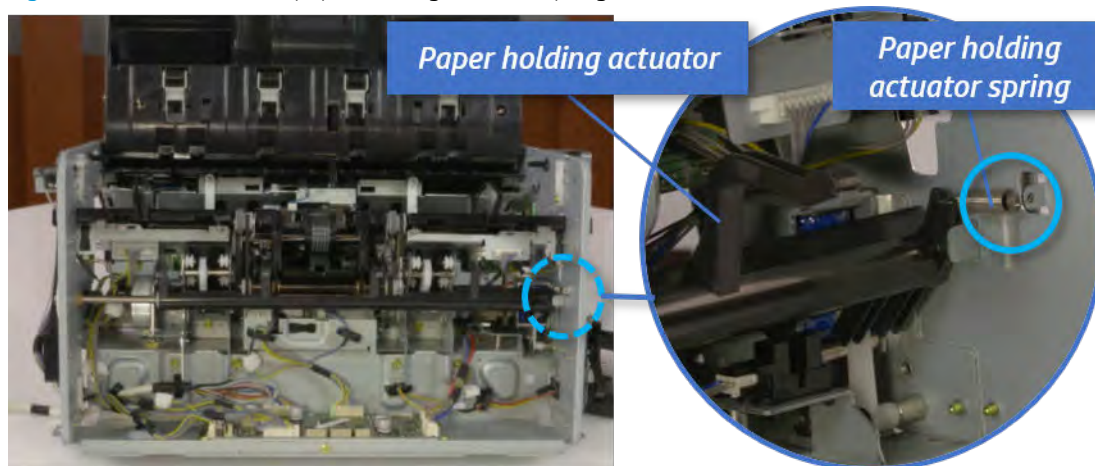


## Remove the paper holding

Follow these steps to remove the paper holding.

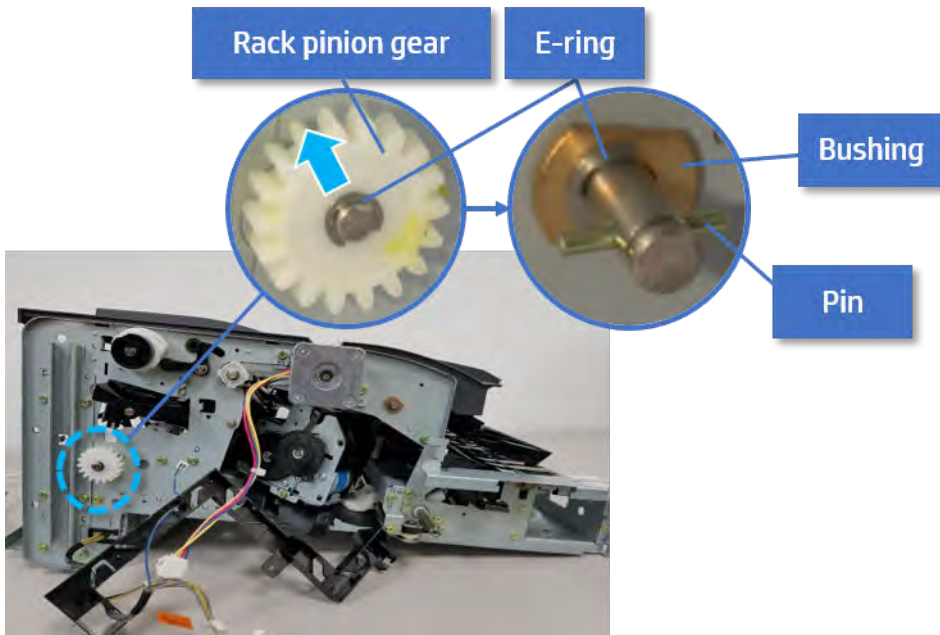
1. Remove the paper holding actuator spring.


**Figure 6-390** Remove the paper holding actuator spring



2. Remove the e-ring and the rack pinion gear. And then remove the pin and the e-ring, and then remove the bushing.

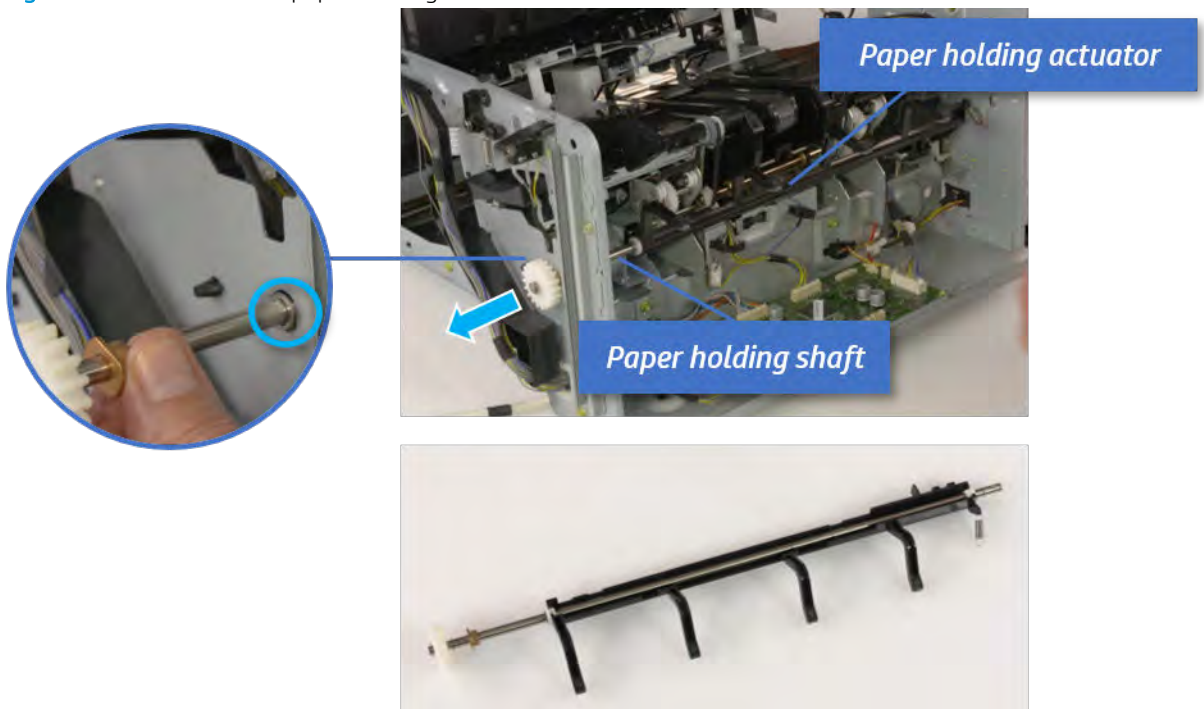
**Figure 6-391** Remove e-ring, rack pinion gear, pin, and bushing



 **NOTE:** Be sure not to lose the pin.

3. Carefully remove the paper holding shaft and the actuator.

**Figure 6-392** Remove the paper holding shaft and the actuator



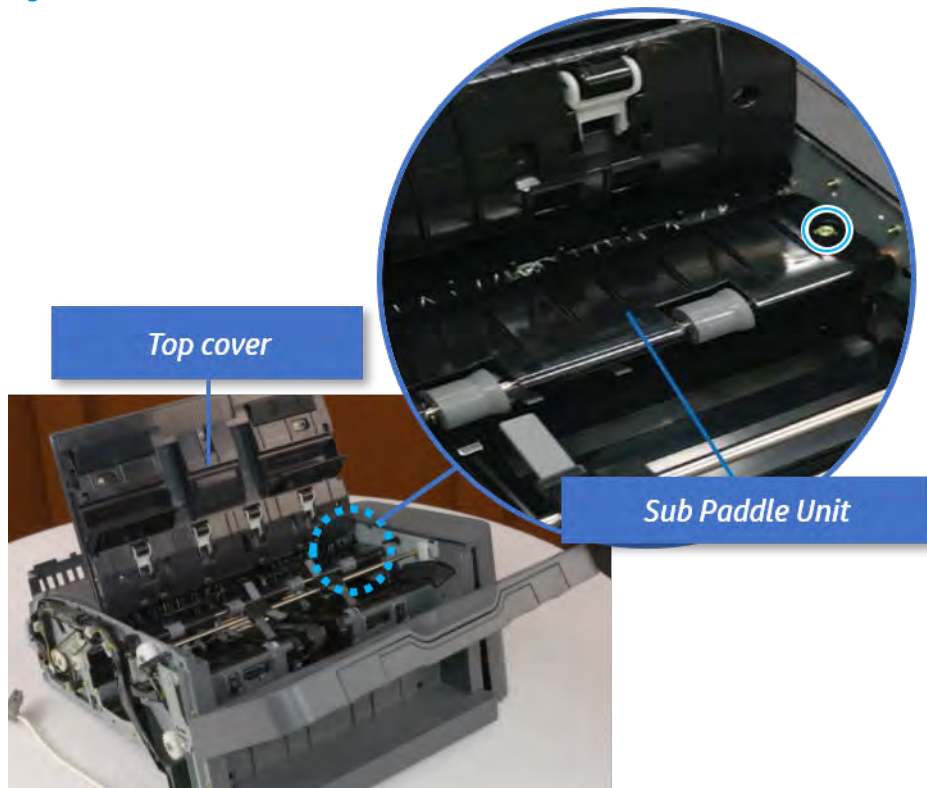
### Remove the sub paddle unit

Follow these steps to remove the sub paddle unit.



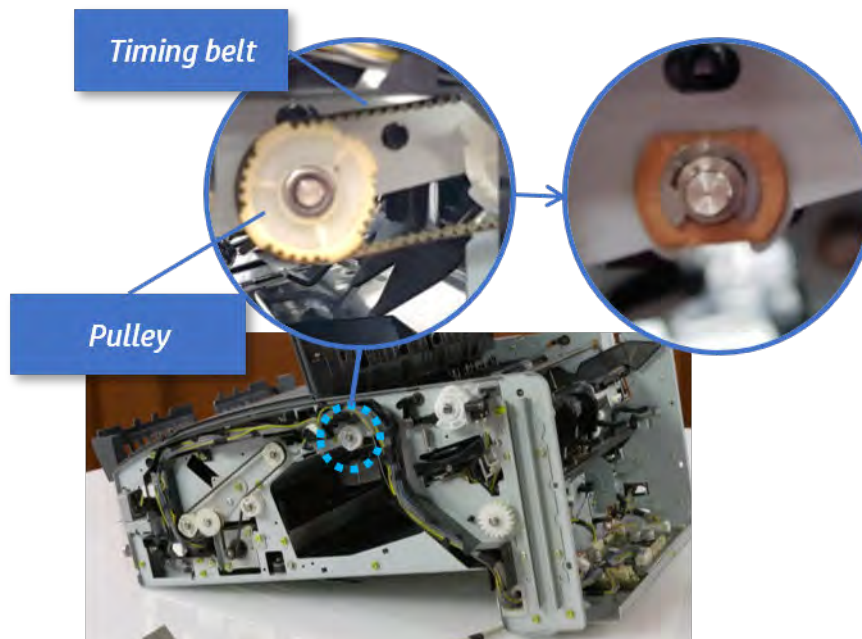
1. Open the top cover, and then remove one screw securing the sub paddle unit.

Figure 6-393 Remove one screw



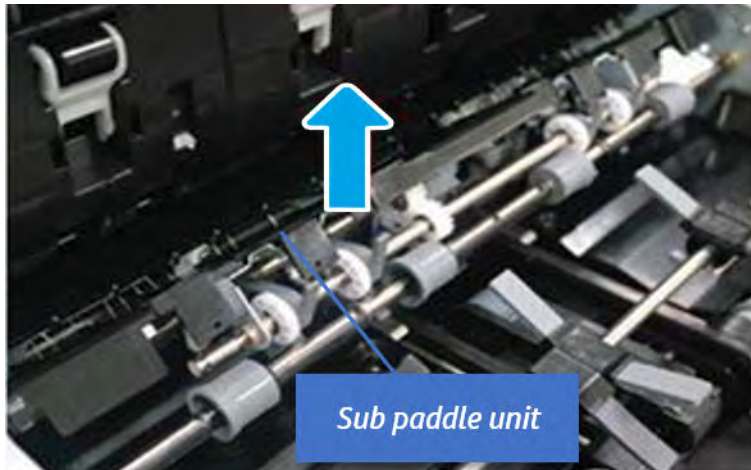
2. Remove the e-ring, and then remove the pulley and timing belt. And then remove the e-ring and the bushing.

Figure 6-394 Remove the e-ring, pulley, timing belt, and bushing



3. Lift up and remove the sub paddle unit.

**Figure 6-395** Remove the sub paddle unit

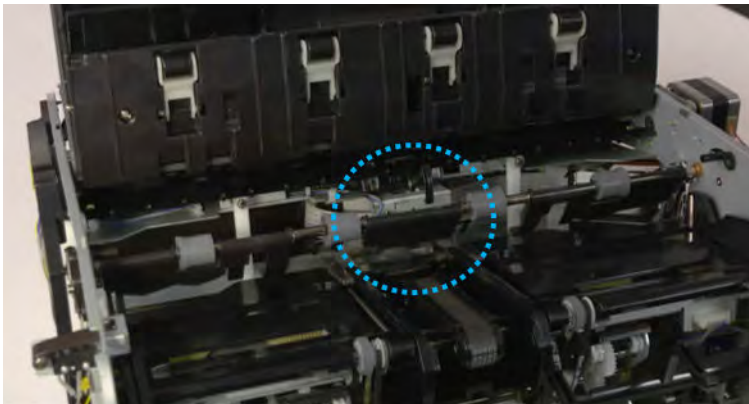


### Remove the exit roller

Follow these steps to remove the exit roller.

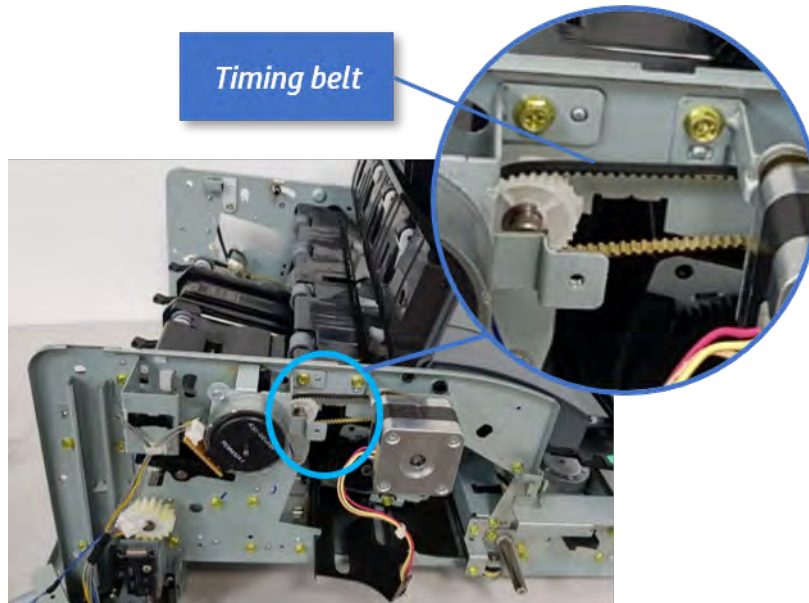
1. Remove the guide on the center of the exit roller.

**Figure 6-396** Remove the guide



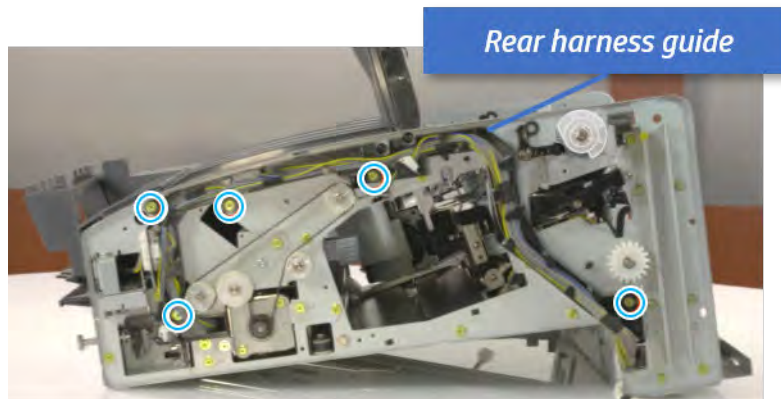
2. On the front of the inner finisher, release the timing belt connected to the exit motor.

Figure 6-397 Release the timing belt



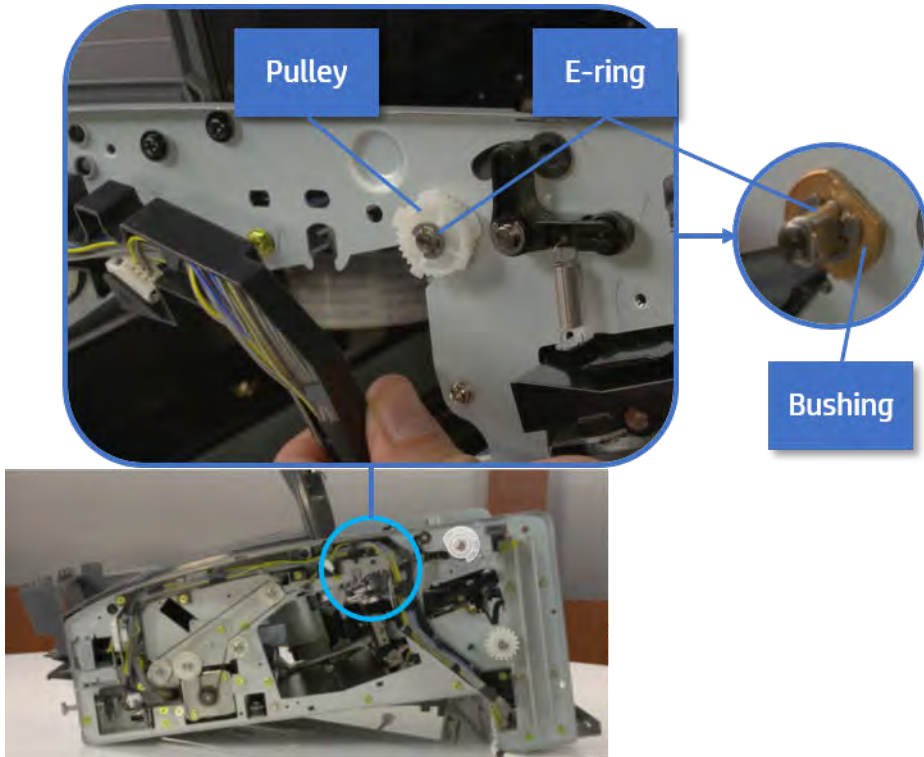
3. Remove five screws securing the rear harness guide.

Figure 6-398 Remove five screws



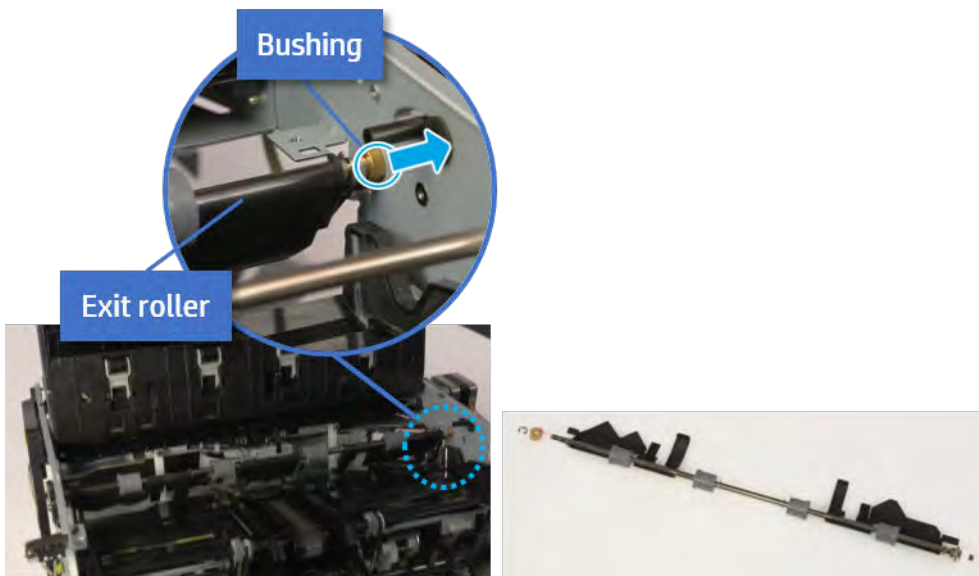
4. On the rear of the inner finisher, remove the e-ring and the pulley and then remove the e-ring and the bushing.

Figure 6-399 Remove e-ring, pulley, and bushing



5. Push the bushing to detach it, and then remove the exit roller.


Figure 6-400 Remove the exit roller



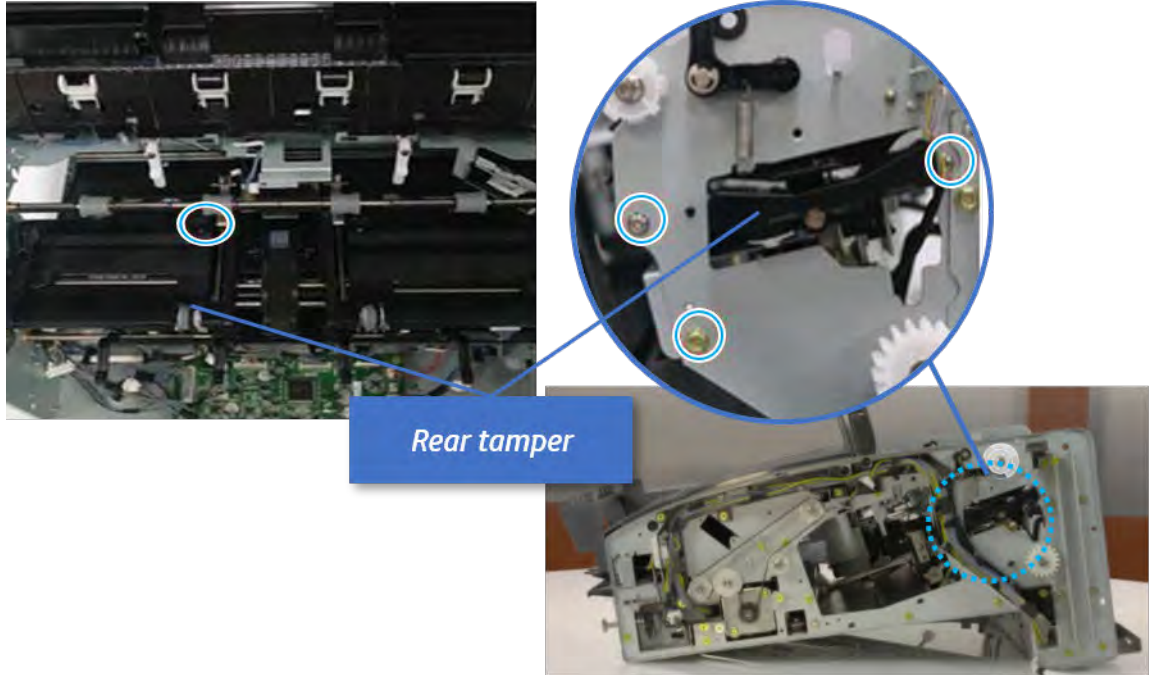
### Remove the rear tamper

Follow these steps to remove the rear tamper.

1. Remove four screws.

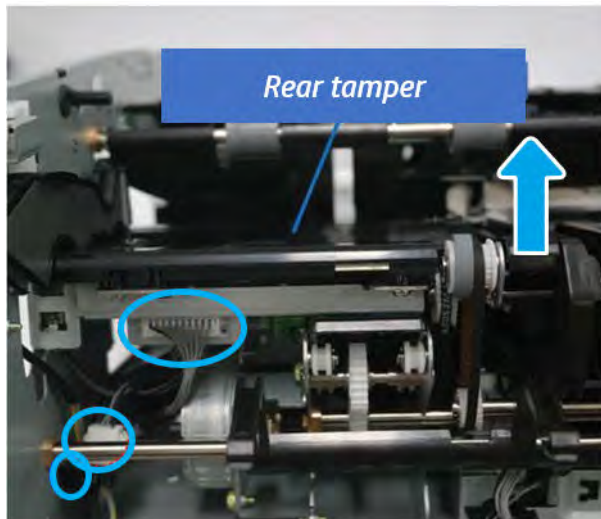
 **NOTE:** Move cable guideout of position to access the screws.

**Figure 6-401** Remove four screws



2. Unplug two connectors and release the hook, and then remove the rear tamper.

**Figure 6-402** Remove the rear tamper



### Unpack the replacement assembly

Follow these steps to unpack the replacement assembly.

1. Dispose of the defective part.



---


 **NOTE:** HP recommends responsible disposal of the defective part.


<http://www8.hp.com/us/en/hp-information/environment/product-recycling.html>

---

2. Unpack the replacement part from the packaging.


 **CAUTION:**  Some parts are sensitive to electrostatic discharge (ESD). Always perform service work at an ESD-protected workstation or mat. If an ESD workstation or mat is not available, touch the sheet-metal chassis to provide a static ground before touching an ESD-sensitive assembly. Protect the ESD-sensitive assemblies by placing them in ESD pouches when they are out of the printer.

 **IMPORTANT:** Make sure that all of the shipping materials (for example shipping tape) are removed from the replacement part prior to installation.

 **NOTE:** If the replacement part is a roller or pad, avoid touching the spongy part of it. Skin oils on the roller or pad can cause paper pickup and/or print-quality problems. HP recommends using disposable gloves when handling rollers or pads or washing your hands before touching rollers or pads.

---

3. To install an assembly, reverse the removal steps.

 **NOTE:** When applicable, special installation instructions are provided for an assembly at the end of the removal procedure. Always completely read the removal instructions and follow all special installation instructions.

---


## Removal and replacement: Rear tamper home sensor (S14)

Learn how to remove and replace the rear tamper home sensor.

To view teardown and reassembling video of the inner finisher, click the link below.

 [View a teardown video of the inner finisher.](#)

 [View a reassembling video of the inner finisher.](#)

 **IMPORTANT:** When applicable, special installation instructions are provided for an assembly at the end of the removal procedure. Always completely read the removal instructions and follow all special installation instructions.


Mean time to repair:

Service level:

### Before performing service

#### Turn the printer power off

- Press the power button on the front of the printer, and then turn off the power switch next to the power cable.
- A shutting-down message appears on the control-panel display.

 **WARNING!** To avoid damage to the printer, turn the power off and wait until the printer shuts down before removing the power cable.

- Disconnect the printer power cable after the printer has completely shut down (the control-panel display is blank).

Use the table below to identify the correct part number for your printer. To order the part, go to [www.hp.com/buy/parts](http://www.hp.com/buy/parts).

**Table 6-57 Part information**

Part number	Part description
0604-001393	Rear tamper home sensor

### Required tools

- #2 JIS screwdriver with a magnetic tip

### After performing service

#### Turn the printer power on

- Connect the power cable.
- Use the power switch to turn the power on.

### Post service test

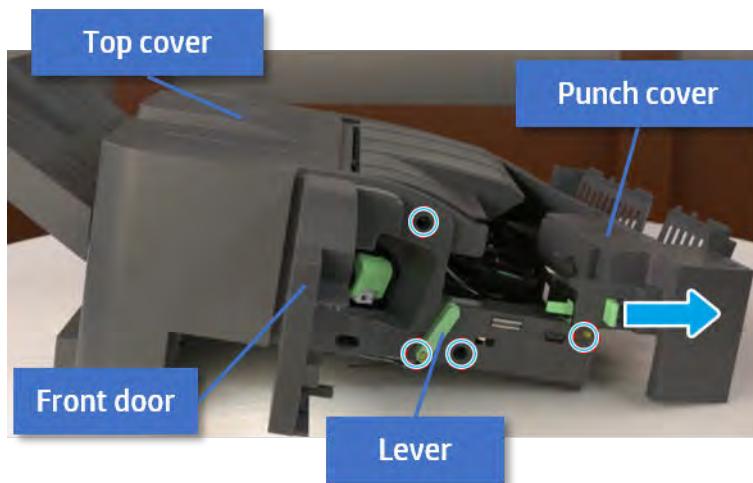
Print any pages necessary to verify that the repair resolved the issue and did not create any new issues.

## Remove the front cover

Follow these steps to remove the front cover.

1. Open the front door and open the punch cover.
2. Remove three screws in the front.
3. Remove the lever.
4. Open the top cover.
5. From the right side of the front cover, carefully lift and pry toward the top-left corner to remove the front cover.

Figure 6-403 Remove the front cover

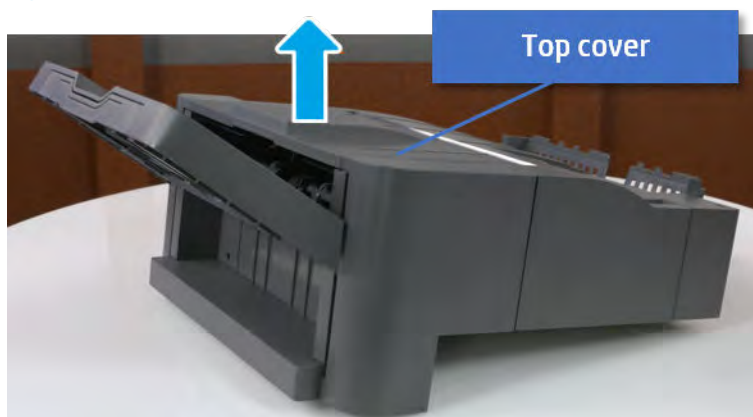


## Remove the rear cover

Follow these steps to remove the rear cover.

1. Open the top cover.

Figure 6-404 Open the top cover

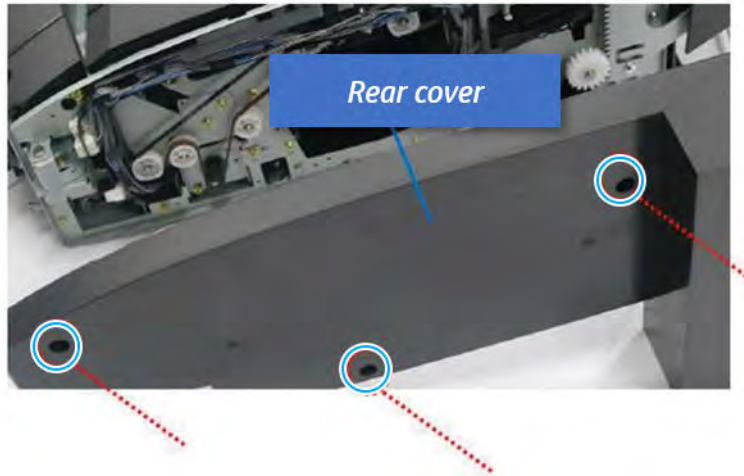


2. Remove three screws.



3. Release hooks carefully and remove the rear cover.

Figure 6-405 Remove the rear cover

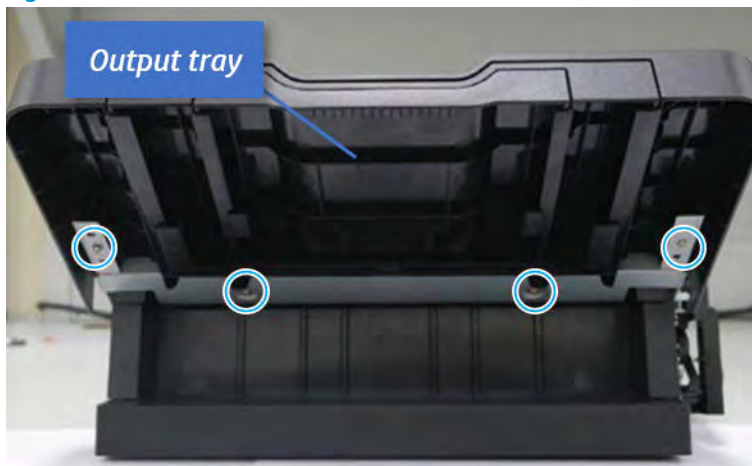


### Remove the output tray

Follow these steps to remove the output tray.

1. Remove four screws.

Figure 6-406 Remove four screws



2. Push the paper holding actuator into the inner finisher, and then remove the output tray.

Figure 6-407 Remove the output tray.

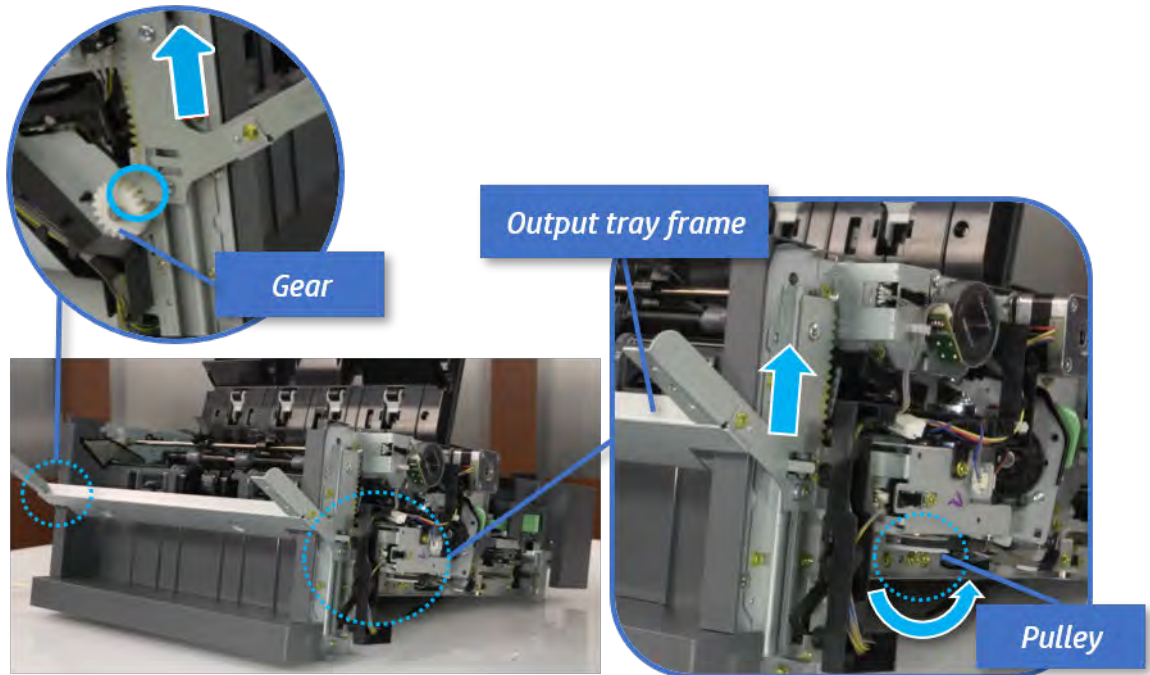


### Remove the output tray frame

Follow these steps to remove the output tray frame.

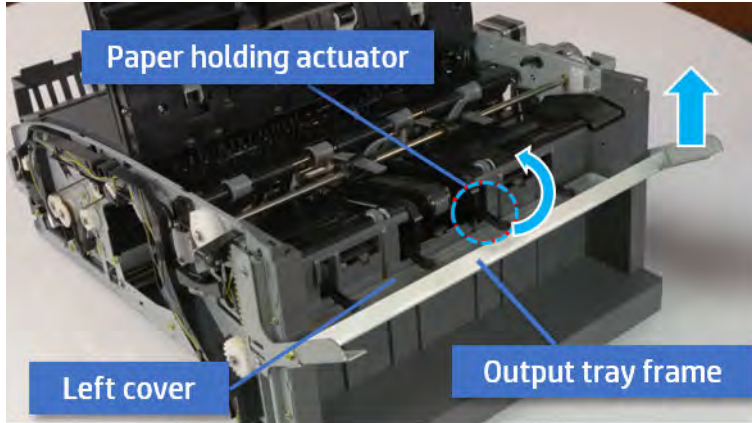
1. Rotate the pulley until the output tray frame depart from the gear.

Figure 6-408 Remove the pulley



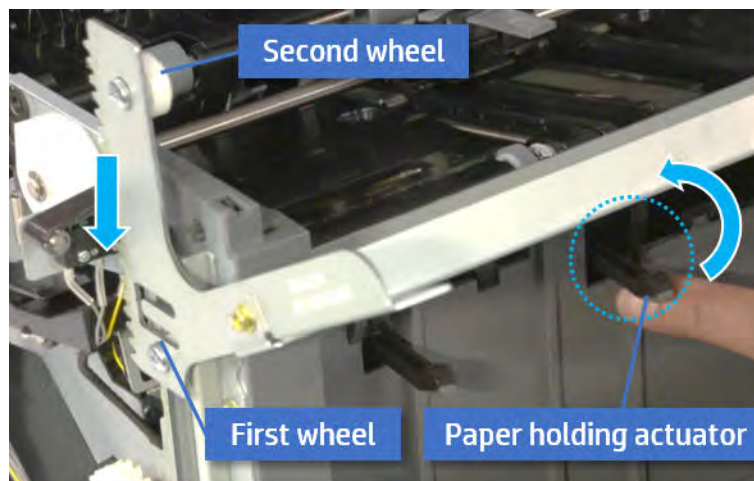
2. Push the paper holding actuator into the inner finisher, and then remove the output tray frame.

Figure 6-409 Remove the output tray frame

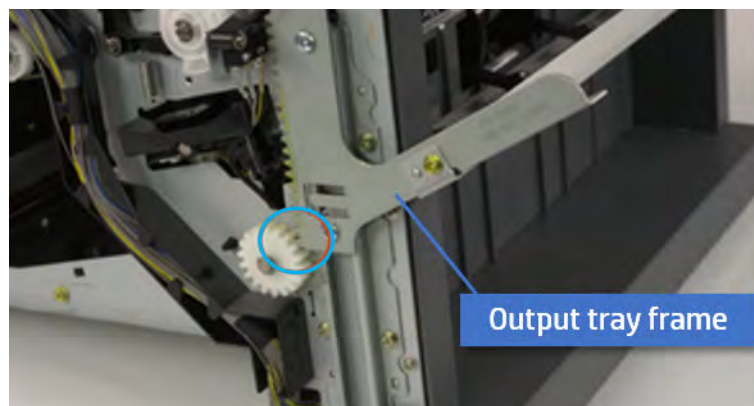


**TIP:** Push the paper holding actuator into the inner finisher when reassembling. Be sure to level the output tray.

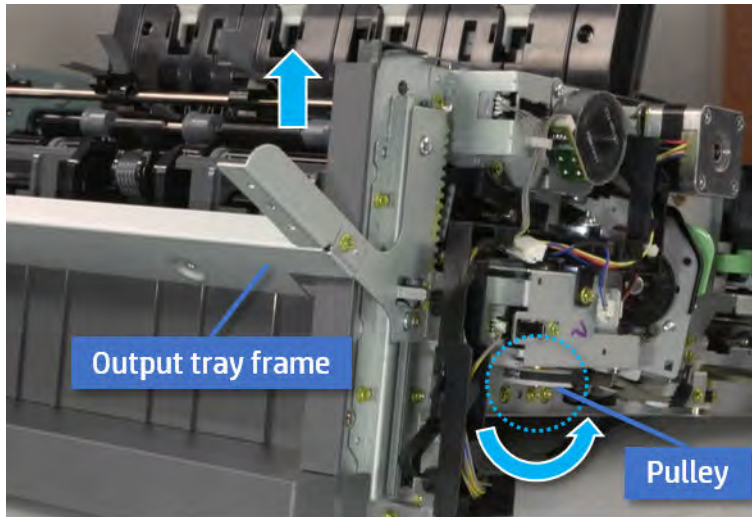
- a. Position the first wheel into the channel on both sides while pushing the paper holding actuator.



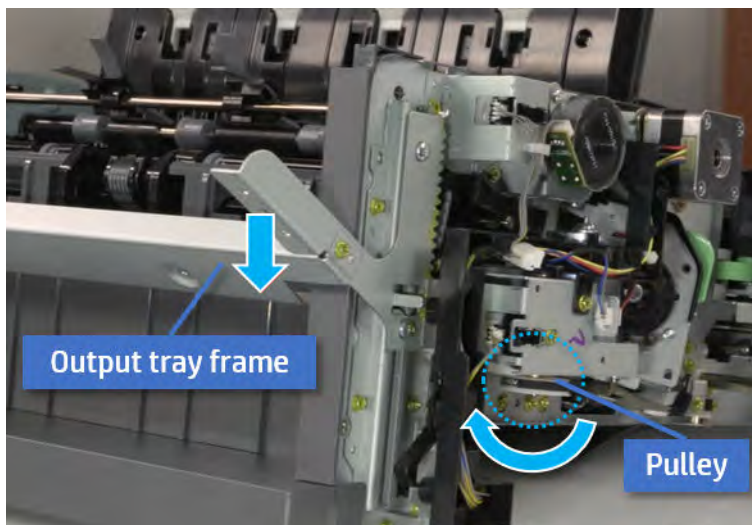
- b. Let the second wheel rest on the channel on both sides simultaneously.
- c. Gently squeeze the wheels into channel until the output tray frame meet the gear.



- d. Rotate the pulley until the output tray frame is no longer lifted. It can make to level the output tray frame.



- e. Rotate the pulley in the opposite direction.

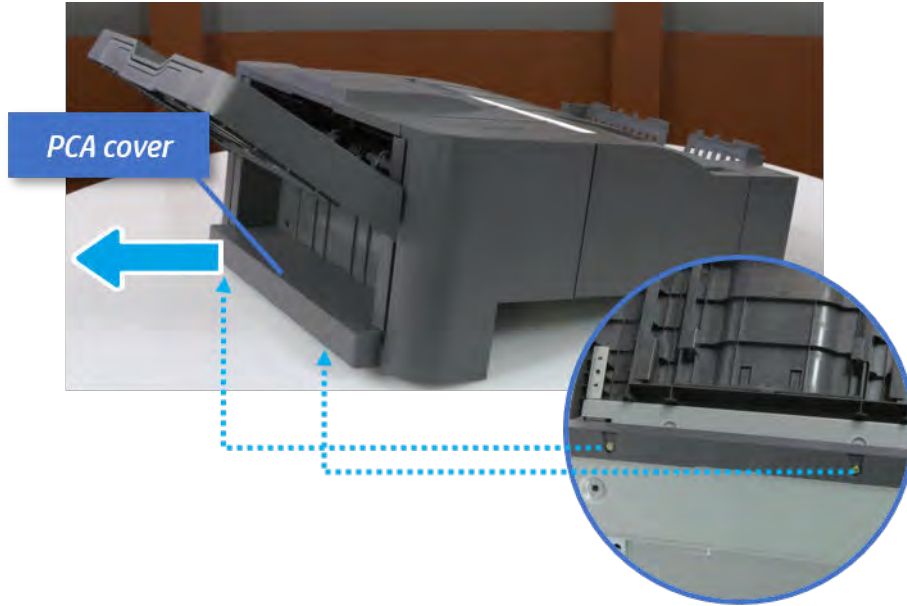


### Remove the PCA cover

Follow these steps to remove the PCA cover.

- ▲ Remove two screws, and then remove the PCA cover.

Figure 6-410 Remove the PCA cover

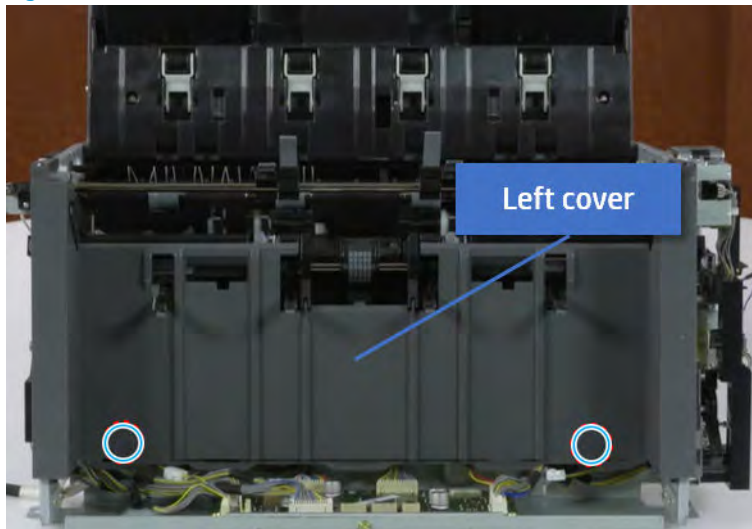


### Remove the left cover

Follow these steps to remove the left cover.

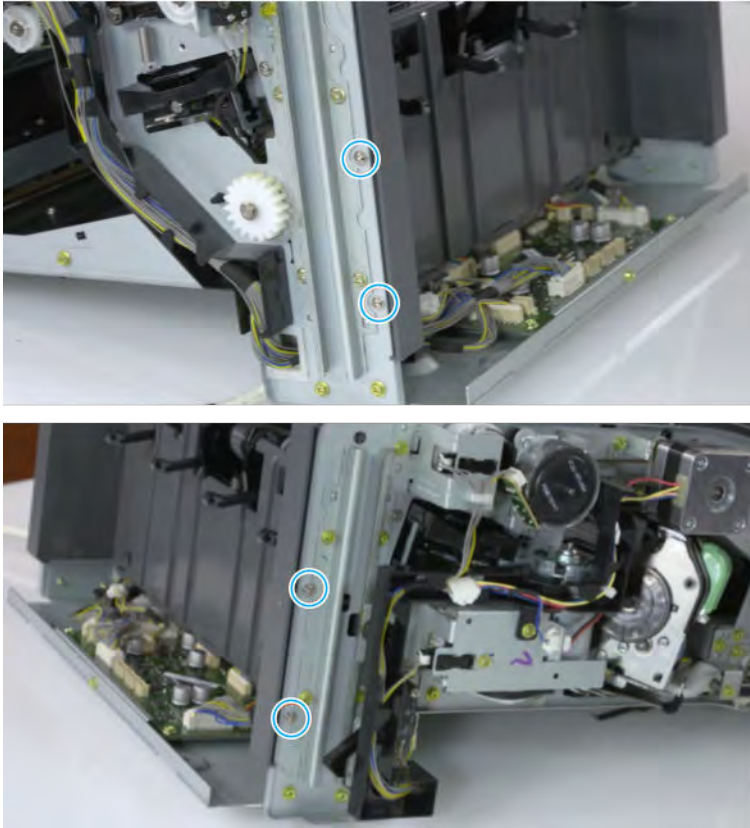
1. Remove two screws.

Figure 6-411 Remove two screws



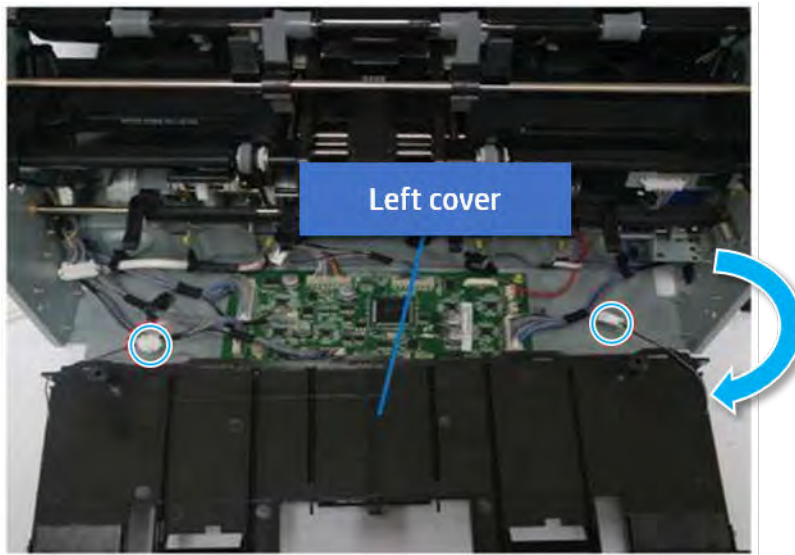
2. Remove four screws from both front and rear sides.


Figure 6-412 Remove four screws

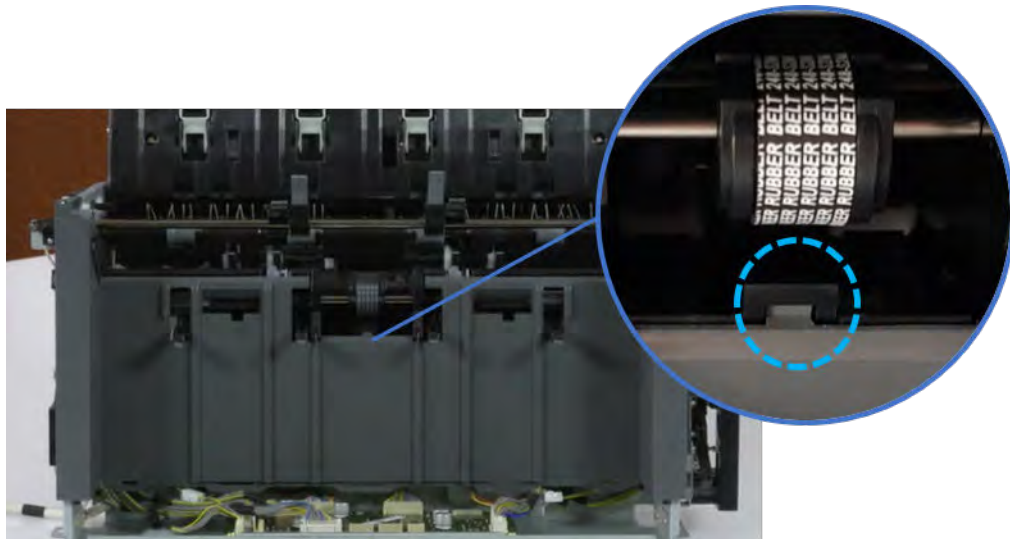


3. Unplug two inline connectors, and then remove the left cover.

Figure 6-413 Unplug two connectors



 **TIP:** Be sure to check the hook when reassembling.



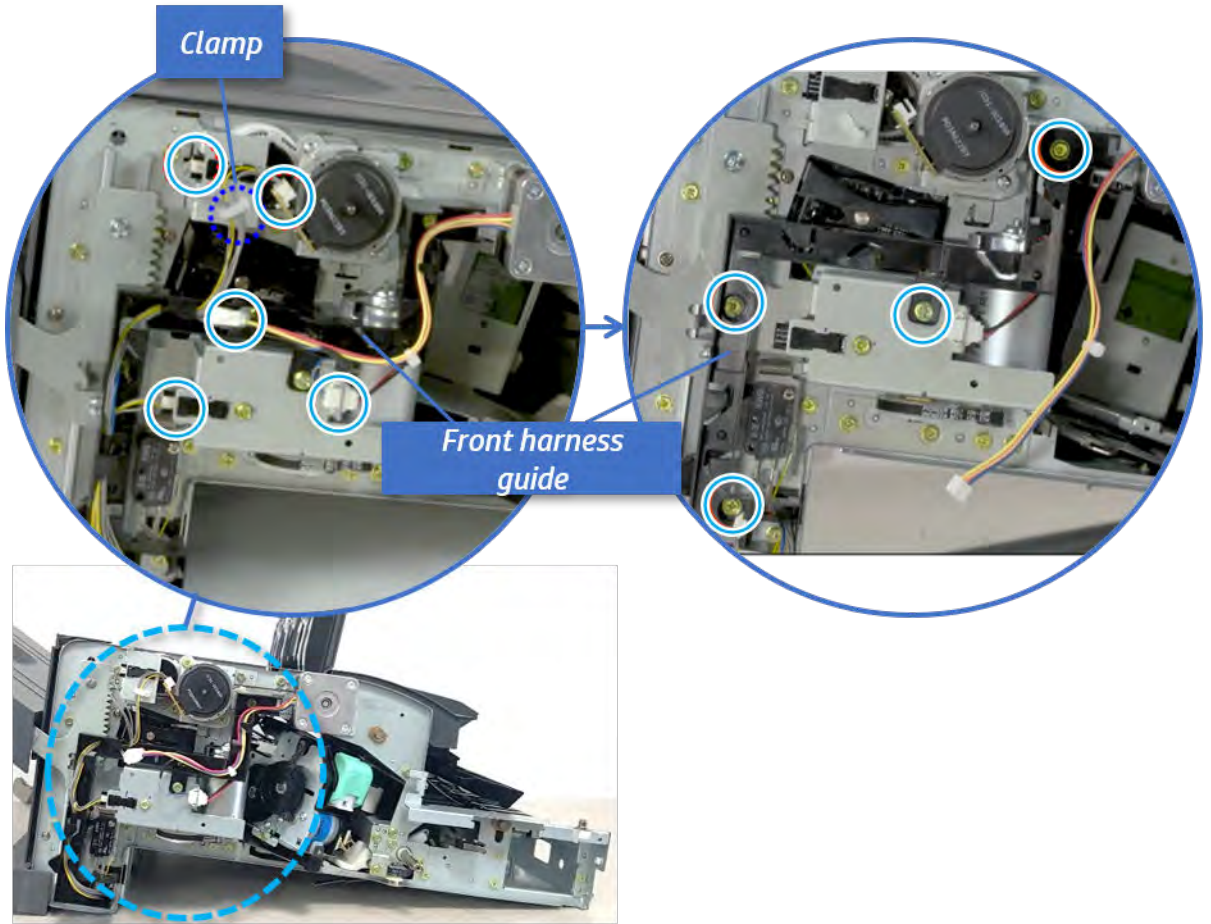
### Remove the front harness guide

Follow these steps to remove the front harness guide.

1. Open one clamp and unplug five connectors, and then remove the wire harness from the front harness guide.

2. Remove four screws, and then remove the front harness guide.

Figure 6-414 Remove the front harness guide

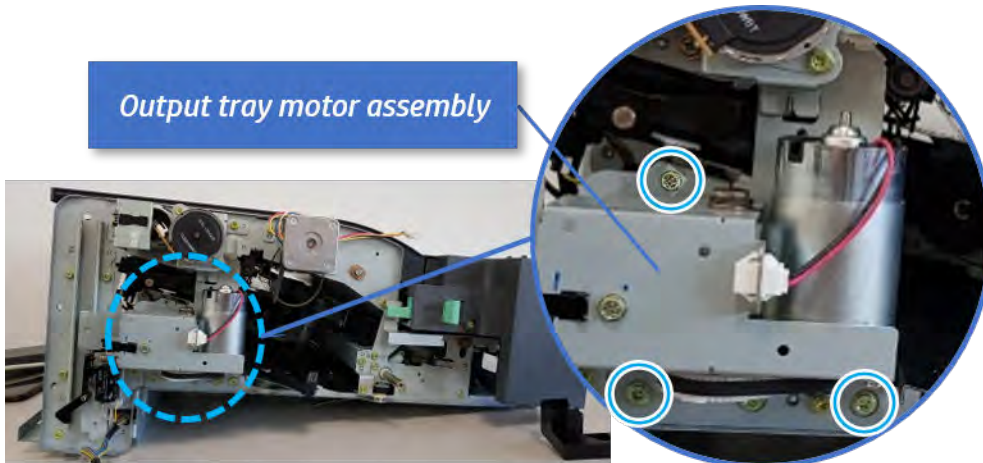


### Remove the output tray motor assembly

Follow these steps to remove the output tray motor assembly.

- ▲ Remove three screws, and then remove the output tray motor assembly.

Figure 6-415 Remove the output tray motor assembly



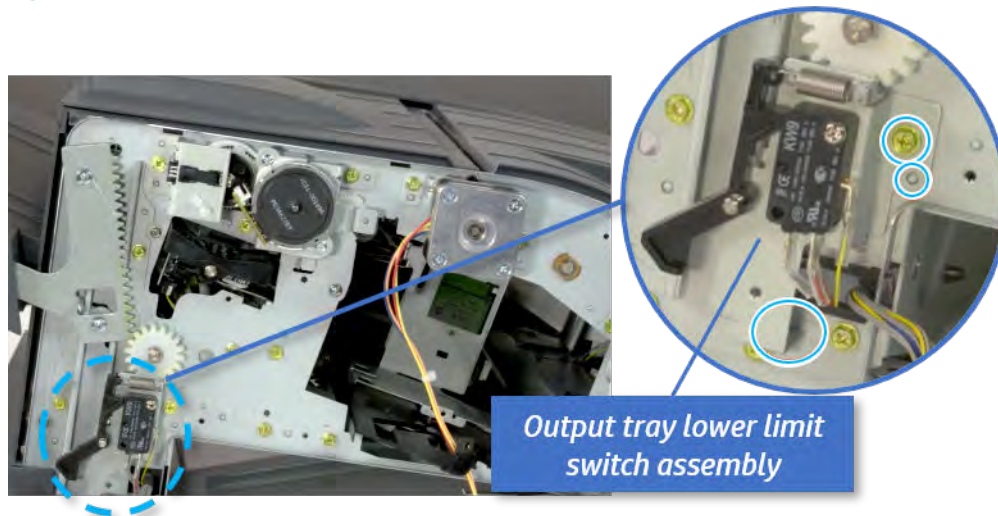


## Remove the output tray lower limit switch

Follow these steps to remove the output tray lower limit switch.

- ▲ Remove one screw, and then remove the output tray lower limit switch.

Figure 6-416 Remove the output tray lower limit switch

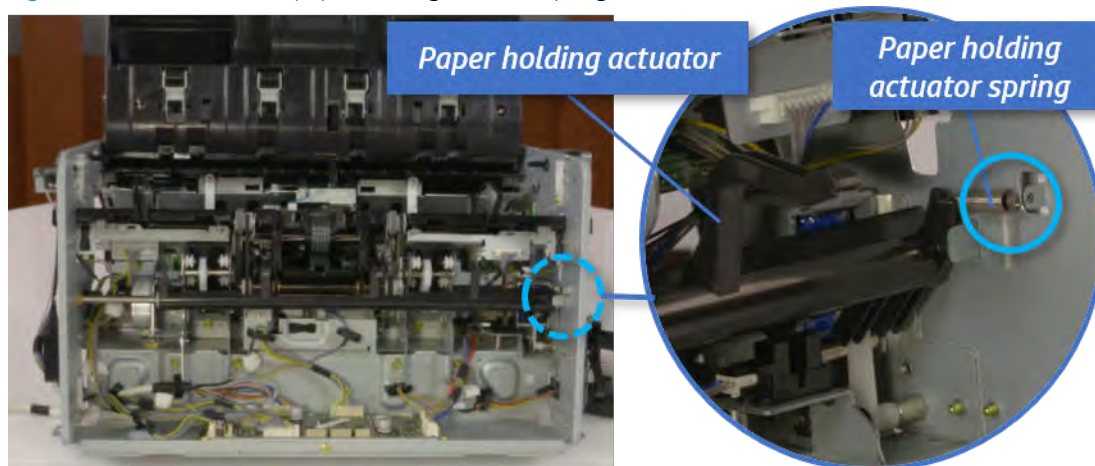


## Remove the paper holding

Follow these steps to remove the paper holding.

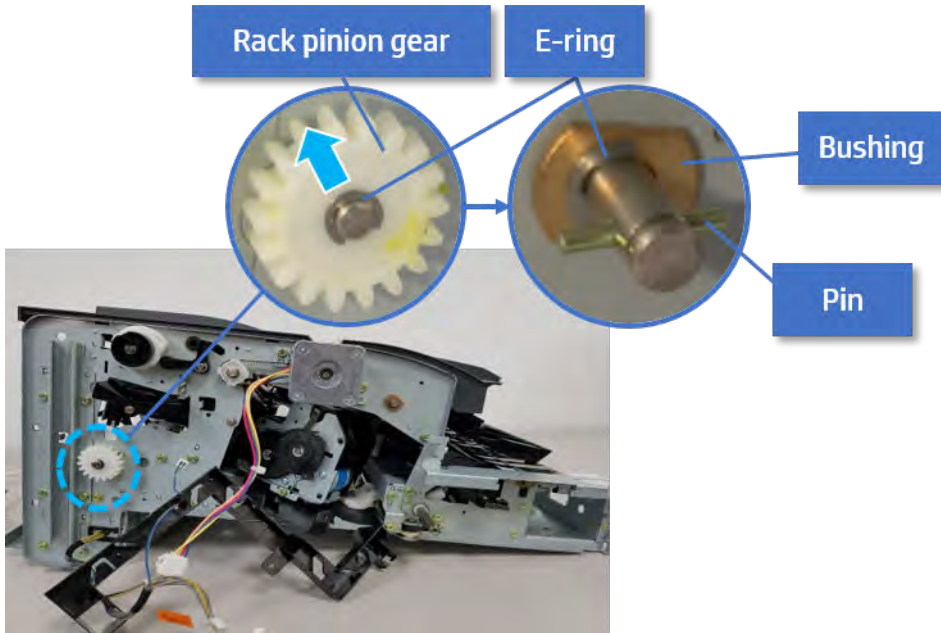
1. Remove the paper holding actuator spring.


Figure 6-417 Remove the paper holding actuator spring



2. Remove the e-ring and the rack pinion gear. And then remove the pin and the e-ring, and then remove the bushing.

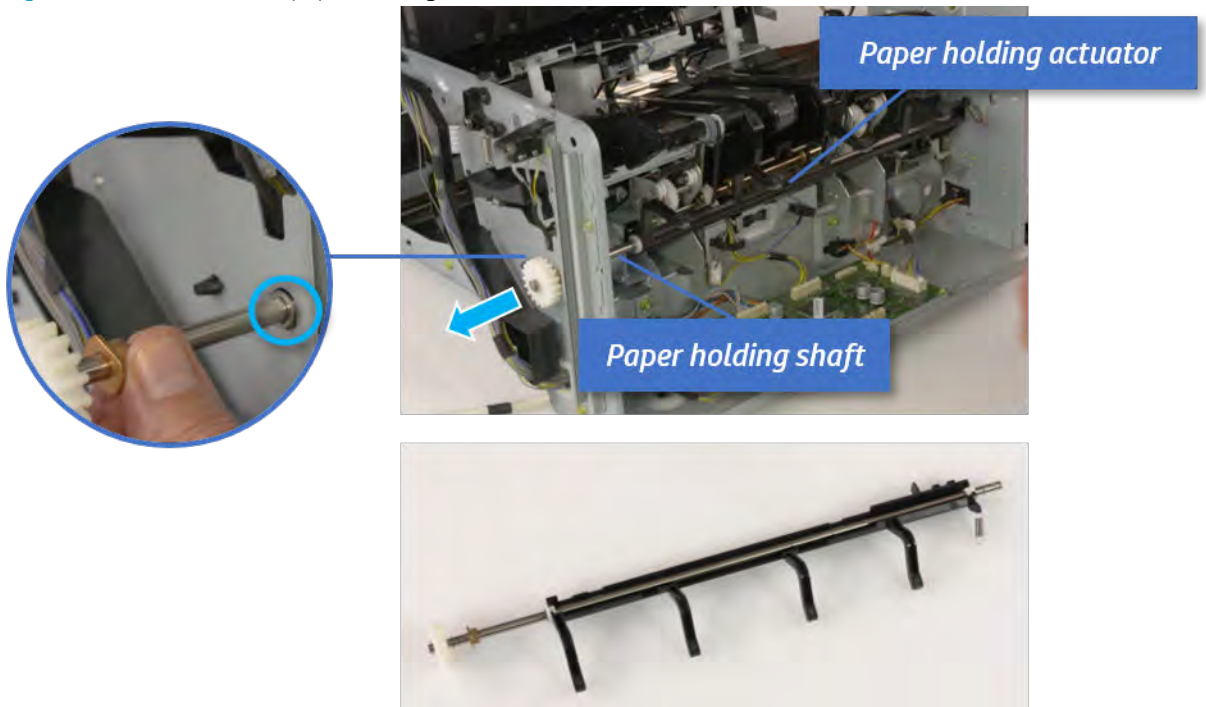
**Figure 6-418** Remove e-ring, rack pinion gear, pin, and bushing



 **NOTE:** Be sure not to lose the pin.

3. Carefully remove the paper holding shaft and the actuator.

**Figure 6-419** Remove the paper holding shaft and the actuator

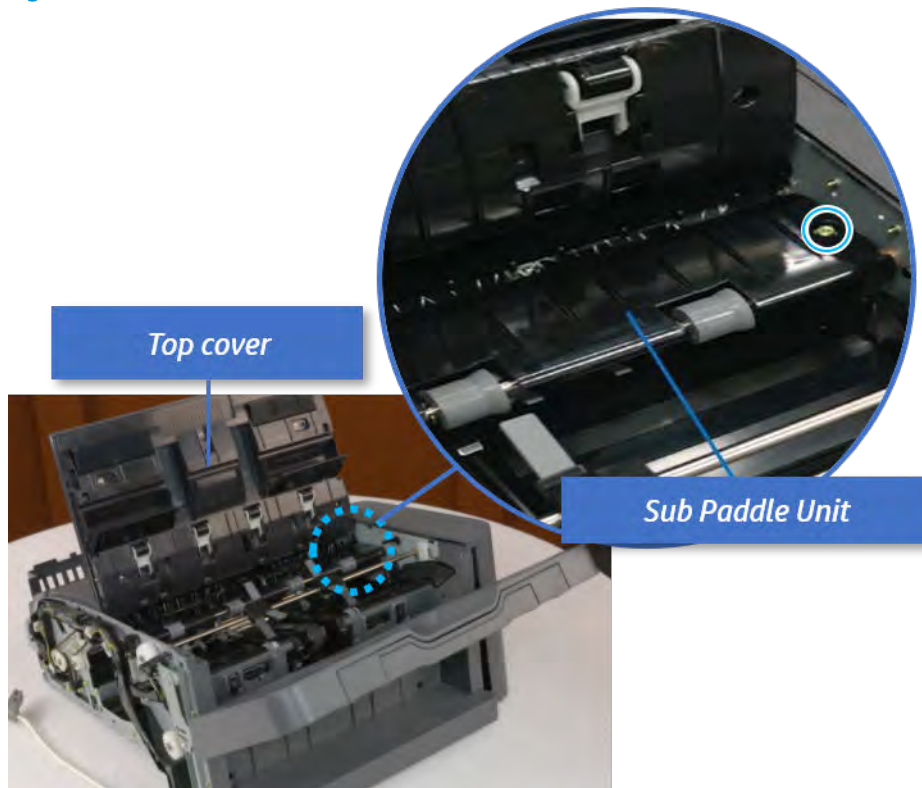


### Remove the sub paddle unit

Follow these steps to remove the sub paddle unit.

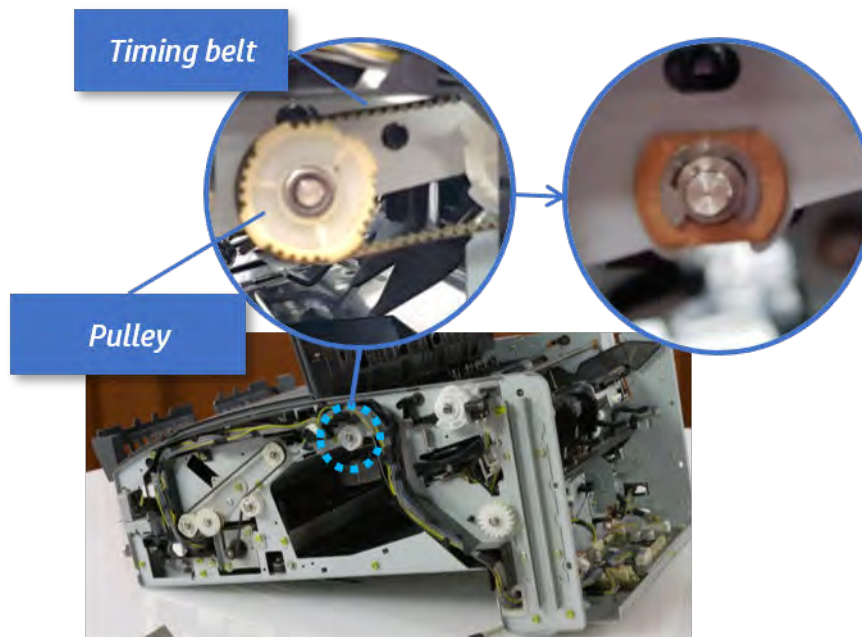
1. Open the top cover, and then remove one screw securing the sub paddle unit.

Figure 6-420 Remove one screw



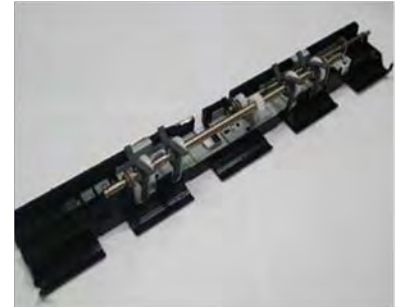
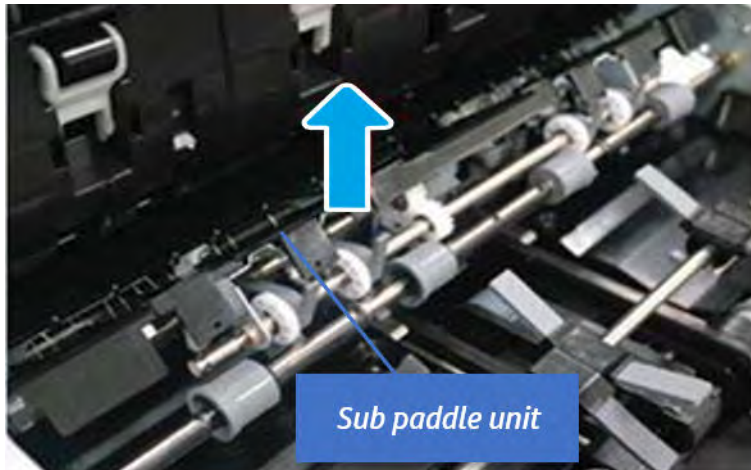
2. Remove the e-ring, and then remove the pulley and timing belt. And then remove the e-ring and the bushing.

Figure 6-421 Remove the e-ring, pulley, timing belt, and bushing



3. Lift up and remove the sub paddle unit.

Figure 6-422 Remove the sub paddle unit

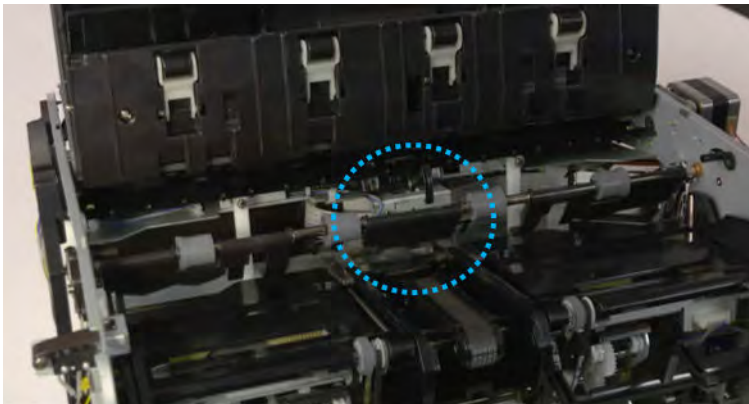


### Remove the exit roller

Follow these steps to remove the exit roller.

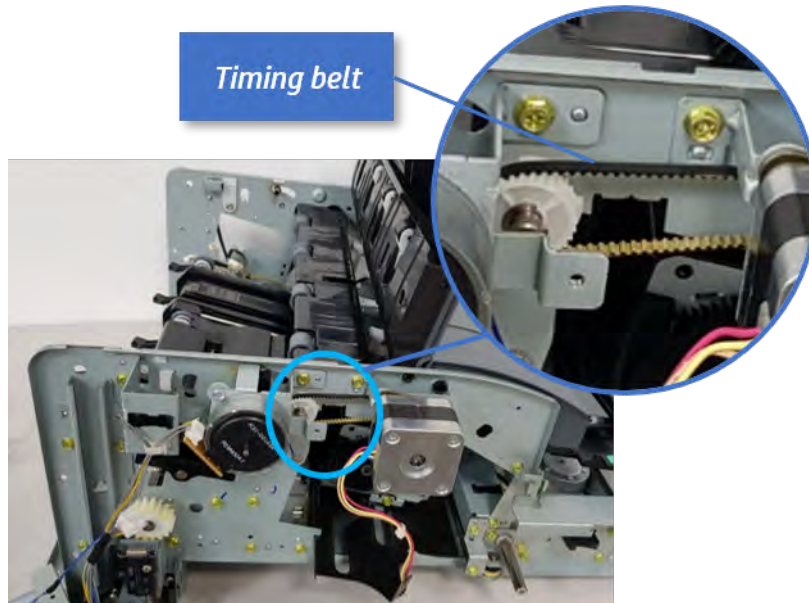
1. Remove the guide on the center of the exit roller.

Figure 6-423 Remove the guide



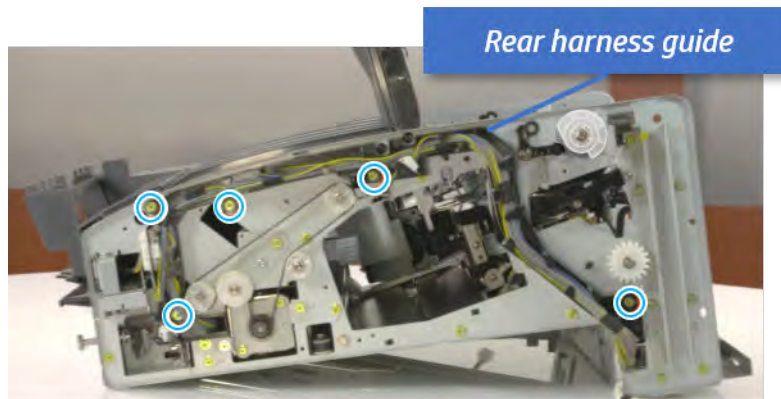
2. On the front of the inner finisher, release the timing belt connected to the exit motor.

Figure 6-424 Release the timing belt



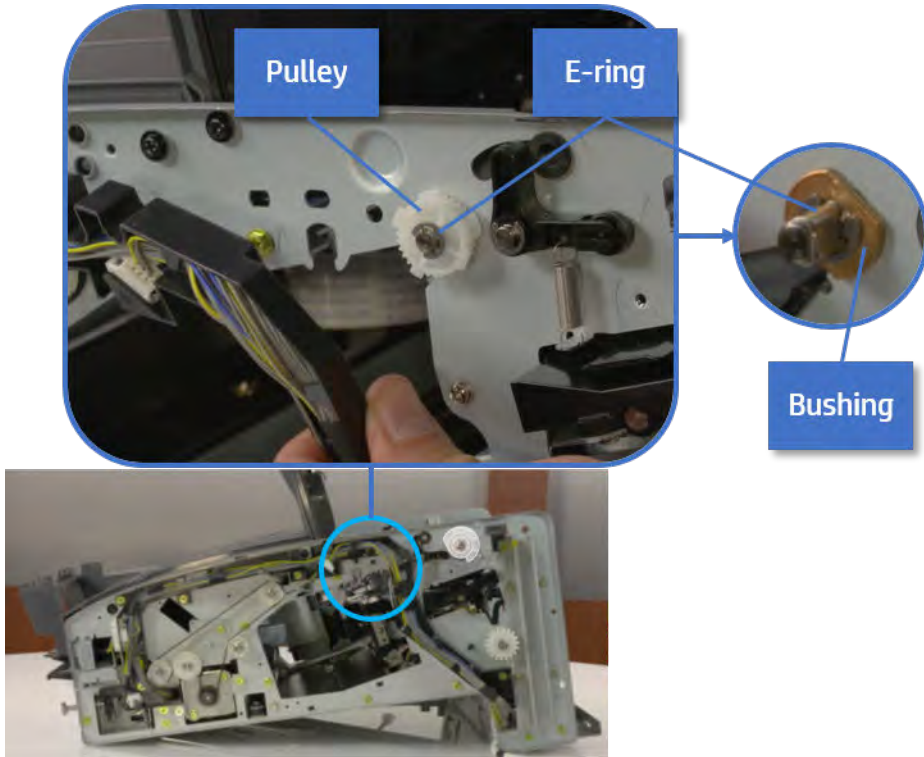
3. Remove five screws securing the rear harness guide.

Figure 6-425 Remove five screws



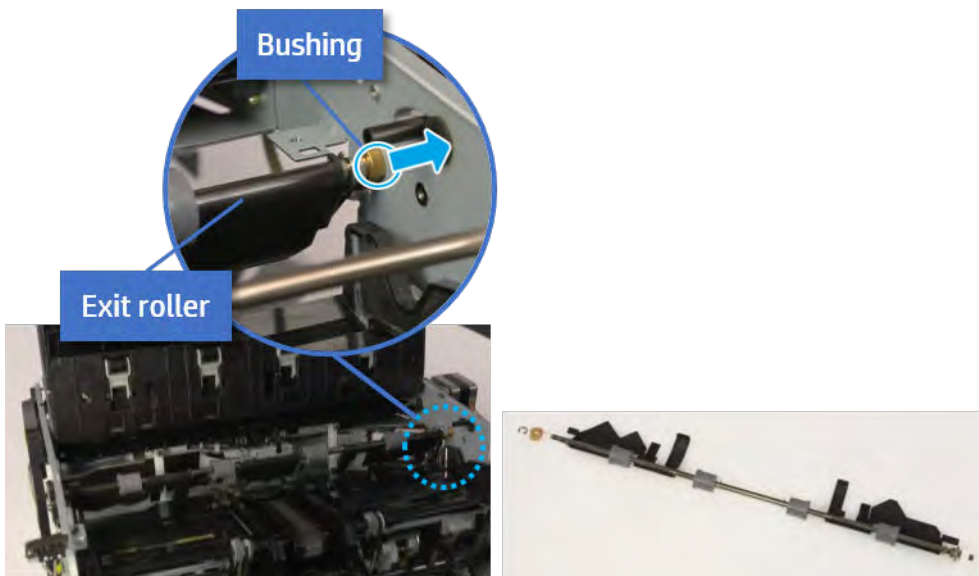
4. On the rear of the inner finisher, remove the e-ring and the pulley and then remove the e-ring and the bushing.

Figure 6-426 Remove e-ring, pulley, and bushing



5. Push the bushing to detach it, and then remove the exit roller.


Figure 6-427 Remove the exit roller



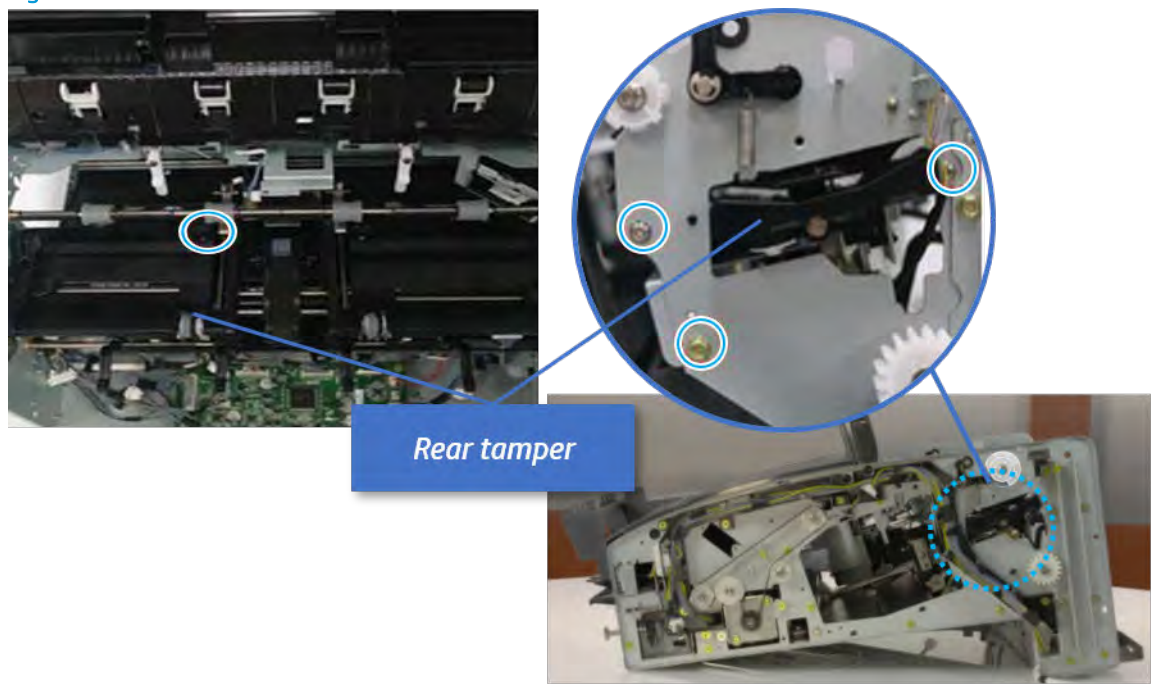
### Remove the rear tamper

Follow these steps to remove the rear tamper.

1. Remove four screws.

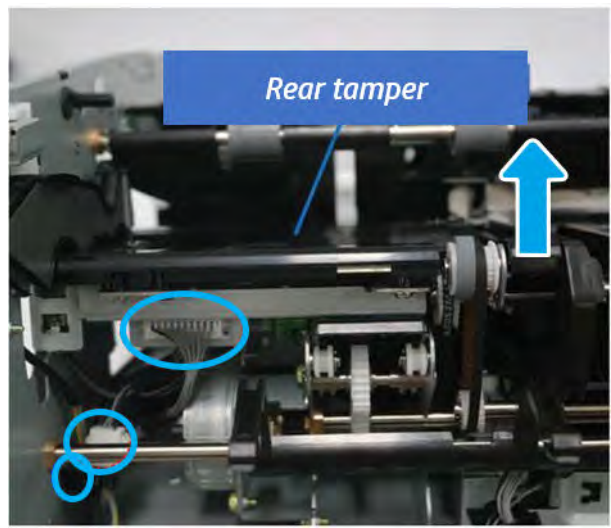
 **NOTE:** Move cable guideout of position to access the screws.

**Figure 6-428** Remove four screws



2. Unplug two connectors and release the hook, and then remove the rear tamper.

**Figure 6-429** Remove the rear tamper

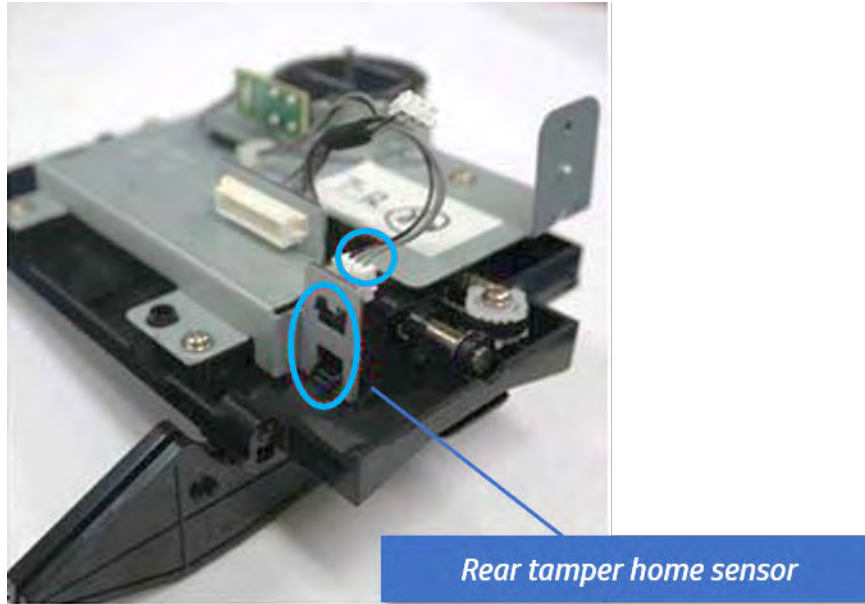


### Remove the rear tamper home sensor

Follow these steps to remove the rear tamper home sensor.

- ▲ Unplug the connector, and then remove the rear tamper home sensor.

Figure 6-430 Remove the rear tamper home sensor



### Unpack the replacement assembly



Follow these steps to unpack the replacement assembly.


1. Dispose of the defective part.


 **NOTE:** HP recommends responsible disposal of the defective part.

<http://www8.hp.com/us/en/hp-information/environment/product-recycling.html>


2. Unpack the replacement part from the packaging.

 **CAUTION:**  Some parts are sensitive to electrostatic discharge (ESD). Always perform service work at an ESD-protected workstation or mat. If an ESD workstation or mat is not available, touch the sheet-metal chassis to provide a static ground before touching an ESD-sensitive assembly. Protect the ESD-sensitive assemblies by placing them in ESD pouches when they are out of the printer.

 **IMPORTANT:** Make sure that all of the shipping materials (for example shipping tape) are removed from the replacement part prior to installation.

 **NOTE:** If the replacement part is a roller or pad, avoid touching the spongy part of it. Skin oils on the roller or pad can cause paper pickup and/or print-quality problems. HP recommends using disposable gloves when handling rollers or pads or washing your hands before touching rollers or pads.

3. To install an assembly, reverse the removal steps.

 **NOTE:** When applicable, special installation instructions are provided for an assembly at the end of the removal procedure. Always completely read the removal instructions and follow all special installation instructions.




## Removal and replacement: Rear tamper motor (M5)

Learn how to remove and replace the rear tamper motor.

To view teardown and reassembling video of the inner finisher, click the link below.

 [View a teardown video of the inner finisher.](#)

 [View a reassembling video of the inner finisher.](#)

 **IMPORTANT:** When applicable, special installation instructions are provided for an assembly at the end of the removal procedure. Always completely read the removal instructions and follow all special installation instructions.

Mean time to repair:

Service level:

### Before performing service

#### Turn the printer power off

- Press the power button on the front of the printer, and then turn off the power switch next to the power cable.
- A shutting-down message appears on the control-panel display.

 **WARNING!** To avoid damage to the printer, turn the power off and wait until the printer shuts down before removing the power cable.

- Disconnect the printer power cable after the printer has completely shut down (the control-panel display is blank).

Use the table below to identify the correct part number for your printer. To order the part, go to [www.hp.com/buy/parts](http://www.hp.com/buy/parts).

**Table 6-58 Part information**

Part number	Part description
JC93-01001A	Rear tamper motor assembly

### Required tools

- #2 JIS screwdriver with a magnetic tip

### After performing service

#### Turn the printer power on

- Connect the power cable.
- Use the power switch to turn the power on.

### Post service test

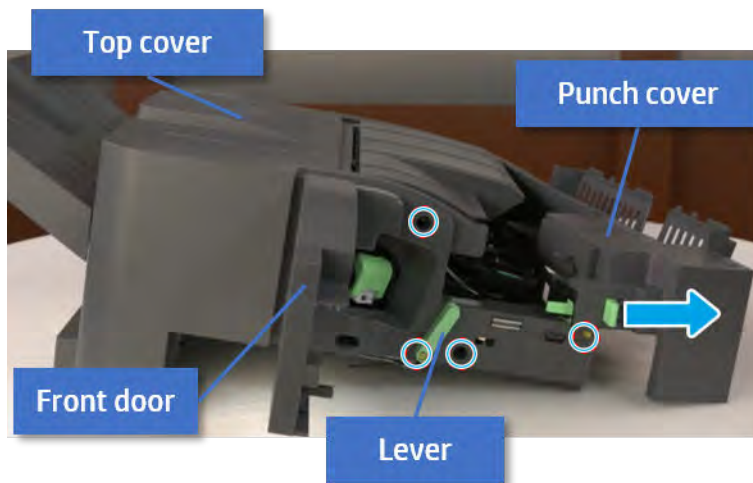
Print any pages necessary to verify that the repair resolved the issue and did not create any new issues.

## Remove the front cover

Follow these steps to remove the front cover.

1. Open the front door and open the punch cover.
2. Remove three screws in the front.
3. Remove the lever.
4. Open the top cover.
5. From the right side of the front cover, carefully lift and pry toward the top-left corner to remove the front cover.

Figure 6-431 Remove the front cover

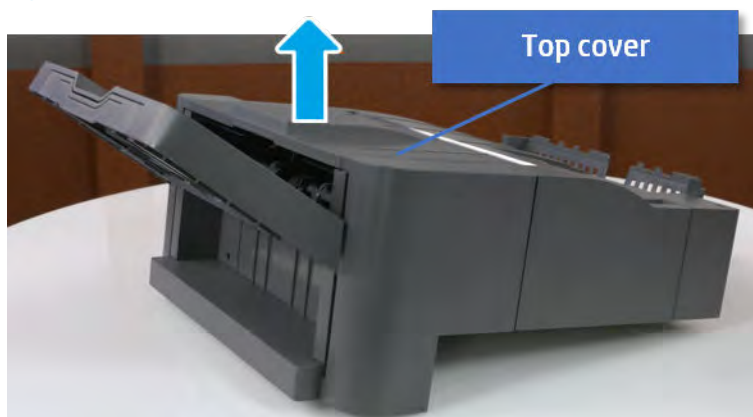


## Remove the rear cover

Follow these steps to remove the rear cover.

1. Open the top cover.

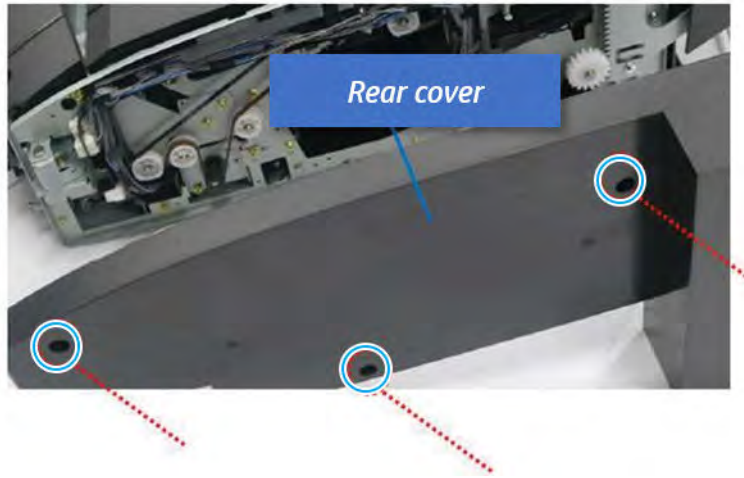
Figure 6-432 Open the top cover



2. Remove three screws.

3. Release hooks carefully and remove the rear cover.

Figure 6-433 Remove the rear cover

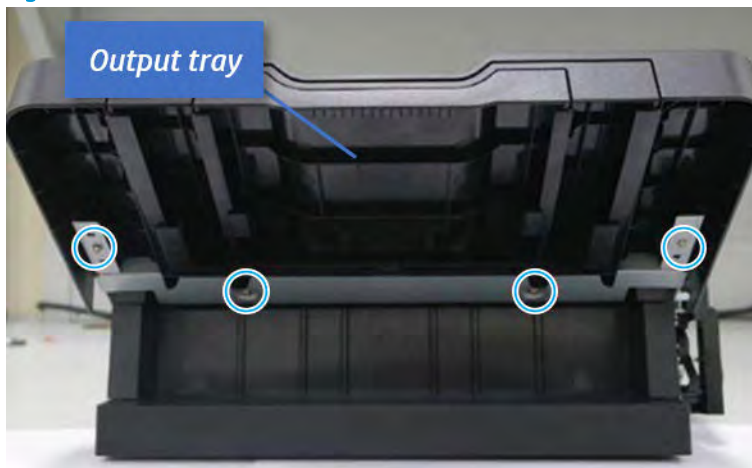


### Remove the output tray

Follow these steps to remove the output tray.

1. Remove four screws.

Figure 6-434 Remove four screws



2. Push the paper holding actuator into the inner finisher, and then remove the output tray.

Figure 6-435 Remove the output tray.

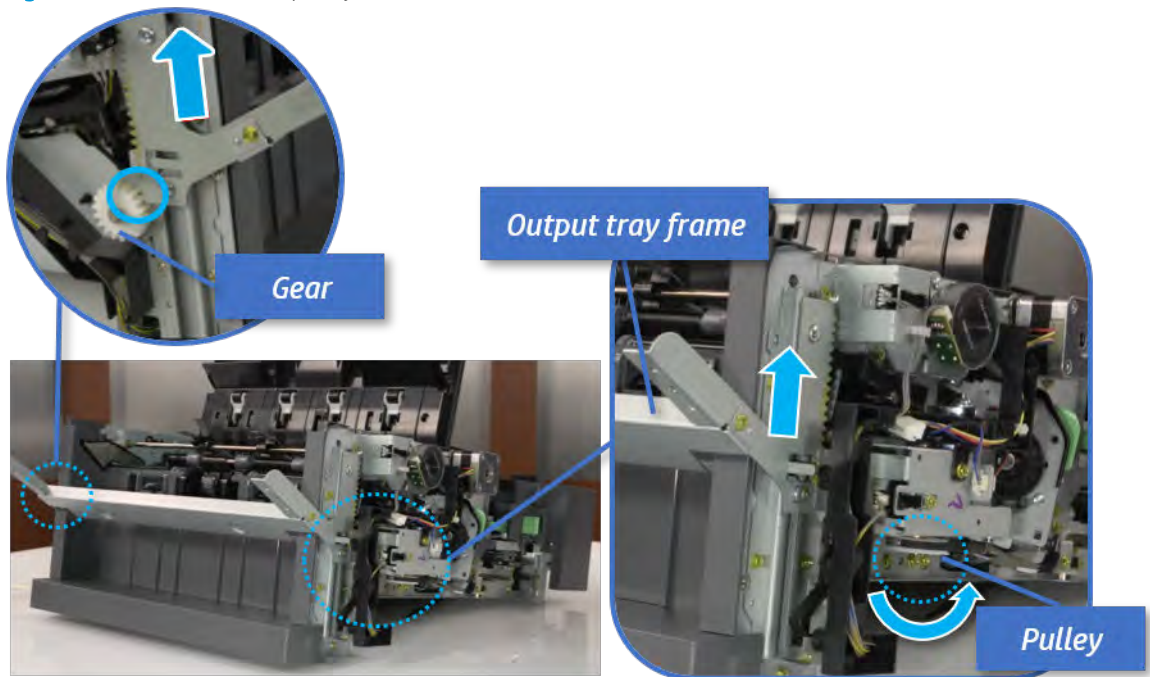


### Remove the output tray frame

Follow these steps to remove the output tray frame.

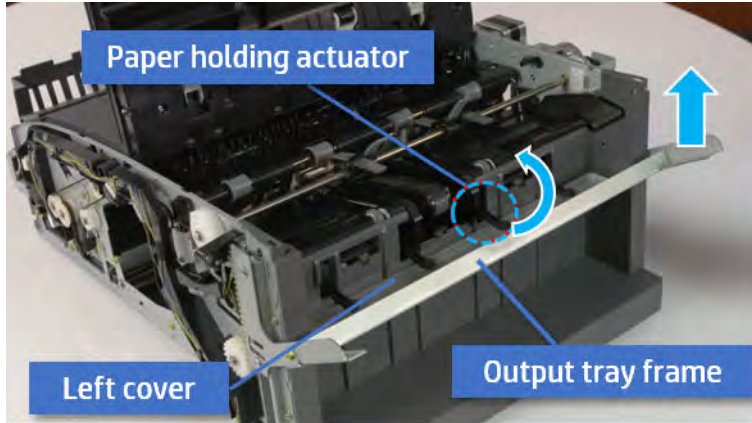
1. Rotate the pulley until the output tray frame depart from the gear.

Figure 6-436 Remove the pulley



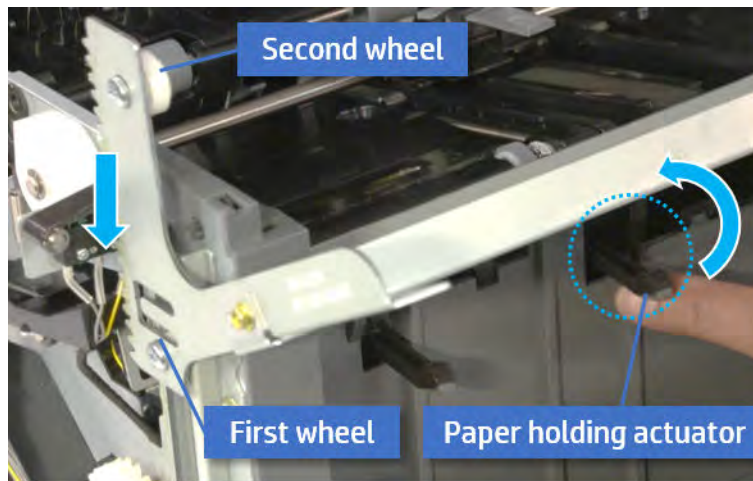
2. Push the paper holding actuator into the inner finisher, and then remove the output tray frame.

Figure 6-437 Remove the output tray frame

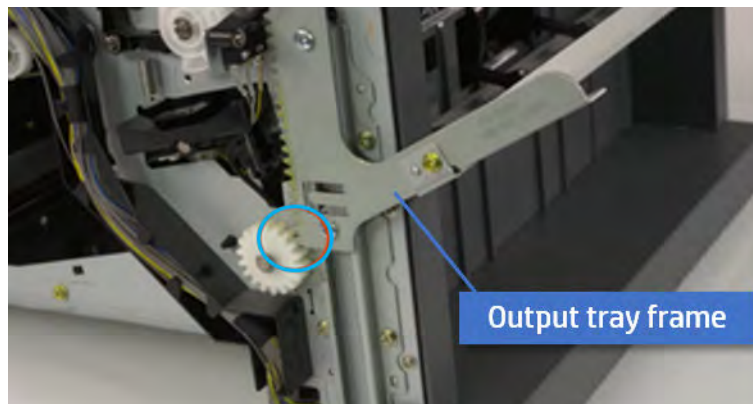


**TIP:** Push the paper holding actuator into the inner finisher when reassembling. Be sure to level the output tray.

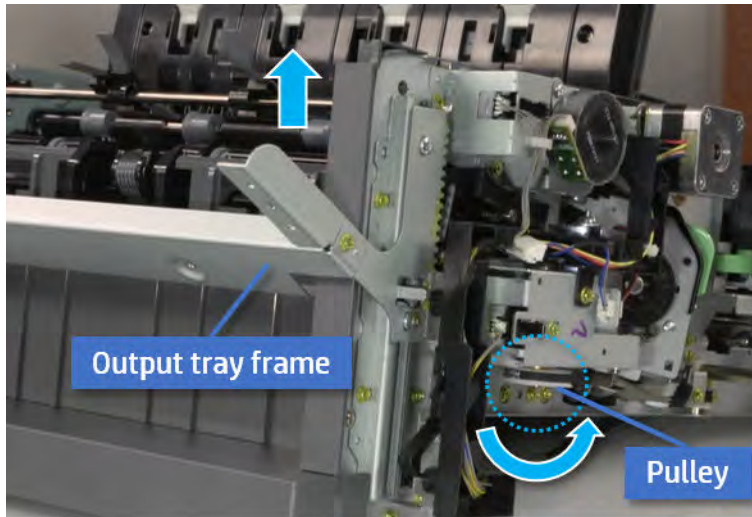
- a. Position the first wheel into the channel on both sides while pushing the paper holding actuator.



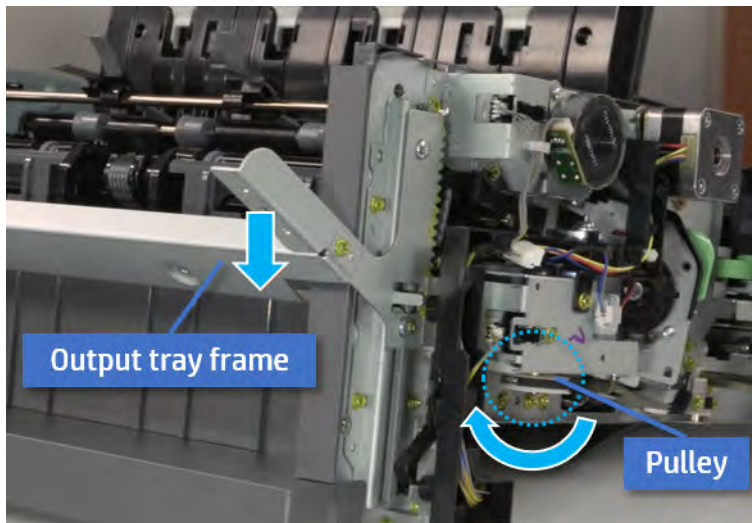
- b. Let the second wheel rest on the channel on both sides simultaneously.
- c. Gently squeeze the wheels into channel until the output tray frame meet the gear.



- d. Rotate the pulley until the output tray frame is no longer lifted. It can make to level the output tray frame.



- e. Rotate the pulley in the opposite direction.

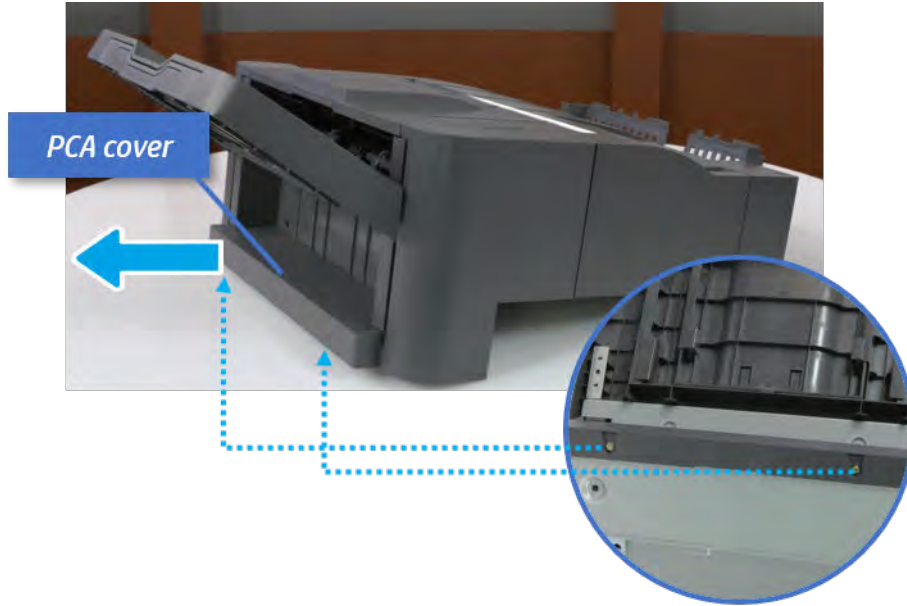


### Remove the PCA cover

Follow these steps to remove the PCA cover.

- ▲ Remove two screws, and then remove the PCA cover.

Figure 6-438 Remove the PCA cover

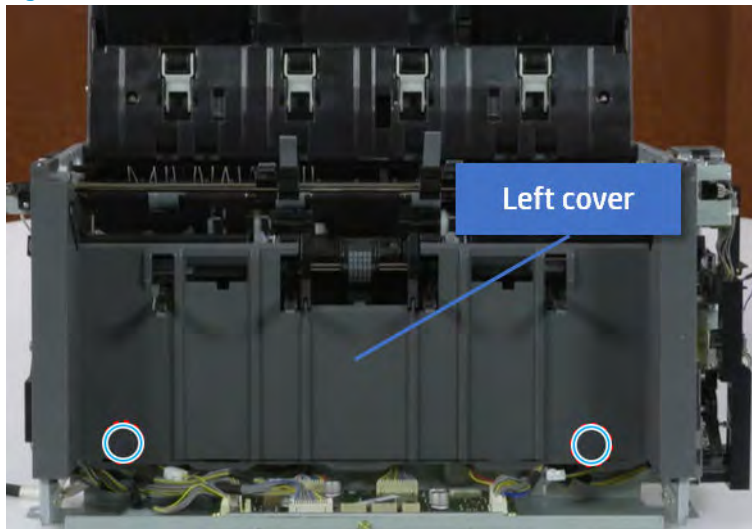


### Remove the left cover

Follow these steps to remove the left cover.

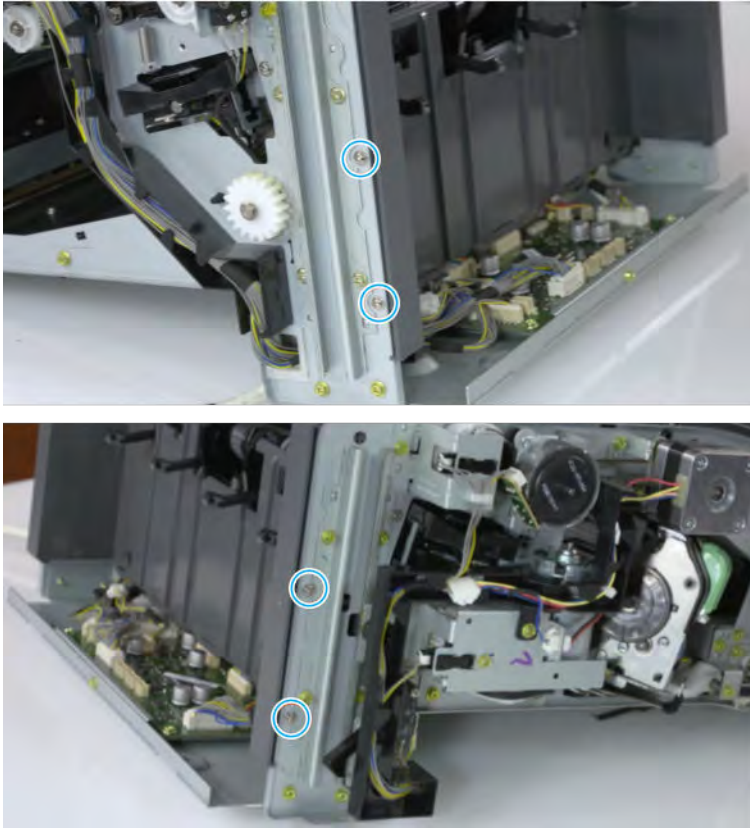
1. Remove two screws.

Figure 6-439 Remove two screws



2. Remove four screws from both front and rear sides.

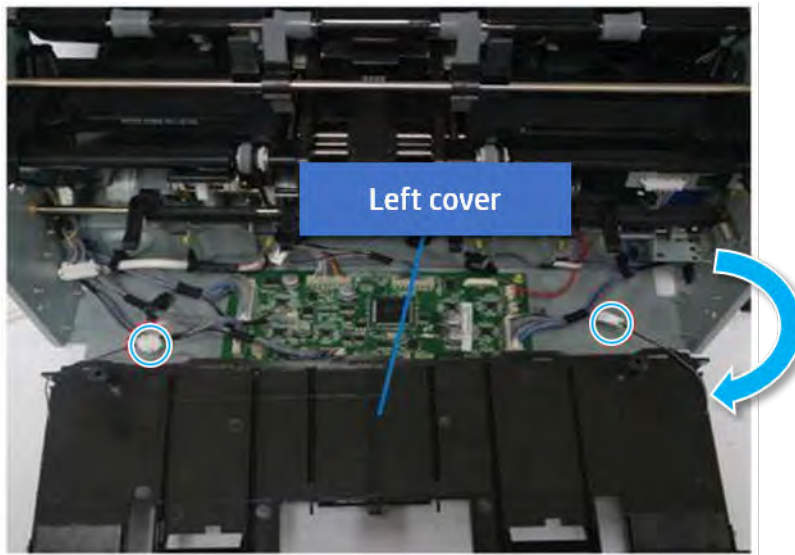
Figure 6-440 Remove four screws




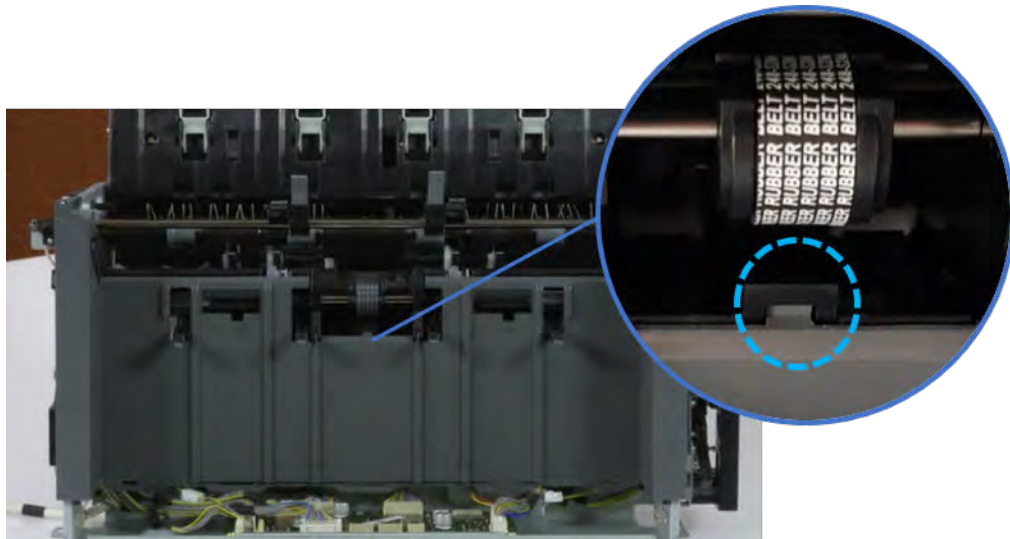


3. Unplug two inline connectors, and then remove the left cover.

Figure 6-441 Unplug two connectors



 **TIP:** Be sure to check the hook when reassembling.



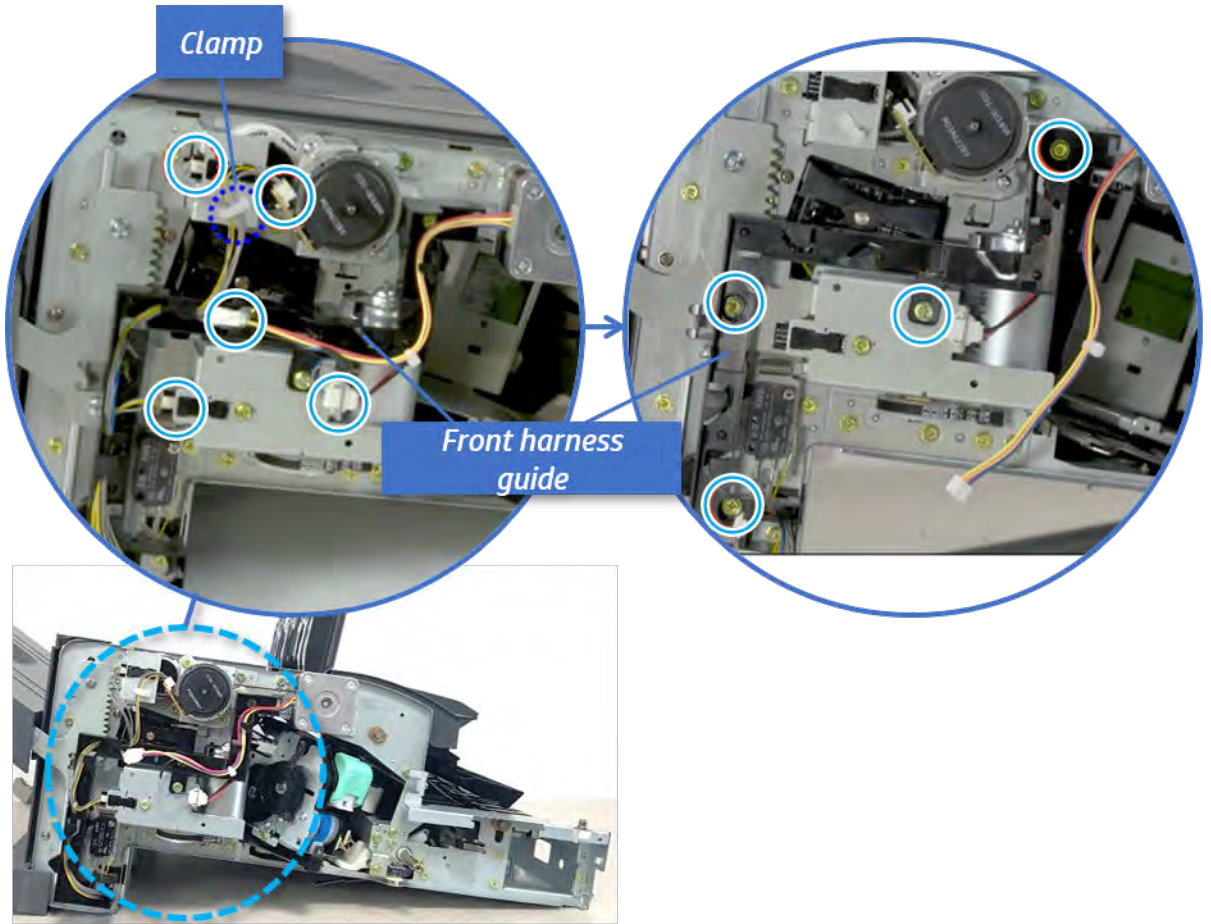
### Remove the front harness guide

Follow these steps to remove the front harness guide.

1. Open one clamp and unplug five connectors, and then remove the wire harness from the front harness guide.

2. Remove four screws, and then remove the front harness guide.

Figure 6-442 Remove the front harness guide

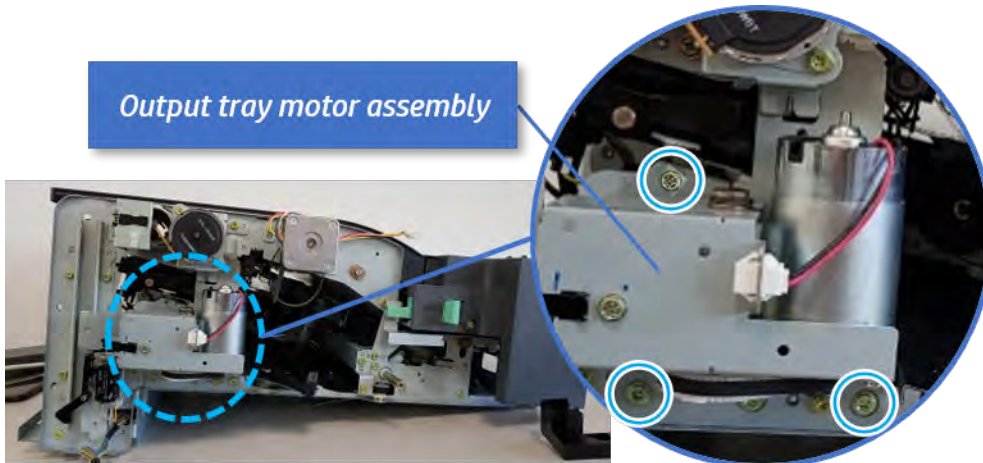


### Remove the output tray motor assembly

Follow these steps to remove the output tray motor assembly.

- ▲ Remove three screws, and then remove the output tray motor assembly.

Figure 6-443 Remove the output tray motor assembly

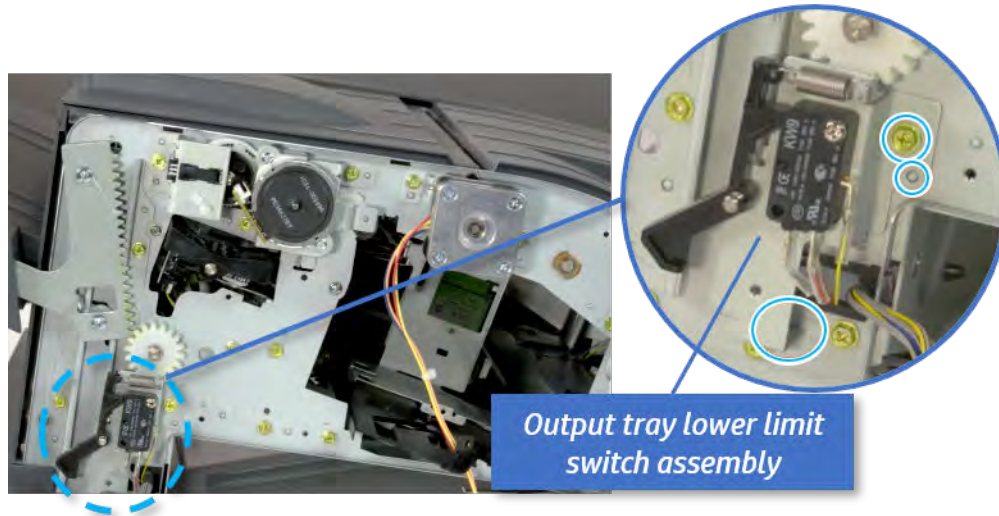


### Remove the output tray lower limit switch

Follow these steps to remove the output tray lower limit switch.

- ▲ Remove one screw, and then remove the output tray lower limit switch.

Figure 6-444 Remove the output tray lower limit switch

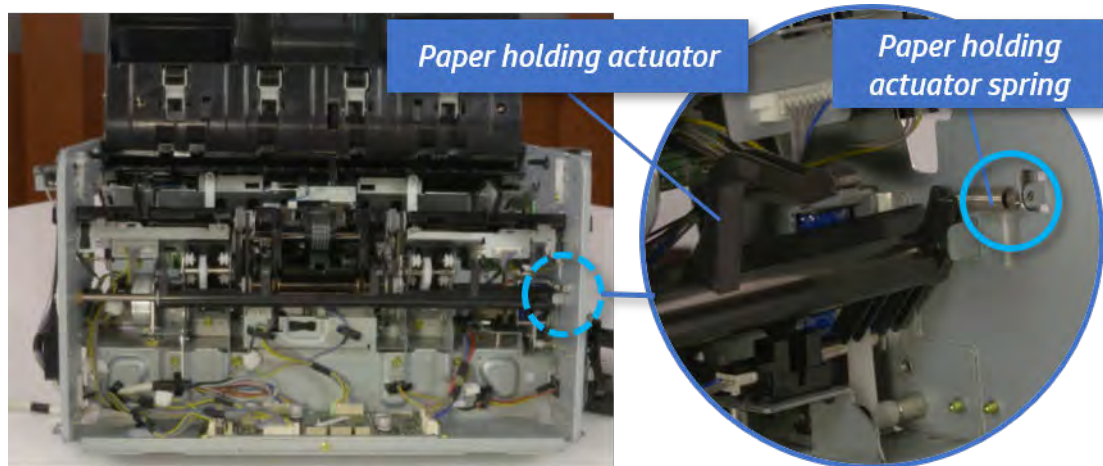


### Remove the paper holding

Follow these steps to remove the paper holding.

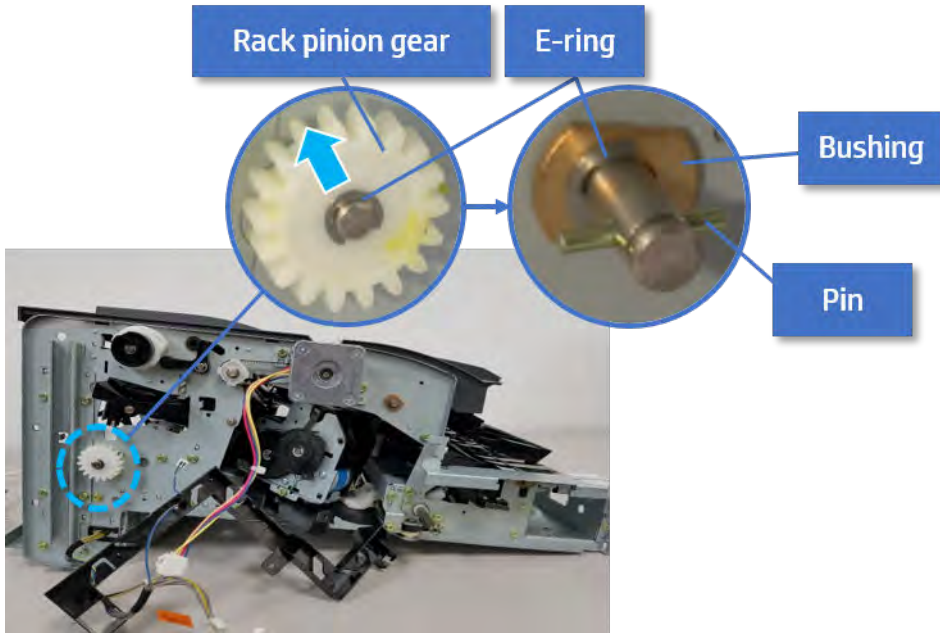
1. Remove the paper holding actuator spring.


Figure 6-445 Remove the paper holding actuator spring



2. Remove the e-ring and the rack pinion gear. And then remove the pin and the e-ring, and then remove the bushing.

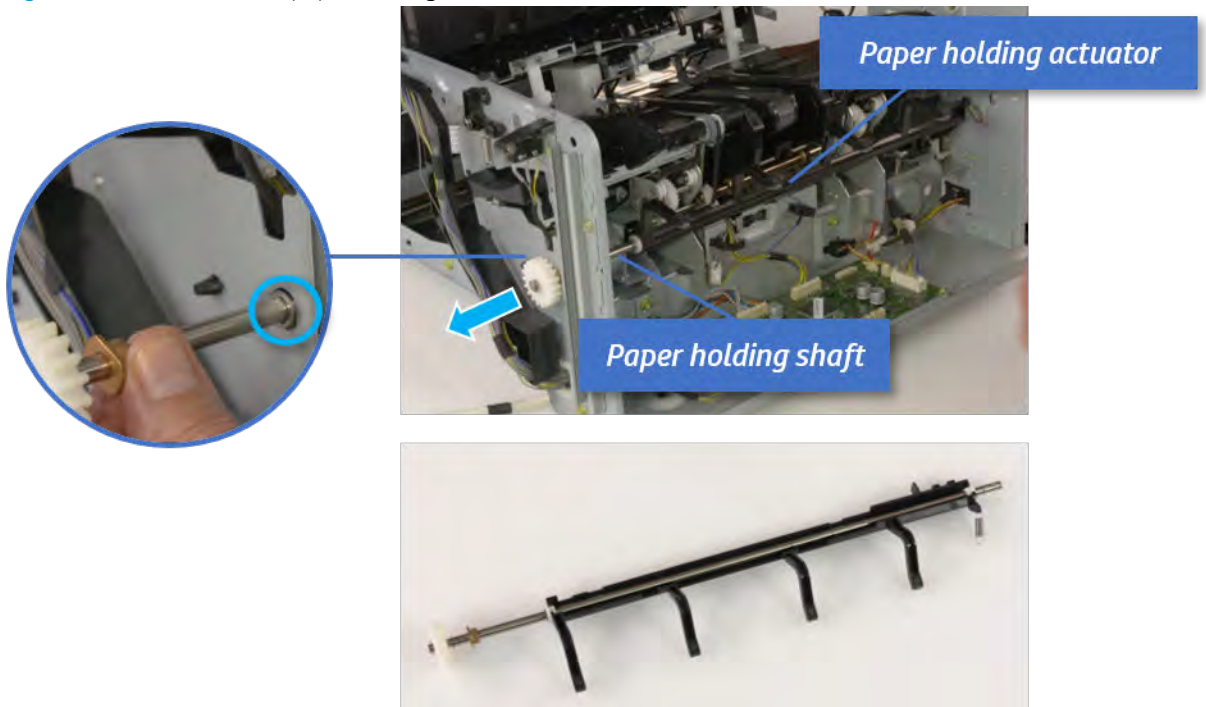
**Figure 6-446** Remove e-ring, rack pinion gear, pin, and bushing



 **NOTE:** Be sure not to lose the pin.

3. Carefully remove the paper holding shaft and the actuator.

**Figure 6-447** Remove the paper holding shaft and the actuator

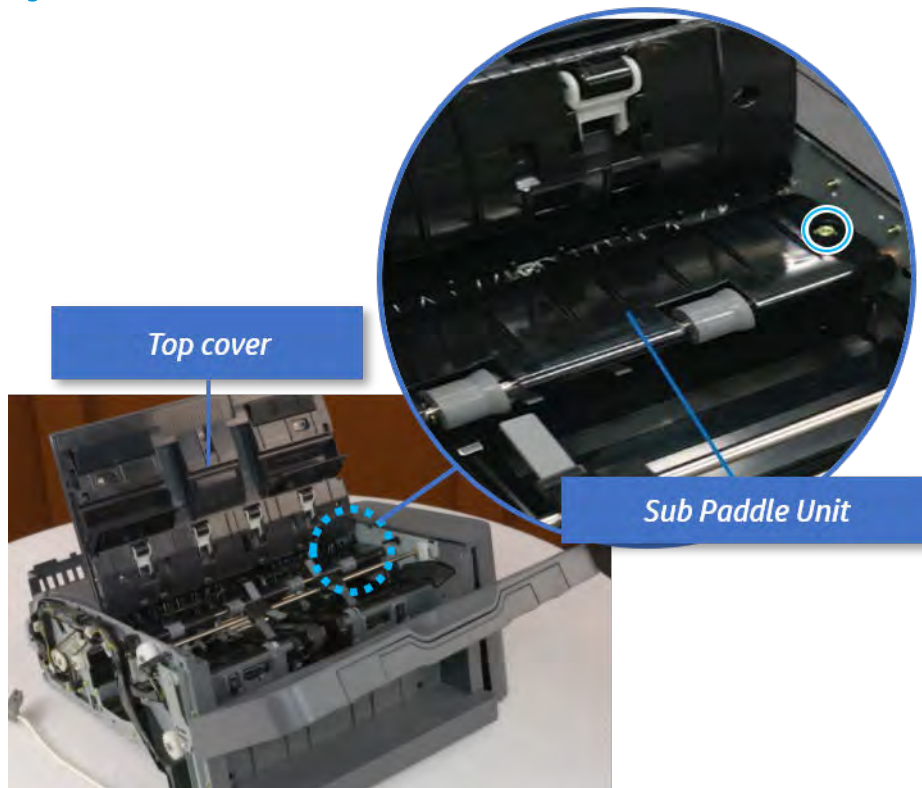


### Remove the sub paddle unit

Follow these steps to remove the sub paddle unit.

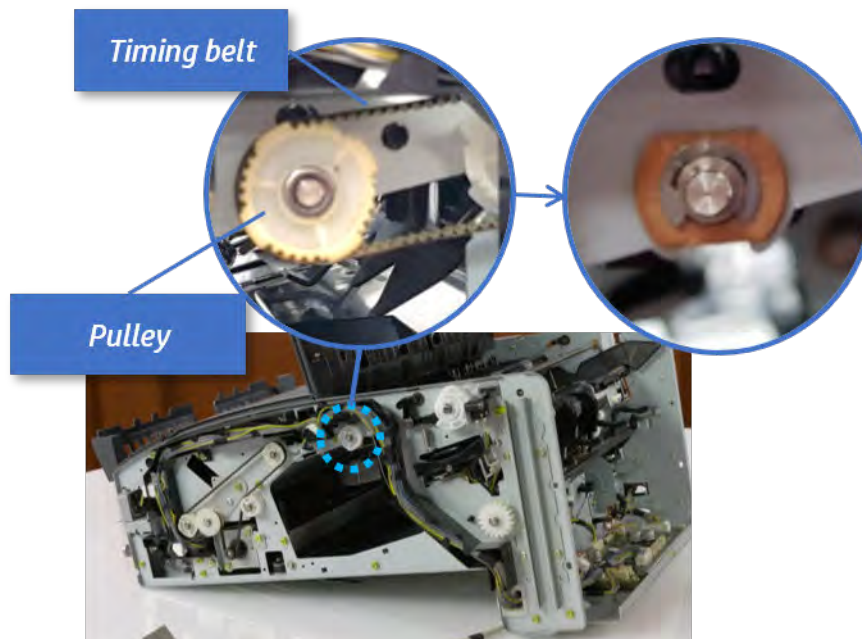
1. Open the top cover, and then remove one screw securing the sub paddle unit.

Figure 6-448 Remove one screw



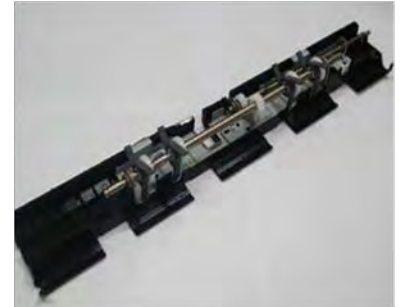
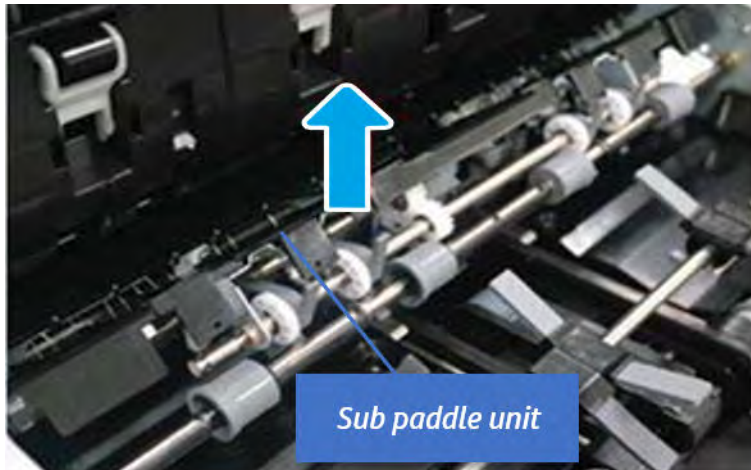
2. Remove the e-ring, and then remove the pulley and timing belt. And then remove the e-ring and the bushing.

Figure 6-449 Remove the e-ring, pulley, timing belt, and bushing



3. Lift up and remove the sub paddle unit.

Figure 6-450 Remove the sub paddle unit

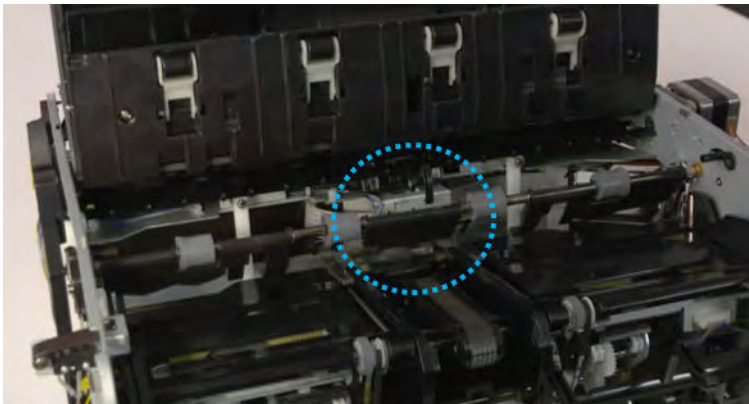


### Remove the exit roller

Follow these steps to remove the exit roller.

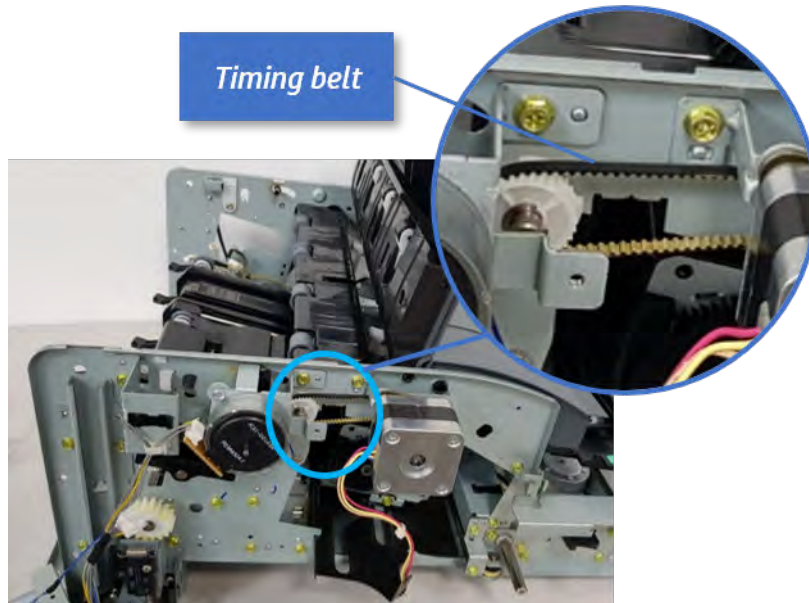
1. Remove the guide on the center of the exit roller.

Figure 6-451 Remove the guide



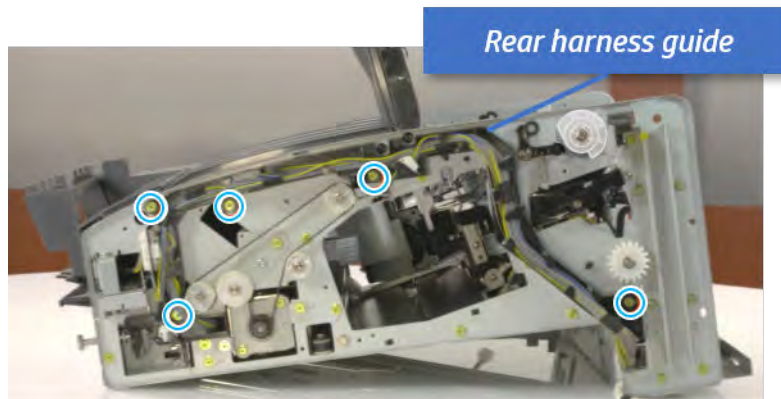
2. On the front of the inner finisher, release the timing belt connected to the exit motor.

Figure 6-452 Release the timing belt



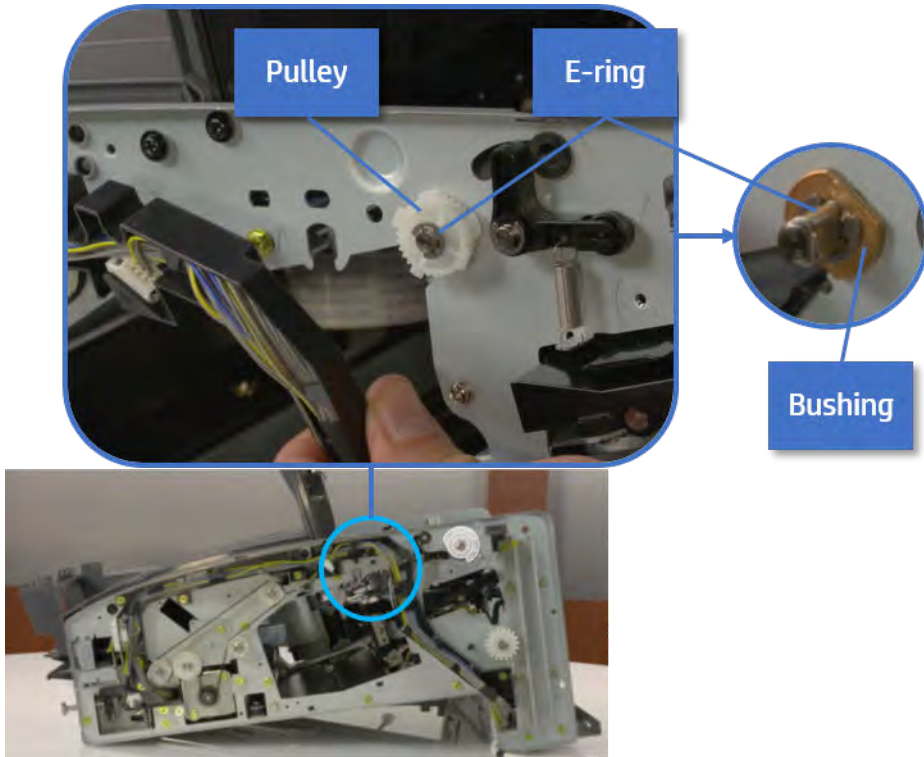
3. Remove five screws securing the rear harness guide.

Figure 6-453 Remove five screws



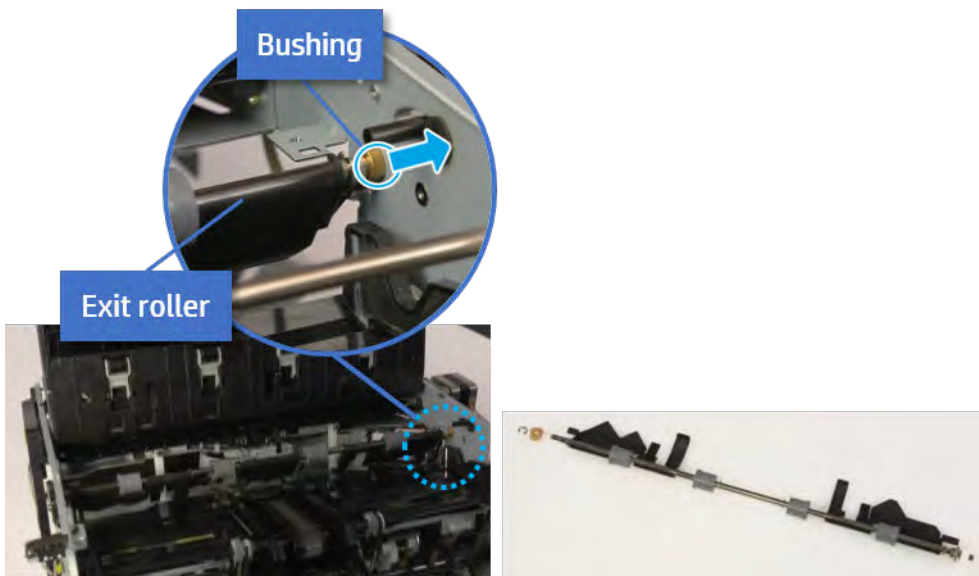
4. On the rear of the inner finisher, remove the e-ring and the pulley and then remove the e-ring and the bushing.

Figure 6-454 Remove e-ring, pulley, and bushing



5. Push the bushing to detach it, and then remove the exit roller.

Figure 6-455 Remove the exit roller




### Remove the rear tamper

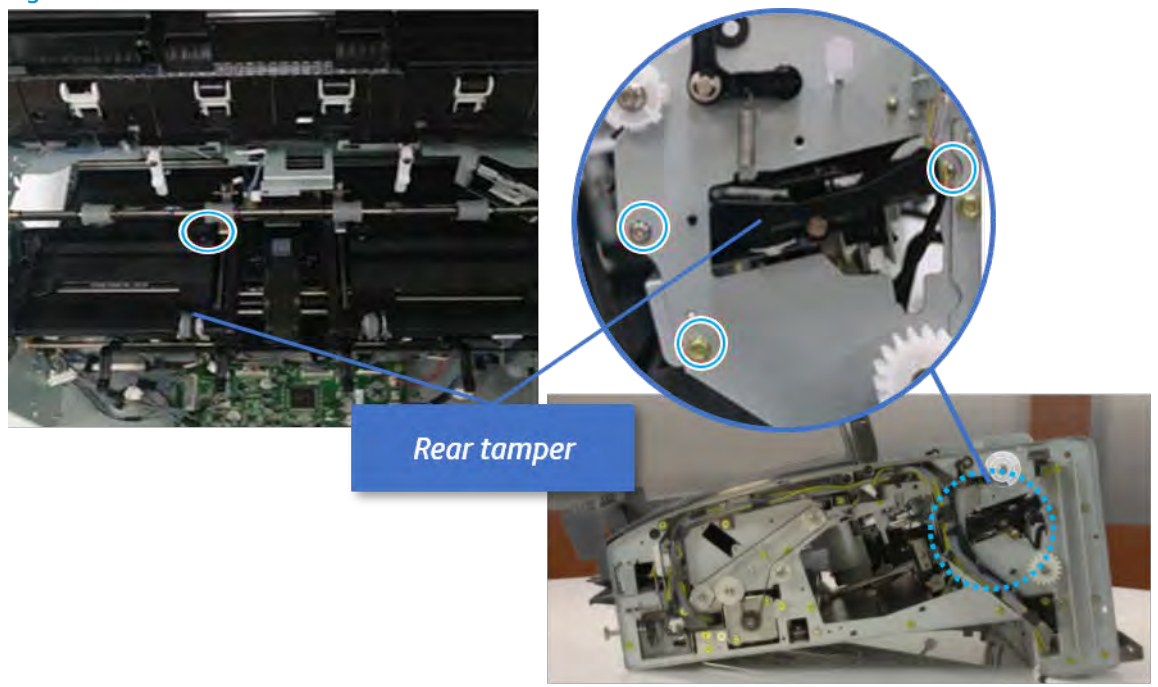
Follow these steps to remove the rear tamper.

1. Remove four screws.



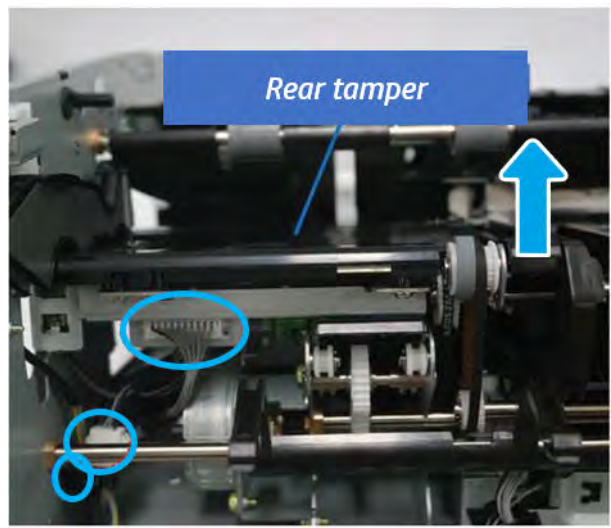
 **NOTE:** Move cable guideout of position to access the screws.

**Figure 6-456** Remove four screws



2. Unplug two connectors and release the hook, and then remove the rear tamper.

**Figure 6-457** Remove the rear tamper

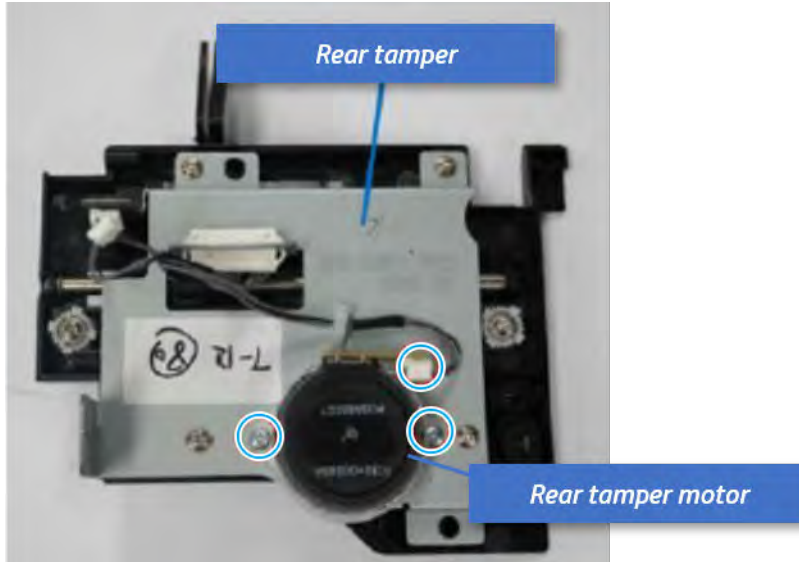


### Remove the rear tamper motor

Follow these steps to remove the rear tamper motor.

- ▲ Remove two screws, unplug the connector, and then remove the motor.

Figure 6-458 Remove the rear tamper motor



### Unpack the replacement assembly



Follow these steps to unpack the replacement assembly.

1. Dispose of the defective part.


 **NOTE:** HP recommends responsible disposal of the defective part.

<http://www8.hp.com/us/en/hp-information/environment/product-recycling.html>


2. Unpack the replacement part from the packaging.

 **CAUTION:**  Some parts are sensitive to electrostatic discharge (ESD). Always perform service work at an ESD-protected workstation or mat. If an ESD workstation or mat is not available, touch the sheet-metal chassis to provide a static ground before touching an ESD-sensitive assembly. Protect the ESD-sensitive assemblies by placing them in ESD pouches when they are out of the printer.

 **IMPORTANT:** Make sure that all of the shipping materials (for example shipping tape) are removed from the replacement part prior to installation.

 **NOTE:** If the replacement part is a roller or pad, avoid touching the spongy part of it. Skin oils on the roller or pad can cause paper pickup and/or print-quality problems. HP recommends using disposable gloves when handling rollers or pads or washing your hands before touching rollers or pads.

3. To install an assembly, reverse the removal steps.

 **NOTE:** When applicable, special installation instructions are provided for an assembly at the end of the removal procedure. Always completely read the removal instructions and follow all special installation instructions.

## Stapler unit

## Removal and replacement: Stapler


Learn how to remove and replace the stapler.

To view teardown and reassembling video of the inner finisher, click the link below.

 [View a teardown video of the inner finisher.](#)

 [View a reassembling video of the inner finisher.](#)

---

 **IMPORTANT:** When applicable, special installation instructions are provided for an assembly at the end of the removal procedure. Always completely read the removal instructions and follow all special installation instructions.

---

Mean time to repair:


Service level:

### Before performing service

#### Turn the printer power off

- Press the power button on the front of the printer, and then turn off the power switch next to the power cable.
- A shutting-down message appears on the control-panel display.

---

 **WARNING!** To avoid damage to the printer, turn the power off and wait until the printer shuts down before removing the power cable.

---

- Disconnect the printer power cable after the printer has completely shut down (the control-panel display is blank).

Use the table below to identify the correct part number for your printer. To order the part, go to [www.hp.com/buy/parts](http://www.hp.com/buy/parts).

Table 6-59 Part information

Part number	Part description
JC90-01342A	Stapler assembly

### Required tools

- #2 JIS screwdriver with a magnetic tip

### After performing service

#### Turn the printer power on

- Connect the power cable.
- Use the power switch to turn the power on.

### Post service test

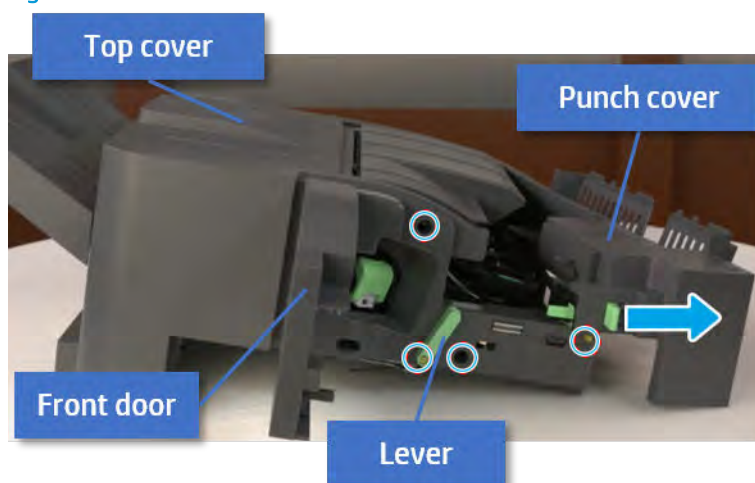
Print any pages necessary to verify that the repair resolved the issue and did not create any new issues.

## Remove the front cover

Follow these steps to remove the front cover:

1. Open the front door and open the punch cover.
2. Remove three screws in the front.
3. Remove the lever.
4. Open the top cover.
5. From the right side of the front cover, carefully lift and pry toward the top-left corner to remove the front cover.

Figure 6-459 Remove the front cover

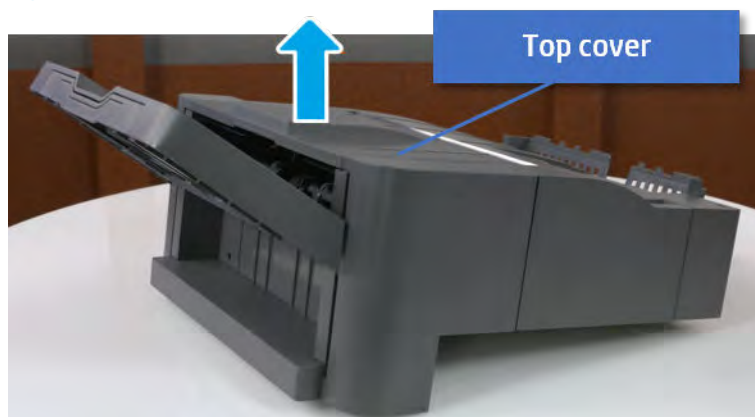


## Remove the rear cover

Follow these steps to remove the rear cover:

1. Open the top cover.

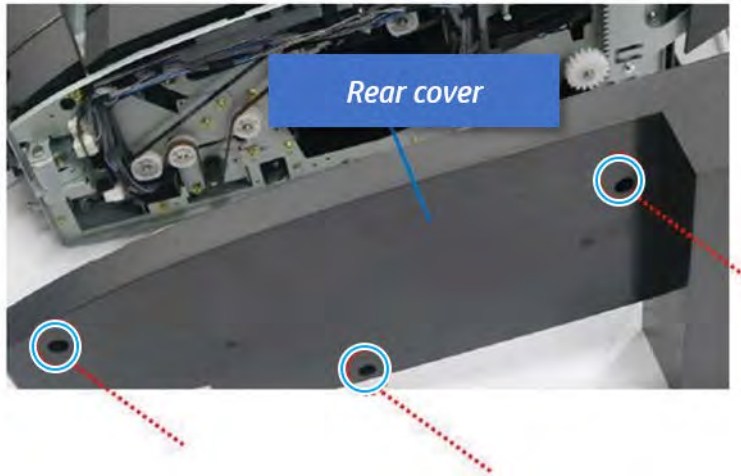
Figure 6-460 Open the top cover



2. Remove three screws.

3. Release hooks carefully and remove the rear cover.

Figure 6-461 Remove the rear cover

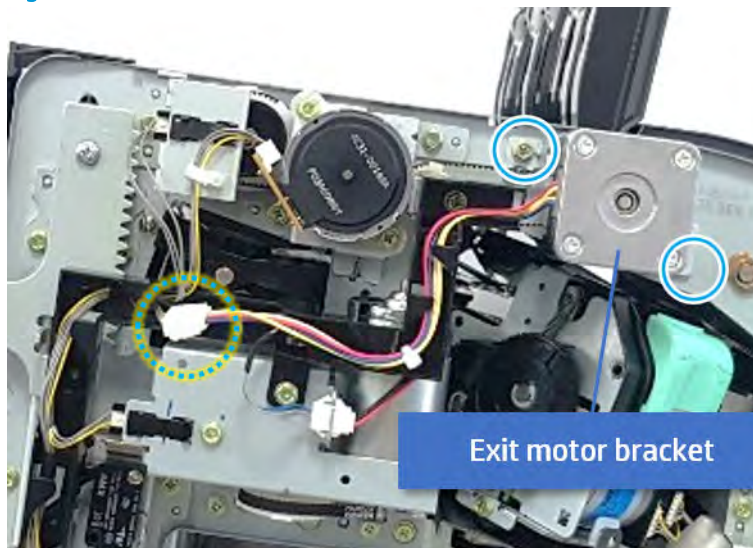


### Remove the exit motor bracket

Follow these steps to remove the exit motor bracket.

- ▲ Remove two screws, unplug the motor connector. And then remove exit motor bracket.

Figure 6-462 Remove the exit motor bracket

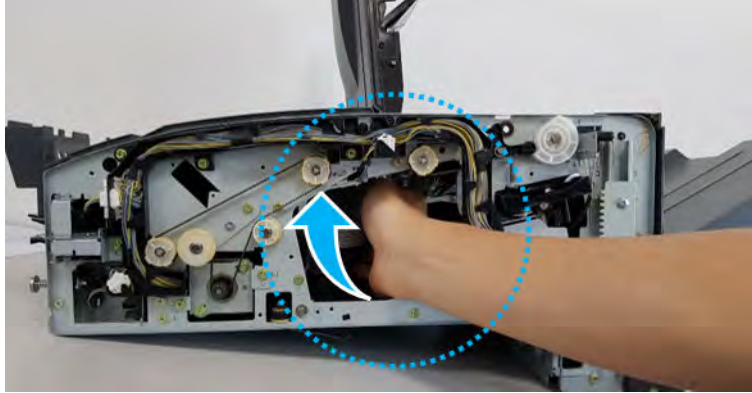


### Remove the stapler

Follow these steps to remove the stapler.

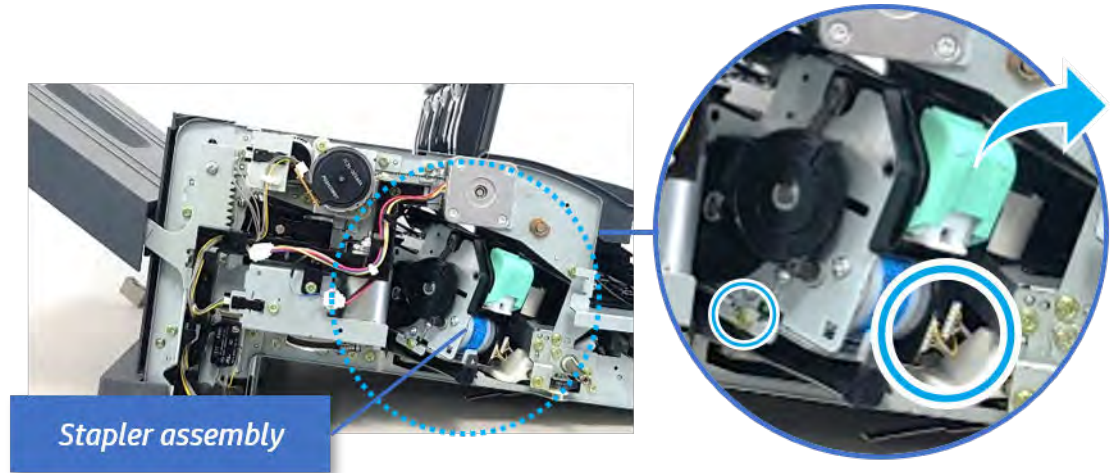
1. Push the stapler from the rear-side to the front-side.

Figure 6-463 Push the stapler



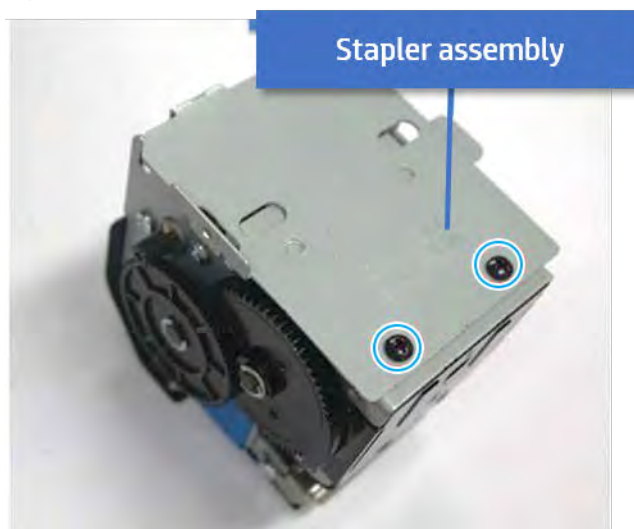
2. Remove one screw, unplug two connectors, and then remove the stapler assembly.

Figure 6-464 Remove the stapler assembly



3. Remove two screws, and then remove the stapler.

Figure 6-465 Remove the stapler



## Unpack the replacement assembly

Follow these steps to unpack the replacement assembly.

1. Dispose of the defective part.




**NOTE:** HP recommends responsible disposal of the defective part.

<http://www8.hp.com/us/en/hp-information/environment/product-recycling.html>

---

2. Unpack the replacement part from the packaging.



**CAUTION:**  Some parts are sensitive to electrostatic discharge (ESD). Always perform service work at an ESD-protected workstation or mat. If an ESD workstation or mat is not available, touch the sheet-metal chassis to provide a static ground before touching an ESD-sensitive assembly. Protect the ESD-sensitive assemblies by placing them in ESD pouches when they are out of the printer.



**IMPORTANT:** Make sure that all of the shipping materials (for example shipping tape) are removed from the replacement part prior to installation.



**NOTE:** If the replacement part is a roller or pad, avoid touching the spongy part of it. Skin oils on the roller or pad can cause paper pickup and/or print-quality problems. HP recommends using disposable gloves when handling rollers or pads or washing your hands before touching rollers or pads.

---

3. To install an assembly, reverse the removal steps.



**NOTE:** When applicable, special installation instructions are provided for an assembly at the end of the removal procedure. Always completely read the removal instructions and follow all special installation instructions.

---




## Removal and replacement: Stapler position sensor (S2)

Learn how to remove and replace the stapler position sensor.

To view teardown and reassembling video of the inner finisher, click the link below.

 [View a teardown video of the inner finisher.](#)

 [View a reassembling video of the inner finisher.](#)

 **IMPORTANT:** When applicable, special installation instructions are provided for an assembly at the end of the removal procedure. Always completely read the removal instructions and follow all special installation instructions.

Mean time to repair:

Service level:

### Before performing service

#### Turn the printer power off

- Press the power button on the front of the printer, and then turn off the power switch next to the power cable.
- A shutting-down message appears on the control-panel display.

 **WARNING!** To avoid damage to the printer, turn the power off and wait until the printer shuts down before removing the power cable.

- Disconnect the printer power cable after the printer has completely shut down (the control-panel display is blank).

Use the table below to identify the correct part number for your printer. To order the part, go to [www.hp.com/buy/parts](http://www.hp.com/buy/parts).

Table 6-60 Part information

Part number	Part description
0604-001393	Stapler position sensor

### Required tools

- #2 JIS screwdriver with a magnetic tip

### After performing service

#### Turn the printer power on

- Connect the power cable.
- Use the power switch to turn the power on.

### Post service test

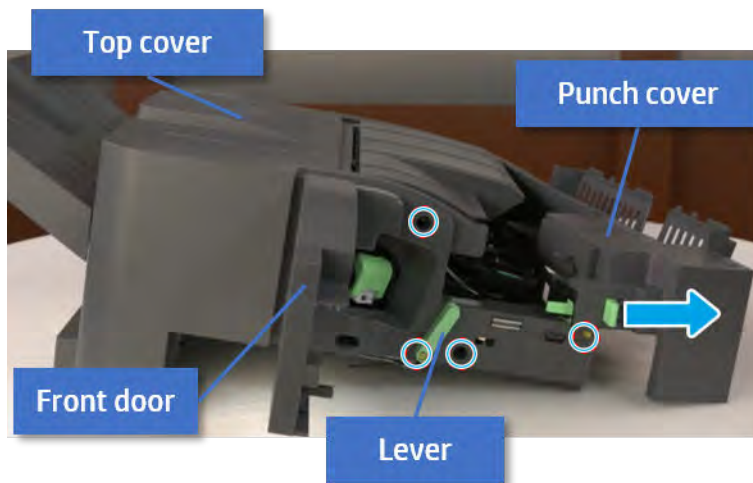
Print any pages necessary to verify that the repair resolved the issue and did not create any new issues.

## Remove the front cover

Follow these steps to remove the front cover.

1. Open the front door and open the punch cover.
2. Remove three screws in the front.
3. Remove the lever.
4. Open the top cover.
5. From the right side of the front cover, carefully lift and pry toward the top-left corner to remove the front cover.

Figure 6-466 Remove the front cover

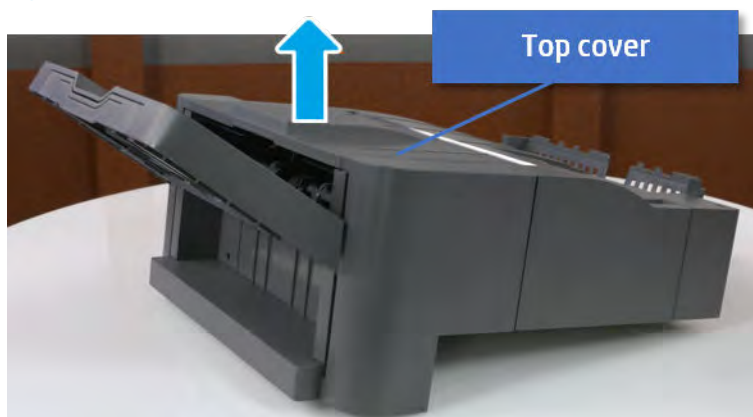


## Remove the rear cover

Follow these steps to remove the rear cover.

1. Open the top cover.

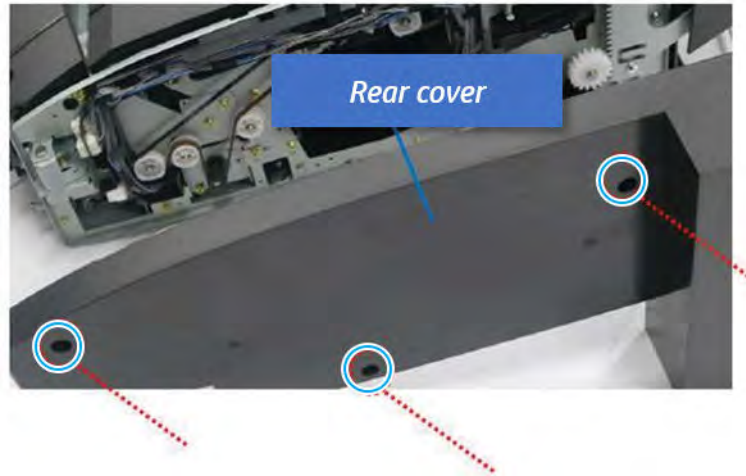
Figure 6-467 Open the top cover



2. Remove three screws.

3. Release hooks carefully and remove the rear cover.

Figure 6-468 Remove the rear cover



### Remove the middle cover

Follow these steps to remove the middle cover.

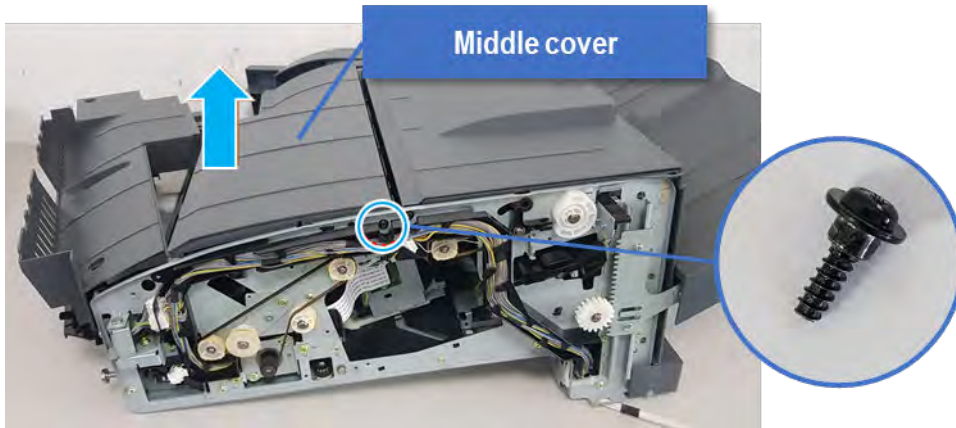
1. Open the front door and then open the punch cover.

Figure 6-469 Open the front door and punch cover



2. Remove left-side one screw at the rear of the inner finisher, and then remove the middle cover by lifting off the hinge pins at the front.

Figure 6-470 Remove the middle cover

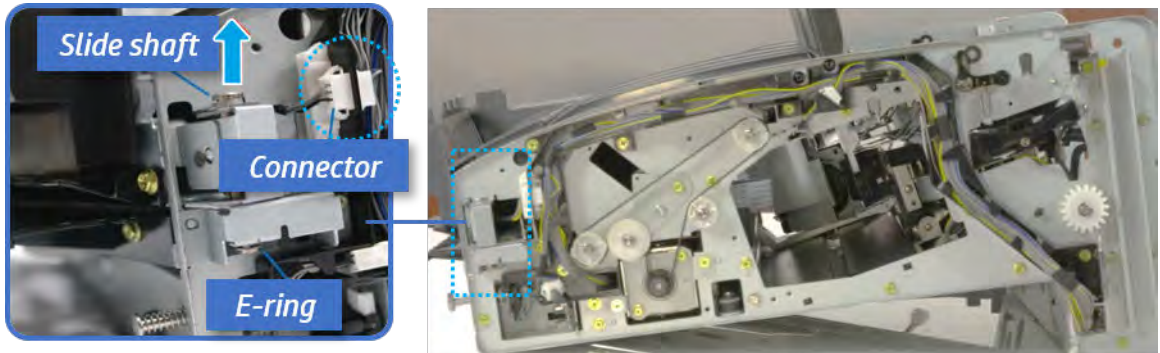


### Remove the punch cover

Follow these steps to remove the punch cover.

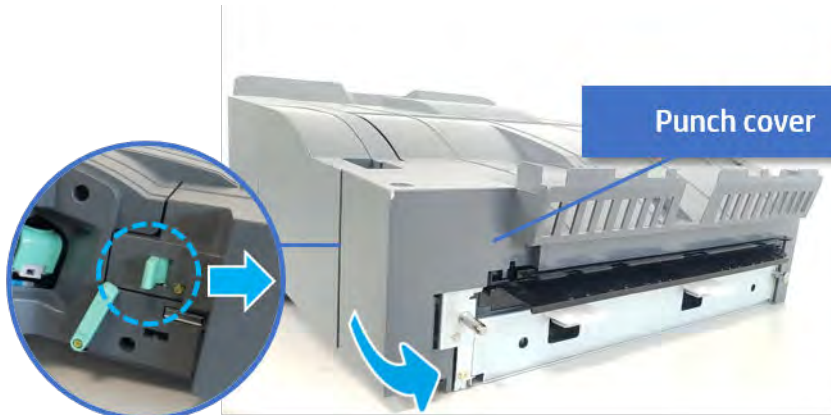
1. Unplug the connector. Remove the e-ring, and then remove the slide shaft at the rear of the inner finisher.

Figure 6-471 Remove the slide shaft



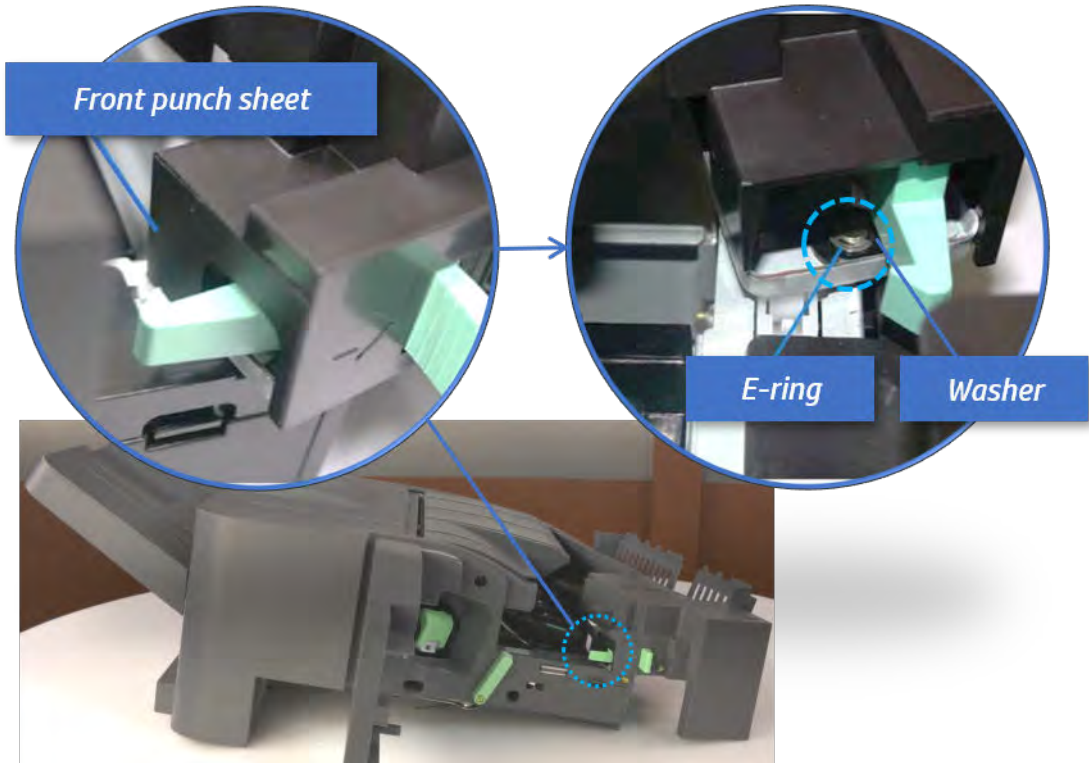
2. Open the punch cover.

Figure 6-472 Open the punch cover



3. Remove the front punch sheet, and then remove the e-ring and the washer. And then remove the punch cover.

Figure 6-473 Remove the punch cover

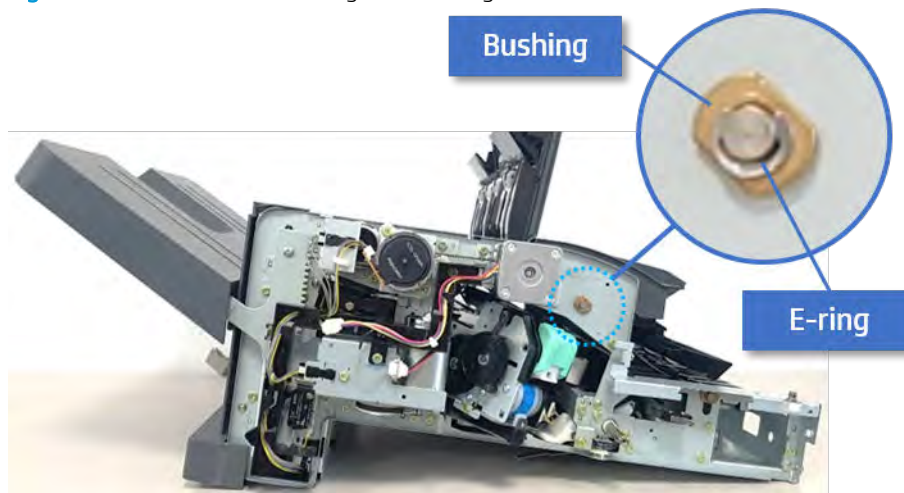


#### Remove the diverter guide and the middle roller

Follow these steps to remove the diverter guide and the middle roller.

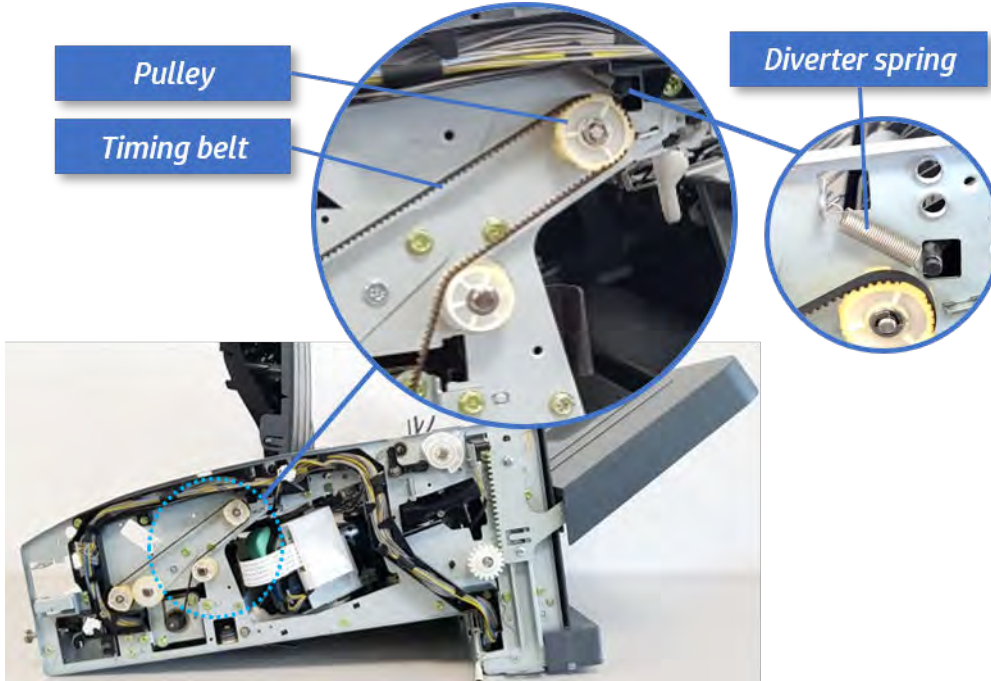
1. On the front of the inner finisher, remove the e-ring and bushing.

Figure 6-474 Remove the e-ring and bushing



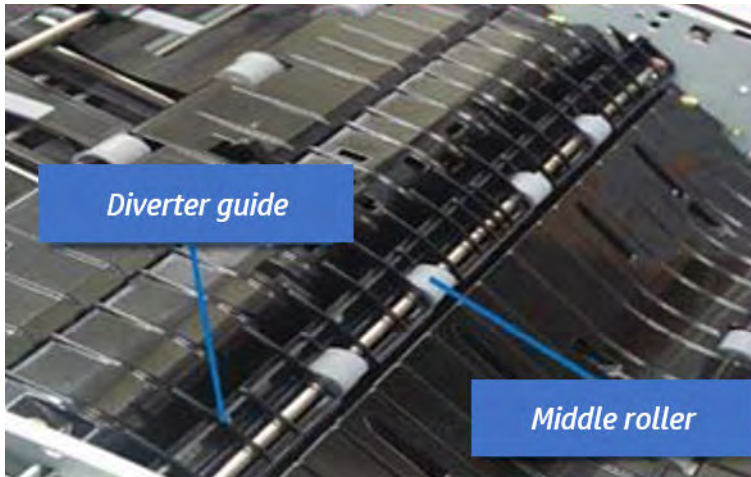
2. On the rear of the inner finisher, remove the e-ring, pulley, bushing, belt, and spring (slightly hidden from view).

**Figure 6-475** Remove the e-ring, pulley, bushing, belt, and spring



3. Remove the diverter guide and the middle roller.

**Figure 6-476** Remove the diverter guide and the middle roller



### Remove the middle paper guide

Follow these steps to remove the middle paper guide.

1. Remove six screws, and then open the middle paper guide in the direction of the arrow.

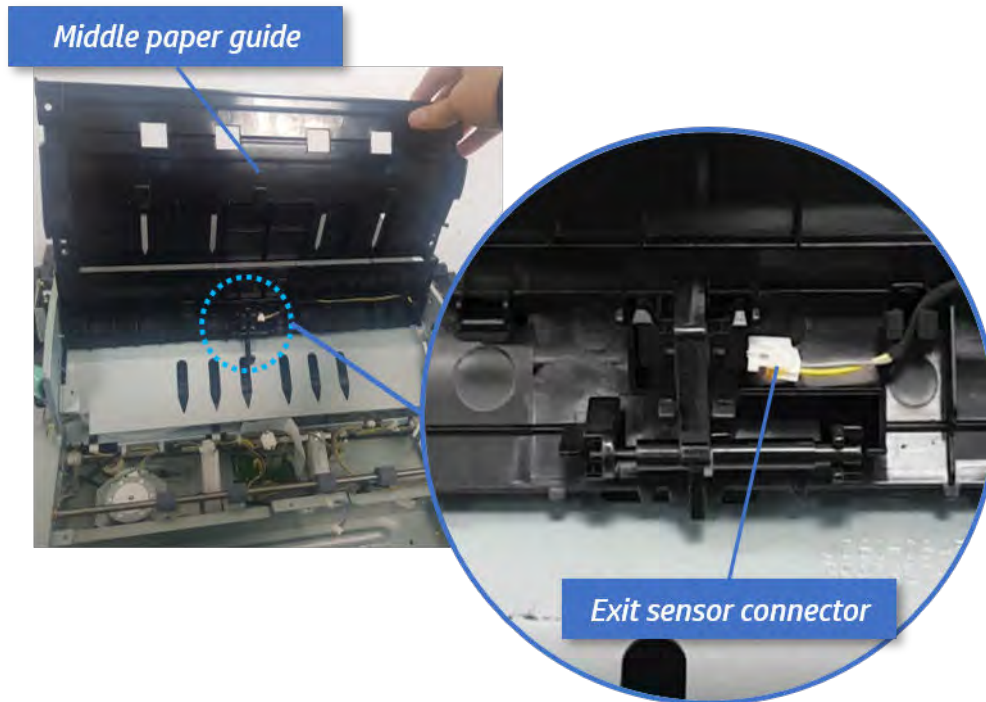
Figure 6-477 Open the middle paper guide



 **NOTE:** Be careful not to damage the sensor connector.

2. Unplug the connector under the middle paper guide. And then, remove the middle paper guide.

Figure 6-478 Remove the middle paper guide

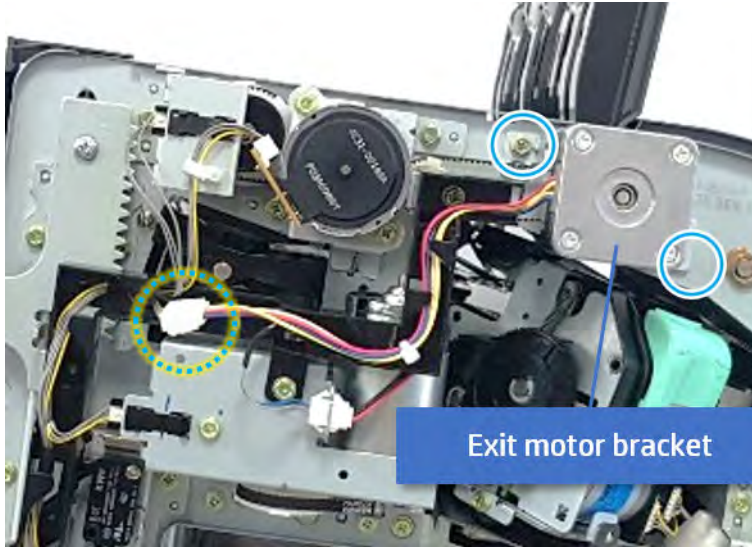


### Remove the exit motor bracket

Follow these steps to remove the exit motor bracket.

- ▲ Remove two screws, unplug the motor connector. And then remove exit motor bracket.

Figure 6-479 Remove the exit motor bracket

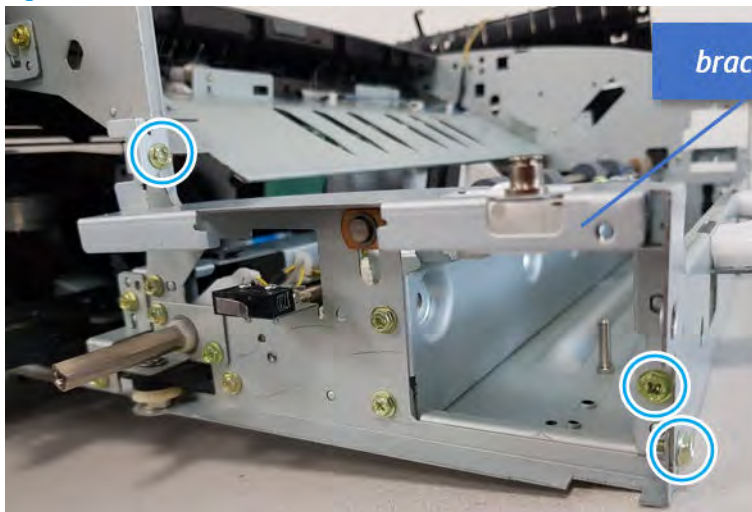


### Remove the end fence sensor bracket

Follow these steps to remove the end fence sensor bracket.

1. Remove three screws at the front of the inner finisher, and then remove the bracket.

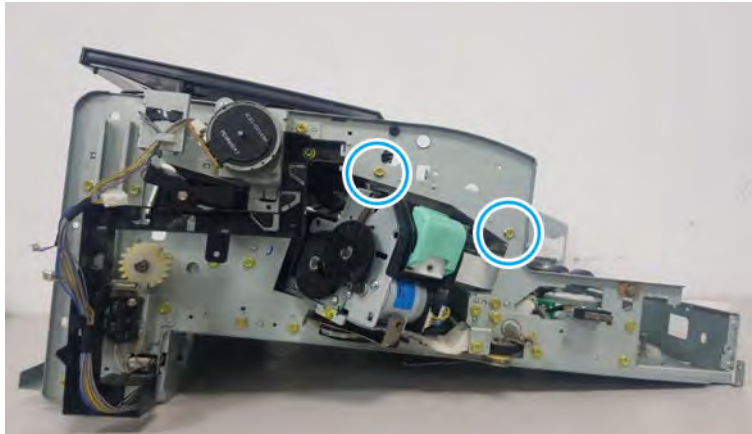
Figure 6-480 Remove the bracket





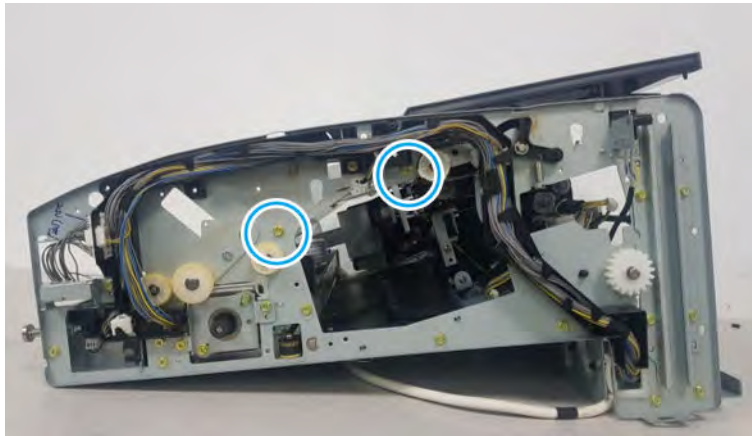
2. Remove two screws at the front of the inner finisher.

Figure 6-481 Remove two screws



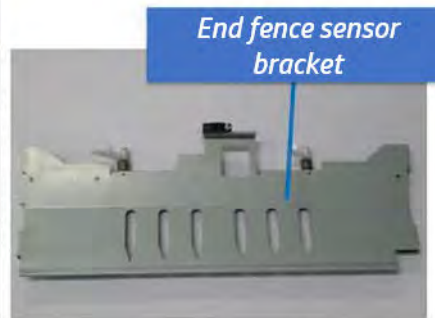
3. Remove two screws at the rear of the inner finisher.

Figure 6-482 Remove two screws



4. Loosen three cable clamps. Unplug the connector at the sensor, and then remove the end fence sensor bracket.

Figure 6-483 Remove the end fence sensor bracket

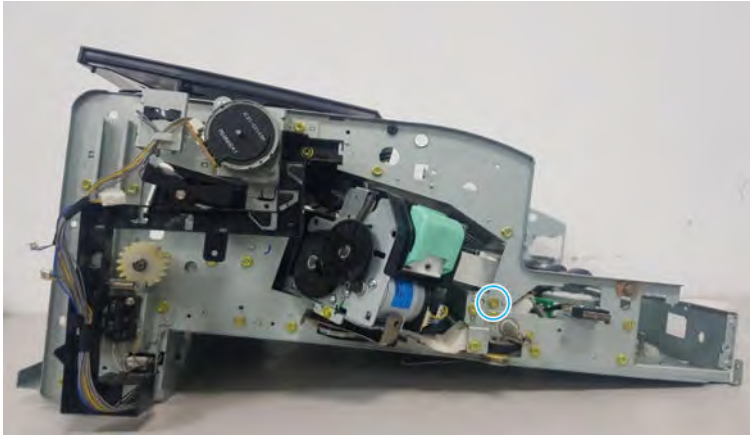


## Remove the stapler position sensor

Follow these steps to remove the stapler position sensor.

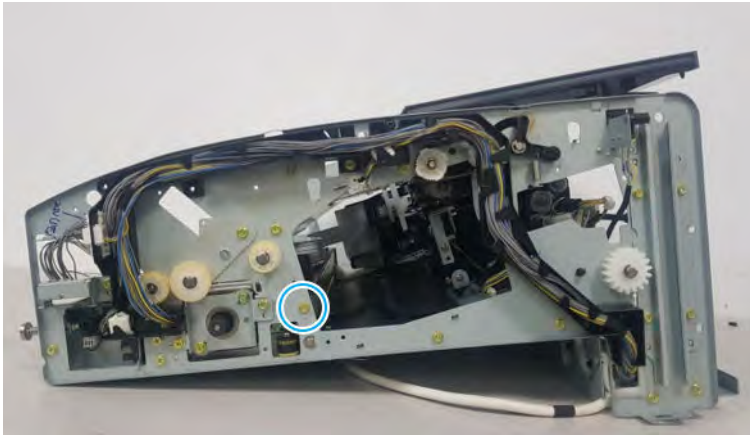
1. Remove one screw from the front of the inner finisher.

**Figure 6-484** Remove one screw



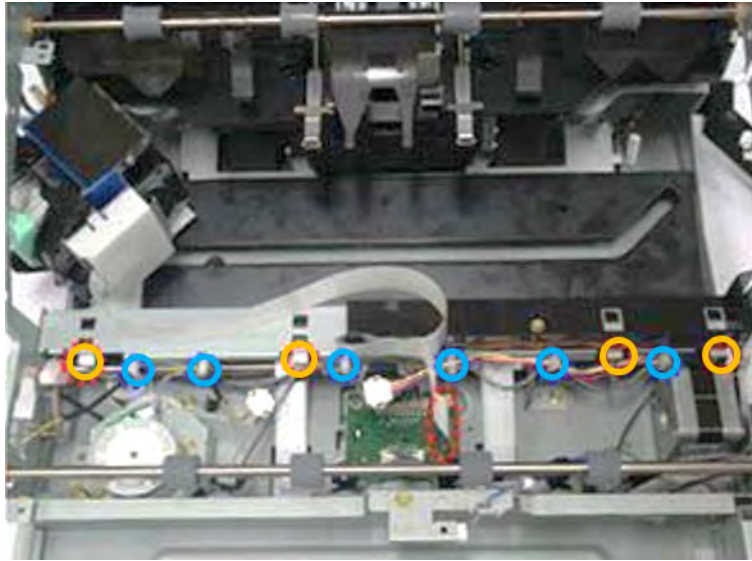
2. Remove one screw from the rear of the inner finisher.

**Figure 6-485** Remove one screw



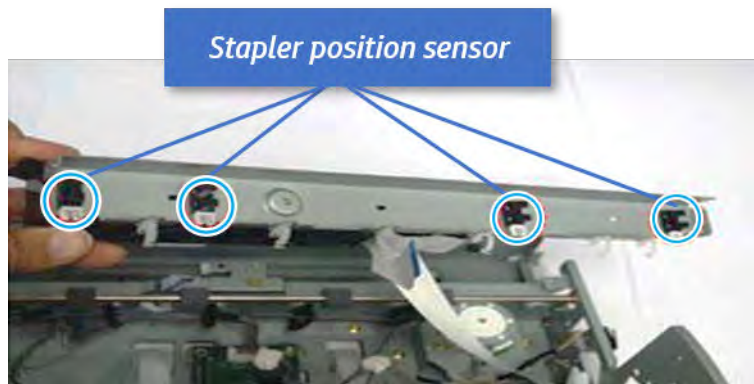
3. Unplug four photo-sensor connectors. Open the six cable clamps.

Figure 6-486 Unplug connectors



4. Remove the assembly, and then remove the sensor.

Figure 6-487 Remove the stapler position sensor



#### Unpack the replacement assembly

Follow these steps to unpack the replacement assembly.

1. Dispose of the defective part.



---


 **NOTE:** HP recommends responsible disposal of the defective part.


<http://www8.hp.com/us/en/hp-information/environment/product-recycling.html>

---

2. Unpack the replacement part from the packaging.


 **CAUTION:**  Some parts are sensitive to electrostatic discharge (ESD). Always perform service work at an ESD-protected workstation or mat. If an ESD workstation or mat is not available, touch the sheet-metal chassis to provide a static ground before touching an ESD-sensitive assembly. Protect the ESD-sensitive assemblies by placing them in ESD pouches when they are out of the printer.

 **IMPORTANT:** Make sure that all of the shipping materials (for example shipping tape) are removed from the replacement part prior to installation.

 **NOTE:** If the replacement part is a roller or pad, avoid touching the spongy part of it. Skin oils on the roller or pad can cause paper pickup and/or print-quality problems. HP recommends using disposable gloves when handling rollers or pads or washing your hands before touching rollers or pads.

---

3. To install an assembly, reverse the removal steps.

 **NOTE:** When applicable, special installation instructions are provided for an assembly at the end of the removal procedure. Always completely read the removal instructions and follow all special installation instructions.

---

## Removal and replacement: Stapler position motor (M1)


Learn how to remove and replace the stapler position motor.

To view teardown and reassembling video of the inner finisher, click the link below.

 [View a teardown video of the inner finisher.](#)

 [View a reassembling video of the inner finisher.](#)

---

 **IMPORTANT:** When applicable, special installation instructions are provided for an assembly at the end of the removal procedure. Always completely read the removal instructions and follow all special installation instructions.

---

Mean time to repair:


Service level:

### Before performing service

#### Turn the printer power off

- Press the power button on the front of the printer, and then turn off the power switch next to the power cable.
- A shutting-down message appears on the control-panel display.

---

 **WARNING!** To avoid damage to the printer, turn the power off and wait until the printer shuts down before removing the power cable.

---

- Disconnect the printer power cable after the printer has completely shut down (the control-panel display is blank).

Use the table below to identify the correct part number for your printer. To order the part, go to <http://www.hp.com/buy/parts>.

**Table 6-61 Part information**

Part number	Part description
JC93-00999A	Stapler position motor

### Required tools

- #2 JIS screwdriver with a magnetic tip

### After performing service

#### Turn the printer power on

- Connect the power cable.
- Use the power switch to turn the power on.

### Post service test

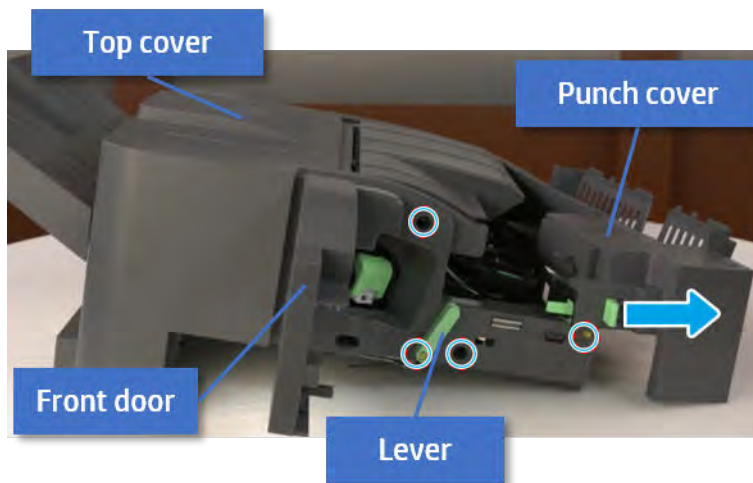
Print any pages necessary to verify that the repair resolved the issue and did not create any new issues.

## Remove the front cover

Follow these steps to remove the front cover.

1. Open the front door and open the punch cover.
2. Remove three screws in the front.
3. Remove the lever.
4. Open the top cover.
5. From the right side of the front cover, carefully lift and pry toward the top-left corner to remove the front cover.

Figure 6-488 Remove the front cover

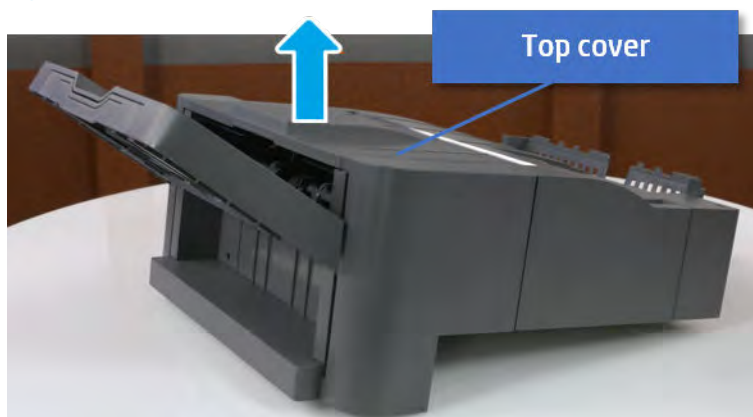


## Remove the rear cover

Follow these steps to remove the rear cover.

1. Open the top cover.

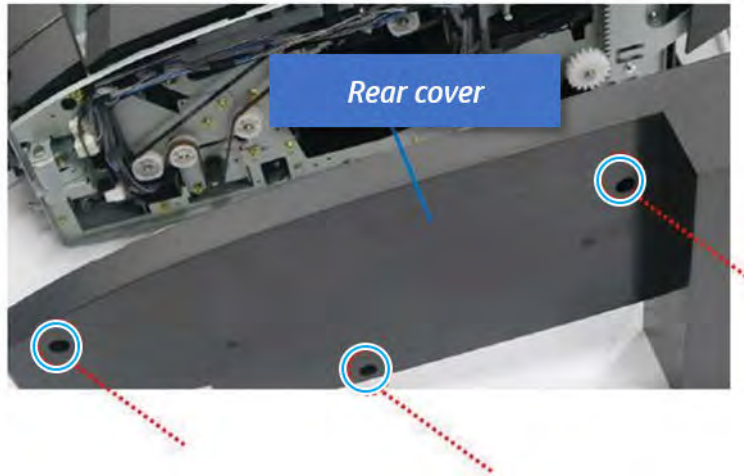
Figure 6-489 Open the top cover



2. Remove three screws.

3. Release hooks carefully and remove the rear cover.

Figure 6-490 Remove the rear cover



### Remove the middle cover

Follow these steps to remove the middle cover.

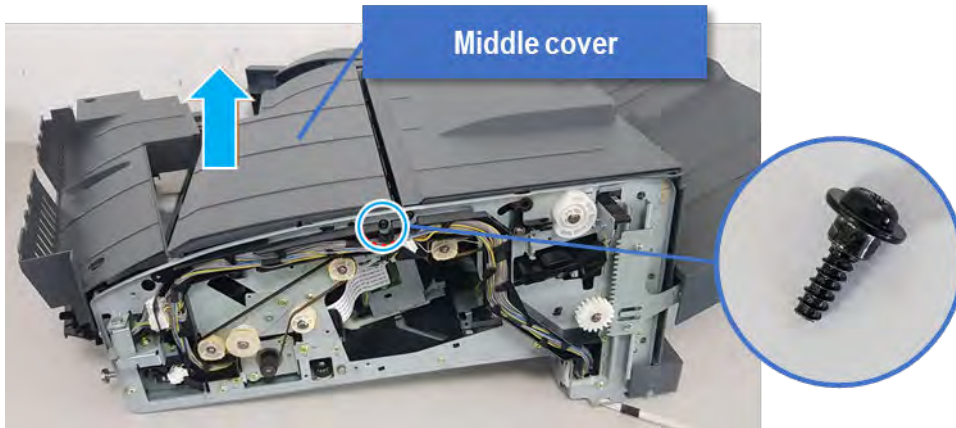
1. Open the front door and then open the punch cover.

Figure 6-491 Open the front door and punch cover



2. Remove left-side one screw at the rear of the inner finisher, and then remove the middle cover by lifting off the hinge pins at the front.

Figure 6-492 Remove the middle cover

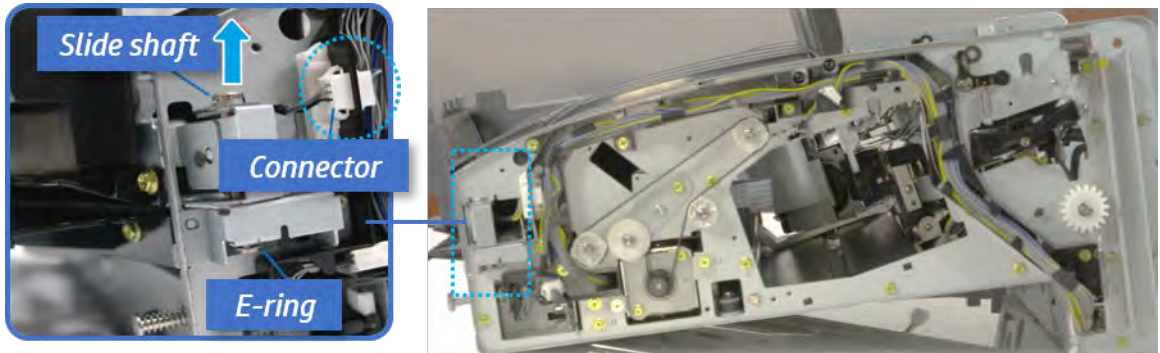


### Remove the punch cover

Follow these steps to remove the punch cover.

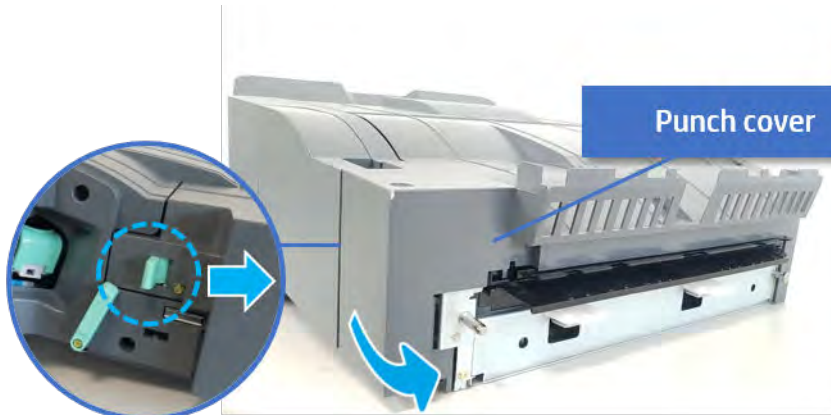
1. Unplug the connector. Remove the e-ring, and then remove the slide shaft at the rear of the inner finisher.

Figure 6-493 Remove the slide shaft



2. Open the punch cover.

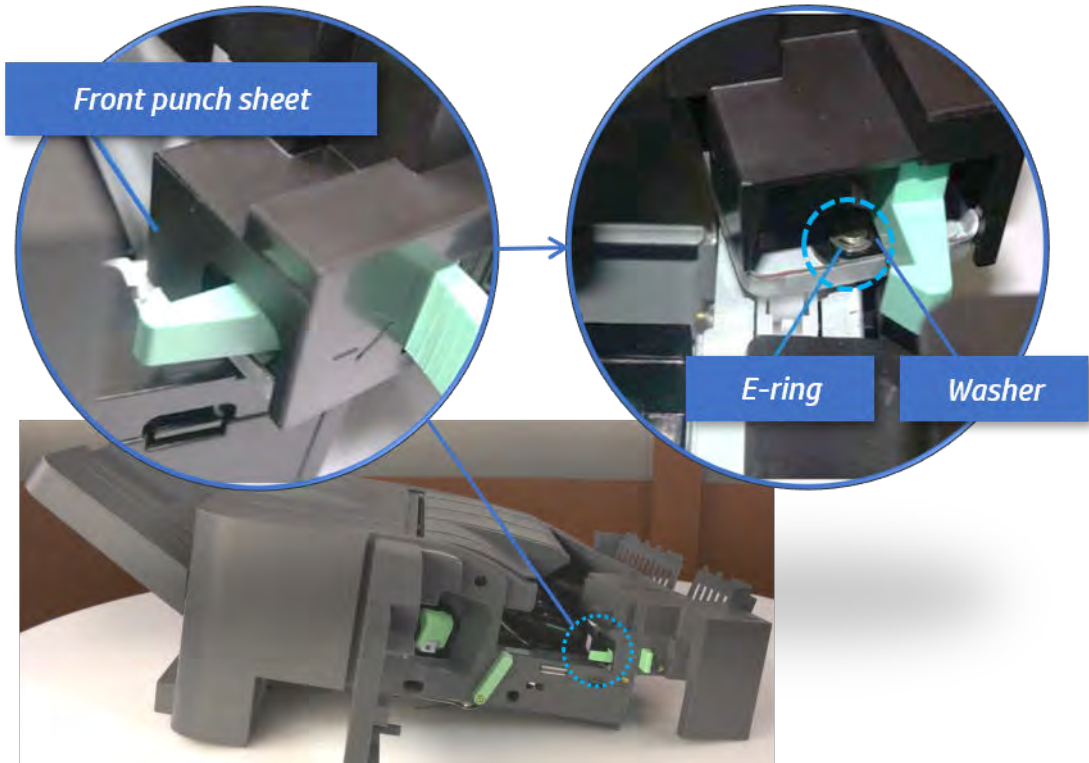
Figure 6-494 Open the punch cover





3. Remove the front punch sheet, and then remove the e-ring and the washer. And then remove the punch cover.

Figure 6-495 Remove the punch cover

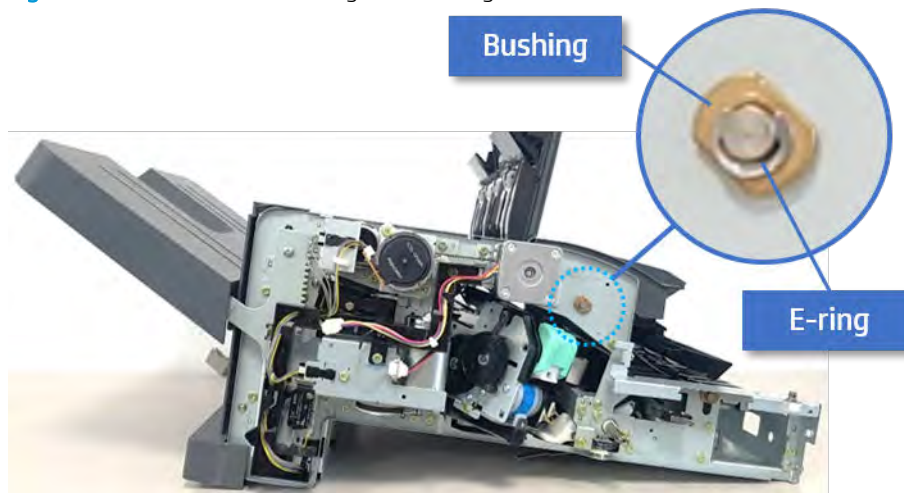


#### Remove the diverter guide and the middle roller

Follow these steps to remove the diverter guide and the middle roller.

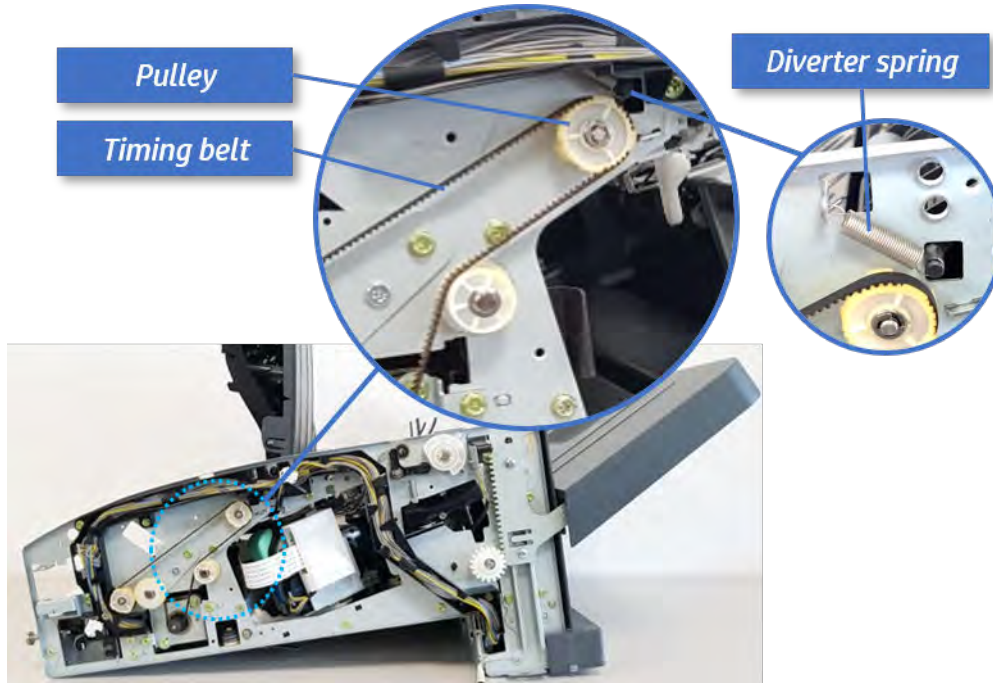
1. On the front of the inner finisher, remove the e-ring and bushing.

Figure 6-496 Remove the e-ring and bushing



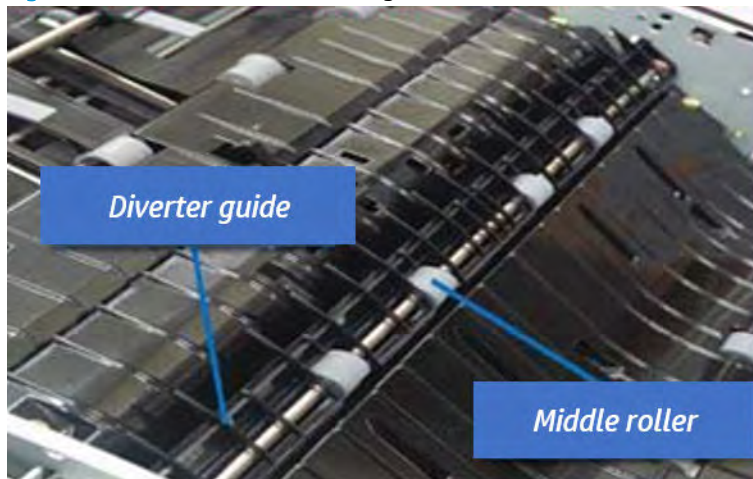
2. On the rear of the inner finisher, remove the e-ring, pulley, bushing, belt, and spring (slightly hidden from view).

**Figure 6-497** Remove the e-ring, pulley, bushing, belt, and spring



3. Remove the diverter guide and the middle roller.

**Figure 6-498** Remove the diverter guide and the middle roller




### Remove the middle paper guide

Follow these steps to remove the middle paper guide.

1. Remove six screws, and then open the middle paper guide in the direction of the arrow.

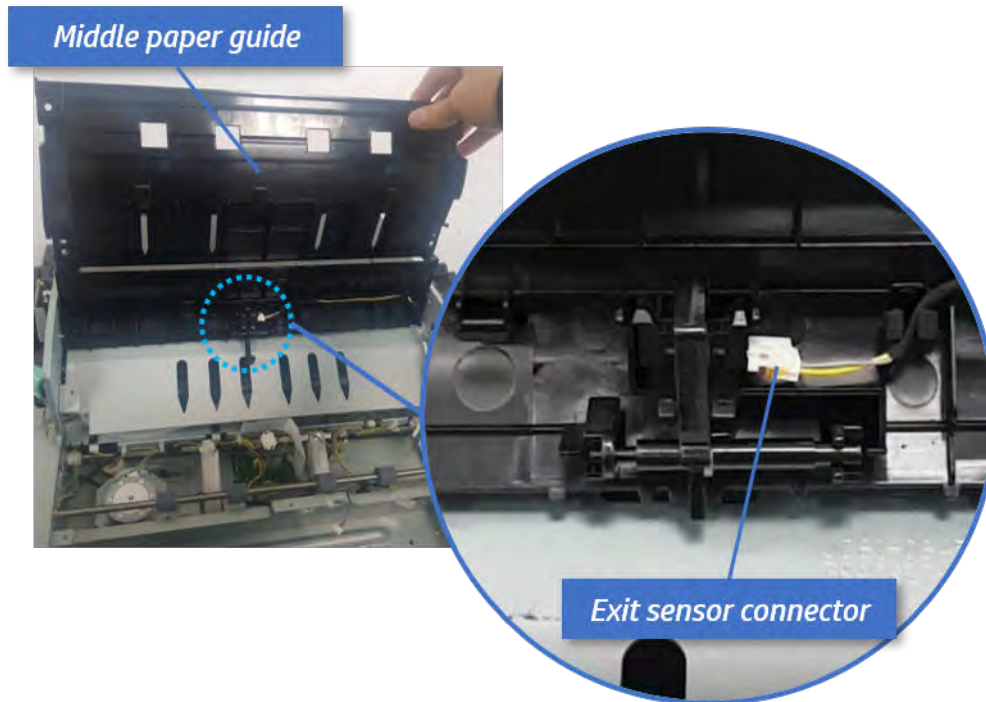
Figure 6-499 Open the middle paper guide



 **NOTE:** Be careful not to damage the sensor connector.

2. Unplug the connector under the middle paper guide. And then, remove the middle paper guide.

Figure 6-500 Remove the middle paper guide

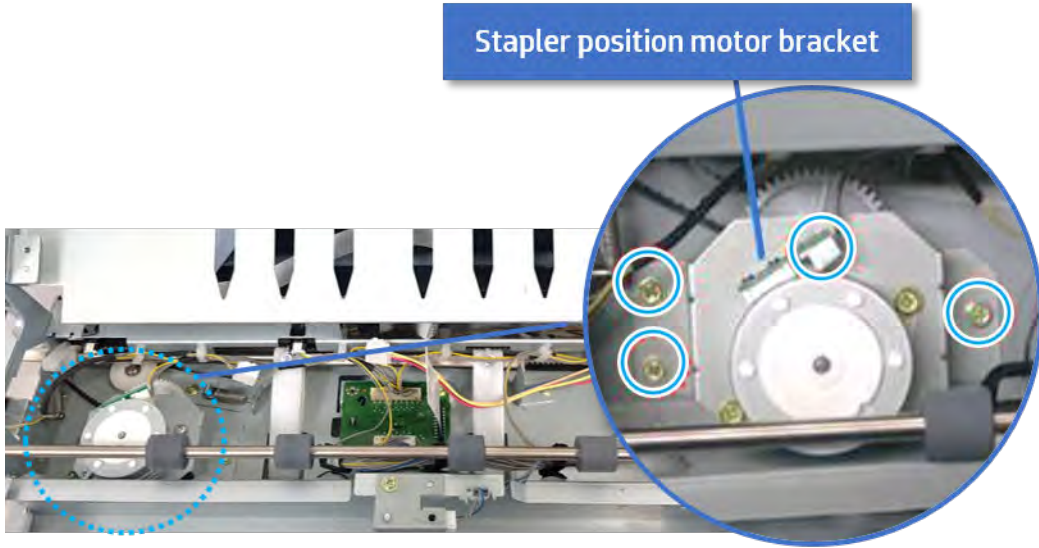


### Remove the stapler position motor

Follow these steps to remove the stapler position motor.

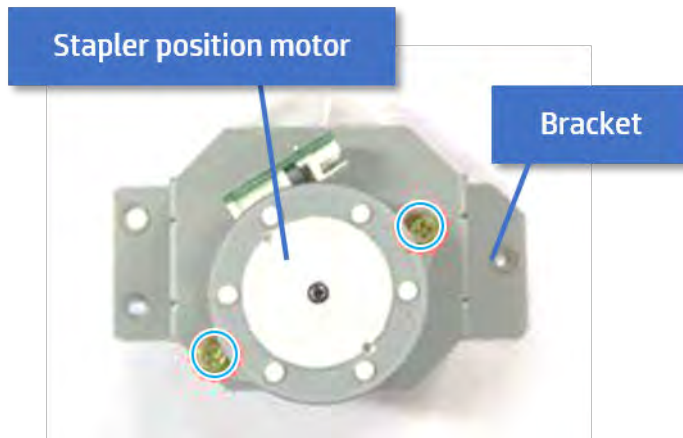
1. Remove three screws, unplug the motor connector, and then remove the stapler position motor bracket.


Figure 6-501 Remove the stapler position motor bracket



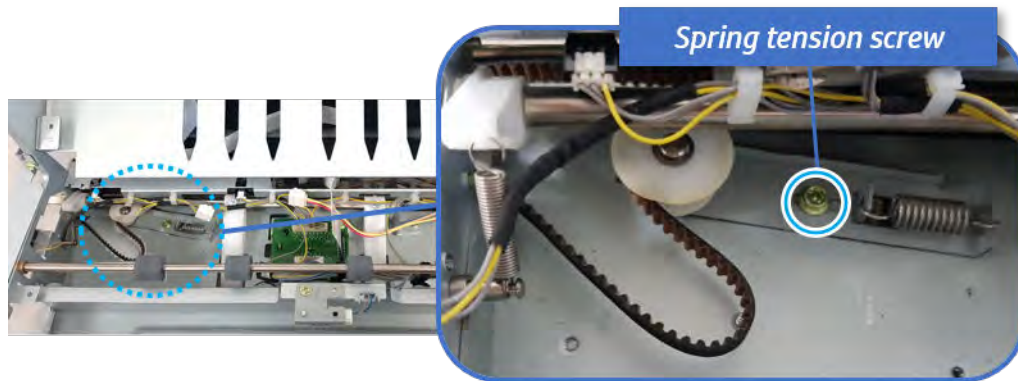
2. Remove two screws, and then remove the motor from the bracket.

Figure 6-502 Remove the stapler position motor

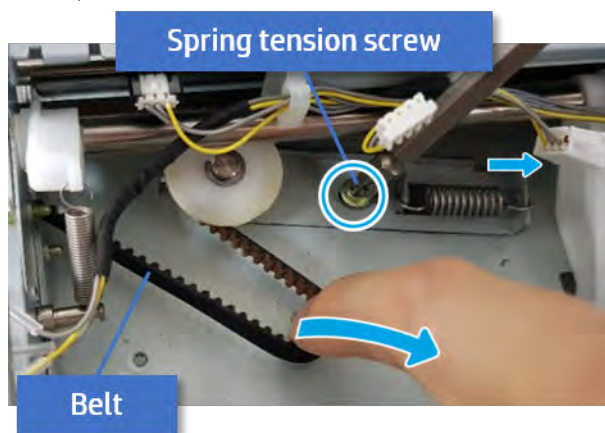


 **TIP:** Use the following steps when reinstalling the stapler position motor.

Release the spring tension screw.



Apply tension to the spring by pulling the belt, and then tighten the spring tension screw. Tightening the screw puts maximum slack in the belt.



Lower the stapler position motor while placing the belt on the motor pulley, and then secure the bracket with three screws.

Release the spring tension screw to allow the spring to apply tension to the belt, and then tighten it again

## Unpack the replacement assembly

Follow these steps to unpack the replacement assembly.

1. Dispose of the defective part.

---



 **NOTE:** HP recommends responsible disposal of the defective part.

<http://www8.hp.com/us/en/hp-information/environment/product-recycling.html>


---

2. Unpack the replacement part from the packaging.

---

 **CAUTION:**  Some parts are sensitive to electrostatic discharge (ESD). Always perform service work at an ESD-protected workstation or mat. If an ESD workstation or mat is not available, touch the sheet-metal chassis to provide a static ground before touching an ESD-sensitive assembly. Protect the ESD-sensitive assemblies by placing them in ESD pouches when they are out of the printer.


 **IMPORTANT:** Make sure that all of the shipping materials (for example shipping tape) are removed from the replacement part prior to installation.

 **NOTE:** If the replacement part is a roller or pad, avoid touching the spongy part of it. Skin oils on the roller or pad can cause paper pickup and/or print-quality problems. HP recommends using disposable gloves when handling rollers or pads or washing your hands before touching rollers or pads.

---

3. To install an assembly, reverse the removal steps.

---

 **NOTE:** When applicable, special installation instructions are provided for an assembly at the end of the removal procedure. Always completely read the removal instructions and follow all special installation instructions.

---

## Ejector unit


## Removal and replacement: Ejector & paper support assembly

Learn how to remove and replace the ejector & paper support assembly.

To view teardown and reassembling video of the inner finisher, click the link below.

 [View a teardown video of the inner finisher.](#)

 [View a reassembling video of the inner finisher.](#)

 **IMPORTANT:** When applicable, special installation instructions are provided for an assembly at the end of the removal procedure. Always completely read the removal instructions and follow all special installation instructions.


Mean time to repair:

Service level:

### Before performing service

#### Turn the printer power off

- Press the power button on the front of the printer, and then turn off the power switch next to the power cable.
- A shutting-down message appears on the control-panel display.

 **WARNING!** To avoid damage to the printer, turn the power off and wait until the printer shuts down before removing the power cable.

- Disconnect the printer power cable after the printer has completely shut down (the control-panel display is blank).

Use the table below to identify the correct part number for your printer. To order the part, go to <http://www.hp.com/buy/parts>.

Table 6-62 Part information

Part number	Part description
SS456-61001	Ejector
JC90-01310A	Front paper support
JC90-01311A	Rear paper support

### Required tools

- #2 JIS screwdriver with a magnetic tip

### After performing service

#### Turn the printer power on

- Connect the power cable.
- Use the power switch to turn the power on.



## Post service test

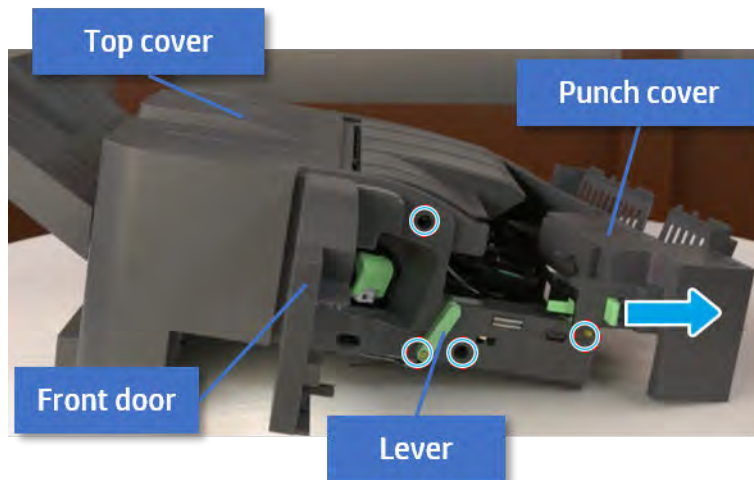
Print any pages necessary to verify that the repair resolved the issue and did not create any new issues.

## Remove the front cover

Follow these steps to remove the front cover.

1. Open the front door and open the punch cover.
2. Remove three screws in the front.
3. Remove the lever.
4. Open the top cover.
5. From the right side of the front cover, carefully lift and pry toward the top-left corner to remove the front cover.

Figure 6-503 Remove the front cover

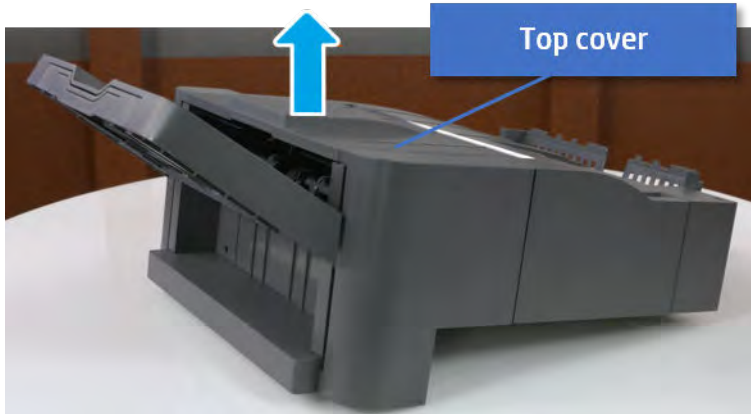


## Remove the rear cover

Follow these steps to remove the rear cover.

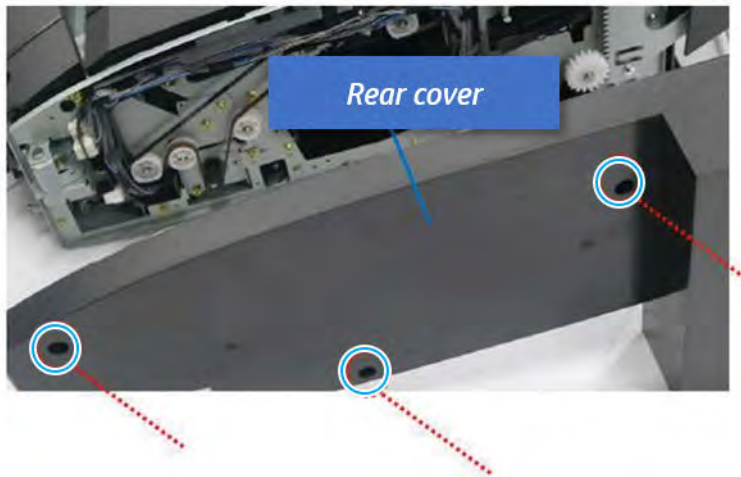
1. Open the top cover.

Figure 6-504 Open the top cover



2. Remove three screws.
3. Release hooks carefully and remove the rear cover.

Figure 6-505 Remove the rear cover

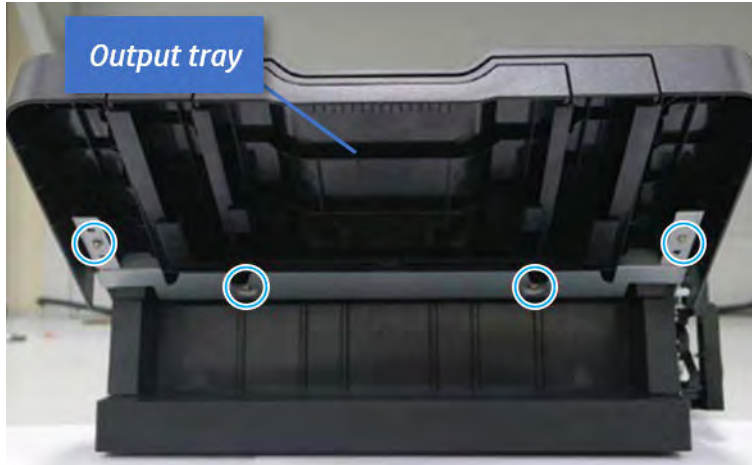


### Remove the output tray

Follow these steps to remove the output tray.

1. Remove four screws.

Figure 6-506 Remove four screws



2. Push the paper holding actuator into the inner finisher, and then remove the output tray.

Figure 6-507 Remove the output tray.

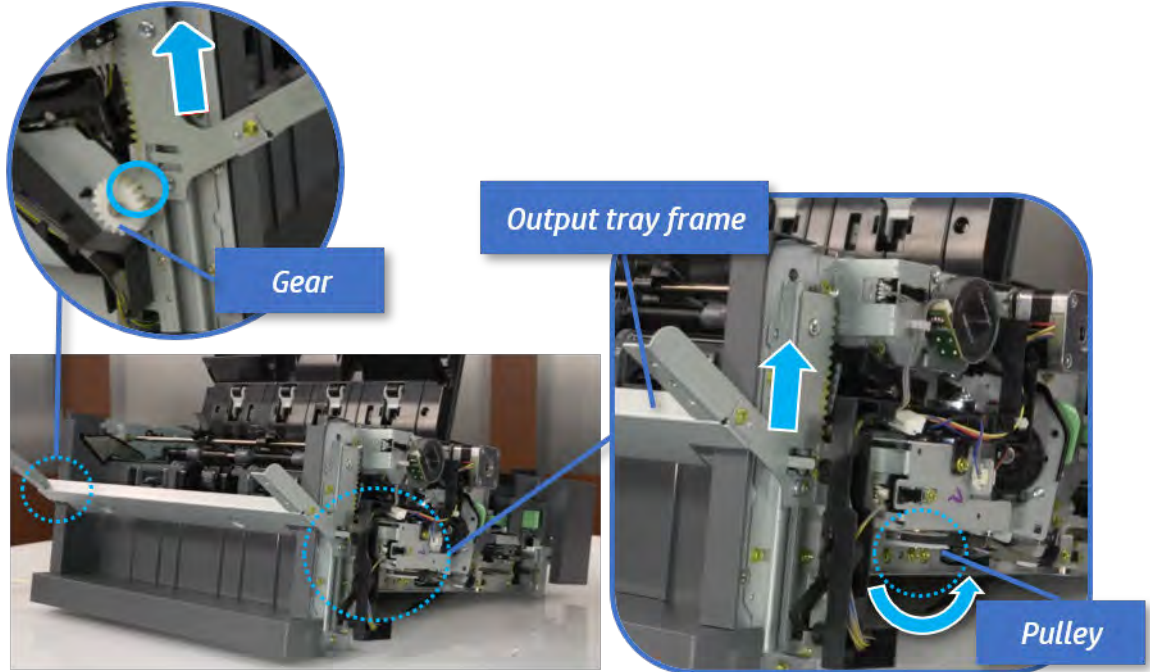


### Remove the output tray frame

Follow these steps to remove the output tray frame.

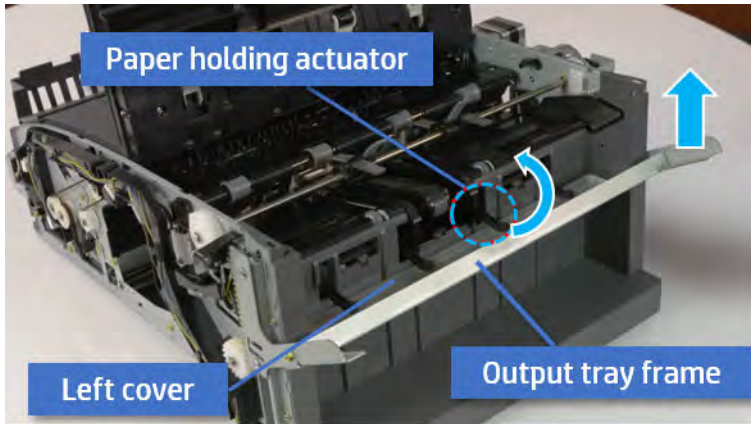
1. Rotate the pulley until the output tray frame depart from the gear.

Figure 6-508 Remove the pulley



2. Push the paper holding actuator into the inner finisher, and then remove the output tray frame.

Figure 6-509 Remove the output tray frame

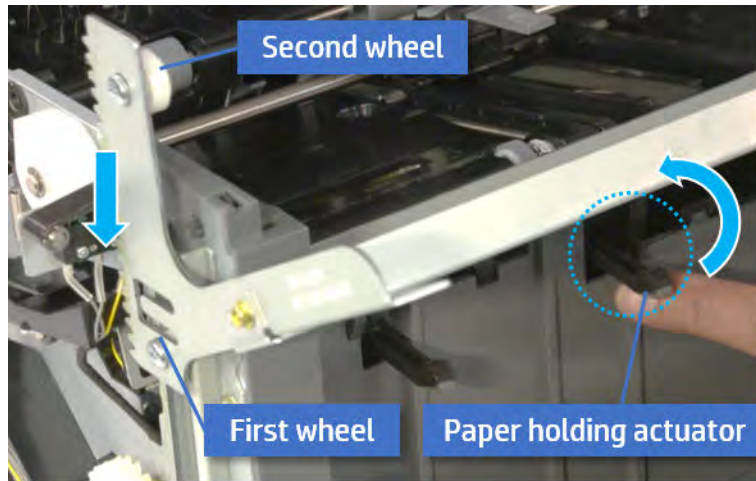


---

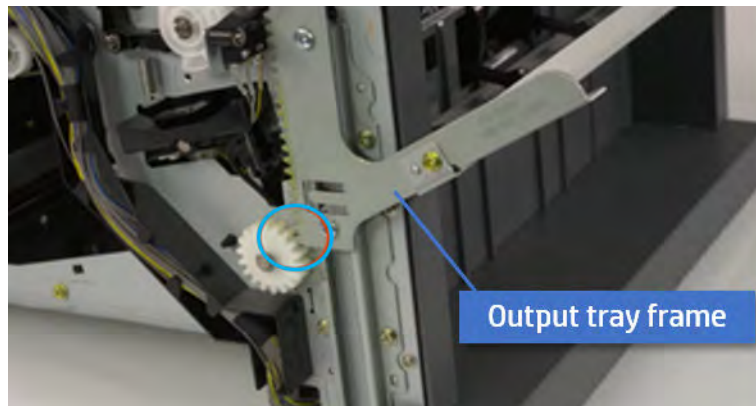
 **TIP:** Push the paper holding actuator into the inner finisher when reassembling. Be sure to level the output tray.

---

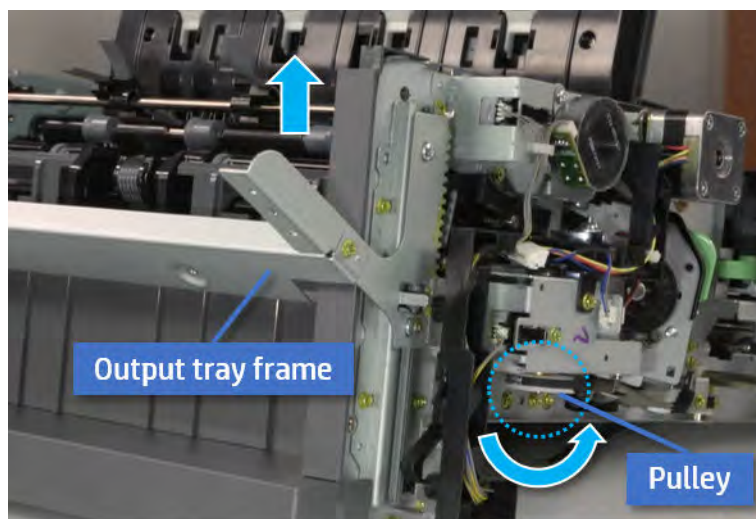
- a. Position the first wheel into the channel on both sides while pushing the paper holding actuator.



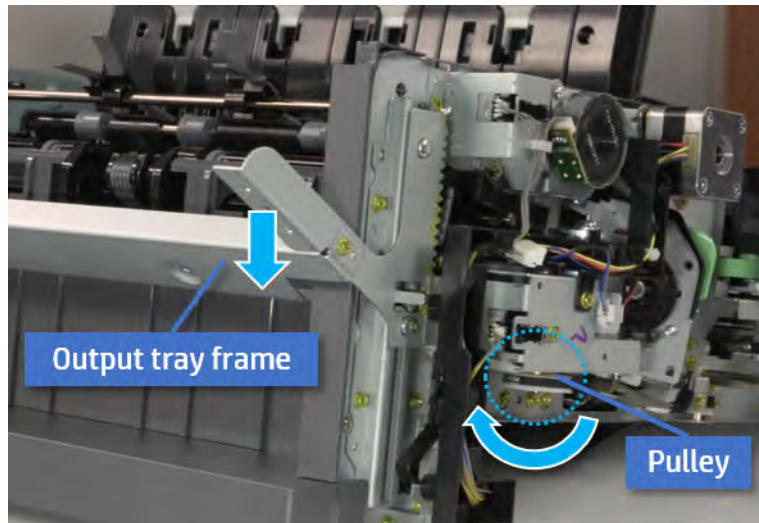
- b. Let the second wheel rest on the channel on both sides simultaneously.
- c. Gently squeeze the wheels into channel until the output tray frame meet the gear.



- d. Rotate the pulley until the output tray frame is no longer lifted. It can make to level the output tray frame.



- e. Rotate the pulley in the opposite direction.

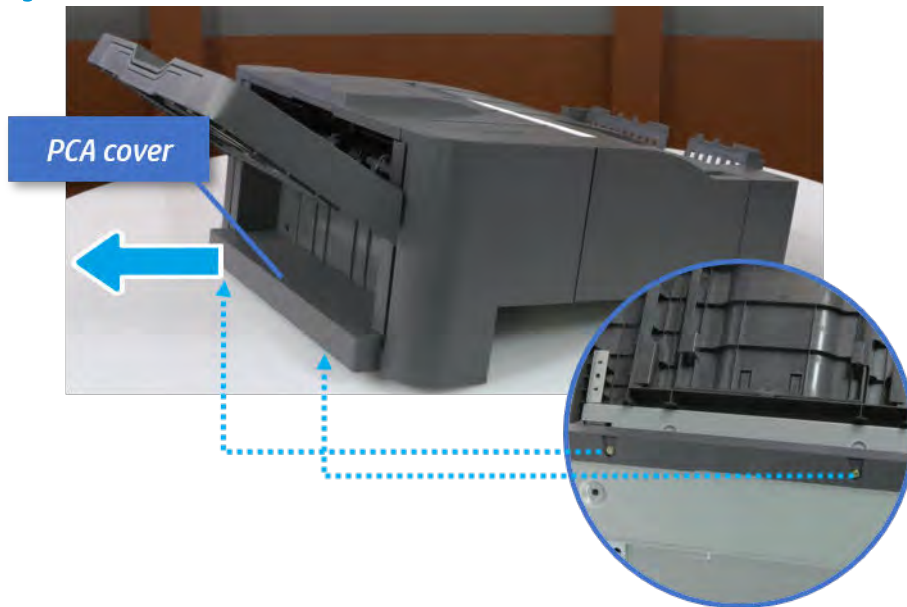


### Remove the PCA cover

Follow these steps to remove the PCA cover.

- ▲ Remove two screws, and then remove the PCA cover.

Figure 6-510 Remove the PCA cover

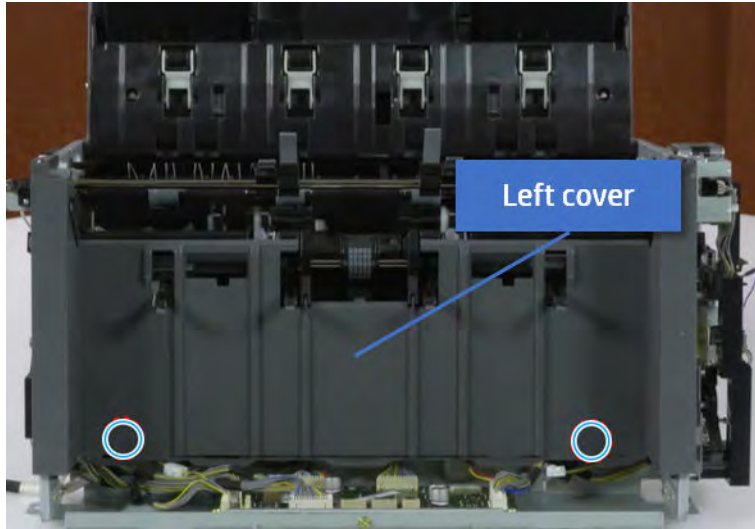


### Remove the left cover

Follow these steps to remove the left cover.

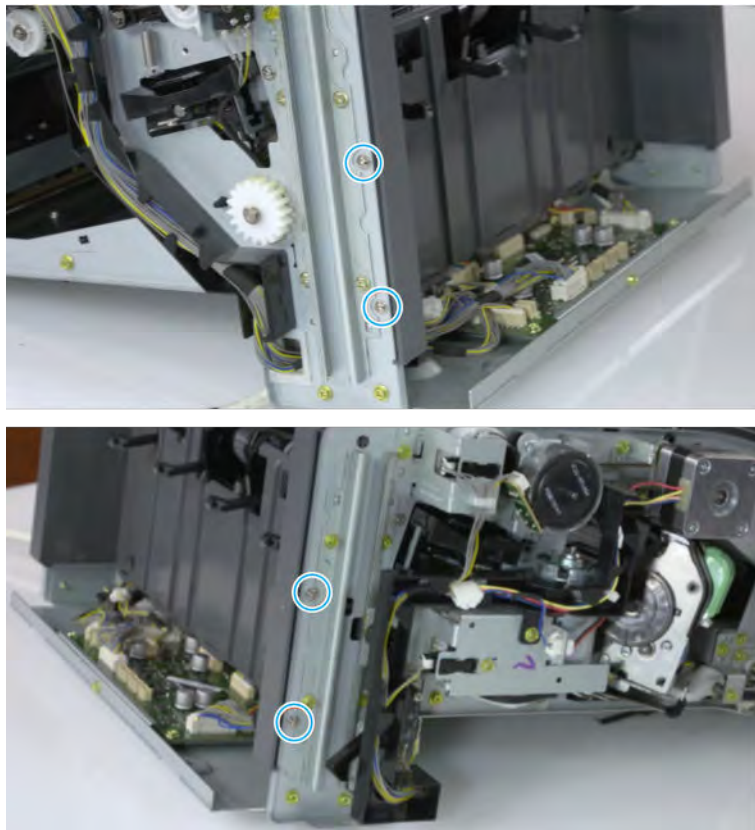
1. Remove two screws.

Figure 6-511 Remove two screws



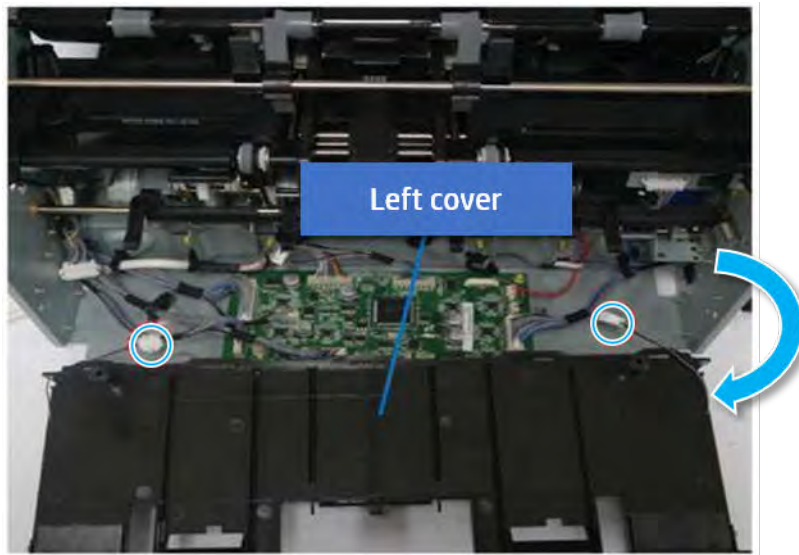
2. Remove four screws from both front and rear sides.


Figure 6-512 Remove four screws

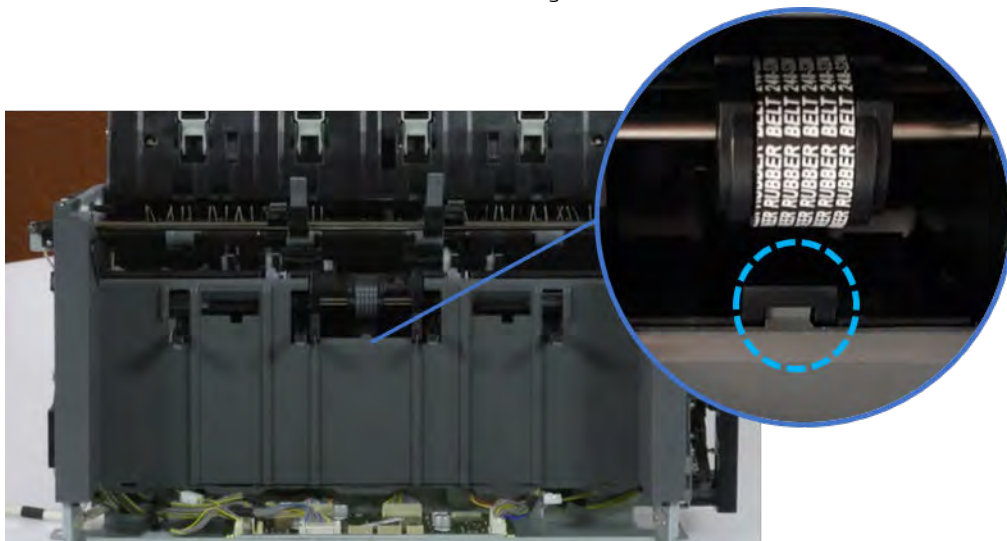


3. Unplug two inline connectors, and then remove the left cover.

**Figure 6-513** Unplug two connectors



 **TIP:** Be sure to check the hook when reassembling.



### Remove the front harness guide

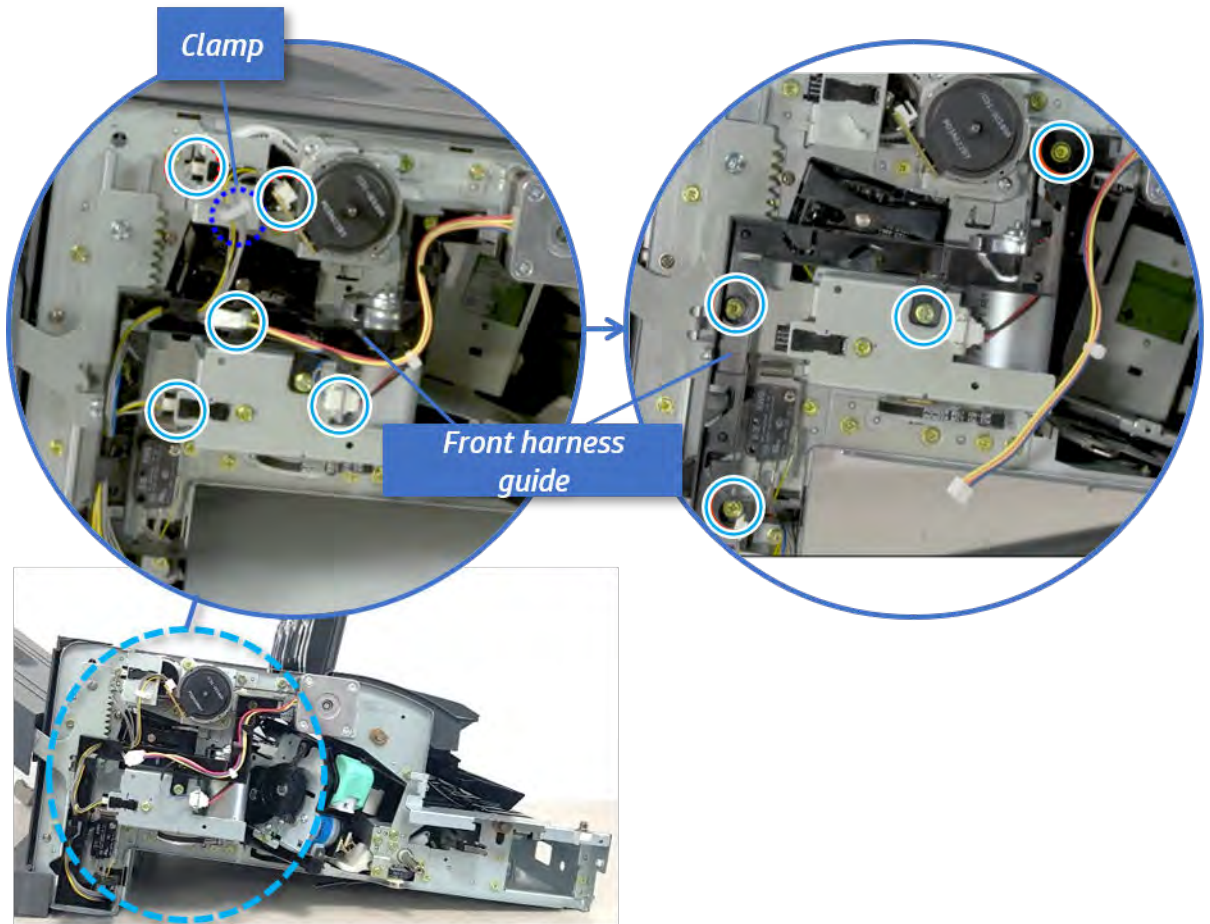
Follow these steps to remove the front harness guide.

1. Open one clamp and unplug five connectors, and then remove the wire harness from the front harness guide.



2. Remove four screws, and then remove the front harness guide.

Figure 6-514 Remove the front harness guide

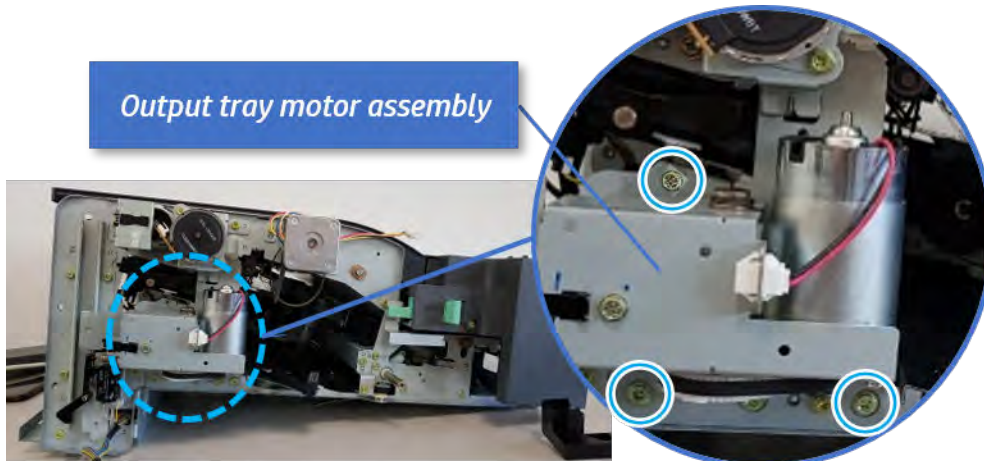


### Remove the output tray motor assembly

Follow these steps to remove the output tray motor assembly.

- ▲ Remove three screws, and then remove the output tray motor assembly.

Figure 6-515 Remove the output tray motor assembly

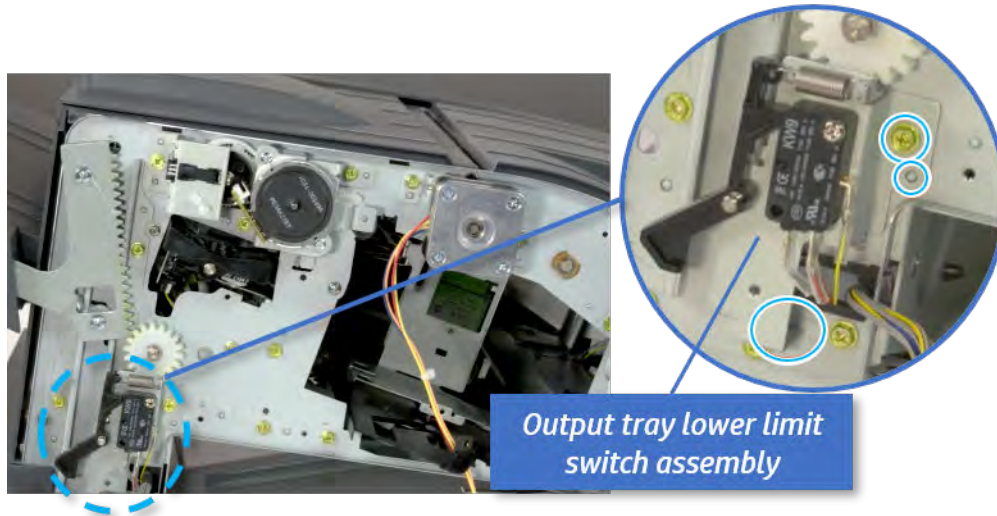


## Remove the output tray lower limit switch

Follow these steps to remove the output tray lower limit switch.

- ▲ Remove one screw, and then remove the output tray lower limit switch.

**Figure 6-516** Remove the output tray lower limit switch

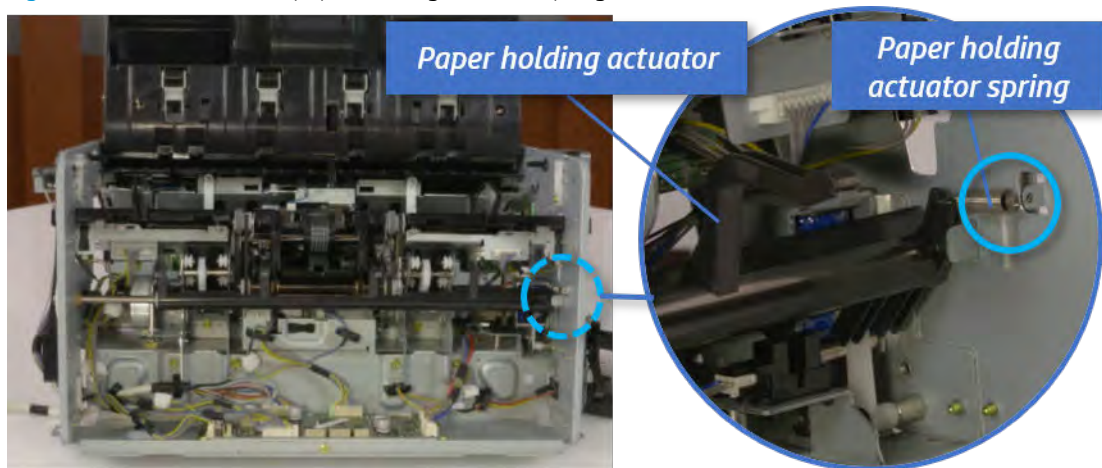


## Remove the paper holding

Follow these steps to remove the paper holding.

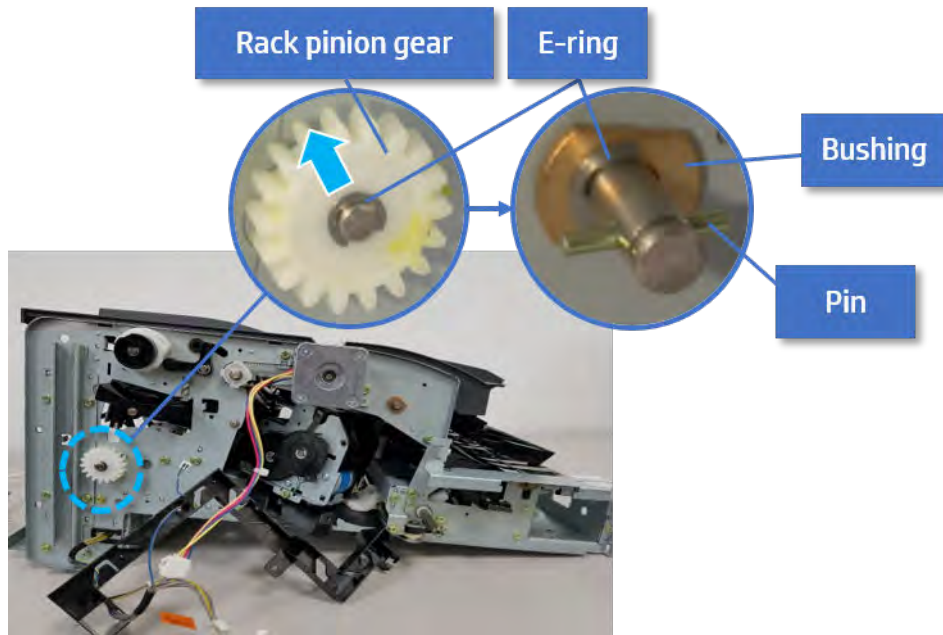
1. Remove the paper holding actuator spring.


**Figure 6-517** Remove the paper holding actuator spring



2. Remove the e-ring and the rack pinion gear. And then remove the pin and the e-ring, and then remove the bushing.

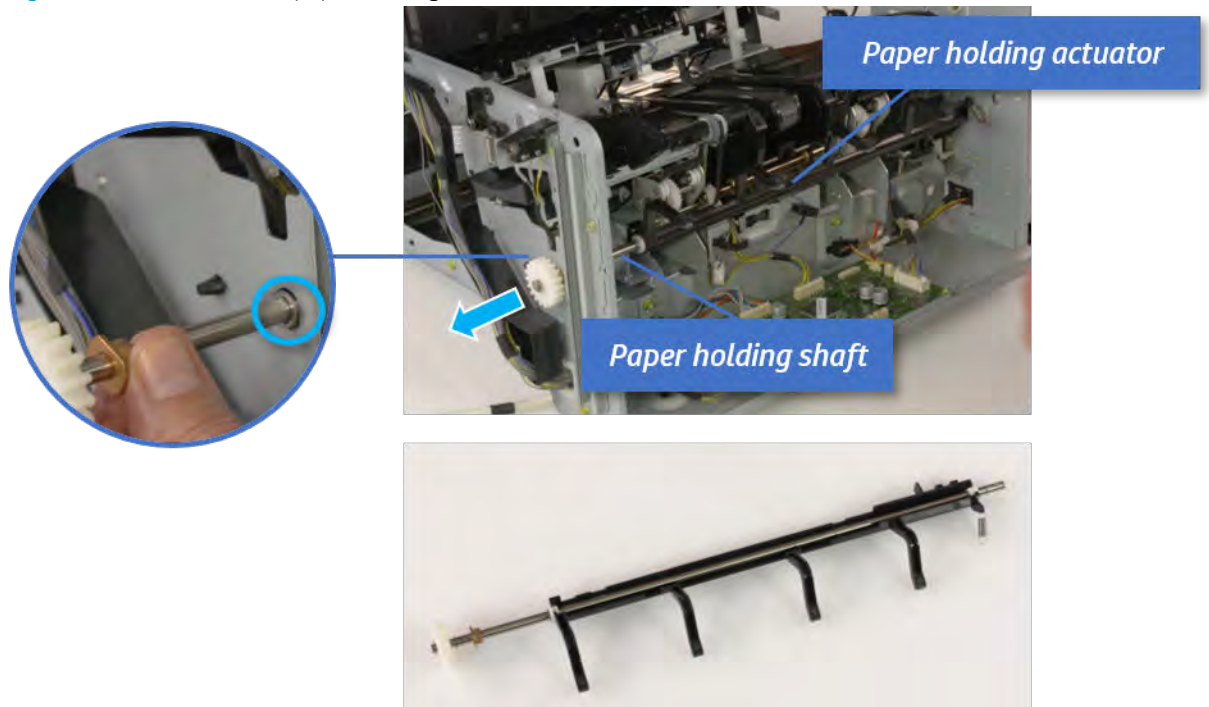
**Figure 6-518** Remove e-ring, rack pinion gear, pin, and bushing



 **NOTE:** Be sure not to lose the pin.

3. Carefully remove the paper holding shaft and the actuator.

**Figure 6-519** Remove the paper holding shaft and the actuator

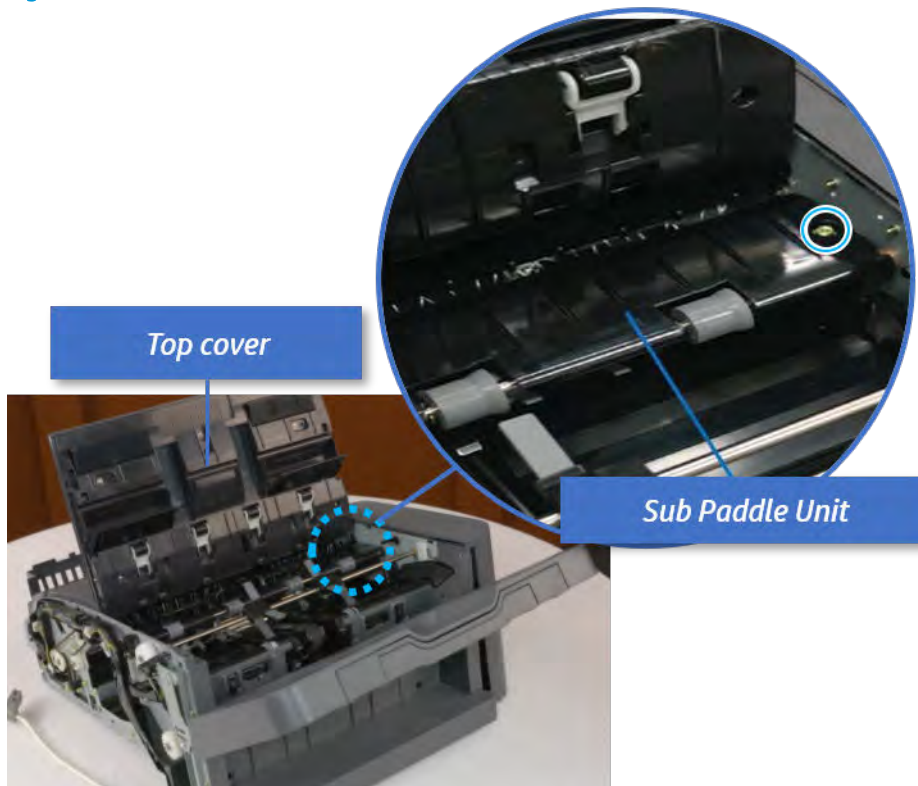


### Remove the sub paddle unit

Follow these steps to remove the sub paddle unit.

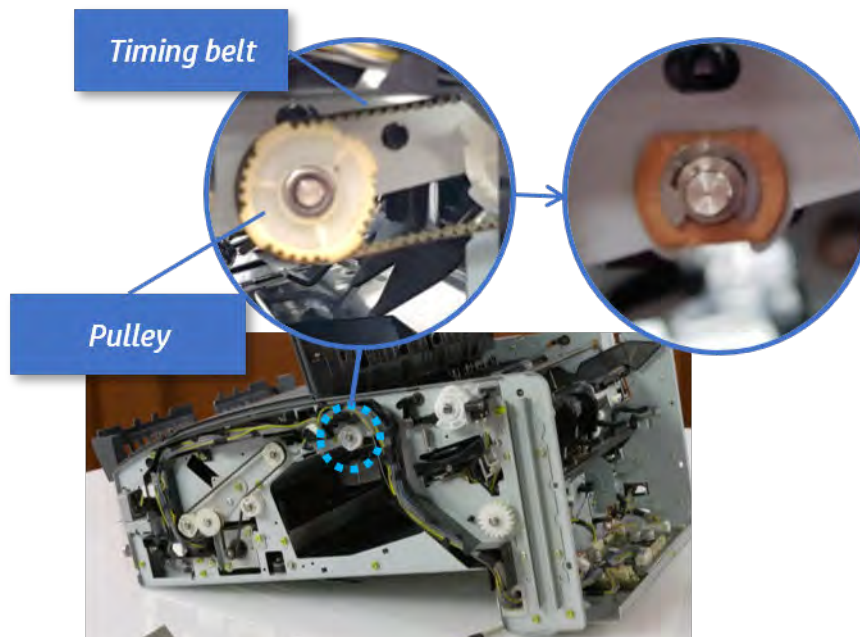
1. Open the top cover, and then remove one screw securing the sub paddle unit.

Figure 6-520 Remove one screw



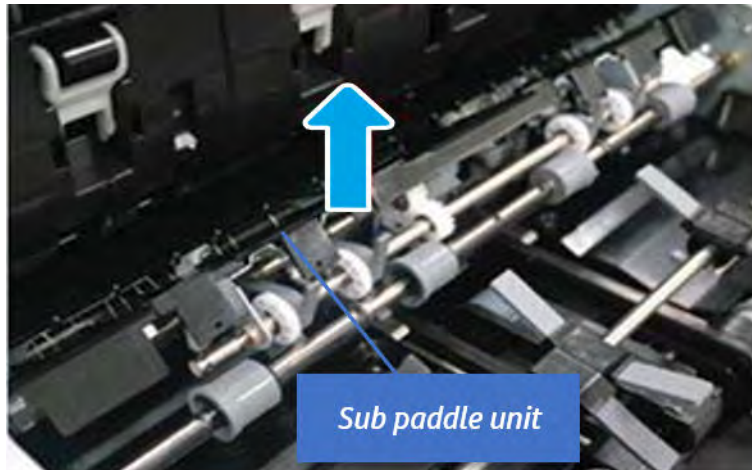
2. Remove the e-ring, and then remove the pulley and timing belt. And then remove the e-ring and the bushing.

Figure 6-521 Remove the e-ring, pulley, timing belt, and bushing



3. Lift up and remove the sub paddle unit.

Figure 6-522 Remove the sub paddle unit

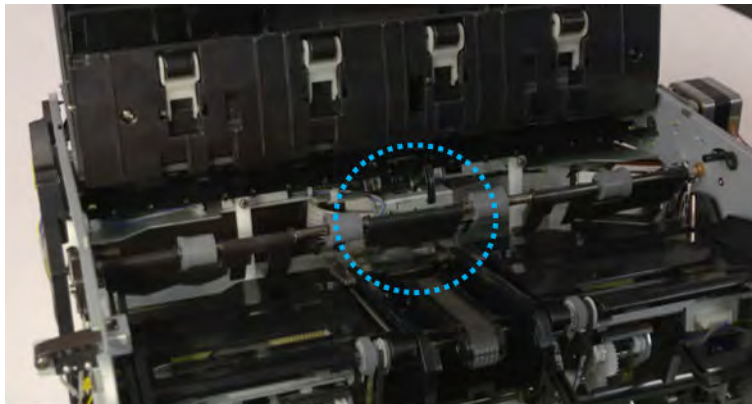


### Remove the exit roller

Follow these steps to remove the exit roller.

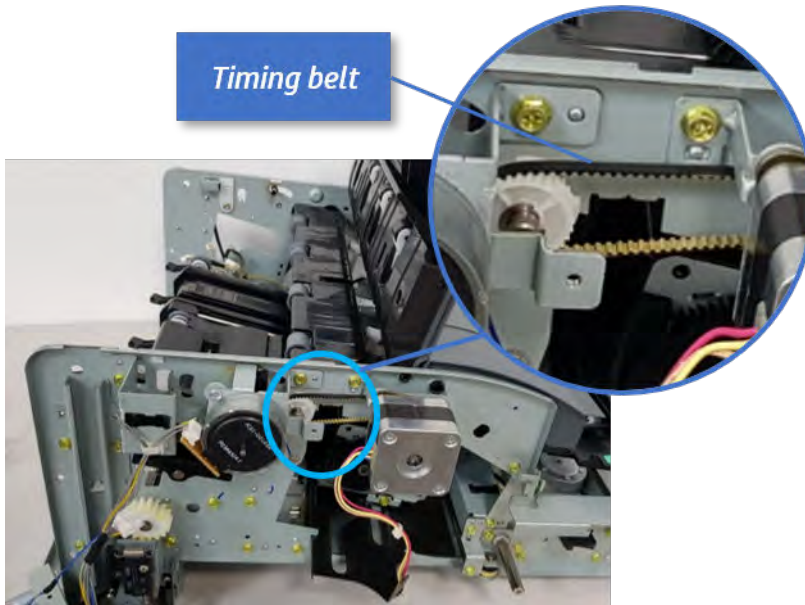
1. Remove the guide on the center of the exit roller.

Figure 6-523 Remove the guide



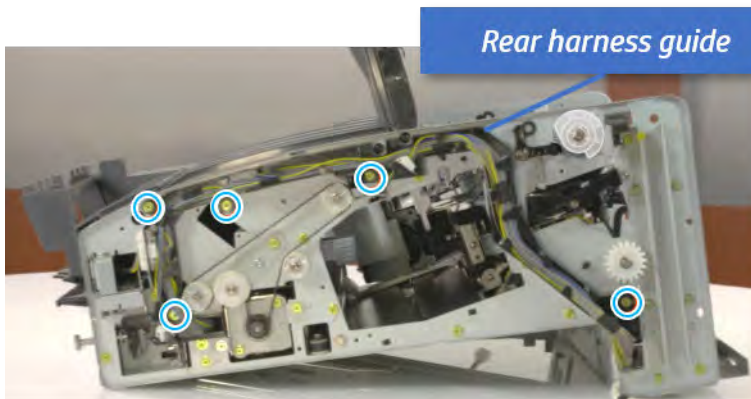
2. On the front of the inner finisher, release the timing belt connected to the exit motor.

Figure 6-524 Release the timing belt



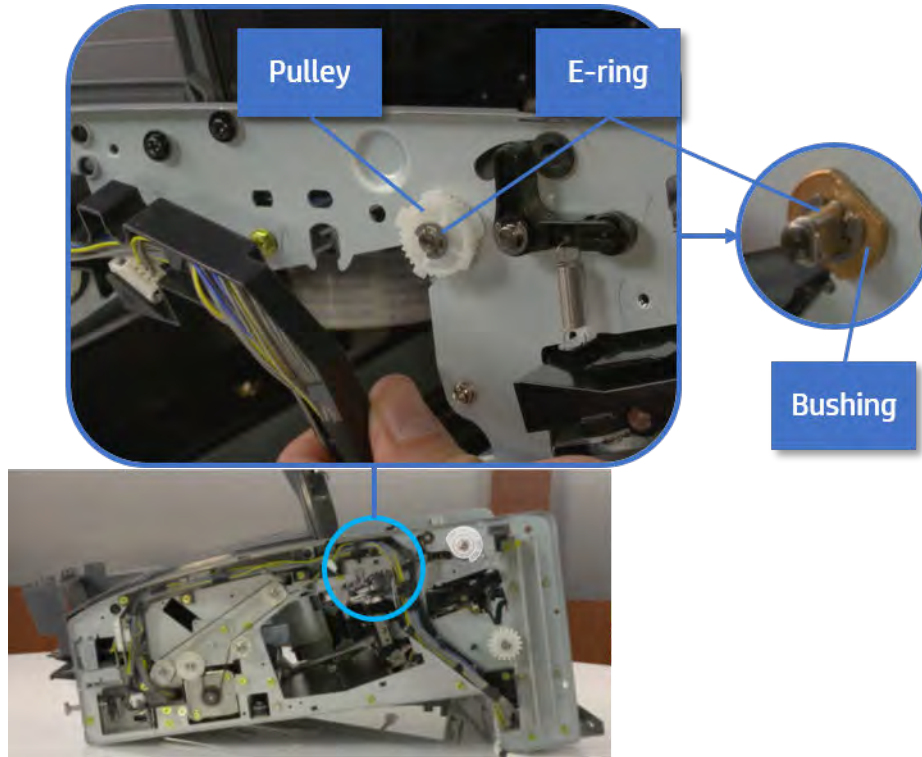
3. Remove five screws securing the rear harness guide.

Figure 6-525 Remove five screws



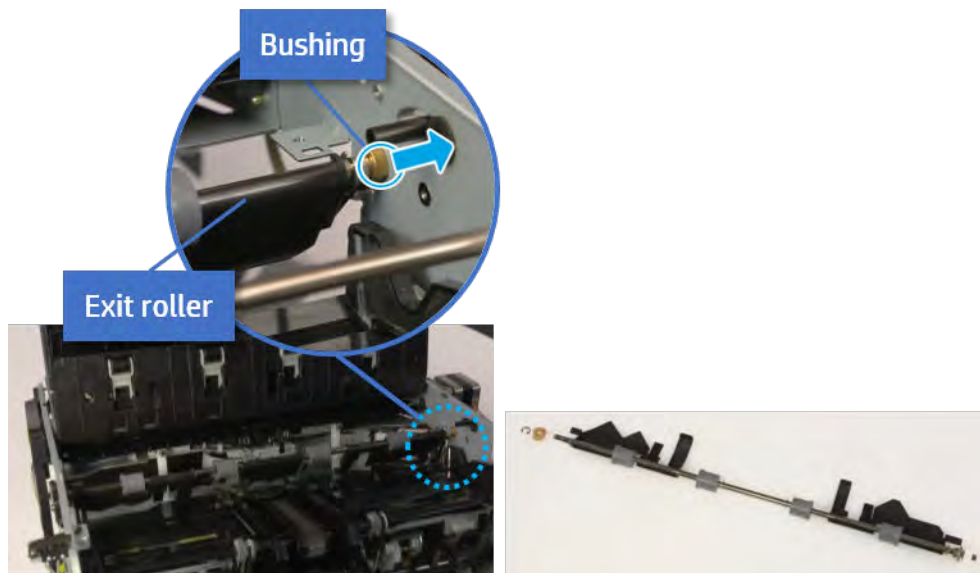
4. On the rear of the inner finisher, remove the e-ring and the pulley and then remove the e-ring and the bushing.

Figure 6-526 Remove e-ring, pulley, and bushing



5. Push the bushing to detach it, and then remove the exit roller.

Figure 6-527 Remove the exit roller

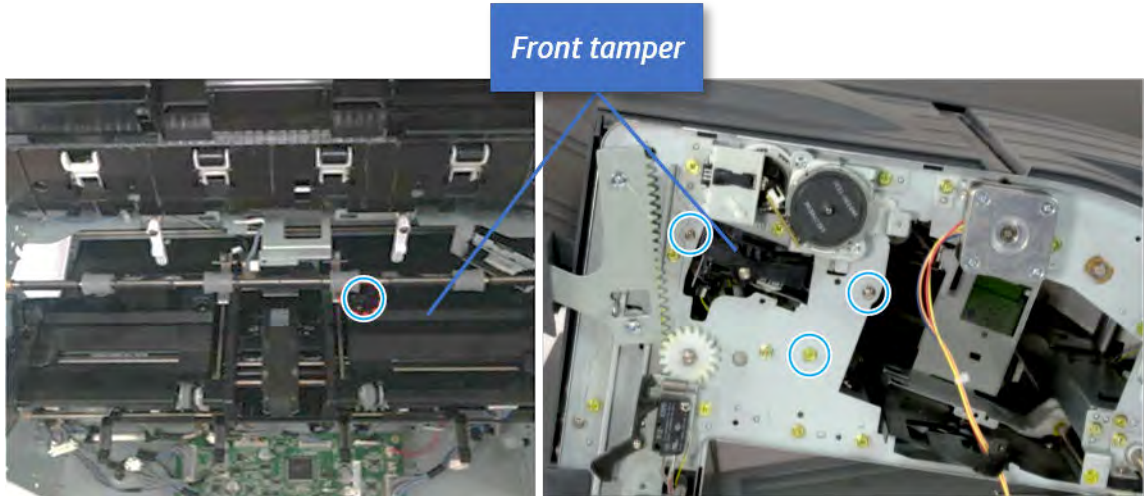


### Remove the front tamper

Follow these steps to remove the front tamper.

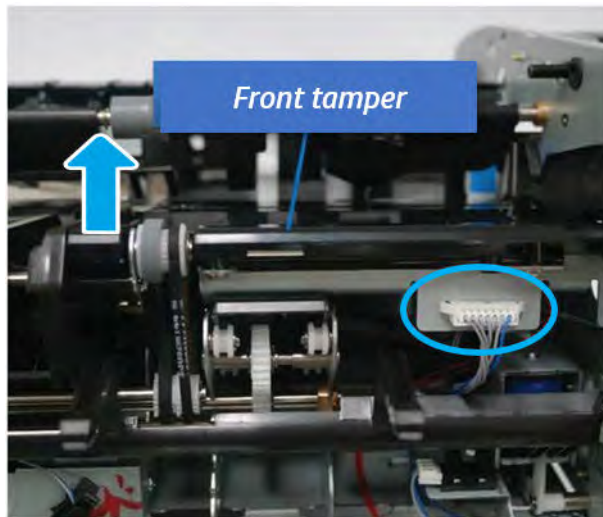
1. Remove four screws.

Figure 6-528 Remove four screws



2. Unplug the connector and release the hook, and then pull the front tamper up to remove.

Figure 6-529 Remove the front tamper



### Remove the rear tamper

Follow these steps to remove the rear tamper.

1. Remove four screws.


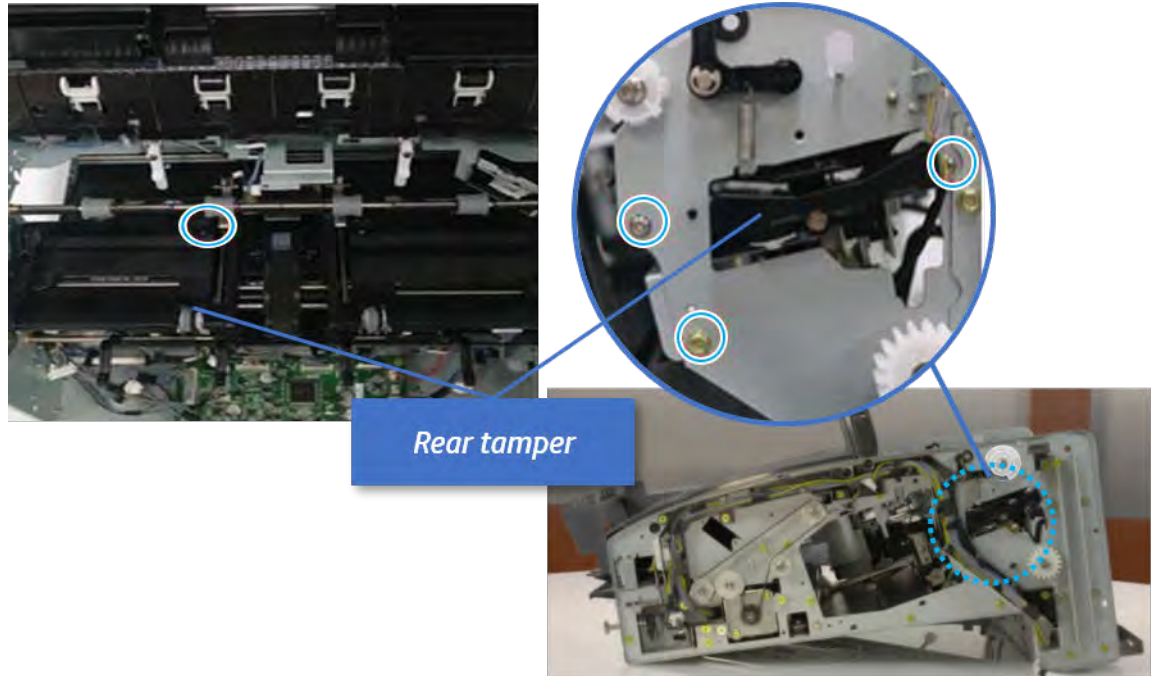
 **NOTE:** Move cable guide out of position to access the screws.

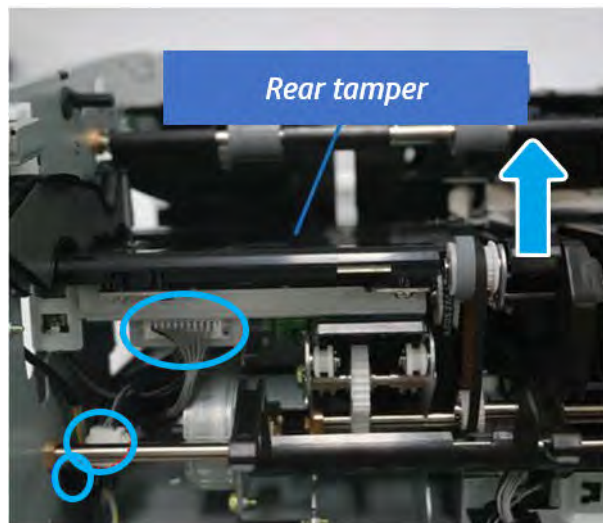


Figure 6-530 Remove four screws



2. Unplug two connectors and release the hook, and then remove the rear tamper.

Figure 6-531 Remove the rear tamper

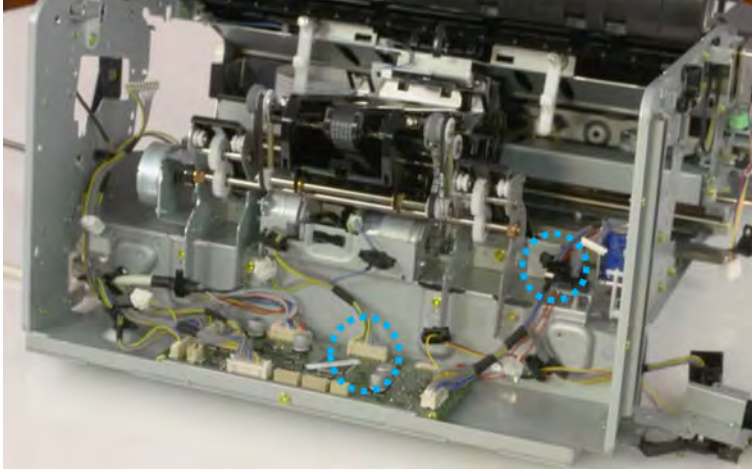


### Remove the ejector & paper support assembly

Follow these steps to remove the ejector & paper support assembly.

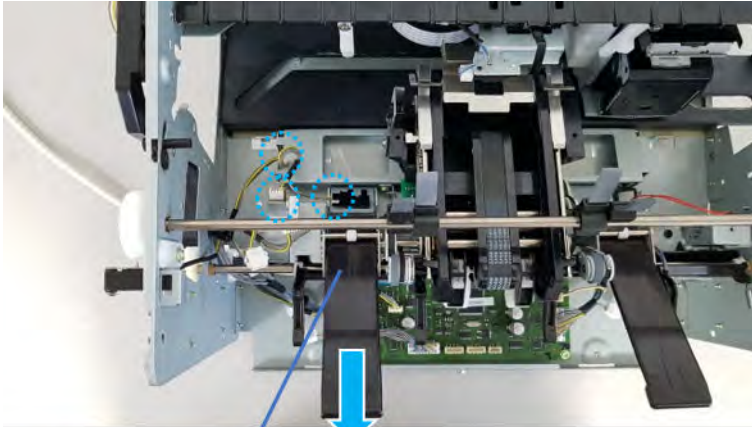
1. Open one clamp, disconnect one connector.

Figure 6-532 Disconnect one connector



2. Pull the rear paper support up, and then release one clamp and disconnect two connectors.

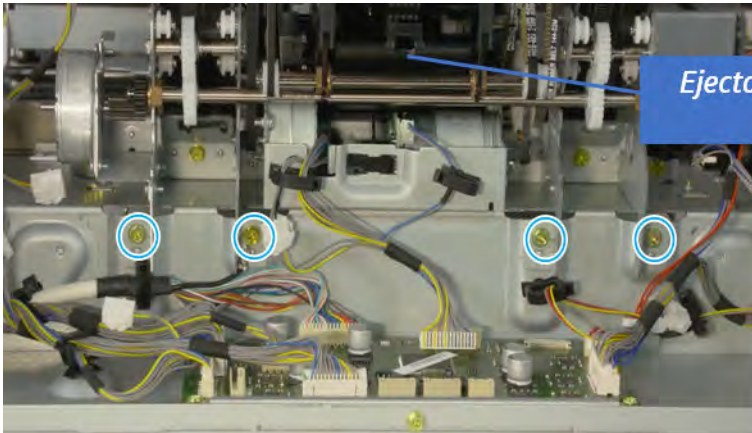
Figure 6-533 Disconnect two connector



*Rear paper support*

3. Remove four screws, and then remove the ejector & paper support assembly.

Figure 6-534 Remove the ejector & paper support assembly



*Ejector & paper support  
assembly*

## Unpack the replacement assembly

Follow these steps to unpack the replacement assembly.

1. Dispose of the defective part.




**NOTE:** HP recommends responsible disposal of the defective part.

<http://www8.hp.com/us/en/hp-information/environment/product-recycling.html>

---

2. Unpack the replacement part from the packaging.



**CAUTION:**  Some parts are sensitive to electrostatic discharge (ESD). Always perform service work at an ESD-protected workstation or mat. If an ESD workstation or mat is not available, touch the sheet-metal chassis to provide a static ground before touching an ESD-sensitive assembly. Protect the ESD-sensitive assemblies by placing them in ESD pouches when they are out of the printer.



**IMPORTANT:** Make sure that all of the shipping materials (for example shipping tape) are removed from the replacement part prior to installation.



**NOTE:** If the replacement part is a roller or pad, avoid touching the spongy part of it. Skin oils on the roller or pad can cause paper pickup and/or print-quality problems. HP recommends using disposable gloves when handling rollers or pads or washing your hands before touching rollers or pads.

---

3. To install an assembly, reverse the removal steps.



**NOTE:** When applicable, special installation instructions are provided for an assembly at the end of the removal procedure. Always completely read the removal instructions and follow all special installation instructions.

---

## Removal and replacement: Ejector motor assembly (S11/ M6/ M7)


Learn how to remove and replace the ejector motor assembly.

To view teardown and reassembling video of the inner finisher, click the link below.

 [View a teardown video of the inner finisher.](#)

 [View a reassembling video of the inner finisher.](#)

---

 **IMPORTANT:** When applicable, special installation instructions are provided for an assembly at the end of the removal procedure. Always completely read the removal instructions and follow all special installation instructions.

---

Mean time to repair:


Service level:

### Before performing service

#### Turn the printer power off

- Press the power button on the front of the printer, and then turn off the power switch next to the power cable.
- A shutting-down message appears on the control-panel display.

---

 **WARNING!** To avoid damage to the printer, turn the power off and wait until the printer shuts down before removing the power cable.

---

- Disconnect the printer power cable after the printer has completely shut down (the control-panel display is blank).

Use the table below to identify the correct part number for your printer. To order the part, go to [www.hp.com/buy/parts](http://www.hp.com/buy/parts).

Table 6-63 Part information

Part number	Part description
JC90-01309A (not orderable)	Ejector motor assembly

### Required tools

- #2 JIS screwdriver with a magnetic tip

### After performing service

#### Turn the printer power on

- Connect the power cable.
- Use the power switch to turn the power on.

### Post service test

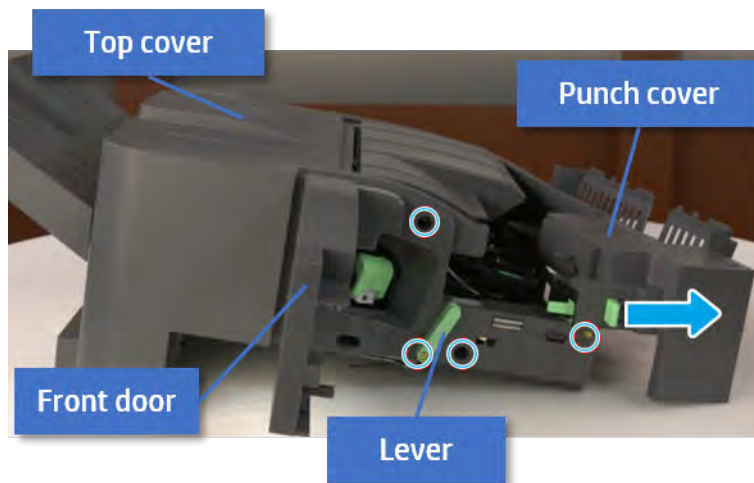
Print any pages necessary to verify that the repair resolved the issue and did not create any new issues.

## Remove the front cover

Follow these steps to remove the front cover:

1. Open the front door and open the punch cover.
2. Remove three screws in the front.
3. Remove the lever.
4. Open the top cover.
5. From the right side of the front cover, carefully lift and pry toward the top-left corner to remove the front cover.

Figure 6-535 Remove the front cover

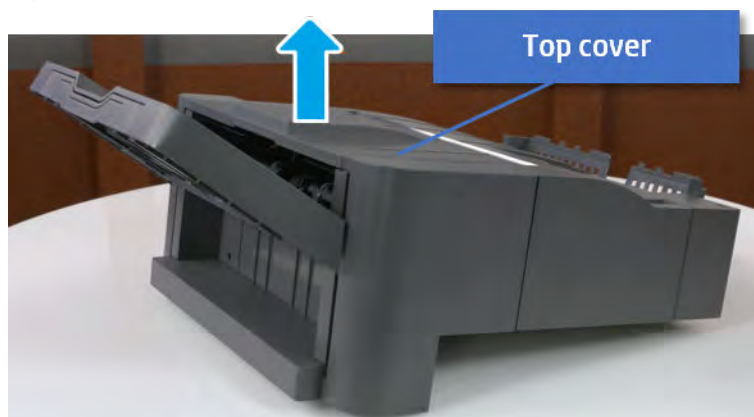


## Remove the rear cover

Follow these steps to remove the rear cover:

1. Open the top cover.

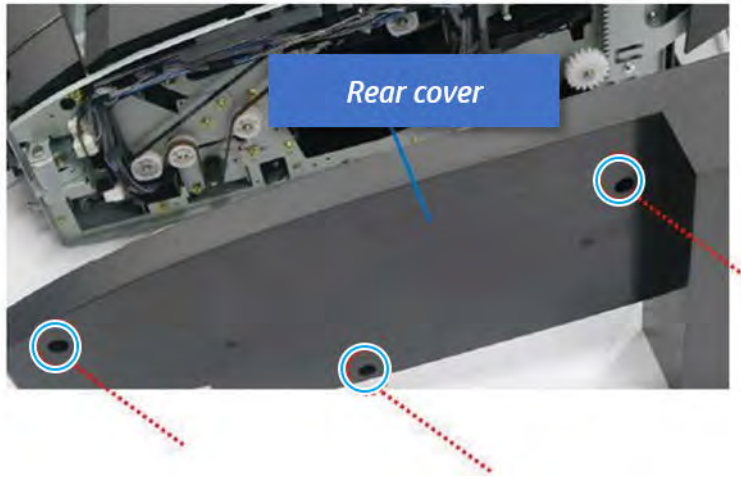
Figure 6-536 Open the top cover



2. Remove three screws.

3. Release hooks carefully and remove the rear cover.

**Figure 6-537** Remove the rear cover

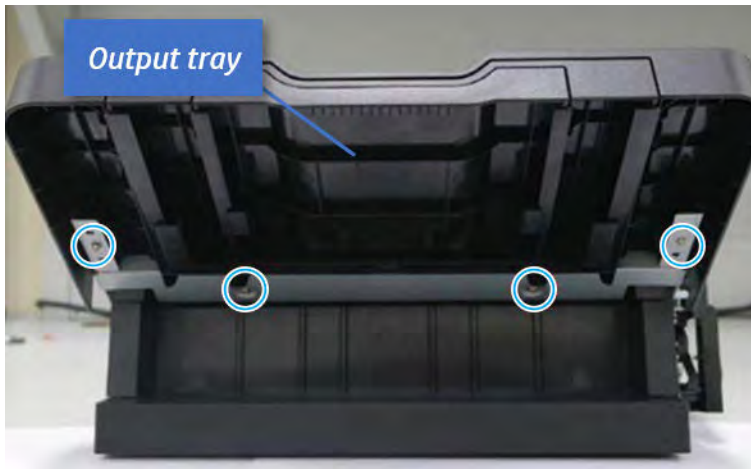


### Remove the output tray

Follow these steps to remove the output tray.

1. Remove four screws.

**Figure 6-538** Remove four screws



2. Push the paper holding actuator into the inner finisher, and then remove the output tray.

Figure 6-539 Remove the output tray.

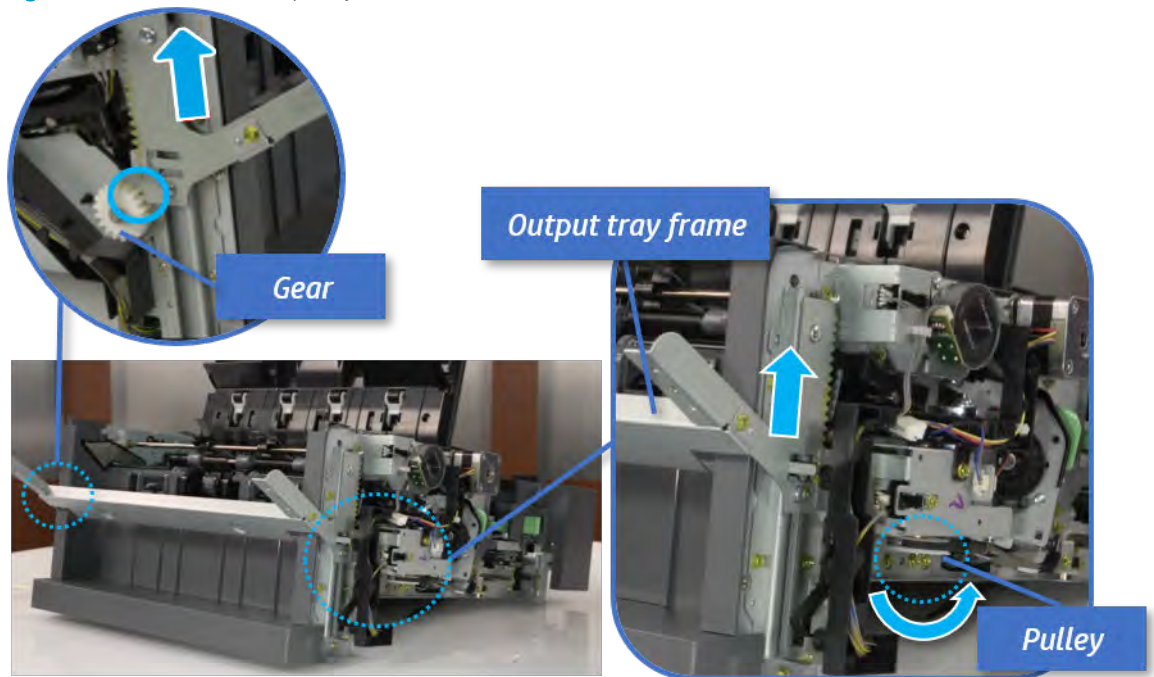


### Remove the output tray frame

Follow these steps to remove the output tray frame.

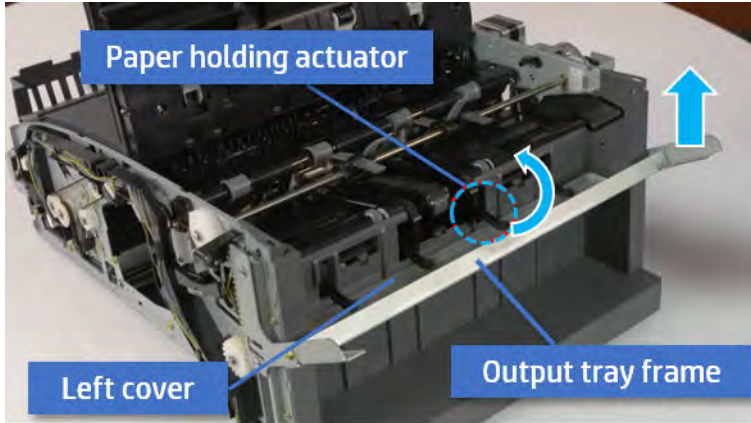
1. Rotate the pulley until the output tray frame depart from the gear.

Figure 6-540 Remove the pulley



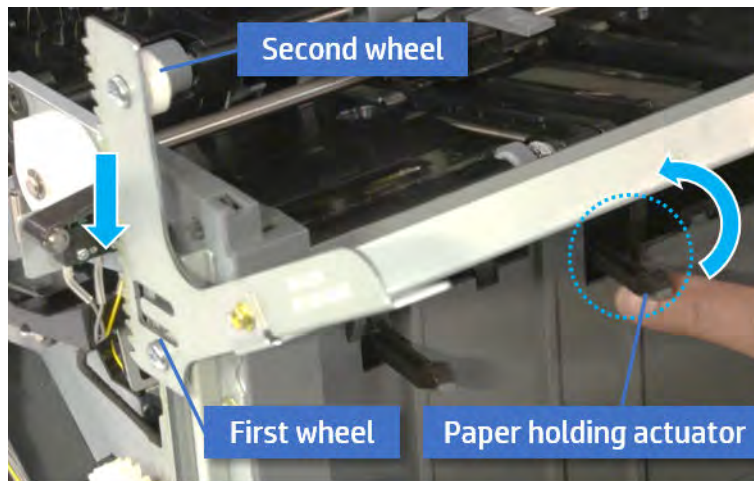
2. Push the paper holding actuator into the inner finisher, and then remove the output tray frame.

Figure 6-541 Remove the output tray frame

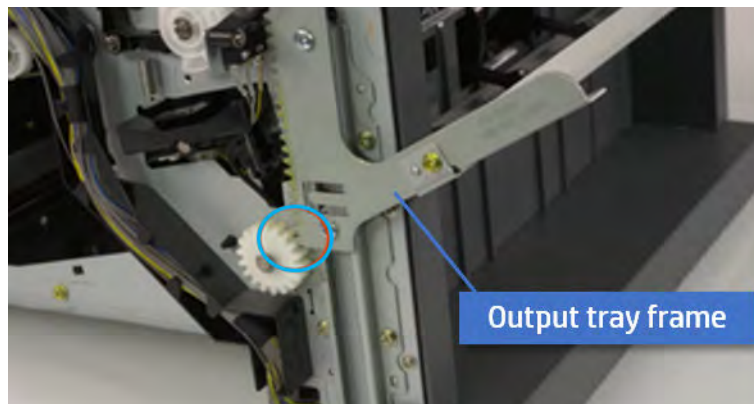


**TIP:** Push the paper holding actuator into the inner finisher when reassembling. Be sure to level the output tray.

- a. Position the first wheel into the channel on both sides while pushing the paper holding actuator.

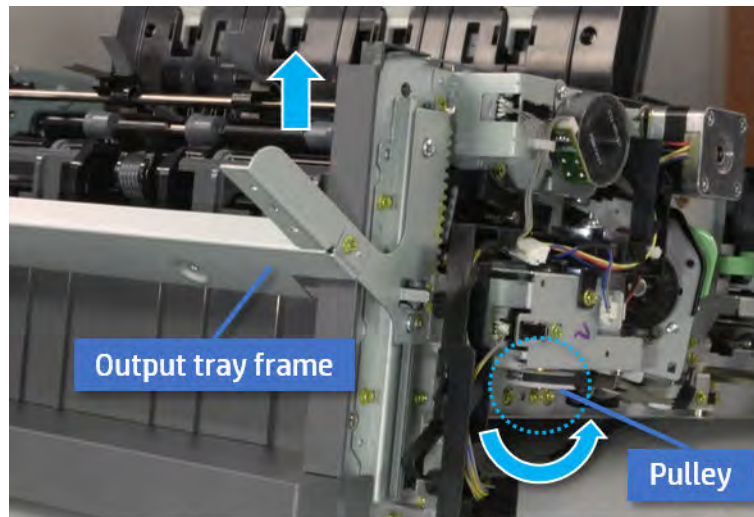


- b. Let the second wheel rest on the channel on both sides simultaneously.
- c. Gently squeeze the wheels into channel until the output tray frame meet the gear.

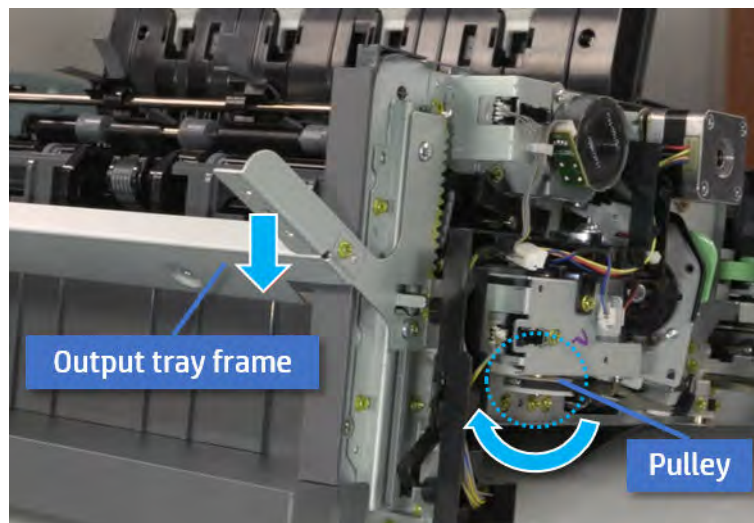




- d. Rotate the pulley until the output tray frame is no longer lifted. It can make to level the output tray frame.



- e. Rotate the pulley in the opposite direction.

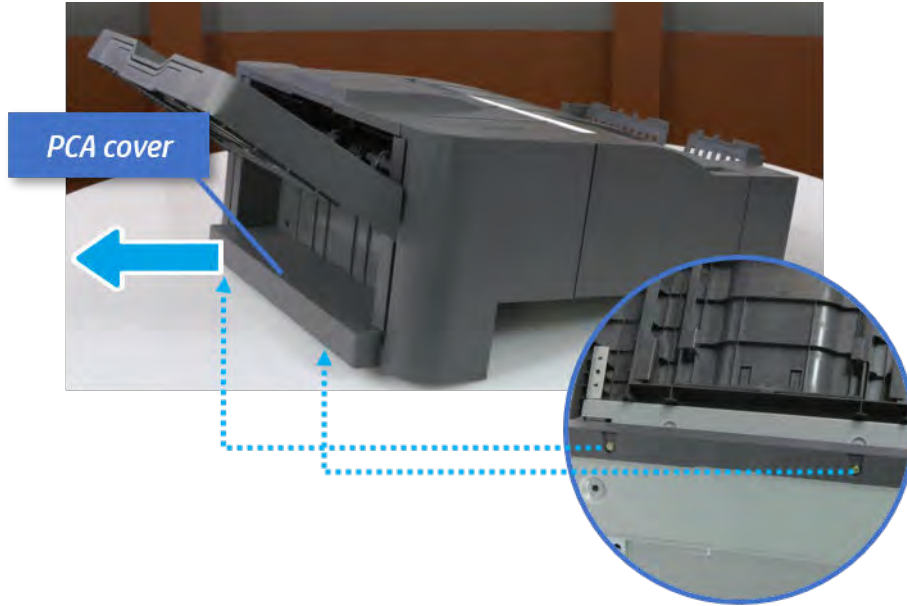


### Remove the PCA cover

Follow these steps to remove the PCA cover.

- ▲ Remove two screws, and then remove the PCA cover.

Figure 6-542 Remove the PCA cover

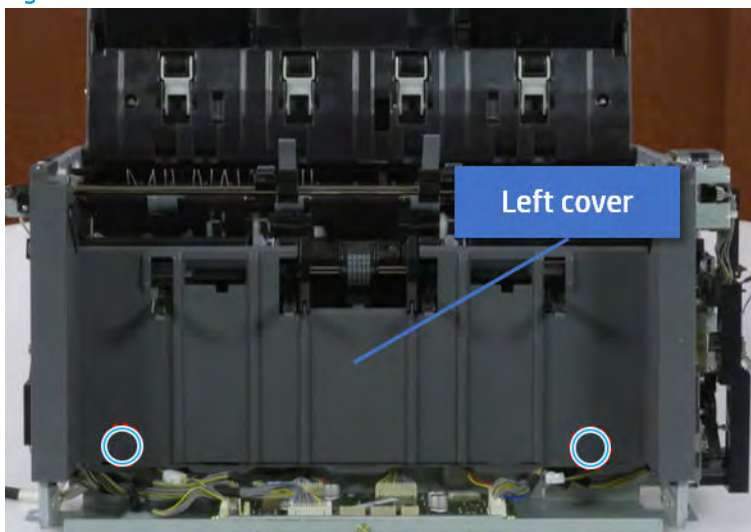


### Remove the left cover

Follow these steps to remove the left cover.

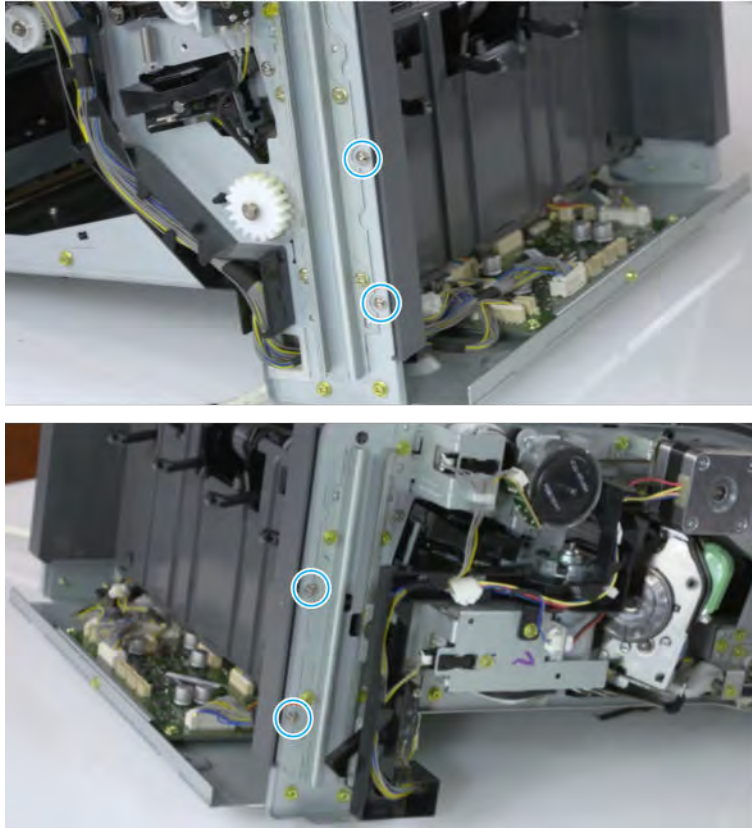
1. Remove two screws.

Figure 6-543 Remove two screws



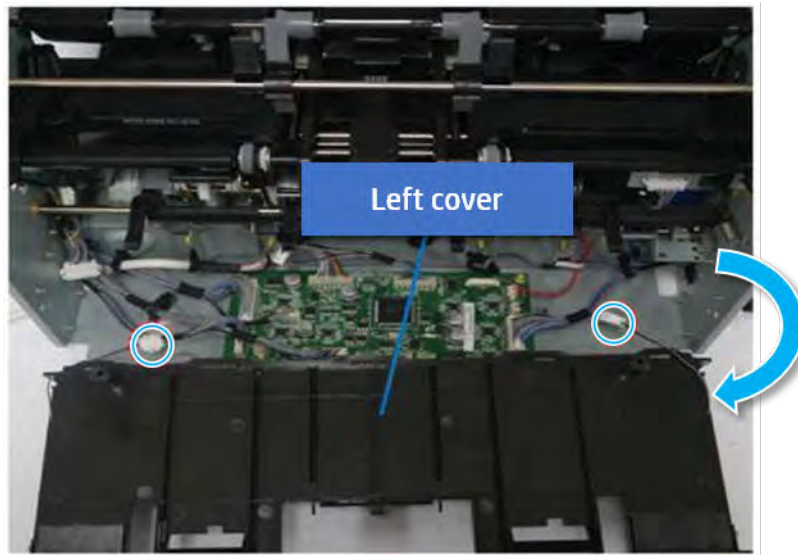
2. Remove four screws from both front and rear sides.


Figure 6-544 Remove four screws

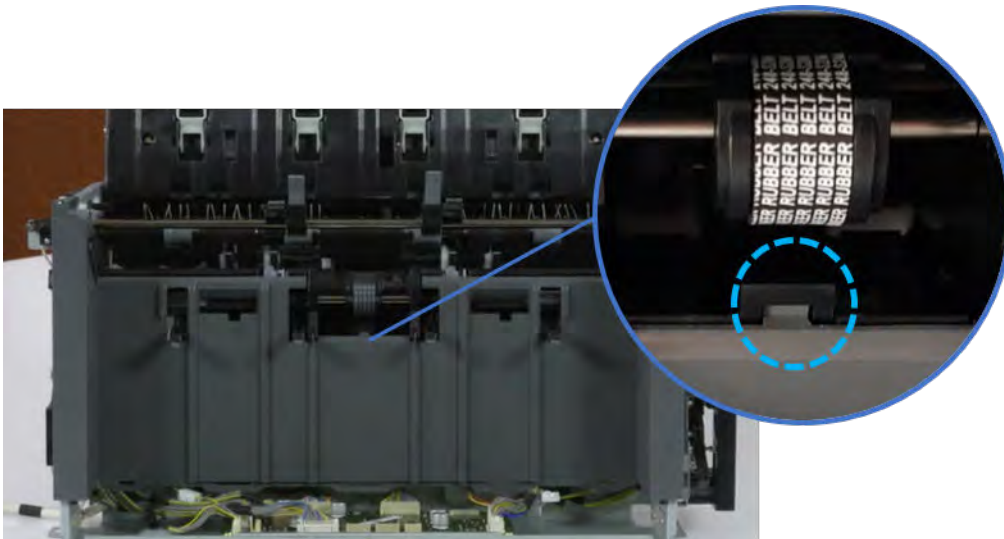


3. Unplug two inline connectors, and then remove the left cover.

Figure 6-545 Unplug two connectors



 **TIP:** Be sure to check the hook when reassembling.



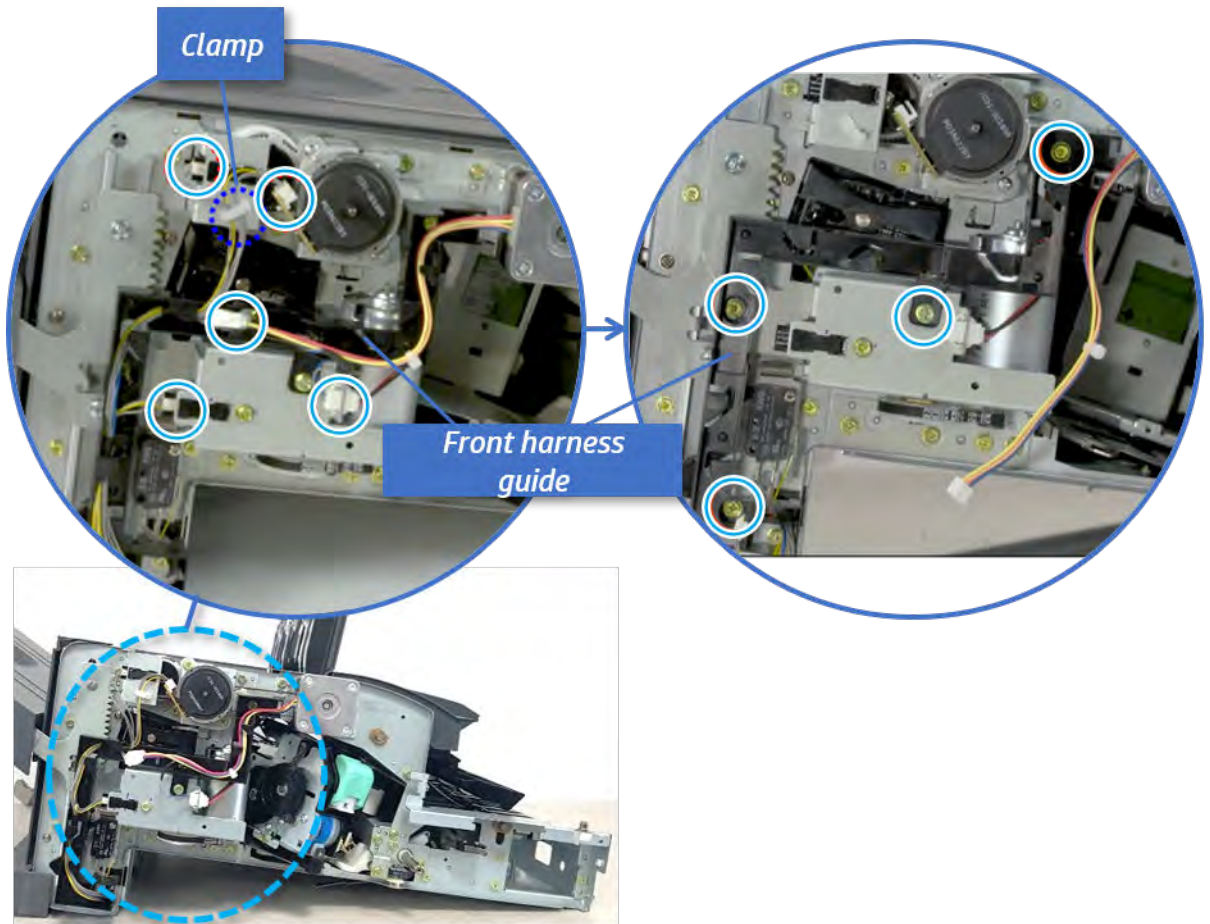
### Remove the front harness guide

Follow these steps to remove the front harness guide.

1. Open one clamp and unplug five connectors, and then remove the wire harness from the front harness guide.

2. Remove four screws, and then remove the front harness guide.

Figure 6-546 Remove the front harness guide

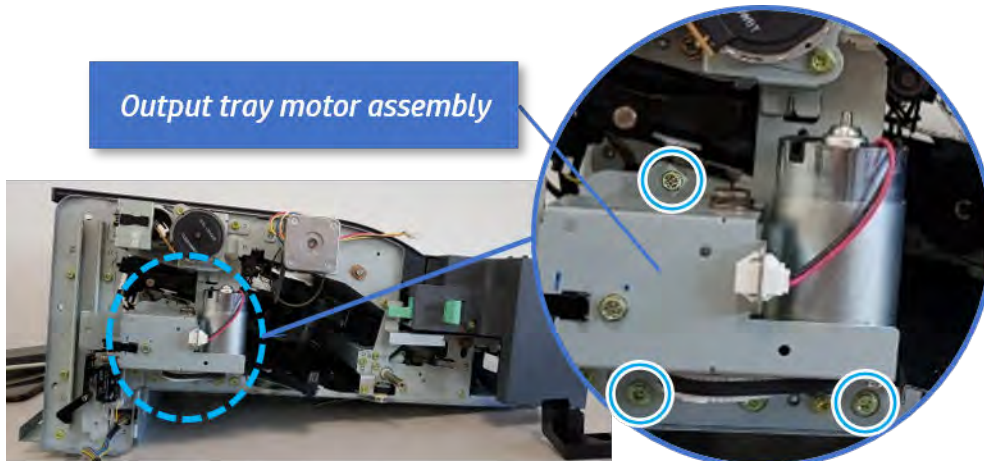


### Remove the output tray motor assembly

Follow these steps to remove the output tray motor assembly.

- ▲ Remove three screws, and then remove the output tray motor assembly.

Figure 6-547 Remove the output tray motor assembly

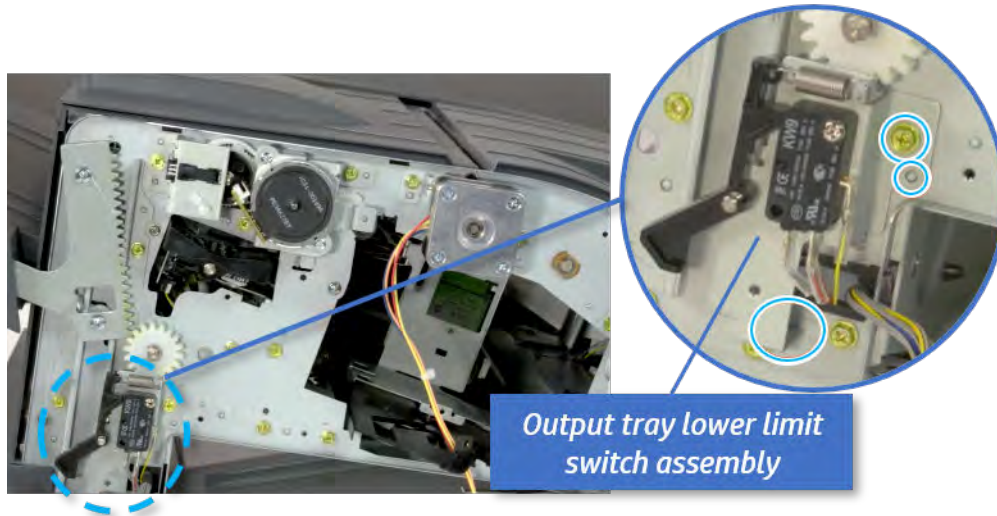


## Remove the output tray lower limit switch

Follow these steps to remove the output tray lower limit switch.

- ▲ Remove one screw, and then remove the output tray lower limit switch.

**Figure 6-548** Remove the output tray lower limit switch

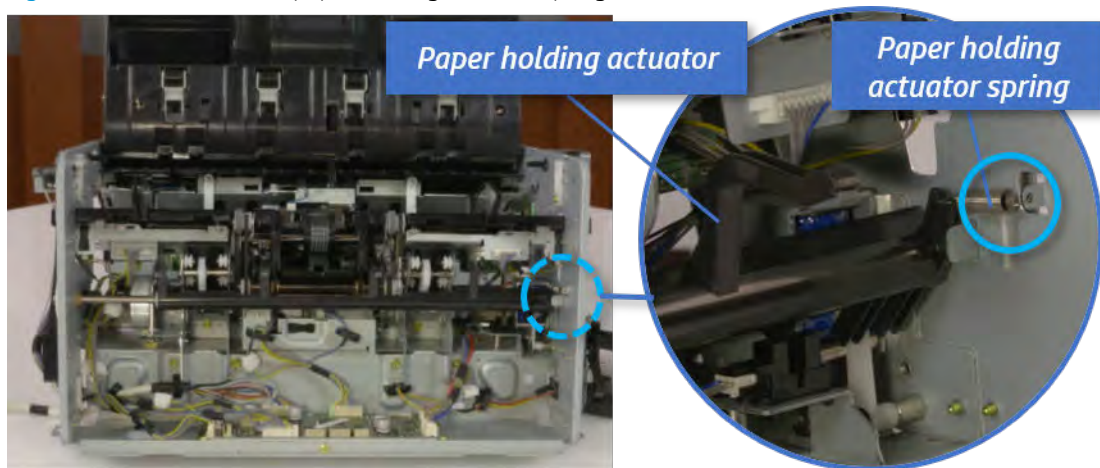


## Remove the paper holding

Follow these steps to remove the paper holding.

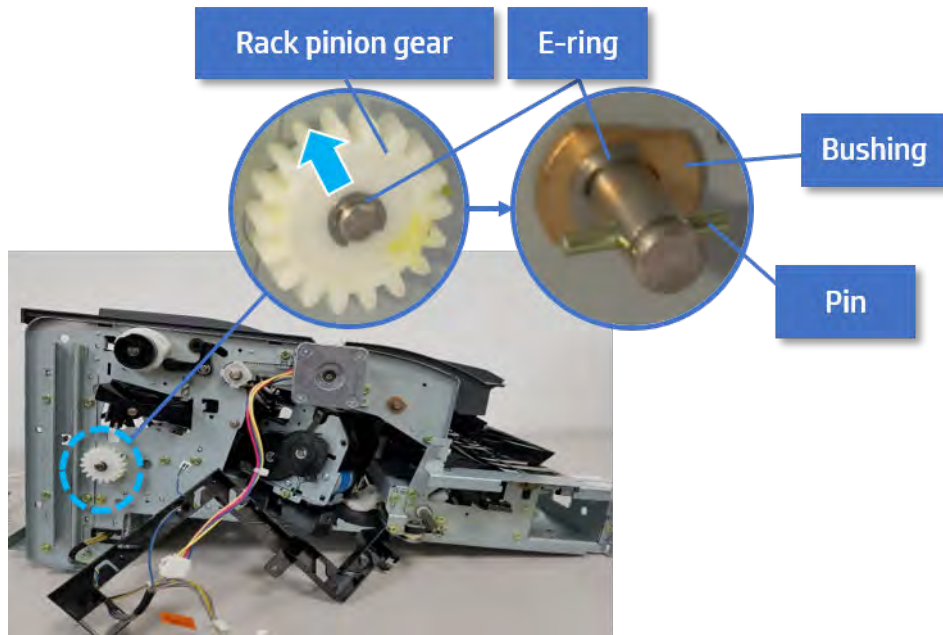
1. Remove the paper holding actuator spring.


**Figure 6-549** Remove the paper holding actuator spring



2. Remove the e-ring and the rack pinion gear. And then remove the pin and the e-ring, and then remove the bushing.

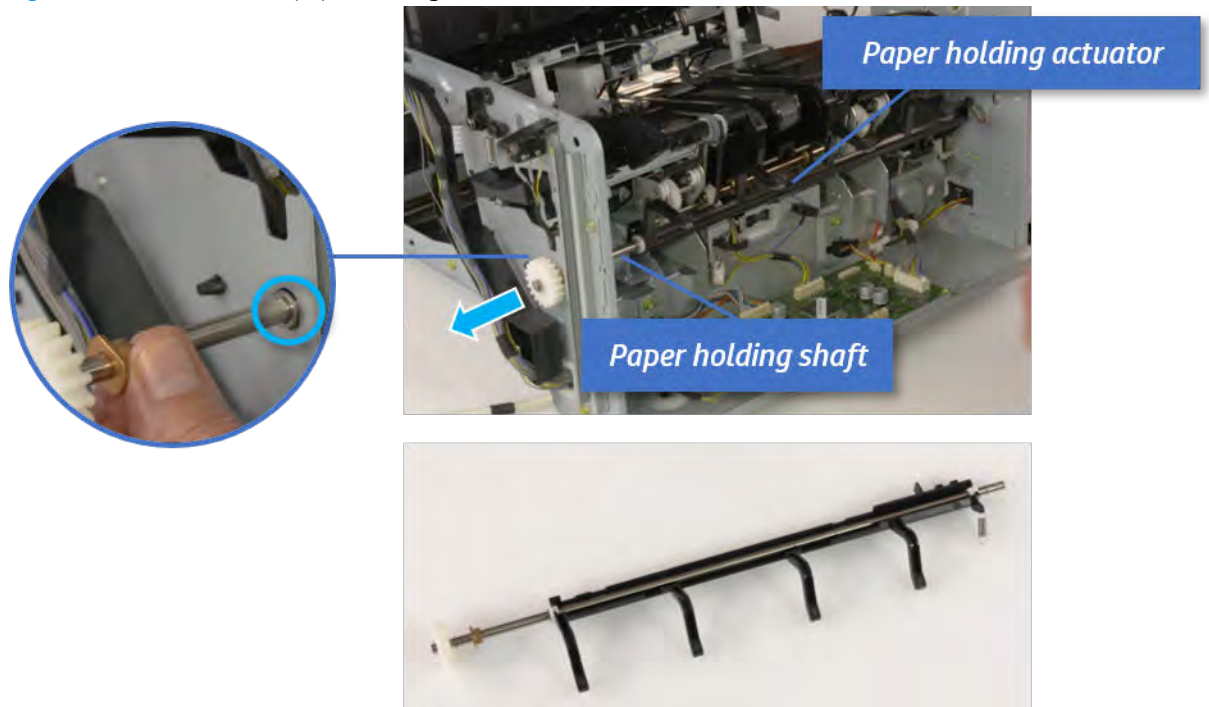
Figure 6-550 Remove e-ring, rack pinion gear, pin, and bushing



 **NOTE:** Be sure not to lose the pin.

3. Carefully remove the paper holding shaft and the actuator.

Figure 6-551 Remove the paper holding shaft and the actuator

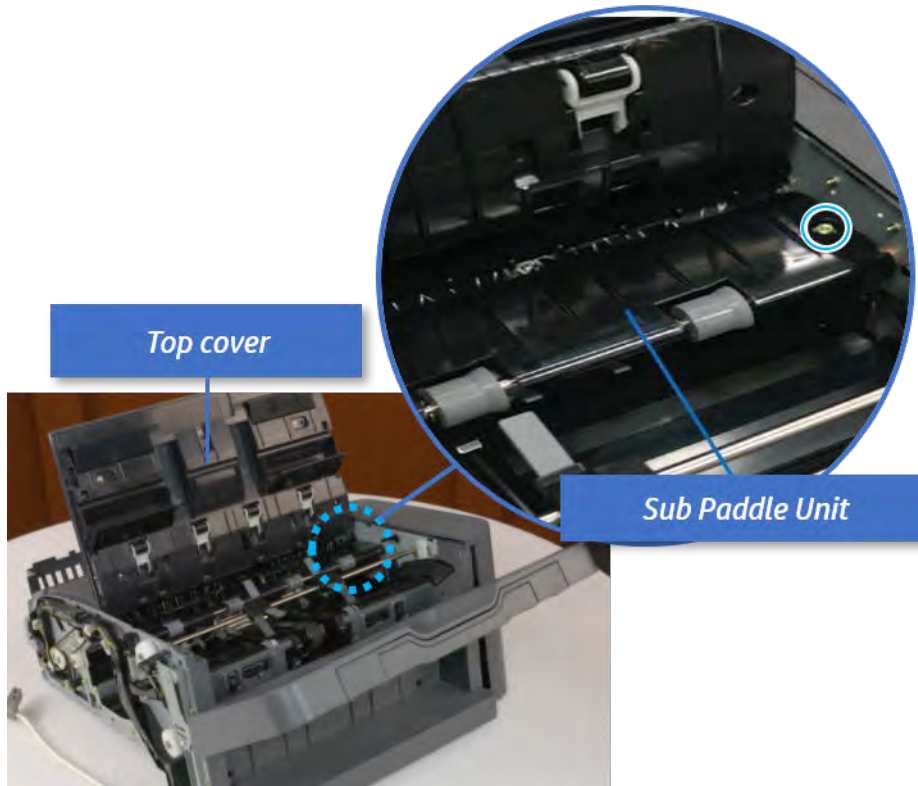


### Remove the sub paddle unit

Follow these steps to remove the sub paddle unit.

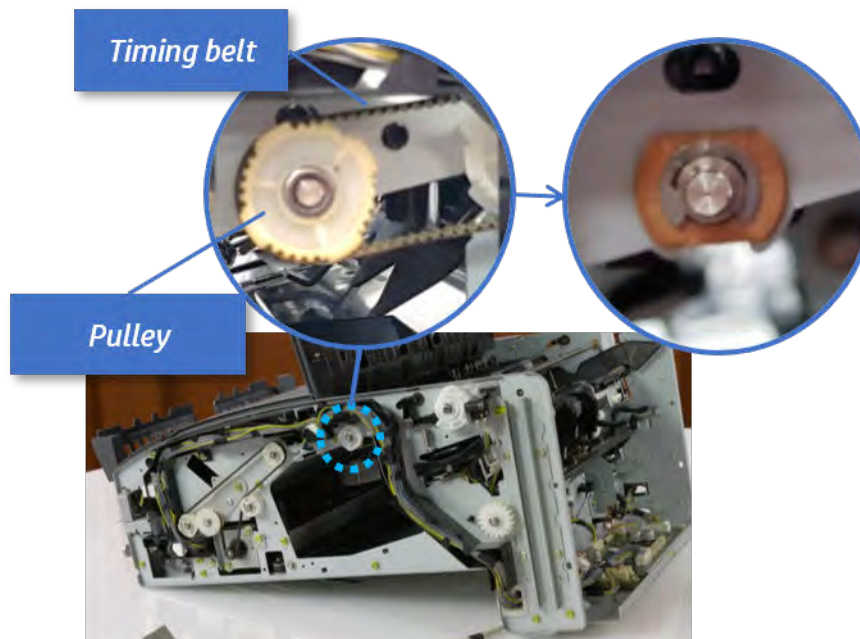
1. Open the top cover, and then remove one screw securing the sub paddle unit.

Figure 6-552 Remove one screw



2. Remove the e-ring, and then remove the pulley and timing belt. And then remove the e-ring and the bushing.

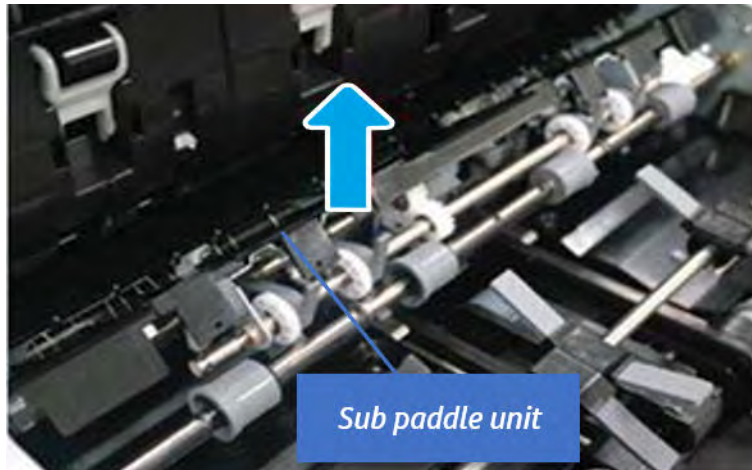
Figure 6-553 Remove the e-ring, pulley, timing belt, and bushing





3. Lift up and remove the sub paddle unit.

Figure 6-554 Remove the sub paddle unit

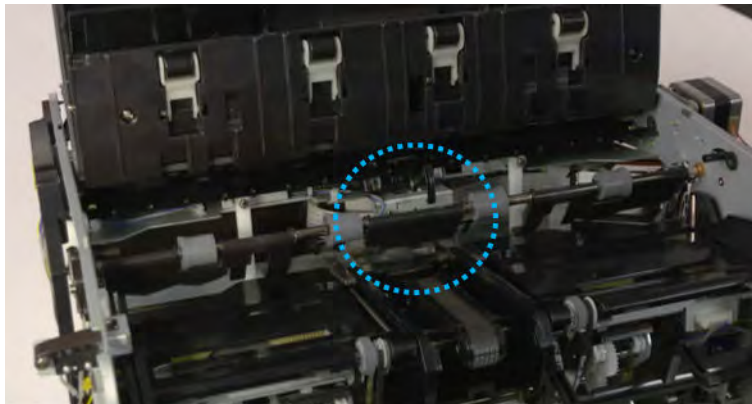


### Remove the exit roller

Follow these steps to remove the exit roller.

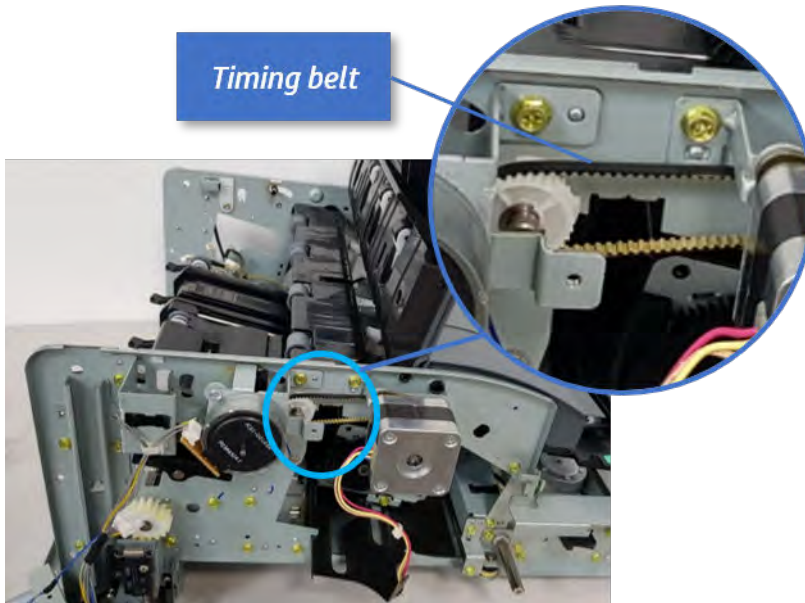
1. Remove the guide on the center of the exit roller.

Figure 6-555 Remove the guide



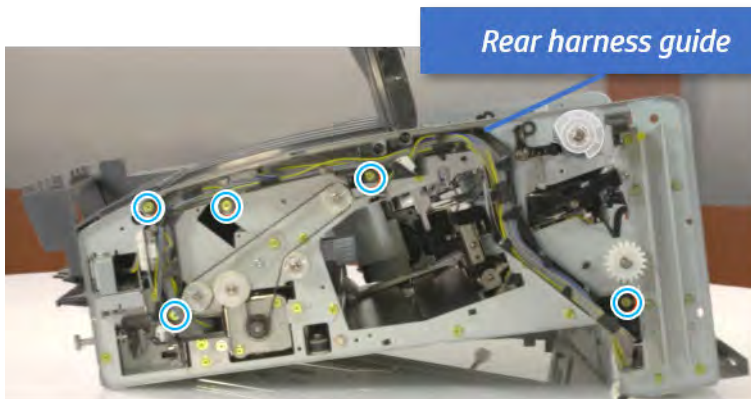
2. On the front of the inner finisher, release the timing belt connected to the exit motor.

Figure 6-556 Release the timing belt



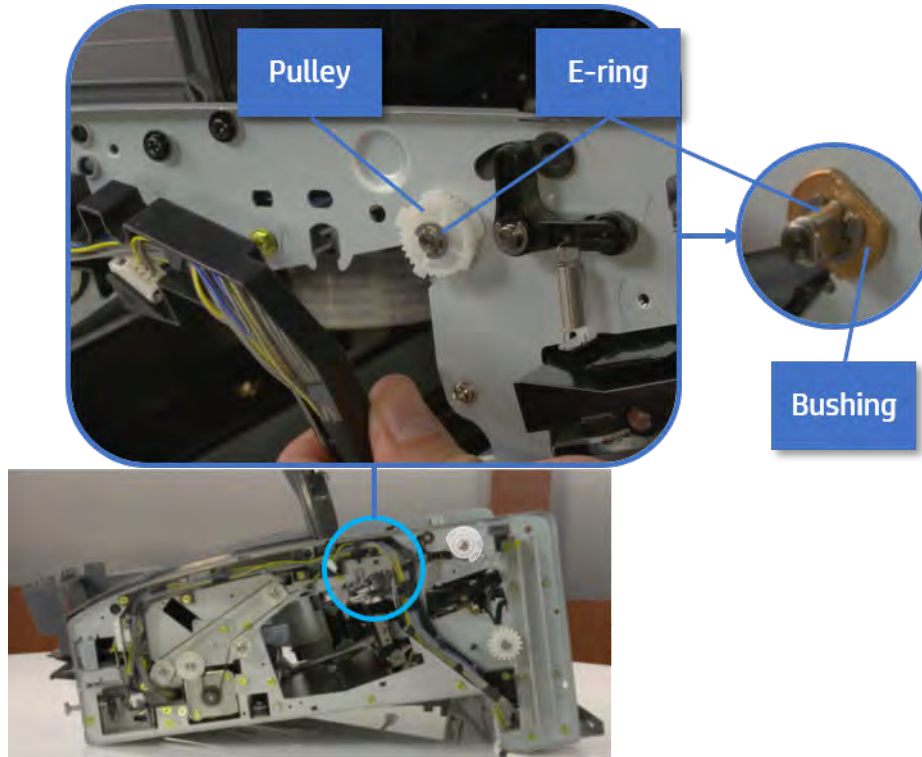
3. Remove five screws securing the rear harness guide.

Figure 6-557 Remove five screws



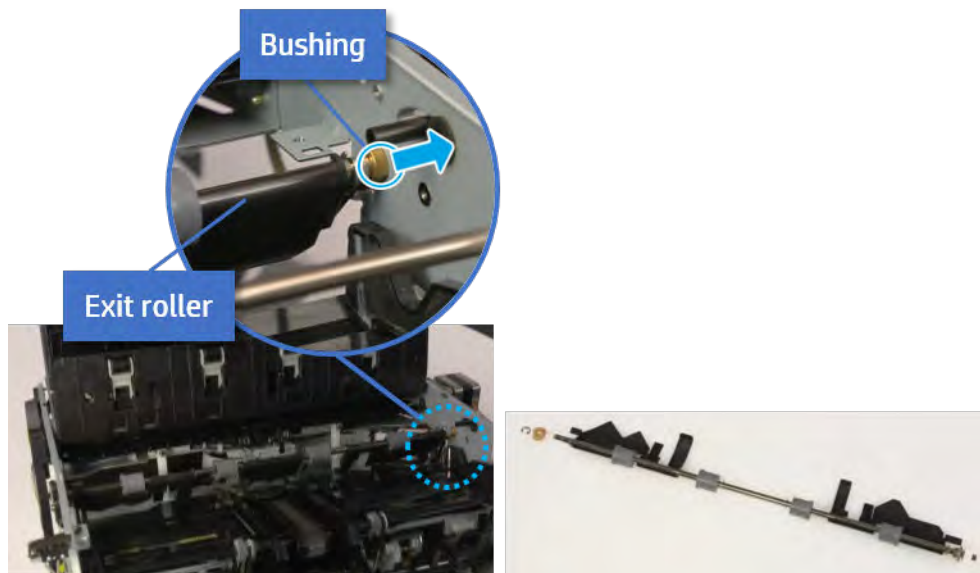
4. On the rear of the inner finisher, remove the e-ring and the pulley and then remove the e-ring and the bushing.

Figure 6-558 Remove e-ring, pulley, and bushing



5. Push the bushing to detach it, and then remove the exit roller.

Figure 6-559 Remove the exit roller

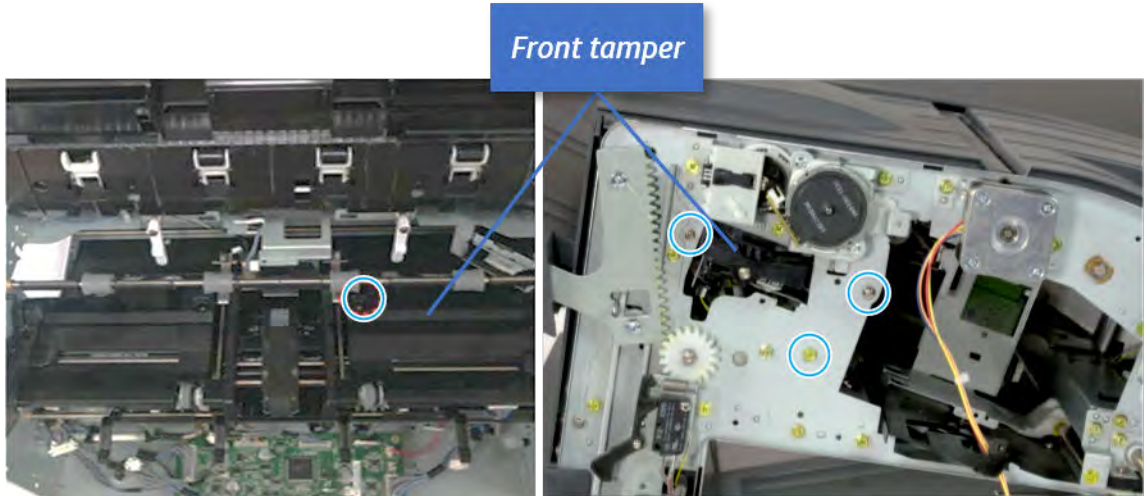


### Remove the front tamper

Follow these steps to remove the front tamper.

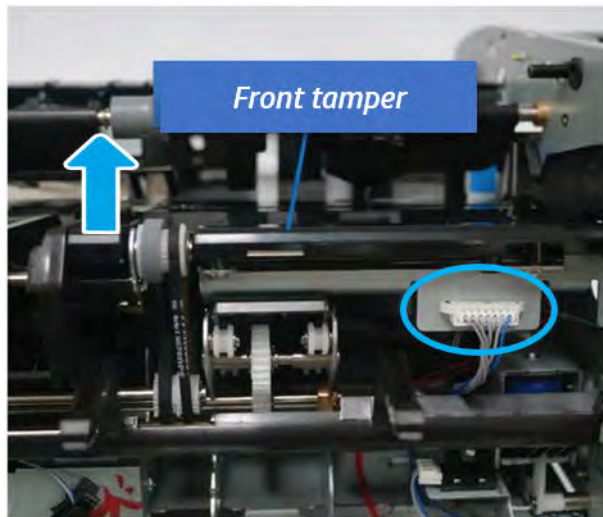
1. Remove four screws.

Figure 6-560 Remove four screws



2. Unplug the connector and release the hook, and then pull the front tamper up to remove.

Figure 6-561 Remove the front tamper



### Remove the rear tamper

Follow these steps to remove the rear tamper.

1. Remove four screws.


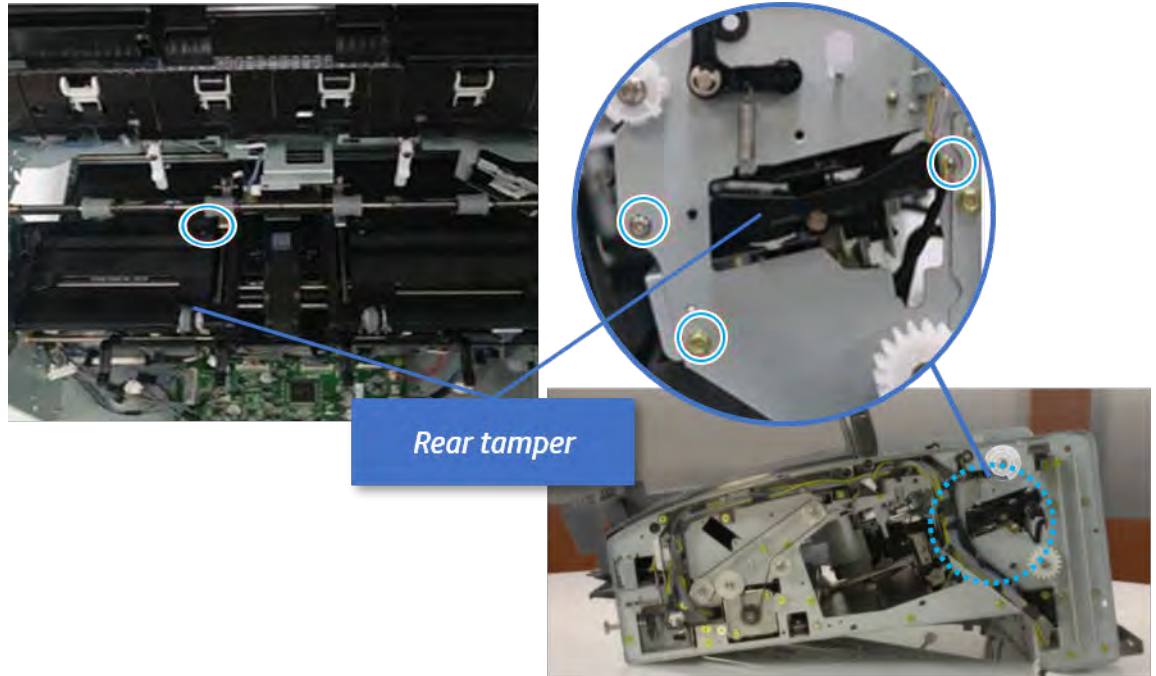
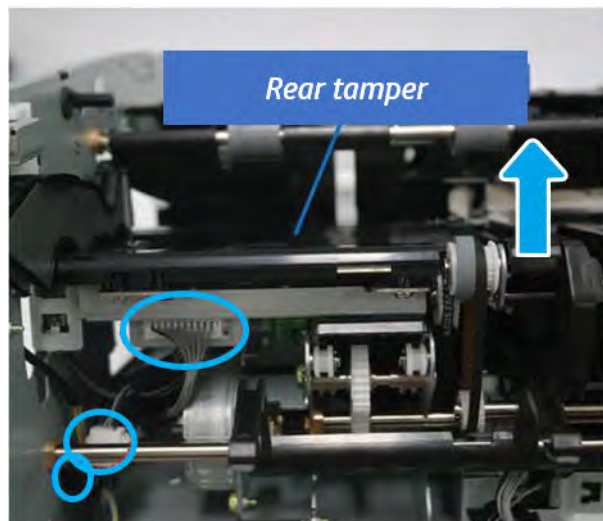
 **NOTE:** Move cable guide out of position to access the screws.

Figure 6-562 Remove four screws



2. Unplug two connectors and release the hook, and then remove the rear tamper.

Figure 6-563 Remove the rear tamper

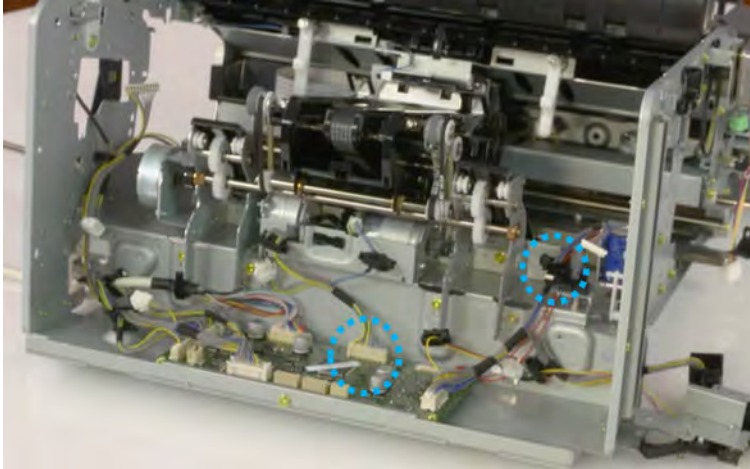


### Remove the ejector & paper support assembly

Follow these steps to remove the ejector & paper support assembly.

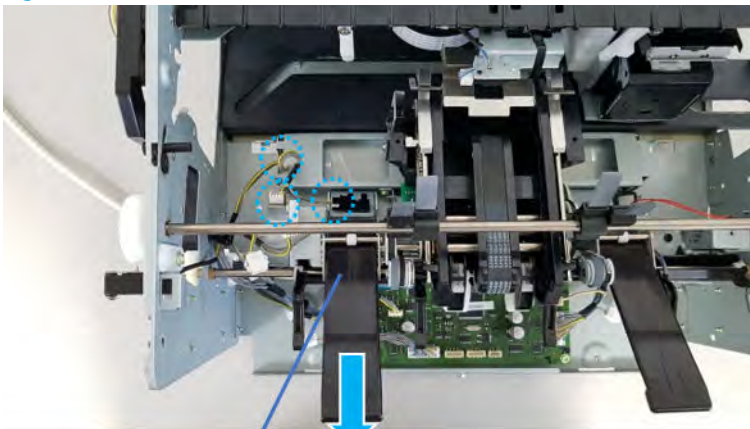
1. Open one clamp, disconnect one connector.

Figure 6-564 Disconnect one connector



2. Pull the rear paper support up, and then release one clamp and disconnect two connectors.

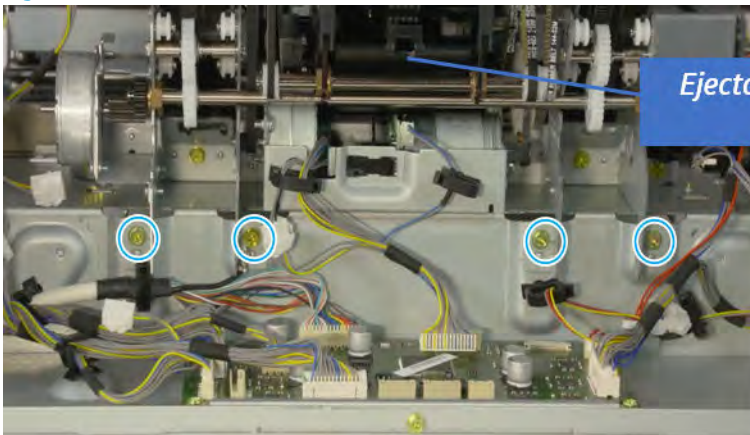
Figure 6-565 Disconnect two connector



*Rear paper support*

3. Remove four screws, and then remove the ejector & paper support assembly.

Figure 6-566 Remove the ejector & paper support assembly



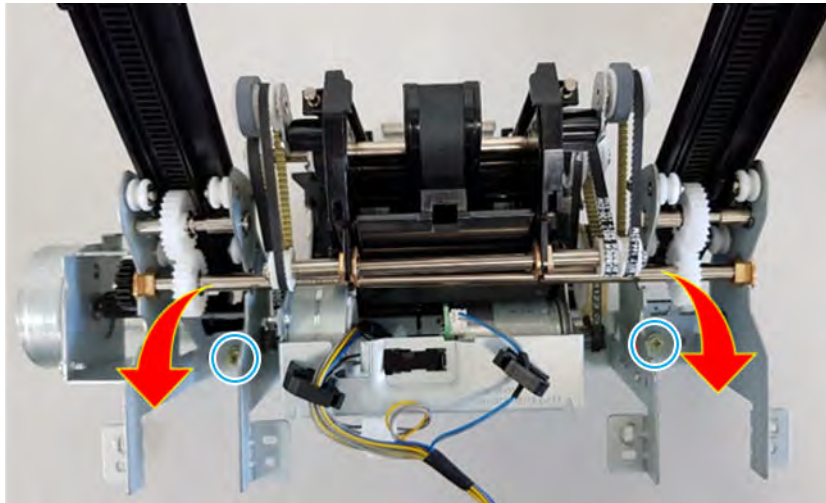
*Ejector & paper support assembly*

## Remove the front paper support and the rear paper support

Follow these steps to remove the front paper support and the rear paper support.

- ▲ Remove two screws, and then pull the paper support assembly out of ejector assembly.

Figure 6-567 Remove paper support assembly

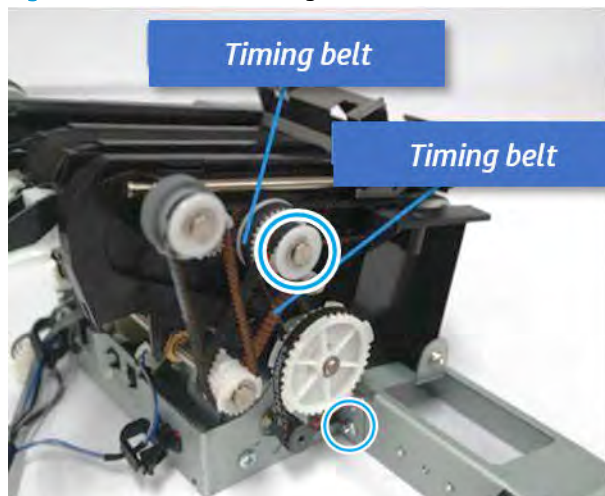


## Remove the ejector motor assembly

Follow these steps to remove the ejector motor assembly.

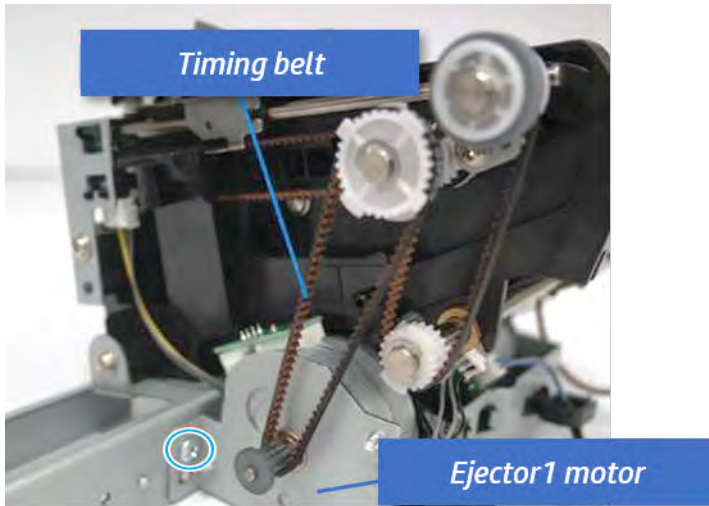
1. Remove the e-ring and washer. Remove two timing belts, and then remove one screw.

Figure 6-568 Remove e-ring, washer, belt, and screw



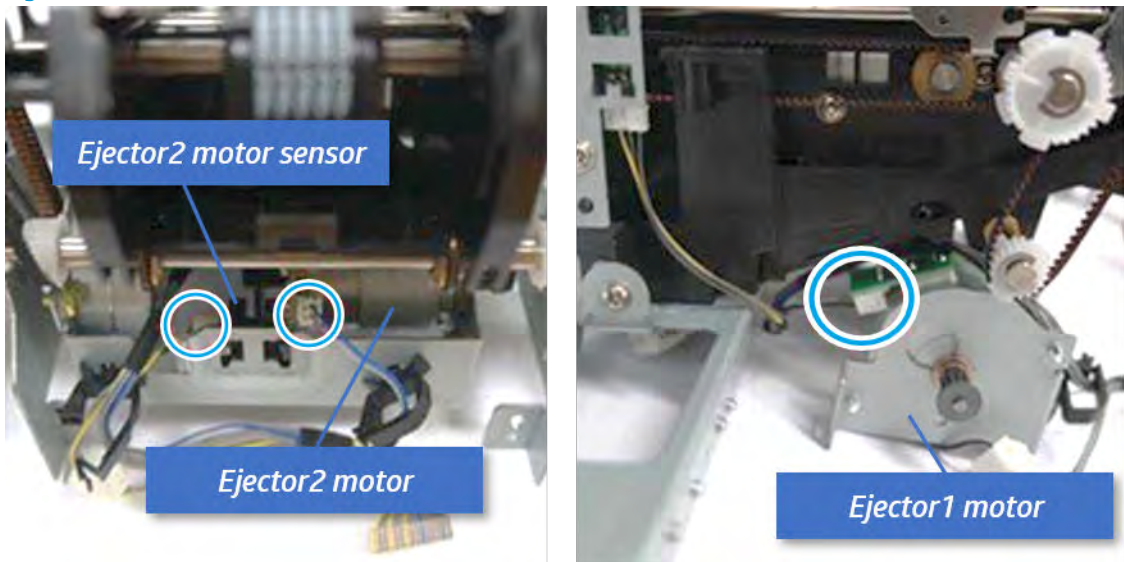
2. Remove the timing belt, and then remove one screw.

Figure 6-569 Remove the belt, screw



3. Remove the cable from clamp, and then disconnect two motor connectors and the sensor connector.

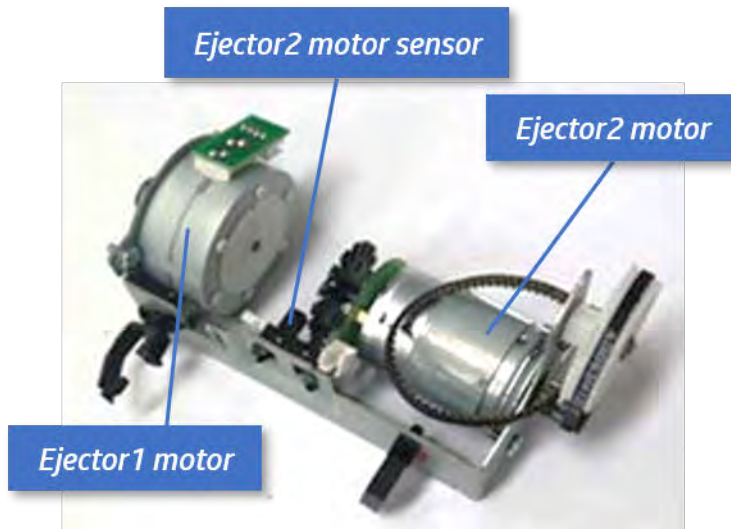
Figure 6-570 Disconnect the motor and sensor connectors





4. Remove the ejector motor assembly.

Figure 6-571 Remove the ejector motor assembly



### Unpack the replacement assembly

Follow these steps to unpack the replacement assembly.

1. Dispose of the defective part.

---



 **NOTE:** HP recommends responsible disposal of the defective part.

<http://www8.hp.com/us/en/hp-information/environment/product-recycling.html>


---

2. Unpack the replacement part from the packaging.

---

 **CAUTION:**  Some parts are sensitive to electrostatic discharge (ESD). Always perform service work at an ESD-protected workstation or mat. If an ESD workstation or mat is not available, touch the sheet-metal chassis to provide a static ground before touching an ESD-sensitive assembly. Protect the ESD-sensitive assemblies by placing them in ESD pouches when they are out of the printer.


 **IMPORTANT:** Make sure that all of the shipping materials (for example shipping tape) are removed from the replacement part prior to installation.

 **NOTE:** If the replacement part is a roller or pad, avoid touching the spongy part of it. Skin oils on the roller or pad can cause paper pickup and/or print-quality problems. HP recommends using disposable gloves when handling rollers or pads or washing your hands before touching rollers or pads.

---

3. To install an assembly, reverse the removal steps.

---

 **NOTE:** When applicable, special installation instructions are provided for an assembly at the end of the removal procedure. Always completely read the removal instructions and follow all special installation instructions.

---

## Removal and replacement: Ejector assembly (include end fence, S10/ S16)


Learn how to remove and replace the ejector assembly.

View videos on how to remove and reassemble the inner finisher below:

 [View a teardown video of the inner finisher .](#)

 [View a reassembling video of the inner finisher .](#)

---

 **IMPORTANT:** When applicable, special installation instructions are provided for an assembly at the end of the removal procedure. Always completely read the removal instructions and follow all special installation instructions.

---

Mean time to repair:


Service level:

### Before performing service

#### Turn the printer power off

- Press the power button on the front of the printer, and then turn off the power switch next to the power cable.
- A shutting-down message appears on the control-panel display.

---

 **WARNING!** To avoid damage to the printer, turn the power off and wait until the printer shuts down before removing the power cable.

---

- Disconnect the printer power cable after the printer has completely shut down (the control-panel display is blank).

Use the table below to identify the correct part number for your printer. To order the part, go to [www.hp.com/buy/parts](http://www.hp.com/buy/parts).

Table 6-64 Part information

Part number	Part description
SS456-61001	Ejector

### Required tools

- #2 JIS screwdriver with a magnetic tip

### After performing service

#### Turn the printer power on

- Connect the power cable.
- Use the power switch to turn the power on.

### Post service test

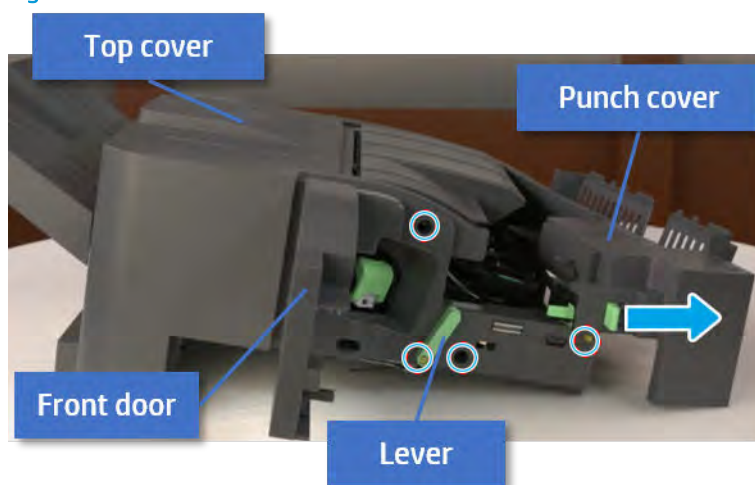
Print any pages necessary to verify that the repair resolved the issue and did not create any new issues.

## Remove the front cover

Follow these steps to remove the front cover:

1. Open the front door and open the punch cover.
2. Remove three screws in the front.
3. Remove the lever.
4. Open the top cover.
5. From the right side of the front cover, carefully lift and pry toward the top-left corner to remove the front cover.

Figure 6-572 Remove the front cover

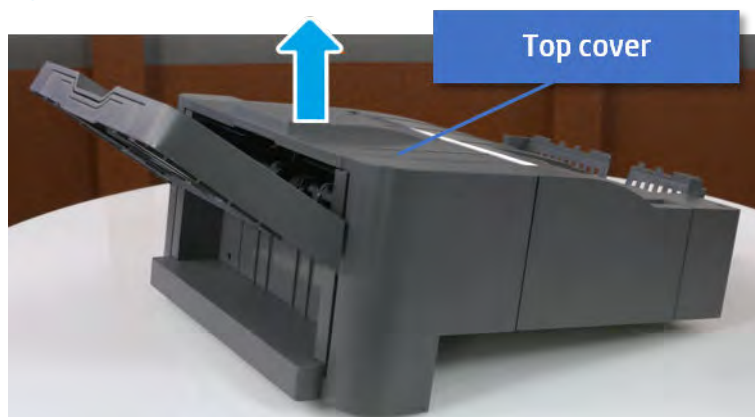


## Remove the rear cover

Follow these steps to remove the rear cover:

1. Open the top cover.

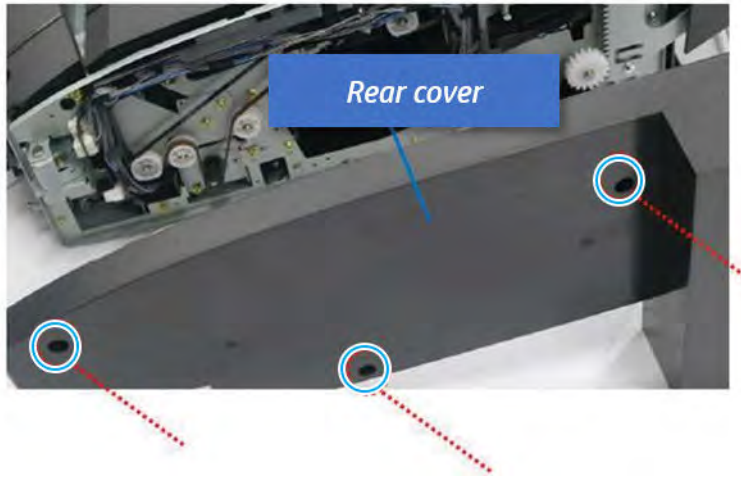
Figure 6-573 Open the top cover



2. Remove three screws.

3. Release hooks carefully and remove the rear cover.

Figure 6-574 Remove the rear cover

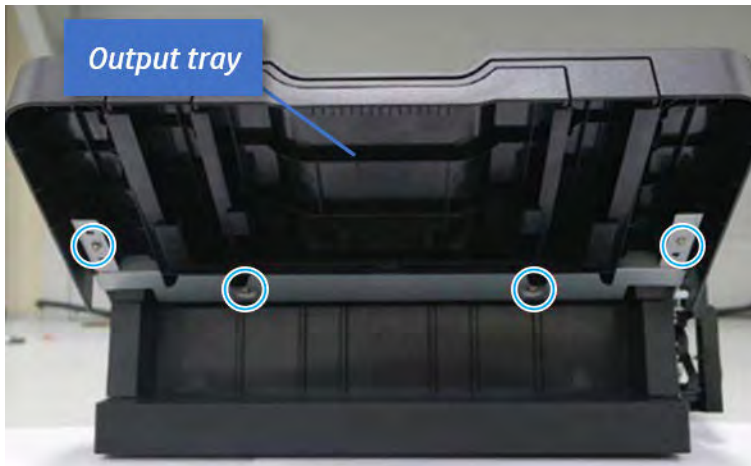


### Remove the output tray

Follow these steps to remove the output tray.

1. Remove four screws.

Figure 6-575 Remove four screws



2. Push the paper holding actuator into the inner finisher, and then remove the output tray.

Figure 6-576 Remove the output tray.

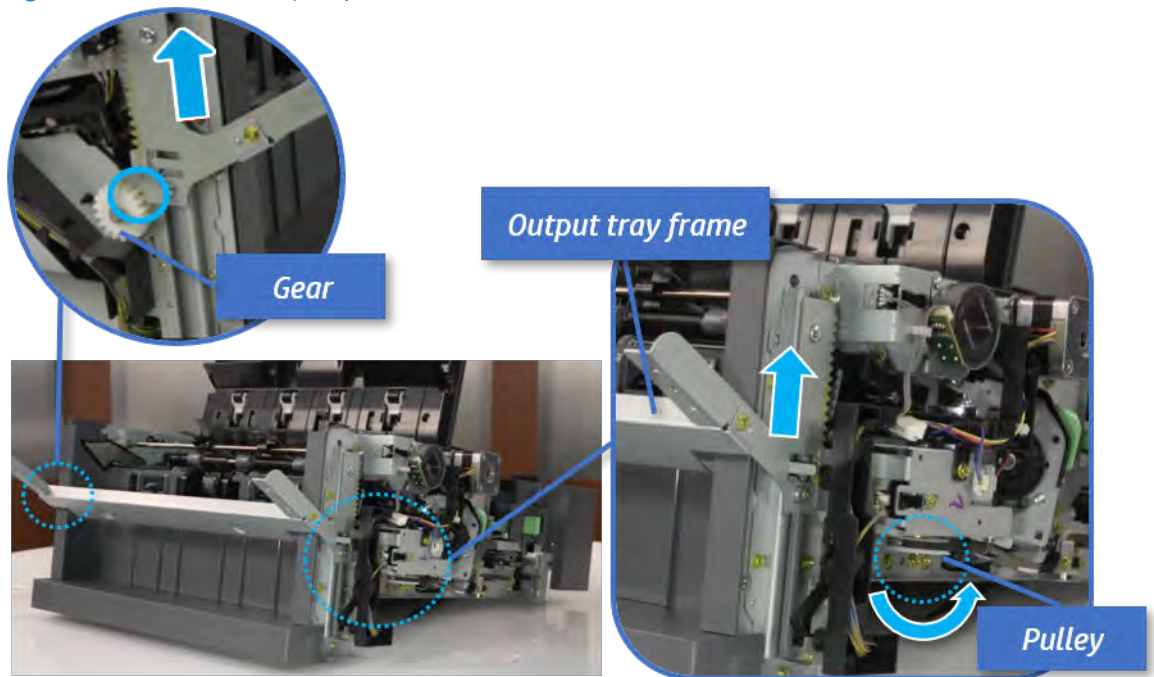


### Remove the output tray frame

Follow these steps to remove the output tray frame.

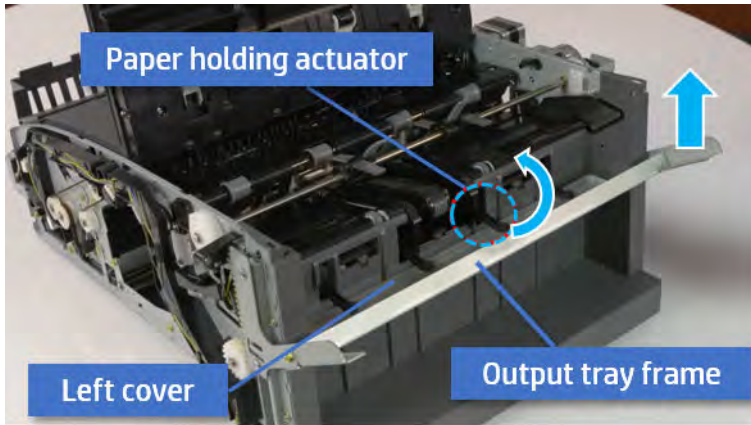
1. Rotate the pulley until the output tray frame depart from the gear.

Figure 6-577 Remove the pulley



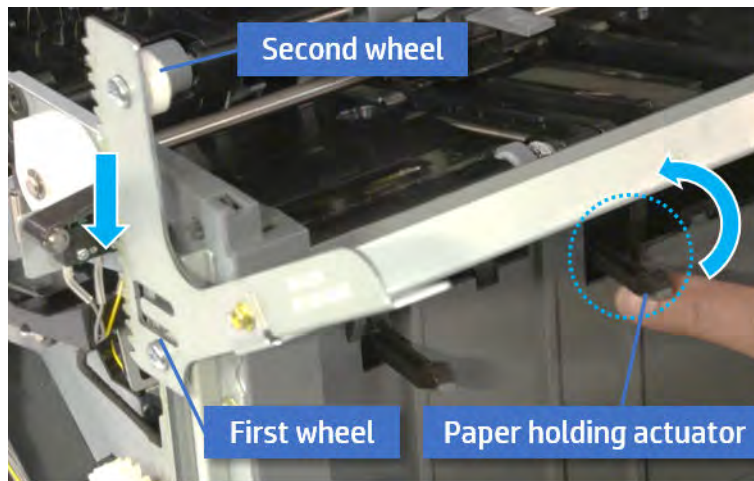
2. Push the paper holding actuator into the inner finisher, and then remove the output tray frame.

Figure 6-578 Remove the output tray frame

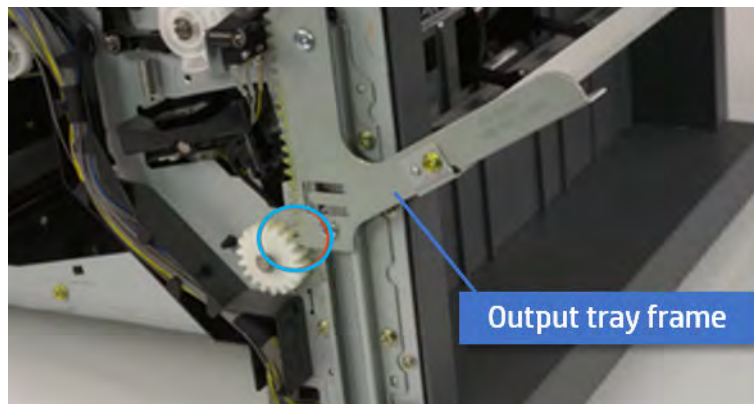


**TIP:** Push the paper holding actuator into the inner finisher when reassembling. Be sure to level the output tray.

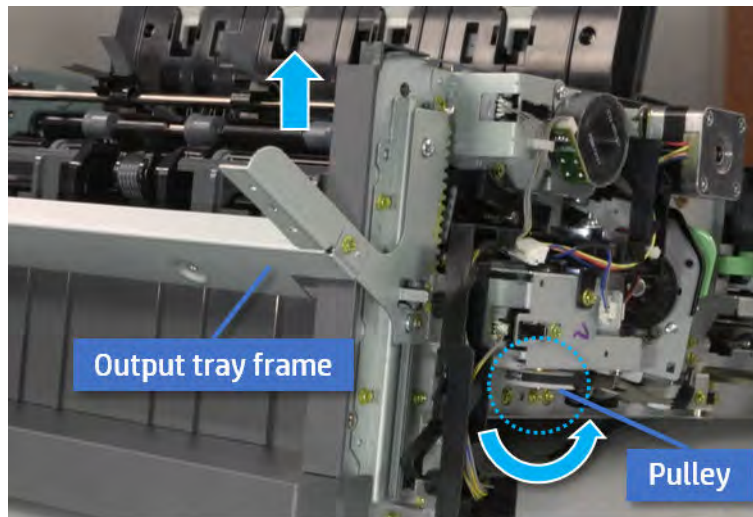
- a. Position the first wheel into the channel on both sides while pushing the paper holding actuator.



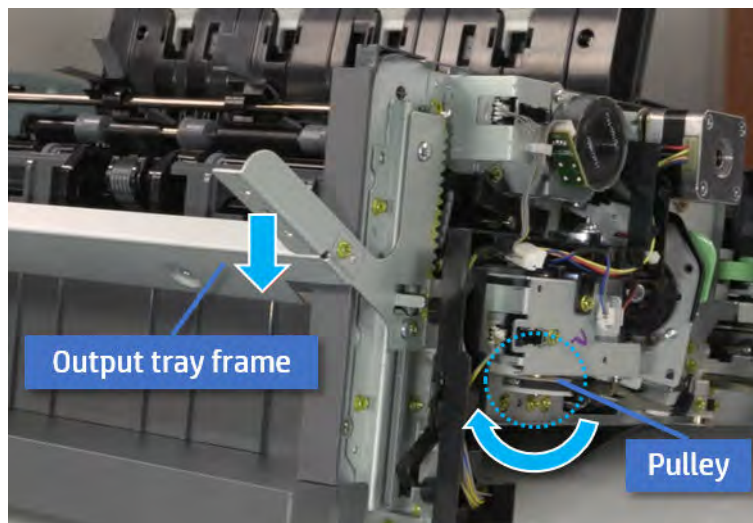
- b. Let the second wheel rest on the channel on both sides simultaneously.
- c. Gently squeeze the wheels into channel until the output tray frame meet the gear.



- d. Rotate the pulley until the output tray frame is no longer lifted. It can make to level the output tray frame.



- e. Rotate the pulley in the opposite direction.

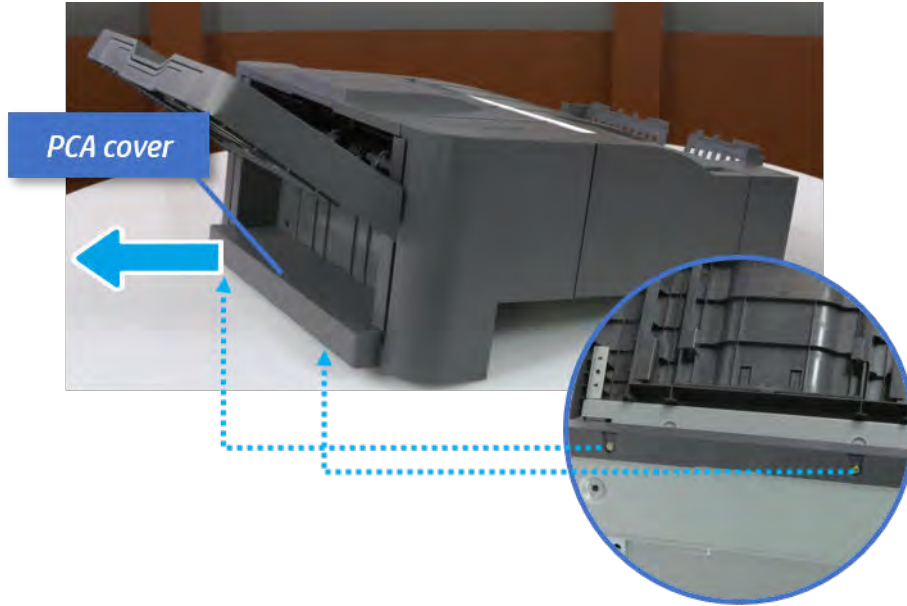


### Remove the PCA cover

Follow these steps to remove the PCA cover.

- ▲ Remove two screws, and then remove the PCA cover.

Figure 6-579 Remove the PCA cover

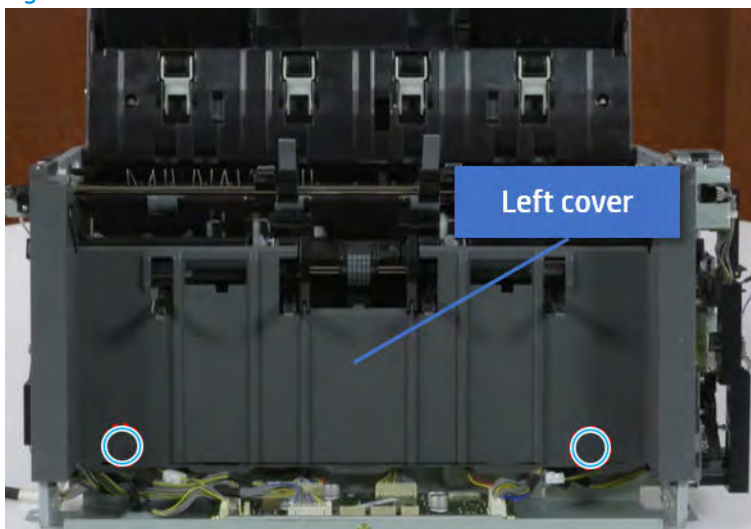


### Remove the left cover

Follow these steps to remove the left cover.

1. Remove two screws.

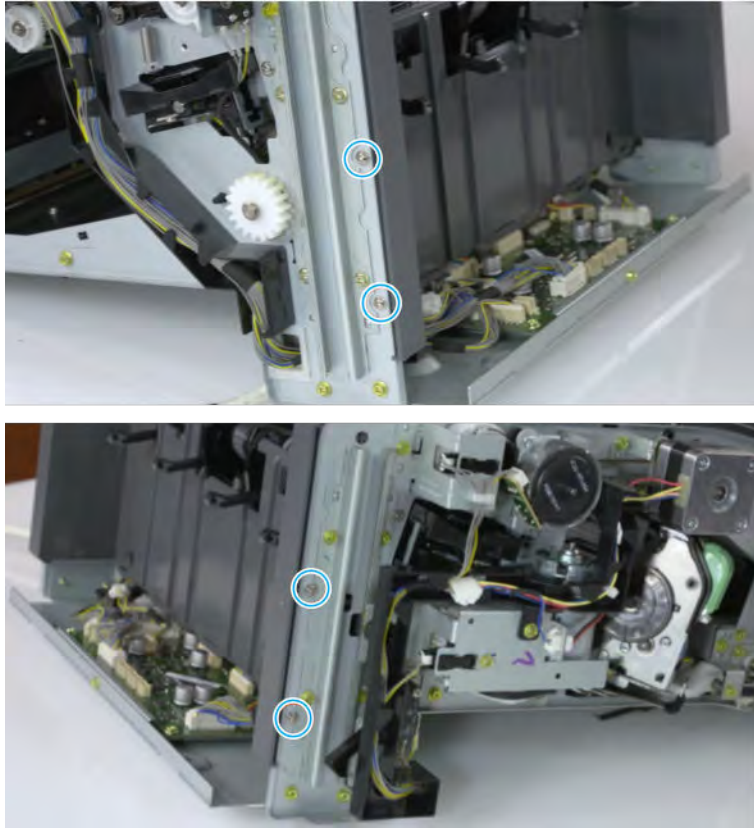
Figure 6-580 Remove two screws





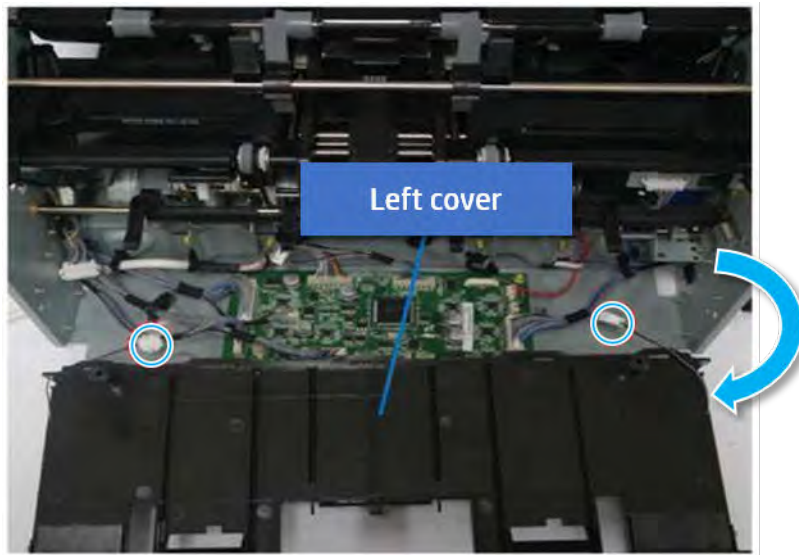
2. Remove four screws from both front and rear sides.


Figure 6-581 Remove four screws

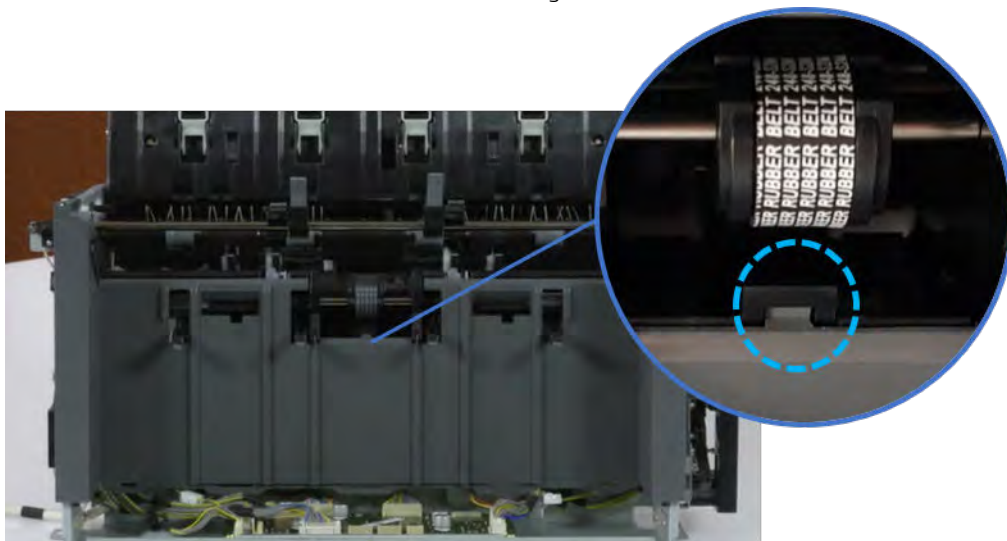


3. Unplug two inline connectors, and then remove the left cover.

Figure 6-582 Unplug two connectors



 **TIP:** Be sure to check the hook when reassembling.



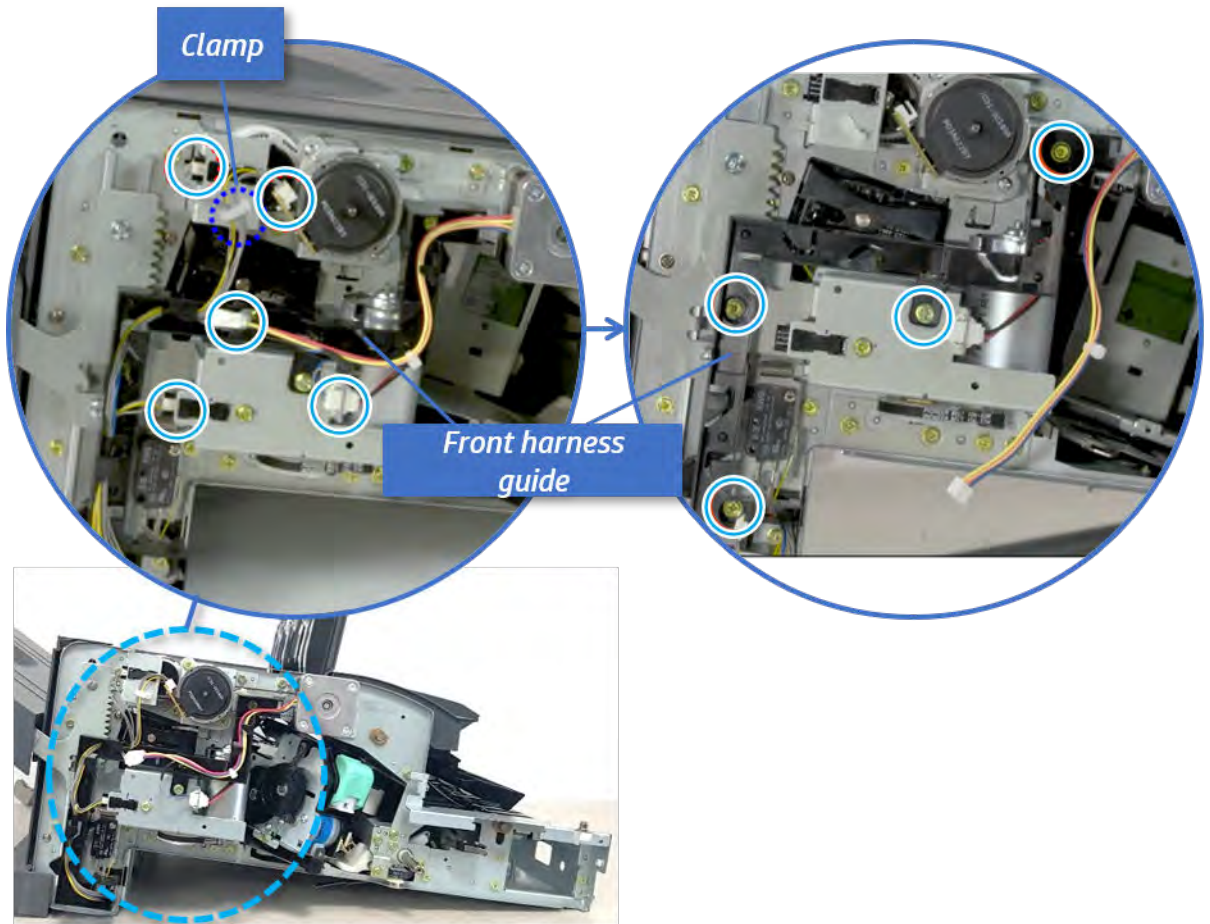
### Remove the front harness guide

Follow these steps to remove the front harness guide.

1. Open one clamp and unplug five connectors, and then remove the wire harness from the front harness guide.

2. Remove four screws, and then remove the front harness guide.

Figure 6-583 Remove the front harness guide

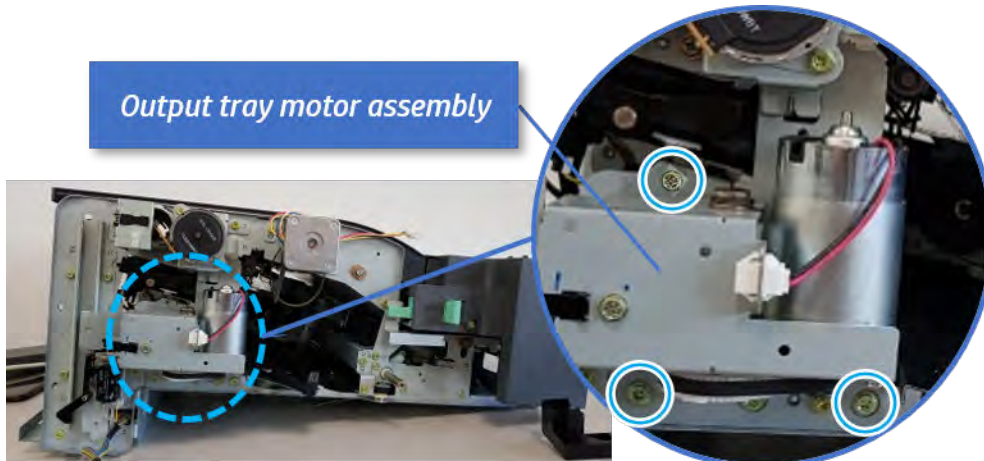


### Remove the output tray motor assembly

Follow these steps to remove the output tray motor assembly.

- ▲ Remove three screws, and then remove the output tray motor assembly.

Figure 6-584 Remove the output tray motor assembly

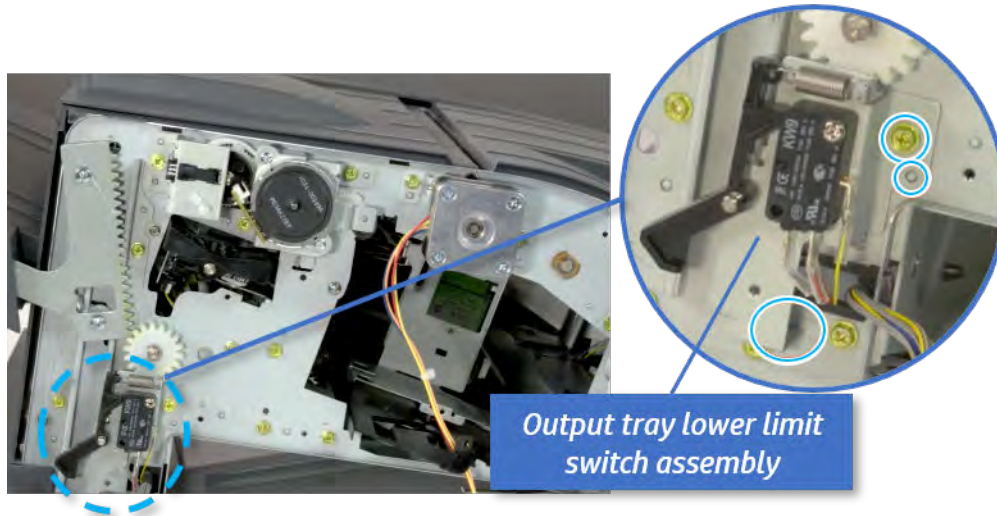


## Remove the output tray lower limit switch

Follow these steps to remove the output tray lower limit switch.

- ▲ Remove one screw, and then remove the output tray lower limit switch.

**Figure 6-585** Remove the output tray lower limit switch

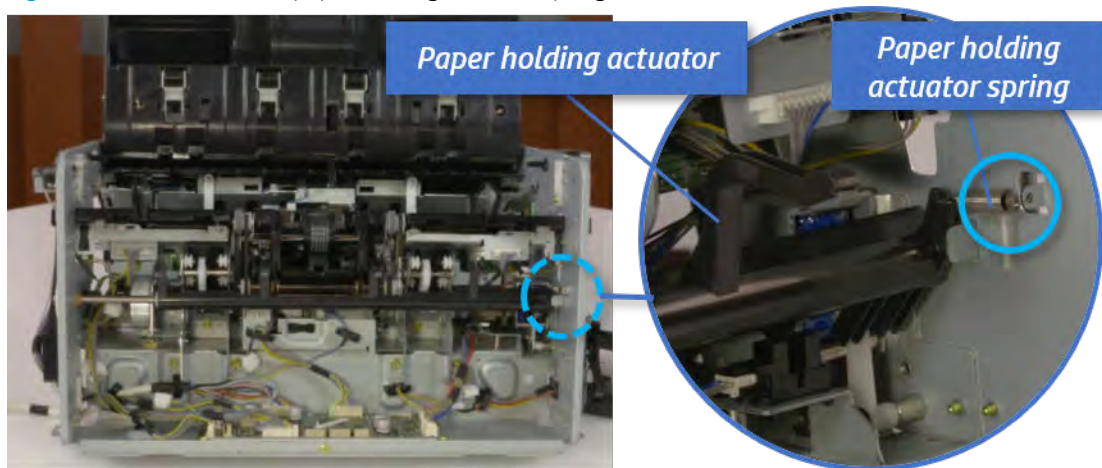


## Remove the paper holding

Follow these steps to remove the paper holding.

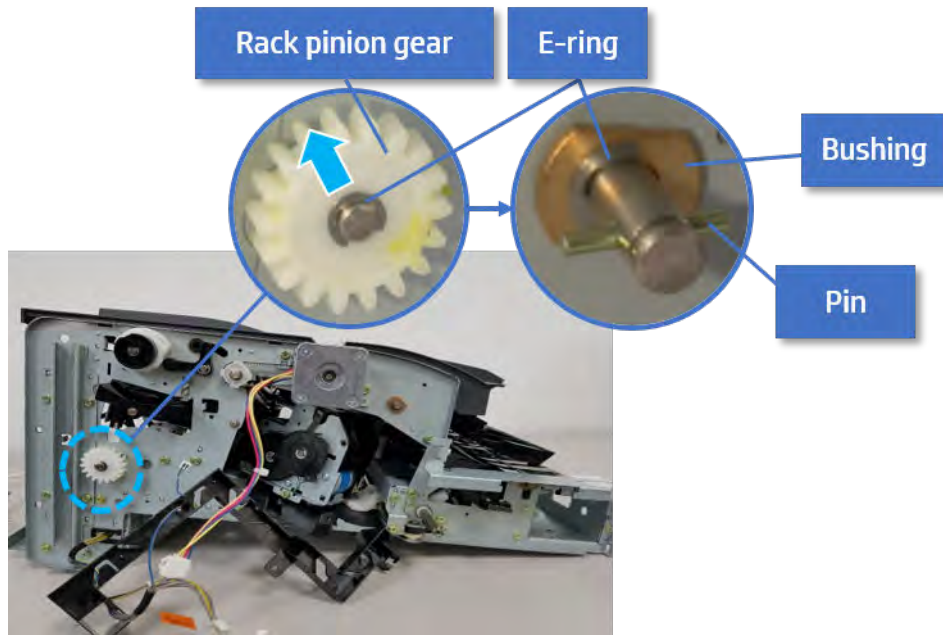
1. Remove the paper holding actuator spring.


**Figure 6-586** Remove the paper holding actuator spring



2. Remove the e-ring and the rack pinion gear. And then remove the pin and the e-ring, and then remove the bushing.

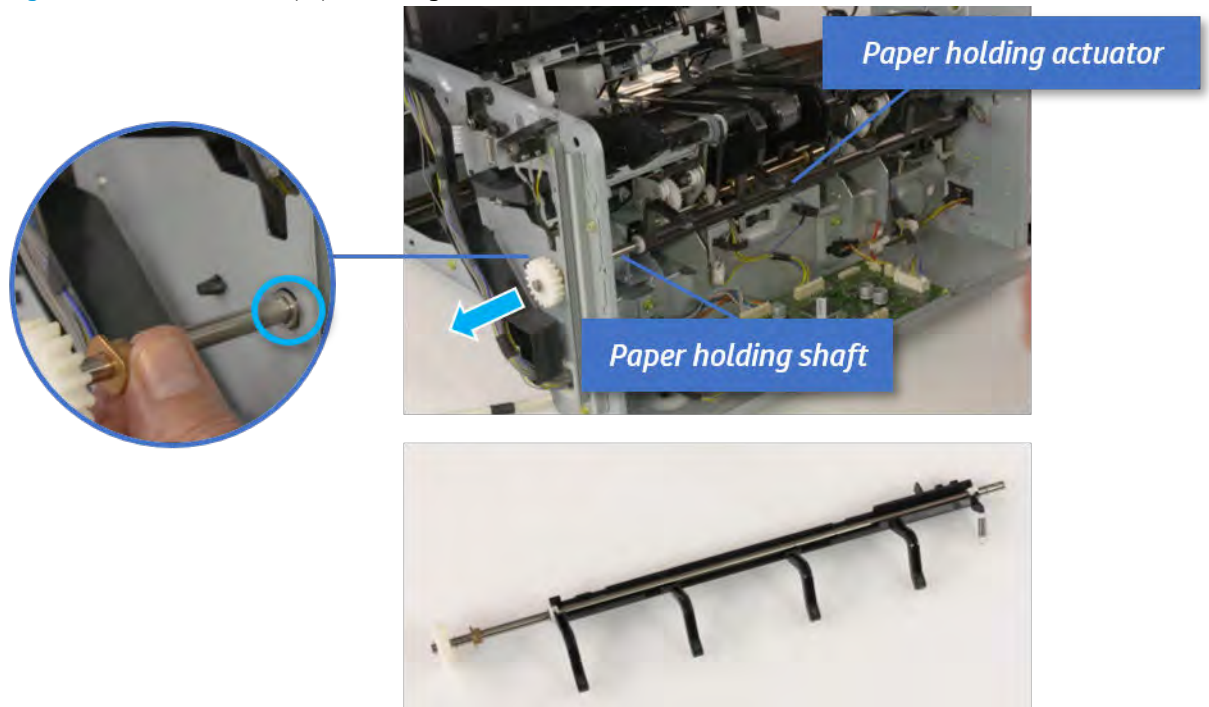
**Figure 6-587** Remove e-ring, rack pinion gear, pin, and bushing



 **NOTE:** Be sure not to lose the pin.

3. Carefully remove the paper holding shaft and the actuator.

**Figure 6-588** Remove the paper holding shaft and the actuator

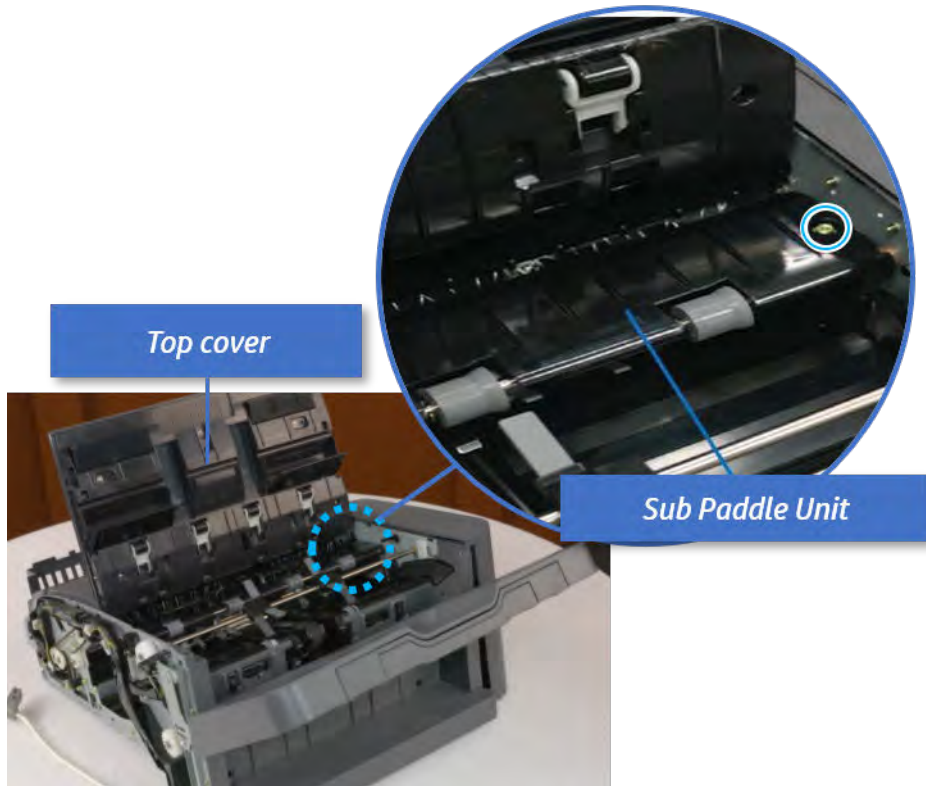


### Remove the sub paddle unit

Follow these steps to remove the sub paddle unit.

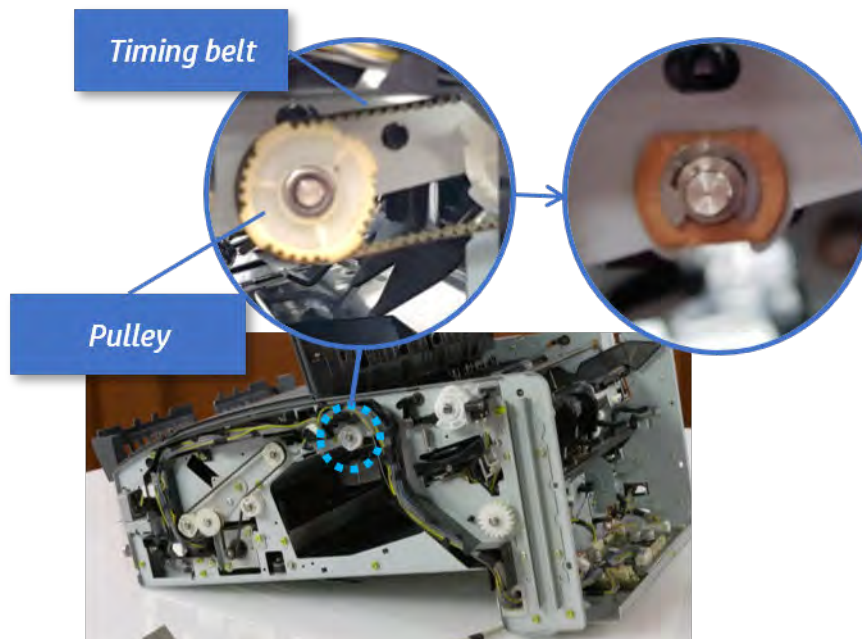
1. Open the top cover, and then remove one screw securing the sub paddle unit.

Figure 6-589 Remove one screw



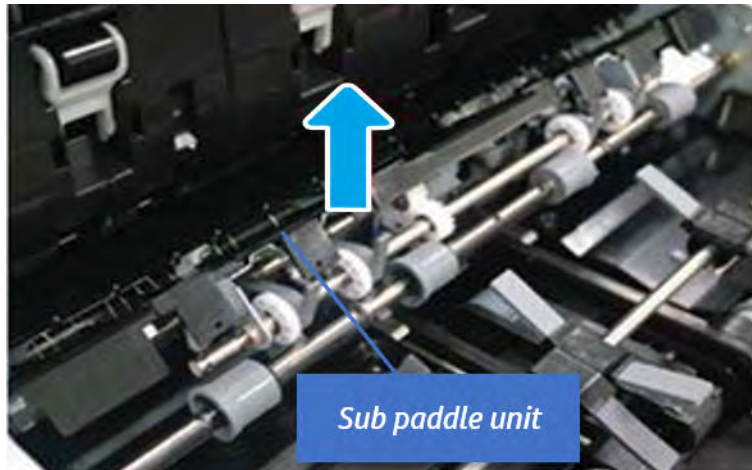
2. Remove the e-ring, and then remove the pulley and timing belt. And then remove the e-ring and the bushing.

Figure 6-590 Remove the e-ring, pulley, timing belt, and bushing



3. Lift up and remove the sub paddle unit.

**Figure 6-591** Remove the sub paddle unit

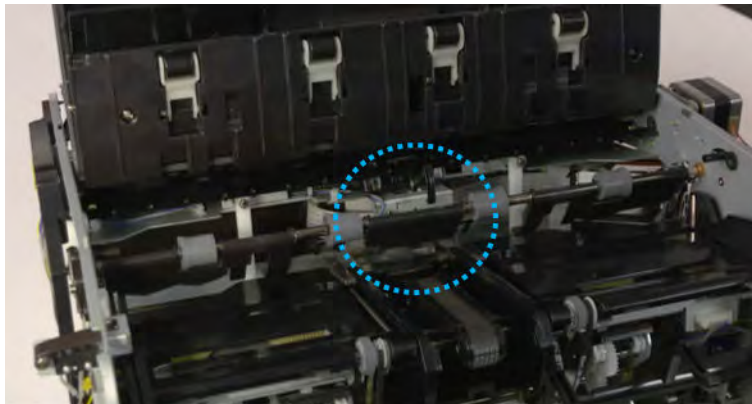


### Remove the exit roller

Follow these steps to remove the exit roller.

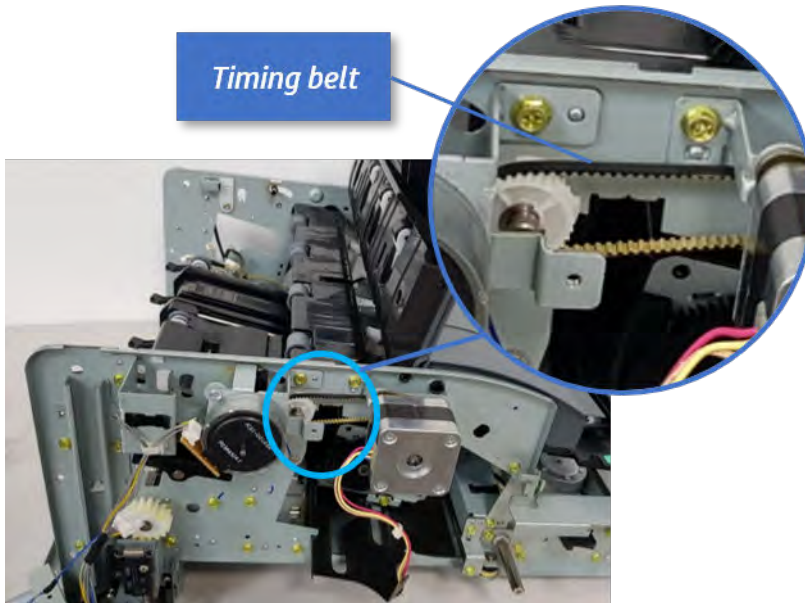
1. Remove the guide on the center of the exit roller.

**Figure 6-592** Remove the guide



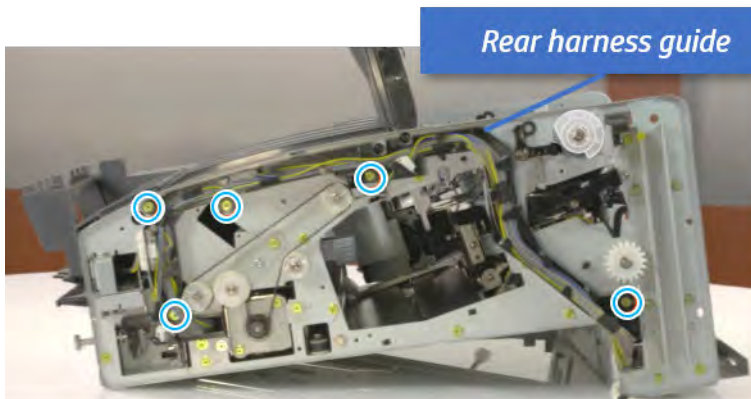
2. On the front of the inner finisher, release the timing belt connected to the exit motor.

Figure 6-593 Release the timing belt



3. Remove five screws securing the rear harness guide.

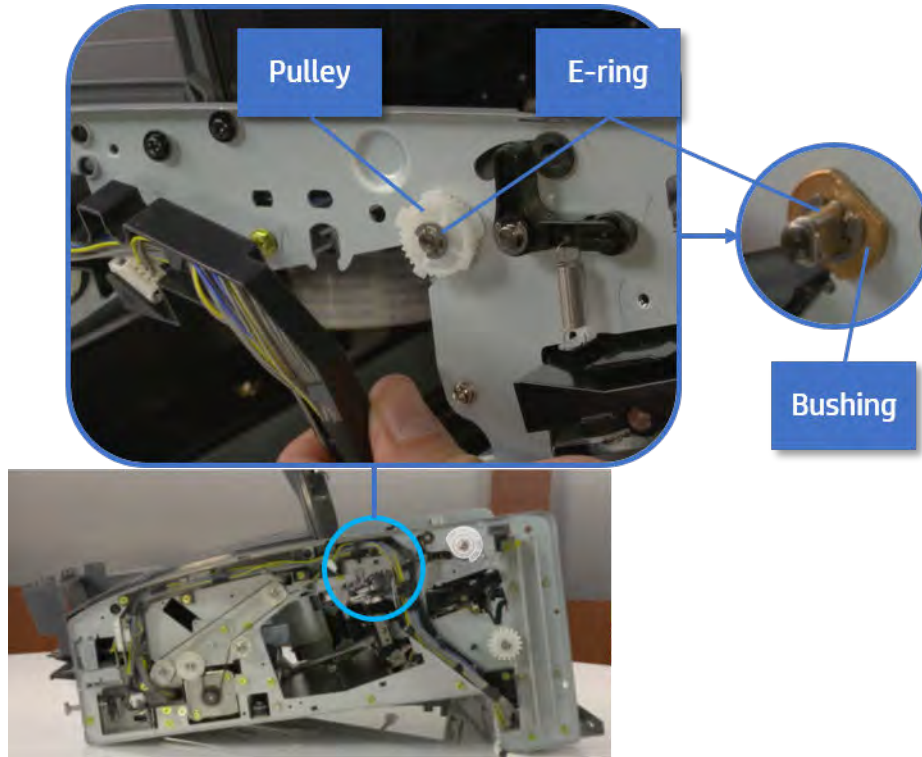
Figure 6-594 Remove five screws





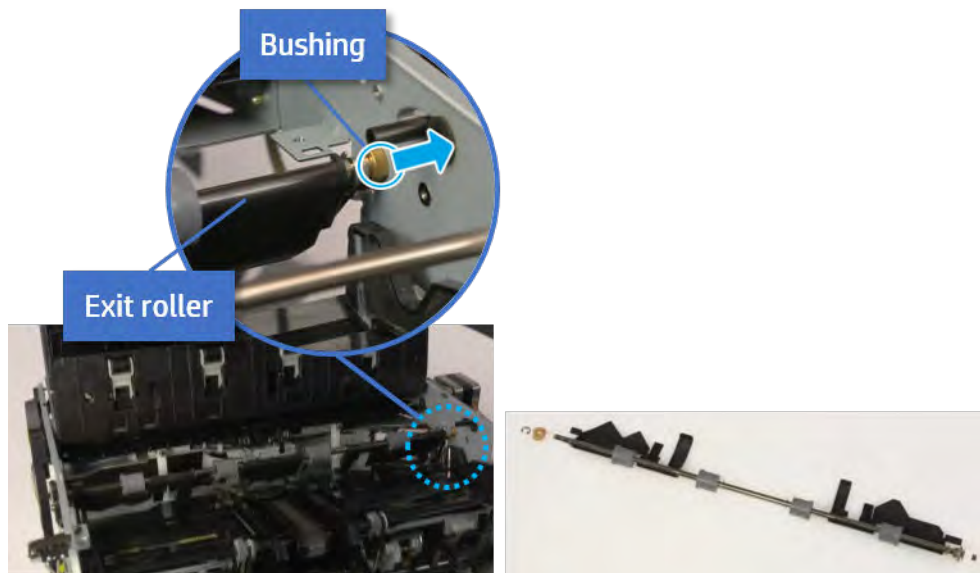
4. On the rear of the inner finisher, remove the e-ring and the pulley and then remove the e-ring and the bushing.

Figure 6-595 Remove e-ring, pulley, and bushing



5. Push the bushing to detach it, and then remove the exit roller.

Figure 6-596 Remove the exit roller

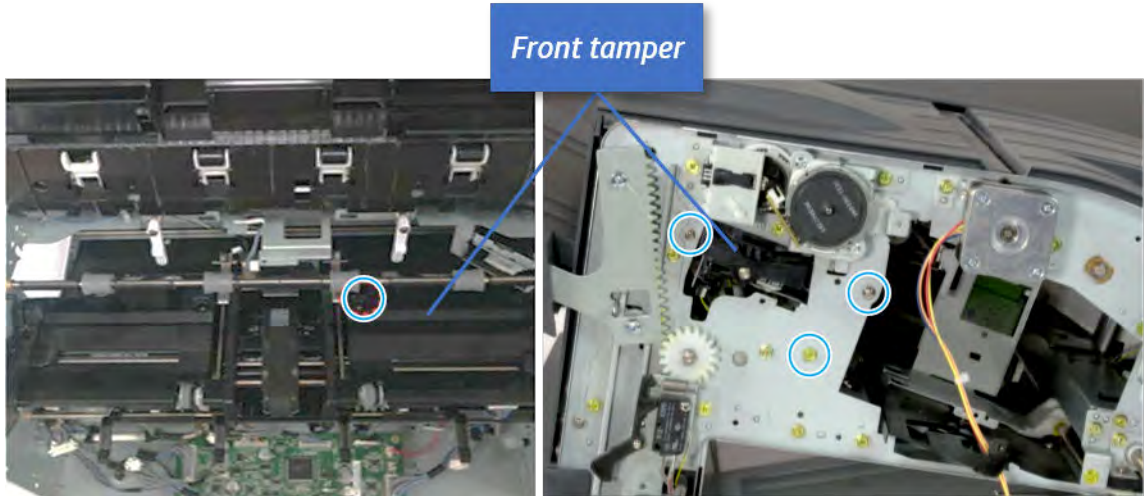


### Remove the front tamper

Follow these steps to remove the front tamper.

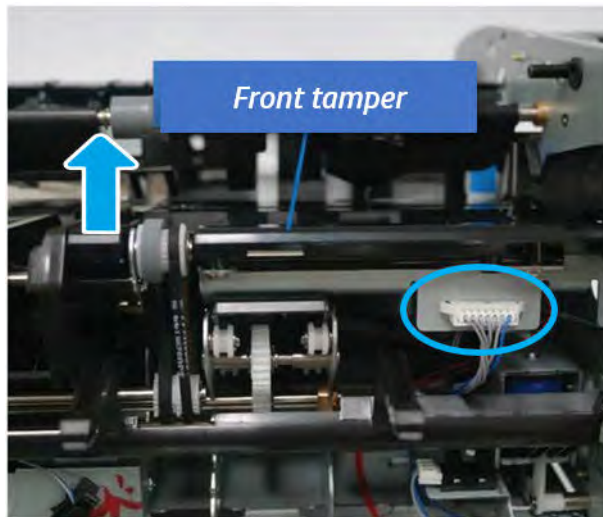
1. Remove four screws.

Figure 6-597 Remove four screws



2. Unplug the connector and release the hook, and then pull the front tamper up to remove.

Figure 6-598 Remove the front tamper



### Remove the rear tamper

Follow these steps to remove the rear tamper.

1. Remove four screws.


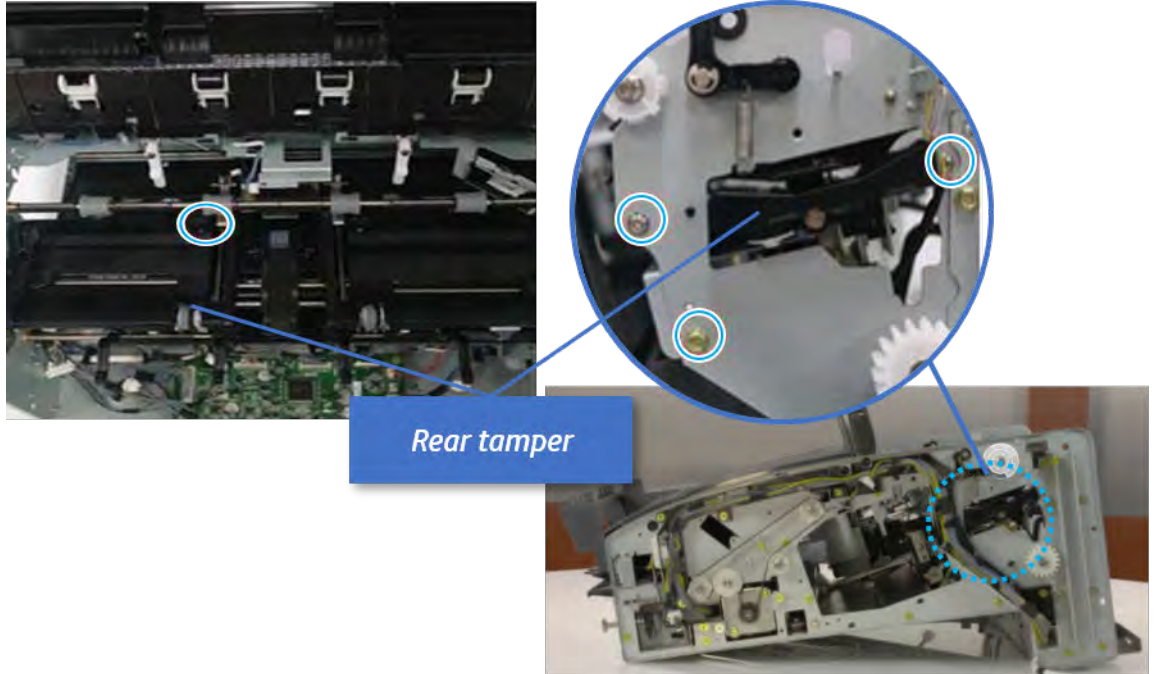
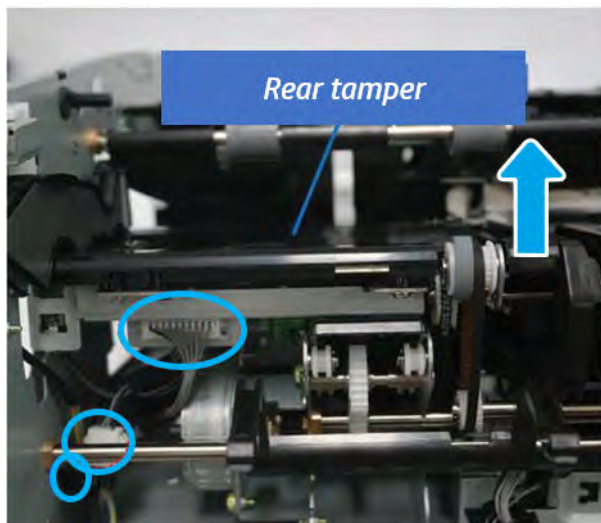
 **NOTE:** Move cable guide out of position to access the screws.

Figure 6-599 Remove four screws



2. Unplug two connectors and release the hook, and then remove the rear tamper.

Figure 6-600 Remove the rear tamper

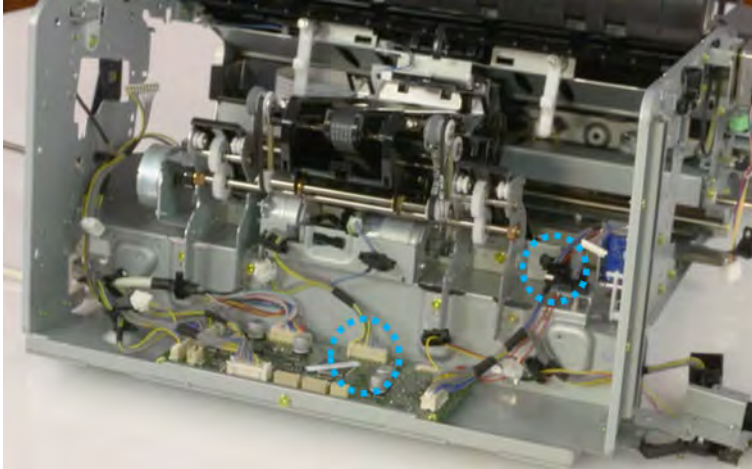


### Remove the ejector & paper support assembly

Follow these steps to remove the ejector & paper support assembly.

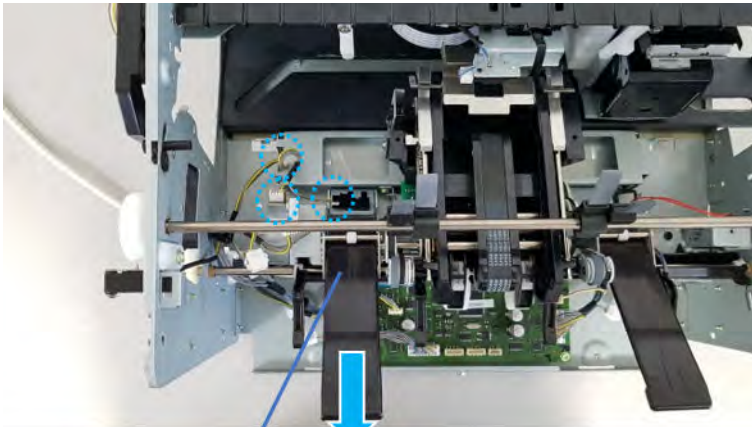
1. Open one clamp, disconnect one connector.

Figure 6-601 Disconnect one connector



2. Pull the rear paper support up, and then release one clamp and disconnect two connectors.

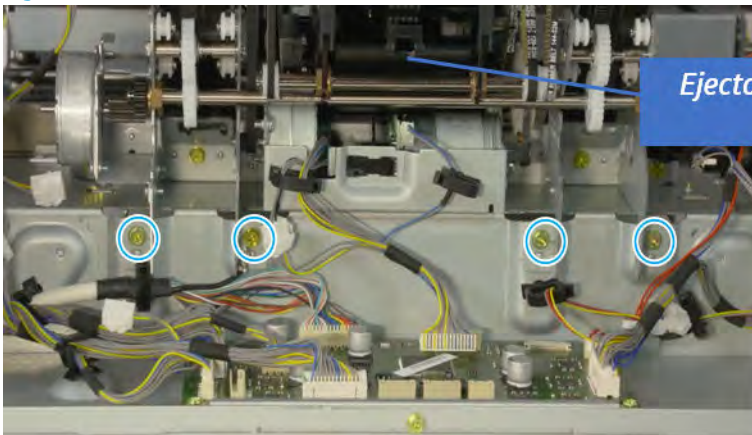
Figure 6-602 Disconnect two connector



*Rear paper support*

3. Remove four screws, and then remove the ejector & paper support assembly.

Figure 6-603 Remove the ejector & paper support assembly



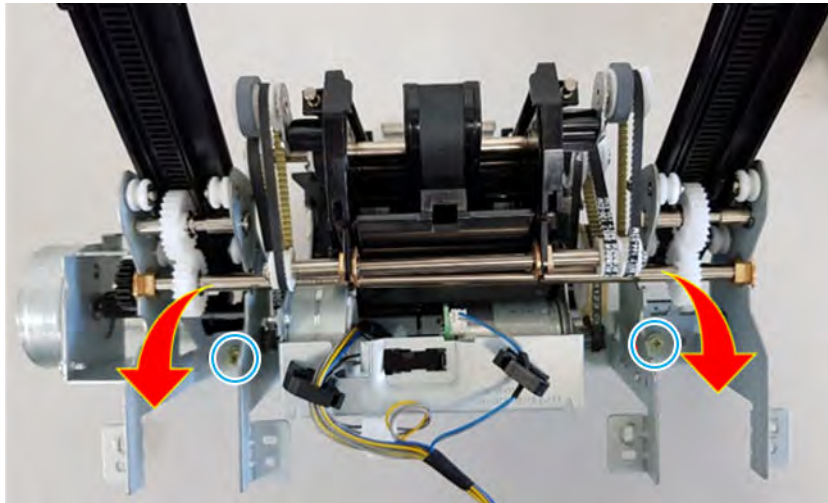
*Ejector & paper support assembly*

## Remove the front paper support and the rear paper support

Follow these steps to remove the front paper support and the rear paper support.

- ▲ Remove two screws, and then pull the paper support assembly out of ejector assembly.

Figure 6-604 Remove paper support assembly

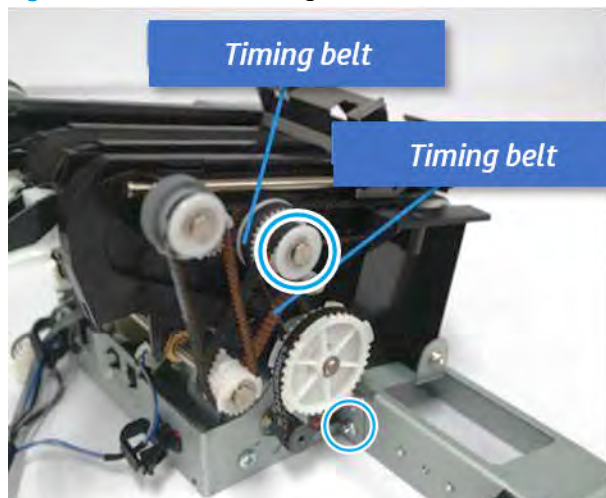


## Remove the ejector motor assembly

Follow these steps to remove the ejector motor assembly.

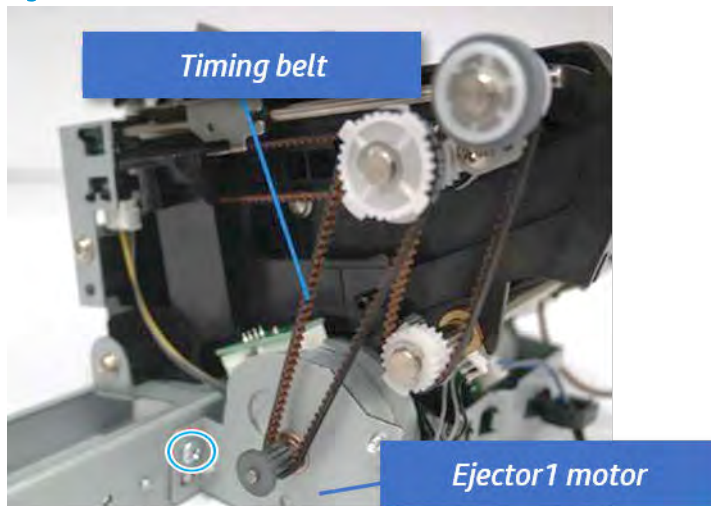
1. Remove the e-ring and washer. Remove two timing belts, and then remove one screw.

Figure 6-605 Remove e-ring, washer, belt, and screw



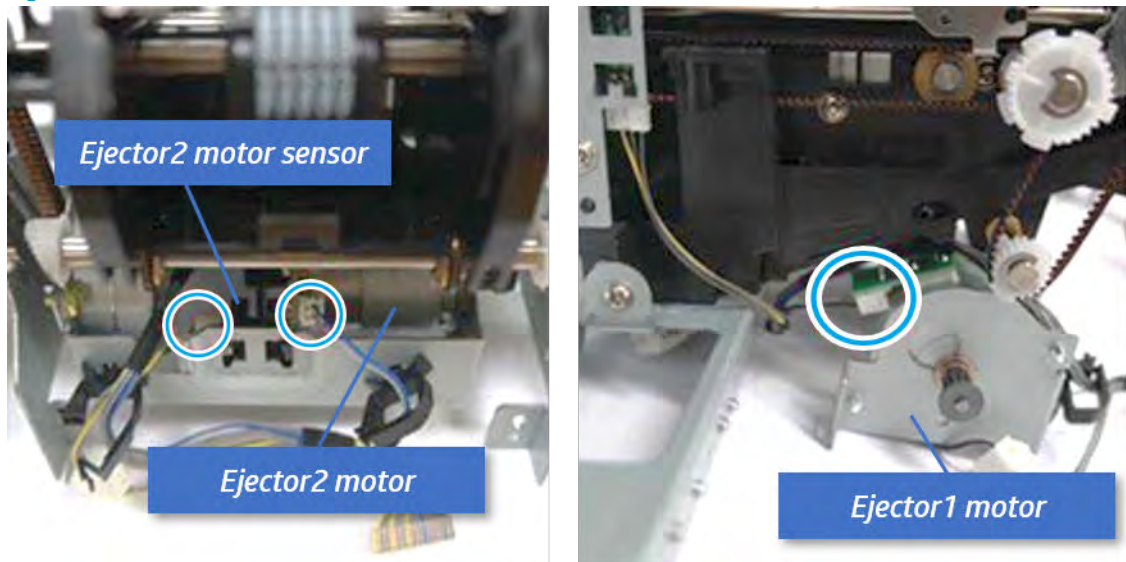
2. Remove the timing belt, and then remove one screw.

Figure 6-606 Remove the belt, screw



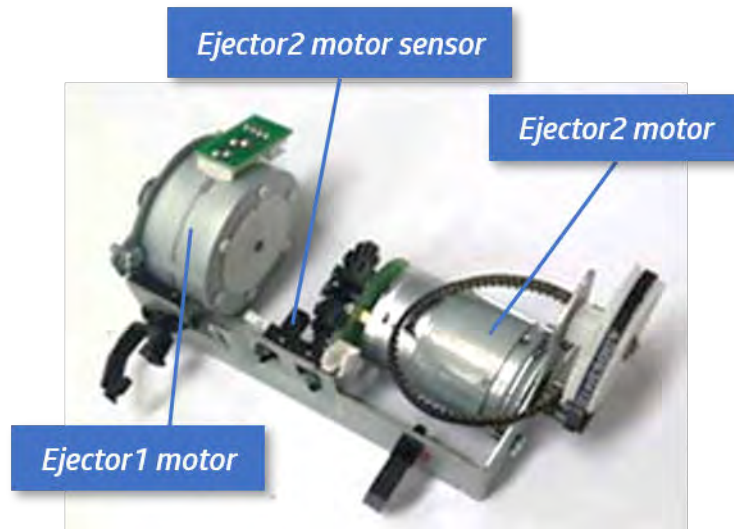
3. Remove the cable from clamp, and then disconnect two motor connectors and the sensor connector.

Figure 6-607 Disconnect the motor and sensor connectors



4. Remove the ejector motor assembly.

Figure 6-608 Remove the ejector motor assembly

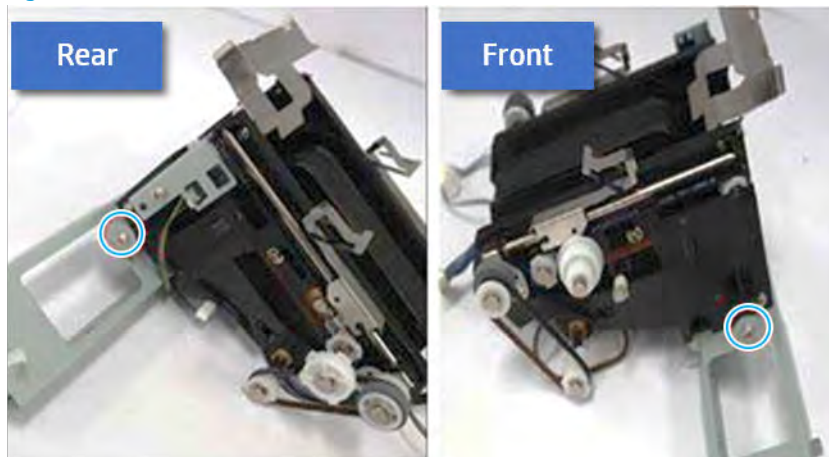


### Remove the ejector assembly

Follow these steps to remove the ejector assembly.

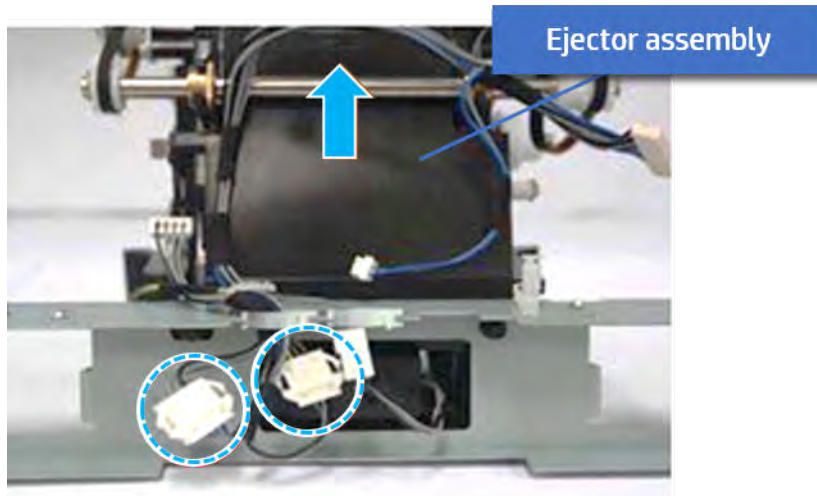
1. Remove two screws.

Figure 6-609 Remove two screws



2. Unplug two connectors, and then remove the ejector assembly.


Figure 6-610 Remove the ejector assembly



### Unpack the replacement assembly



Follow these steps to unpack the replacement assembly.

1. Dispose of the defective part.


 **NOTE:** HP recommends responsible disposal of the defective part.

<http://www8.hp.com/us/en/hp-information/environment/product-recycling.html>


2. Unpack the replacement part from the packaging.

 **CAUTION:**  Some parts are sensitive to electrostatic discharge (ESD). Always perform service work at an ESD-protected workstation or mat. If an ESD workstation or mat is not available, touch the sheet-metal chassis to provide a static ground before touching an ESD-sensitive assembly. Protect the ESD-sensitive assemblies by placing them in ESD pouches when they are out of the printer.

 **IMPORTANT:** Make sure that all of the shipping materials (for example shipping tape) are removed from the replacement part prior to installation.

 **NOTE:** If the replacement part is a roller or pad, avoid touching the spongy part of it. Skin oils on the roller or pad can cause paper pickup and/or print-quality problems. HP recommends using disposable gloves when handling rollers or pads or washing your hands before touching rollers or pads.

3. To install an assembly, reverse the removal steps.

 **NOTE:** When applicable, special installation instructions are provided for an assembly at the end of the removal procedure. Always completely read the removal instructions and follow all special installation instructions.



## End fence unit

## Removal and replacement: End fence sensor (S17)


Learn how to remove and replace the end fence sensor.

To view teardown and reassembling video of the inner finisher, click the link below.

 [View a teardown video of the inner finisher.](#)

 [View a reassembling video of the inner finisher.](#)

---

 **IMPORTANT:** When applicable, special installation instructions are provided for an assembly at the end of the removal procedure. Always completely read the removal instructions and follow all special installation instructions.

---

Mean time to repair:


Service level:

### Before performing service

#### Turn the printer power off

- Press the power button on the front of the printer, and then turn off the power switch next to the power cable.
- A shutting-down message appears on the control-panel display.

---

 **WARNING!** To avoid damage to the printer, turn the power off and wait until the printer shuts down before removing the power cable.

---

- Disconnect the printer power cable after the printer has completely shut down (the control-panel display is blank).

Use the table below to identify the correct part number for your printer. To order the part, go to [www.hp.com/buy/parts](http://www.hp.com/buy/parts).

Table 6-65 Part information

Part number	Part description
0604-001381	End fence sensor

### Required tools

- #2 JIS screwdriver with a magnetic tip

### After performing service

#### Turn the printer power on

- Connect the power cable.
- Use the power switch to turn the power on.

### Post service test

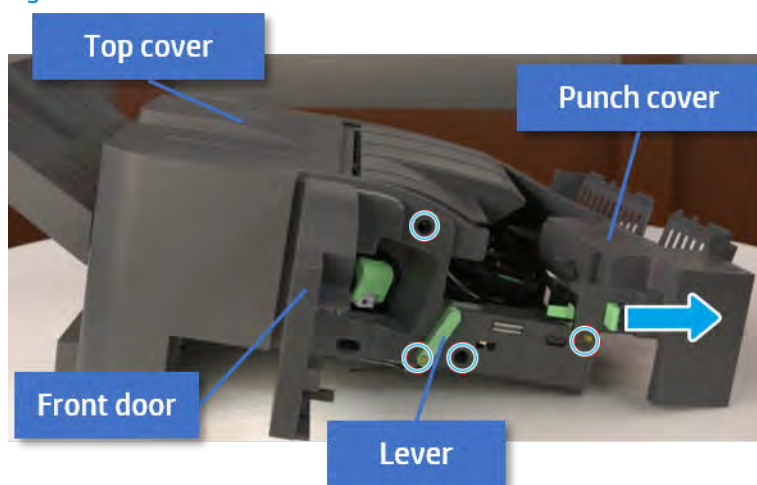
Print any pages necessary to verify that the repair resolved the issue and did not create any new issues.

## Remove the front cover

Follow these steps to remove the front cover:

1. Open the front door and open the punch cover.
2. Remove three screws in the front.
3. Remove the lever.
4. Open the top cover.
5. From the right side of the front cover, carefully lift and pry toward the top-left corner to remove the front cover.

Figure 6-611 Remove the front cover

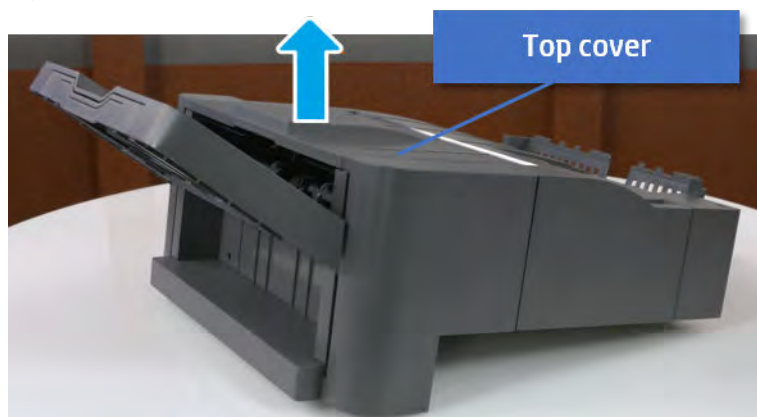


## Remove the rear cover

Follow these steps to remove the rear cover:

1. Open the top cover.

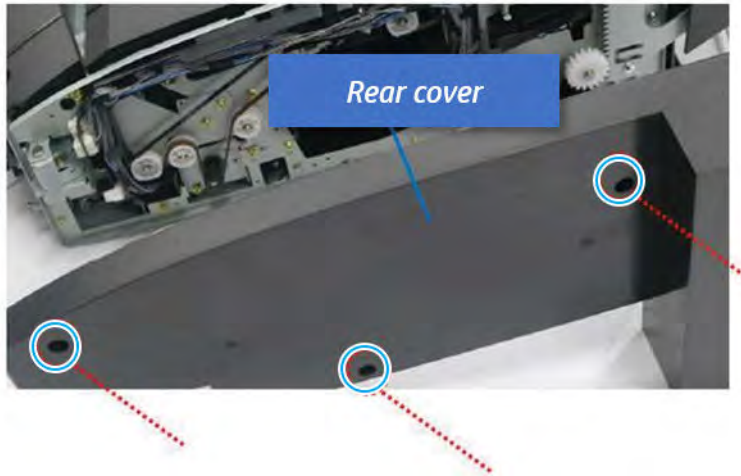
Figure 6-612 Open the top cover



2. Remove three screws.

3. Release hooks carefully and remove the rear cover.

Figure 6-613 Remove the rear cover



### Remove the middle cover

Follow these steps to remove the middle cover.

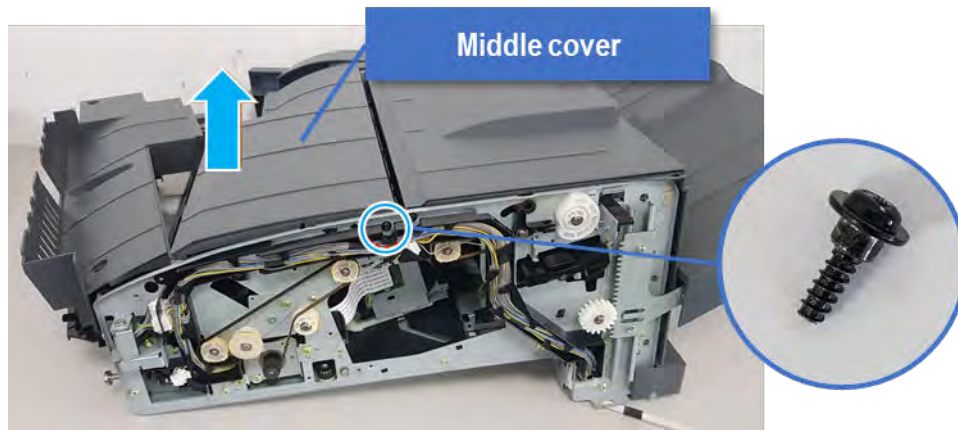
1. Open the front door and then open the punch cover.

Figure 6-614 Open the front door and punch cover



2. Remove left-side one screw at the rear of the inner finisher, and then remove the middle cover by lifting off the hinge pins at the front.

Figure 6-615 Remove the middle cover

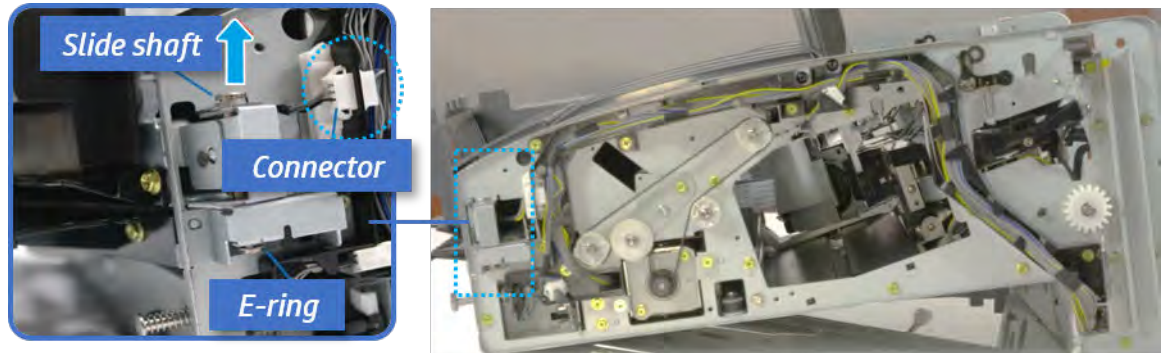


### Remove the punch cover

Follow these steps to remove the punch cover.

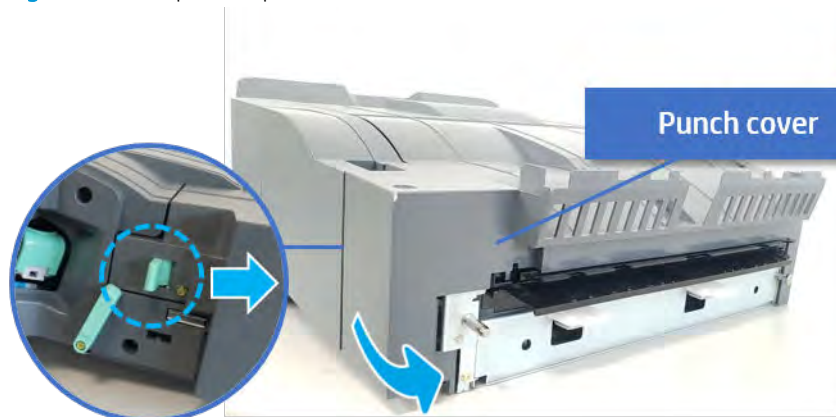
1. Unplug the connector. Remove the e-ring, and then remove the slide shaft at the rear of the inner finisher.

Figure 6-616 Remove the slide shaft



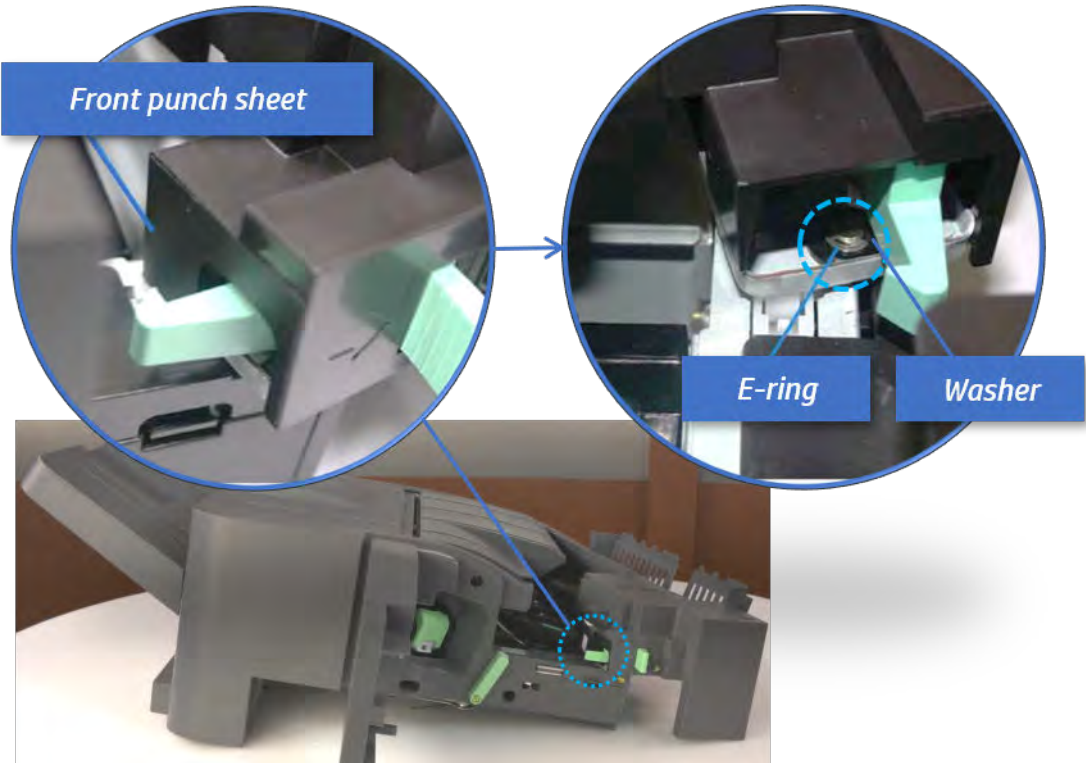
2. Open the punch cover.

Figure 6-617 Open the punch cover



3. Remove the front punch sheet, and then remove the e-ring and the washer. And then remove the punch cover.

Figure 6-618 Remove the punch cover

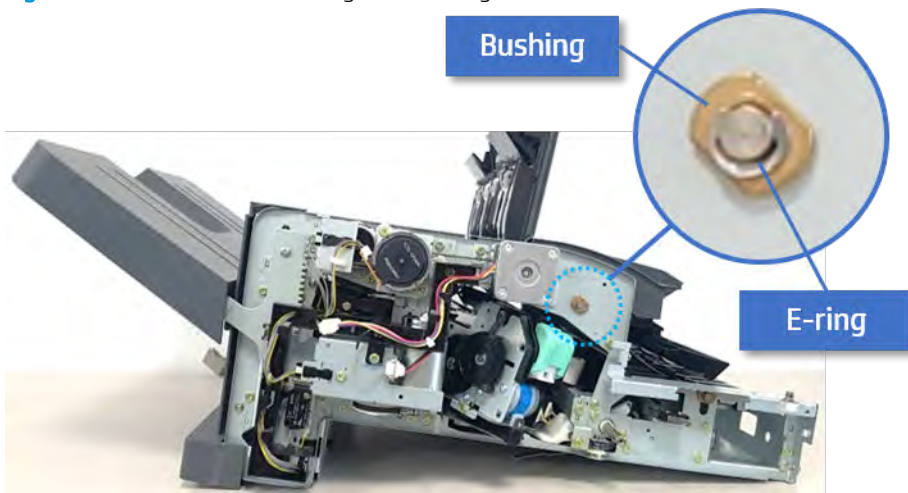


#### Remove the diverter guide and the middle roller

Follow these steps to remove the diverter guide and the middle roller.

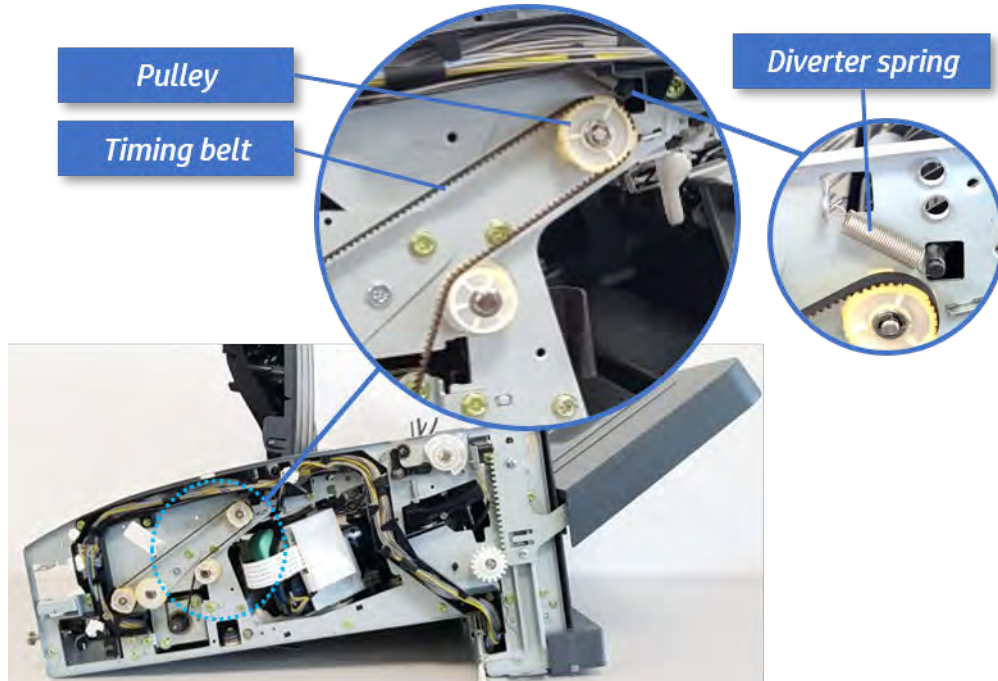
1. On the front of the inner finisher, remove the e-ring and bushing.

Figure 6-619 Remove the e-ring and bushing



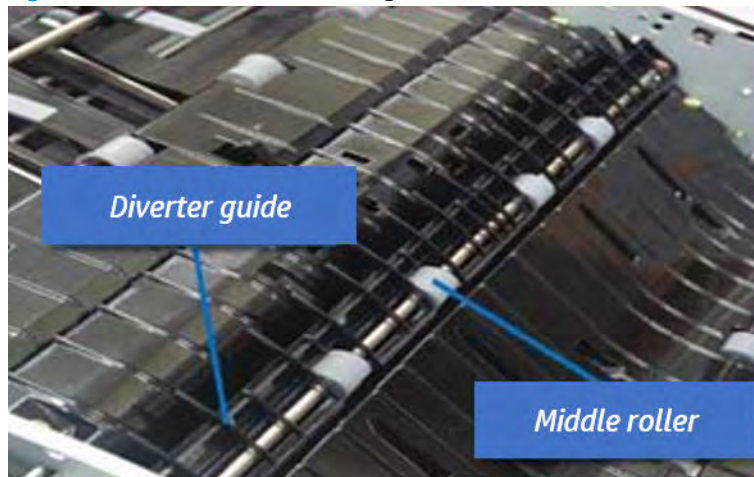
2. On the rear of the inner finisher, remove the e-ring, pulley, bushing, belt, and spring (slightly hidden from view).

**Figure 6-620** Remove the e-ring, pulley, bushing, belt, and spring



3. Remove the diverter guide and the middle roller.

**Figure 6-621** Remove the diverter guide and the middle roller

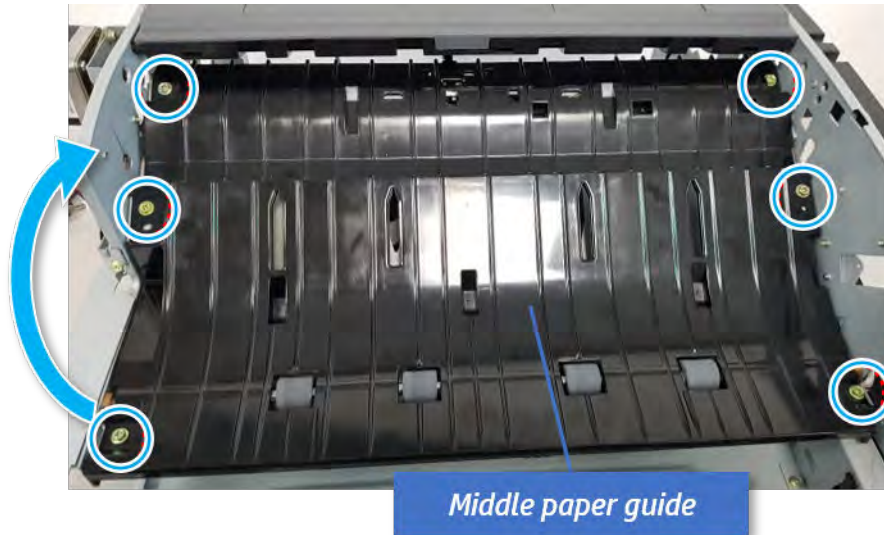


### Remove the middle paper guide

Follow these steps to remove the middle paper guide.

1. Remove six screws, and then open the middle paper guide in the direction of the arrow.

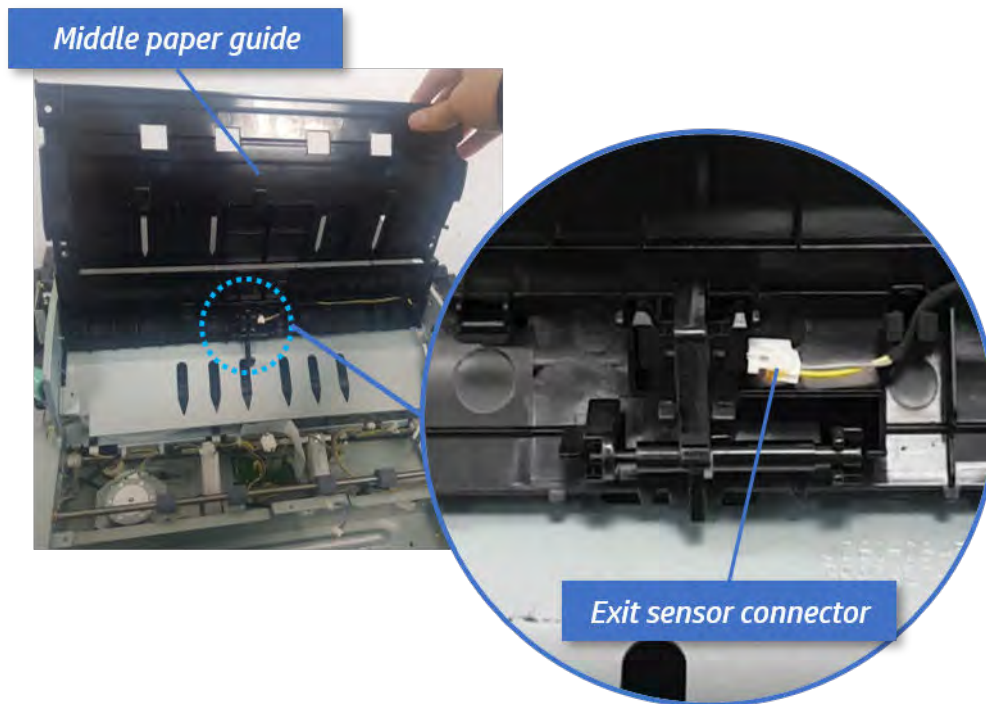
Figure 6-622 Open the middle paper guide



 **NOTE:** Be careful not to damage the sensor connector.

2. Unplug the connector under the middle paper guide. And then, remove the middle paper guide.

Figure 6-623 Remove the middle paper guide



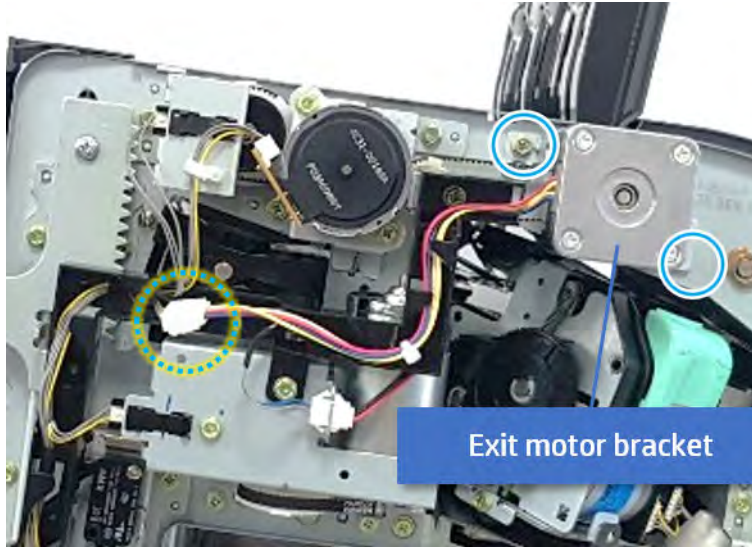
### Remove the exit motor bracket

Follow these steps to remove the exit motor bracket.

- ▲ Remove two screws, unplug the motor connector. And then remove exit motor bracket.



Figure 6-624 Remove the exit motor bracket

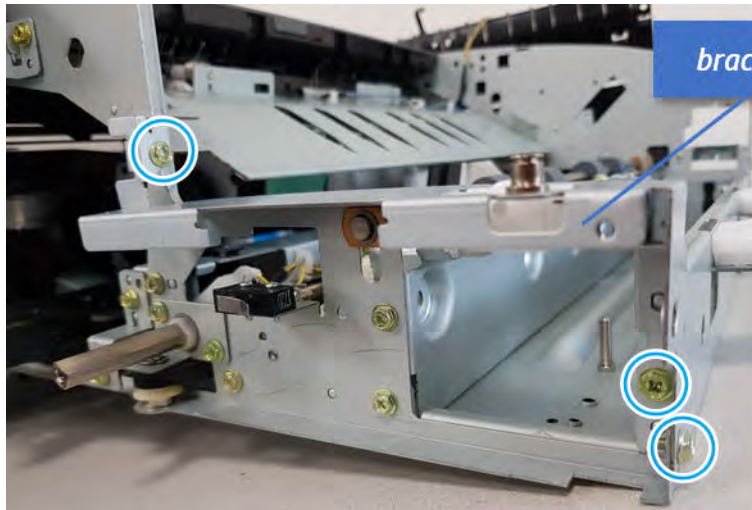


### Remove the end fence sensor bracket

Follow these steps to remove the end fence sensor bracket.

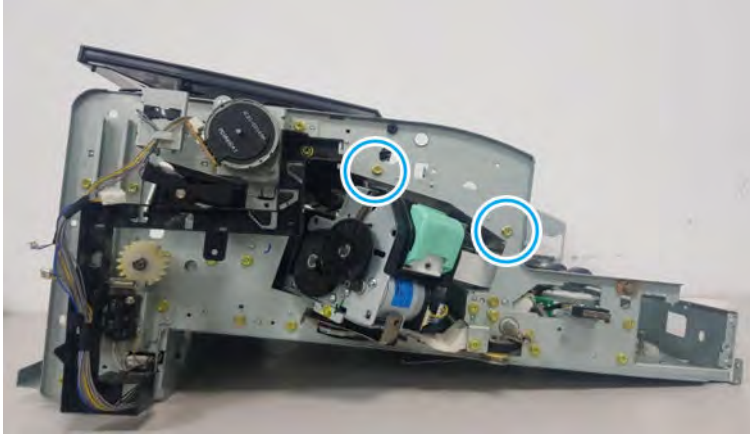
1. Remove three screws at the front of the inner finisher, and then remove the bracket.

Figure 6-625 Remove the bracket



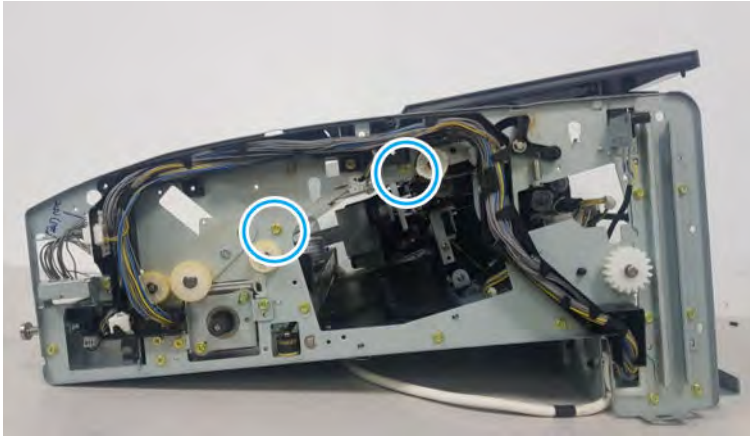
2. Remove two screws at the front of the inner finisher.

Figure 6-626 Remove two screws



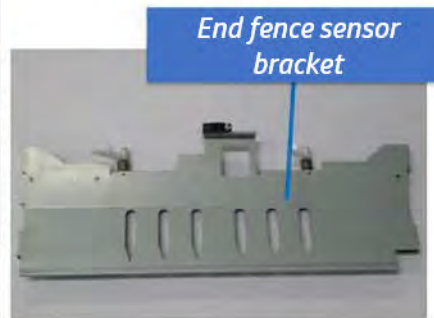
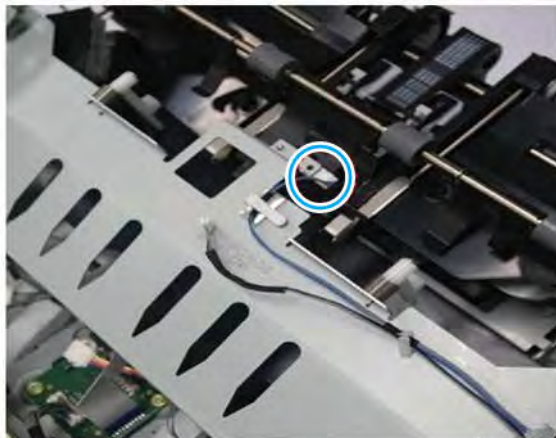
3. Remove two screws at the rear of the inner finisher.

Figure 6-627 Remove two screws



4. Loosen three cable clamps. Unplug the connector at the sensor, and then remove the end fence sensor bracket.

Figure 6-628 Remove the end fence sensor bracket

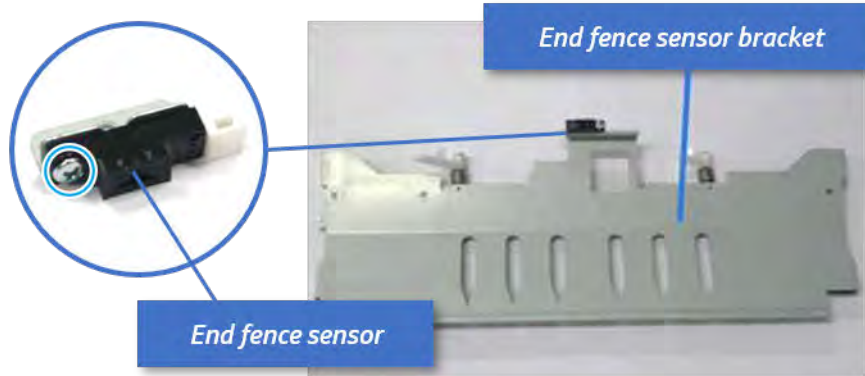


## Remove the end fence sensor

Follow these steps to remove the end fence sensor.

- ▲ Remove one screw, and then remove the end fence sensor.

Figure 6-629 Remove the end fence sensor



## Unpack the replacement assembly



Follow these steps to unpack the replacement assembly.


1. Dispose of the defective part.


 **NOTE:** HP recommends responsible disposal of the defective part.

<http://www8.hp.com/us/en/hp-information/environment/product-recycling.html>


2. Unpack the replacement part from the packaging.

 **CAUTION:**  Some parts are sensitive to electrostatic discharge (ESD). Always perform service work at an ESD-protected workstation or mat. If an ESD workstation or mat is not available, touch the sheet-metal chassis to provide a static ground before touching an ESD-sensitive assembly. Protect the ESD-sensitive assemblies by placing them in ESD pouches when they are out of the printer.

 **IMPORTANT:** Make sure that all of the shipping materials (for example shipping tape) are removed from the replacement part prior to installation.

 **NOTE:** If the replacement part is a roller or pad, avoid touching the spongy part of it. Skin oils on the roller or pad can cause paper pickup and/or print-quality problems. HP recommends using disposable gloves when handling rollers or pads or washing your hands before touching rollers or pads.

3. To install an assembly, reverse the removal steps.

 **NOTE:** When applicable, special installation instructions are provided for an assembly at the end of the removal procedure. Always completely read the removal instructions and follow all special installation instructions.

## Output tray unit

## Removal and replacement: Output tray


Learn how to remove and replace the output tray.

To view teardown and reassembling video of the inner finisher, click the link below.

 [View a teardown video of the inner finisher.](#)

 [View a reassembling video of the inner finisher.](#)

---

 **IMPORTANT:** When applicable, special installation instructions are provided for an assembly at the end of the removal procedure. Always completely read the removal instructions and follow all special installation instructions.

---

Mean time to repair:


Service level:

### Before performing service

#### Turn the printer power off

- Press the power button on the front of the printer, and then turn off the power switch next to the power cable.
- A shutting-down message appears on the control-panel display.

---

 **WARNING!** To avoid damage to the printer, turn the power off and wait until the printer shuts down before removing the power cable.

---

- Disconnect the printer power cable after the printer has completely shut down (the control-panel display is blank).

Use the table below to identify the correct part number for your printer. To order the part, go to <http://www.hp.com/buy/parts>.

**Table 6-66** Part information

Part number	Part description
JC90-01337B	Output tray

### Required tools

- #2 JIS screwdriver with a magnetic tip

### After performing service

#### Turn the printer power on

- Connect the power cable.
- Use the power switch to turn the power on.

### Post service test

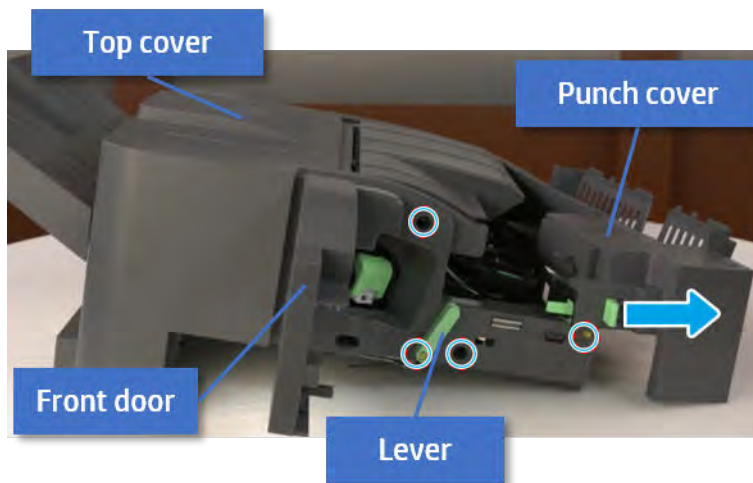
Print any pages necessary to verify that the repair resolved the issue and did not create any new issues.

## Remove the front cover

Follow these steps to remove the front cover.

1. Open the front door and open the punch cover.
2. Remove three screws in the front.
3. Remove the lever.
4. Open the top cover.
5. From the right side of the front cover, carefully lift and pry toward the top-left corner to remove the front cover.

Figure 6-630 Remove the front cover

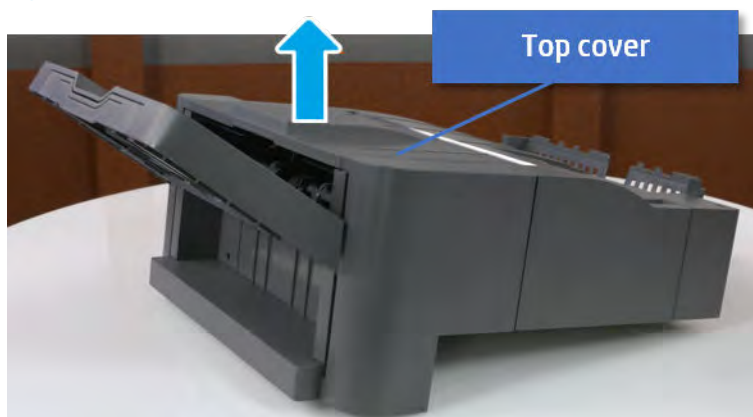


## Remove the rear cover

Follow these steps to remove the rear cover.

1. Open the top cover.

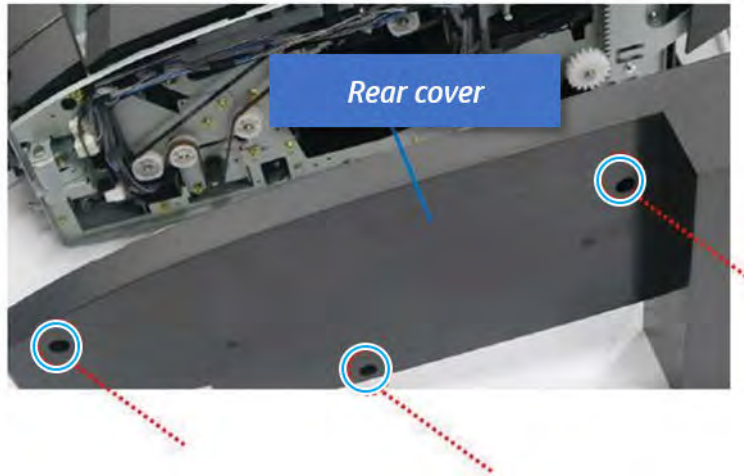
Figure 6-631 Open the top cover



2. Remove three screws.

3. Release hooks carefully and remove the rear cover.

Figure 6-632 Remove the rear cover

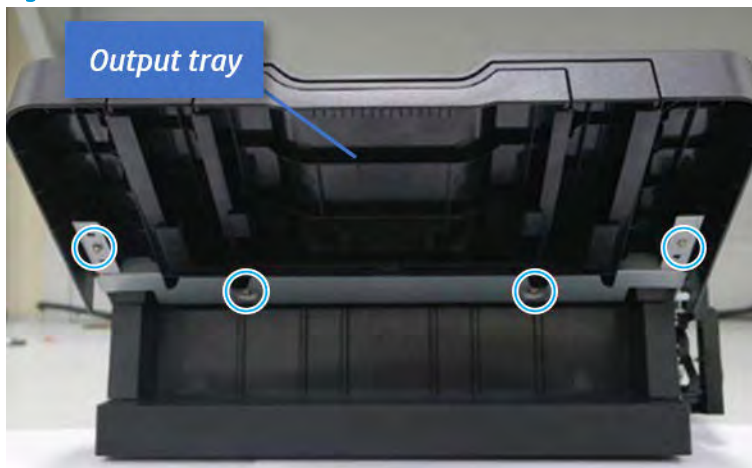


### Remove the output tray

Follow these steps to remove the output tray.

1. Remove four screws.

Figure 6-633 Remove four screws



2. Push the paper holding actuator into the inner finisher, and then remove the output tray.

Figure 6-634 Remove the output tray.

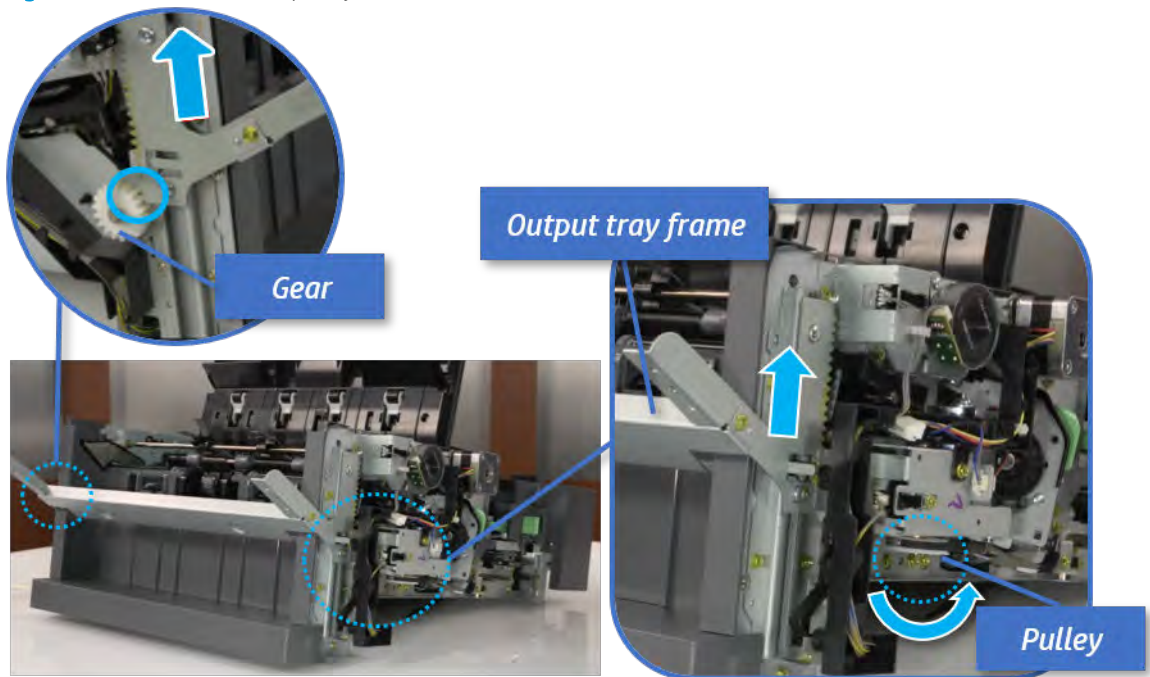


### Remove the output tray frame

Follow these steps to remove the output tray frame.

1. Rotate the pulley until the output tray frame depart from the gear.

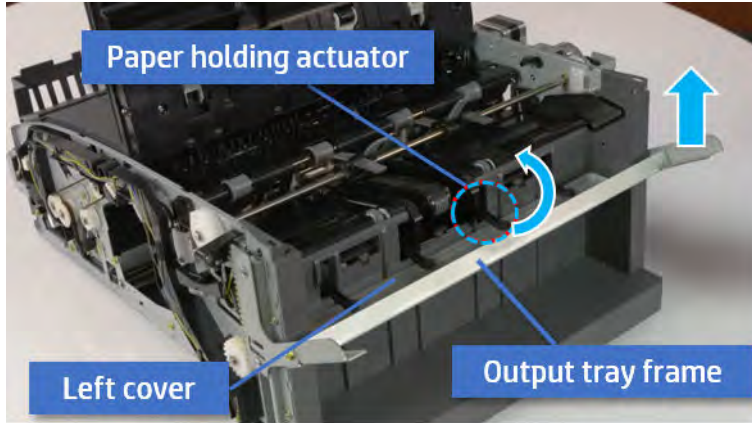
Figure 6-635 Remove the pulley



2. Push the paper holding actuator into the inner finisher, and then remove the output tray frame.

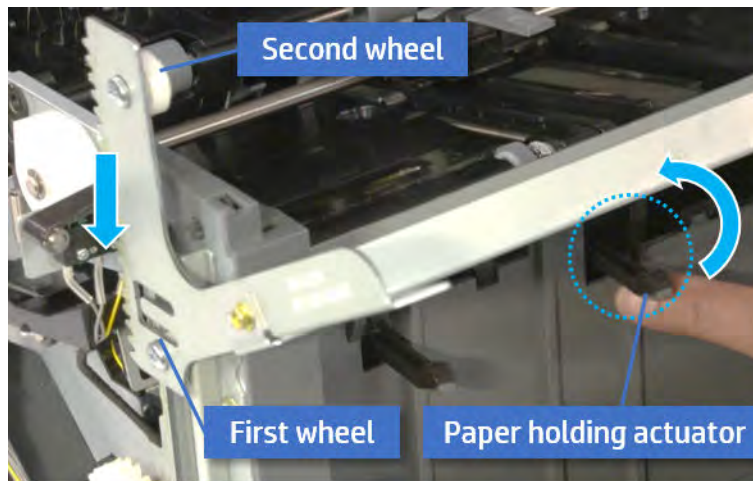


Figure 6-636 Remove the output tray frame

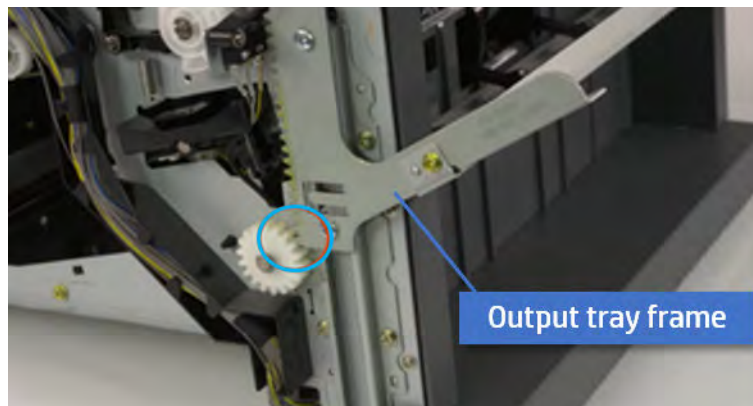


**TIP:** Push the paper holding actuator into the inner finisher when reassembling. Be sure to level the output tray.

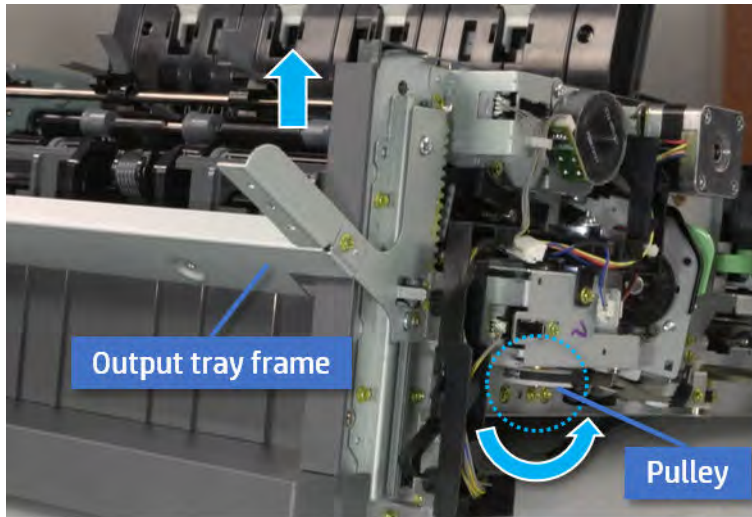
- a. Position the first wheel into the channel on both sides while pushing the paper holding actuator.



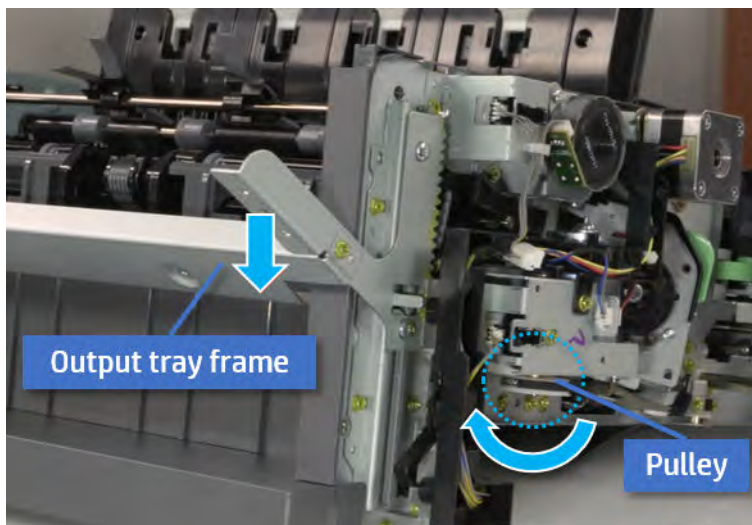
- b. Let the second wheel rest on the channel on both sides simultaneously.
- c. Gently squeeze the wheels into channel until the output tray frame meet the gear.



- d. Rotate the pulley until the output tray frame is no longer lifted. It can make to level the output tray frame.



- e. Rotate the pulley in the opposite direction.



### Unpack the replacement assembly

Follow these steps to unpack the replacement assembly.

1. Dispose of the defective part.



---

 **NOTE:** HP recommends responsible disposal of the defective part.


<http://www8.hp.com/us/en/hp-information/environment/product-recycling.html>

---

2. Unpack the replacement part from the packaging.


 **CAUTION:**  Some parts are sensitive to electrostatic discharge (ESD). Always perform service work at an ESD-protected workstation or mat. If an ESD workstation or mat is not available, touch the sheet-metal chassis to provide a static ground before touching an ESD-sensitive assembly. Protect the ESD-sensitive assemblies by placing them in ESD pouches when they are out of the printer.

 **IMPORTANT:** Make sure that all of the shipping materials (for example shipping tape) are removed from the replacement part prior to installation.

 **NOTE:** If the replacement part is a roller or pad, avoid touching the spongy part of it. Skin oils on the roller or pad can cause paper pickup and/or print-quality problems. HP recommends using disposable gloves when handling rollers or pads or washing your hands before touching rollers or pads.

---

3. To install an assembly, reverse the removal steps.

 **NOTE:** When applicable, special installation instructions are provided for an assembly at the end of the removal procedure. Always completely read the removal instructions and follow all special installation instructions.

---

## Removal and replacement: Output tray top of stack sensor (S8)


Learn how to remove and replace the output tray top of stack sensor.

To view teardown and reassembling video of the inner finisher, click the link below.

 [View a teardown video of the inner finisher.](#)

 [View a reassembling video of the inner finisher.](#)

---

 **IMPORTANT:** When applicable, special installation instructions are provided for an assembly at the end of the removal procedure. Always completely read the removal instructions and follow all special installation instructions.

---

Mean time to repair:


Service level:

### Before performing service

#### Turn the printer power off

- Press the power button on the front of the printer, and then turn off the power switch next to the power cable.
- A shutting-down message appears on the control-panel display.

---

 **WARNING!** To avoid damage to the printer, turn the power off and wait until the printer shuts down before removing the power cable.

---

- Disconnect the printer power cable after the printer has completely shut down (the control-panel display is blank).

Use the table below to identify the correct part number for your printer. To order the part, go to <http://www.hp.com/buy/parts>.

Table 6-67 Part information

Part number	Part description
JC82-01039A	output tray top of stack sensor

### Required tools

- #2 JIS screwdriver with a magnetic tip

### After performing service

#### Turn the printer power on

- Connect the power cable.
- Use the power switch to turn the power on.

### Post service test

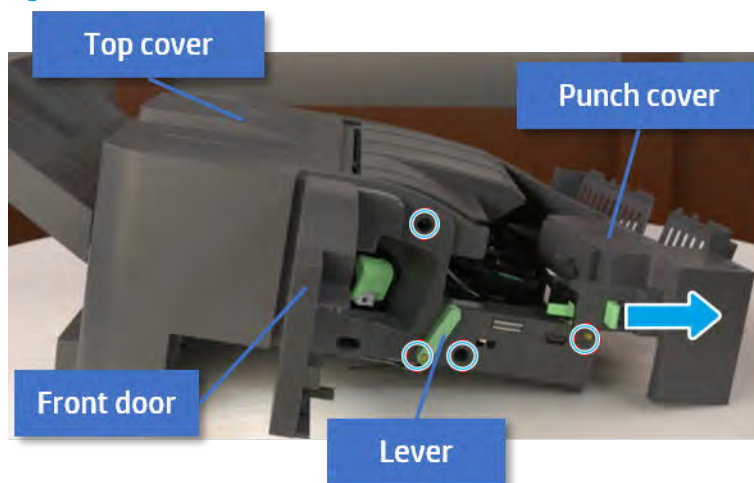
Print any pages necessary to verify that the repair resolved the issue and did not create any new issues.

## Remove the front cover

Follow these steps to remove the front cover:

1. Open the front door and open the punch cover.
2. Remove three screws in the front.
3. Remove the lever.
4. Open the top cover.
5. From the right side of the front cover, carefully lift and pry toward the top-left corner to remove the front cover.

Figure 6-637 Remove the front cover

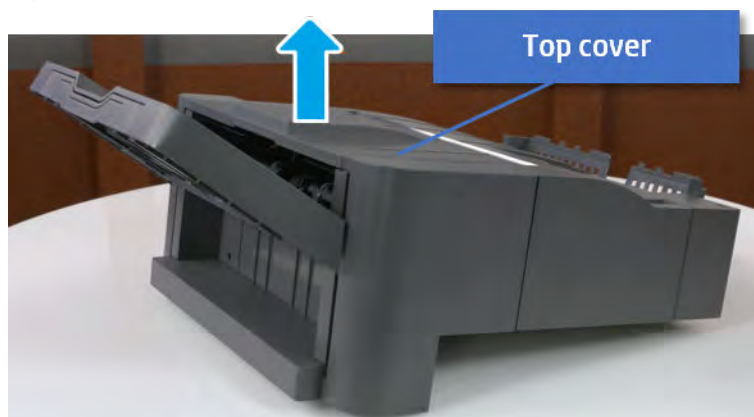


## Remove the rear cover

Follow these steps to remove the rear cover:

1. Open the top cover.

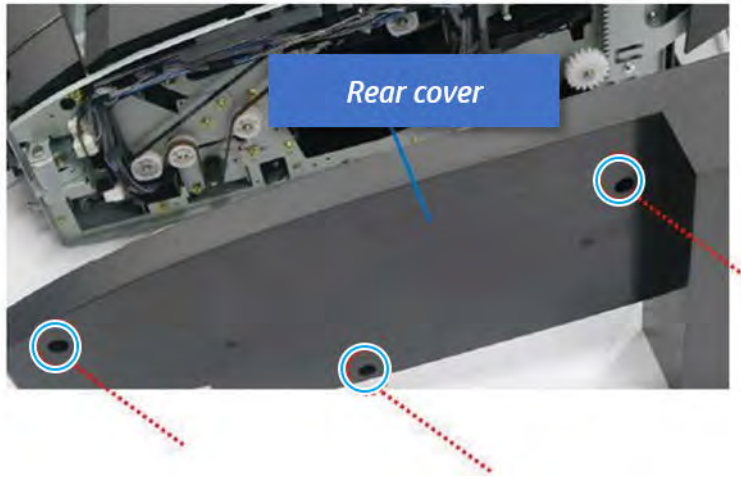
Figure 6-638 Open the top cover



2. Remove three screws.

3. Release hooks carefully and remove the rear cover.

Figure 6-639 Remove the rear cover

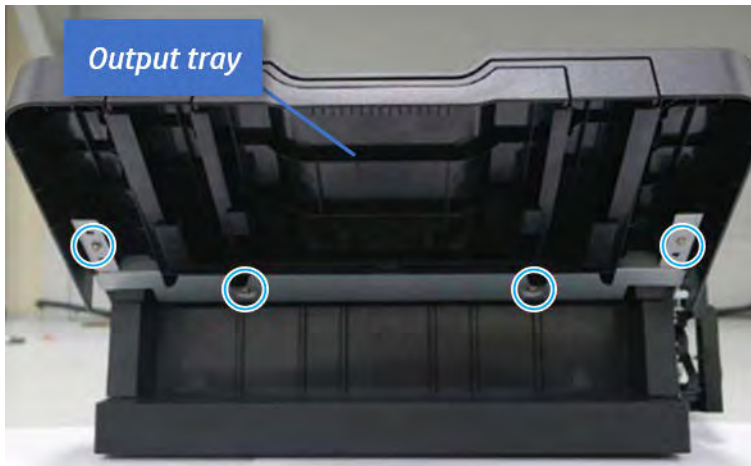


### Remove the output tray

Follow these steps to remove the output tray.

1. Remove four screws.

Figure 6-640 Remove four screws



2. Push the paper holding actuator into the inner finisher, and then remove the output tray.

Figure 6-641 Remove the output tray.

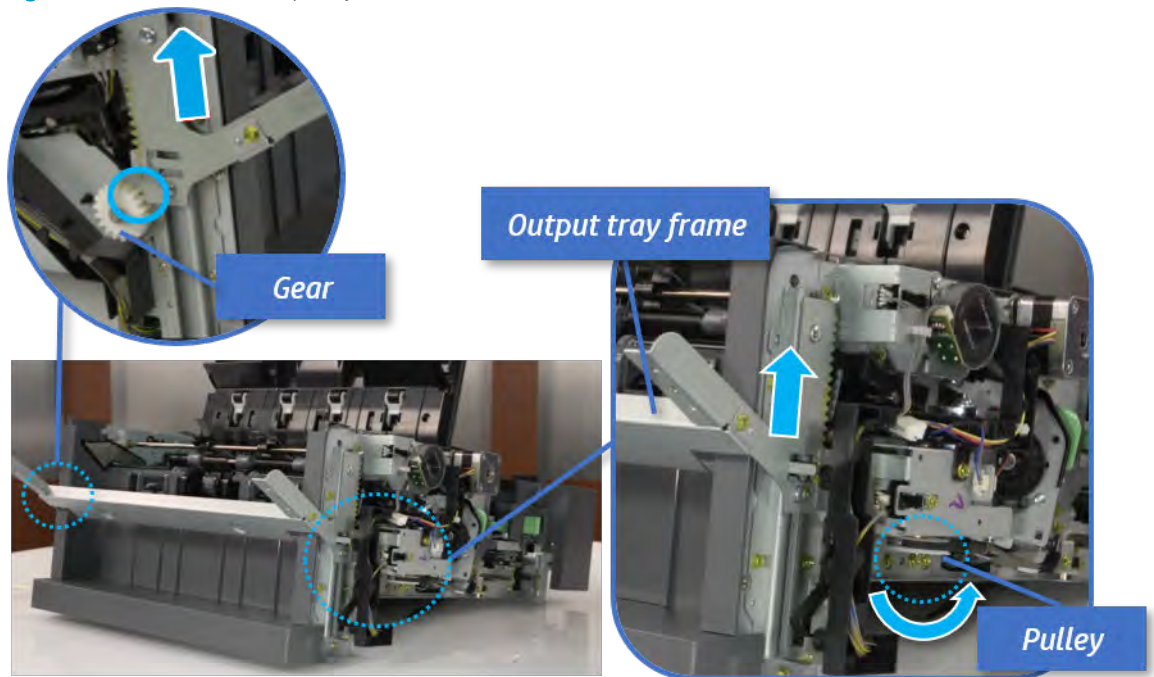


### Remove the output tray frame

Follow these steps to remove the output tray frame.

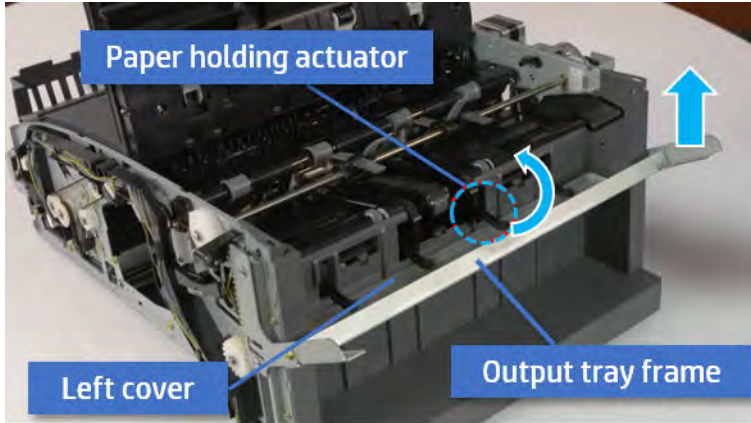
1. Rotate the pulley until the output tray frame depart from the gear.

Figure 6-642 Remove the pulley



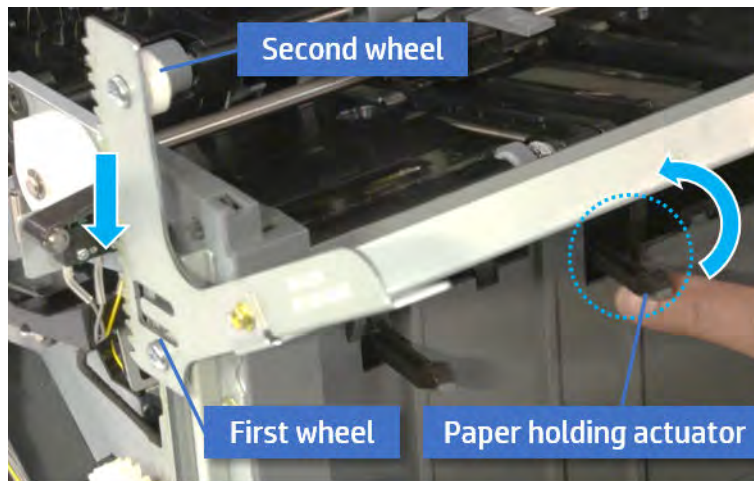
2. Push the paper holding actuator into the inner finisher, and then remove the output tray frame.

Figure 6-643 Remove the output tray frame

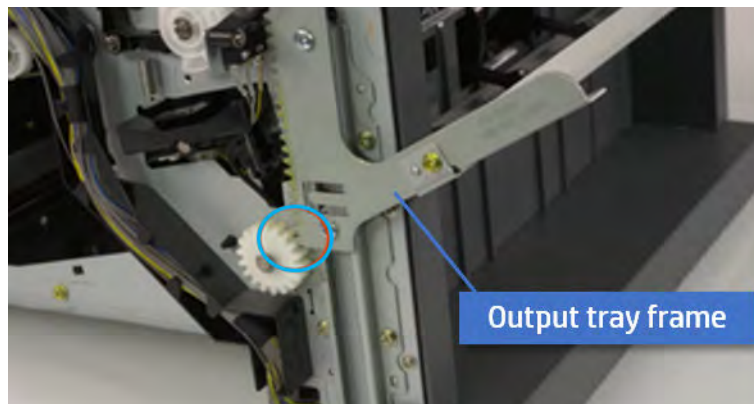


**TIP:** Push the paper holding actuator into the inner finisher when reassembling. Be sure to level the output tray.

- a. Position the first wheel into the channel on both sides while pushing the paper holding actuator.

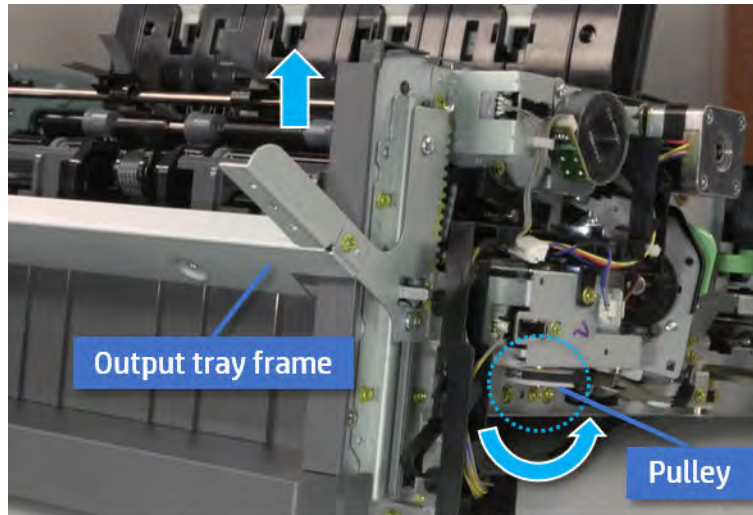


- b. Let the second wheel rest on the channel on both sides simultaneously.
- c. Gently squeeze the wheels into channel until the output tray frame meet the gear.

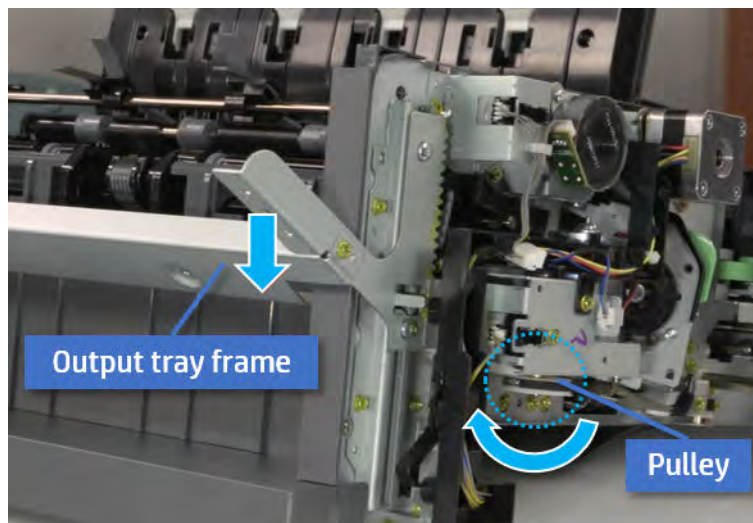




- d. Rotate the pulley until the output tray frame is no longer lifted. It can make to level the output tray frame.



- e. Rotate the pulley in the opposite direction.

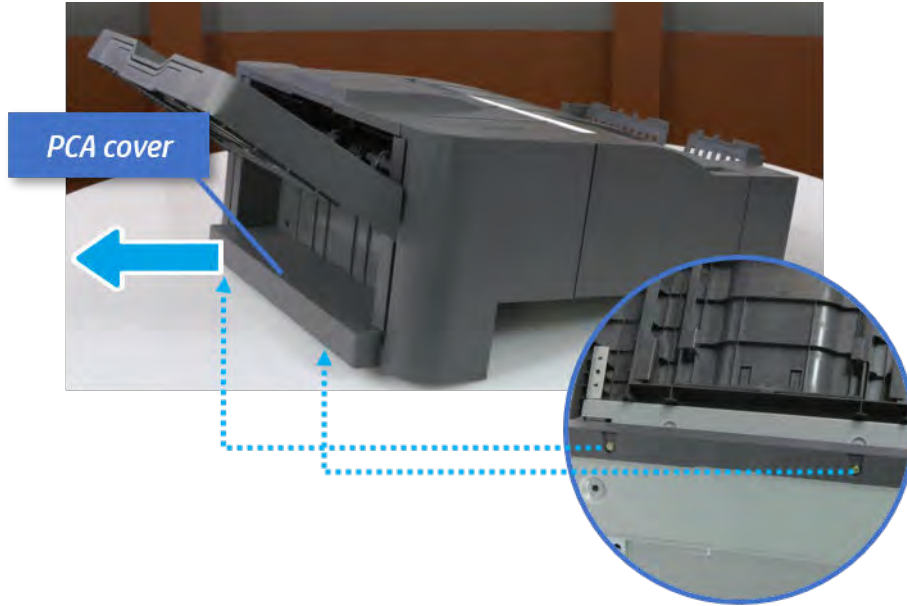


### Remove the PCA cover

Follow these steps to remove the PCA cover.

- ▲ Remove two screws, and then remove the PCA cover.

Figure 6-644 Remove the PCA cover

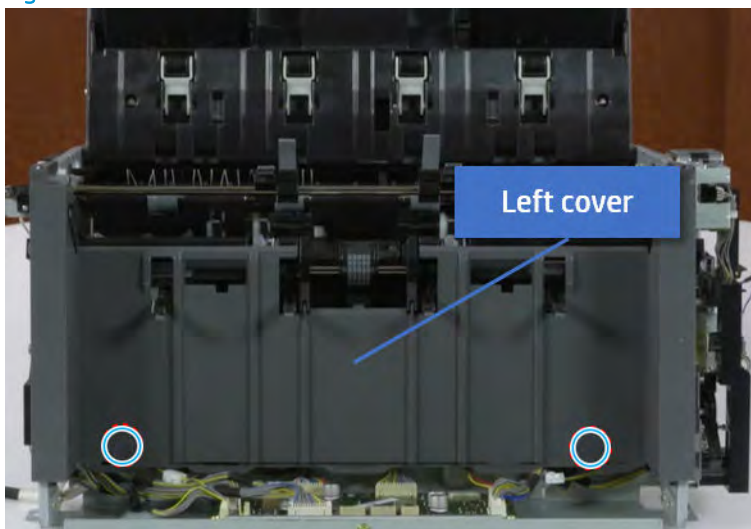


### Remove the left cover

Follow these steps to remove the left cover.

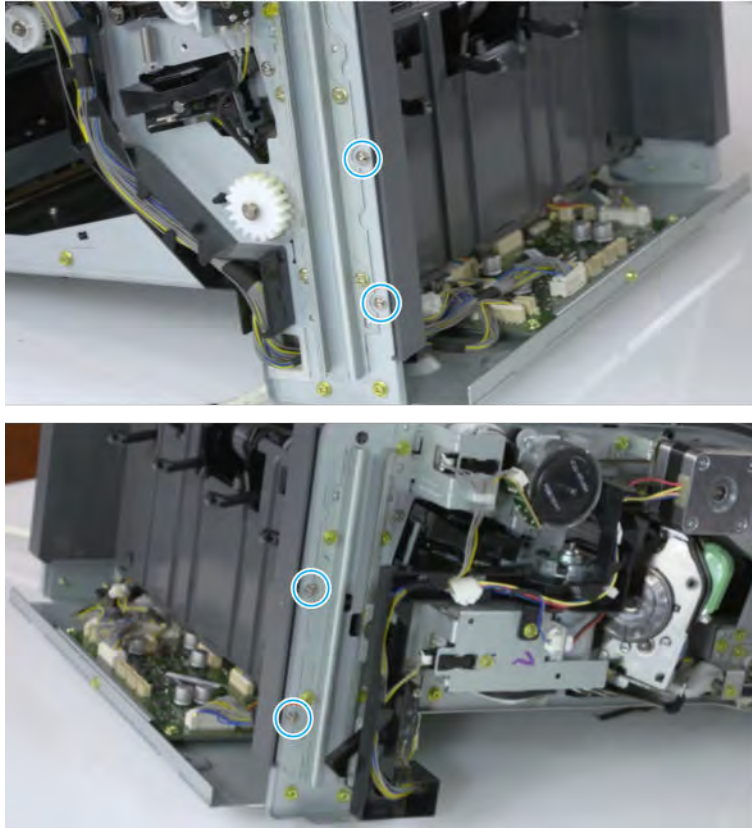
1. Remove two screws.

Figure 6-645 Remove two screws



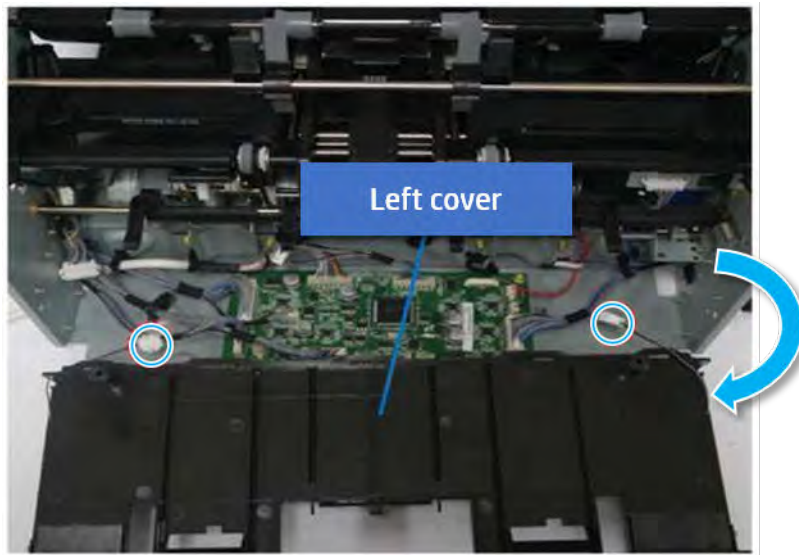
2. Remove four screws from both front and rear sides.


Figure 6-646 Remove four screws

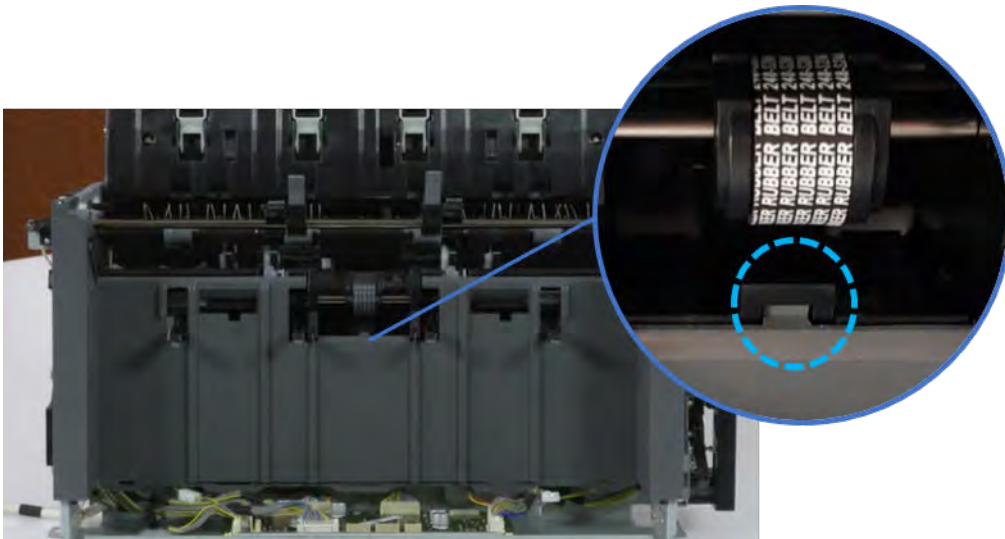


3. Unplug two inline connectors, and then remove the left cover.

Figure 6-647 Unplug two connectors



 **TIP:** Be sure to check the hook when reassembling.



### Remove the output tray top of stack sensor

Follow these steps to Remove the output tray top of stack sensor.

- ▲ Remove two screws from both sides of the left cover. Remove the bracket, and then remove the sensor.

Figure 6-648 Remove the output tray top of stack sensor



### Unpack the replacement assembly



Follow these steps to unpack the replacement assembly.


1. Dispose of the defective part.


 **NOTE:** HP recommends responsible disposal of the defective part.

<http://www8.hp.com/us/en/hp-information/environment/product-recycling.html>


2. Unpack the replacement part from the packaging.

 **CAUTION:**  Some parts are sensitive to electrostatic discharge (ESD). Always perform service work at an ESD-protected workstation or mat. If an ESD workstation or mat is not available, touch the sheet-metal chassis to provide a static ground before touching an ESD-sensitive assembly. Protect the ESD-sensitive assemblies by placing them in ESD pouches when they are out of the printer.

 **IMPORTANT:** Make sure that all of the shipping materials (for example shipping tape) are removed from the replacement part prior to installation.

 **NOTE:** If the replacement part is a roller or pad, avoid touching the spongy part of it. Skin oils on the roller or pad can cause paper pickup and/or print-quality problems. HP recommends using disposable gloves when handling rollers or pads or washing your hands before touching rollers or pads.

3. To install an assembly, reverse the removal steps.

 **NOTE:** When applicable, special installation instructions are provided for an assembly at the end of the removal procedure. Always completely read the removal instructions and follow all special installation instructions.

## Removal and replacement: Output tray lower limit switch (S7)


Learn how to remove and replace the output tray lower limit switch.

To view teardown and reassembling video of the inner finisher, click the link below.

 [View a teardown video of the inner finisher.](#)

 [View a reassembling video of the inner finisher.](#)

---

 **IMPORTANT:** When applicable, special installation instructions are provided for an assembly at the end of the removal procedure. Always completely read the removal instructions and follow all special installation instructions.

---

Mean time to repair:


Service level:

### Before performing service

#### Turn the printer power off

- Press the power button on the front of the printer, and then turn off the power switch next to the power cable.
- A shutting-down message appears on the control-panel display.

---

 **WARNING!** To avoid damage to the printer, turn the power off and wait until the printer shuts down before removing the power cable.

---

- Disconnect the printer power cable after the printer has completely shut down (the control-panel display is blank).

Use the table below to identify the correct part number for your printer. To order the part, go to [www.hp.com/buy/parts](http://www.hp.com/buy/parts).

Table 6-68 Part information

Part number	Part description
JC90-01320A	Output tray lower limit switch

### Required tools

- #2 JIS screwdriver with a magnetic tip

### After performing service

#### Turn the printer power on

- Connect the power cable.
- Use the power switch to turn the power on.

### Post service test

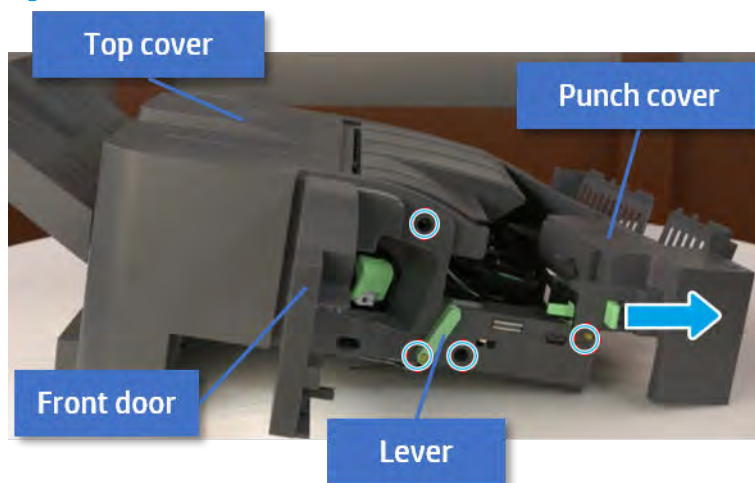
Print any pages necessary to verify that the repair resolved the issue and did not create any new issues.

## Remove the front cover

Follow these steps to remove the front cover:

1. Open the front door and open the punch cover.
2. Remove three screws in the front.
3. Remove the lever.
4. Open the top cover.
5. From the right side of the front cover, carefully lift and pry toward the top-left corner to remove the front cover.

Figure 6-649 Remove the front cover

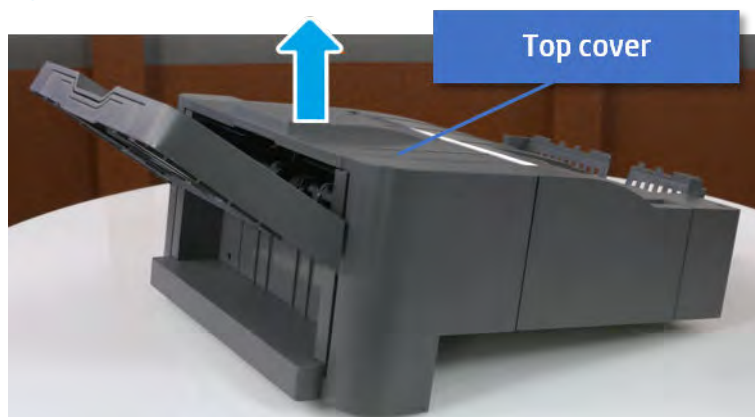


## Remove the rear cover

Follow these steps to remove the rear cover:

1. Open the top cover.

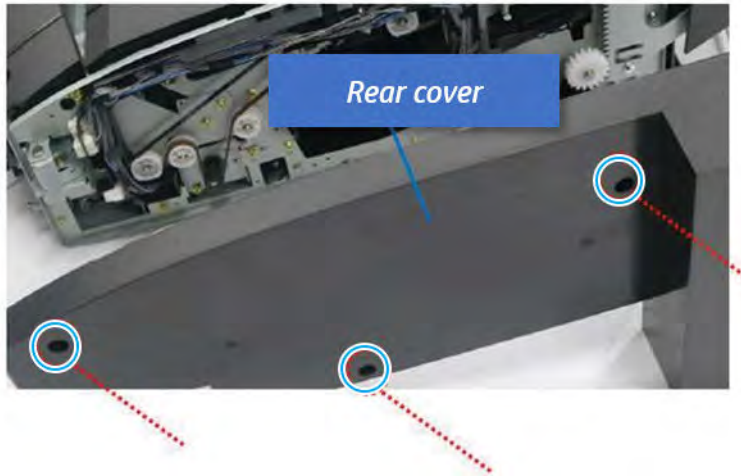
Figure 6-650 Open the top cover



2. Remove three screws.

3. Release hooks carefully and remove the rear cover.

**Figure 6-651** Remove the rear cover

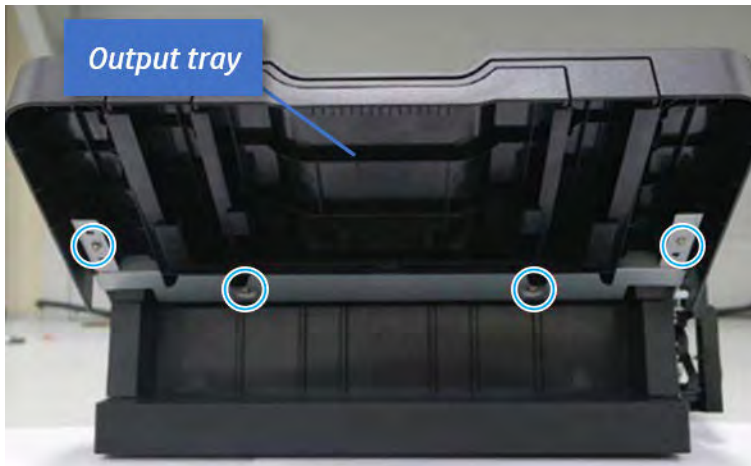


### Remove the output tray

Follow these steps to remove the output tray.

1. Remove four screws.

**Figure 6-652** Remove four screws





2. Push the paper holding actuator into the inner finisher, and then remove the output tray.

Figure 6-653 Remove the output tray.

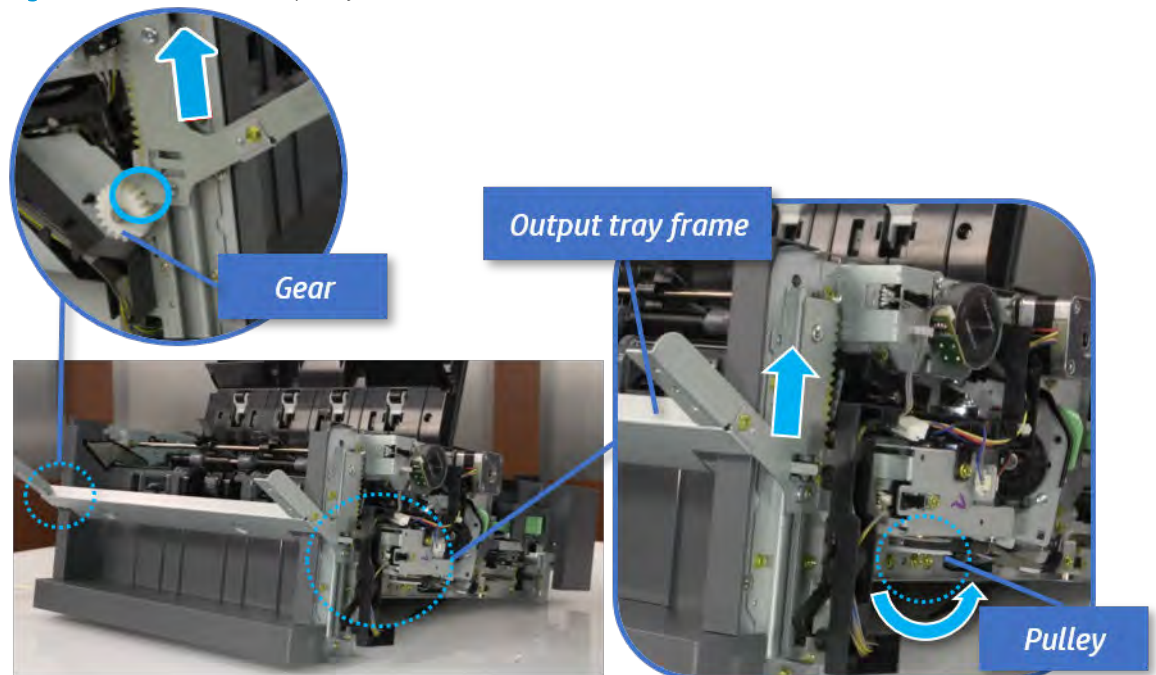


### Remove the output tray frame

Follow these steps to remove the output tray frame.

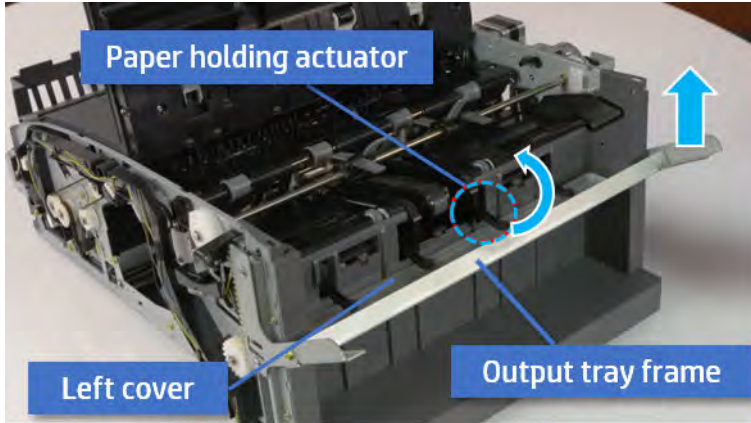
1. Rotate the pulley until the output tray frame depart from the gear.

Figure 6-654 Remove the pulley



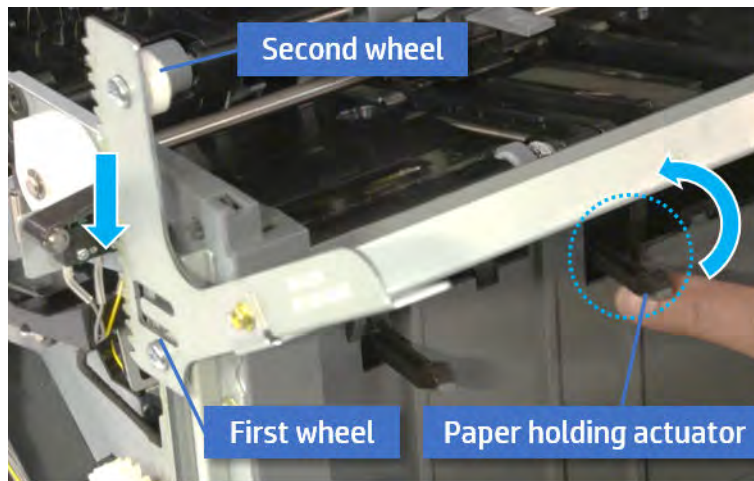
2. Push the paper holding actuator into the inner finisher, and then remove the output tray frame.

Figure 6-655 Remove the output tray frame

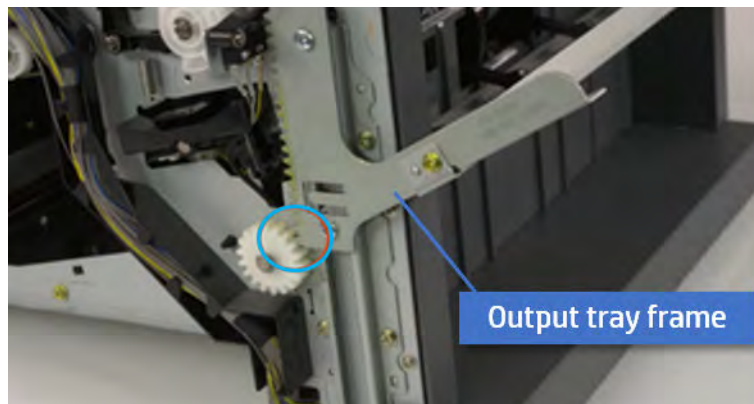


**TIP:** Push the paper holding actuator into the inner finisher when reassembling. Be sure to level the output tray.

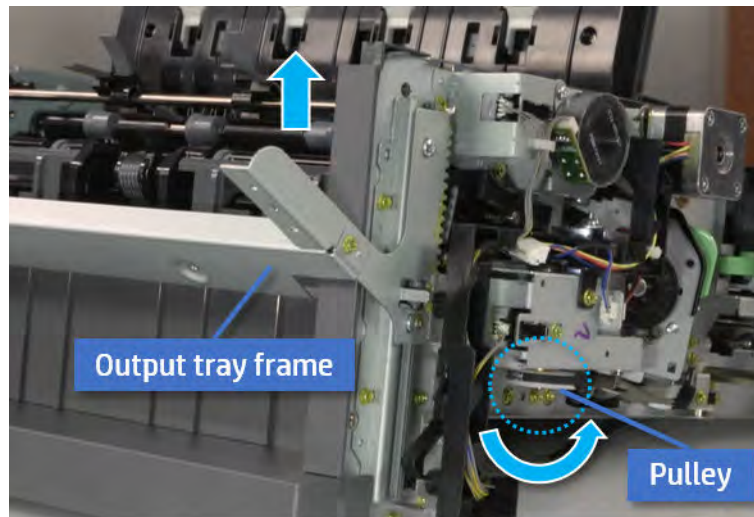
- a. Position the first wheel into the channel on both sides while pushing the paper holding actuator.



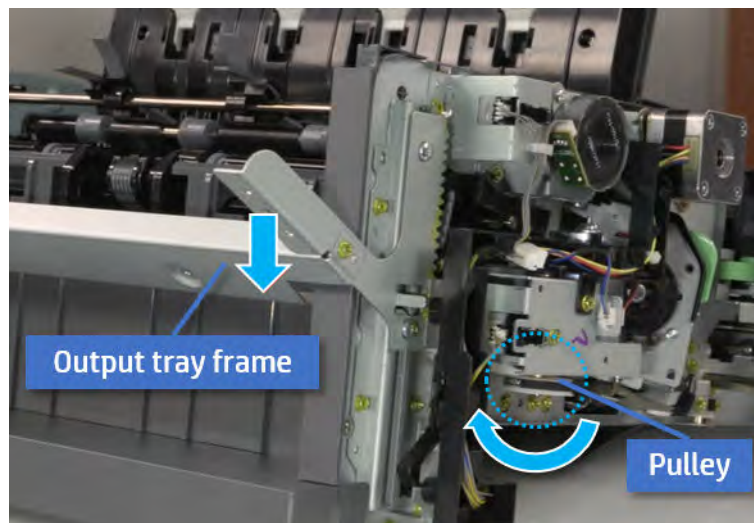
- b. Let the second wheel rest on the channel on both sides simultaneously.
- c. Gently squeeze the wheels into channel until the output tray frame meet the gear.



- d. Rotate the pulley until the output tray frame is no longer lifted. It can make to level the output tray frame.



- e. Rotate the pulley in the opposite direction.

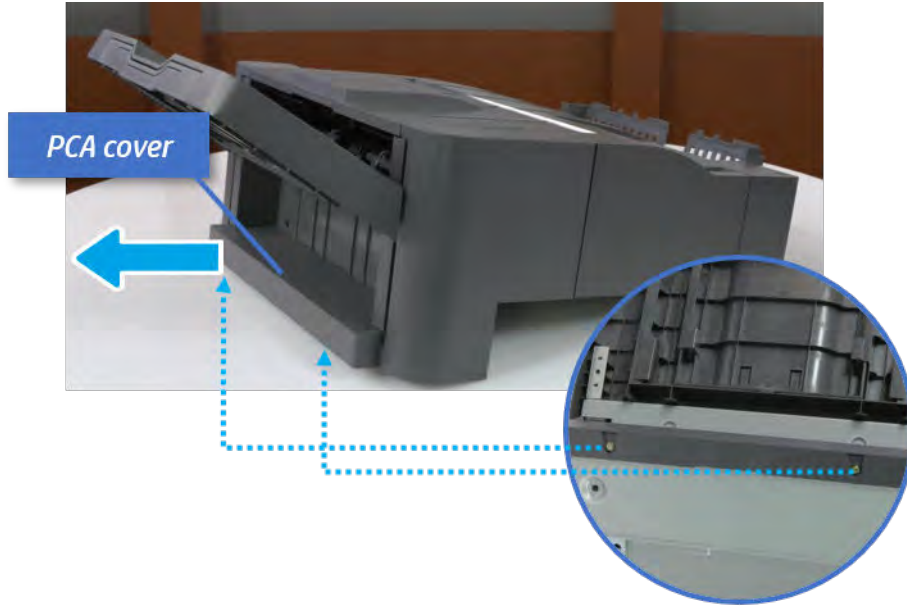


### Remove the PCA cover

Follow these steps to remove the PCA cover.

- ▲ Remove two screws, and then remove the PCA cover.

Figure 6-656 Remove the PCA cover

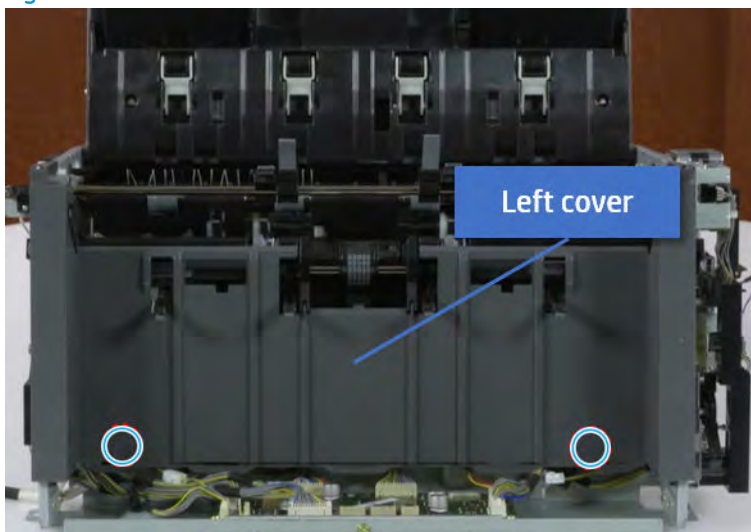


### Remove the left cover

Follow these steps to remove the left cover.

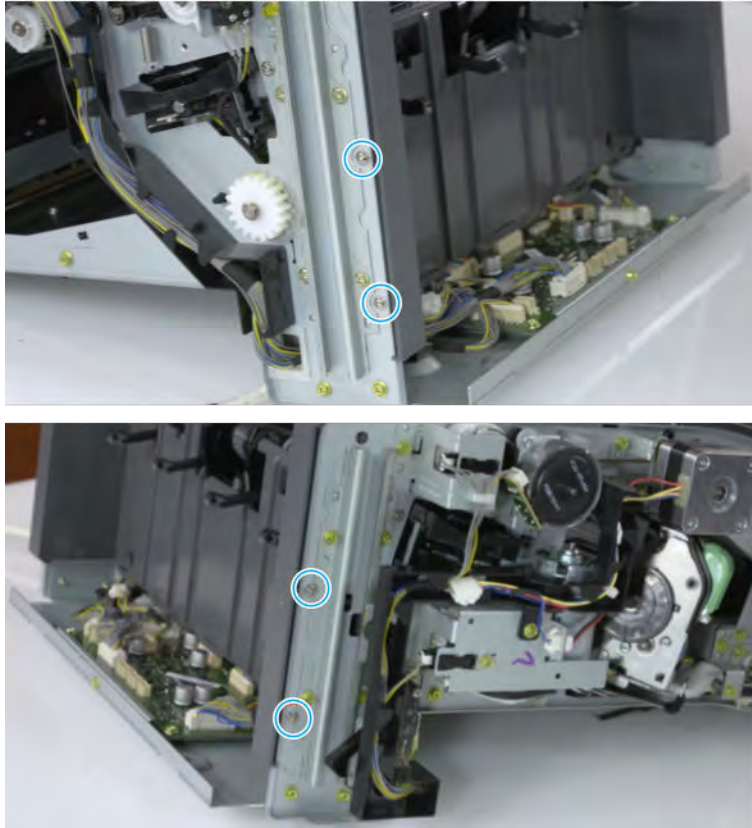
1. Remove two screws.

Figure 6-657 Remove two screws



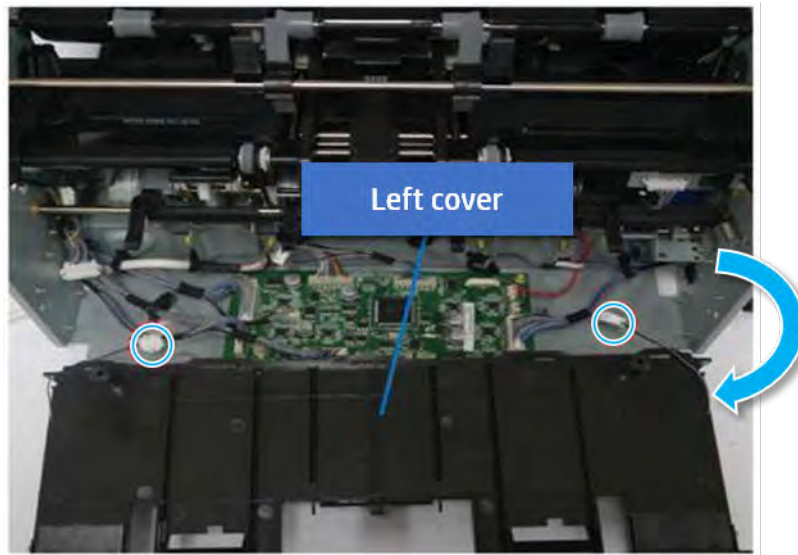
2. Remove four screws from both front and rear sides.


Figure 6-658 Remove four screws

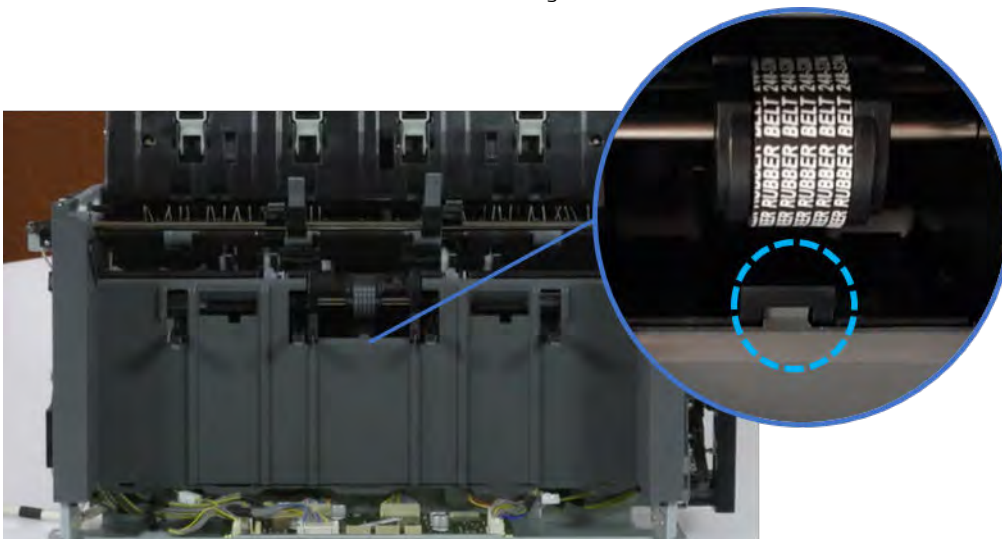


3. Unplug two inline connectors, and then remove the left cover.

Figure 6-659 Unplug two connectors



 **TIP:** Be sure to check the hook when reassembling.



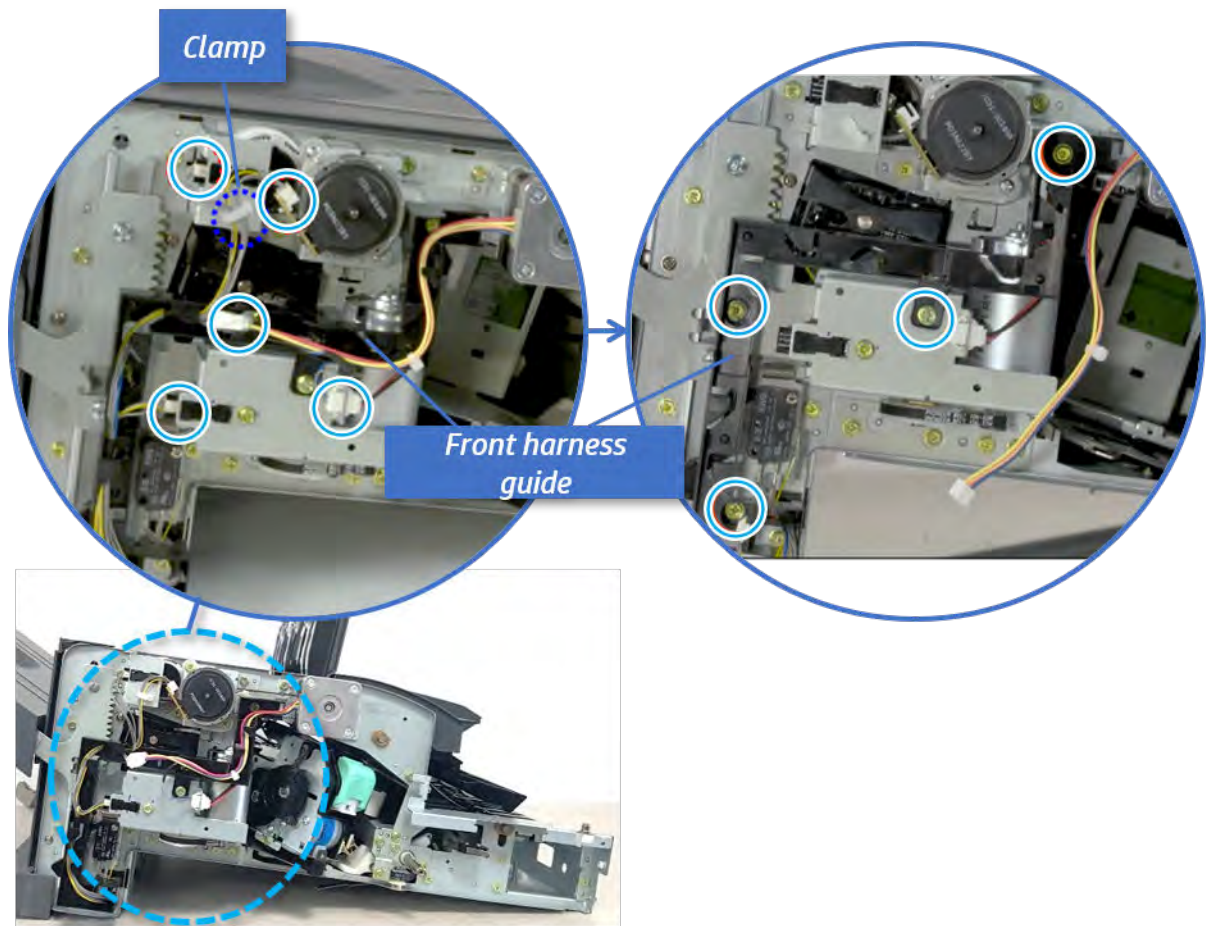
### Remove the front harness guide

Follow these steps to remove the front harness guide.

1. Open one clamp and unplug five connectors, and then remove the wire harness from the front harness guide.

2. Remove four screws, and then remove the front harness guide.

Figure 6-660 Remove the front harness guide

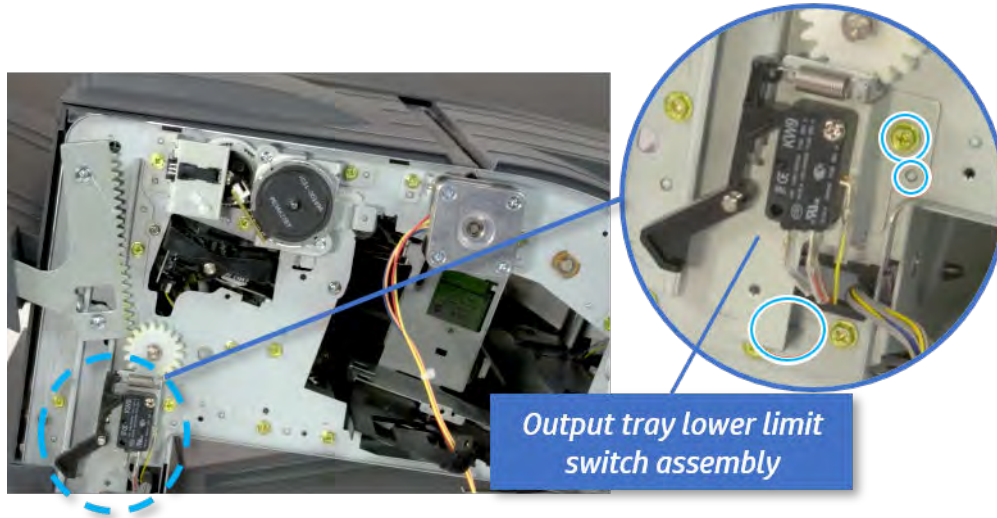


### Remove the output tray lower limit switch

Follow these steps to remove the output tray lower limit switch.

- ▲ Remove one screw, and then remove the output tray lower limit switch.


Figure 6-661 Remove the output tray lower limit switch



### Unpack the replacement assembly



Follow these steps to unpack the replacement assembly.


1. Dispose of the defective part.


 **NOTE:** HP recommends responsible disposal of the defective part.

<http://www8.hp.com/us/en/hp-information/environment/product-recycling.html>


2. Unpack the replacement part from the packaging.

 **CAUTION:**  Some parts are sensitive to electrostatic discharge (ESD). Always perform service work at an ESD-protected workstation or mat. If an ESD workstation or mat is not available, touch the sheet-metal chassis to provide a static ground before touching an ESD-sensitive assembly. Protect the ESD-sensitive assemblies by placing them in ESD pouches when they are out of the printer.

 **IMPORTANT:** Make sure that all of the shipping materials (for example shipping tape) are removed from the replacement part prior to installation.

 **NOTE:** If the replacement part is a roller or pad, avoid touching the spongy part of it. Skin oils on the roller or pad can cause paper pickup and/or print-quality problems. HP recommends using disposable gloves when handling rollers or pads or washing your hands before touching rollers or pads.

3. To install an assembly, reverse the removal steps.

 **NOTE:** When applicable, special installation instructions are provided for an assembly at the end of the removal procedure. Always completely read the removal instructions and follow all special installation instructions.



## Output tray motor assembly

## Removal and replacement: Output tray motor assembly (M4)


Learn how to remove and replace the output tray motor assembly.

To view teardown and reassembling video of the inner finisher, click the link below.

 [View a teardown video of the inner finisher.](#)

 [View a reassembling video of the inner finisher.](#)

---

 **IMPORTANT:** When applicable, special installation instructions are provided for an assembly at the end of the removal procedure. Always completely read the removal instructions and follow all special installation instructions.

---

Mean time to repair:


Service level:

### Before performing service

#### Turn the printer power off

- Press the power button on the front of the printer, and then turn off the power switch next to the power cable.
- A shutting-down message appears on the control-panel display.

---

 **WARNING!** To avoid damage to the printer, turn the power off and wait until the printer shuts down before removing the power cable.

---

- Disconnect the printer power cable after the printer has completely shut down (the control-panel display is blank).

Use the table below to identify the correct part number for your printer. To order the part, go to <http://www.hp.com/buy/parts>.

**Table 6-69** Part information

Part number	Part description
JC90-01334B	Output tray motor assembly

### Required tools

- #2 JIS screwdriver with a magnetic tip

### After performing service

#### Turn the printer power on

- Connect the power cable.
- Use the power switch to turn the power on.

### Post service test

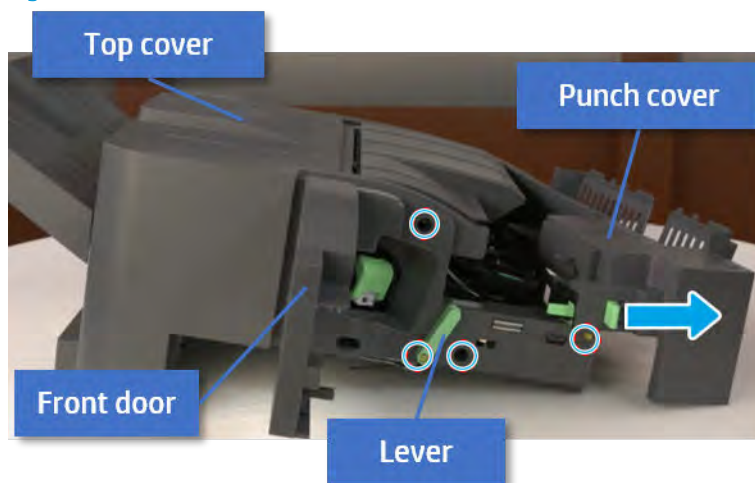
Print any pages necessary to verify that the repair resolved the issue and did not create any new issues.

## Remove the front cover

Follow these steps to remove the front cover:

1. Open the front door and open the punch cover.
2. Remove three screws in the front.
3. Remove the lever.
4. Open the top cover.
5. From the right side of the front cover, carefully lift and pry toward the top-left corner to remove the front cover.

Figure 6-662 Remove the front cover

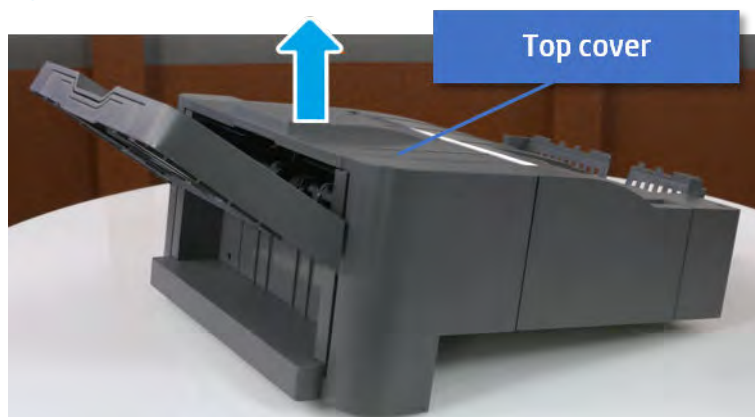


## Remove the rear cover

Follow these steps to remove the rear cover:

1. Open the top cover.

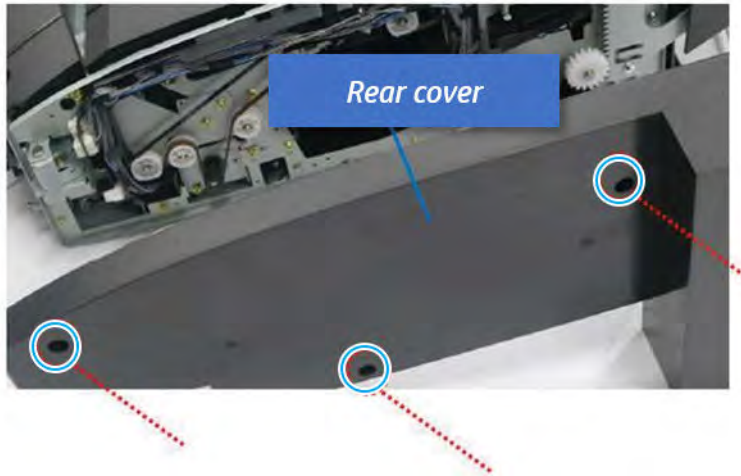
Figure 6-663 Open the top cover



2. Remove three screws.

3. Release hooks carefully and remove the rear cover.

Figure 6-664 Remove the rear cover

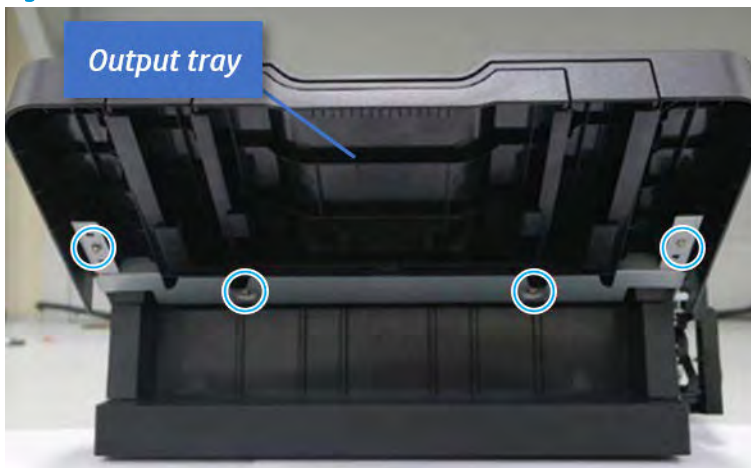


### Remove the output tray

Follow these steps to remove the output tray.

1. Remove four screws.

Figure 6-665 Remove four screws



2. Push the paper holding actuator into the inner finisher, and then remove the output tray.

Figure 6-666 Remove the output tray.

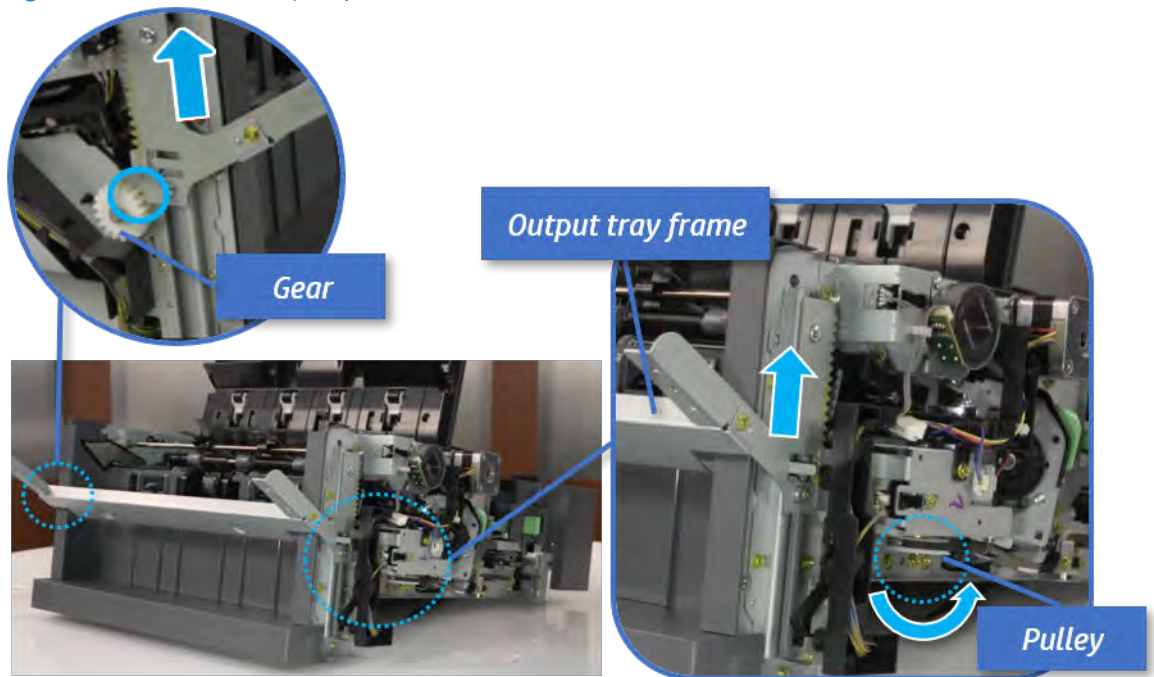


### Remove the output tray frame

Follow these steps to remove the output tray frame.

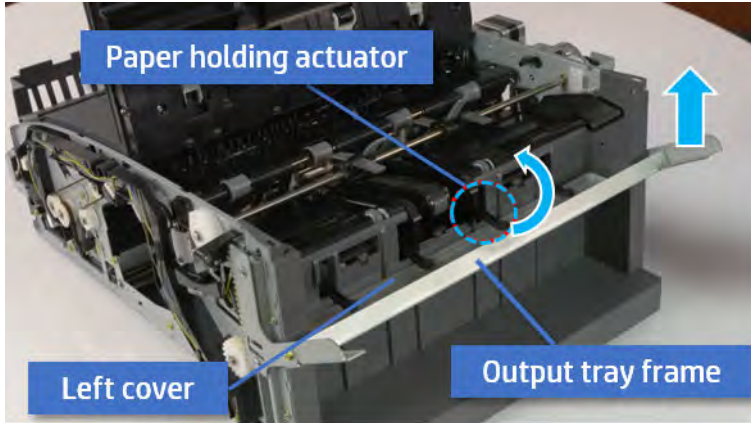
1. Rotate the pulley until the output tray frame depart from the gear.

Figure 6-667 Remove the pulley



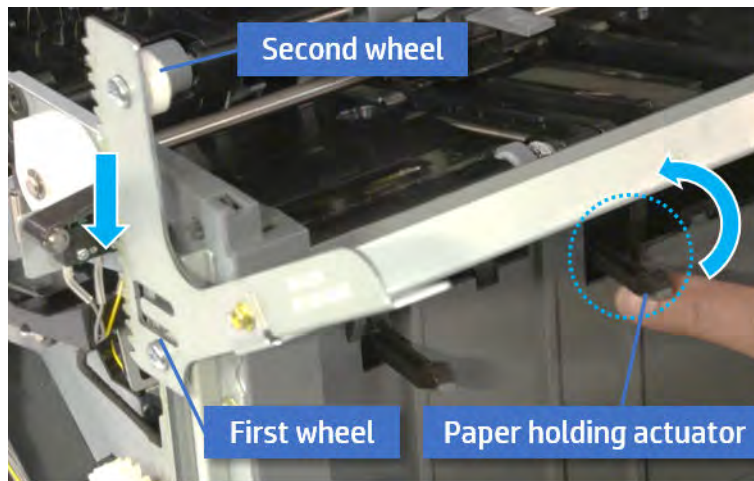
2. Push the paper holding actuator into the inner finisher, and then remove the output tray frame.

Figure 6-668 Remove the output tray frame

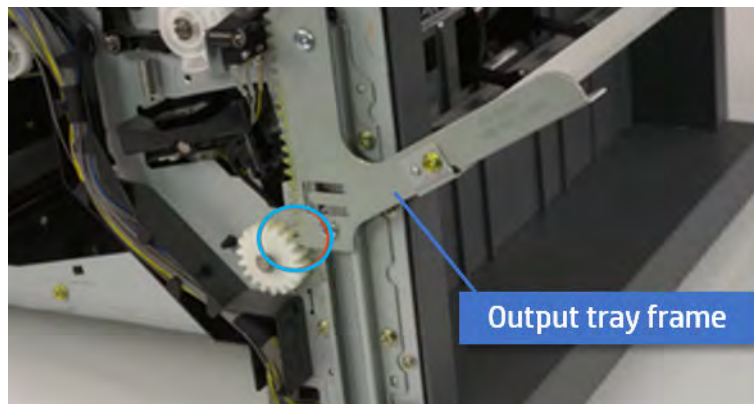


**TIP:** Push the paper holding actuator into the inner finisher when reassembling. Be sure to level the output tray.

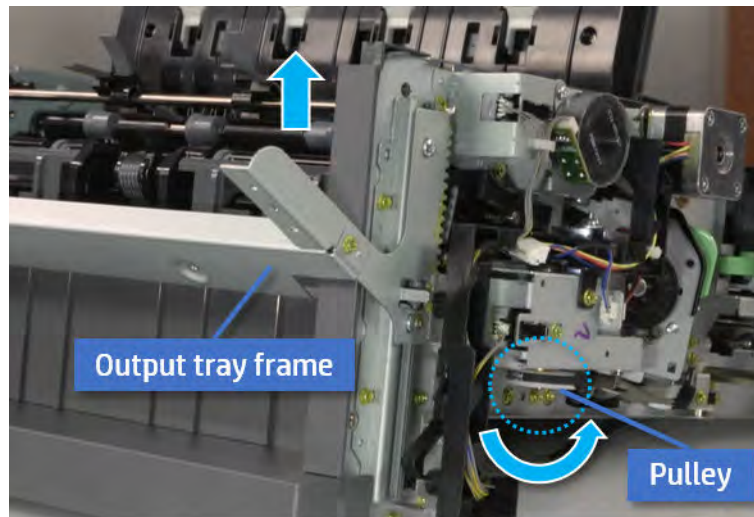
- a. Position the first wheel into the channel on both sides while pushing the paper holding actuator.



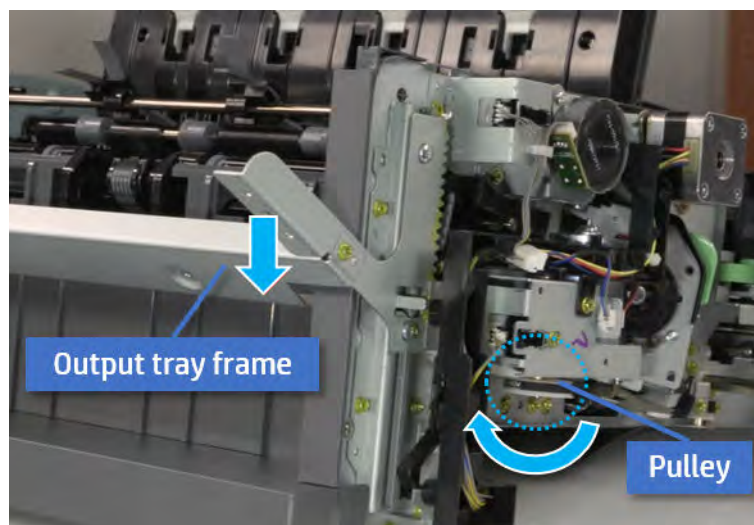
- b. Let the second wheel rest on the channel on both sides simultaneously.
- c. Gently squeeze the wheels into channel until the output tray frame meet the gear.



- d. Rotate the pulley until the output tray frame is no longer lifted. It can make to level the output tray frame.



- e. Rotate the pulley in the opposite direction.

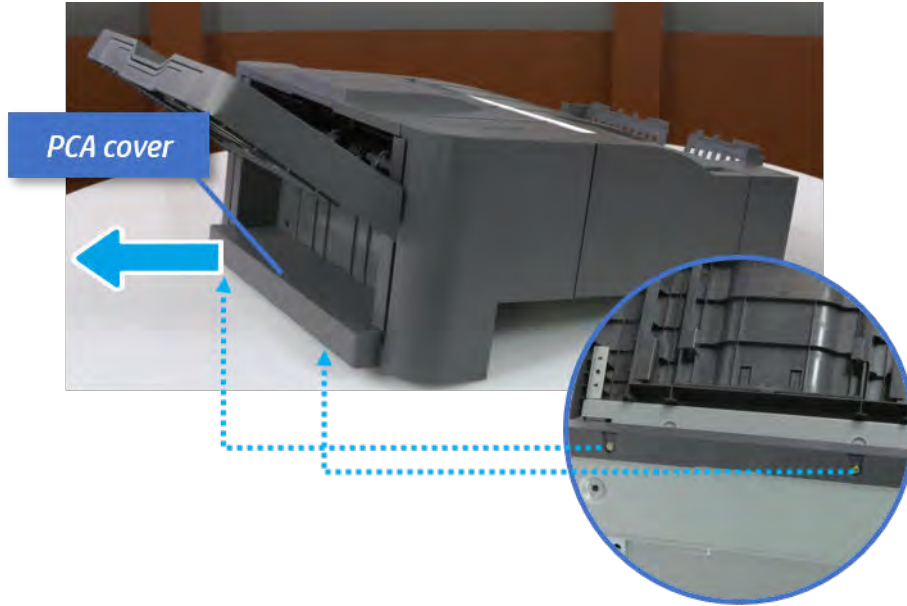


### Remove the PCA cover

Follow these steps to remove the PCA cover.

- ▲ Remove two screws, and then remove the PCA cover.

Figure 6-669 Remove the PCA cover

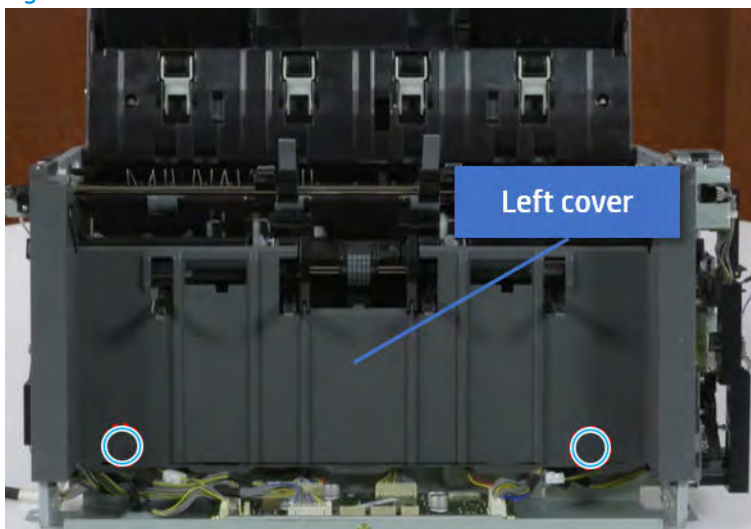


### Remove the left cover

Follow these steps to remove the left cover.

1. Remove two screws.

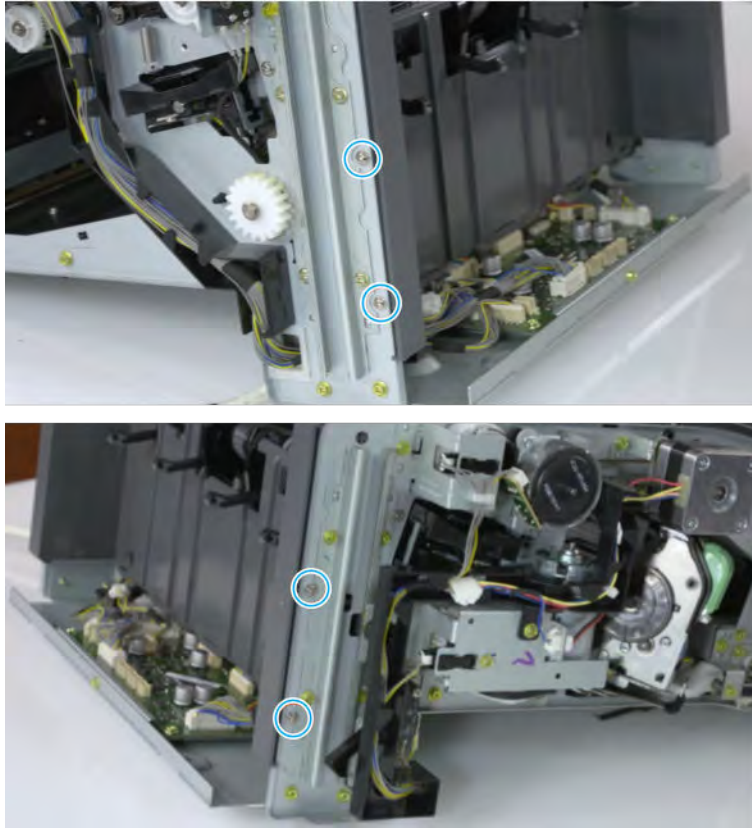
Figure 6-670 Remove two screws





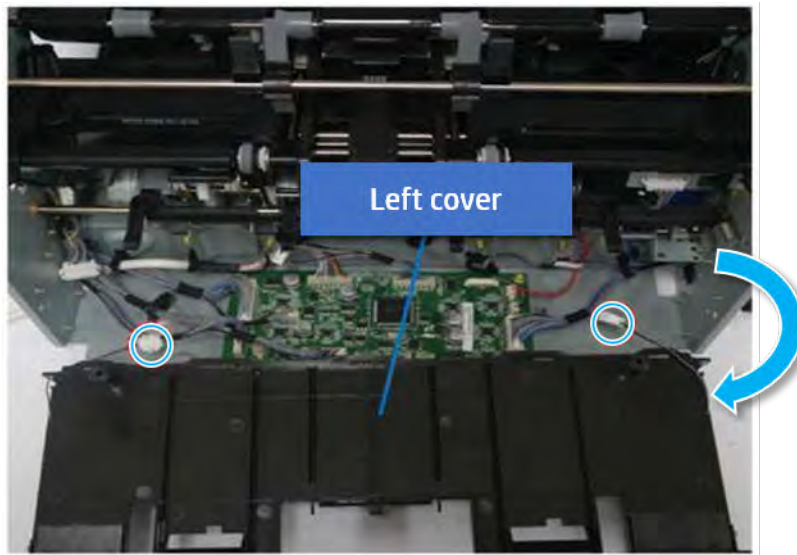
2. Remove four screws from both front and rear sides.


Figure 6-671 Remove four screws

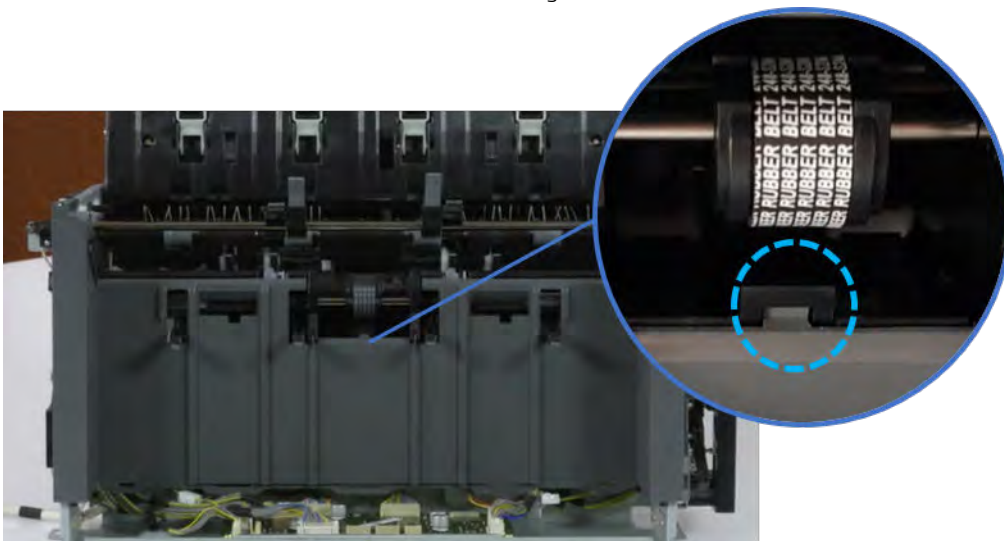


3. Unplug two inline connectors, and then remove the left cover.

Figure 6-672 Unplug two connectors



 **TIP:** Be sure to check the hook when reassembling.



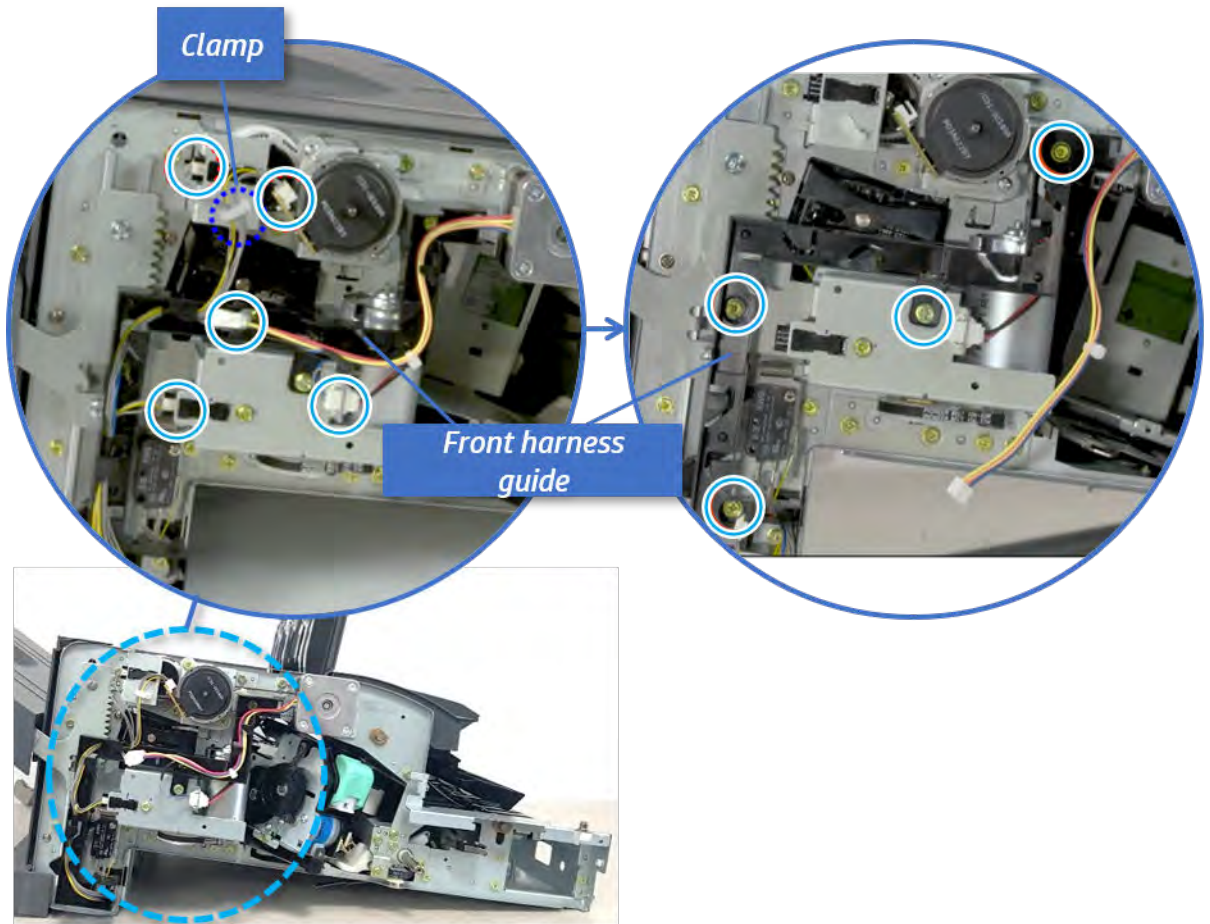
### Remove the front harness guide

Follow these steps to remove the front harness guide.

1. Open one clamp and unplug five connectors, and then remove the wire harness from the front harness guide.

2. Remove four screws, and then remove the front harness guide.

Figure 6-673 Remove the front harness guide

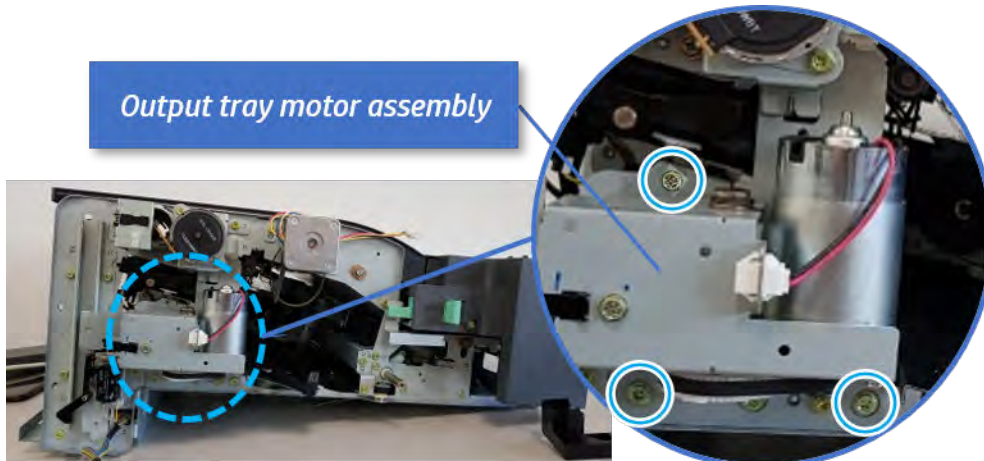


### Remove the output tray motor assembly

Follow these steps to remove the output tray motor assembly.

- ▲ Remove three screws, and then remove the output tray motor assembly.

Figure 6-674 Remove the output tray motor assembly



## Unpack the replacement assembly

Follow these steps to unpack the replacement assembly.

1. Dispose of the defective part.

---



 **NOTE:** HP recommends responsible disposal of the defective part.

<http://www8.hp.com/us/en/hp-information/environment/product-recycling.html>


---

2. Unpack the replacement part from the packaging.

---

 **CAUTION:**  Some parts are sensitive to electrostatic discharge (ESD). Always perform service work at an ESD-protected workstation or mat. If an ESD workstation or mat is not available, touch the sheet-metal chassis to provide a static ground before touching an ESD-sensitive assembly. Protect the ESD-sensitive assemblies by placing them in ESD pouches when they are out of the printer.


 **IMPORTANT:** Make sure that all of the shipping materials (for example shipping tape) are removed from the replacement part prior to installation.

 **NOTE:** If the replacement part is a roller or pad, avoid touching the spongy part of it. Skin oils on the roller or pad can cause paper pickup and/or print-quality problems. HP recommends using disposable gloves when handling rollers or pads or washing your hands before touching rollers or pads.

---

3. To install an assembly, reverse the removal steps.

---

 **NOTE:** When applicable, special installation instructions are provided for an assembly at the end of the removal procedure. Always completely read the removal instructions and follow all special installation instructions.

---


## Removal and replacement: Output tray motor sensor (S6)

Learn how to remove and replace the output tray motor sensor.

To view teardown and reassembling video of the inner finisher, click the link below.

 [View a teardown video of the inner finisher.](#)

 [View a reassembling video of the inner finisher.](#)

 **IMPORTANT:** When applicable, special installation instructions are provided for an assembly at the end of the removal procedure. Always completely read the removal instructions and follow all special installation instructions.


Mean time to repair:

Service level:

### Before performing service

#### Turn the printer power off

- Press the power button on the front of the printer, and then turn off the power switch next to the power cable.
- A shutting-down message appears on the control-panel display.

 **WARNING!** To avoid damage to the printer, turn the power off and wait until the printer shuts down before removing the power cable.

- Disconnect the printer power cable after the printer has completely shut down (the control-panel display is blank).

Use the table below to identify the correct part number for your printer. To order the part, go to <http://www.hp.com/buy/parts>.

**Table 6-70 Part information**

Part number	Part description
0604-001393	Output tray motor sensor

### Required tools

- #2 JIS screwdriver with a magnetic tip

### After performing service

#### Turn the printer power on

- Connect the power cable.
- Use the power switch to turn the power on.

### Post service test

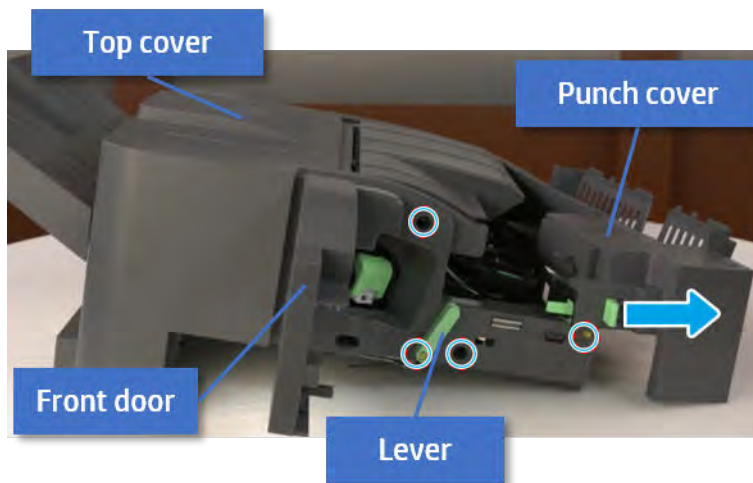
Print any pages necessary to verify that the repair resolved the issue and did not create any new issues.

## Remove the front cover

Follow these steps to remove the front cover.

1. Open the front door and open the punch cover.
2. Remove three screws in the front.
3. Remove the lever.
4. Open the top cover.
5. From the right side of the front cover, carefully lift and pry toward the top-left corner to remove the front cover.

Figure 6-675 Remove the front cover

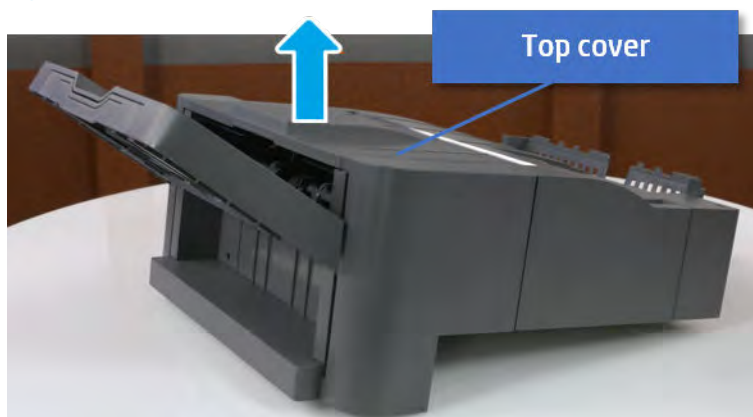


## Remove the rear cover

Follow these steps to remove the rear cover.

1. Open the top cover.

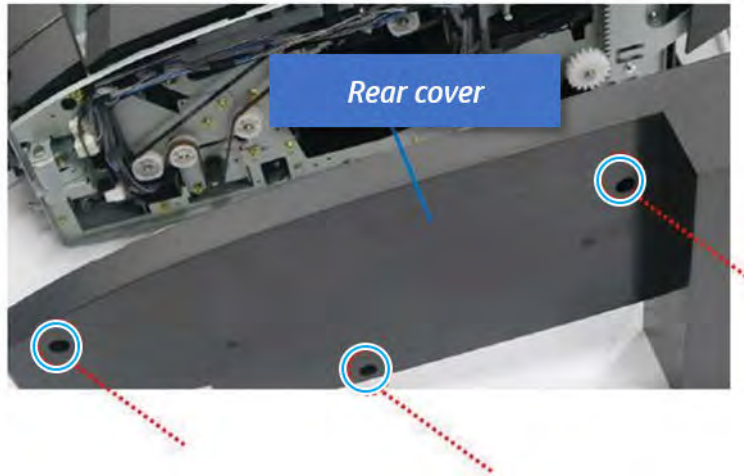
Figure 6-676 Open the top cover



2. Remove three screws.

3. Release hooks carefully and remove the rear cover.

Figure 6-677 Remove the rear cover

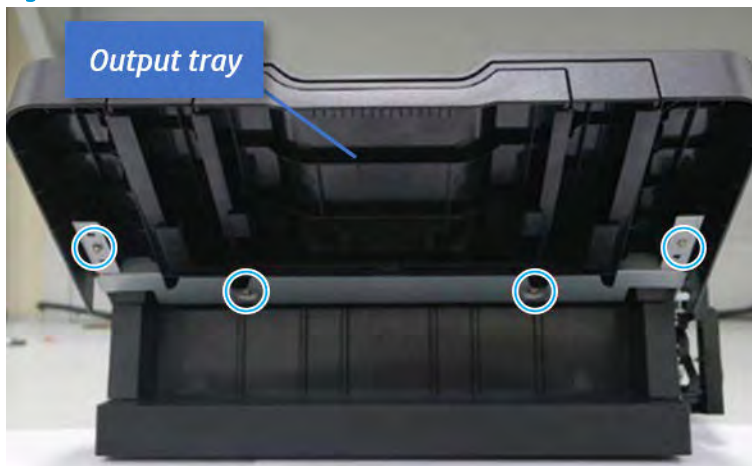


### Remove the output tray

Follow these steps to remove the output tray.

1. Remove four screws.

Figure 6-678 Remove four screws



2. Push the paper holding actuator into the inner finisher, and then remove the output tray.

Figure 6-679 Remove the output tray.

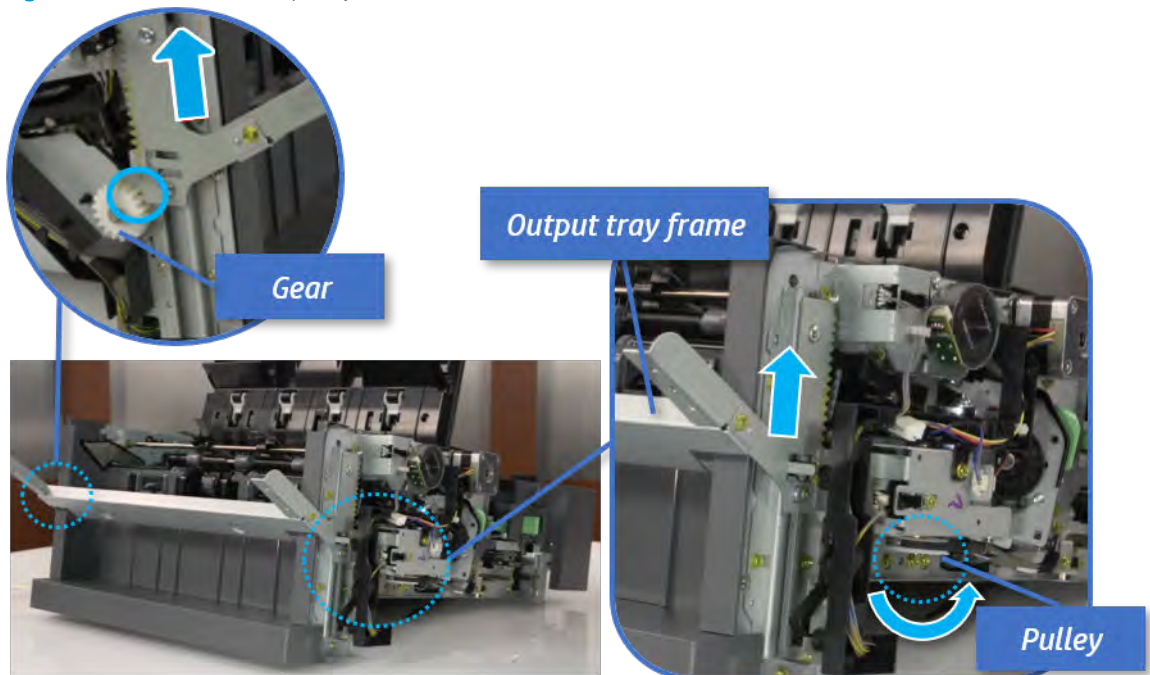


### Remove the output tray frame

Follow these steps to remove the output tray frame.

1. Rotate the pulley until the output tray frame depart from the gear.

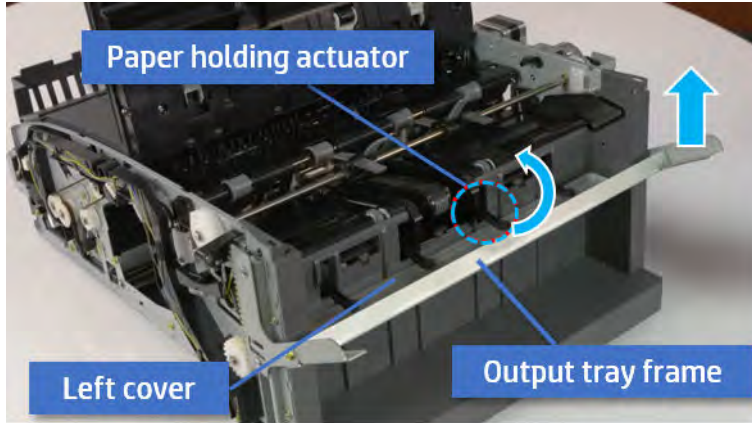
Figure 6-680 Remove the pulley



2. Push the paper holding actuator into the inner finisher, and then remove the output tray frame.

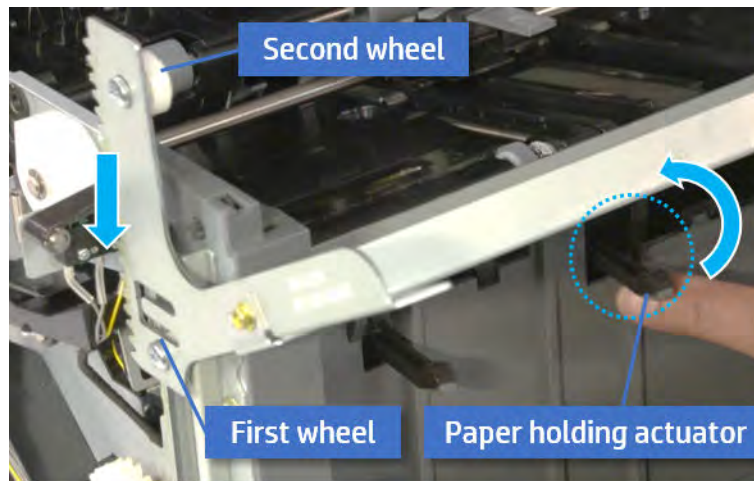


Figure 6-681 Remove the output tray frame

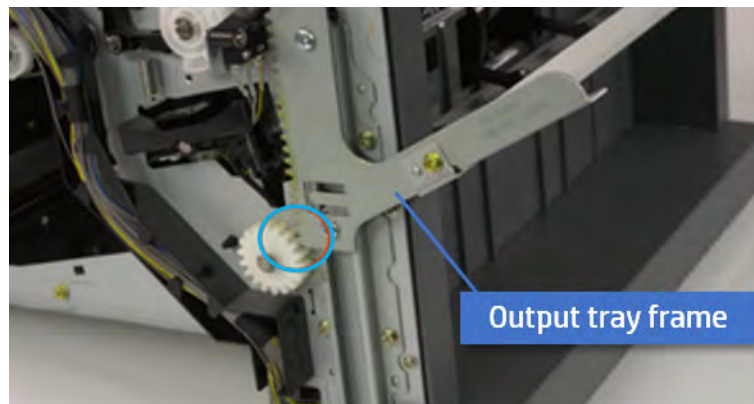


**TIP:** Push the paper holding actuator into the inner finisher when reassembling. Be sure to level the output tray.

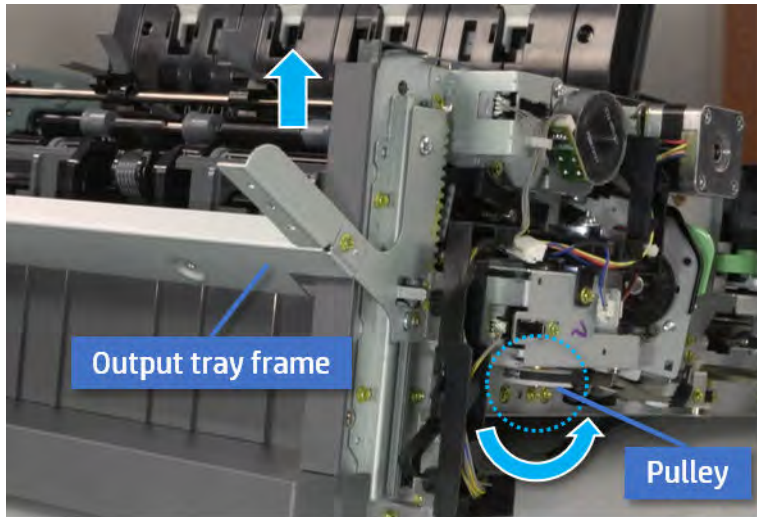
- a. Position the first wheel into the channel on both sides while pushing the paper holding actuator.



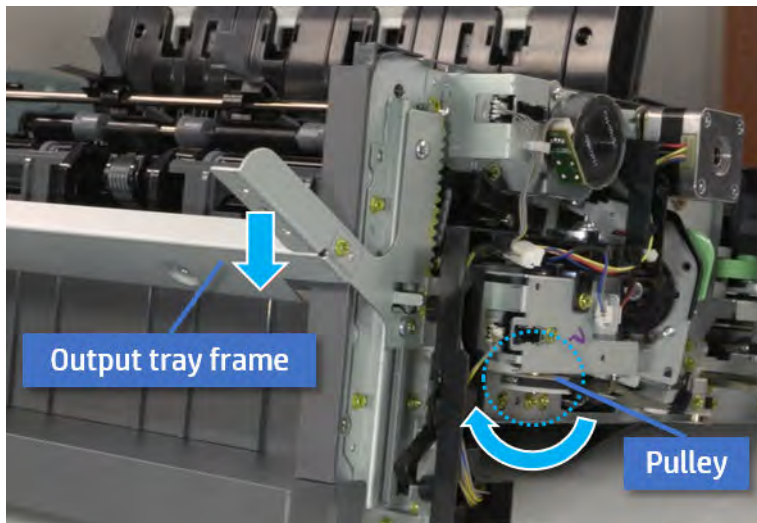
- b. Let the second wheel rest on the channel on both sides simultaneously.
- c. Gently squeeze the wheels into channel until the output tray frame meet the gear.



- d. Rotate the pulley until the output tray frame is no longer lifted. It can make to level the output tray frame.



- e. Rotate the pulley in the opposite direction.

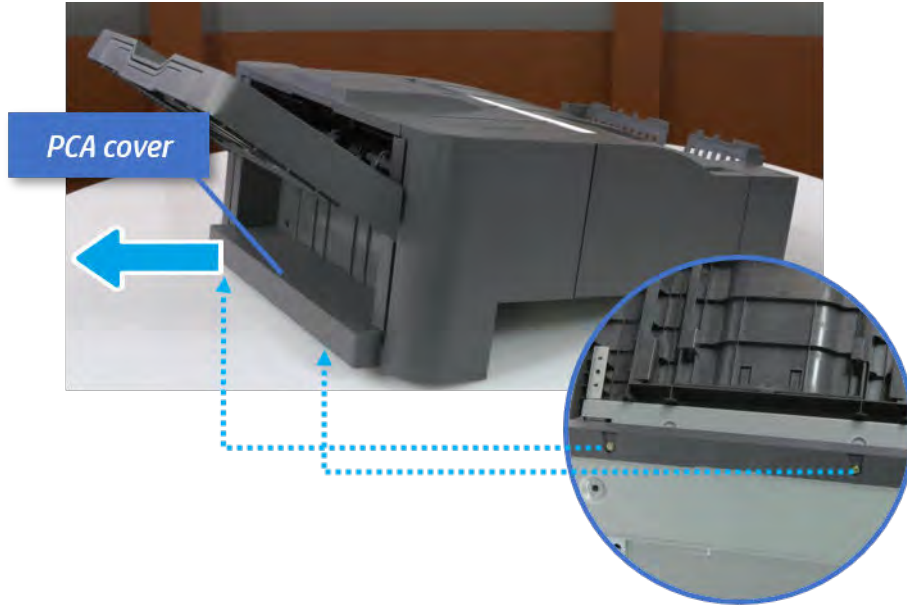


### Remove the PCA cover

Follow these steps to remove the PCA cover.

- ▲ Remove two screws, and then remove the PCA cover.

Figure 6-682 Remove the PCA cover

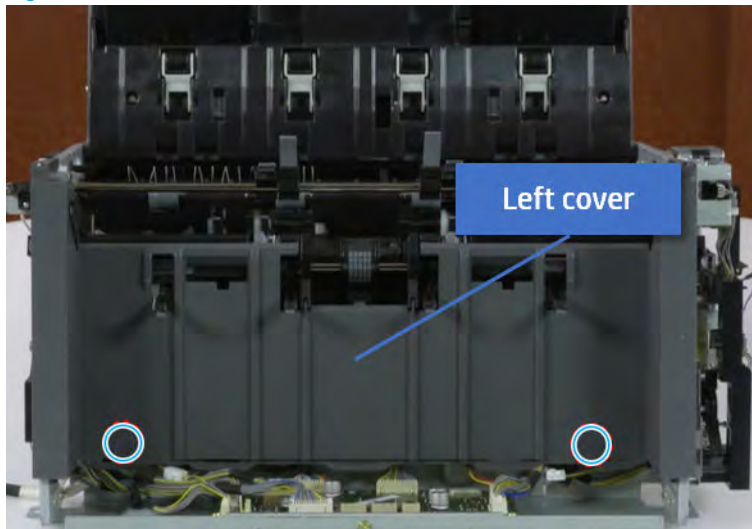


### Remove the left cover

Follow these steps to remove the left cover.

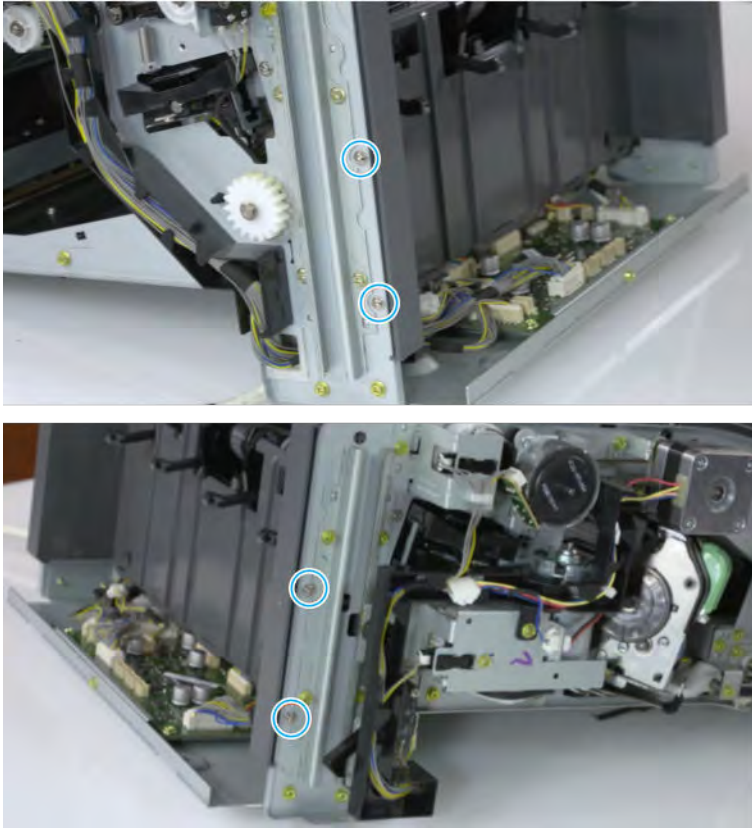
1. Remove two screws.

Figure 6-683 Remove two screws



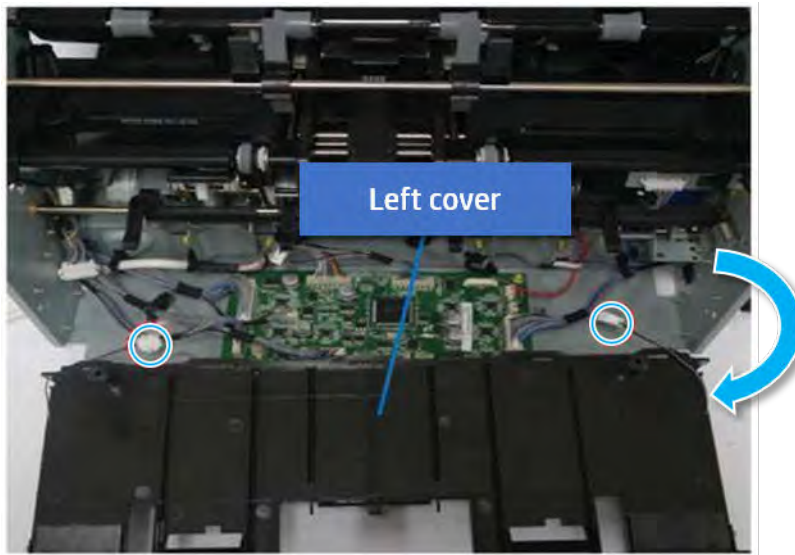
2. Remove four screws from both front and rear sides.


Figure 6-684 Remove four screws

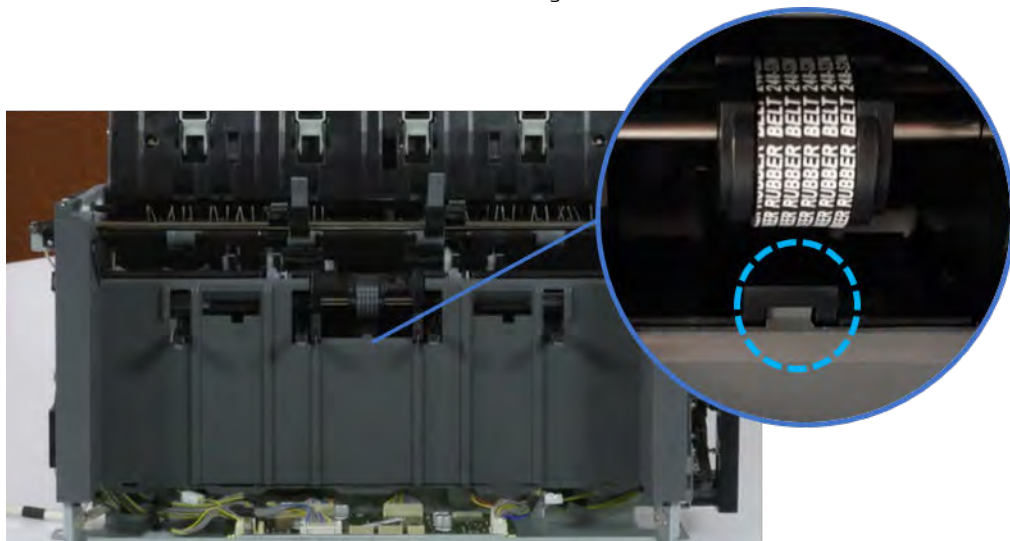


3. Unplug two inline connectors, and then remove the left cover.

Figure 6-685 Unplug two connectors



 **TIP:** Be sure to check the hook when reassembling.



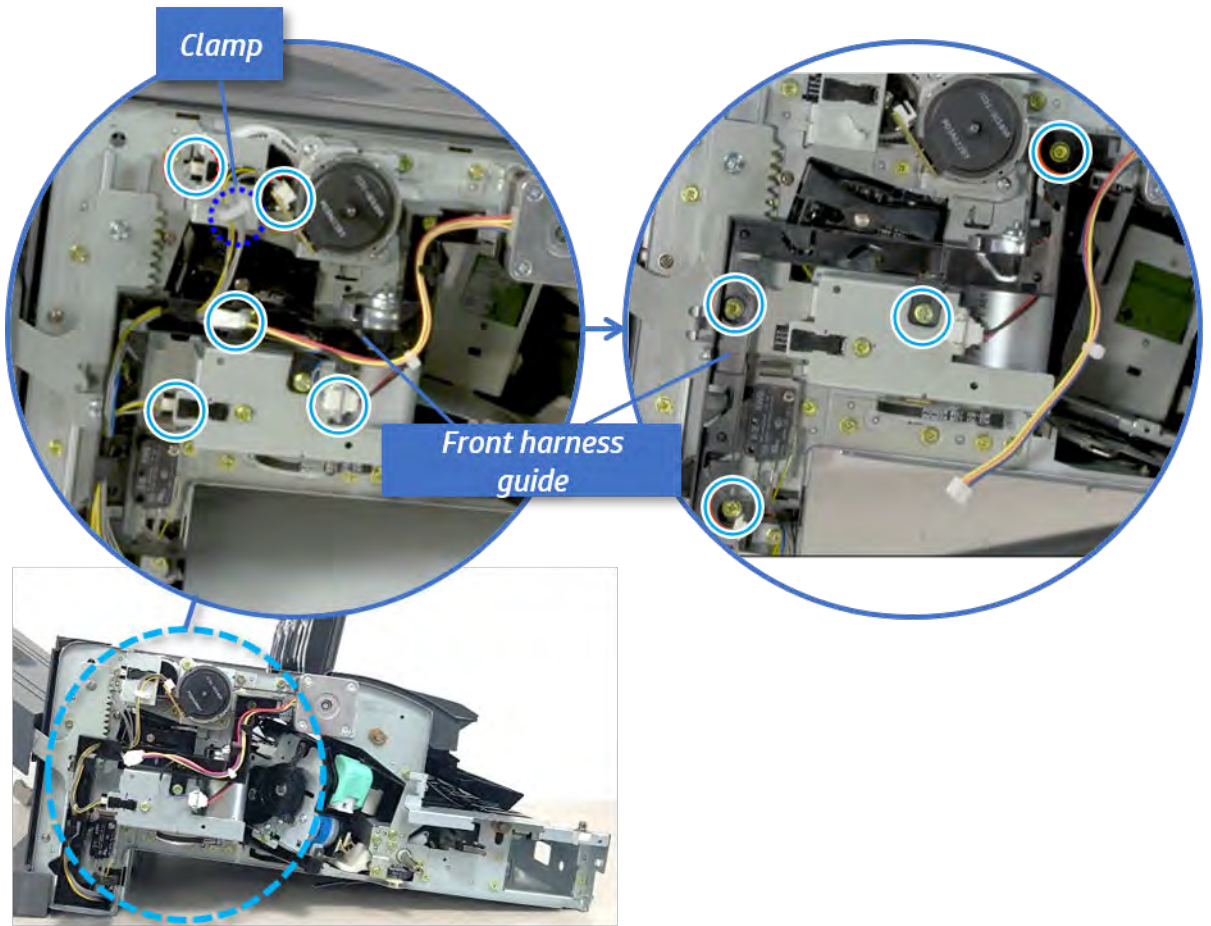
### Remove the front harness guide

Follow these steps to remove the front harness guide.

1. Open one clamp and unplug five connectors, and then remove the wire harness from the front harness guide.

2. Remove four screws, and then remove the front harness guide.

Figure 6-686 Remove the front harness guide

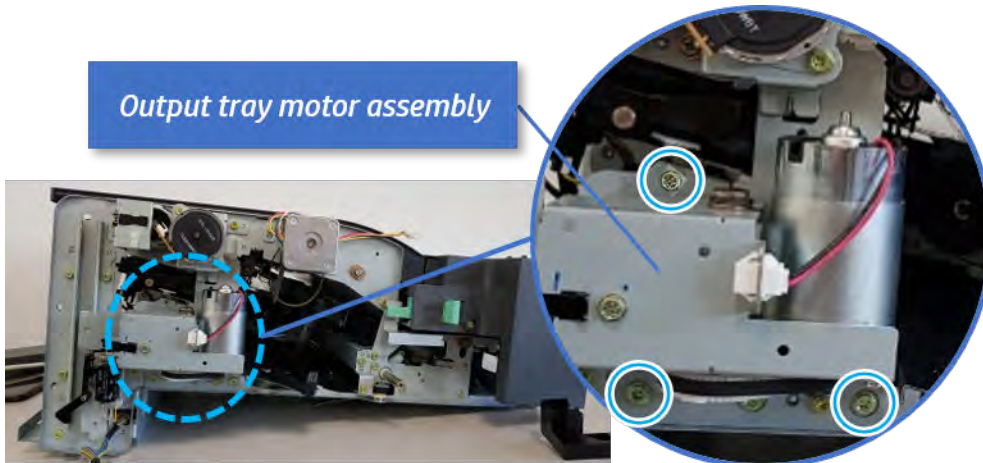


### Remove the output tray motor assembly

Follow these steps to remove the output tray motor assembly.

- ▲ Remove three screws, and then remove the output tray motor assembly.

Figure 6-687 Remove the output tray motor assembly

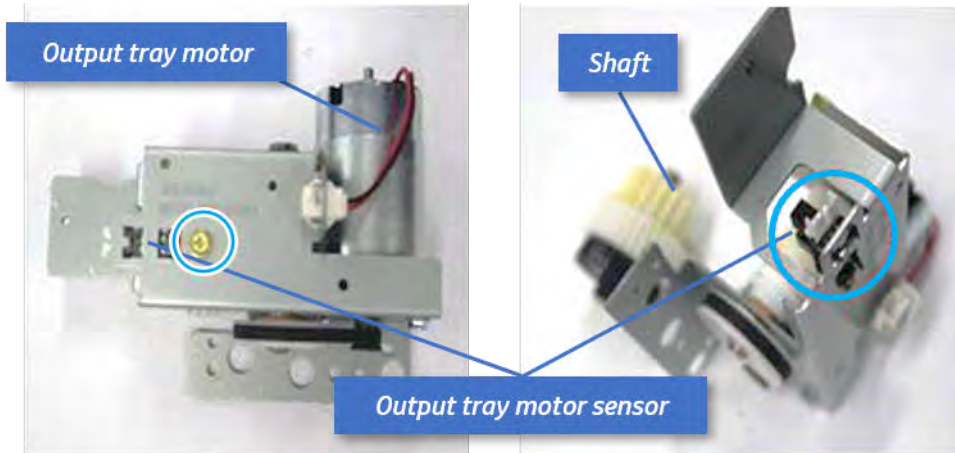


## Remove the output tray motor sensor

Follow these steps to remove the output tray motor sensor.

- ▲ Remove one screw, remove the shaft, and then remove the sensor.

Figure 6-688 Remove the output tray motor sensor



## Unpack the replacement assembly



Follow these steps to unpack the replacement assembly.


1. Dispose of the defective part.


 **NOTE:** HP recommends responsible disposal of the defective part.

<http://www8.hp.com/us/en/hp-information/environment/product-recycling.html>


2. Unpack the replacement part from the packaging.

 **CAUTION:**  Some parts are sensitive to electrostatic discharge (ESD). Always perform service work at an ESD-protected workstation or mat. If an ESD workstation or mat is not available, touch the sheet-metal chassis to provide a static ground before touching an ESD-sensitive assembly. Protect the ESD-sensitive assemblies by placing them in ESD pouches when they are out of the printer.

 **IMPORTANT:** Make sure that all of the shipping materials (for example shipping tape) are removed from the replacement part prior to installation.

 **NOTE:** If the replacement part is a roller or pad, avoid touching the spongy part of it. Skin oils on the roller or pad can cause paper pickup and/or print-quality problems. HP recommends using disposable gloves when handling rollers or pads or washing your hands before touching rollers or pads.

3. To install an assembly, reverse the removal steps.

 **NOTE:** When applicable, special installation instructions are provided for an assembly at the end of the removal procedure. Always completely read the removal instructions and follow all special installation instructions.


## Removal and replacement: Output tray motor

Learn how to remove and replace the output tray motor.

To view teardown and reassembling video of the inner finisher, click the link below.

 [View a teardown video of the inner finisher.](#)

 [View a reassembling video of the inner finisher.](#)

 **IMPORTANT:** When applicable, special installation instructions are provided for an assembly at the end of the removal procedure. Always completely read the removal instructions and follow all special installation instructions.


Mean time to repair:

Service level:

## Before performing service

### Turn the printer power off

- Press the power button on the front of the printer, and then turn off the power switch next to the power cable.
- A shutting-down message appears on the control-panel display.

 **WARNING!** To avoid damage to the printer, turn the power off and wait until the printer shuts down before removing the power cable.

- Disconnect the printer power cable after the printer has completely shut down (the control-panel display is blank).

Use the table below to identify the correct part number for your printer. To order the part, go to <http://www.hp.com/buy/parts>.

Table 6-71 Part information

Part number	Part description
JC31-00178B	Output tray motor

## Required tools

- #2 JIS screwdriver with a magnetic tip

## After performing service

### Turn the printer power on

- Connect the power cable.
- Use the power switch to turn the power on.

## Post service test

Print any pages necessary to verify that the repair resolved the issue and did not create any new issues.

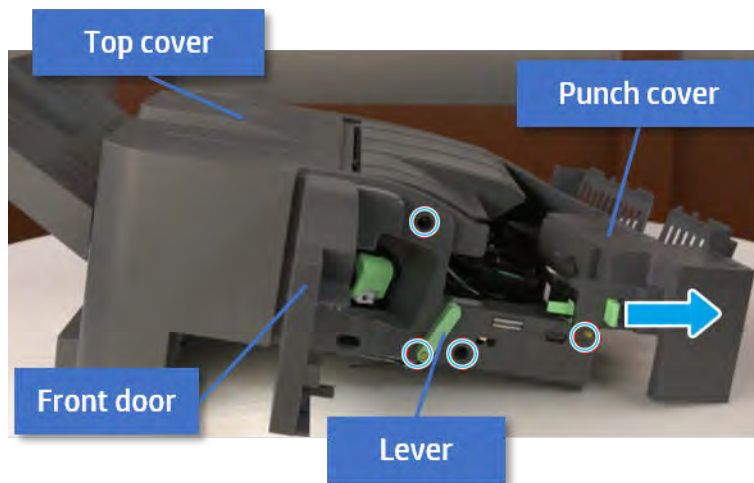


## Remove the front cover

Follow these steps to remove the front cover:

1. Open the front door and open the punch cover.
2. Remove three screws in the front.
3. Remove the lever.
4. Open the top cover.
5. From the right side of the front cover, carefully lift and pry toward the top-left corner to remove the front cover.

Figure 6-689 Remove the front cover

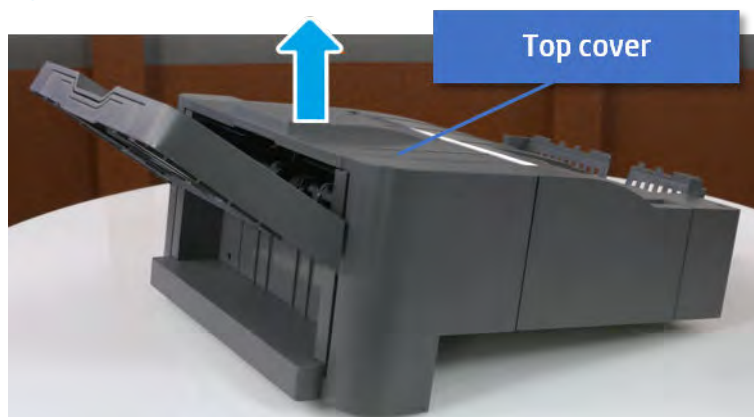


## Remove the rear cover

Follow these steps to remove the rear cover:

1. Open the top cover.

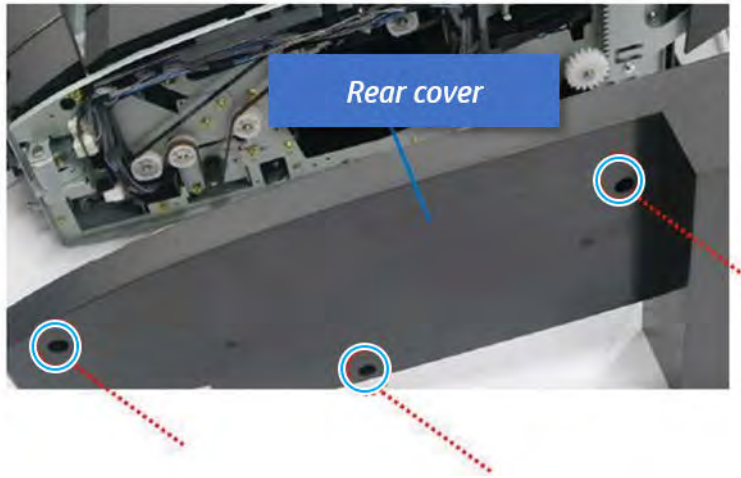
Figure 6-690 Open the top cover



2. Remove three screws.

3. Release hooks carefully and remove the rear cover.

**Figure 6-691** Remove the rear cover

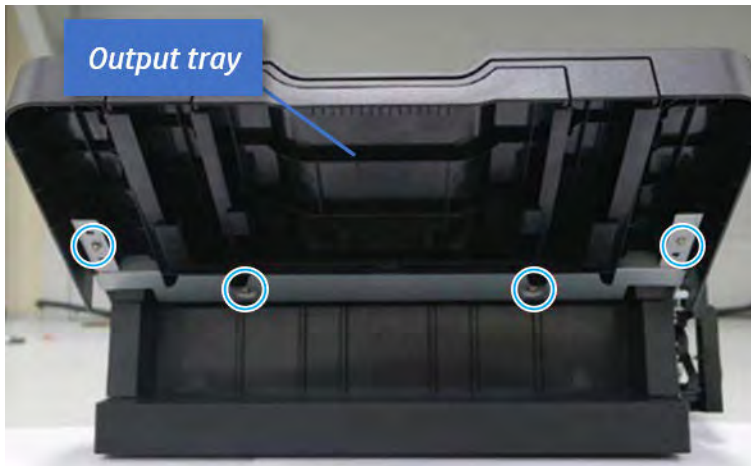


### Remove the output tray

Follow these steps to remove the output tray.

1. Remove four screws.

**Figure 6-692** Remove four screws



2. Push the paper holding actuator into the inner finisher, and then remove the output tray.

Figure 6-693 Remove the output tray.

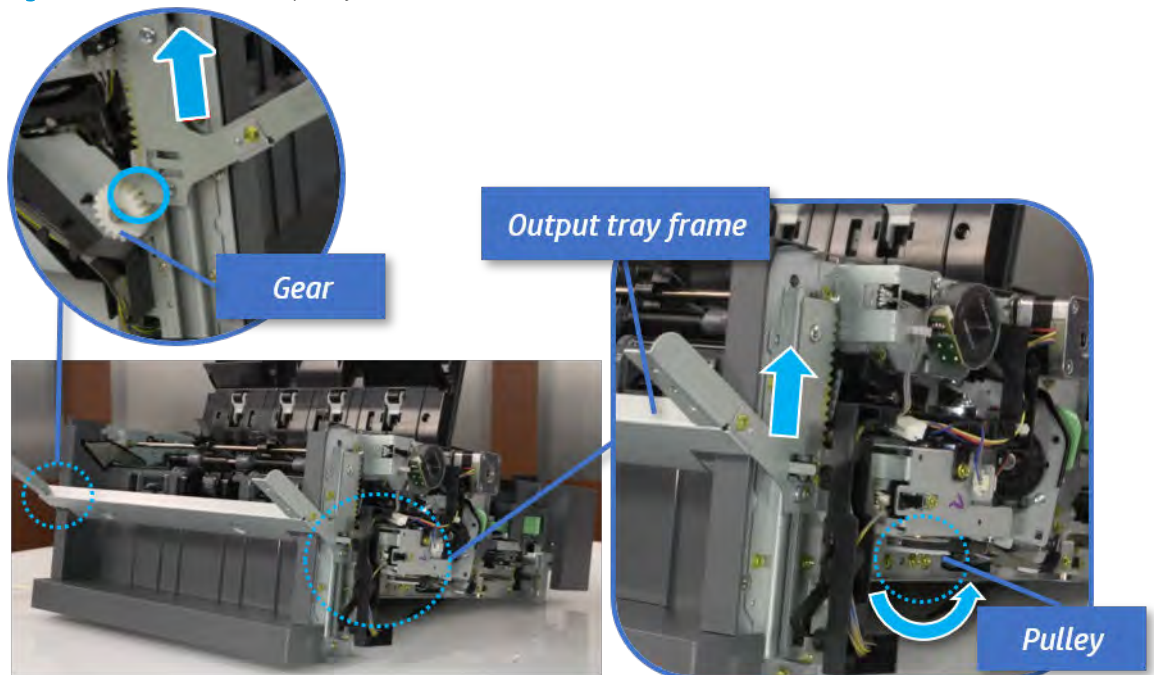


### Remove the output tray frame

Follow these steps to remove the output tray frame.

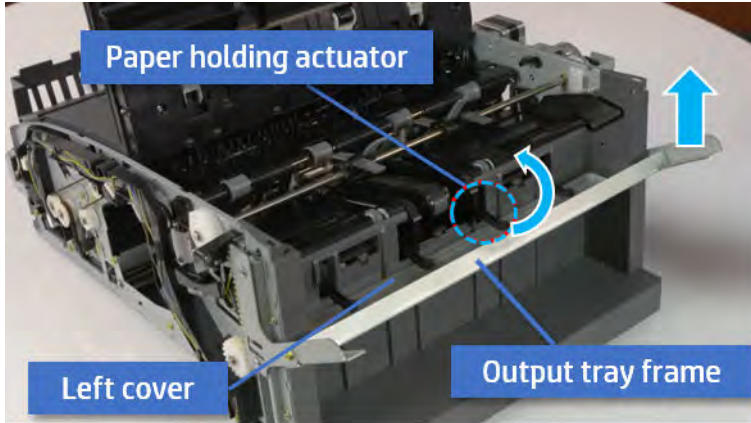
1. Rotate the pulley until the output tray frame depart from the gear.

Figure 6-694 Remove the pulley



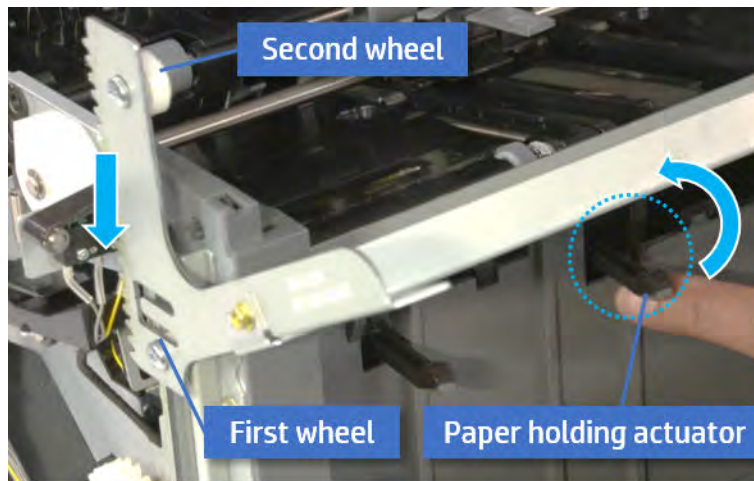
2. Push the paper holding actuator into the inner finisher, and then remove the output tray frame.

Figure 6-695 Remove the output tray frame

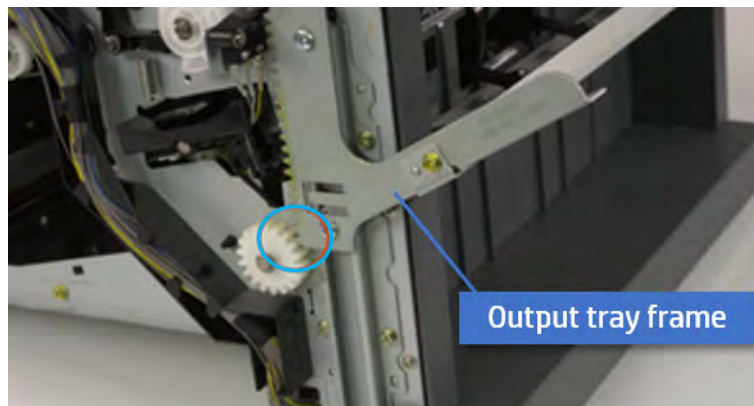


**TIP:** Push the paper holding actuator into the inner finisher when reassembling. Be sure to level the output tray.

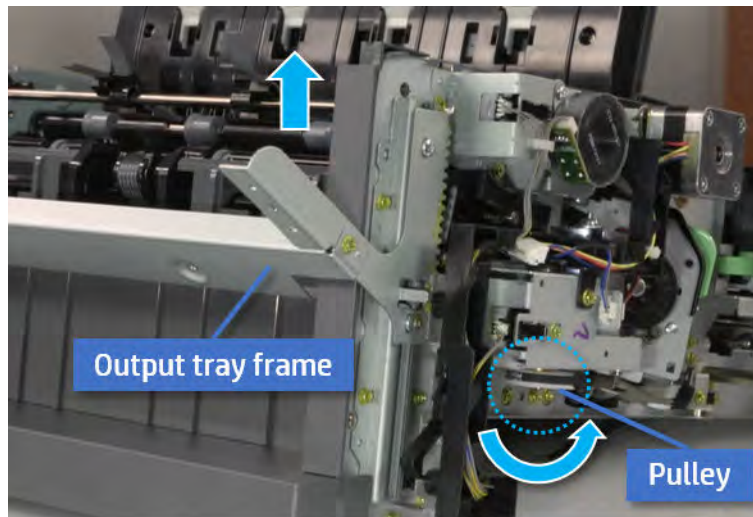
- a. Position the first wheel into the channel on both sides while pushing the paper holding actuator.



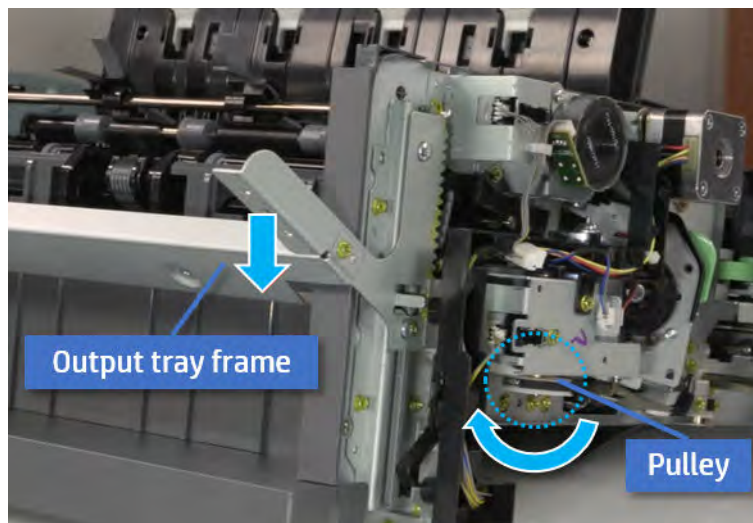
- b. Let the second wheel rest on the channel on both sides simultaneously.
- c. Gently squeeze the wheels into channel until the output tray frame meet the gear.



- d. Rotate the pulley until the output tray frame is no longer lifted. It can make to level the output tray frame.



- e. Rotate the pulley in the opposite direction.

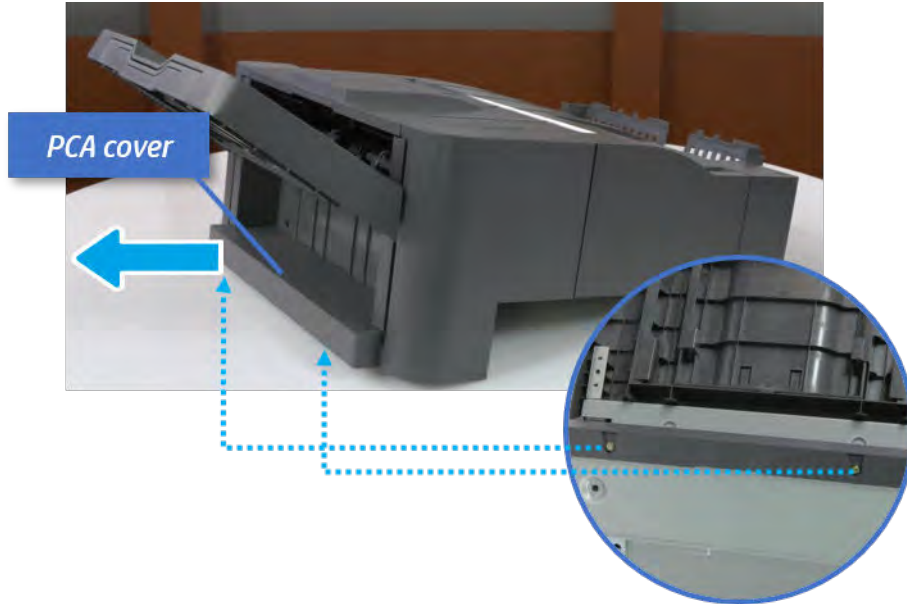


### Remove the PCA cover

Follow these steps to remove the PCA cover.

- ▲ Remove two screws, and then remove the PCA cover.

Figure 6-696 Remove the PCA cover

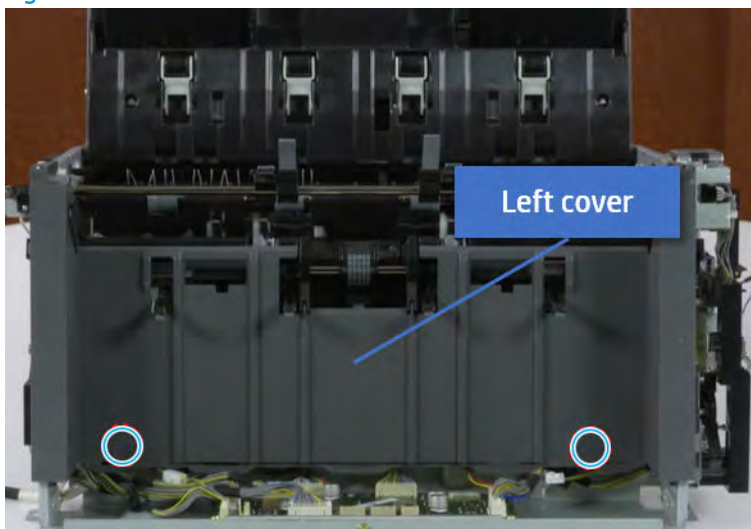


### Remove the left cover

Follow these steps to remove the left cover.

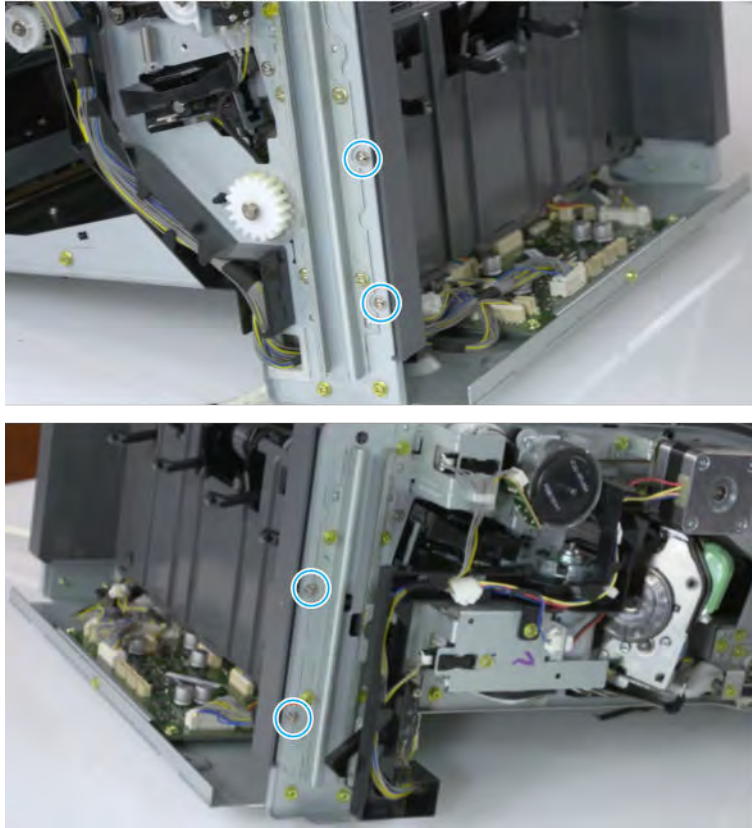
1. Remove two screws.

Figure 6-697 Remove two screws



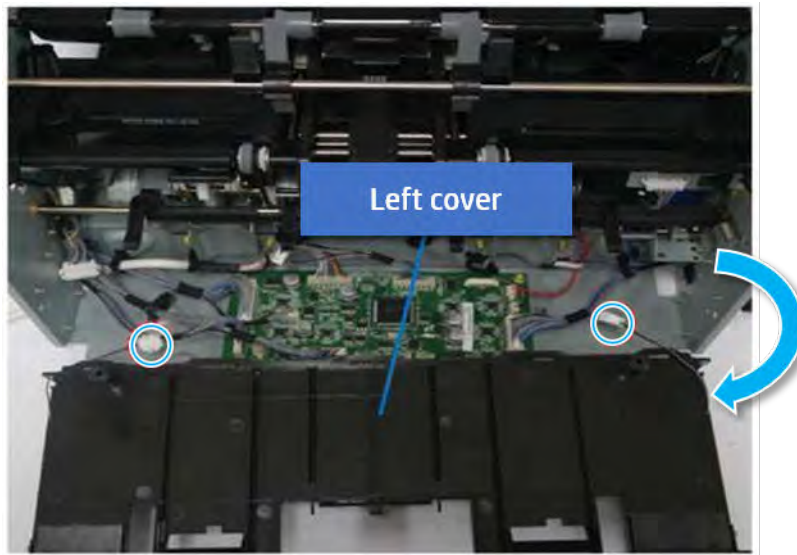
2. Remove four screws from both front and rear sides.


Figure 6-698 Remove four screws

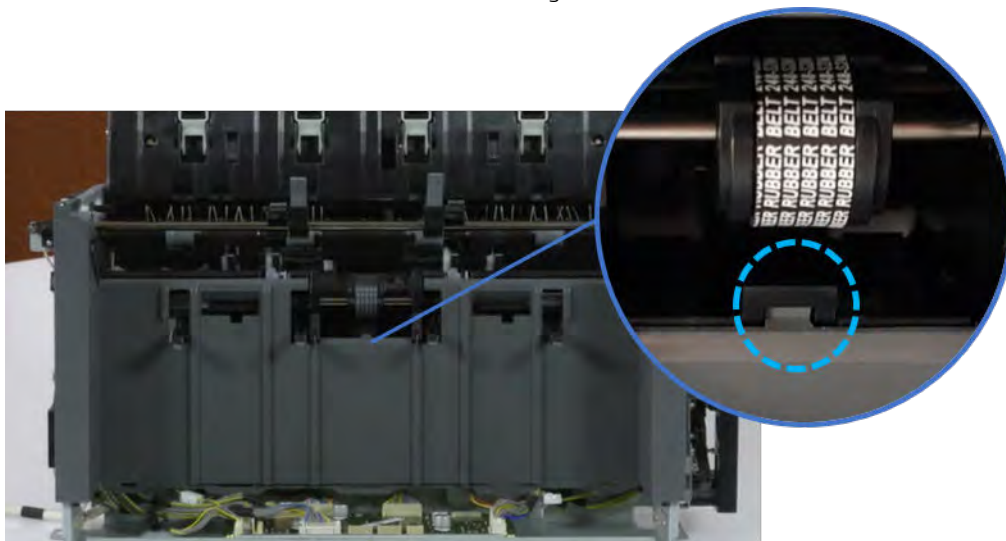


3. Unplug two inline connectors, and then remove the left cover.

Figure 6-699 Unplug two connectors



 **TIP:** Be sure to check the hook when reassembling.



### Remove the front harness guide

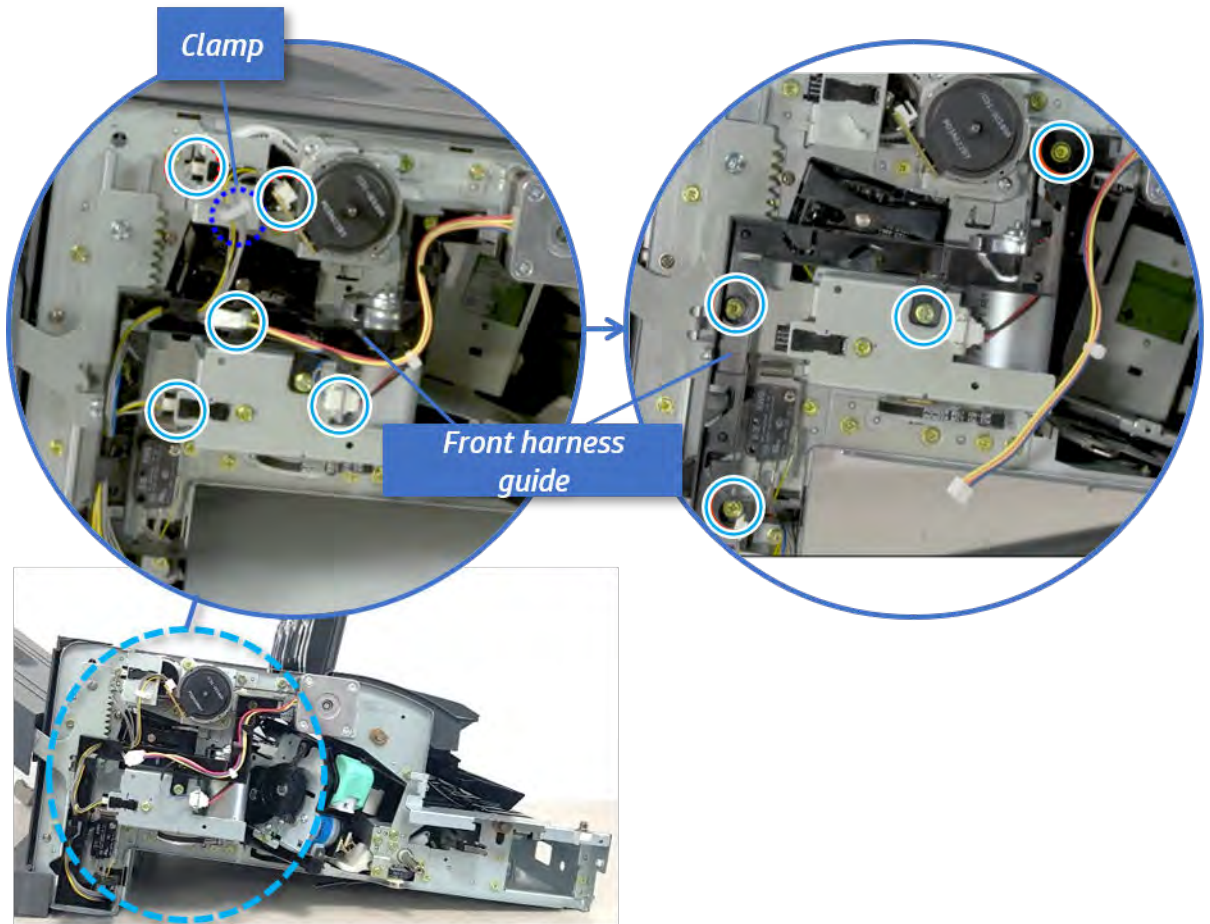
Follow these steps to remove the front harness guide.

1. Open one clamp and unplug five connectors, and then remove the wire harness from the front harness guide.



2. Remove four screws, and then remove the front harness guide.

Figure 6-700 Remove the front harness guide

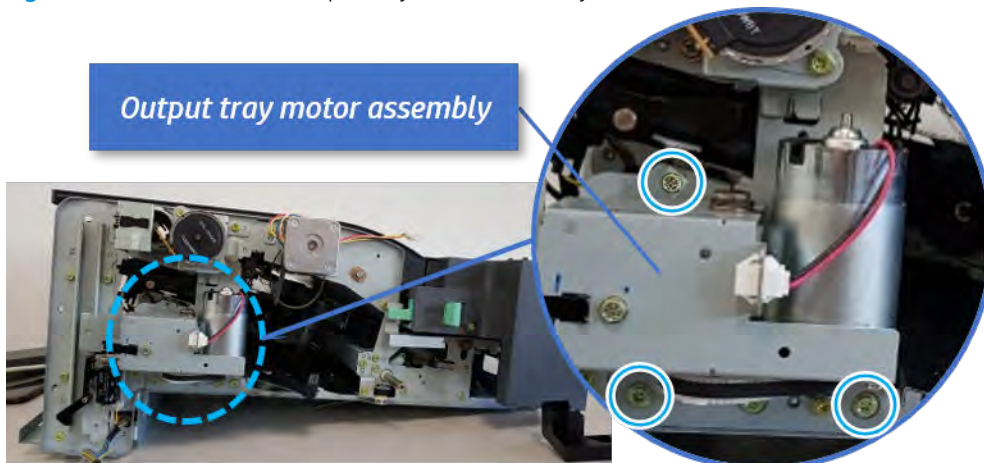


### Remove the output tray motor assembly

Follow these steps to remove the output tray motor assembly.

- ▲ Remove three screws, and then remove the output tray motor assembly.

Figure 6-701 Remove the output tray motor assembly

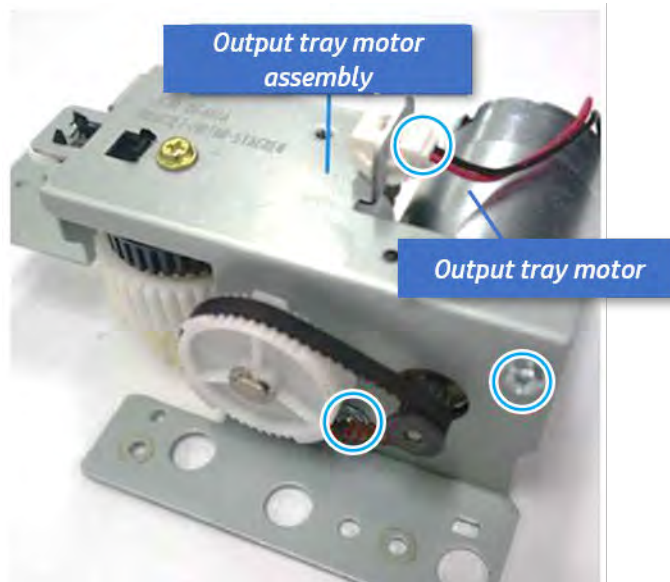


## Remove the output tray motor

Follow these steps to remove the output tray motor.

- ▲ Remove two screws, unplug the connector, and then remove the output tray motor.

**Figure 6-702** Remove the output tray motor



## Unpack the replacement assembly



Follow these steps to unpack the replacement assembly.

1. Dispose of the defective part.


 **NOTE:** HP recommends responsible disposal of the defective part.

<http://www8.hp.com/us/en/hp-information/environment/product-recycling.html>


2. Unpack the replacement part from the packaging.

 **CAUTION:**  Some parts are sensitive to electrostatic discharge (ESD). Always perform service work at an ESD-protected workstation or mat. If an ESD workstation or mat is not available, touch the sheet-metal chassis to provide a static ground before touching an ESD-sensitive assembly. Protect the ESD-sensitive assemblies by placing them in ESD pouches when they are out of the printer.

 **IMPORTANT:** Make sure that all of the shipping materials (for example shipping tape) are removed from the replacement part prior to installation.

 **NOTE:** If the replacement part is a roller or pad, avoid touching the spongy part of it. Skin oils on the roller or pad can cause paper pickup and/or print-quality problems. HP recommends using disposable gloves when handling rollers or pads or washing your hands before touching rollers or pads.

3. To install an assembly, reverse the removal steps.

 **NOTE:** When applicable, special installation instructions are provided for an assembly at the end of the removal procedure. Always completely read the removal instructions and follow all special installation instructions.

## Paper holding unit

## Removal and replacement: Paper holding


Learn how to remove and replace the paper holding.

To view teardown and reassembling video of the inner finisher, click the link below.

 [View a teardown video of the inner finisher.](#)

 [View a reassembling video of the inner finisher.](#)

---

 **IMPORTANT:** When applicable, special installation instructions are provided for an assembly at the end of the removal procedure. Always completely read the removal instructions and follow all special installation instructions.

---

Mean time to repair:


Service level:

### Before performing service

#### Turn the printer power off

- Press the power button on the front of the printer, and then turn off the power switch next to the power cable.
- A shutting-down message appears on the control-panel display.

---

 **WARNING!** To avoid damage to the printer, turn the power off and wait until the printer shuts down before removing the power cable.

---

- Disconnect the printer power cable after the printer has completely shut down (the control-panel display is blank).

Use the table below to identify the correct part number for your printer. To order the part, go to <http://www.hp.com/buy/parts>.

Table 6-72 Part information

Part number	Part description
JC90-01313A	Paper holding actuator

### Required tools

- #2 JIS screwdriver with a magnetic tip

### After performing service

#### Turn the printer power on

- Connect the power cable.
- Use the power switch to turn the power on.

### Post service test

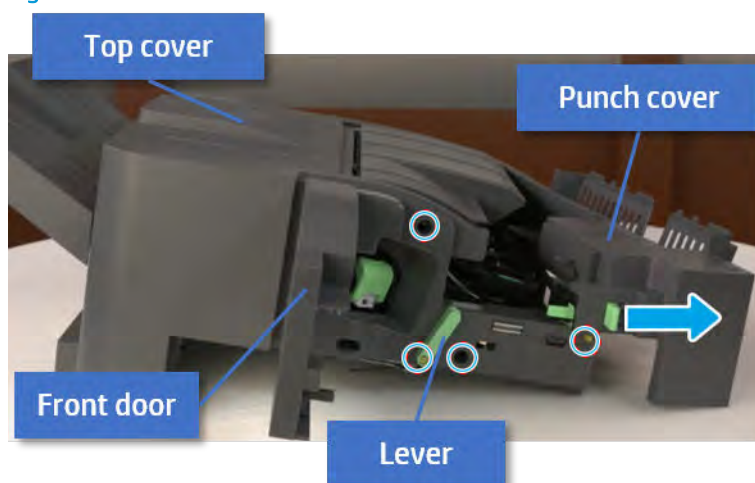
Print any pages necessary to verify that the repair resolved the issue and did not create any new issues.

## Remove the front cover

Follow these steps to remove the front cover:

1. Open the front door and open the punch cover.
2. Remove three screws in the front.
3. Remove the lever.
4. Open the top cover.
5. From the right side of the front cover, carefully lift and pry toward the top-left corner to remove the front cover.

Figure 6-703 Remove the front cover

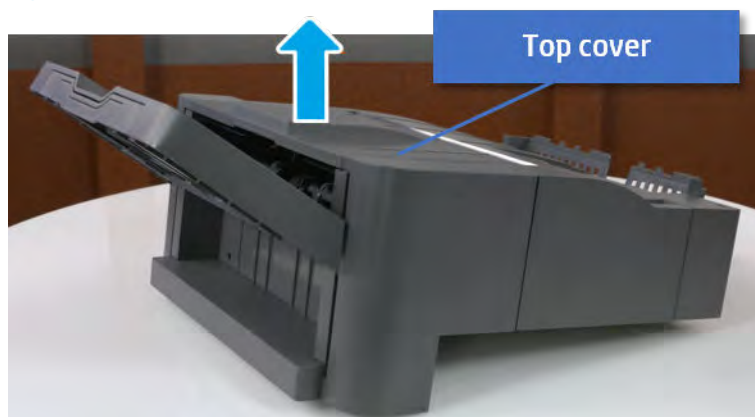


## Remove the rear cover

Follow these steps to remove the rear cover:

1. Open the top cover.

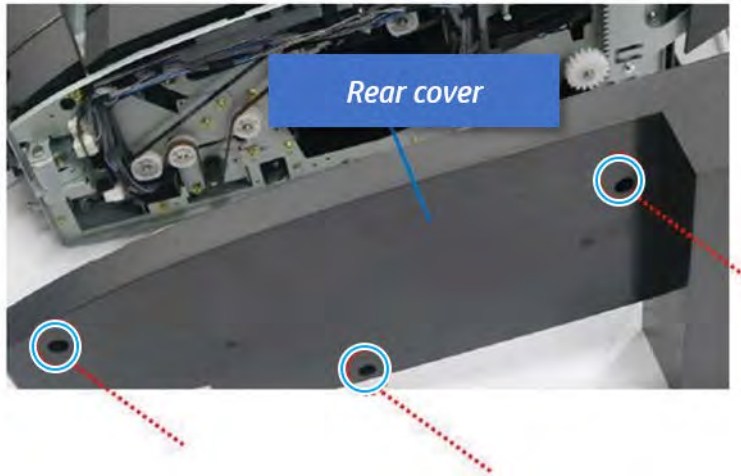
Figure 6-704 Open the top cover



2. Remove three screws.

3. Release hooks carefully and remove the rear cover.

**Figure 6-705** Remove the rear cover

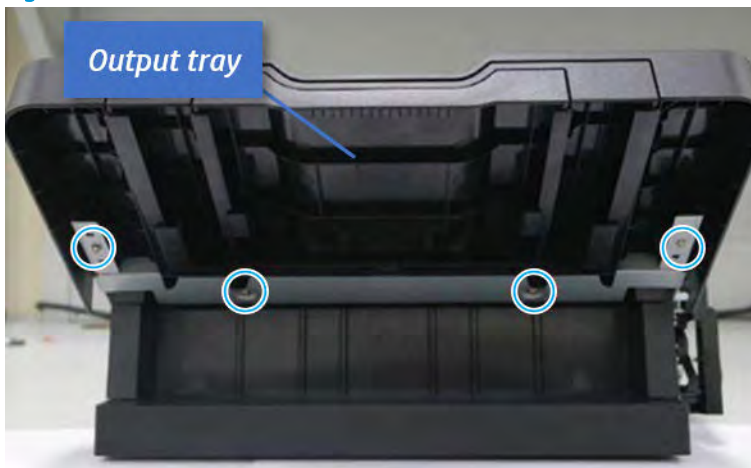


### Remove the output tray

Follow these steps to remove the output tray.

1. Remove four screws.

**Figure 6-706** Remove four screws



2. Push the paper holding actuator into the inner finisher, and then remove the output tray.

Figure 6-707 Remove the output tray.

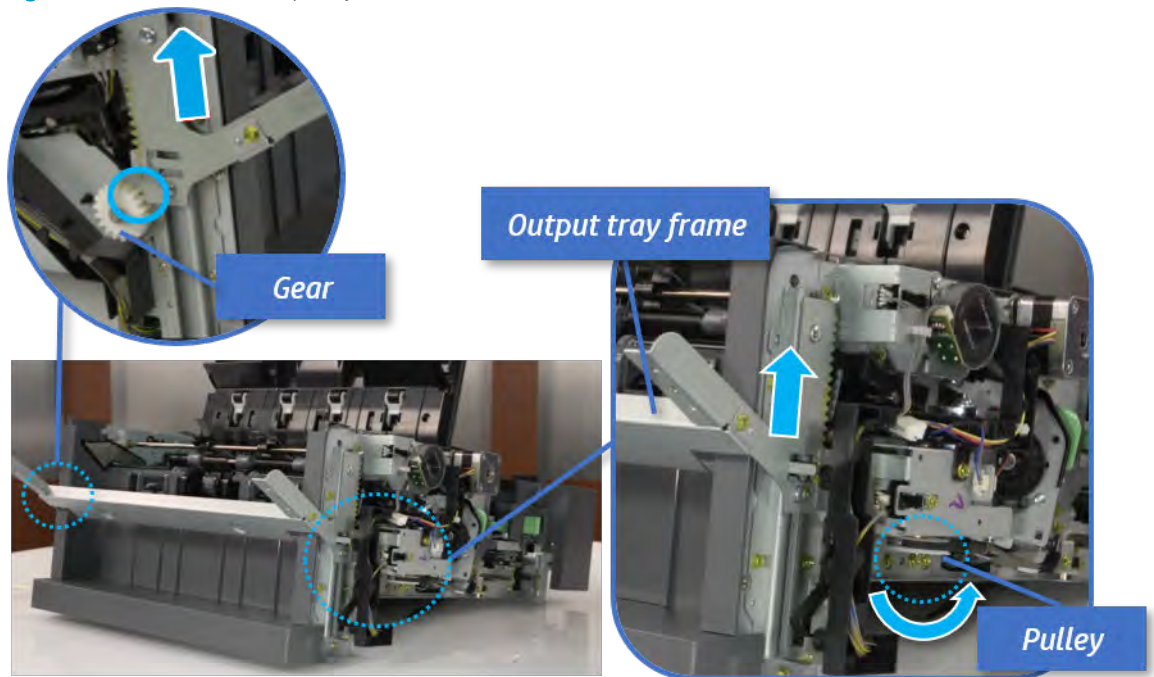


### Remove the output tray frame

Follow these steps to remove the output tray frame.

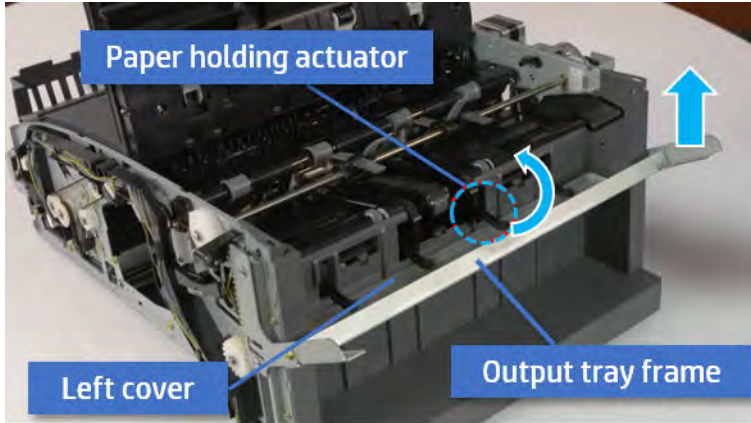
1. Rotate the pulley until the output tray frame depart from the gear.

Figure 6-708 Remove the pulley



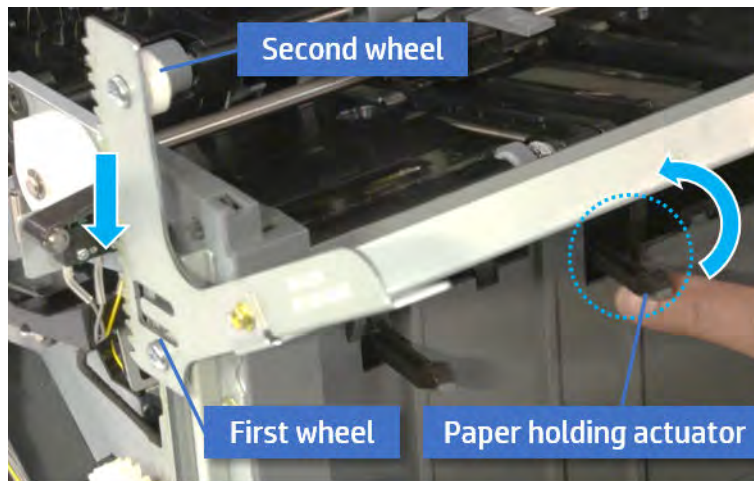
2. Push the paper holding actuator into the inner finisher, and then remove the output tray frame.

Figure 6-709 Remove the output tray frame

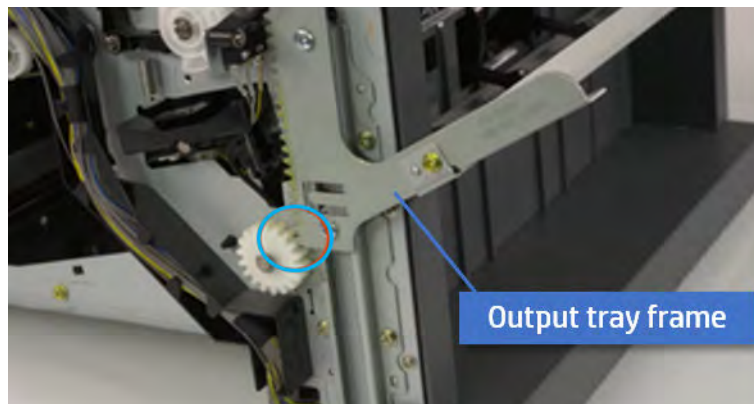


**TIP:** Push the paper holding actuator into the inner finisher when reassembling. Be sure to level the output tray.

- a. Position the first wheel into the channel on both sides while pushing the paper holding actuator.

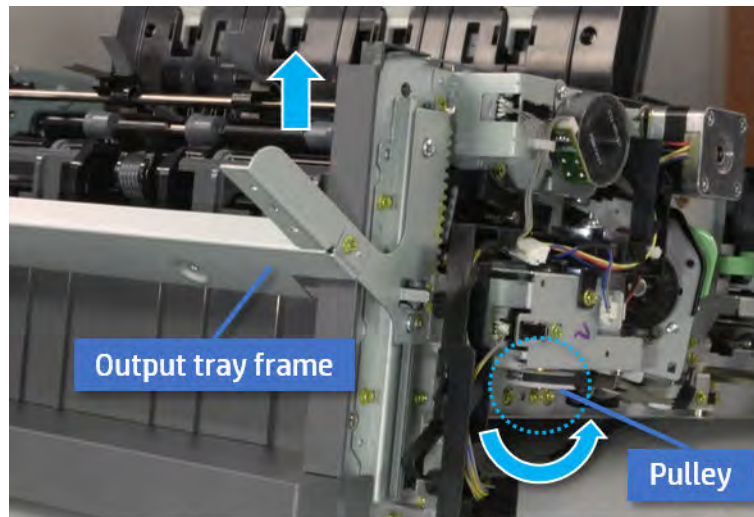


- b. Let the second wheel rest on the channel on both sides simultaneously.
- c. Gently squeeze the wheels into channel until the output tray frame meet the gear.

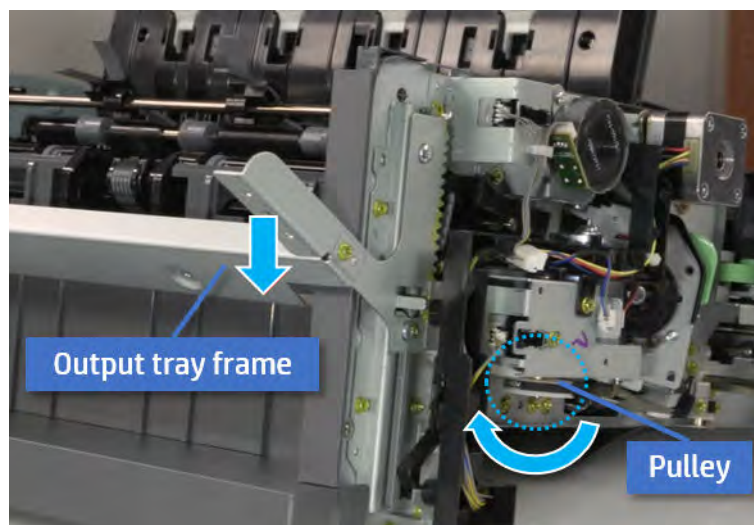




- d. Rotate the pulley until the output tray frame is no longer lifted. It can make to level the output tray frame.



- e. Rotate the pulley in the opposite direction.

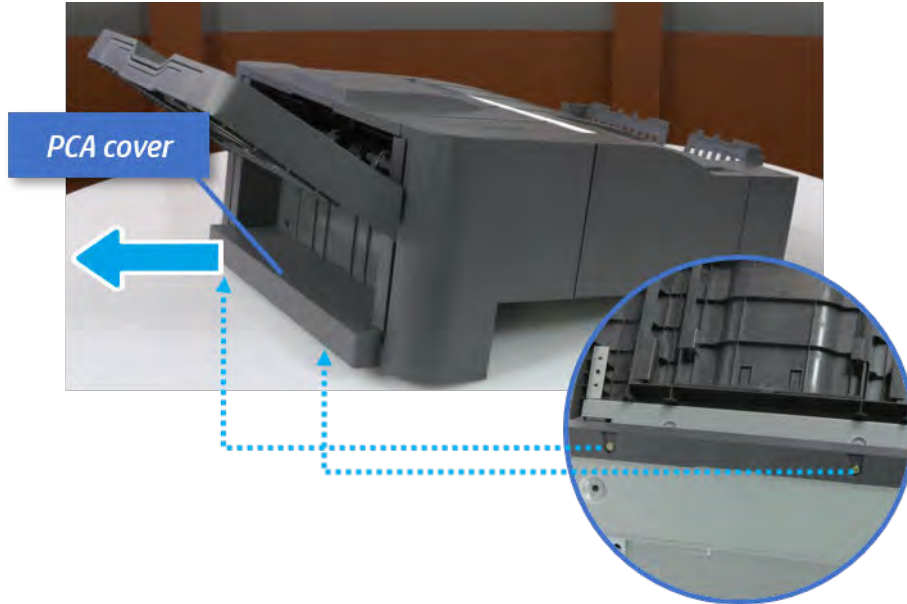


### Remove the PCA cover

Follow these steps to remove the PCA cover.

- ▲ Remove two screws, and then remove the PCA cover.

Figure 6-710 Remove the PCA cover

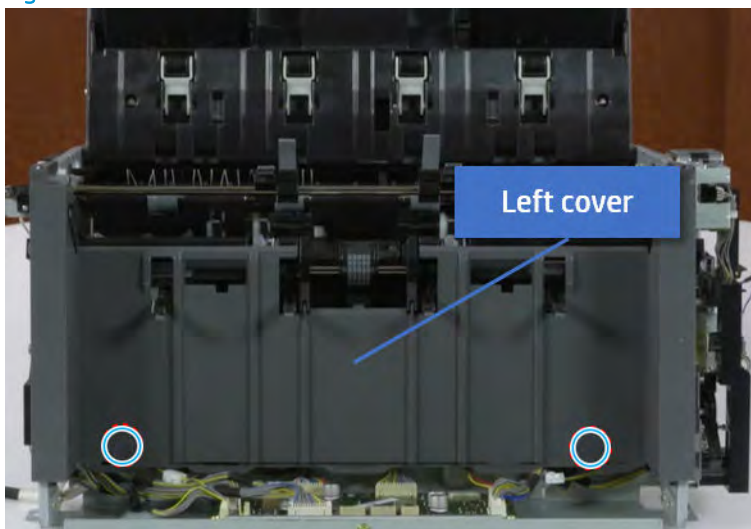


### Remove the left cover

Follow these steps to remove the left cover.

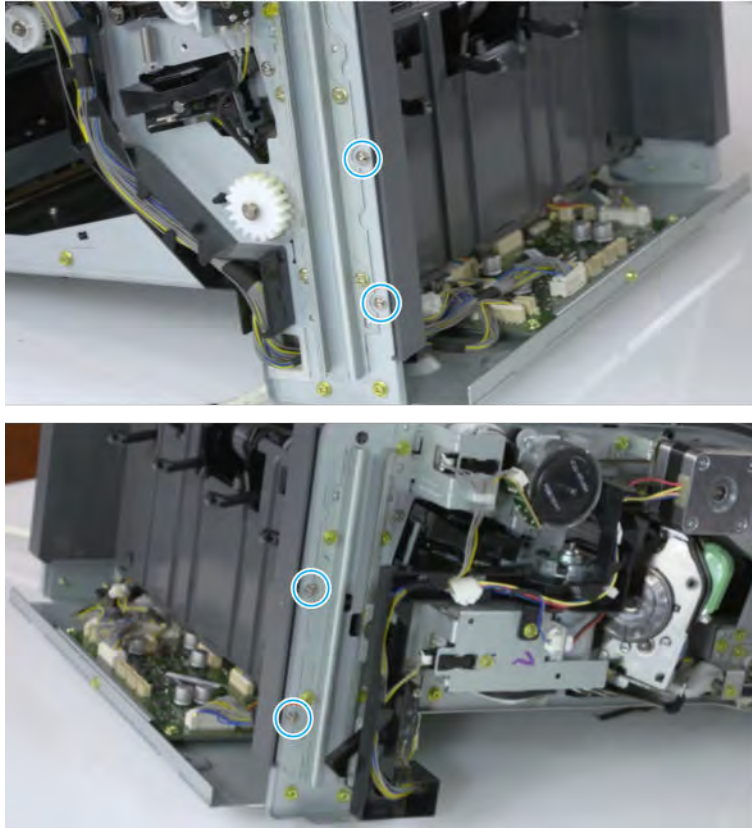
1. Remove two screws.

Figure 6-711 Remove two screws



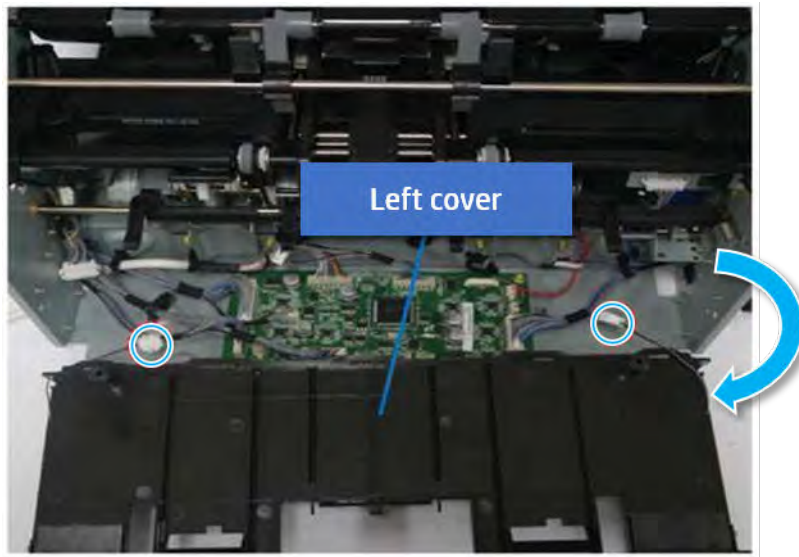
2. Remove four screws from both front and rear sides.


Figure 6-712 Remove four screws

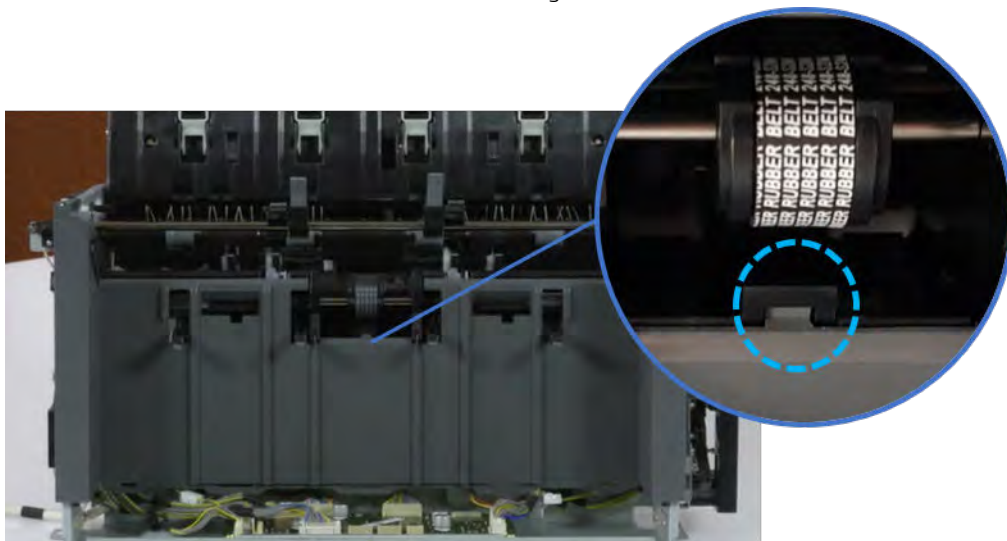


3. Unplug two inline connectors, and then remove the left cover.

**Figure 6-713** Unplug two connectors



 **TIP:** Be sure to check the hook when reassembling.



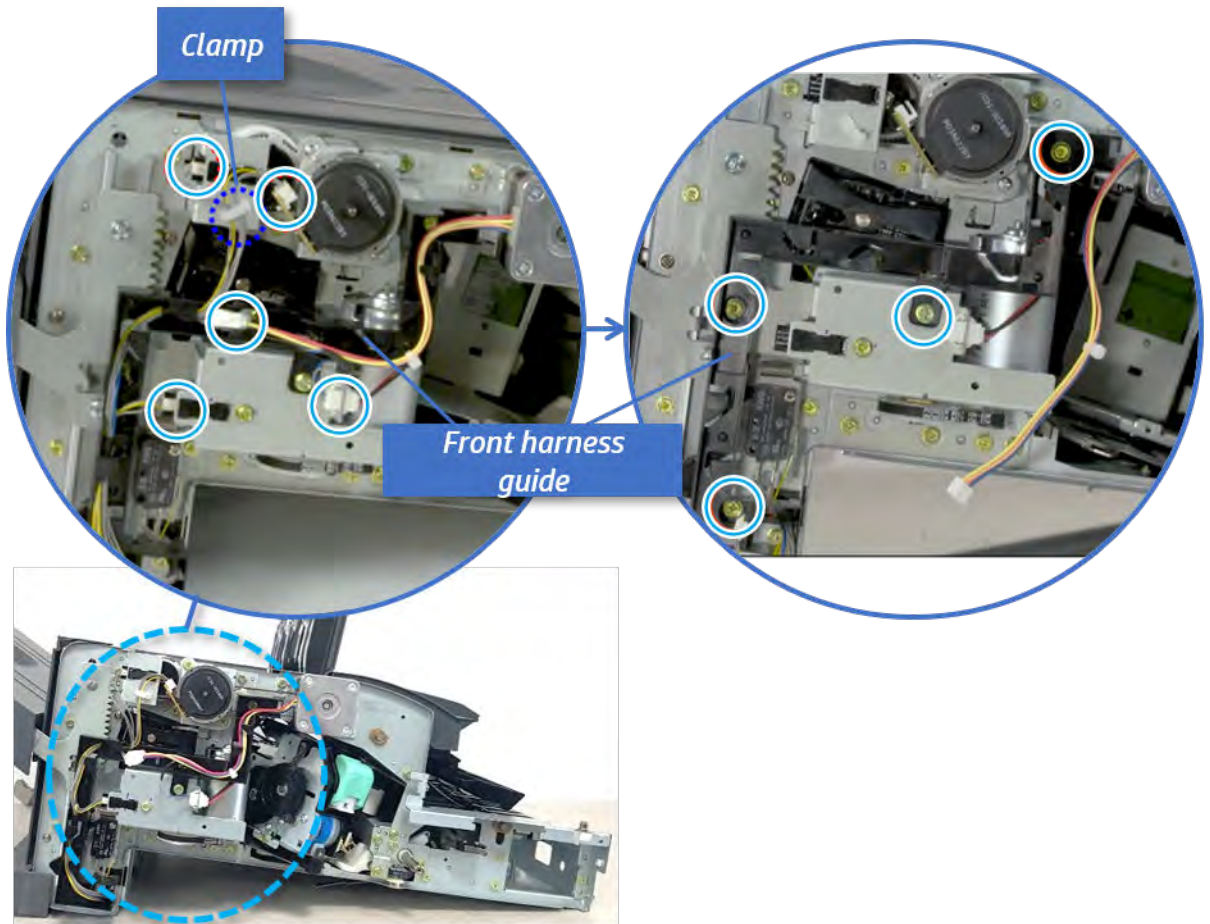
### Remove the front harness guide

Follow these steps to remove the front harness guide.

1. Open one clamp and unplug five connectors, and then remove the wire harness from the front harness guide.

2. Remove four screws, and then remove the front harness guide.

Figure 6-714 Remove the front harness guide

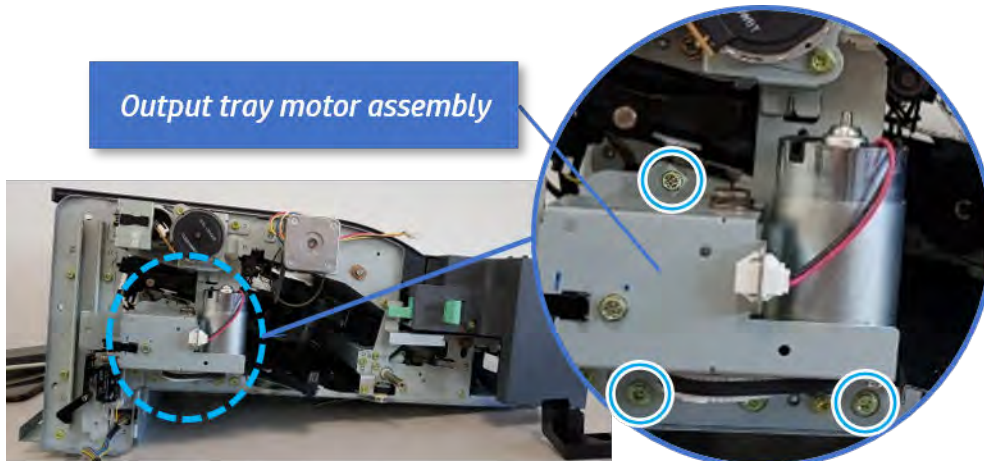


### Remove the output tray motor assembly

Follow these steps to remove the output tray motor assembly.

- ▲ Remove three screws, and then remove the output tray motor assembly.

Figure 6-715 Remove the output tray motor assembly

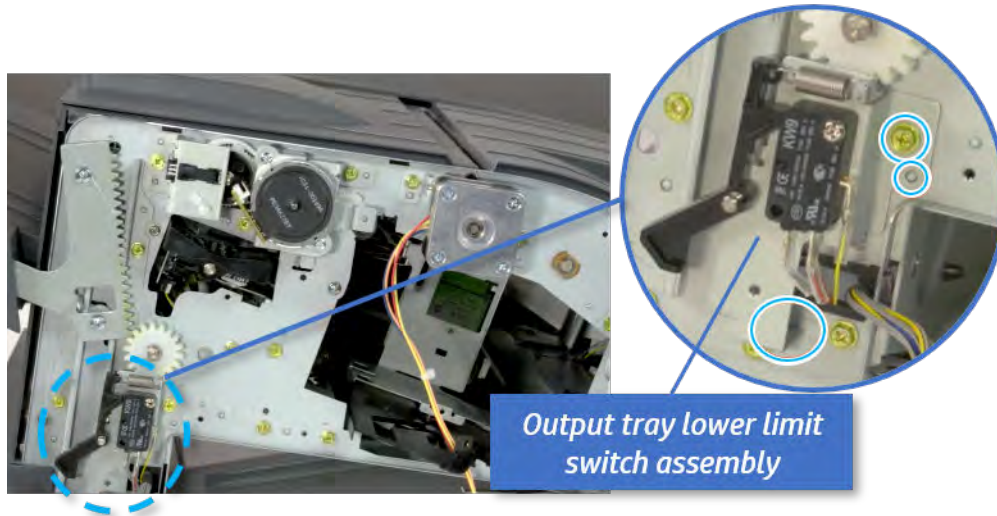


## Remove the output tray lower limit switch

Follow these steps to remove the output tray lower limit switch.

- ▲ Remove one screw, and then remove the output tray lower limit switch.

**Figure 6-716** Remove the output tray lower limit switch

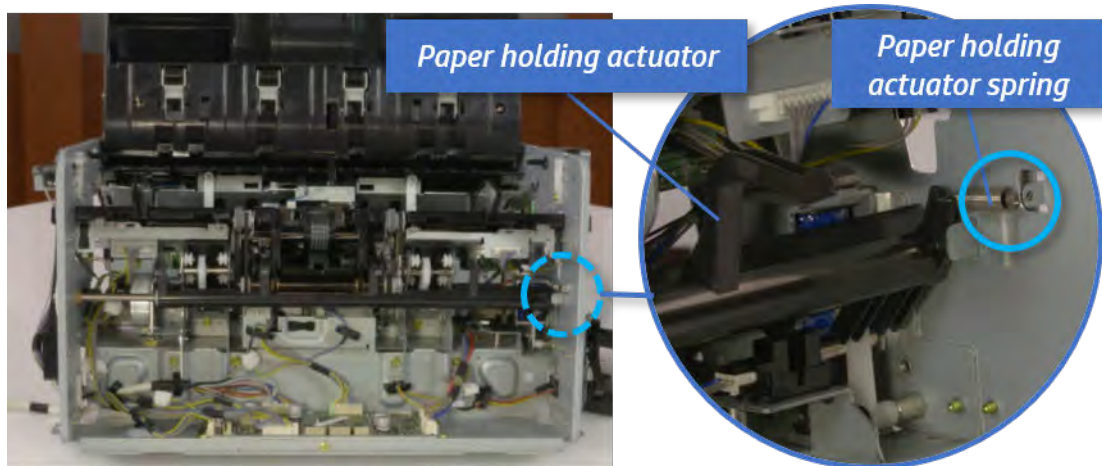


## Remove the paper holding

Follow these steps to remove the paper holding.

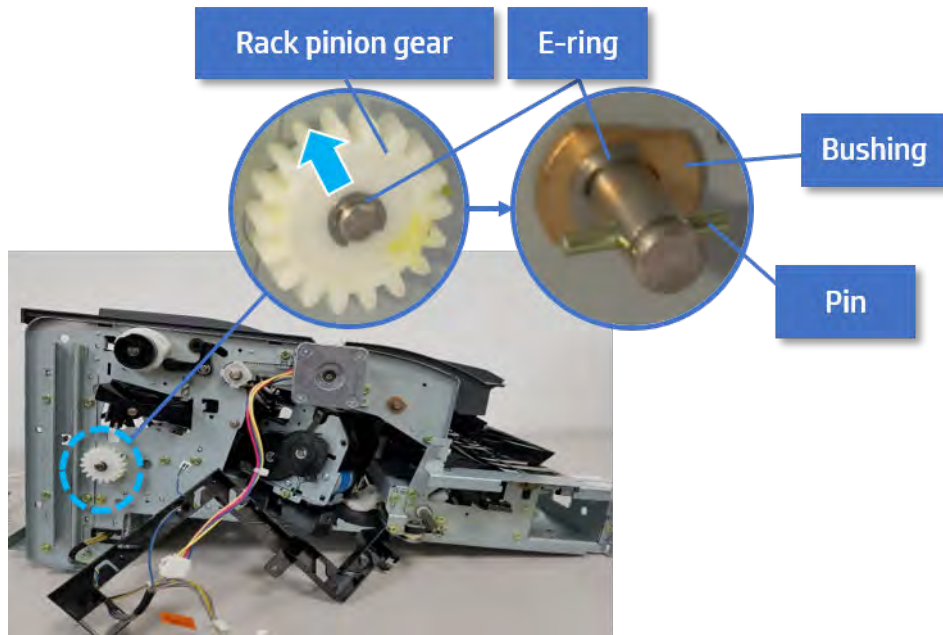
1. Remove the paper holding actuator spring.


**Figure 6-717** Remove the paper holding actuator spring



2. Remove the e-ring and the rack pinion gear. And then remove the pin and the e-ring, and then remove the bushing.

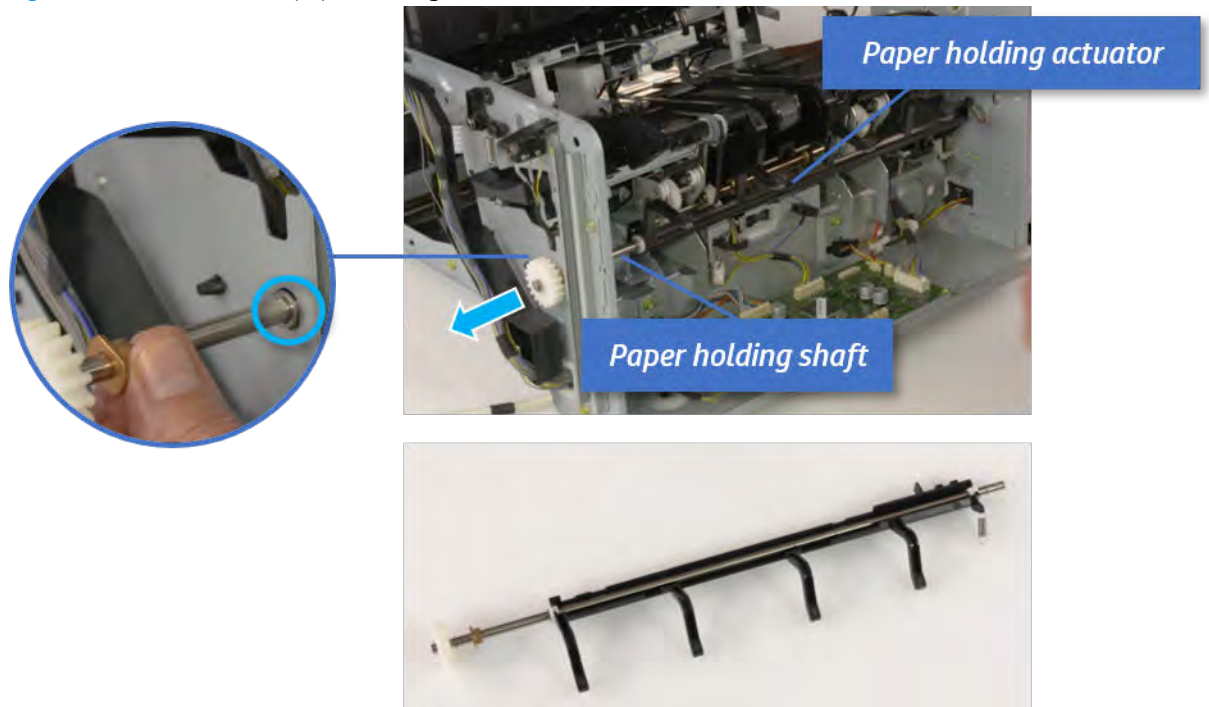
**Figure 6-718** Remove e-ring, rack pinion gear, pin, and bushing



 **NOTE:** Be sure not to lose the pin.

3. Carefully remove the paper holding shaft and the actuator.

**Figure 6-719** Remove the paper holding shaft and the actuator




### Unpack the replacement assembly

Follow these steps to unpack the replacement assembly.

1. Dispose of the defective part.



---

 **NOTE:** HP recommends responsible disposal of the defective part.


<http://www8.hp.com/us/en/hp-information/environment/product-recycling.html>

---

2. Unpack the replacement part from the packaging.


 **CAUTION:**  Some parts are sensitive to electrostatic discharge (ESD). Always perform service work at an ESD-protected workstation or mat. If an ESD workstation or mat is not available, touch the sheet-metal chassis to provide a static ground before touching an ESD-sensitive assembly. Protect the ESD-sensitive assemblies by placing them in ESD pouches when they are out of the printer.

 **IMPORTANT:** Make sure that all of the shipping materials (for example shipping tape) are removed from the replacement part prior to installation.

 **NOTE:** If the replacement part is a roller or pad, avoid touching the spongy part of it. Skin oils on the roller or pad can cause paper pickup and/or print-quality problems. HP recommends using disposable gloves when handling rollers or pads or washing your hands before touching rollers or pads.

---

3. To install an assembly, reverse the removal steps.

 **NOTE:** When applicable, special installation instructions are provided for an assembly at the end of the removal procedure. Always completely read the removal instructions and follow all special installation instructions.

---




## Removal and replacement: Paper holding sensor (S9)

Learn how to remove and replace the paper holding sensor.

To view teardown and reassembling video of the inner finisher, click the link below.

 [View a teardown video of the inner finisher.](#)

 [View a reassembling video of the inner finisher.](#)

 **IMPORTANT:** When applicable, special installation instructions are provided for an assembly at the end of the removal procedure. Always completely read the removal instructions and follow all special installation instructions.


Mean time to repair:

Service level:

### Before performing service

#### Turn the printer power off

- Press the power button on the front of the printer, and then turn off the power switch next to the power cable.
- A shutting-down message appears on the control-panel display.

 **WARNING!** To avoid damage to the printer, turn the power off and wait until the printer shuts down before removing the power cable.

- Disconnect the printer power cable after the printer has completely shut down (the control-panel display is blank).

Use the table below to identify the correct part number for your printer. To order the part, go to <http://www.hp.com/buy/parts>.

Table 6-73 Part information

Part number	Part description
0604-001393	Paper holding sensor

### Required tools

- #2 JIS screwdriver with a magnetic tip

### After performing service

#### Turn the printer power on

- Connect the power cable.
- Use the power switch to turn the power on.

### Post service test

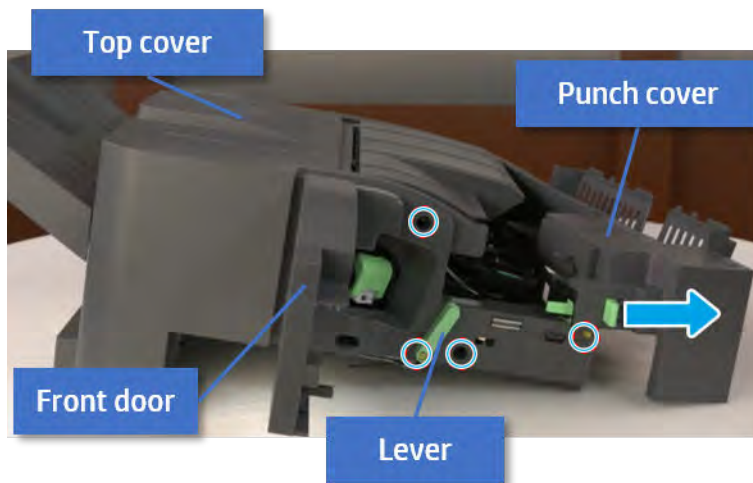
Print any pages necessary to verify that the repair resolved the issue and did not create any new issues.

## Remove the front cover

Follow these steps to remove the front cover.

1. Open the front door and open the punch cover.
2. Remove three screws in the front.
3. Remove the lever.
4. Open the top cover.
5. From the right side of the front cover, carefully lift and pry toward the top-left corner to remove the front cover.

Figure 6-720 Remove the front cover

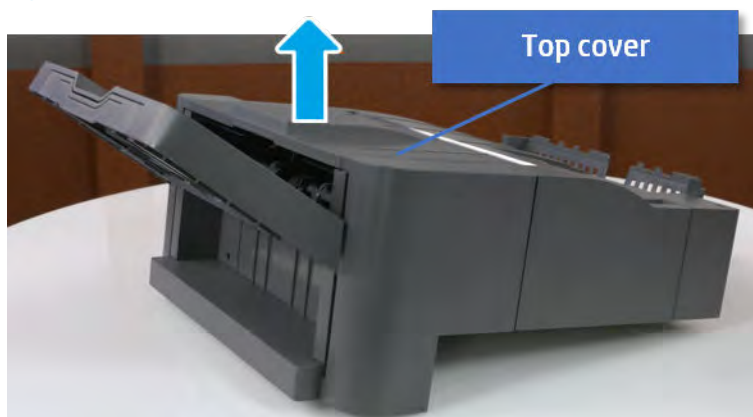


## Remove the rear cover

Follow these steps to remove the rear cover.

1. Open the top cover.

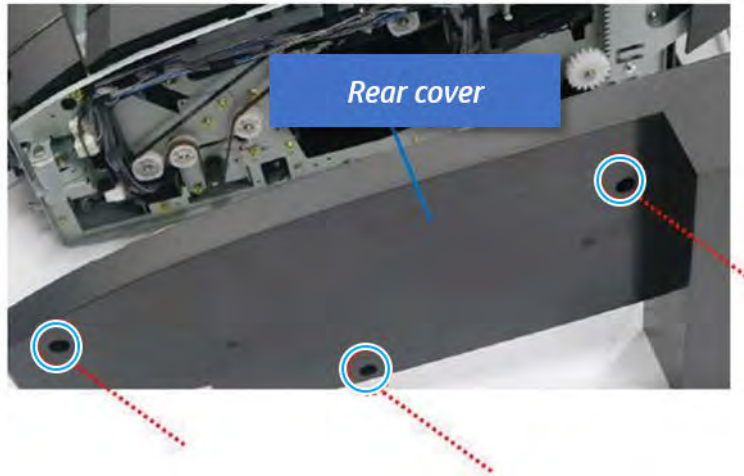
Figure 6-721 Open the top cover



2. Remove three screws.

3. Release hooks carefully and remove the rear cover.

**Figure 6-722** Remove the rear cover

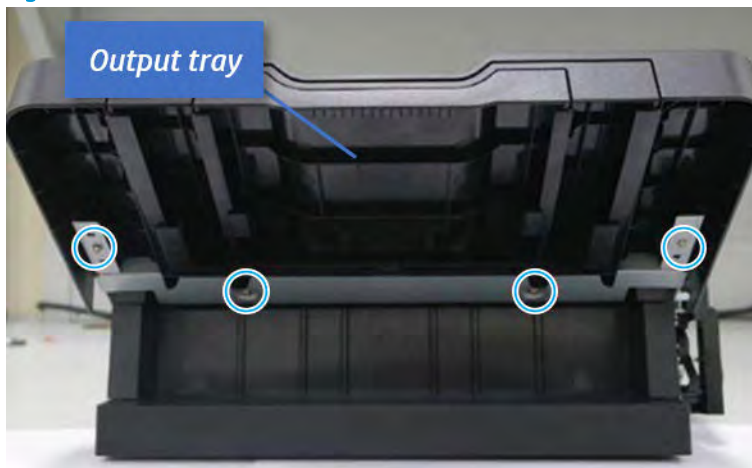


### Remove the output tray

Follow these steps to remove the output tray.

1. Remove four screws.

**Figure 6-723** Remove four screws



2. Push the paper holding actuator into the inner finisher, and then remove the output tray.

Figure 6-724 Remove the output tray.

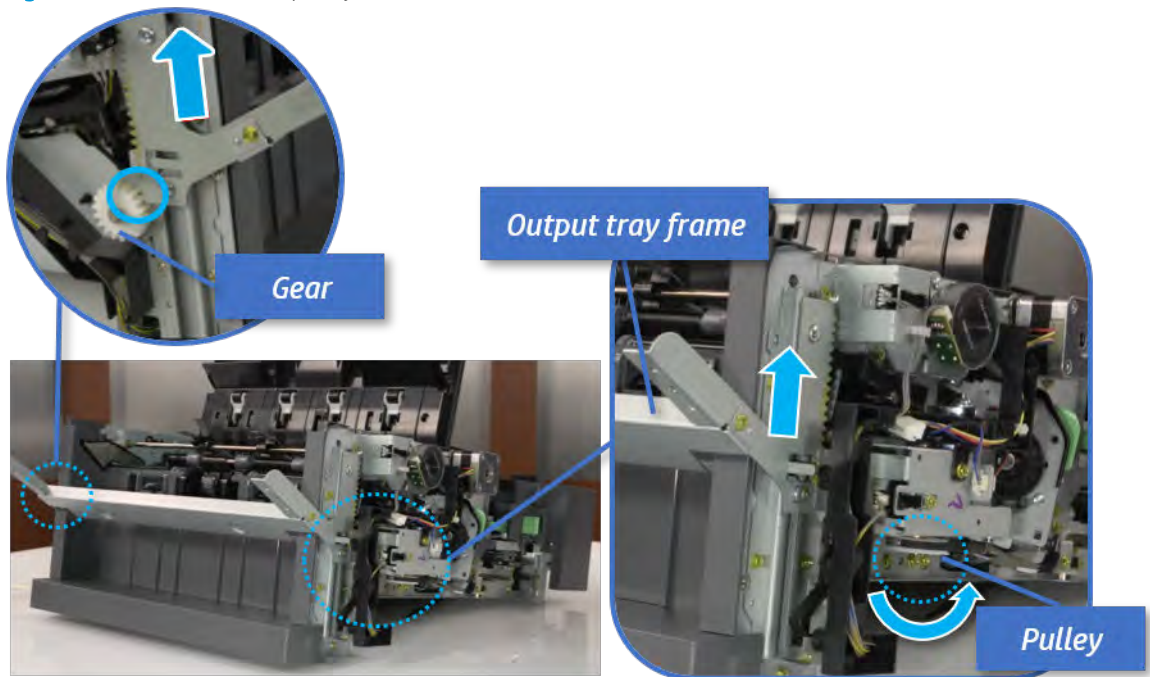


### Remove the output tray frame

Follow these steps to remove the output tray frame.

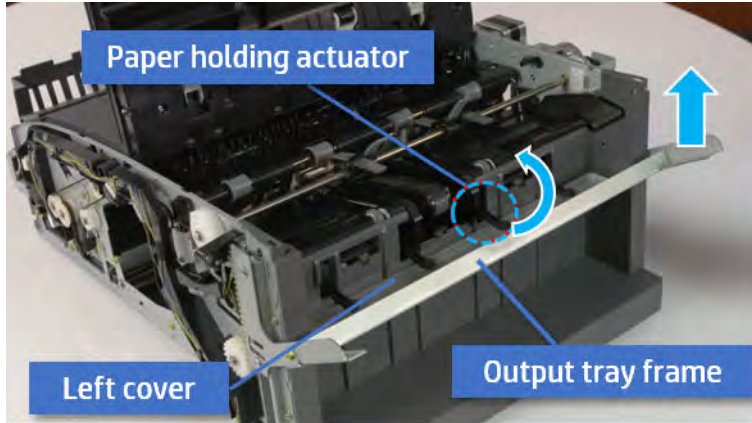
1. Rotate the pulley until the output tray frame depart from the gear.

Figure 6-725 Remove the pulley



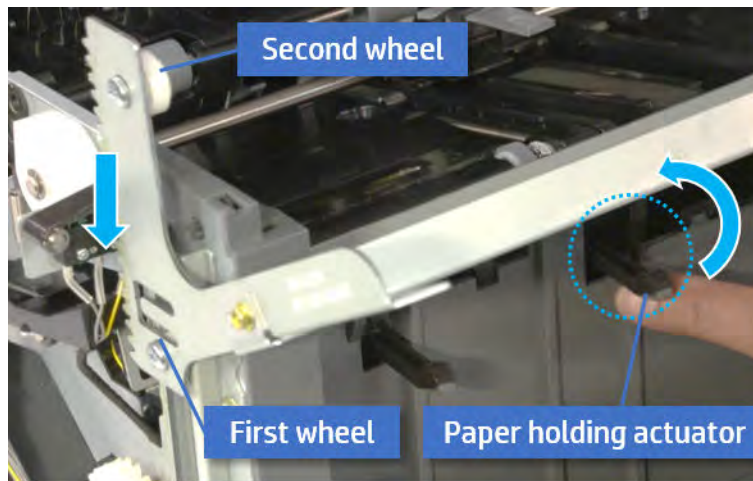
2. Push the paper holding actuator into the inner finisher, and then remove the output tray frame.

Figure 6-726 Remove the output tray frame

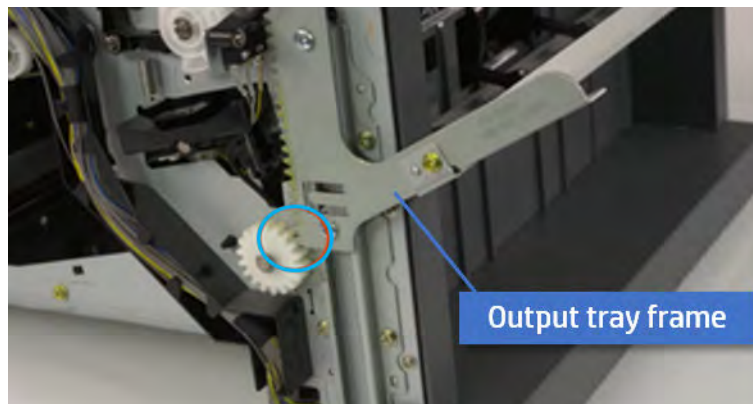


**TIP:** Push the paper holding actuator into the inner finisher when reassembling. Be sure to level the output tray.

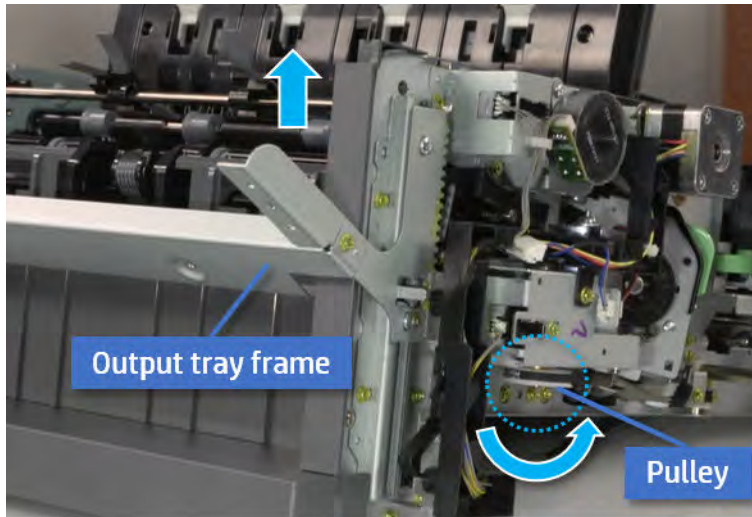
- a. Position the first wheel into the channel on both sides while pushing the paper holding actuator.



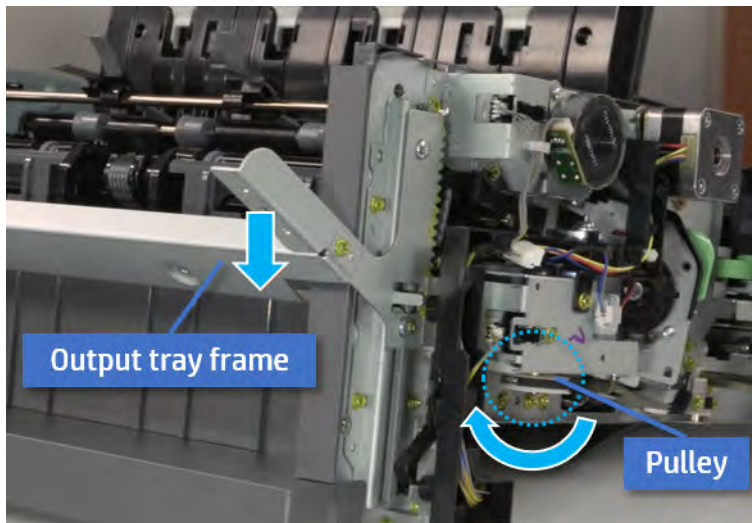
- b. Let the second wheel rest on the channel on both sides simultaneously.
- c. Gently squeeze the wheels into channel until the output tray frame meet the gear.



- d. Rotate the pulley until the output tray frame is no longer lifted. It can make to level the output tray frame.



- e. Rotate the pulley in the opposite direction.

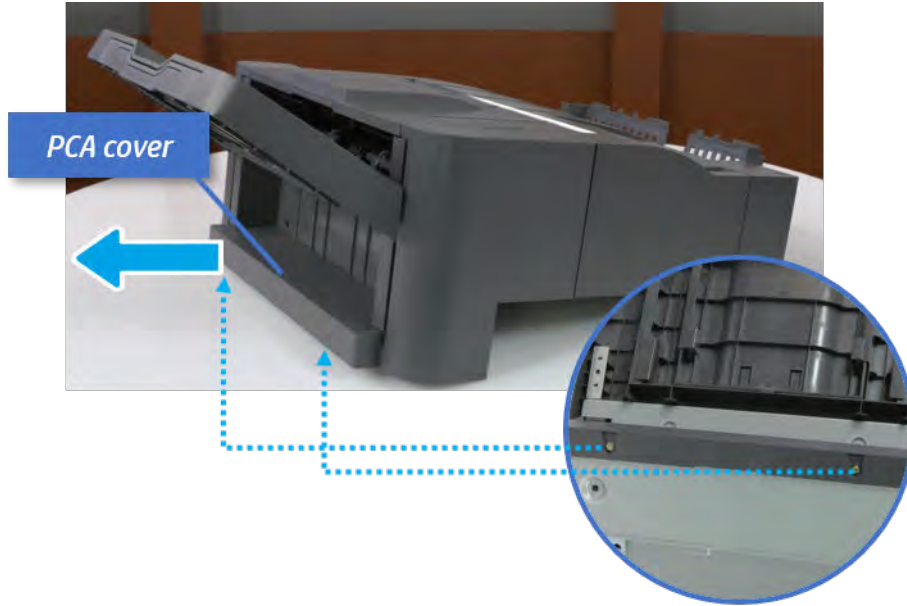


### Remove the PCA cover

Follow these steps to remove the PCA cover.

- ▲ Remove two screws, and then remove the PCA cover.

Figure 6-727 Remove the PCA cover

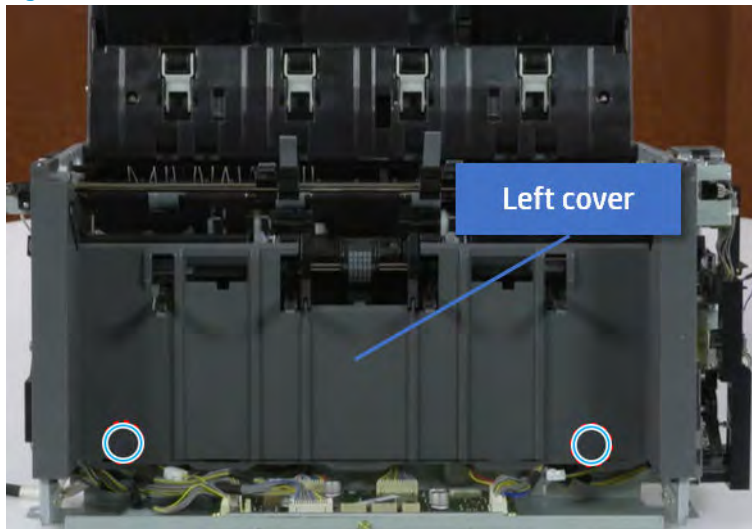


### Remove the left cover

Follow these steps to remove the left cover.

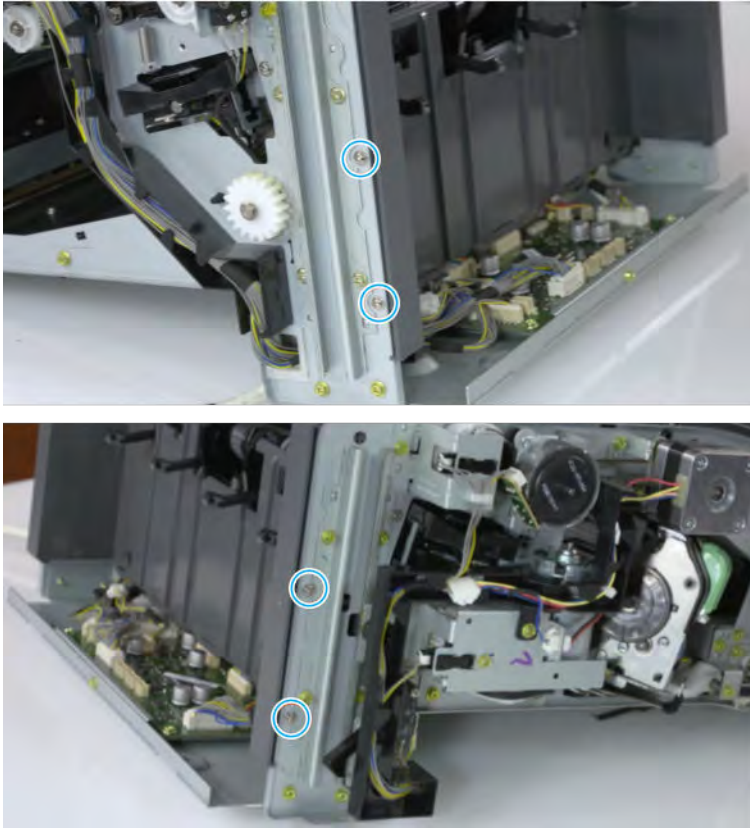
1. Remove two screws.

Figure 6-728 Remove two screws



2. Remove four screws from both front and rear sides.

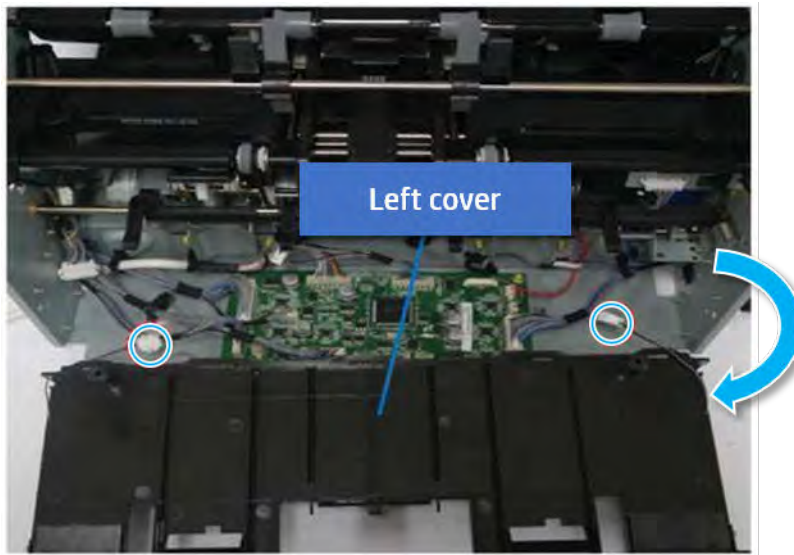
Figure 6-729 Remove four screws




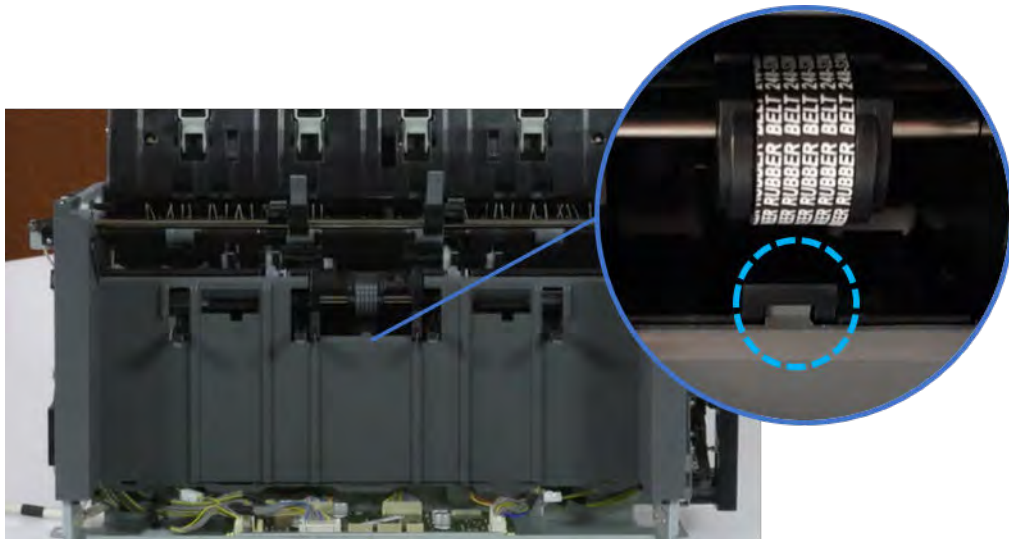


3. Unplug two inline connectors, and then remove the left cover.

Figure 6-730 Unplug two connectors



 **TIP:** Be sure to check the hook when reassembling.



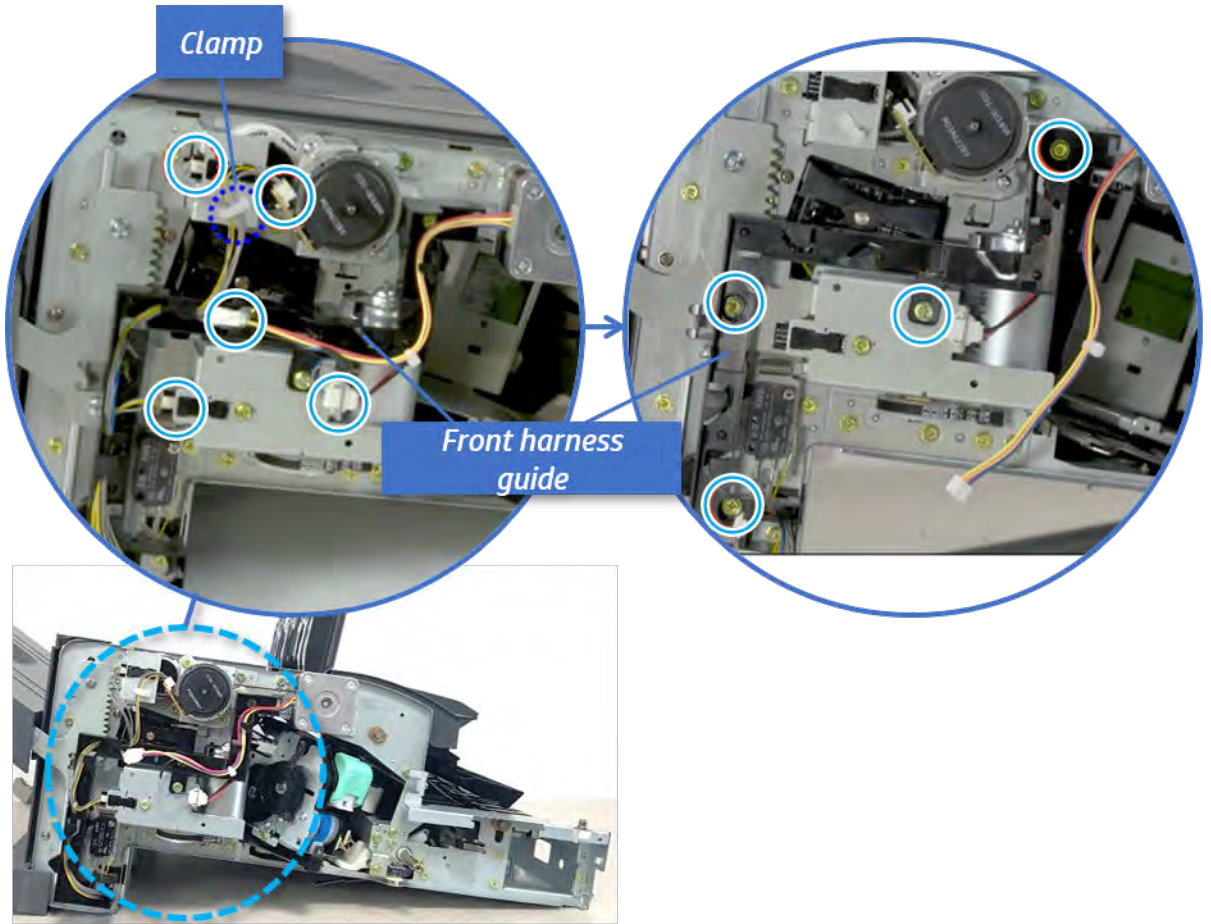
### Remove the front harness guide

Follow these steps to remove the front harness guide.

1. Open one clamp and unplug five connectors, and then remove the wire harness from the front harness guide.

2. Remove four screws, and then remove the front harness guide.

Figure 6-731 Remove the front harness guide

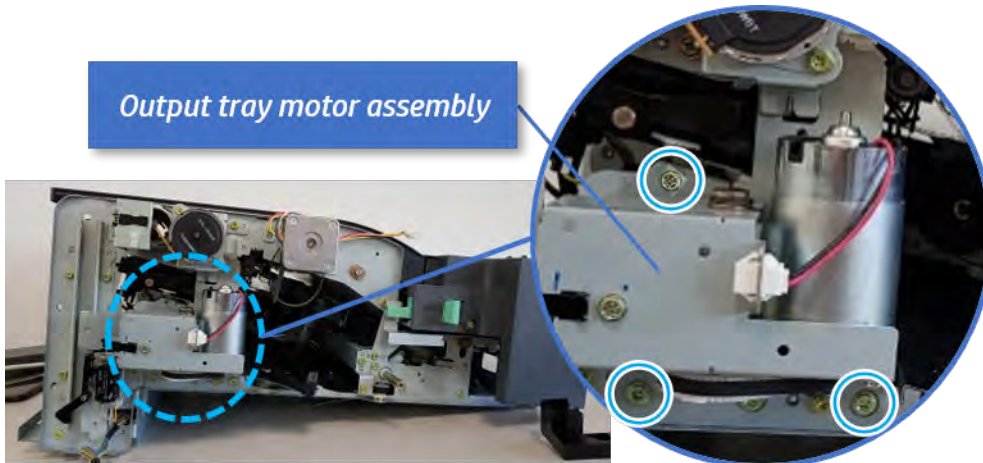


### Remove the output tray motor assembly

Follow these steps to remove the output tray motor assembly.

- ▲ Remove three screws, and then remove the output tray motor assembly.

Figure 6-732 Remove the output tray motor assembly

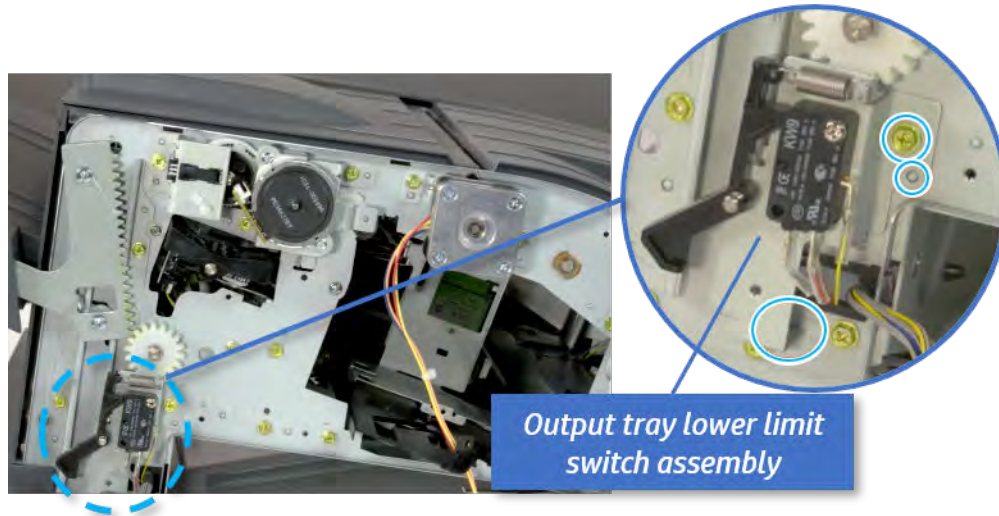


### Remove the output tray lower limit switch

Follow these steps to remove the output tray lower limit switch.

- ▲ Remove one screw, and then remove the output tray lower limit switch.

Figure 6-733 Remove the output tray lower limit switch

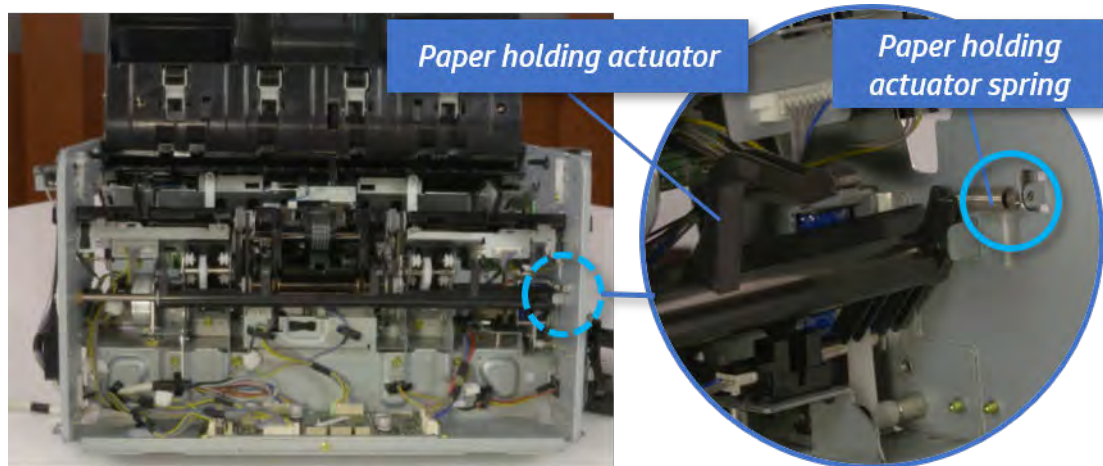


### Remove the paper holding

Follow these steps to remove the paper holding.

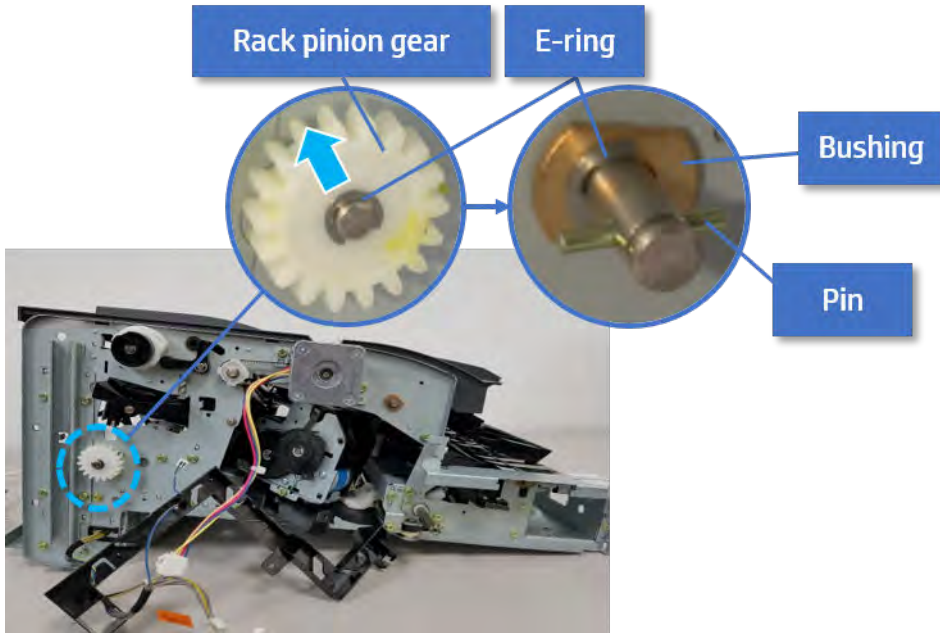
1. Remove the paper holding actuator spring.


Figure 6-734 Remove the paper holding actuator spring



2. Remove the e-ring and the rack pinion gear. And then remove the pin and the e-ring, and then remove the bushing.

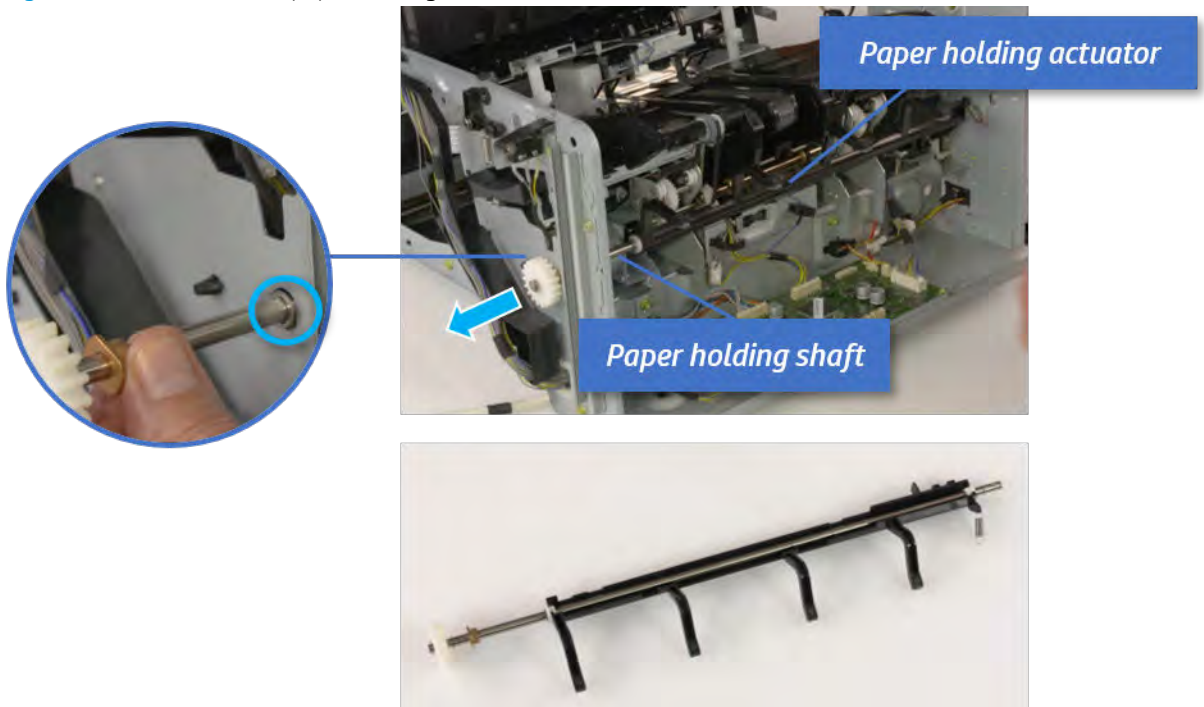
**Figure 6-735** Remove e-ring, rack pinion gear, pin, and bushing



 **NOTE:** Be sure not to lose the pin.

3. Carefully remove the paper holding shaft and the actuator.

**Figure 6-736** Remove the paper holding shaft and the actuator

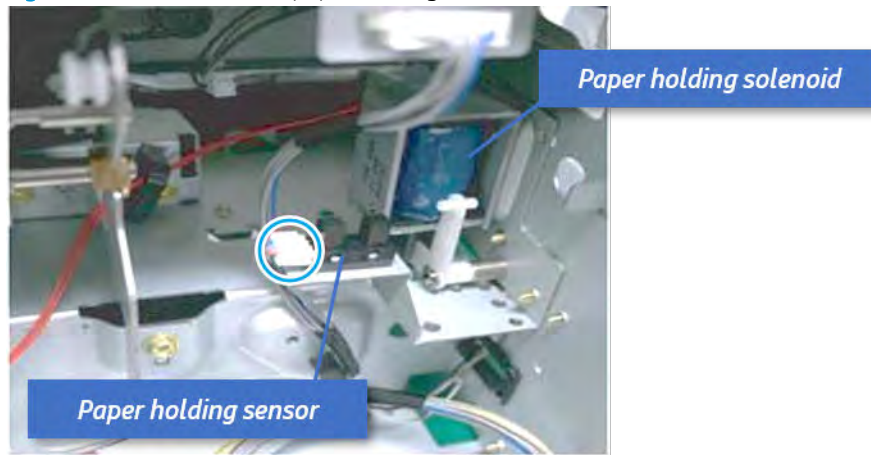


### Remove the paper holding sensor

Follow these steps to remove the paper holding sensor.

1. Unplug the connector.
2. Remove the adhesive strip from below the sensor.
3. Remove the paper holding sensor.

**Figure 6-737** Remove the paper holding sensor



### Unpack the replacement assembly



Follow these steps to unpack the replacement assembly.


1. Dispose of the defective part.


 **NOTE:** HP recommends responsible disposal of the defective part.

<http://www8.hp.com/us/en/hp-information/environment/product-recycling.html>


2. Unpack the replacement part from the packaging.

 **CAUTION:**  Some parts are sensitive to electrostatic discharge (ESD). Always perform service work at an ESD-protected workstation or mat. If an ESD workstation or mat is not available, touch the sheet-metal chassis to provide a static ground before touching an ESD-sensitive assembly. Protect the ESD-sensitive assemblies by placing them in ESD pouches when they are out of the printer.

 **IMPORTANT:** Make sure that all of the shipping materials (for example shipping tape) are removed from the replacement part prior to installation.

 **NOTE:** If the replacement part is a roller or pad, avoid touching the spongy part of it. Skin oils on the roller or pad can cause paper pickup and/or print-quality problems. HP recommends using disposable gloves when handling rollers or pads or washing your hands before touching rollers or pads.

3. To install an assembly, reverse the removal steps.

 **NOTE:** When applicable, special installation instructions are provided for an assembly at the end of the removal procedure. Always completely read the removal instructions and follow all special installation instructions.

## Removal and replacement: Paper holding solenoid (SL1)


Learn how to remove and replace the paper holding solenoid.

To view teardown and reassembling video of the inner finisher, click the link below.

 [View a teardown video of the inner finisher.](#)

 [View a reassembling video of the inner finisher.](#)

---

 **IMPORTANT:** When applicable, special installation instructions are provided for an assembly at the end of the removal procedure. Always completely read the removal instructions and follow all special installation instructions.

---

Mean time to repair:


Service level:

### Before performing service

#### Turn the printer power off

- Press the power button on the front of the printer, and then turn off the power switch next to the power cable.
- A shutting-down message appears on the control-panel display.

---

 **WARNING!** To avoid damage to the printer, turn the power off and wait until the printer shuts down before removing the power cable.

---

- Disconnect the printer power cable after the printer has completely shut down (the control-panel display is blank).

Use the table below to identify the correct part number for your printer. To order the part, go to [www.hp.com/buy/parts](http://www.hp.com/buy/parts).

Table 6-74 Part information

Part number	Part description
JC33-00037A	Paper holding solenoid

### Required tools

- #2 JIS screwdriver with a magnetic tip

### After performing service

#### Turn the printer power on

- Connect the power cable.
- Use the power switch to turn the power on.

### Post service test

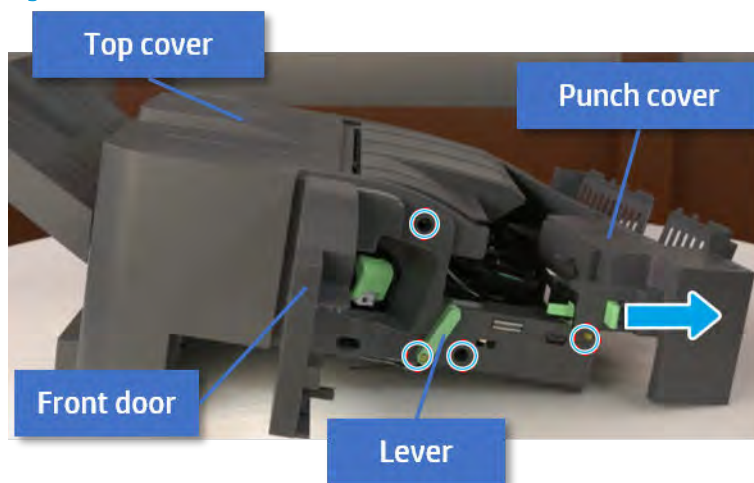
Print any pages necessary to verify that the repair resolved the issue and did not create any new issues.

## Remove the front cover

Follow these steps to remove the front cover:

1. Open the front door and open the punch cover.
2. Remove three screws in the front.
3. Remove the lever.
4. Open the top cover.
5. From the right side of the front cover, carefully lift and pry toward the top-left corner to remove the front cover.

Figure 6-738 Remove the front cover

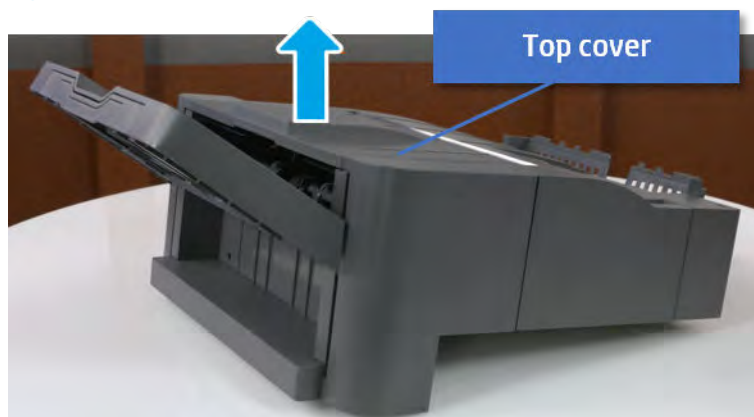


## Remove the rear cover

Follow these steps to remove the rear cover:

1. Open the top cover.

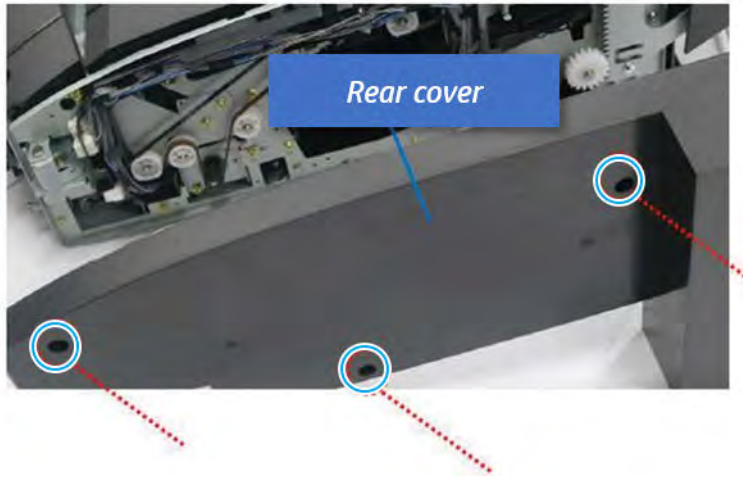
Figure 6-739 Open the top cover



2. Remove three screws.

3. Release hooks carefully and remove the rear cover.

Figure 6-740 Remove the rear cover

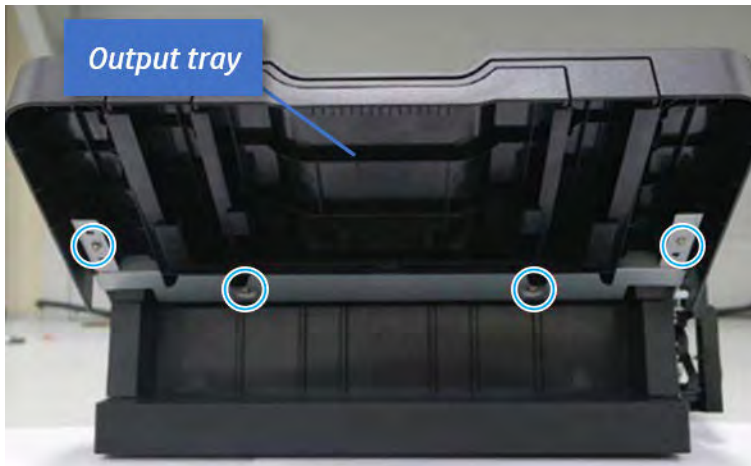


### Remove the output tray

Follow these steps to remove the output tray.

1. Remove four screws.

Figure 6-741 Remove four screws





2. Push the paper holding actuator into the inner finisher, and then remove the output tray.

Figure 6-742 Remove the output tray.

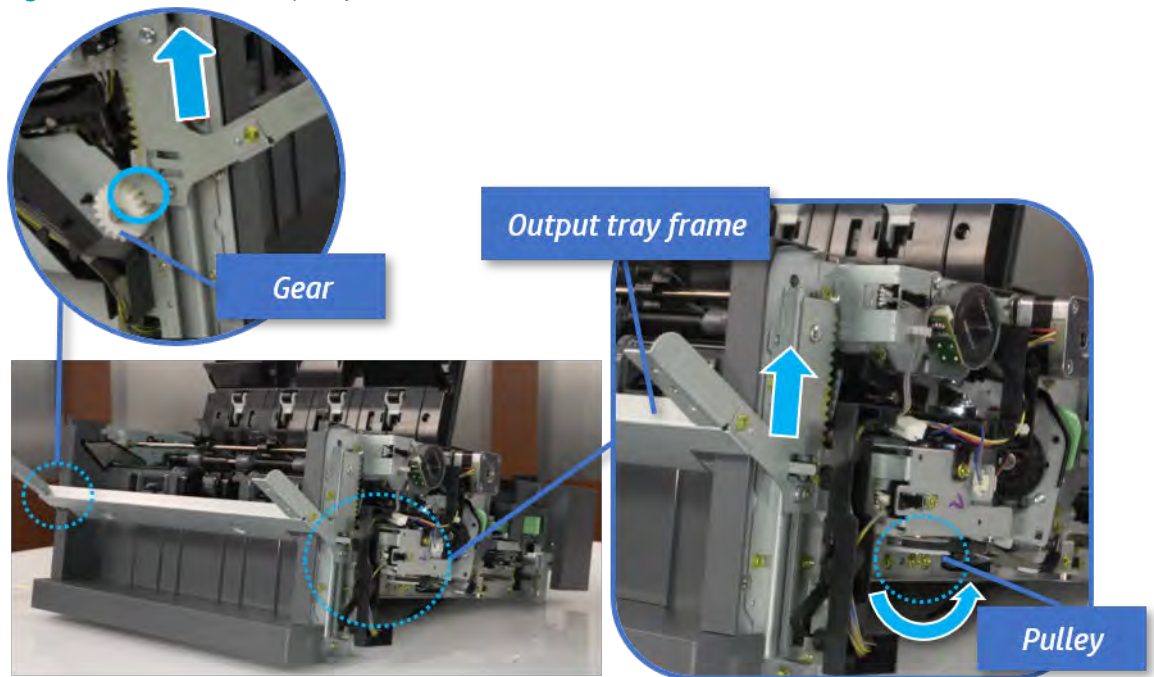


### Remove the output tray frame

Follow these steps to remove the output tray frame.

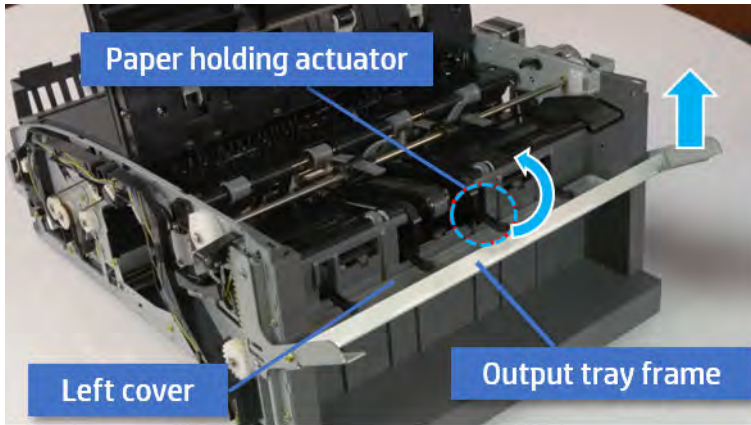
1. Rotate the pulley until the output tray frame depart from the gear.

Figure 6-743 Remove the pulley



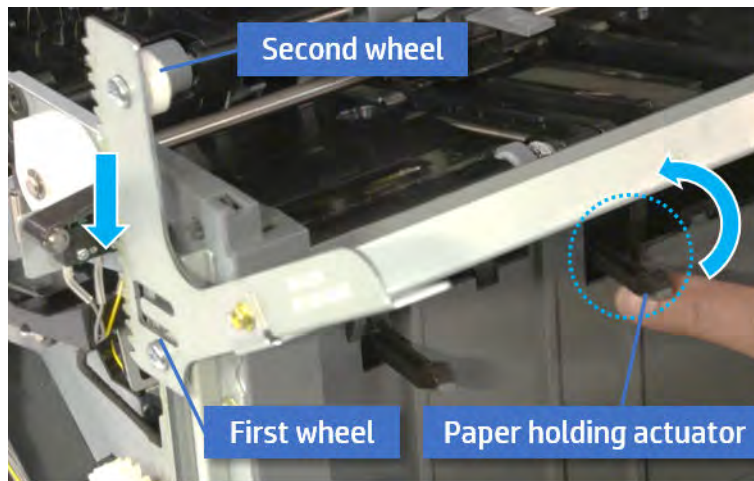
2. Push the paper holding actuator into the inner finisher, and then remove the output tray frame.

Figure 6-744 Remove the output tray frame

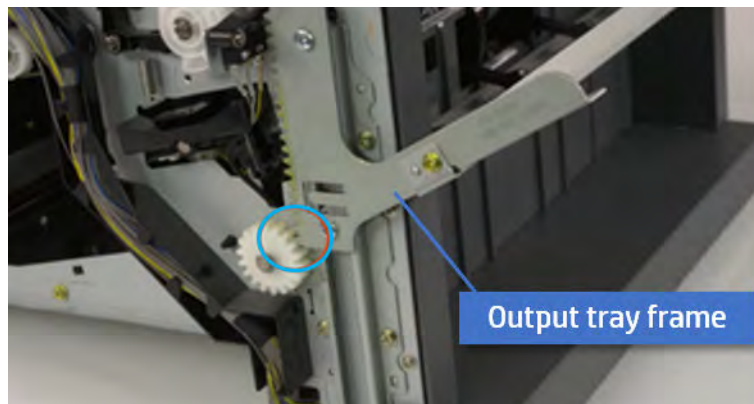


**TIP:** Push the paper holding actuator into the inner finisher when reassembling. Be sure to level the output tray.

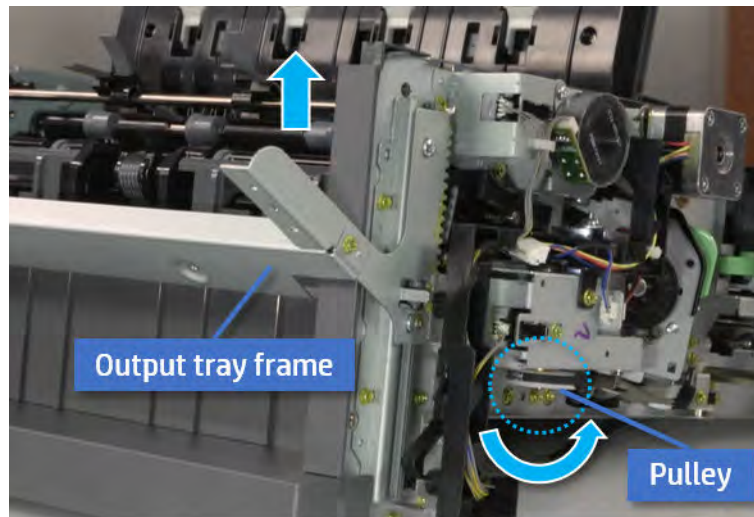
- a. Position the first wheel into the channel on both sides while pushing the paper holding actuator.



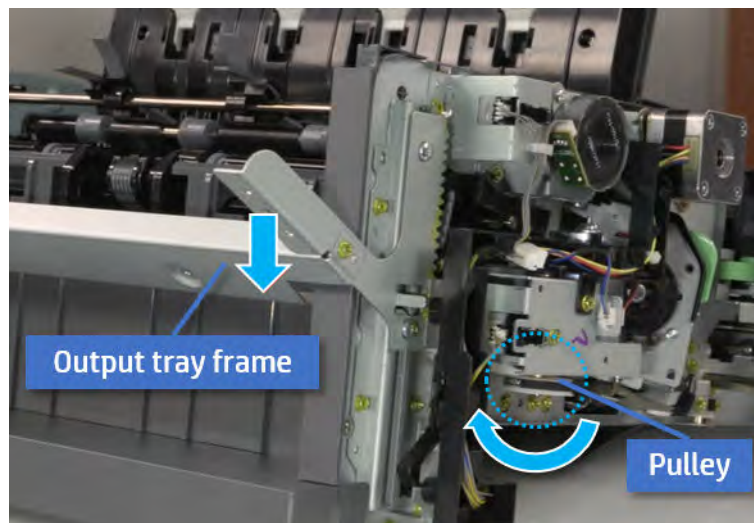
- b. Let the second wheel rest on the channel on both sides simultaneously.
- c. Gently squeeze the wheels into channel until the output tray frame meet the gear.



- d. Rotate the pulley until the output tray frame is no longer lifted. It can make to level the output tray frame.



- e. Rotate the pulley in the opposite direction.

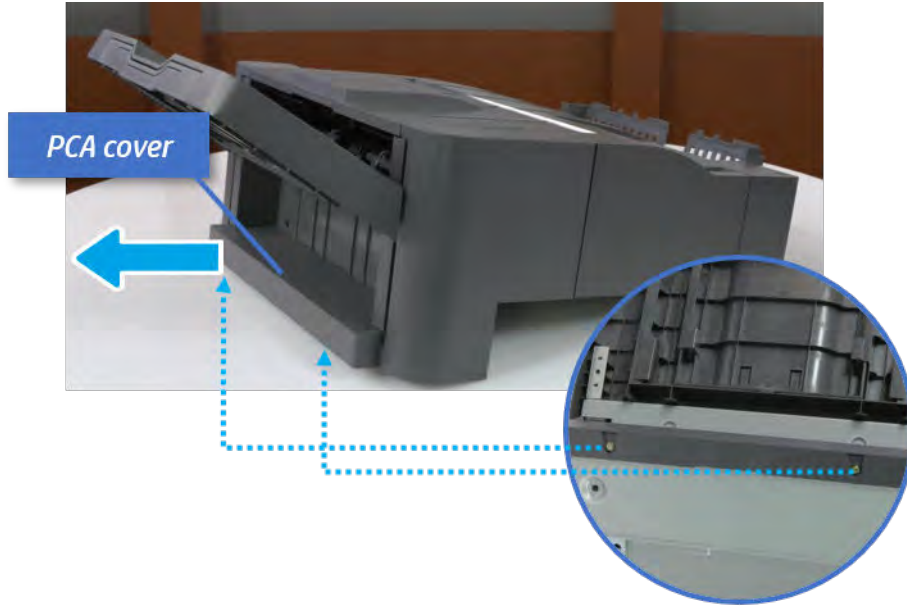


### Remove the PCA cover

Follow these steps to remove the PCA cover.

- ▲ Remove two screws, and then remove the PCA cover.

Figure 6-745 Remove the PCA cover

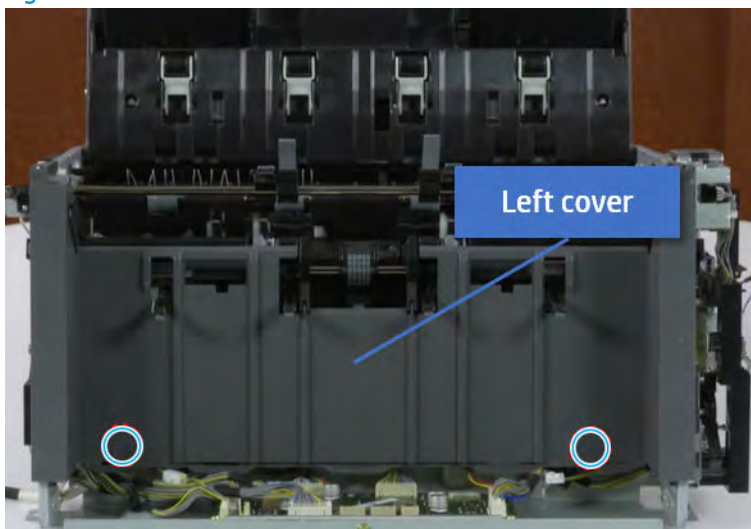


### Remove the left cover

Follow these steps to remove the left cover.

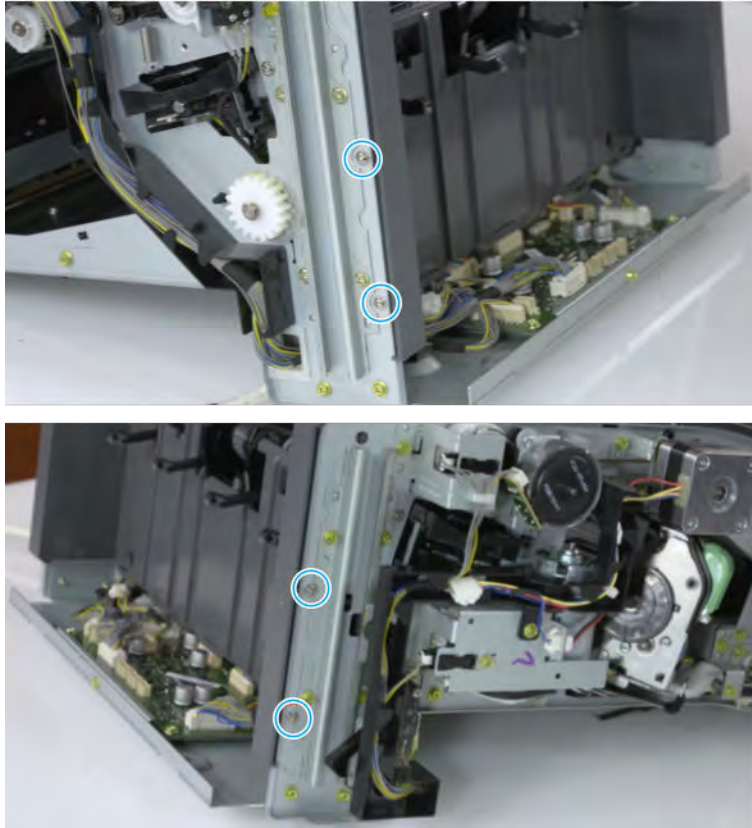
1. Remove two screws.

Figure 6-746 Remove two screws



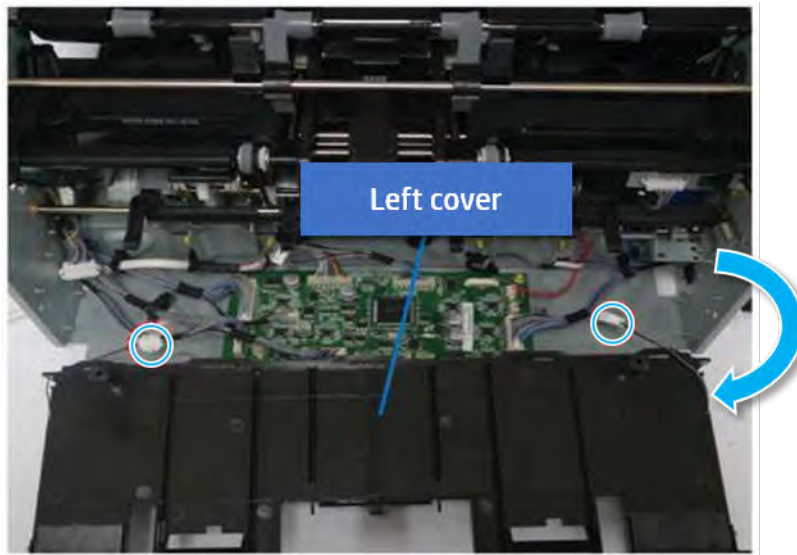
2. Remove four screws from both front and rear sides.


Figure 6-747 Remove four screws

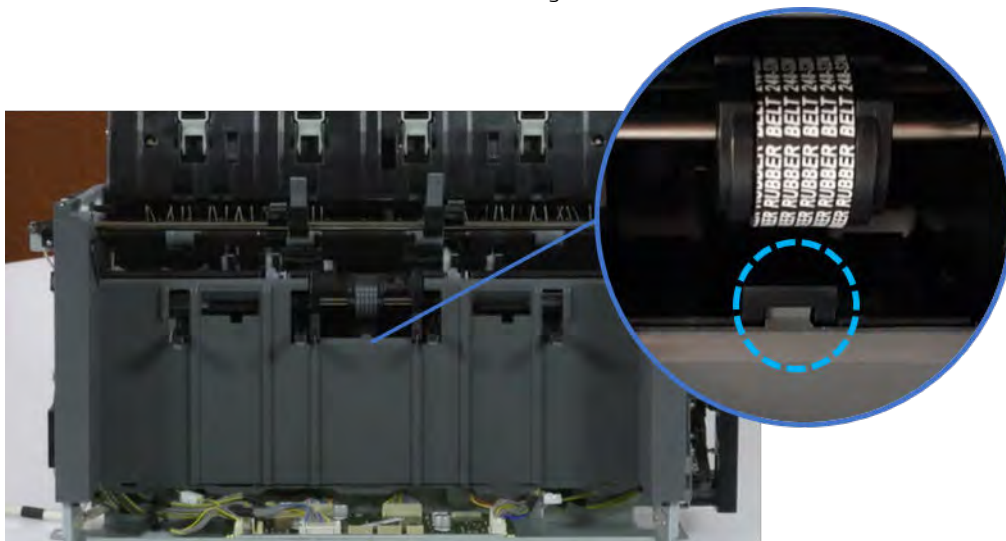


3. Unplug two inline connectors, and then remove the left cover.

Figure 6-748 Unplug two connectors



 **TIP:** Be sure to check the hook when reassembling.



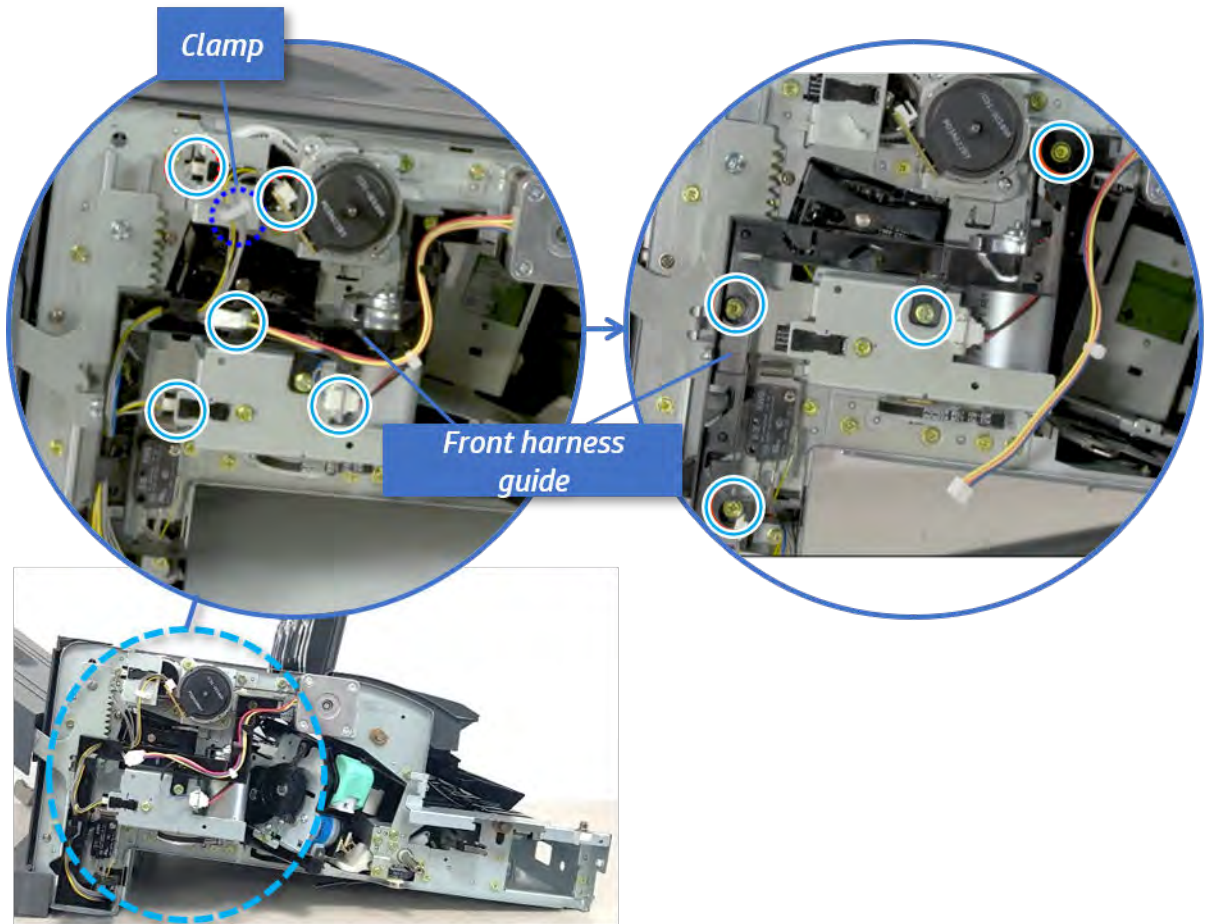
### Remove the front harness guide

Follow these steps to remove the front harness guide.

1. Open one clamp and unplug five connectors, and then remove the wire harness from the front harness guide.

2. Remove four screws, and then remove the front harness guide.

Figure 6-749 Remove the front harness guide

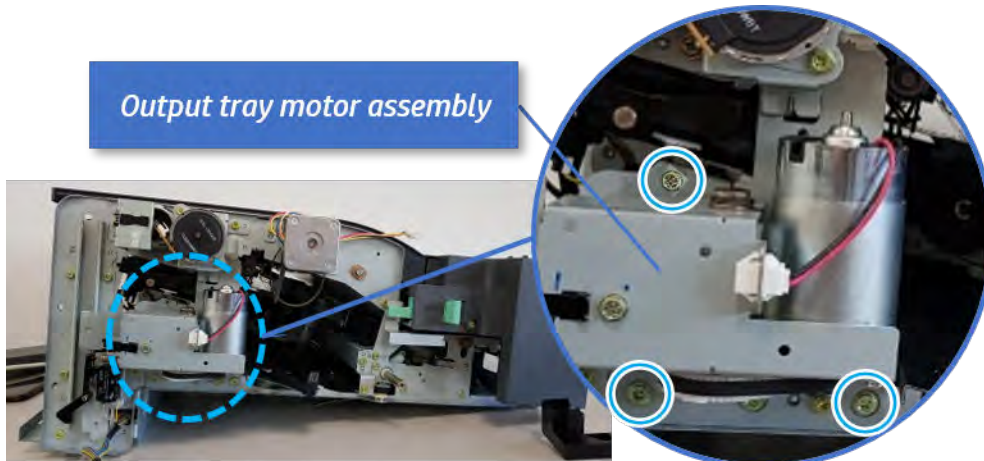


### Remove the output tray motor assembly

Follow these steps to remove the output tray motor assembly.

- ▲ Remove three screws, and then remove the output tray motor assembly.

Figure 6-750 Remove the output tray motor assembly

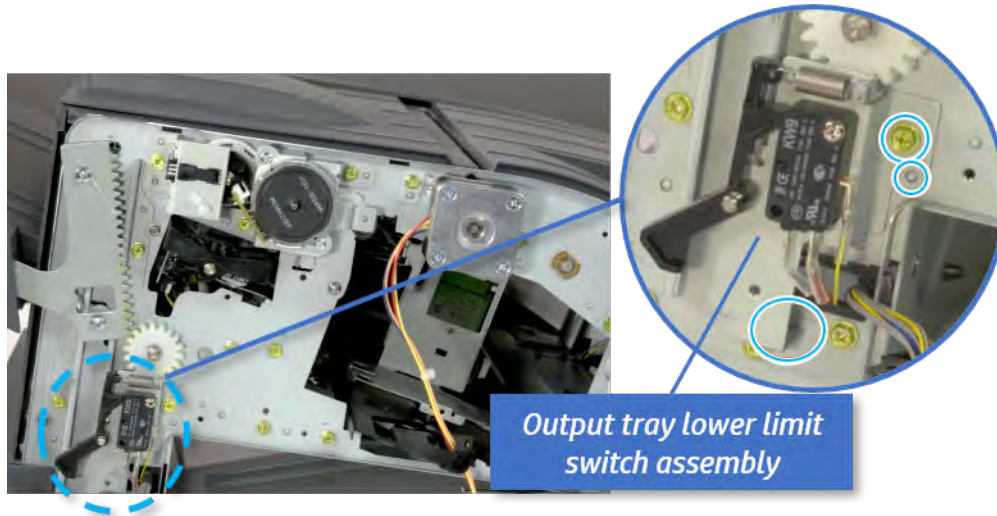


## Remove the output tray lower limit switch

Follow these steps to remove the output tray lower limit switch.

- ▲ Remove one screw, and then remove the output tray lower limit switch.

**Figure 6-751** Remove the output tray lower limit switch

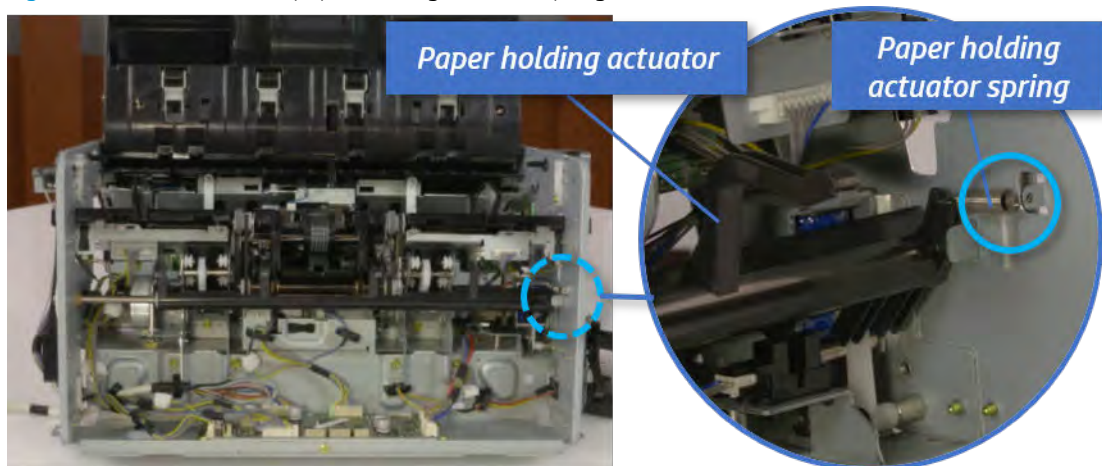


## Remove the paper holding

Follow these steps to remove the paper holding.

1. Remove the paper holding actuator spring.

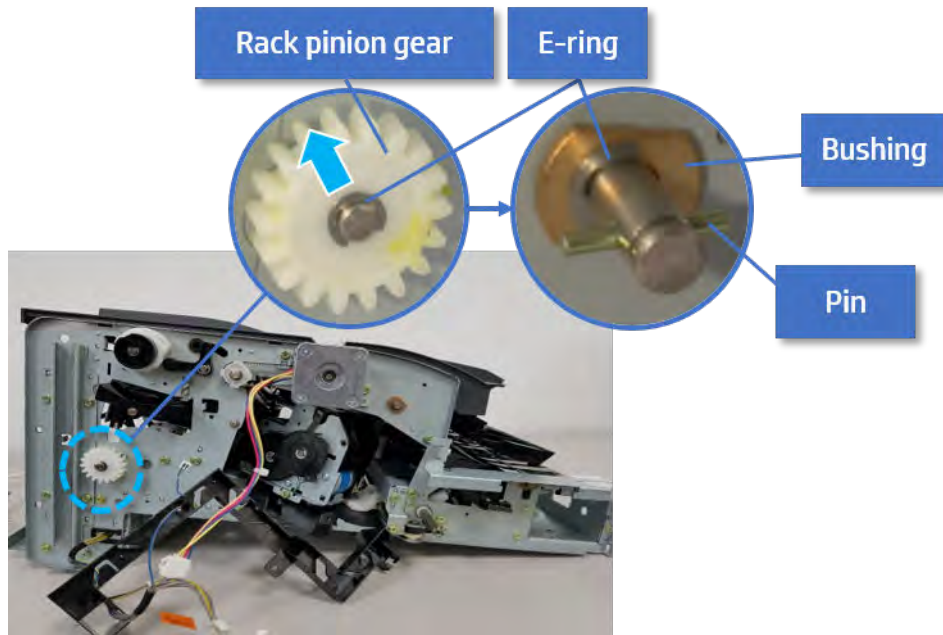
**Figure 6-752** Remove the paper holding actuator spring






2. Remove the e-ring and the rack pinion gear. And then remove the pin and the e-ring, and then remove the bushing.

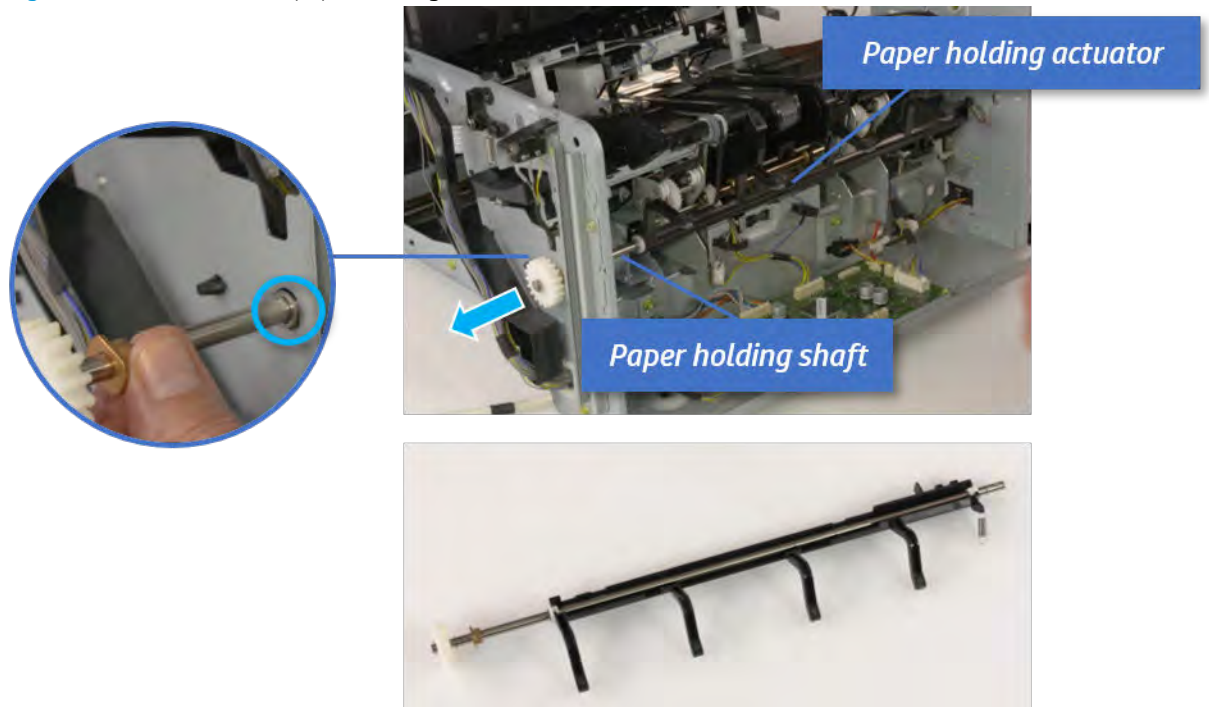
**Figure 6-753** Remove e-ring, rack pinion gear, pin, and bushing



 **NOTE:** Be sure not to lose the pin.

3. Carefully remove the paper holding shaft and the actuator.

**Figure 6-754** Remove the paper holding shaft and the actuator

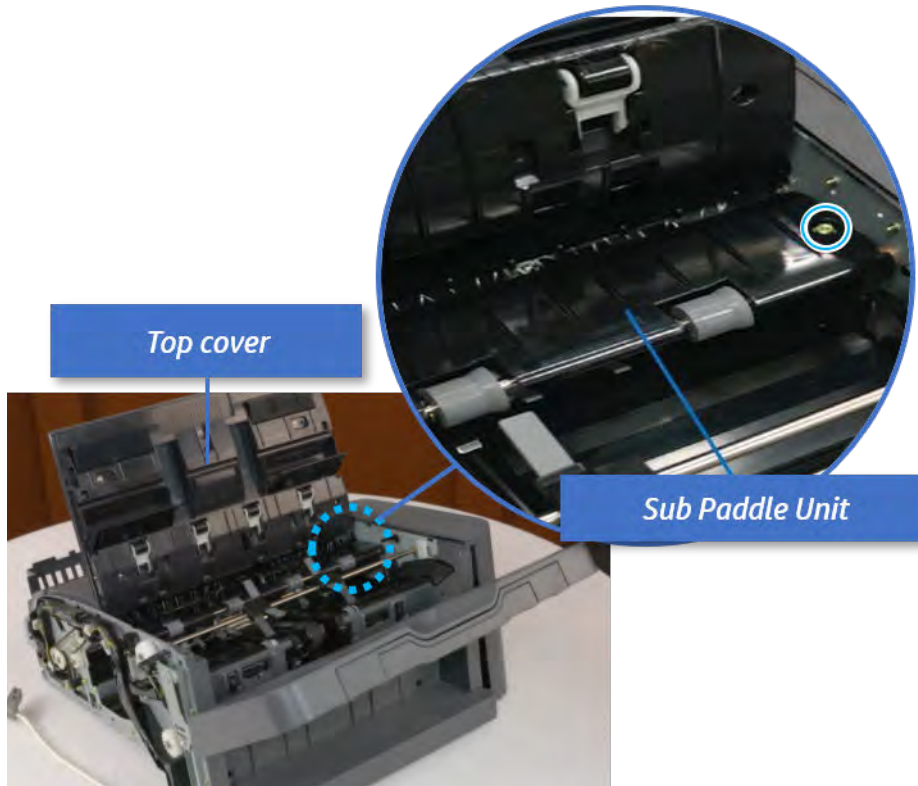


### Remove the sub paddle unit

Follow these steps to remove the sub paddle unit.

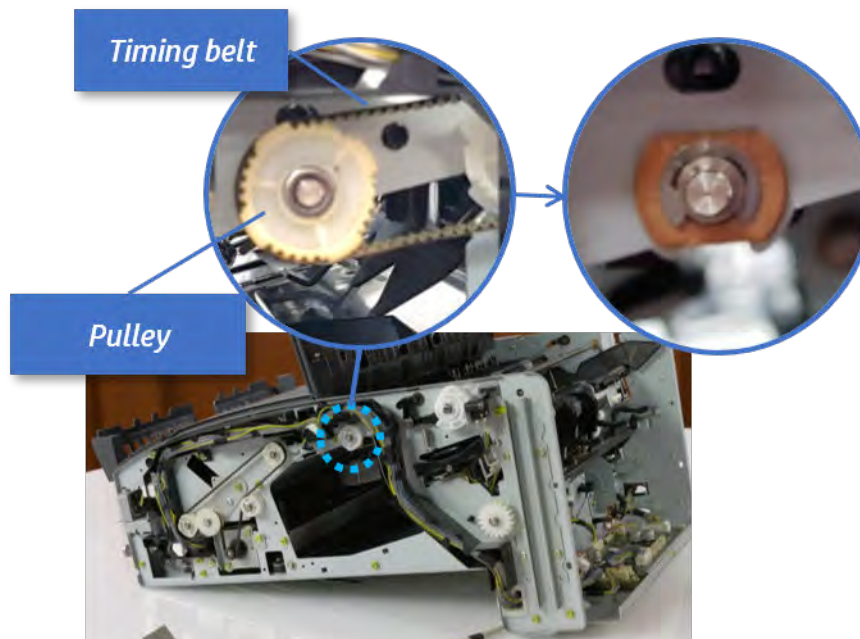
1. Open the top cover, and then remove one screw securing the sub paddle unit.

Figure 6-755 Remove one screw



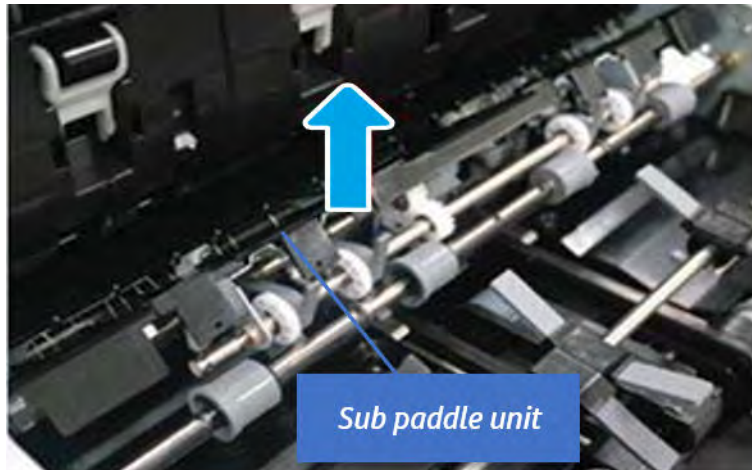
2. Remove the e-ring, and then remove the pulley and timing belt. And then remove the e-ring and the bushing.

Figure 6-756 Remove the e-ring, pulley, timing belt, and bushing



3. Lift up and remove the sub paddle unit.

**Figure 6-757** Remove the sub paddle unit

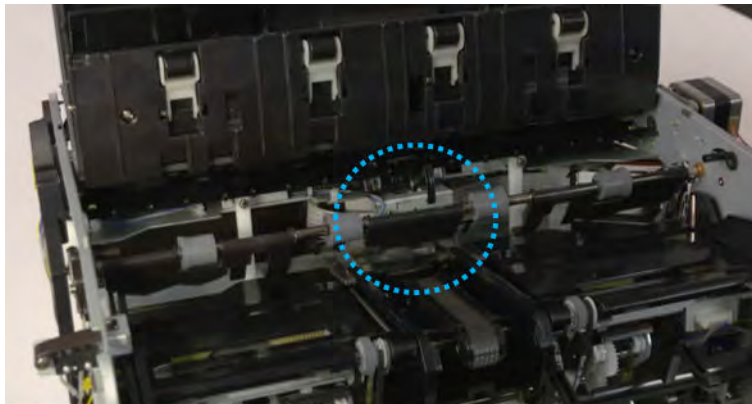


### Remove the exit roller

Follow these steps to remove the exit roller.

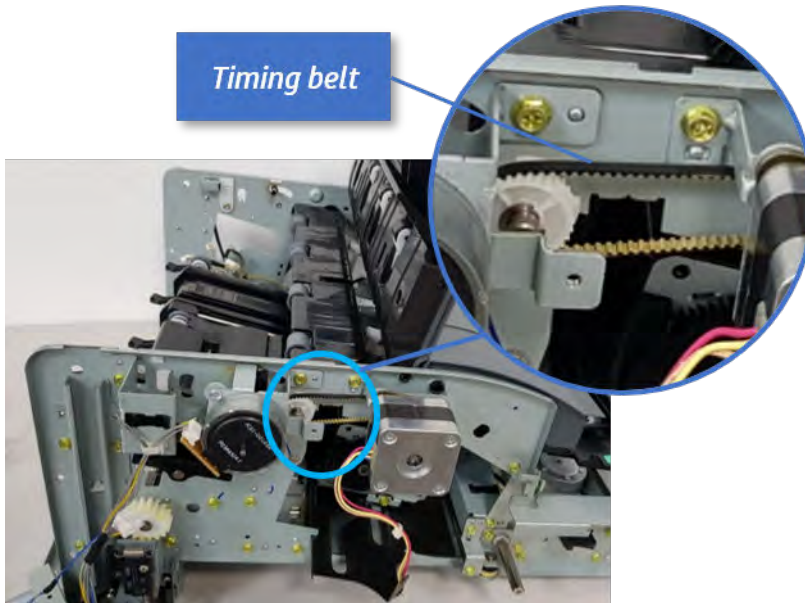
1. Remove the guide on the center of the exit roller.

**Figure 6-758** Remove the guide



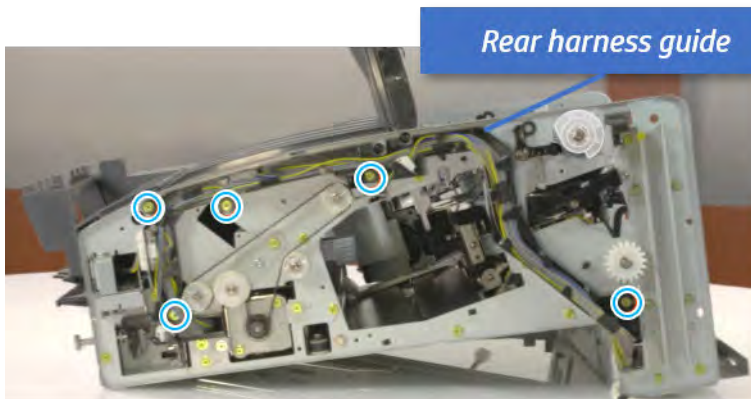
2. On the front of the inner finisher, release the timing belt connected to the exit motor.

Figure 6-759 Release the timing belt



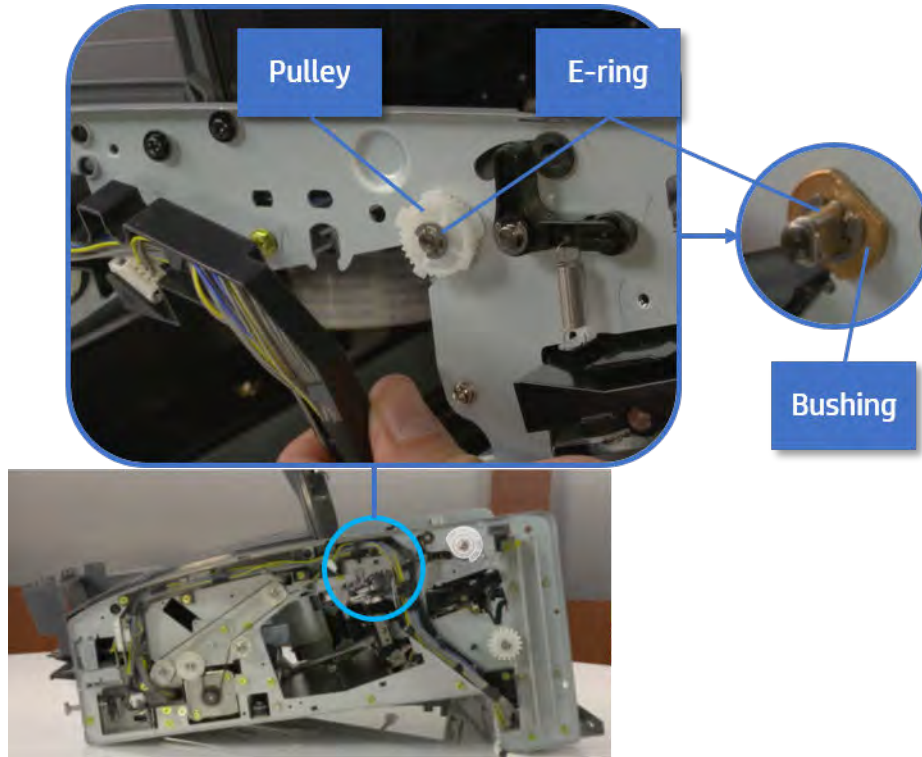
3. Remove five screws securing the rear harness guide.

Figure 6-760 Remove five screws



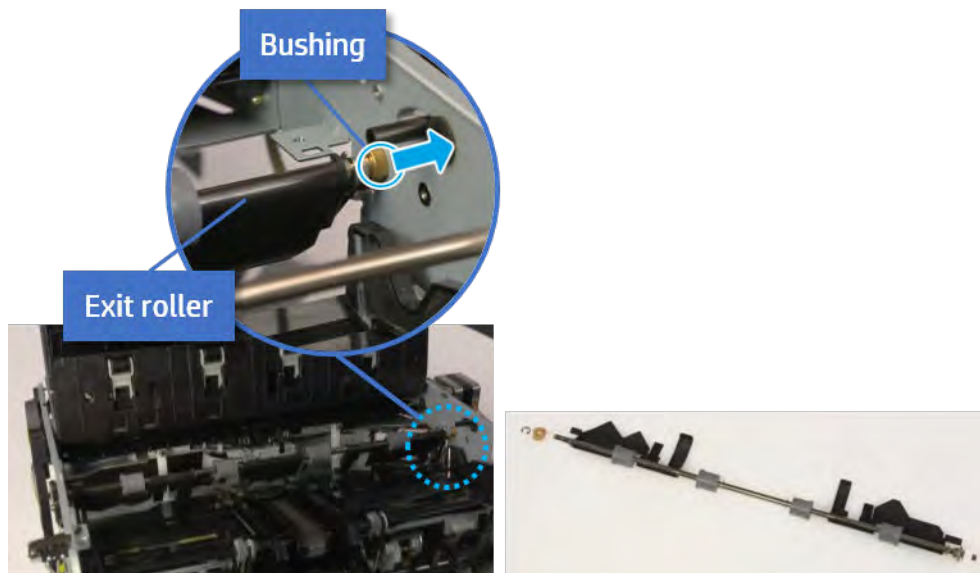
4. On the rear of the inner finisher, remove the e-ring and the pulley and then remove the e-ring and the bushing.

Figure 6-761 Remove e-ring, pulley, and bushing



5. Push the bushing to detach it, and then remove the exit roller.

Figure 6-762 Remove the exit roller

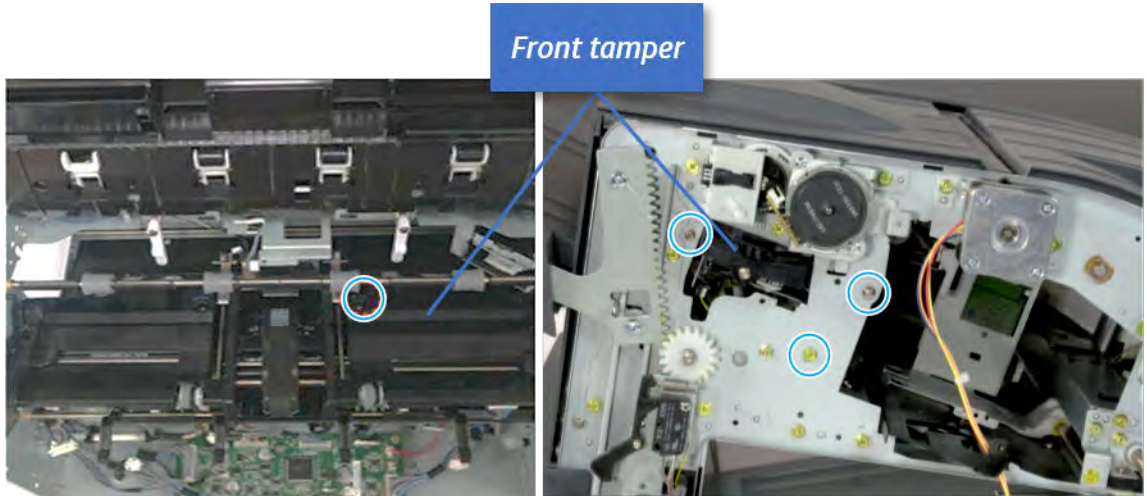


### Remove the front tamper

Follow these steps to remove the front tamper.

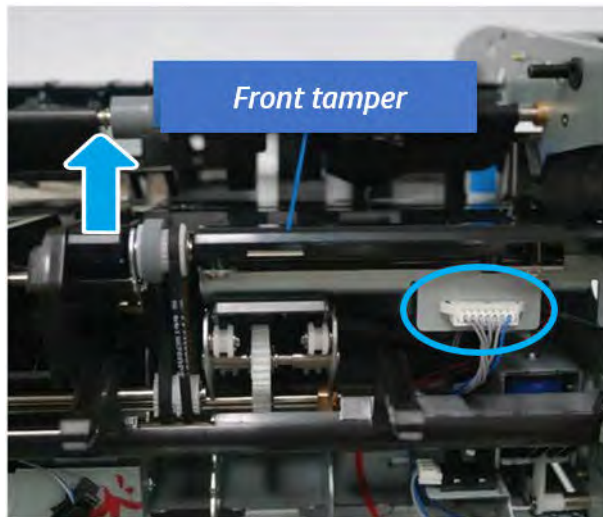
1. Remove four screws.

Figure 6-763 Remove four screws



2. Unplug the connector and release the hook, and then pull the front tamper up to remove.

Figure 6-764 Remove the front tamper

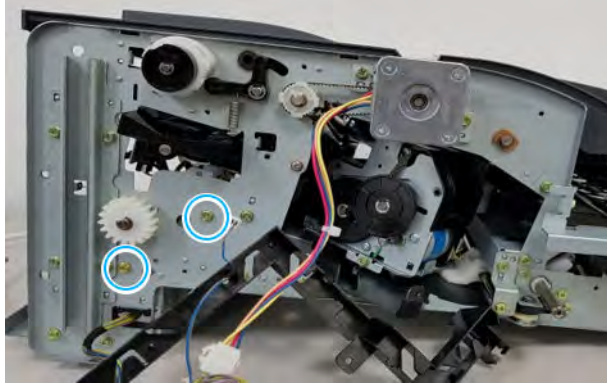


### Remove the paper holding solenoid

Follow these steps to remove the paper holding solenoid.

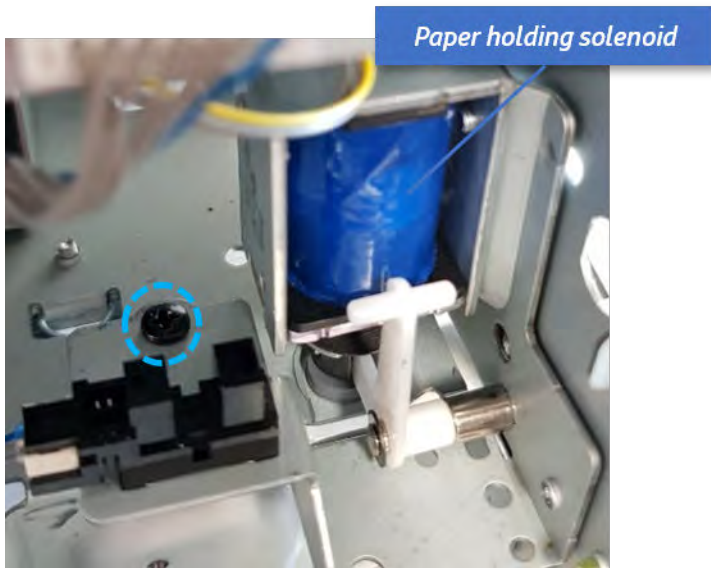
1. Remove two screws at the front of the inner finisher.

Figure 6-765 Remove two screws



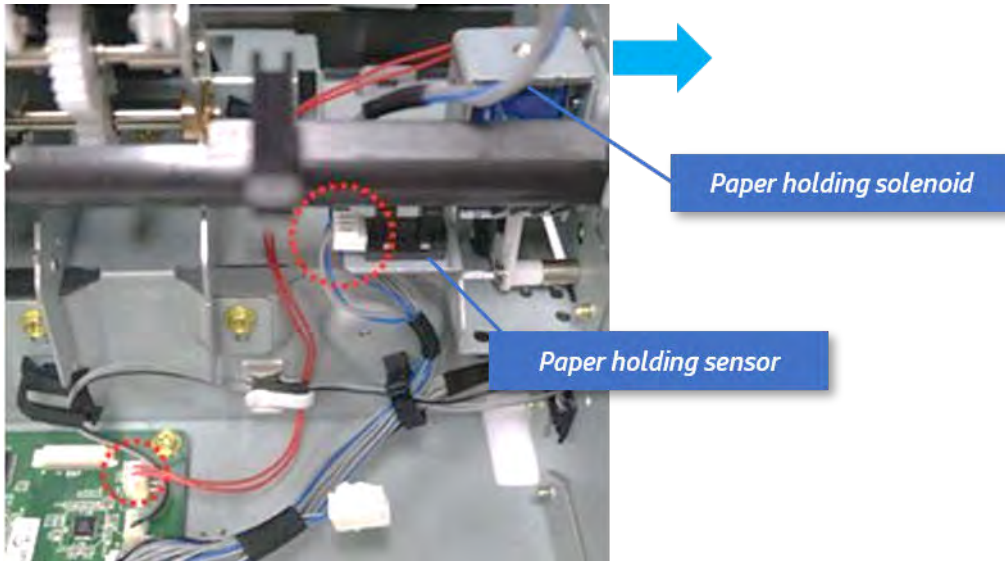
2. Remove one screw.

Figure 6-766 Remove one screw



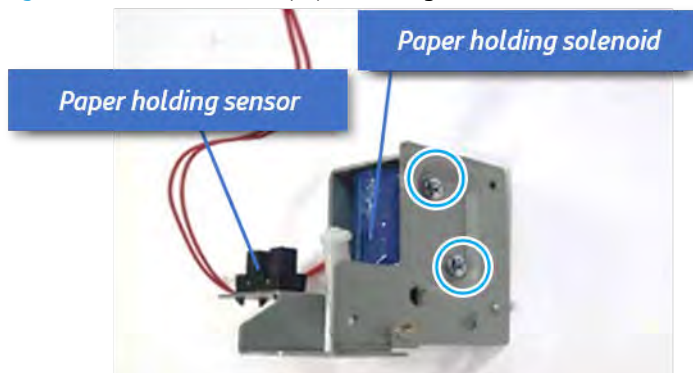
3. Disconnect two connectors and remove the solenoid assembly.

**Figure 6-767** Remove the solenoid assembly



4. Remove two screws, and then release the solenoid from the bracket.

**Figure 6-768** Remove the paper holding solenoid



### Unpack the replacement assembly

Follow these steps to unpack the replacement assembly.

1. Dispose of the defective part.





---

 **NOTE:** HP recommends responsible disposal of the defective part.


<http://www8.hp.com/us/en/hp-information/environment/product-recycling.html>

---

2. Unpack the replacement part from the packaging.


 **CAUTION:**  Some parts are sensitive to electrostatic discharge (ESD). Always perform service work at an ESD-protected workstation or mat. If an ESD workstation or mat is not available, touch the sheet-metal chassis to provide a static ground before touching an ESD-sensitive assembly. Protect the ESD-sensitive assemblies by placing them in ESD pouches when they are out of the printer.

 **IMPORTANT:** Make sure that all of the shipping materials (for example shipping tape) are removed from the replacement part prior to installation.

 **NOTE:** If the replacement part is a roller or pad, avoid touching the spongy part of it. Skin oils on the roller or pad can cause paper pickup and/or print-quality problems. HP recommends using disposable gloves when handling rollers or pads or washing your hands before touching rollers or pads.

---

3. To install an assembly, reverse the removal steps.

 **NOTE:** When applicable, special installation instructions are provided for an assembly at the end of the removal procedure. Always completely read the removal instructions and follow all special installation instructions.

---

## Punch unit


## Removal and replacement: Punch cover

Learn how to remove and replace the punch cover.

To view teardown and reassembling video of the inner finisher, click the link below.

 [View a teardown video of the inner finisher.](#)

 [View a reassembling video of the inner finisher.](#)

 **IMPORTANT:** When applicable, special installation instructions are provided for an assembly at the end of the removal procedure. Always completely read the removal instructions and follow all special installation instructions.


Mean time to repair:

Service level:

### Before performing service

#### Turn the printer power off

- Press the power button on the front of the printer, and then turn off the power switch next to the power cable.
- A shutting-down message appears on the control-panel display.

 **WARNING!** To avoid damage to the printer, turn the power off and wait until the printer shuts down before removing the power cable.

- Disconnect the printer power cable after the printer has completely shut down (the control-panel display is blank).

Use the table below to identify the correct part number for your printer. To order the part, go to <http://www.hp.com/buy/parts>.

Table 6-75 Part information

Part number	Part description
JC90-01343B	Punch cover

### Required tools

- #2 JIS screwdriver with a magnetic tip

### After performing service

#### Turn the printer power on

- Connect the power cable.
- Use the power switch to turn the power on.

### Post service test

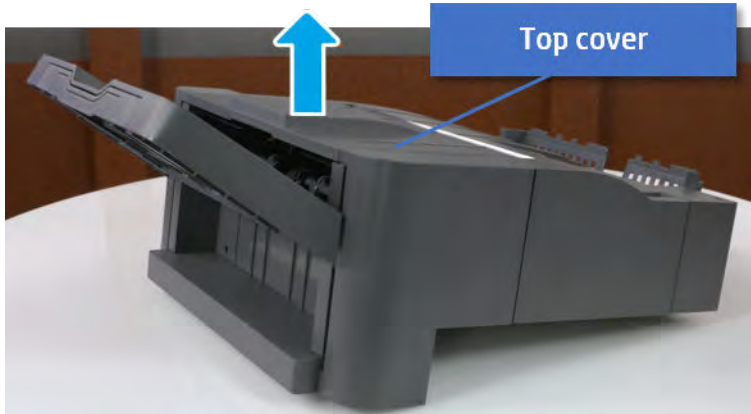
Print any pages necessary to verify that the repair resolved the issue and did not create any new issues.

## Remove the rear cover

Follow these steps to remove the rear cover.

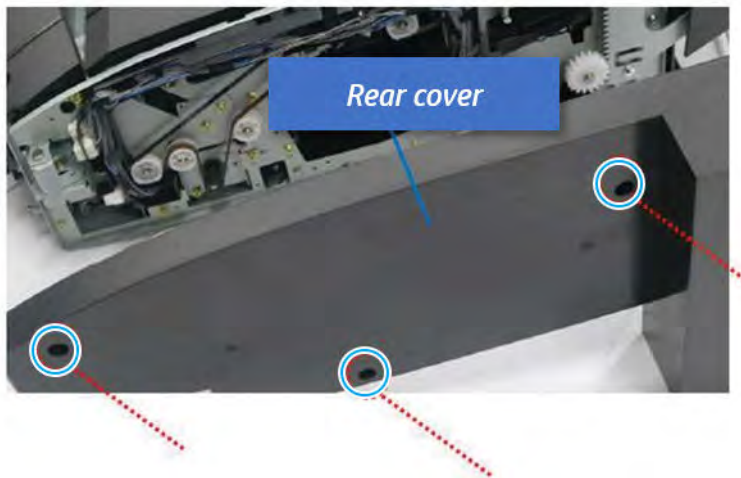
1. Open the top cover.

Figure 6-769 Open the top cover



2. Remove three screws.
3. Release hooks carefully and remove the rear cover.

Figure 6-770 Remove the rear cover

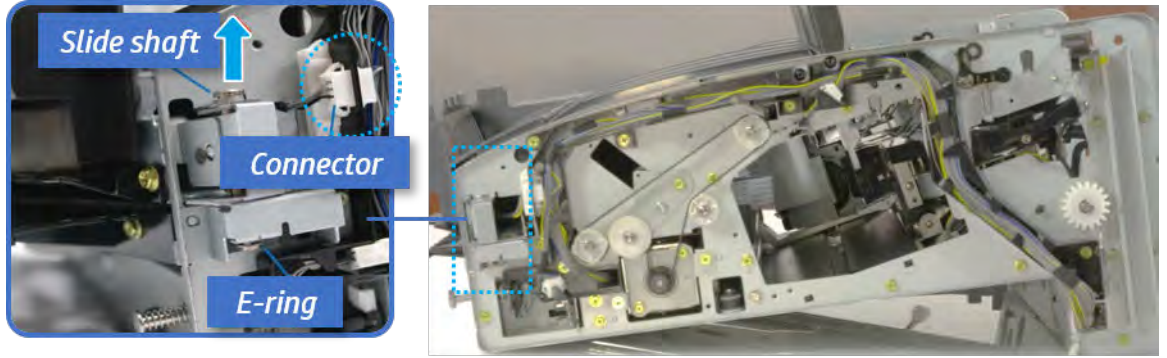


## Remove the punch cover

Follow these steps to remove the punch cover.

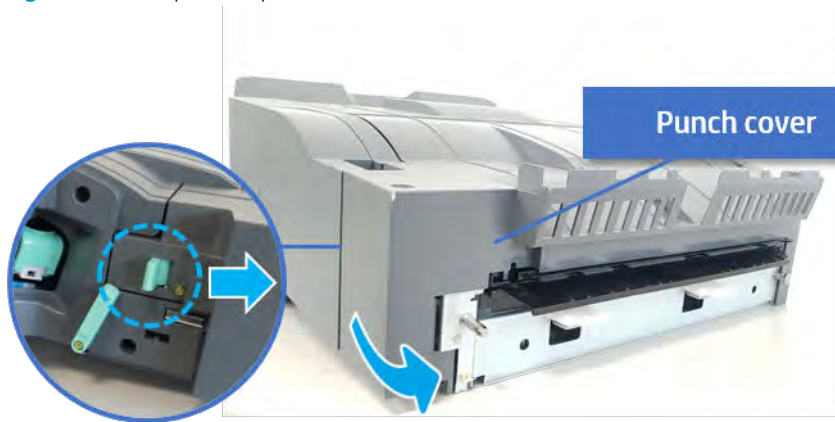
1. Unplug the connector. Remove the e-ring, and then remove the slide shaft at the rear of the inner finisher.

Figure 6-771 Remove the slide shaft



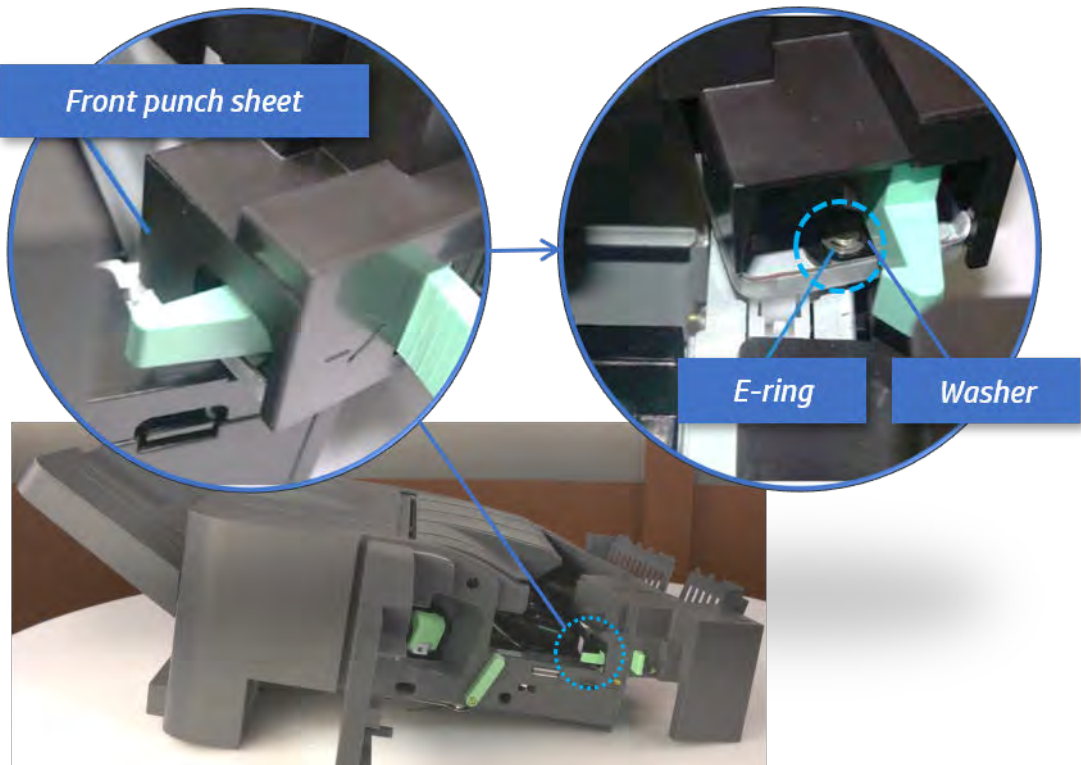
2. Open the punch cover.

Figure 6-772 Open the punch cover



3. Remove the front punch sheet, and then remove the e-ring and the washer. And then remove the punch cover.

Figure 6-773 Remove the punch cover



### Unpack the replacement assembly



Follow these steps to unpack the replacement assembly.


1. Dispose of the defective part.


 **NOTE:** HP recommends responsible disposal of the defective part.

<http://www8.hp.com/us/en/hp-information/environment/product-recycling.html>

2. Unpack the replacement part from the packaging.

 **CAUTION:**  Some parts are sensitive to electrostatic discharge (ESD). Always perform service work at an ESD-protected workstation or mat. If an ESD workstation or mat is not available, touch the sheet-metal chassis to provide a static ground before touching an ESD-sensitive assembly. Protect the ESD-sensitive assemblies by placing them in ESD pouches when they are out of the printer.

 **IMPORTANT:** Make sure that all of the shipping materials (for example shipping tape) are removed from the replacement part prior to installation.

 **NOTE:** If the replacement part is a roller or pad, avoid touching the spongy part of it. Skin oils on the roller or pad can cause paper pickup and/or print-quality problems. HP recommends using disposable gloves when handling rollers or pads or washing your hands before touching rollers or pads.

3. To install an assembly, reverse the removal steps.



---

**NOTE:** When applicable, special installation instructions are provided for an assembly at the end of the removal procedure. Always completely read the removal instructions and follow all special installation instructions.

---

## Removal and replacement: Punch waste full sensor (S19)


Learn how to remove and replace the punch waste full sensor.

To view teardown and reassembling video of the inner finisher, click the link below.

 [View a teardown video of the inner finisher.](#)

 [View a reassembling video of the inner finisher.](#)

---

 **IMPORTANT:** When applicable, special installation instructions are provided for an assembly at the end of the removal procedure. Always completely read the removal instructions and follow all special installation instructions.

---

Mean time to repair:


Service level:

### Before performing service

#### Turn the printer power off

- Press the power button on the front of the printer, and then turn off the power switch next to the power cable.
- A shutting-down message appears on the control-panel display.

---

 **WARNING!** To avoid damage to the printer, turn the power off and wait until the printer shuts down before removing the power cable.

---

- Disconnect the printer power cable after the printer has completely shut down (the control-panel display is blank).

Use the table below to identify the correct part number for your printer. To order the part, go to [www.hp.com/buy/parts](http://www.hp.com/buy/parts).

Table 6-76 Part information

Part number	Part description
0604-001381	Punch waste full sensor

### Required tools

- #2 JIS screwdriver with a magnetic tip

### After performing service

#### Turn the printer power on

- Connect the power cable.
- Use the power switch to turn the power on.

### Post service test

Print any pages necessary to verify that the repair resolved the issue and did not create any new issues.

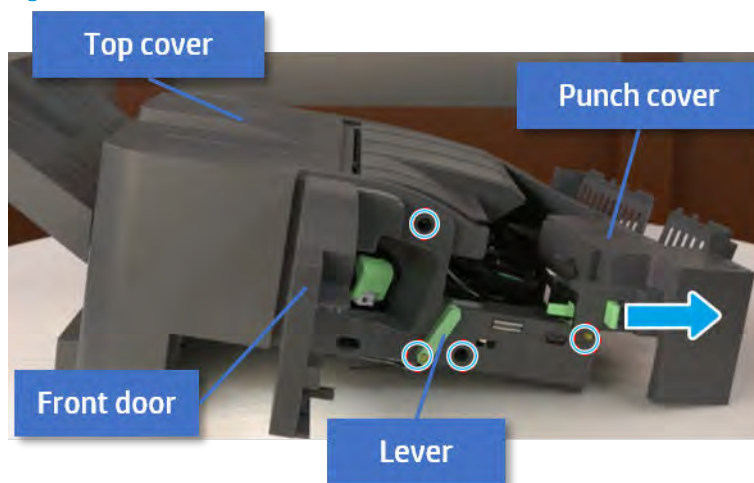


## Remove the front cover

Follow these steps to remove the front cover:

1. Open the front door and open the punch cover.
2. Remove three screws in the front.
3. Remove the lever.
4. Open the top cover.
5. From the right side of the front cover, carefully lift and pry toward the top-left corner to remove the front cover.

Figure 6-774 Remove the front cover

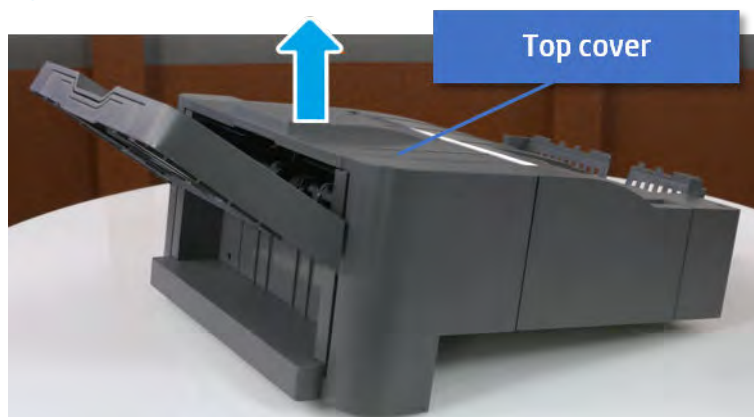


## Remove the rear cover

Follow these steps to remove the rear cover:

1. Open the top cover.

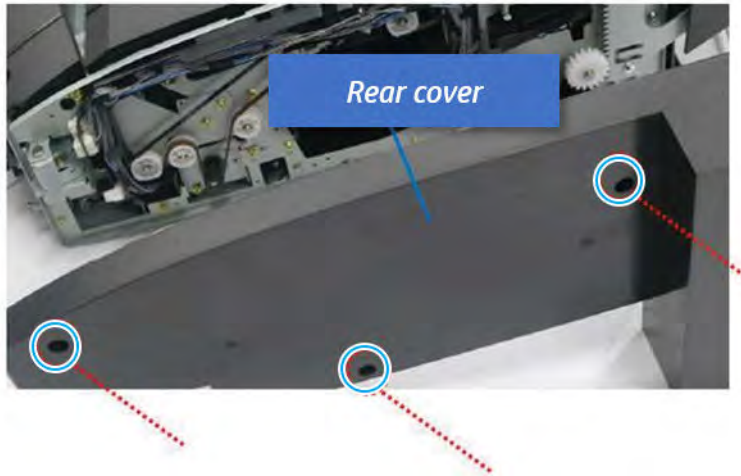
Figure 6-775 Open the top cover



2. Remove three screws.

3. Release hooks carefully and remove the rear cover.

Figure 6-776 Remove the rear cover



### Remove the middle cover

Follow these steps to remove the middle cover.

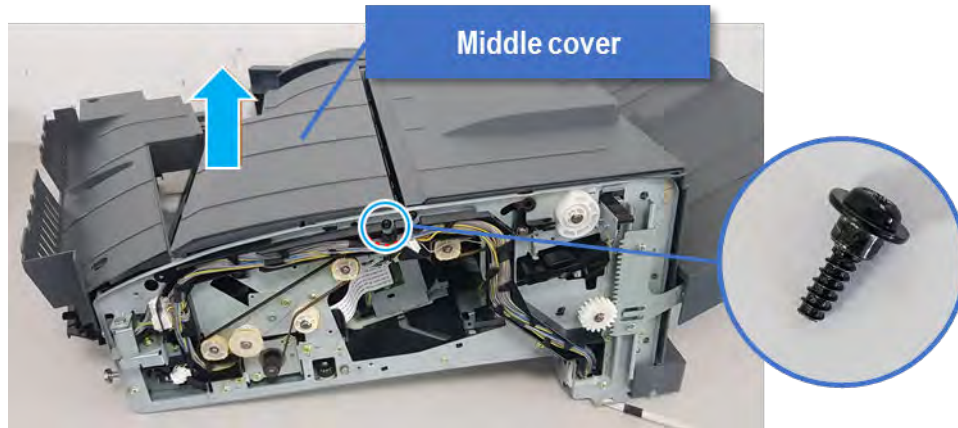
1. Open the front door and then open the punch cover.

Figure 6-777 Open the front door and punch cover



2. Remove left-side one screw at the rear of the inner finisher, and then remove the middle cover by lifting off the hinge pins at the front.

Figure 6-778 Remove the middle cover

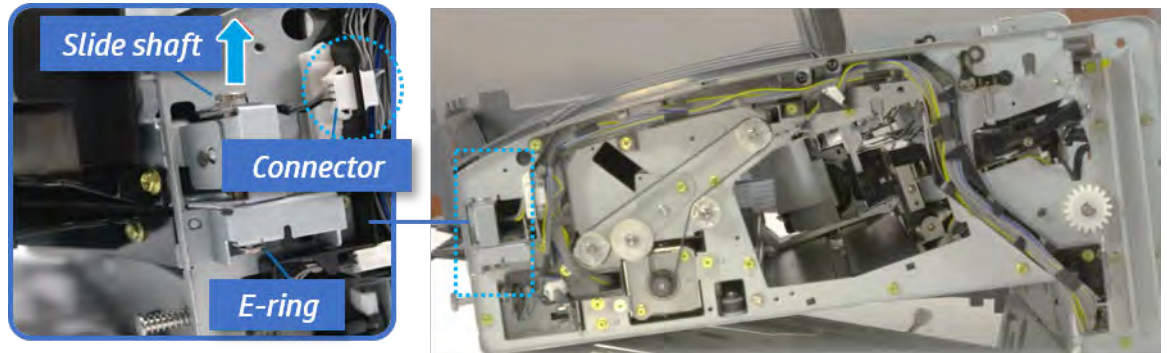


### Remove the punch cover

Follow these steps to remove the punch cover.

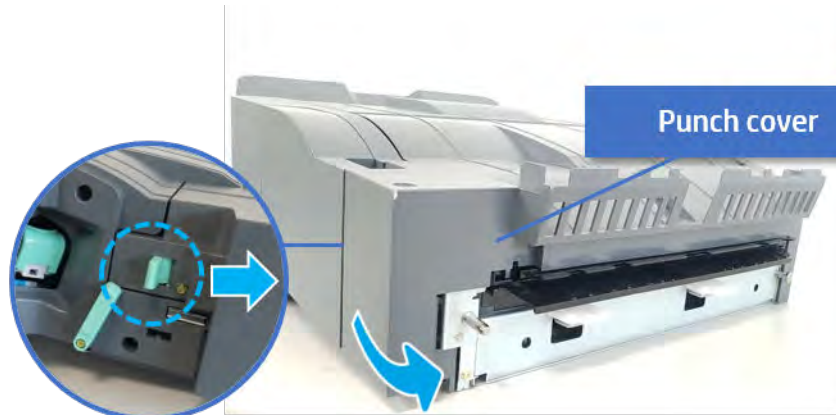
1. Unplug the connector. Remove the e-ring, and then remove the slide shaft at the rear of the inner finisher.

Figure 6-779 Remove the slide shaft



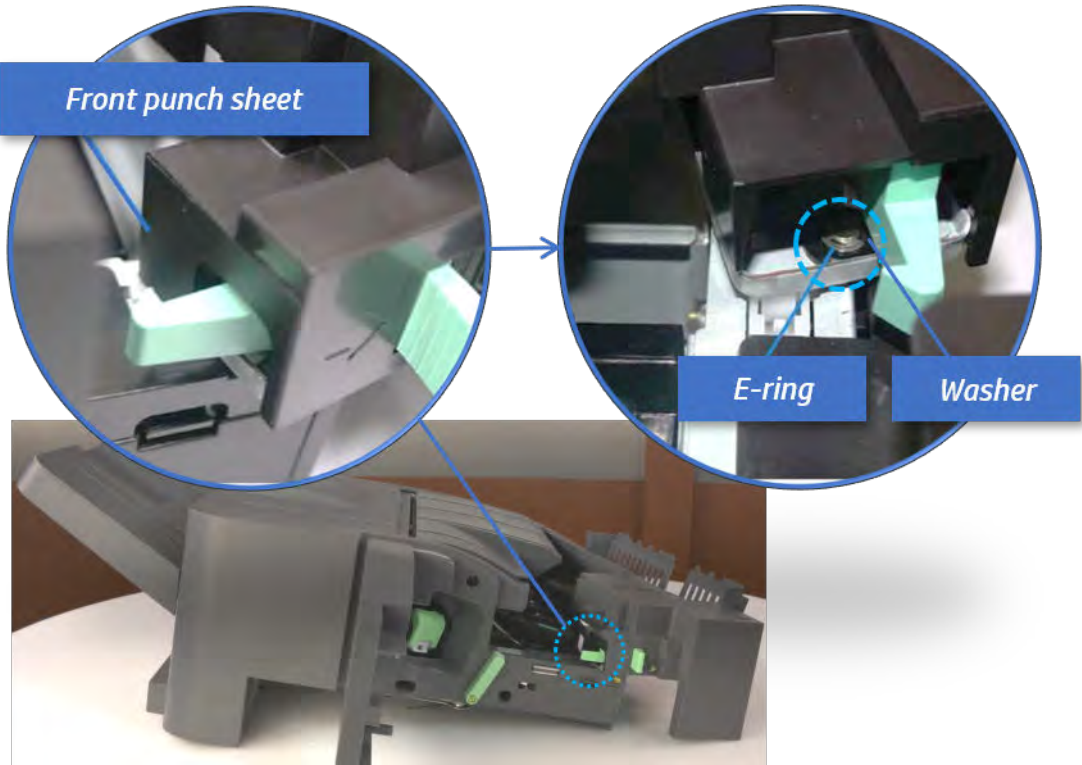
2. Open the punch cover.

Figure 6-780 Open the punch cover



3. Remove the front punch sheet, and then remove the e-ring and the washer. And then remove the punch cover.

Figure 6-781 Remove the punch cover

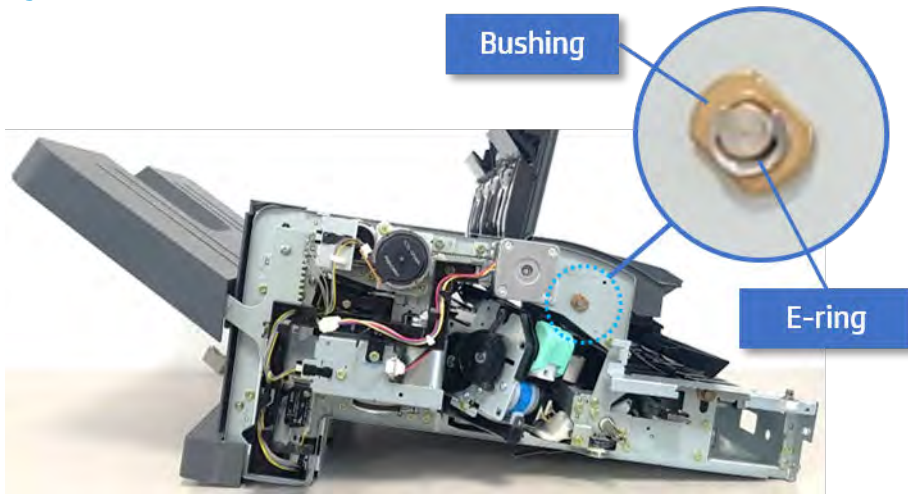


#### Remove the diverter guide and the middle roller

Follow these steps to remove the diverter guide and the middle roller.

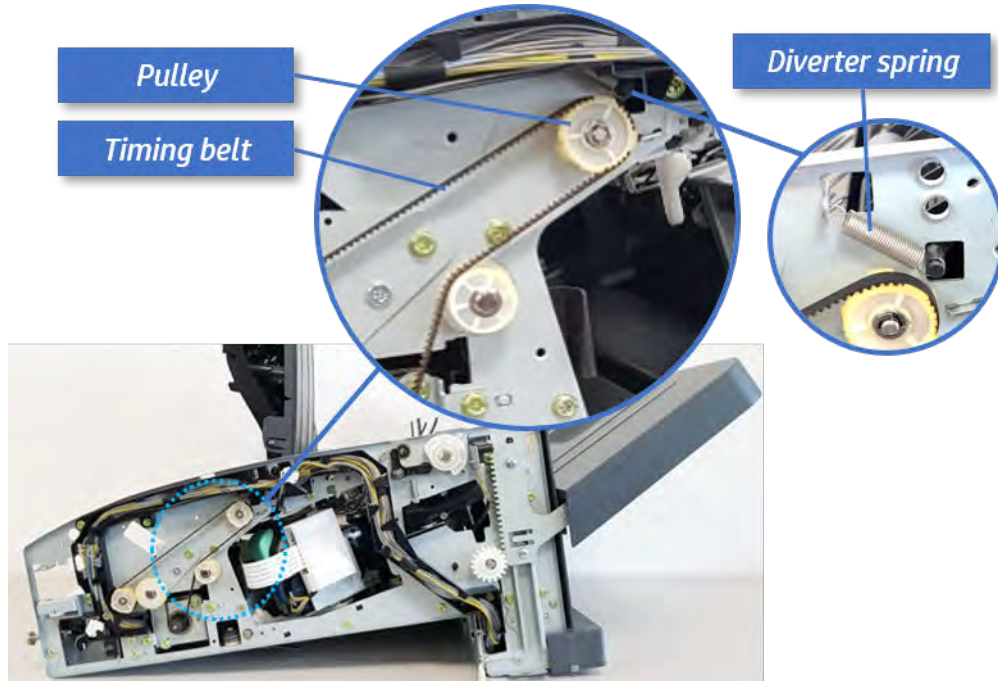
1. On the front of the inner finisher, remove the e-ring and bushing.

Figure 6-782 Remove the e-ring and bushing



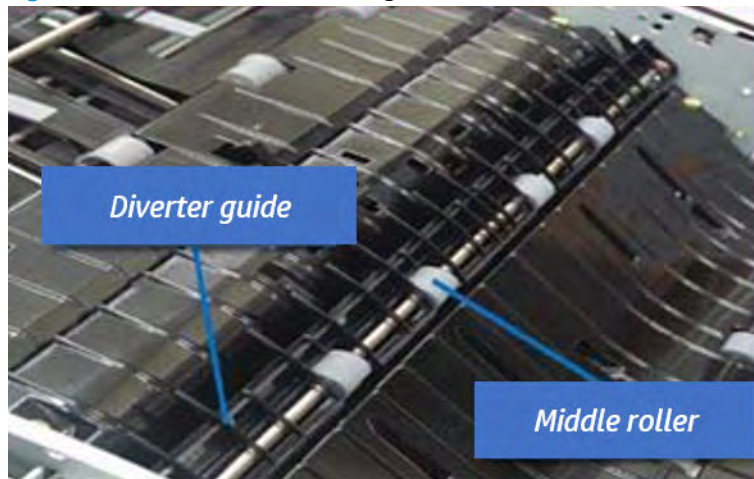
2. On the rear of the inner finisher, remove the e-ring, pulley, bushing, belt, and spring (slightly hidden from view).

**Figure 6-783** Remove the e-ring, pulley, bushing, belt, and spring



3. Remove the diverter guide and the middle roller.

**Figure 6-784** Remove the diverter guide and the middle roller




### Remove the middle paper guide

Follow these steps to remove the middle paper guide.

1. Remove six screws, and then open the middle paper guide in the direction of the arrow.

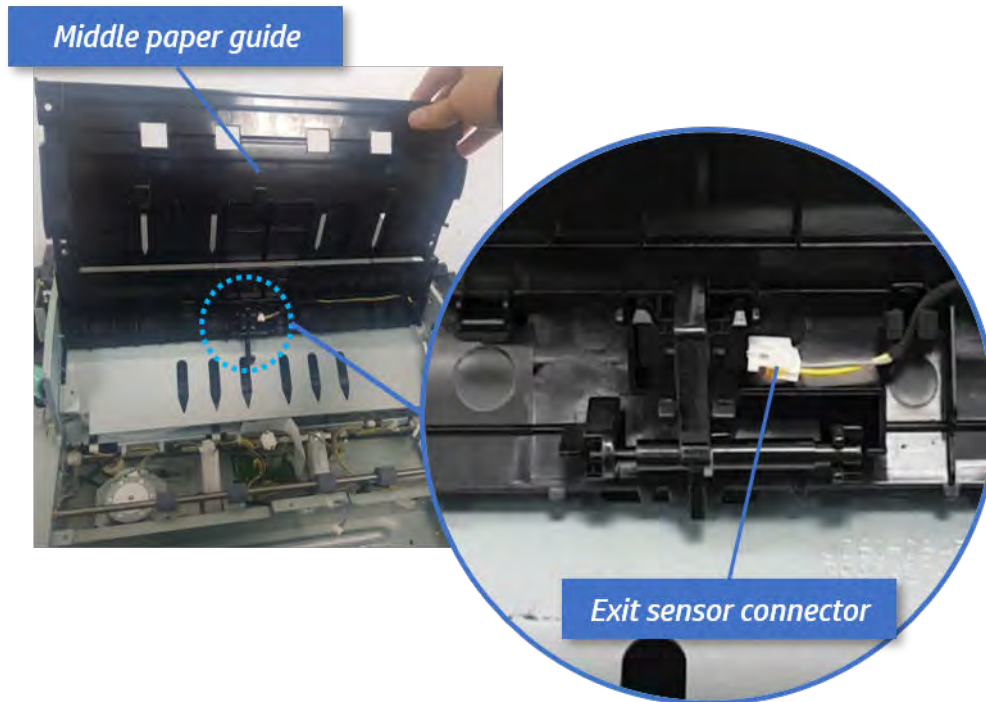
Figure 6-785 Open the middle paper guide



 **NOTE:** Be careful not to damage the sensor connector.

2. Unplug the connector under the middle paper guide. And then, remove the middle paper guide.

Figure 6-786 Remove the middle paper guide

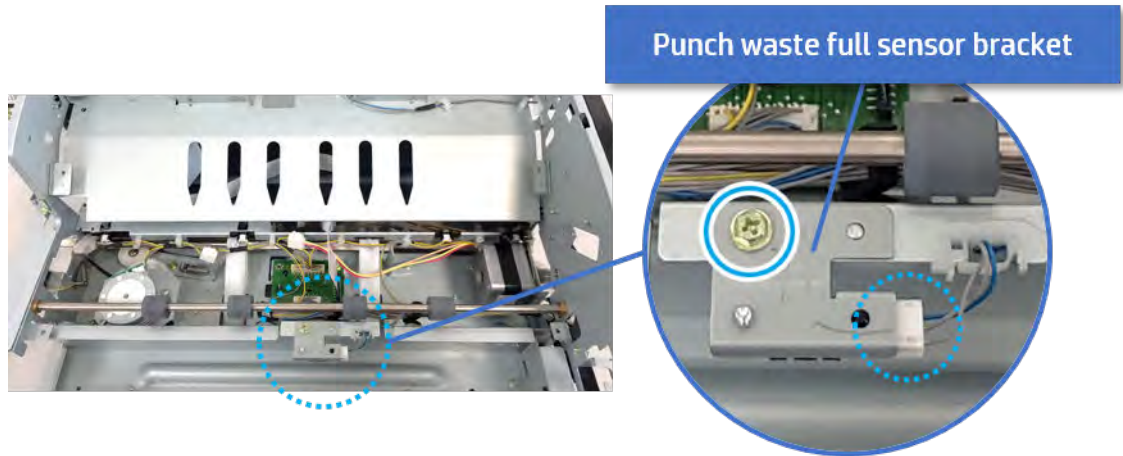


### Remove the punch waste full sensor

Follow these steps to remove the punch waste full sensor.

1. Remove one screw, unplug the connector, and then remove the punch waste full sensor bracket.

Figure 6-787 Remove the punch waste full sensor bracket



2. Remove one screw, and then remove the punch waste full sensor from the bracket.

Figure 6-788 Remove the punch waste full sensor



### Unpack the replacement assembly

Follow these steps to unpack the replacement assembly.

1. Dispose of the defective part.



---


 **NOTE:** HP recommends responsible disposal of the defective part.


<http://www8.hp.com/us/en/hp-information/environment/product-recycling.html>

---

2. Unpack the replacement part from the packaging.


 **CAUTION:**  Some parts are sensitive to electrostatic discharge (ESD). Always perform service work at an ESD-protected workstation or mat. If an ESD workstation or mat is not available, touch the sheet-metal chassis to provide a static ground before touching an ESD-sensitive assembly. Protect the ESD-sensitive assemblies by placing them in ESD pouches when they are out of the printer.

 **IMPORTANT:** Make sure that all of the shipping materials (for example shipping tape) are removed from the replacement part prior to installation.

 **NOTE:** If the replacement part is a roller or pad, avoid touching the spongy part of it. Skin oils on the roller or pad can cause paper pickup and/or print-quality problems. HP recommends using disposable gloves when handling rollers or pads or washing your hands before touching rollers or pads.

---

3. To install an assembly, reverse the removal steps.

 **NOTE:** When applicable, special installation instructions are provided for an assembly at the end of the removal procedure. Always completely read the removal instructions and follow all special installation instructions.

---



## Problem solving

Learn about problem solving.

### Control panel message document (CPMD)

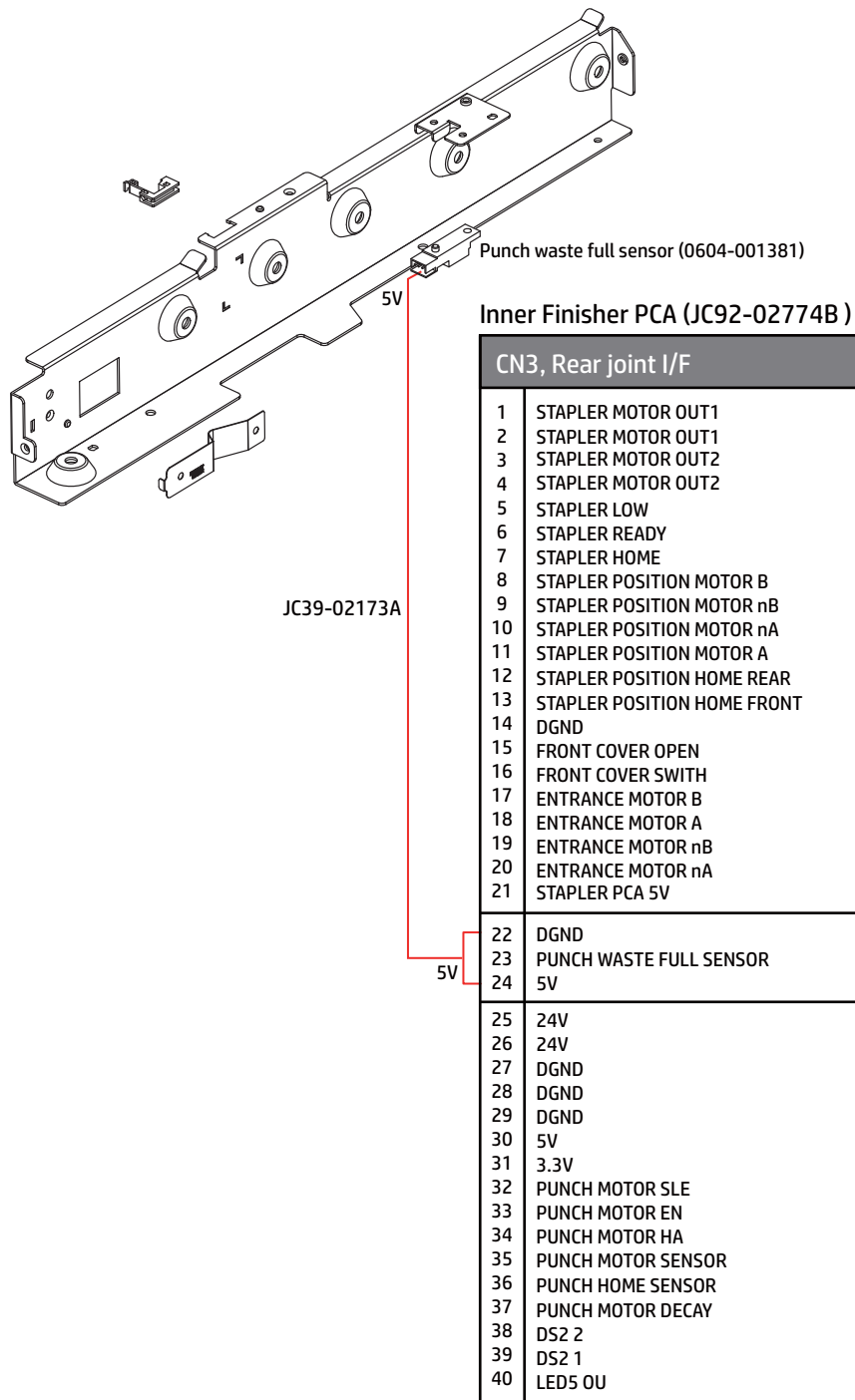
Learn about the control panel message document (CPMD).

Refer to [Error codes on page 760](#) for more details.

# Electrical Mechanical Diagrams (Inner finisher)

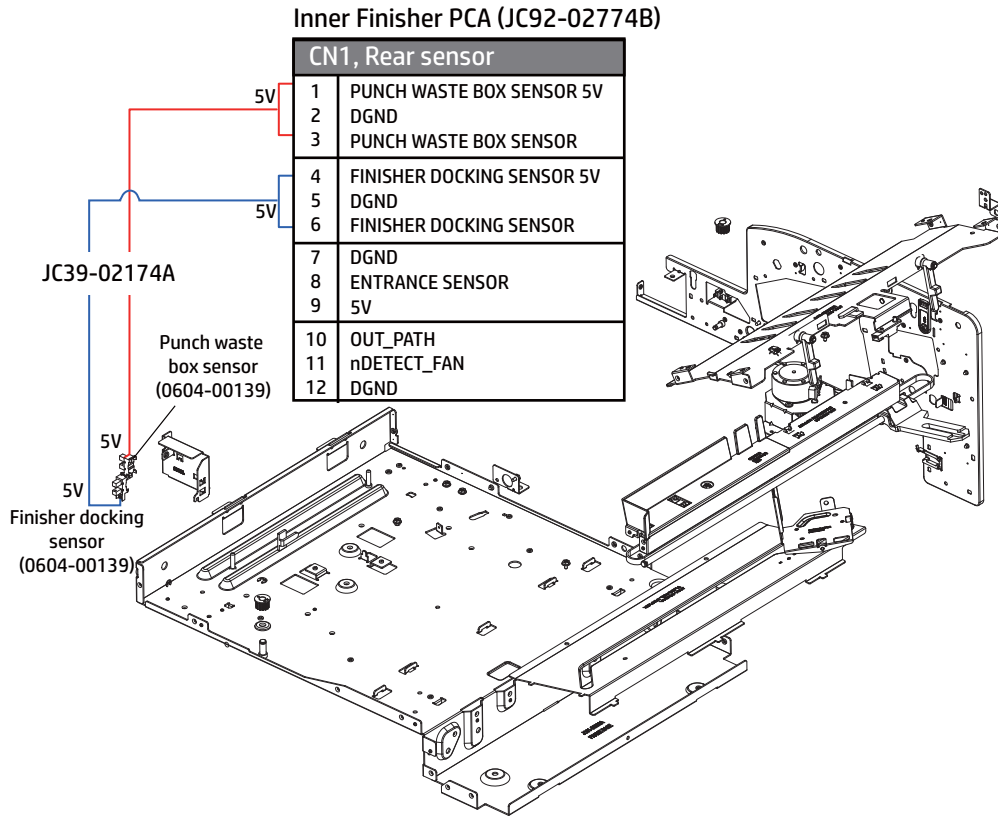
Punch waste full sensor

Figure 6-789 Punch waste full sensor



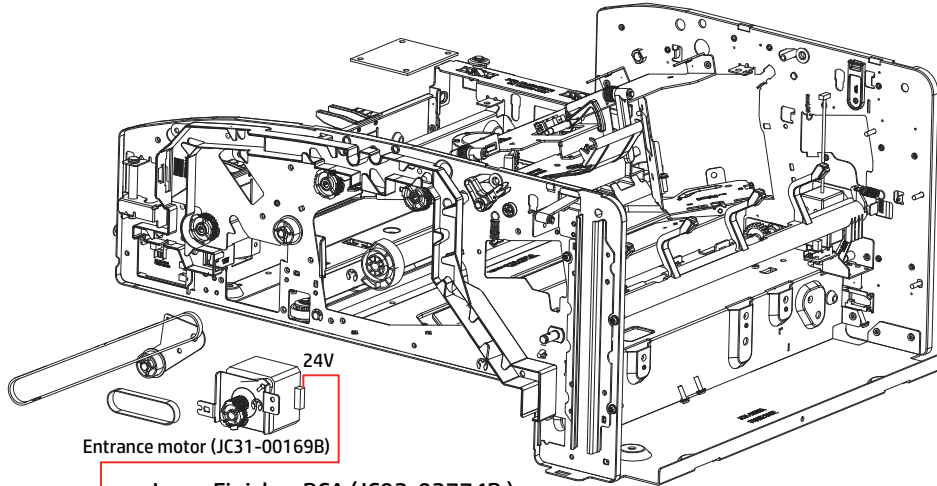
## Punch waste box sensor and finisher docking sensor

Figure 6-790 Punch waste box sensor and finisher docking sensor



## Entrance motor

Figure 6-791 Entrance motor



Entrance motor (JC31-00169B)

Inner Finisher PCA (JC92-02774B)

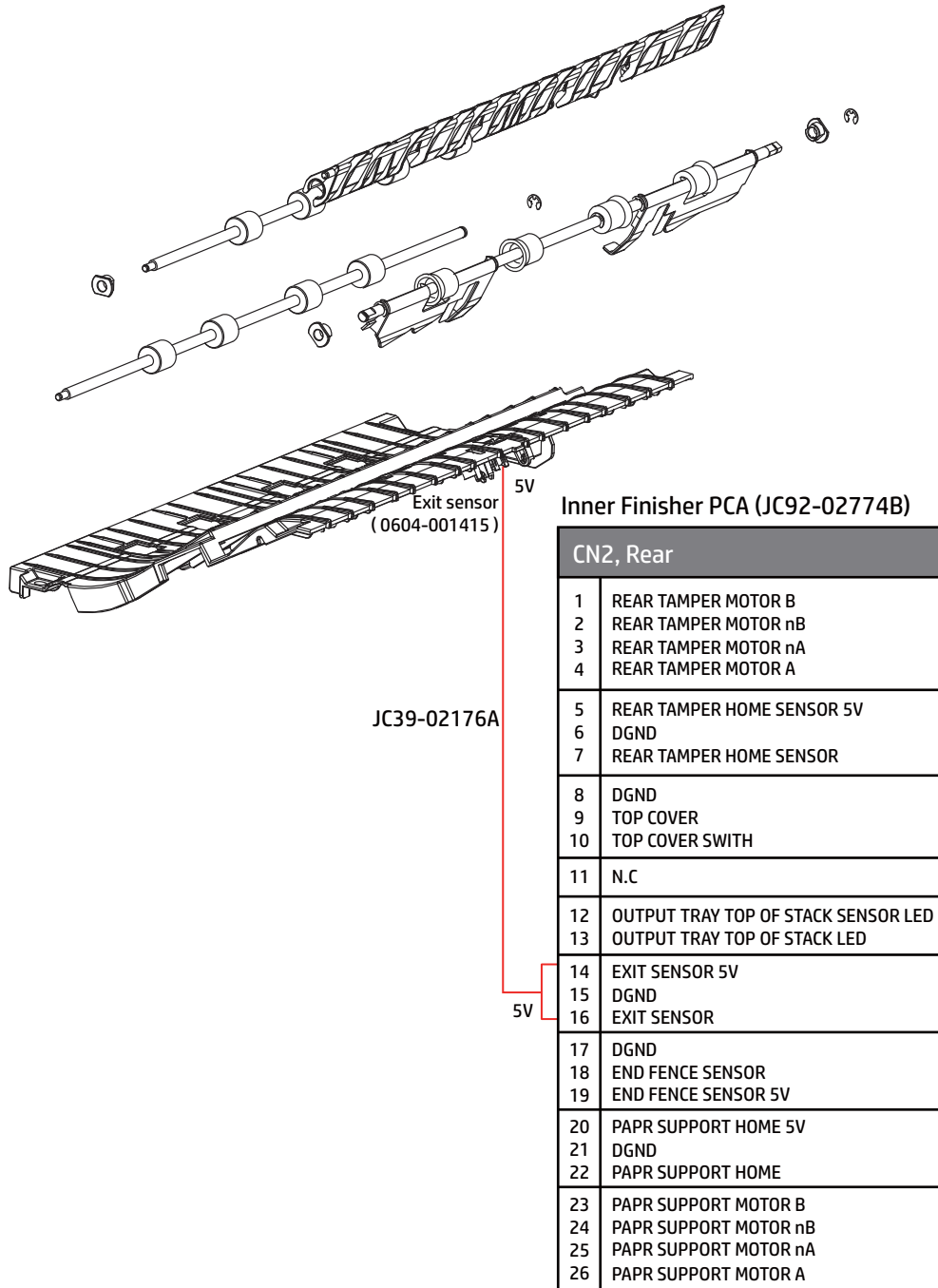
CN3, Rear joint I/F	
1	STAPLER MOTOR OUT1
2	STAPLER MOTOR OUT1
3	STAPLER MOTOR OUT2
4	STAPLER MOTOR OUT2
5	STAPLER LOW
6	STAPLER READY
7	STAPLER HOME
8	STAPLER POSITION MOTOR B
9	STAPLER POSITION MOTOR nB
10	STAPLER POSITION MOTOR nA
11	STAPLER POSITION MOTOR A
12	STAPLER POSITION HOME REAR
13	STAPLER POSITION HOME FRONT
14	DGND
15	FRONT COVER OPEN
16	FRONT COVER SWITH
17	ENTRANCE MOTOR B
18	ENTRANCE MOTOR A
19	ENTRANCE MOTOR nB
20	ENTRANCE MOTOR nA
21	STAPLER PCA 5V
22	DGND
23	PUNCH WASTE FULL SENSOR
24	5V
25	24V
26	24V
27	DGND
28	DGND
29	DGND
30	5V
31	3.3V
32	PUNCH MOTOR SLE
33	PUNCH MOTOR EN
34	PUNCH MOTOR HA
35	PUNCH MOTOR SENSOR
36	PUNCH HOME SENSOR
37	PUNCH MOTOR DECAY
38	DS2 2
39	DS2 1
40	LED5 OU

JC39-02173A

24V

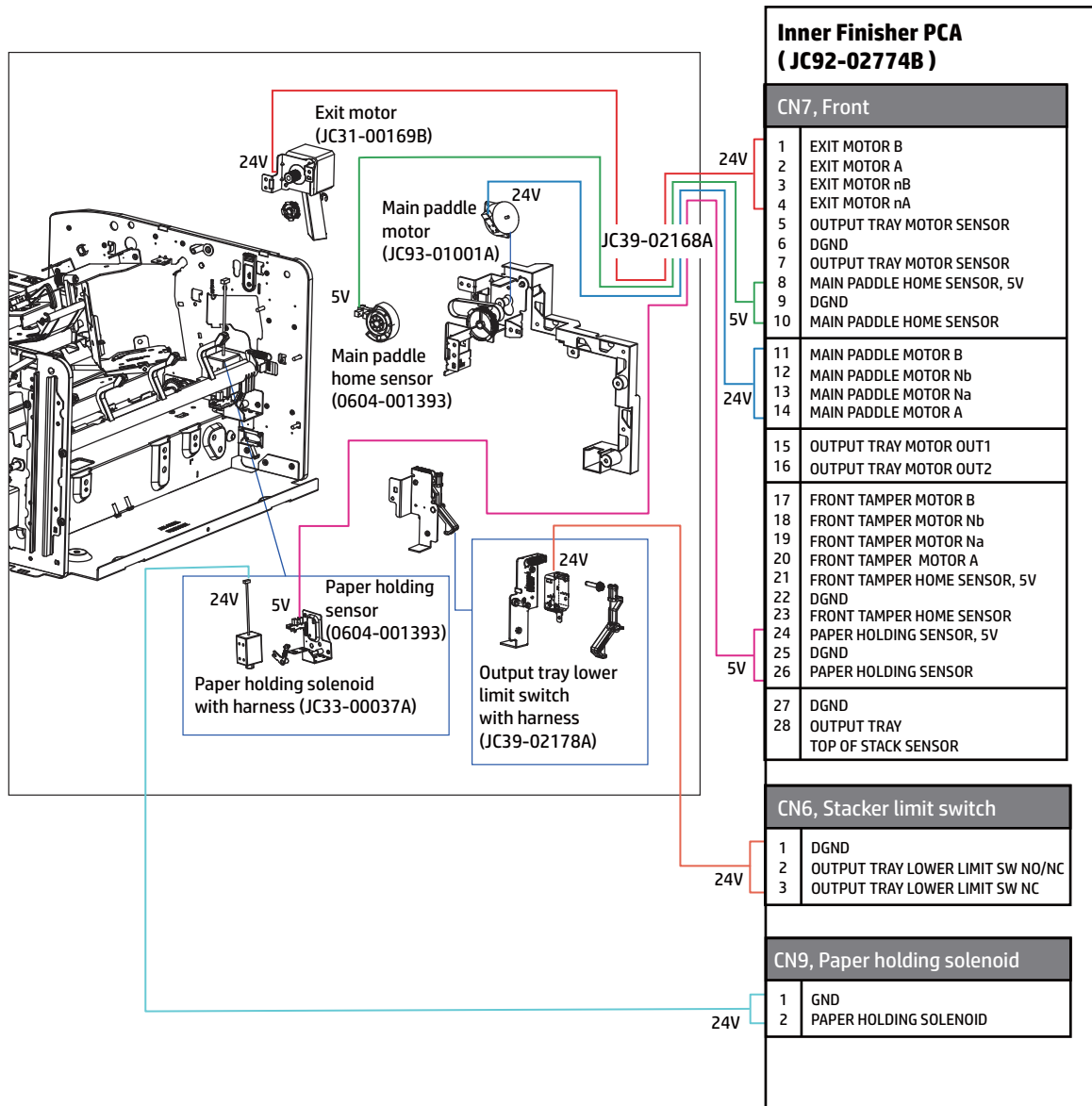
Exit sensor

Figure 6-792 Exit sensor



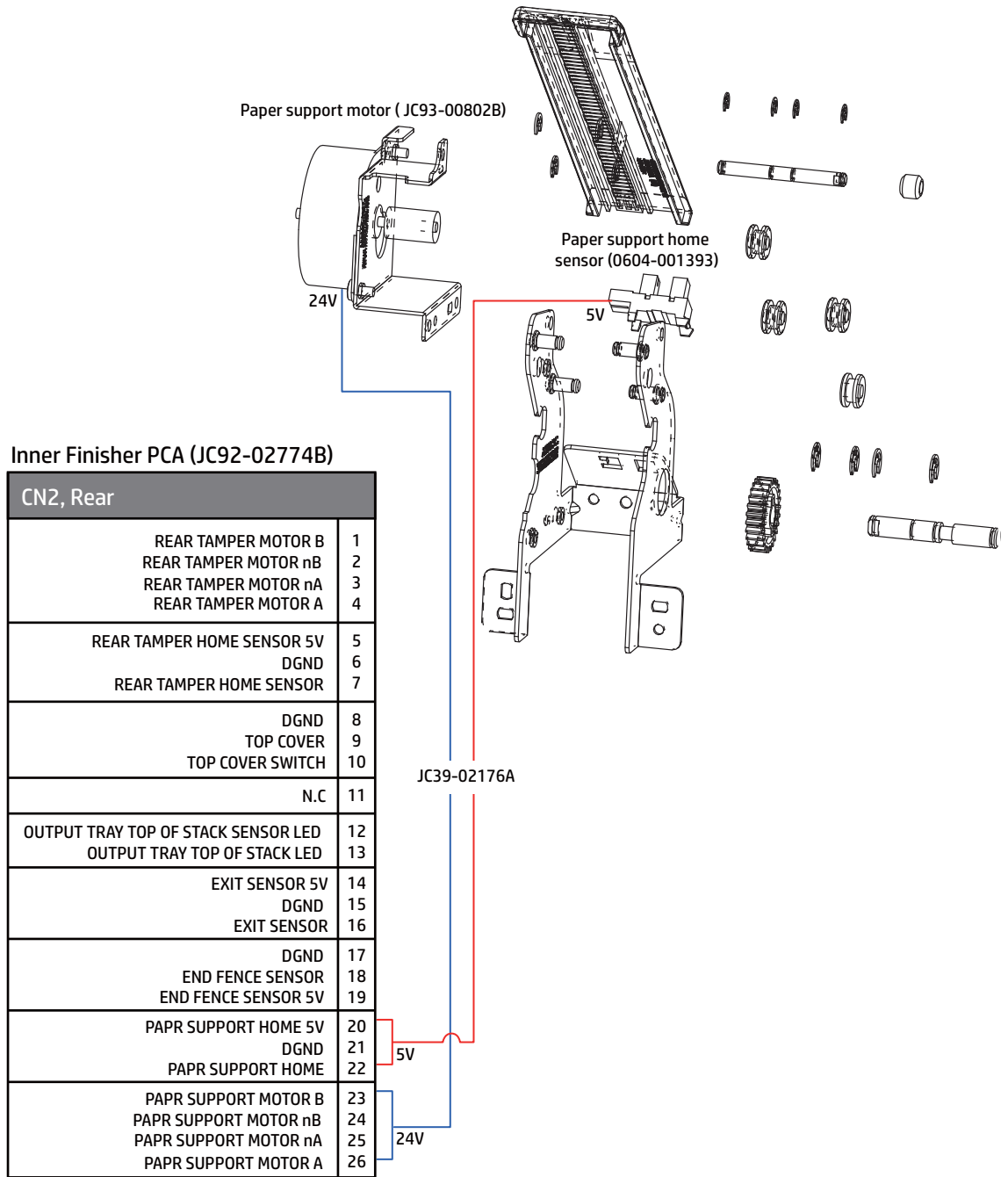
Exit motor, main paddle motor & home sensor, output tray lower limit switch, and paper holding solenoid

Figure 6-793 Exit motor, paddle motor&sensor, output tray lower limit sensor, and paper holding solenoid



## Paper support motor & home sensor

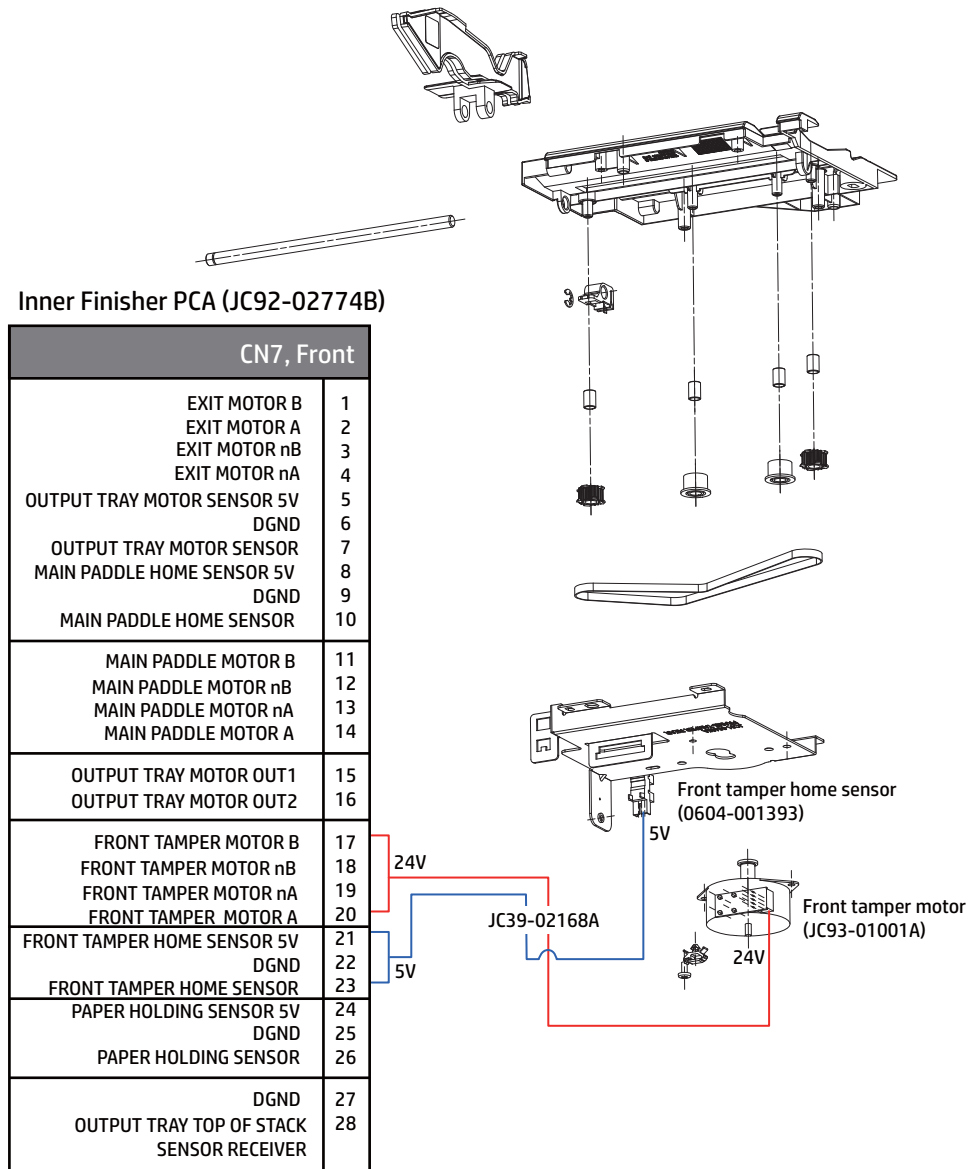
Figure 6-794 Paper support sensor and motor



## Front tamper motor and home sensor

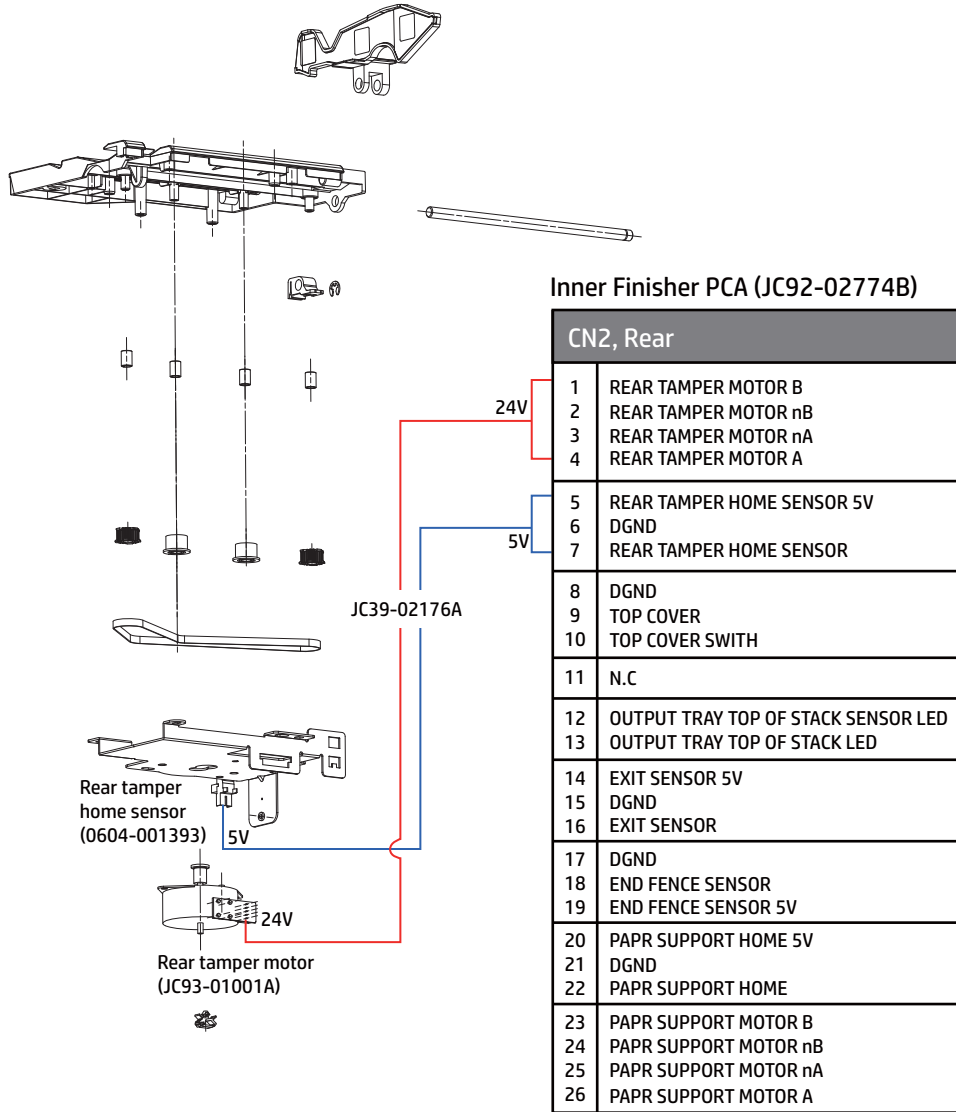


Figure 6-795 Front tamper sensor and motor



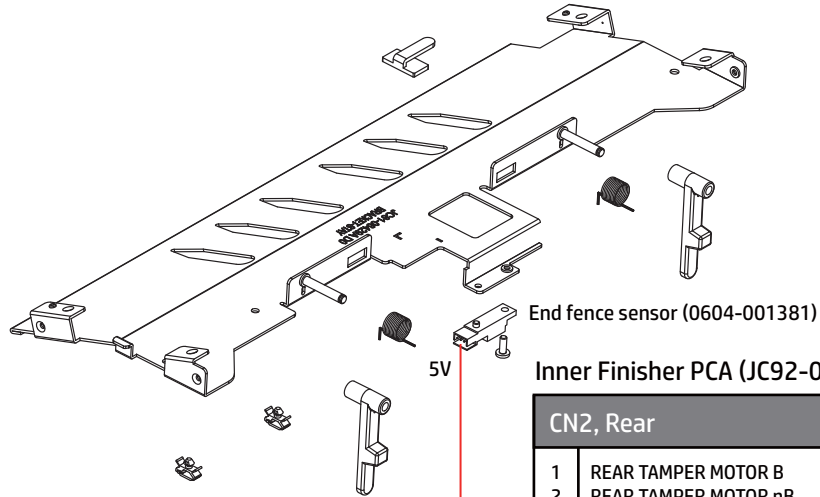
## Rear tamper motor and home sensor

Figure 6-796 Rear tamper sensor and motor



## End fence sensor

Figure 6-797 End fence sensor



End fence sensor (0604-001381)

Inner Finisher PCA (JC92-02774B)

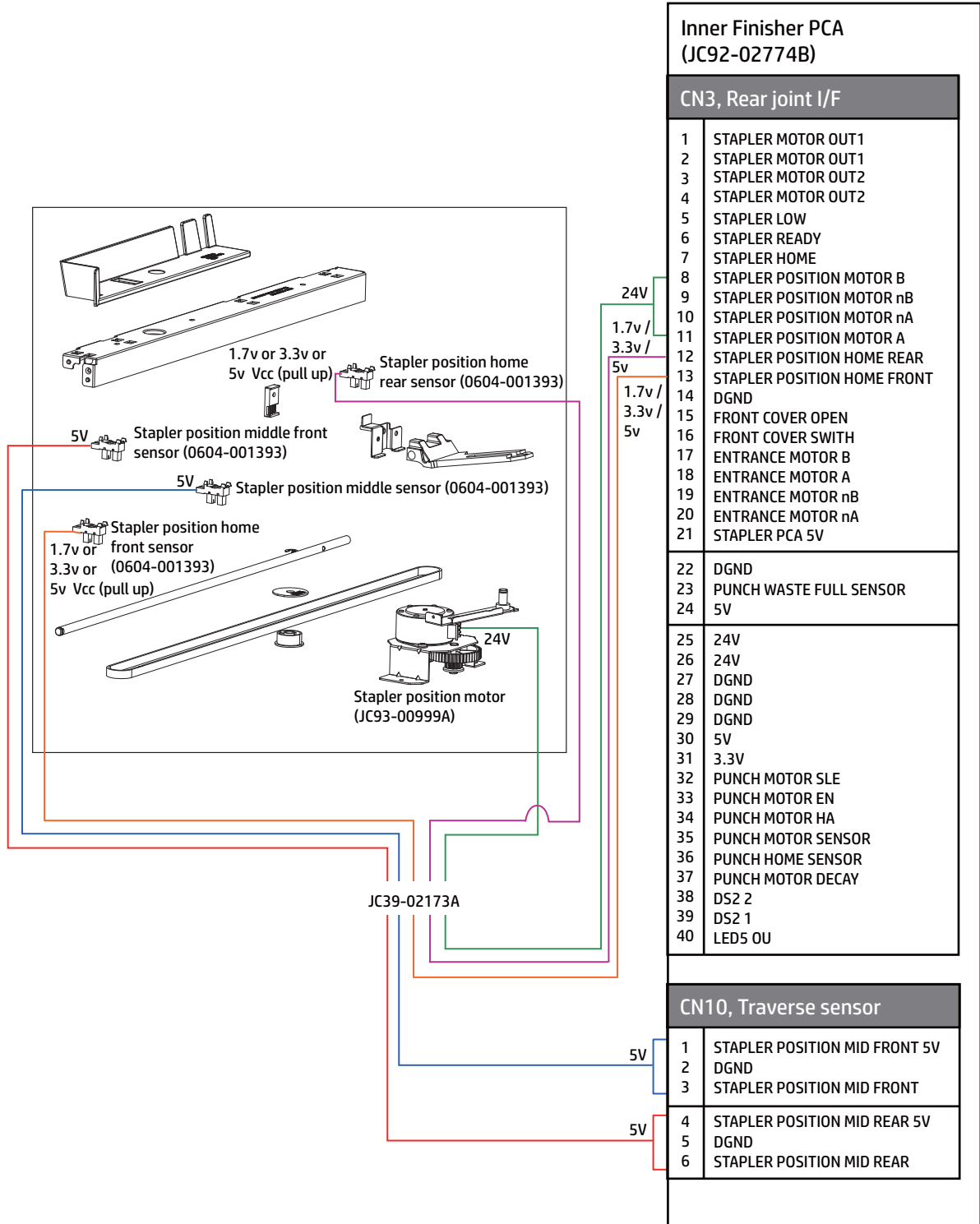
CN2, Rear	
1	REAR TAMPER MOTOR B
2	REAR TAMPER MOTOR nB
3	REAR TAMPER MOTOR nA
4	REAR TAMPER MOTOR A
5	REAR TAMPER HOME SENSOR 5V
6	DGND
7	REAR TAMPER HOME SENSOR
8	DGND
9	TOP COVER
10	TOP COVER SWITH
11	N.C
12	OUTPUT TRAY TOP OF STACK SENSOR LED
13	OUTPUT TRAY TOP OF STACK LED
14	EXIT SENSOR 5V
15	DGND
16	EXIT SENSOR
17	DGND
18	END FENCE SENSOR
19	END FENCE SENSOR 5V
20	PAPR SUPPORT HOME 5V
21	DGND
22	PAPR SUPPORT HOME
23	PAPR SUPPORT MOTOR B
24	PAPR SUPPORT MOTOR nB
25	PAPR SUPPORT MOTOR nA
26	PAPR SUPPORT MOTOR A

JC39-02176A

5V

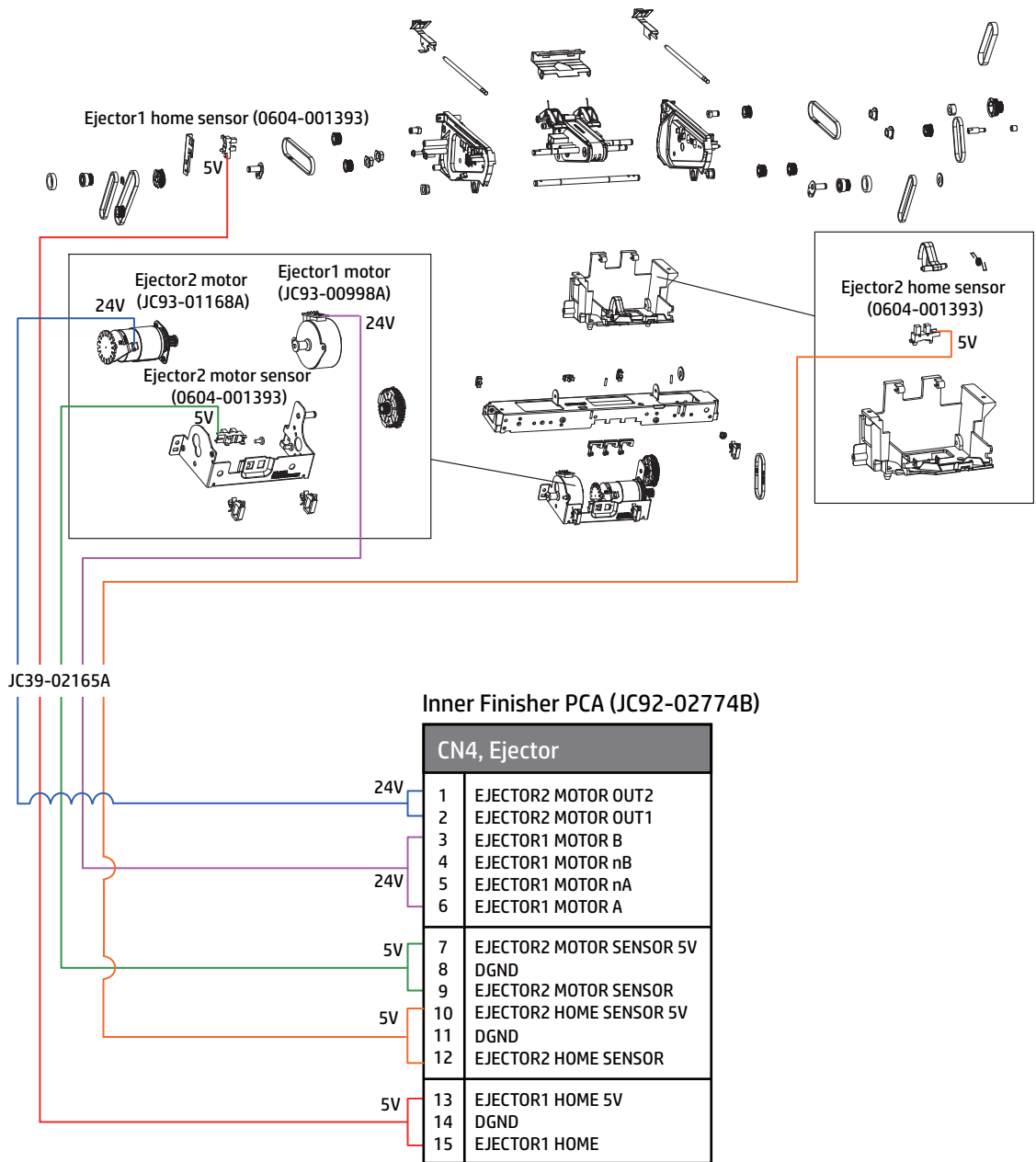
## Stapler position motor and sensor

Figure 6-798 Stapler position sensor and motor



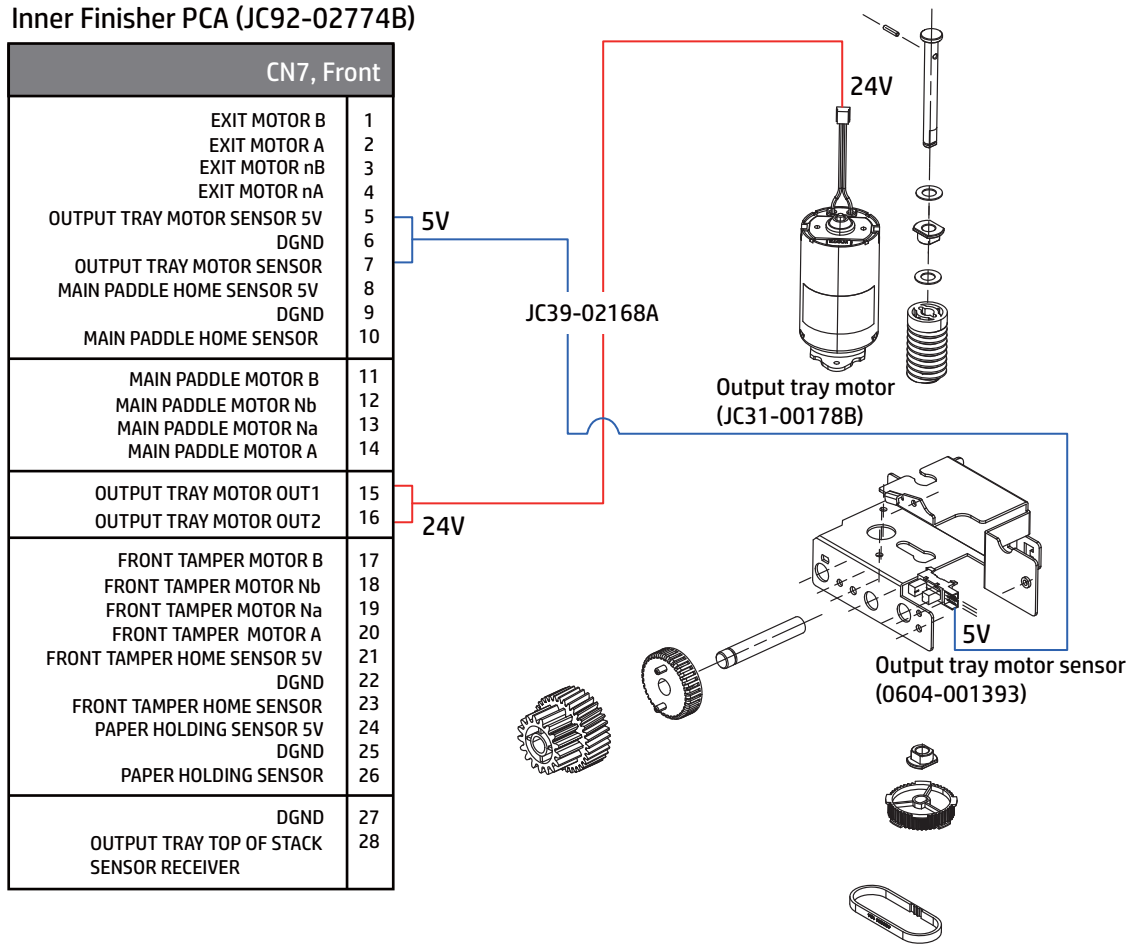
Ejector 1 motor and home sensor, ejector 2 motor, motor sensor, and home sensor

Figure 6-799 Ejector 1 motor and home sensor, ejector 2 motor, motor sensor, and home sensor



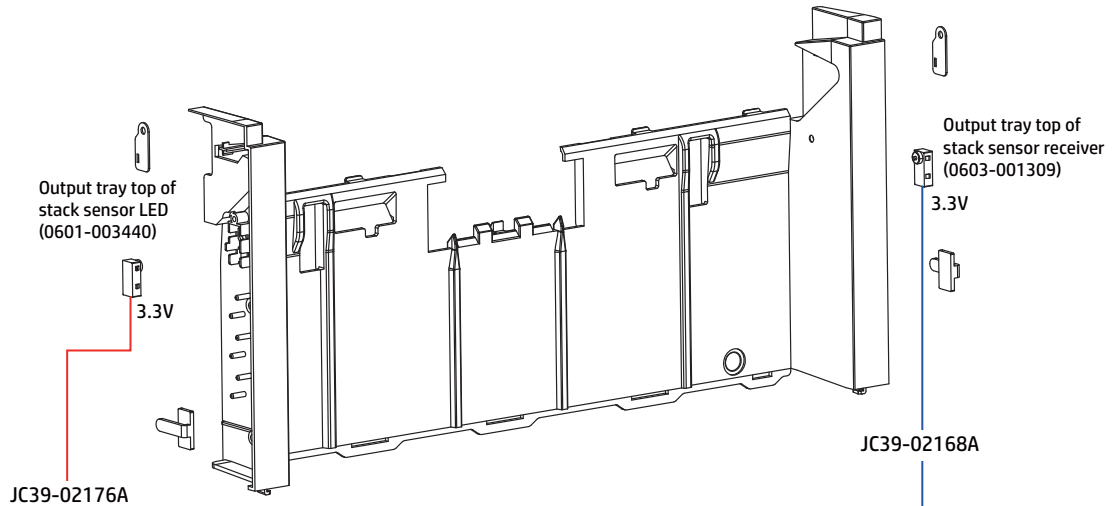
## Output tray motor and sensor

Figure 6-800 Output tray motor and sensor



## Output tray top of stack sensor

Figure 6-801 Output tray top of stack sensor



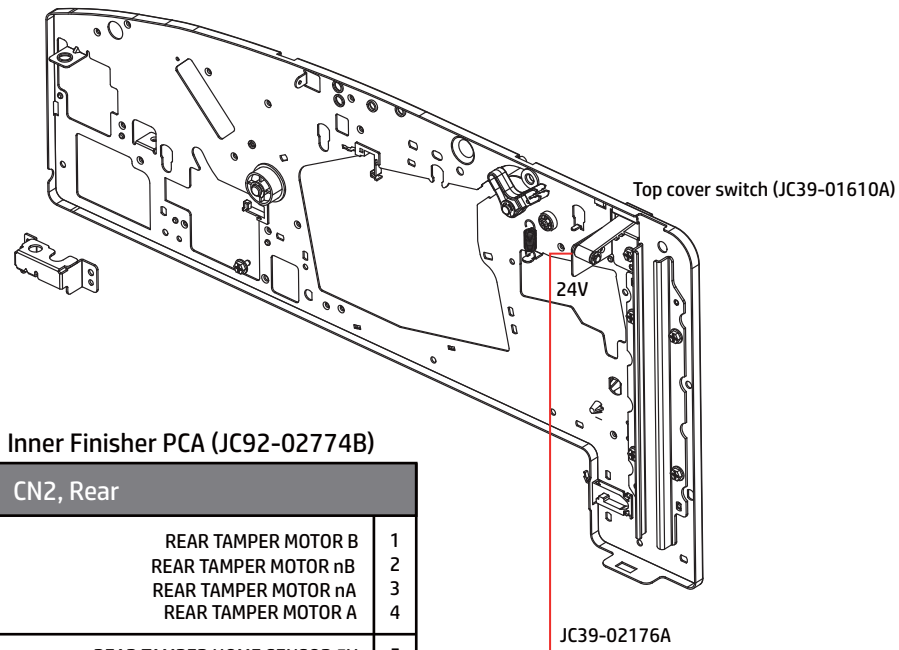
Inner Finisher PCA (JC92-02774B)	
CN2, Rear	
1	REAR TAMPER MOTOR B
2	REAR TAMPER MOTOR nB
3	REAR TAMPER MOTOR nA
4	REAR TAMPER MOTOR A
5	REAR TAMPER HOME SENSOR 5V
6	DGND
7	REAR TAMPER HOME SENSOR
8	DGND
9	TOP COVER 24V
10	TOP COVER SWITCH
11	N.C
12	OUTPUT TRAY TOP OF STACK SENSOR LED 3.3V
13	OUTPUT TRAY TOP OF STACK LED
14	EXIT SENSOR 5V
15	DGND
16	EXIT SENSOR
17	DGND
18	END FENCE SENSOR
19	END FENCE SENSOR 5V
20	PAPR SUPPORT HOME 5V
21	DGND
22	PAPR SUPPORT HOME
23	PAPR SUPPORT MOTOR B
24	PAPR SUPPORT MOTOR nB
25	PAPR SUPPORT MOTOR nA
26	PAPR SUPPORT MOTOR A

CN7, Front		
	EXIT MOTOR B	1
	EXIT MOTOR A	2
	EXIT MOTOR nB	3
	EXIT MOTOR nA	4
	OUTPUT TRAY MOTOR SENSOR 5V	5
	DGND	6
	OUTPUT TRAY MOTOR SENSOR	7
	MAIN PADDLE HOME SENSOR 5V	8
	DGND	9
	MAIN PADDLE HOME SENSOR	10
	MAIN PADDLE MOTOR B	11
	MAIN PADDLE MOTOR nB	12
	MAIN PADDLE MOTOR nA	13
	MAIN PADDLE MOTOR A	14
	OUTPUT TRAY MOTOR OUT1	15
	OUTPUT TRAY MOTOR OUT2	16
	FRONT TAMPER MOTOR B	17
	FRONT TAMPER MOTOR nB	18
	FRONT TAMPER MOTOR nA	19
	FRONT TAMPER MOTOR A	20
	FRONT TAMPER HOME SENSOR 5V	21
	DGND	22
	FRONT TAMPER HOME SENSOR	23
	PAPER HOLDING SENSOR 5V	24
	DGND	25
	PAPER HOLDING SENSOR	26
	DGND	27
	OUTPUT TRAY TOP OF STACK SENSOR RECEIVER 3.3V	28

### Top cover switch

Figure 6-802 Top cover switch



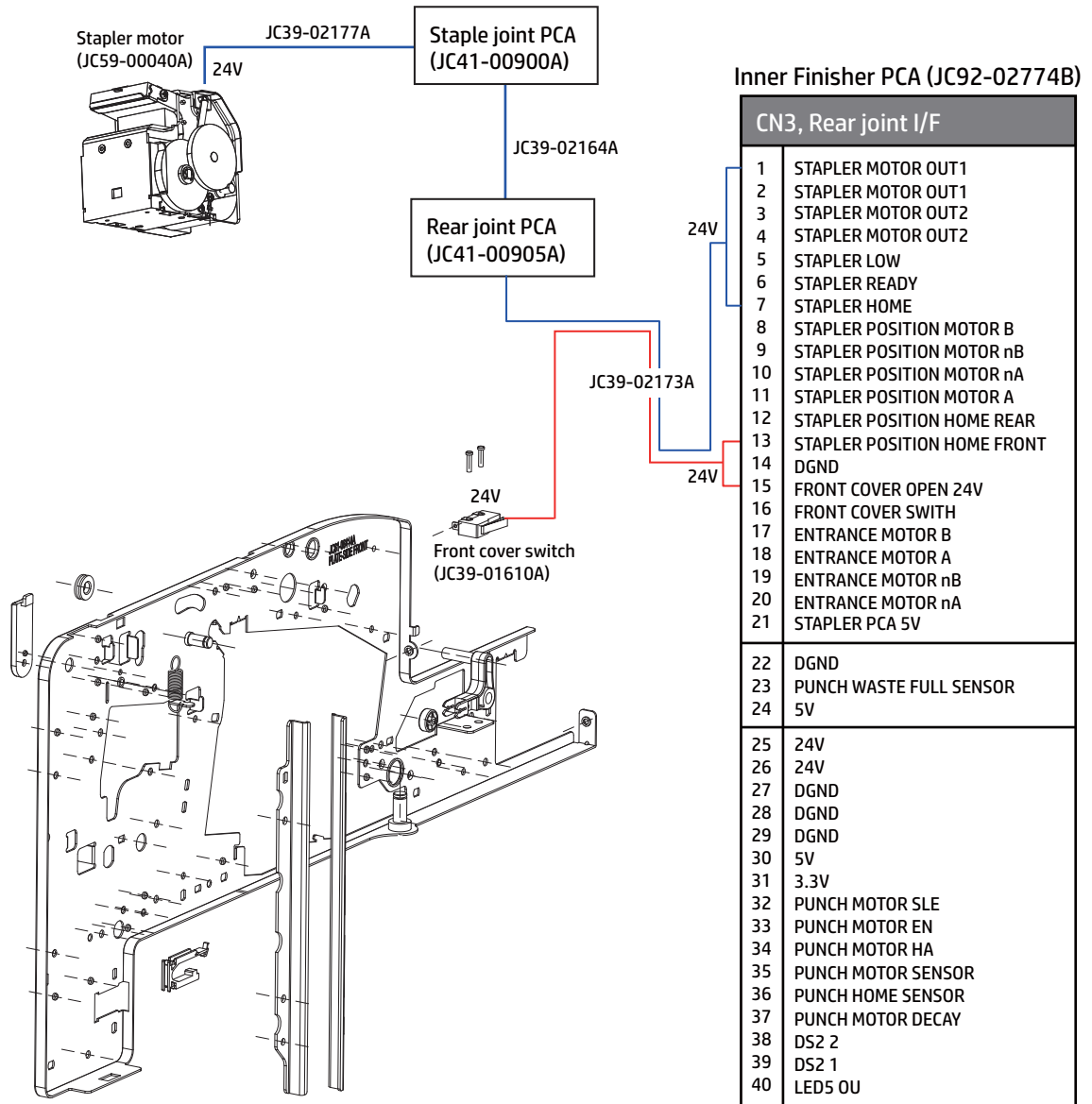
Inner Finisher PCA (JC92-02774B)

CN2, Rear	
REAR TAMPER MOTOR B	1
REAR TAMPER MOTOR nB	2
REAR TAMPER MOTOR nA	3
REAR TAMPER MOTOR A	4
REAR TAMPER HOME SENSOR 5V	5
DGND	6
REAR TAMPER HOME SENSOR	7
DGND	8
TOP COVER 24V	9
TOP COVER SWITCH	10
N.C	11
OUTPUT TRAY TOP OF STACK SENSOR LED	12
OUTPUT TRAY TOP OF STACK LED	13
EXIT SENSOR 5V	14
DGND	15
EXIT SENSOR	16
DGND	17
END FENCE SENSOR	18
END FENCE SENSOR 5V	19
PAPR SUPPORT HOME 5V	20
DGND	21
PAPR SUPPORT HOME	22
PAPR SUPPORT MOTOR B	23
PAPR SUPPORT MOTOR nB	24
PAPR SUPPORT MOTOR nA	25
PAPR SUPPORT MOTOR A	26

Front cover switch



Figure 6-803 Frame front





# 7 Diagrams

Learn about the electrical-mechanical diagrams.

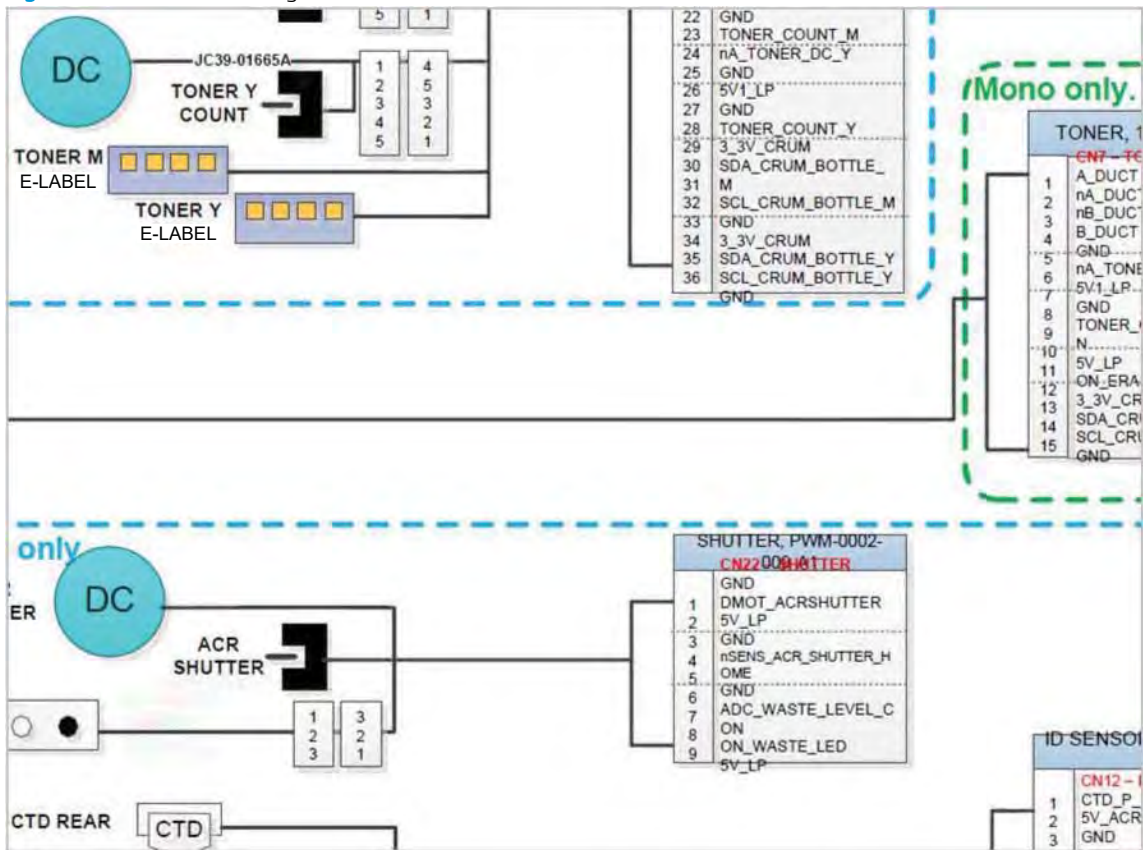
## Diagrams (connection)

Learn about the connection diagram.

**NOTE:** The connection diagram includes the harness part code as shown below.

- Blue text harness codes are for both color and mono models.
- Green text harness codes are for mono models.
- Red text harness codes are for color models.

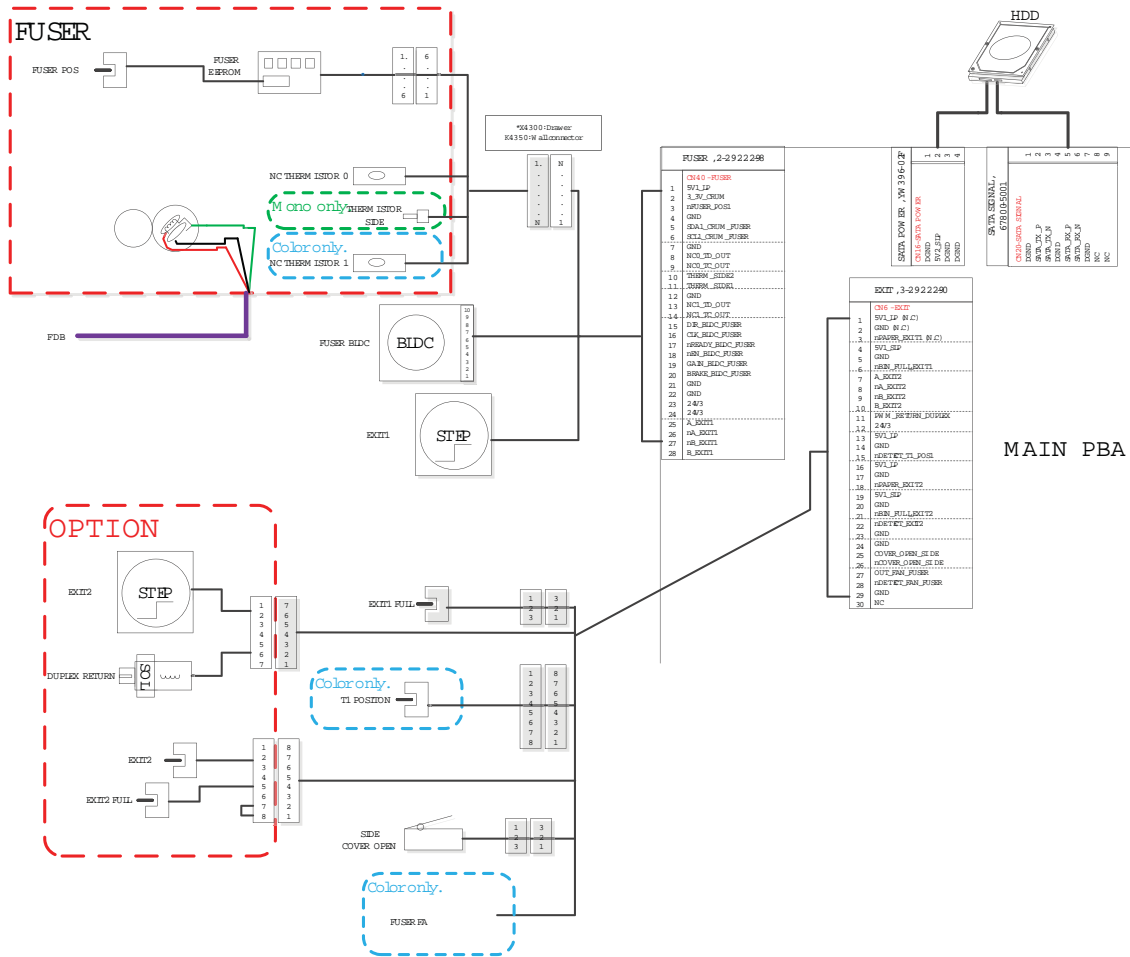
Figure 7-1 Connection diagram



# Diagrams (FUSER EXIT)

Learn about the fuser exit diagram.

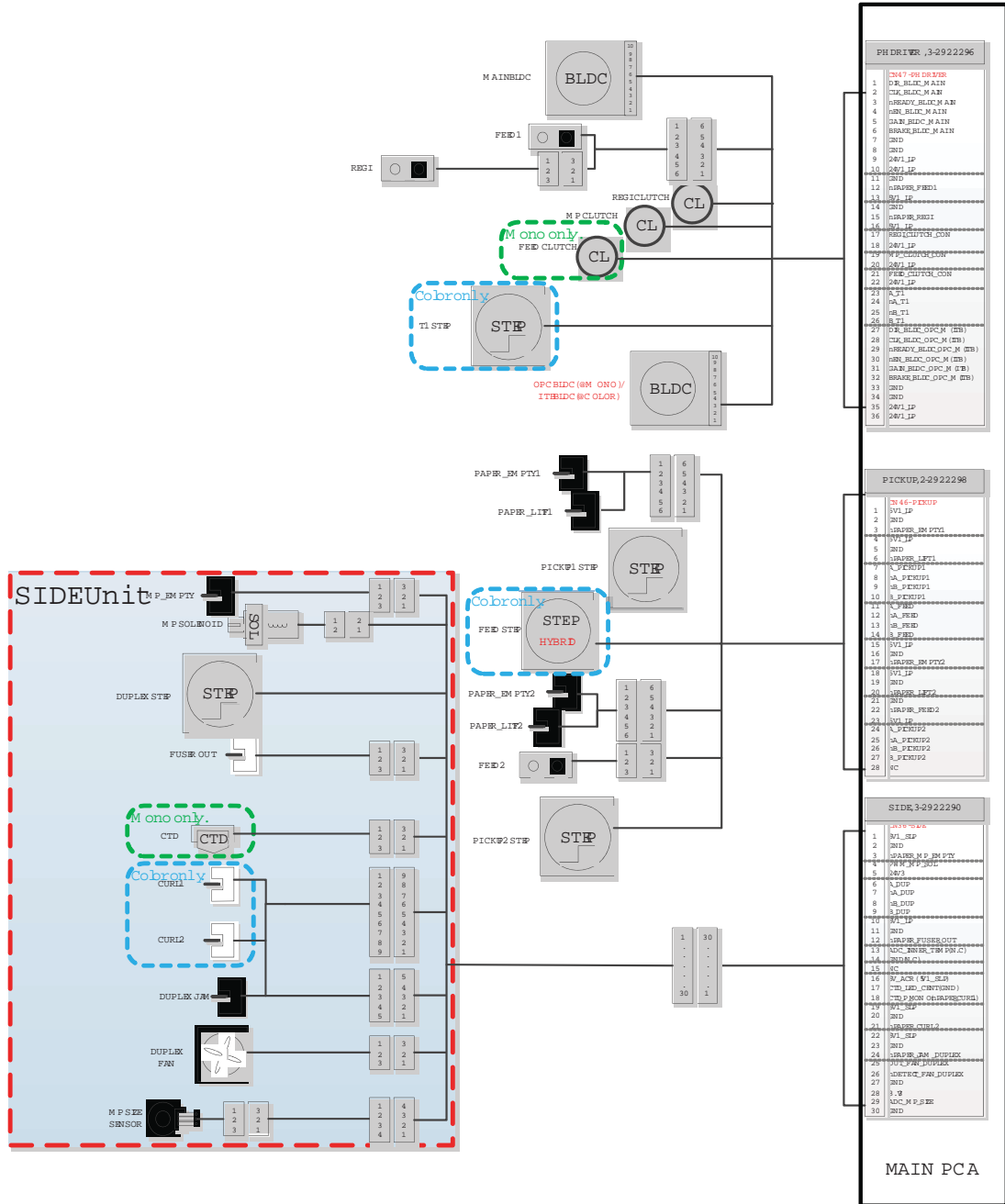
Figure 7-2 Fuser exit diagram



# Diagrams (PICKUP/PH DRIVE/SIDE)

Learn about the pickup/ph drive/side diagram.

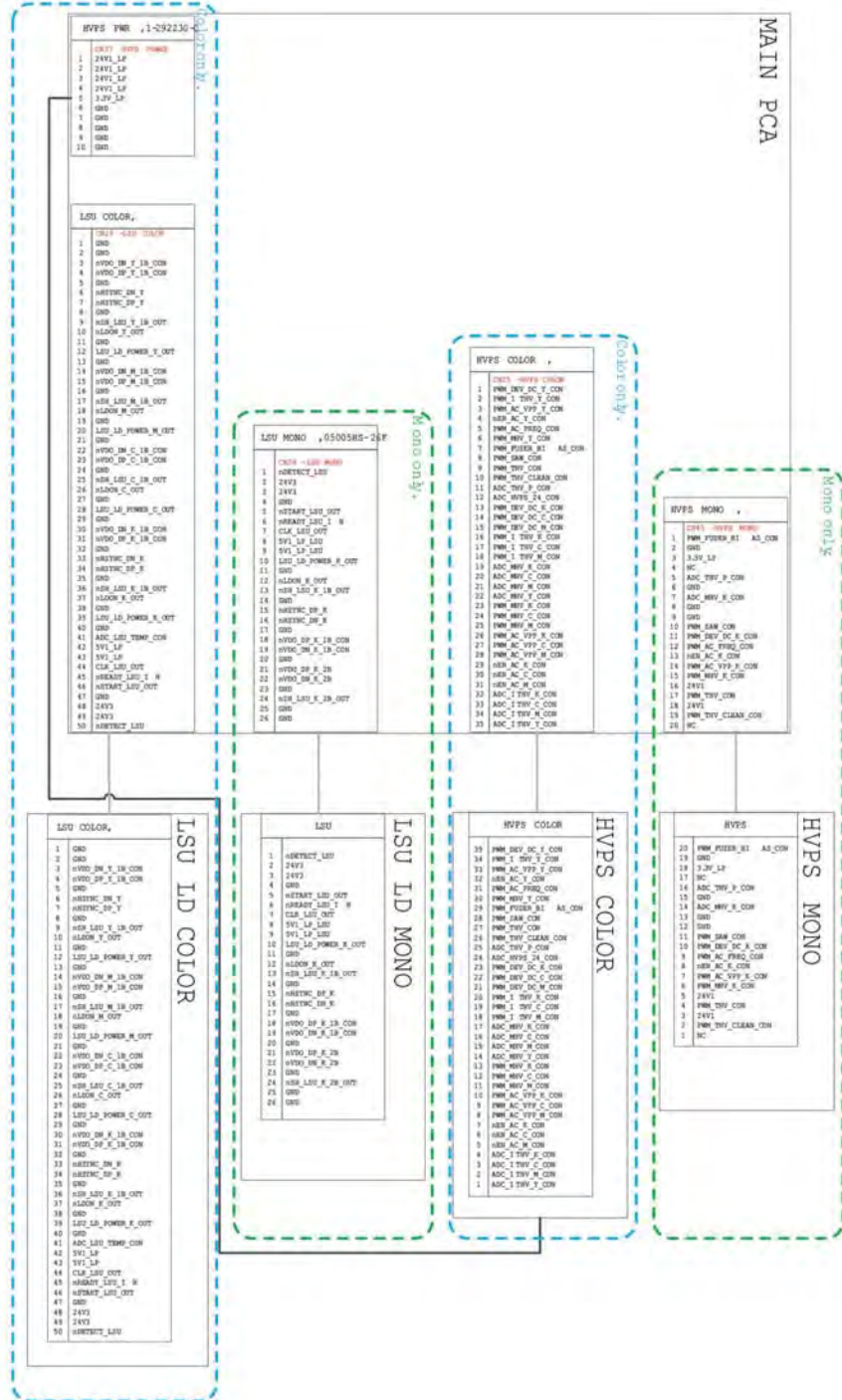
Figure 7-3 Pickup/PH drive/side diagram



## Diagrams (laser scanner assembly/HVPS)

Learn about the laser scanner assembly/HVPS diagram.

Figure 7-4 Laser scanner assembly/HVPS diagram

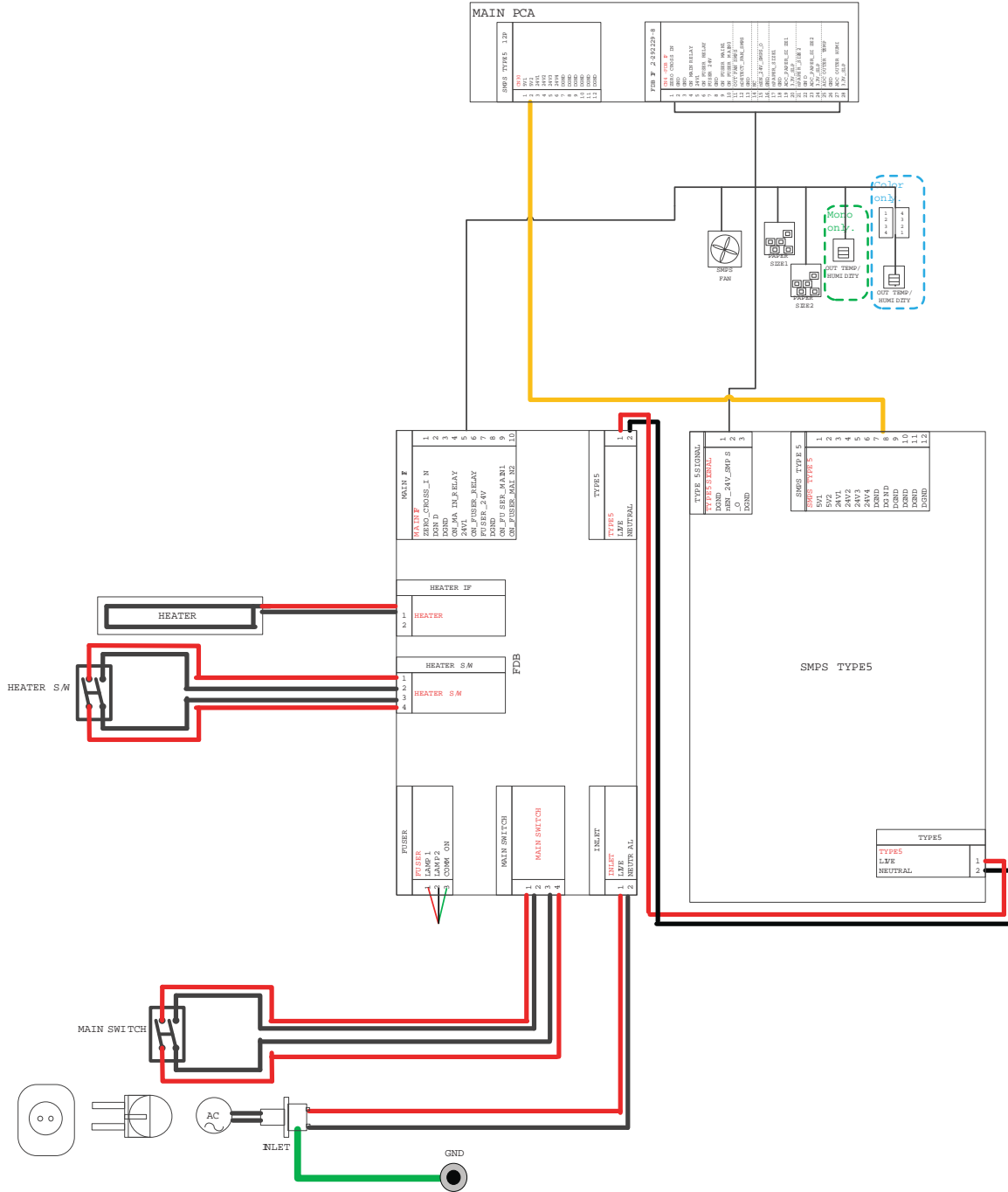


## Diagrams (toner)

Learn about the toner diagram.



Figure 7-6 FDB/LVPS diagram

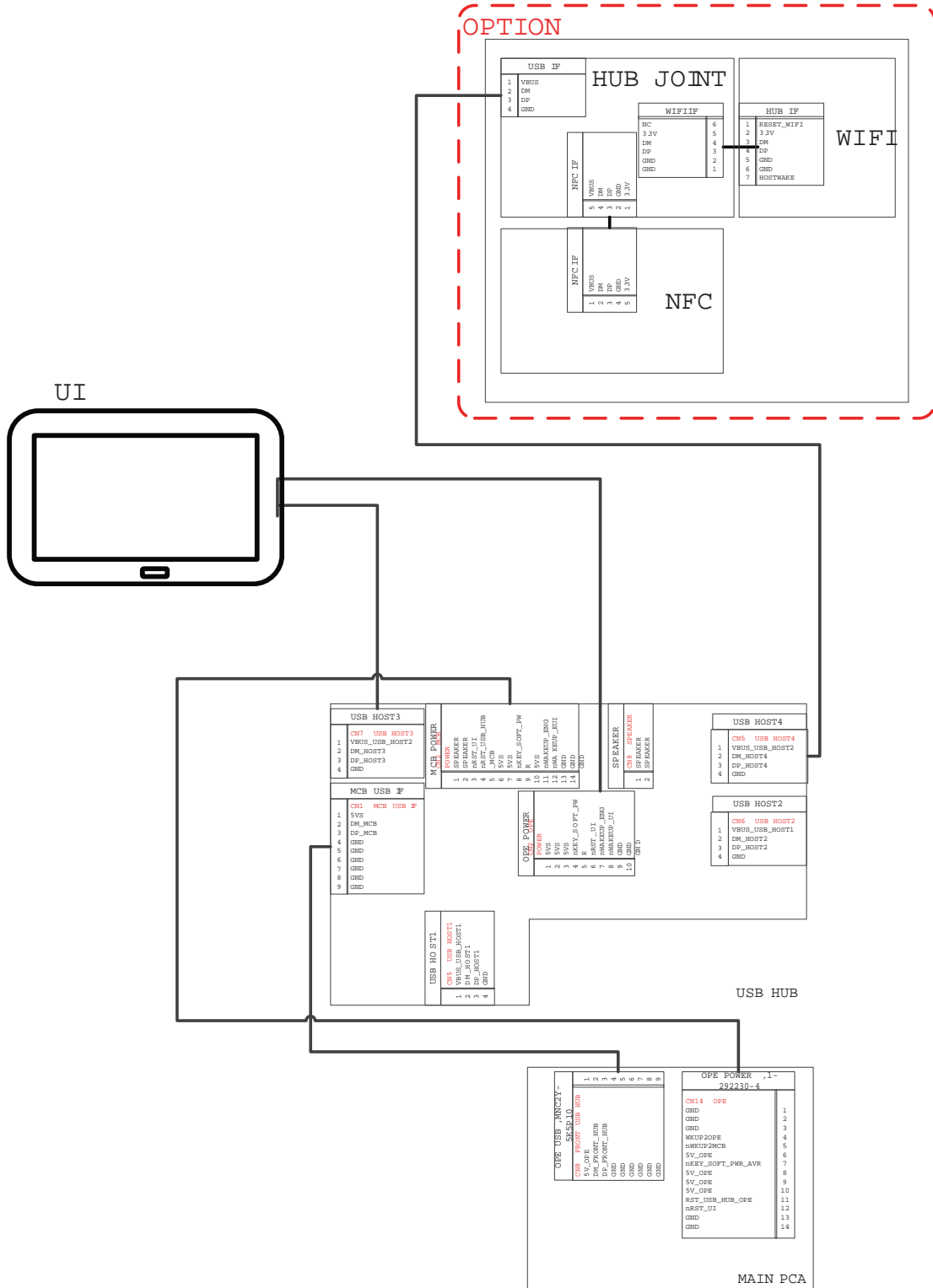


## Diagrams (UI)

Learn about the UI diagram.



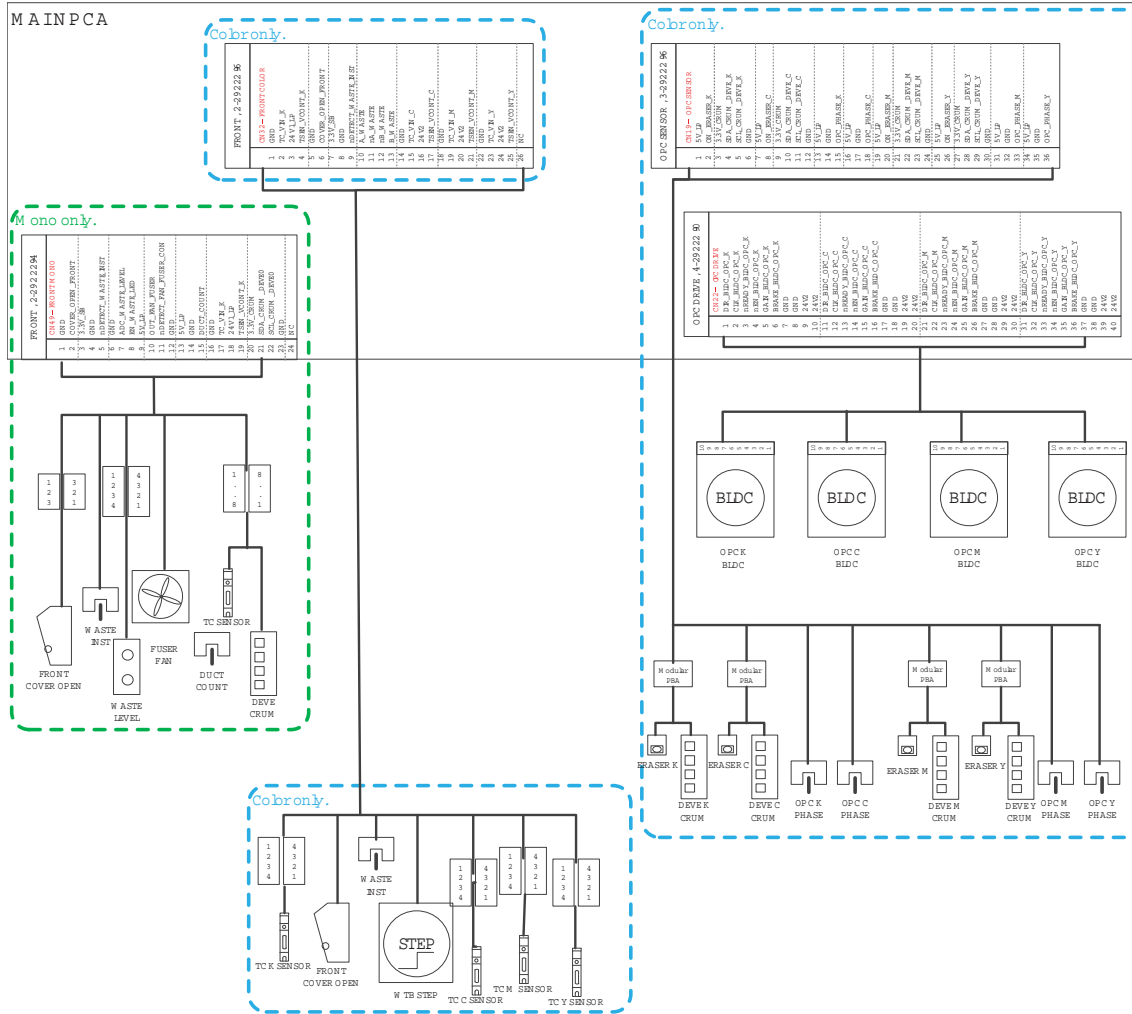
Figure 7-7 UI diagram



## Diagrams (FRONT/OPC)

Learn about the front OPC diagram.

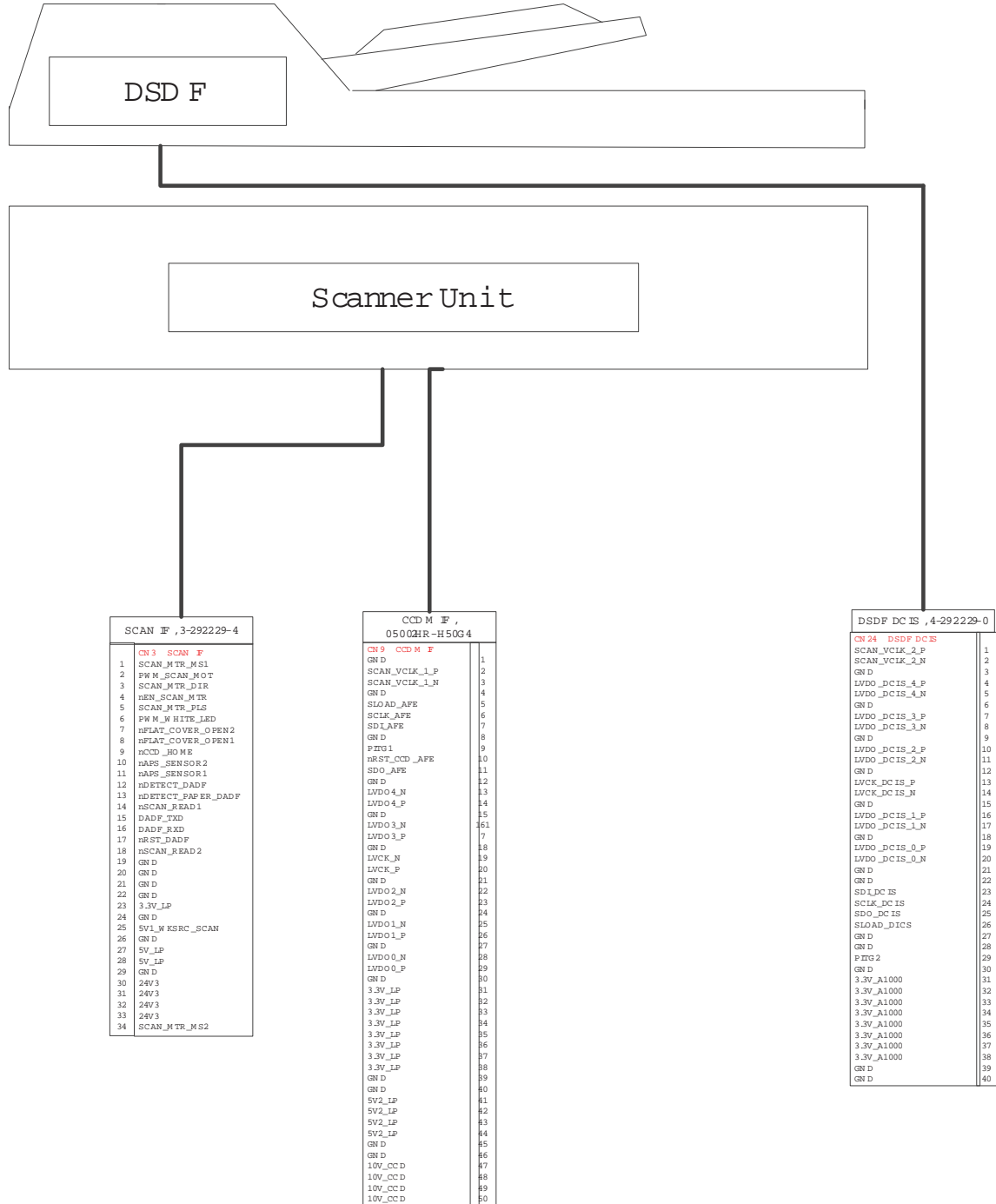
Figure 7-8 Front/OPC diagram



## Diagrams (scanner)

Learn about the scanner diagram.

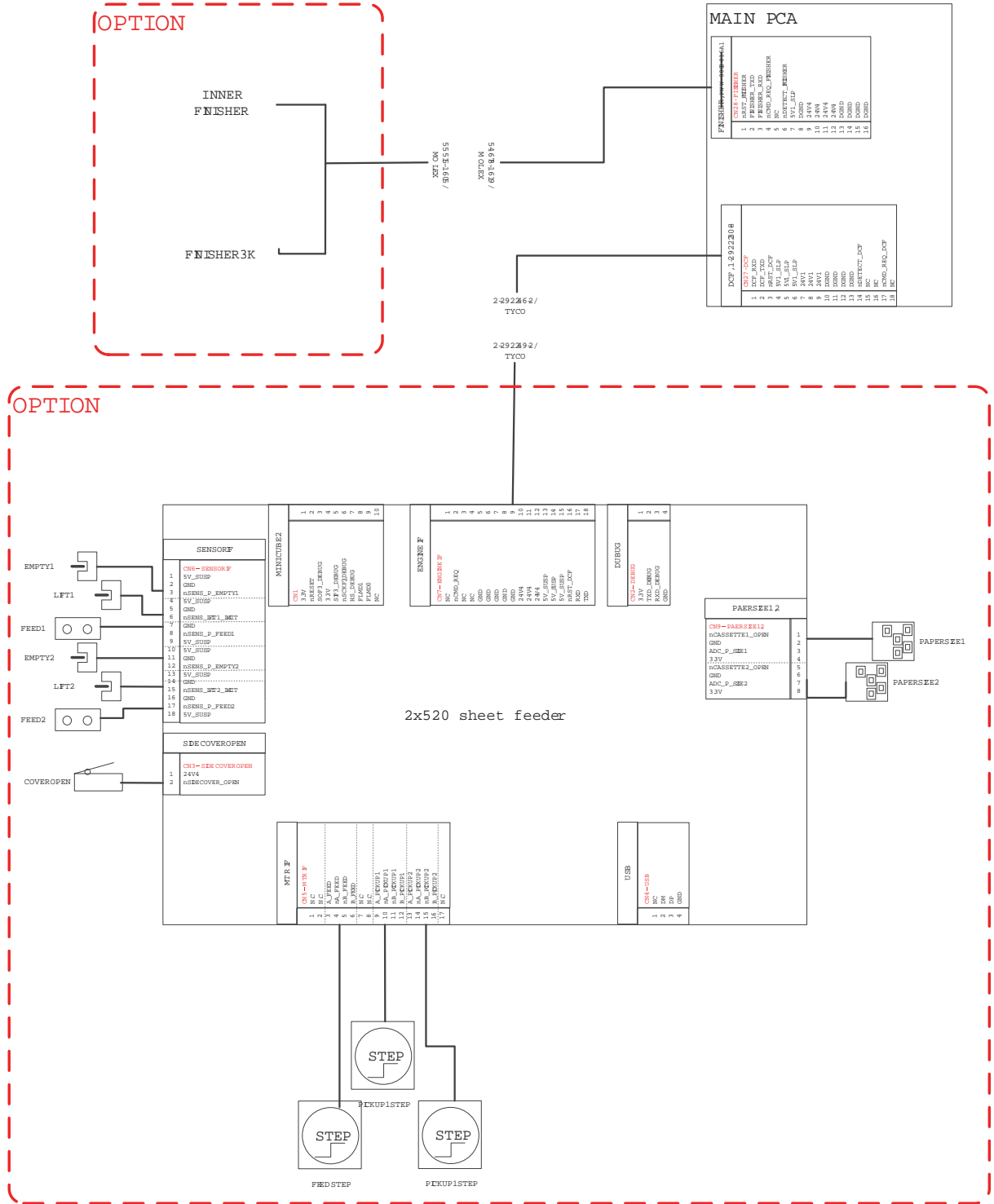
Figure 7-9 Scanner diagram



## Diagrams (Dual Cassette Feeder)

Learn about the Dual Cassette Feeder diagram.

Figure 7-10 2x520 sheet feeder diagram



---

# A Certificate of Volatility

[View the product certificates of volatility.](#)

## Certificate of Volatility (For 77822, 77825, 77830)

[Learn about the product certificate of volatility.](#)

Figure A-1 Certificate of Volatility (1 of 2)

Hewlett-Packard Certificate of Volatility				
<b>Model:</b> <b>HP Color LaserJet Managed MFP E778XXdn</b>  <b>HP Color LaserJet Managed Flow MFP E778XXz</b>		<b>Part Number:</b> <b>Managed</b> X3A78A= E77822dn X3A81A= E77825dn X3A84A= E77830dn X3A77A= E77822z X3A80A= E77825z X3A83A= E77830z		<b>Address:</b> Hewlett Packard Company 11311 Chinden Blvd Boise, ID 83714
Volatile Memory				
Does the device contain volatile memory (Memory whose contents are lost when power is removed)? <input checked="" type="checkbox"/> Yes <input type="checkbox"/> No If Yes please describe the type, size, function, and steps to clear the memory below				
Type (SRAM, DRAM, etc): <b>Z Bundles</b> DDR3 - DRAM	Size: <b>HP Formatter</b> 3GB- Obsidian 1 GB -Accel brd 4 GB - Main Formatter	User Modifiable: <input type="checkbox"/> Yes <input checked="" type="checkbox"/> No	Function: Operation system and print/scan buffer	Steps to clear memory: When the printer is powered off the memory is erased.
Type (SRAM, DRAM, etc): <b>dn Bundles</b> DDR3 - DRAM	Size: <b>HP Formatter</b> 3GB- Obsidian 4 GB - Main Formatter	User Modifiable: <input type="checkbox"/> Yes <input checked="" type="checkbox"/> No	Function:	Steps to clear memory: .
Type (SRAM, DRAM, etc):	Size:	User Modifiable: <input type="checkbox"/> Yes <input type="checkbox"/> No	Function:	Steps to clear memory:
Non-Volatile Memory				
Does the device contain non-volatile memory (Memory whose contents are retained when power is removed)? <input checked="" type="checkbox"/> Yes <input type="checkbox"/> No If Yes please describe the type, size, function, and steps to clear the memory below				
Type (Flash, EEPROM, etc): IOD EEPROM	Size: 32KB	User Modifiable: <input type="checkbox"/> Yes <input checked="" type="checkbox"/> No	Function: Store customer setting data for backup/restore	Steps to clear memory: There are no steps to clear this data.
Type (Flash, EEPROM, etc): <b>HP side: SPI Flash</b>	Size: 4MB	User Modifiable: <input checked="" type="checkbox"/> Yes <input type="checkbox"/> No	Function: Contains the boot code and factory product configuration data required for the device to function. User modifications are limited to downloading digitally signed HP firmware images.	Steps to clear memory: There are no steps to clear this data
Type (Flash, EEPROM, etc): Samsung MSOK : MSOK – TPM MSOK – CRUM MSOK - EEPROM	Size: 2 KB 256 Bytes 1 KB	User Modifiable: <input type="checkbox"/> Yes <input checked="" type="checkbox"/> No	Function: RSA Key Pair is stored on the TPM, HP-signed Immutable ID Certificate is stored on the CRUM, the new Key pair is saved on the EEPROM	Steps to clear memory: There are none. FW reload will handle any issues.

Figure A-2 Certificate of Volatility (2 of 2)

Mass Storage				
Does the device contain mass storage memory (Hard Disk Drive, Tape Backup)? <input checked="" type="checkbox"/> Yes <input type="checkbox"/> No If Yes please describe the type, size, function, and steps to clear the memory below				
Type (HDD, Tape, etc): <b>dn &amp; z Bundles</b> 1 – HDD Main board	Size: 320GB	User Modifiable: <input checked="" type="checkbox"/> Yes <input type="checkbox"/> No	Function: OS and user data	Steps to clear memory: Firmware update
dn bundles only 1 – EMMC card	16GB	Yes	OS and user data	Firmware update

USB
Does the item accept USB input and if so, for what purpose (i.e Print Jobs, device firmware updates, scan upload)? <input checked="" type="checkbox"/> Yes <input type="checkbox"/> No If Yes please describe below
Print jobs, HP digitally signed firmware upgrades, 3rd party application loading. USB ports can be disabled.
Can any data other than scan upload be sent to the USB device)? <input checked="" type="checkbox"/> Yes <input type="checkbox"/> No If Yes please describe below
Diagnostic service logs can be uploaded. Print files can be printed via a USB thumb drive.

RF/RFID	
Does the item use RF or RFID for receive or transmit of any data including remote diagnostics. (e.g. Cellular phone, Bluetooth) <input type="checkbox"/> Yes <input checked="" type="checkbox"/> No If Yes please describe below	
Purpose:	
Frequency:	Bandwidth:
Modulation:	Effective Radiate Power (ERP):
Specifications:	

Other Transmission Capabilities	
Does the device employ any other methods of non-wired access to transmit or receive any data whatsoever (e.g. anything other than standard hard wired TCP/IP, direct USB, or parallel connections)? <input checked="" type="checkbox"/> Yes <input type="checkbox"/> No If Yes please describe below:	
Purpose: WiFi Direct Print	
Frequency: 2.4 GHz, 5GHz	Bandwidth: 2401 - 2495 MHz; depending on selected channel in 2.4GHz band. 5180 - 5825 MHz; depending on selected channel in 5GHz band.
Modulation:	Effective Radiate Power (ERP):
Specifications: 802.11 b/g/n	

Other Transmission Capabilities	
Does the device employ any other methods of non-wired access to transmit or receive any data whatsoever (e.g. anything other than standard hard wired TCP/IP, direct USB, or parallel connections)? <input checked="" type="checkbox"/> Yes <input type="checkbox"/> No If Yes please describe below:	
Purpose: Device Beaconing, Secure Print Apps	
Frequency: 2.4 GHz	Bandwidth: 2400-2483.5 MHz; depending on selected channel.
Modulation:	Effective Radiate Power (ERP):
Specifications: BTLE4.0 compliant	

Other Capabilities
Does the device employ any other method of communications such as a Modem to transmit or receive any data whatsoever? <input type="checkbox"/> Yes <input checked="" type="checkbox"/> No If Yes please describe below:
Purpose:
Specifications:

## Certificate of Volatility (for E783xxdn)

Figure A-3 Certificate of Volatility (1 of 3)

Hewlett-Packard Certificate of Volatility				
<b>Model:</b> HP Color LaserJet Managed MFP E783xxdn		<b>Part Number:</b> Managed 8GR95A =E78323dn  8GR96A = E78325dn  8GR97A = E78330dn		<b>Address:</b> Hewlett Packard Company 11311 Chinden Blvd Boise, ID 83714
Volatile Memory				
Does the device contain volatile memory (Memory whose contents are lost when power is removed)? <input checked="" type="checkbox"/> Yes <input type="checkbox"/> No If Yes please describe the type, size, function, and steps to clear the memory below				
Type (SRAM, DRAM, etc): DDR3-DRAM	Size: HP Formatter (Obsidian) – 3GB ECB – 4GB	User Modifiable: <input type="checkbox"/> Yes <input checked="" type="checkbox"/> No	Function: Operation system and print/scan buffer	Steps to clear memory: When the printer is powered off the memory is erased
Type (SRAM, DRAM, etc):	Size:	User Modifiable: <input type="checkbox"/> Yes <input type="checkbox"/> No	Function:	Steps to clear memory: When the printer is powered off the memory is erased
Non-Volatile Memory				
Does the device contain non-volatile memory (Memory whose contents are retained when power is removed)? <input checked="" type="checkbox"/> Yes <input type="checkbox"/> No If Yes please describe the type, size, function, and steps to clear the memory below				
Type (Flash, EEPROM, etc): IOD EEPROM	Size: 64KB	User Modifiable: <input type="checkbox"/> Yes <input checked="" type="checkbox"/> No	Function: Store customer setting data for backup/restore	Steps to clear memory: There are no steps to clear this data.
Type (Flash, EEPROM, etc): HP side: SPI Flash	Size: 4MB	User Modifiable: <input checked="" type="checkbox"/> Yes <input type="checkbox"/> No	Function: Contains the boot code and factory product configuration data required for the device to function. User modifications are limited to downloading digitally signed HP firmware images.	Steps to clear memory: There are no steps to clear this data
Type (Flash, EEPROM, etc): MSOK : MSOK – TPM NVRAM MSOK – EEPROM MSOK – CRUM	Size: 256 KB 32 KB 120 KB	User Modifiable: <input type="checkbox"/> Yes <input checked="" type="checkbox"/> No	Function: TPM NVRAM - stores HP-signed immutable ID certificate and associated RSA key pair in locked memory. EEPROM - stores device lifecycle data (e.g. device page counts), copy of device speed license, and SED (self-encrypting drive) drive lock password. CRUM - stores device page counts, consumables information, device speed information, and product serial number.	Steps to clear memory: Drive lock password can be changed through the device embedded web server interface. No other data stored on the MSOK can be cleared.



Figure A-4 Certificate of Volatility (2 of 3)

Mass Storage				
Does the device contain mass storage memory (Hard Disk Drive, Tape Backup)? <input checked="" type="checkbox"/> Yes <input type="checkbox"/> No If Yes please describe the type, size, function, and steps to clear the memory below				
Type (HDD, Tape, etc.): 1 – HDD Main board SED Encrypted HDD	Size: 500GB	User Modifiable: <input checked="" type="checkbox"/> Yes <input type="checkbox"/> No	Function: Stores customer data, OS, applications, digitally signed firmware images, persistent data, and temporary data used for processing and system functions.	Steps to clear memory: 1. Secure Storage Erase – Areas temporary files and job data by overwriting information one or three times. 2. Secure Disk Erase – Erases files when jobs finish processing by overwriting them one or three times. 3. Secure File Erase – Erases files when jobs finish processing by overwriting them one or three times.
Type (HDD, Tape, etc.): 1 – EMMC card	Size: HP Formatter (Obsidian) – 16GB (Card) ECB – 4GB	User Modifiable: <input checked="" type="checkbox"/> Yes <input type="checkbox"/> No	Function: Stores customer data, OS, applications, digitally signed firmware images, persistent data, and temporary data used for processing and system functions.	Steps to clear memory: 1. Secure Fast Erase – Changes the encryption keys rendering all data in the customer partition unreadable. 2. Power Cycle of the printer – Deletes all customer data stored in the customer partition.

Optional Mass Storage				
Does the device contain mass storage memory (Hard Disk Drive, Tape Backup)? <input checked="" type="checkbox"/> Yes <input type="checkbox"/> No If Yes please describe the type, size, function, and steps to clear the memory below				
Type (HDD, Tape, etc.): Optional Formatter HDD FIPS Encrypted HDD  Optional Formatter HDD TAA Secure Encrypted HDD (Available AMS only)	Size: 500GB  500GB	User Modifiable: <input checked="" type="checkbox"/> Yes <input type="checkbox"/> No	Function: Stores customer data, OS, applications, digitally signed firmware images, persistent data, and temporary data used for processing and system functions.	Steps to clear memory: 1. Erase and Unlock Encrypted Disk – This changes the Encryption keys rendering all data unreadable. 2. Secure Storage Erase – Areas temporary files and job data by overwriting information one or three times. 3. Secure Disk Erase – Erases files when jobs finish processing 4. Secure File Erase – Erases files when jobs finish processing by overwriting them one or three times.

Figure A-5 Certificate of Volatility (3 of 3)

USB			
Does the item accept USB input and if so, for what purpose (i.e Print Jobs, device firmware updates, scan upload)? <input checked="" type="checkbox"/> Yes <input type="checkbox"/> No If Yes please describe below			
Print jobs, HP digitally signed firmware upgrades, 3rd party application loading. USB ports can be disabled.			
Can any data other than scan upload be sent to the USB device? <input checked="" type="checkbox"/> Yes <input type="checkbox"/> No If Yes please describe below			
Diagnostic service logs can be uploaded. Print files can be printed via a USB thumb drive.			
RF/RFID			
Does the item use RF or RFID for receive or transmit of any data including remote diagnostics. (e.g. Cellular phone, Bluetooth) <input type="checkbox"/> Yes <input checked="" type="checkbox"/> No If Yes please describe below			
Purpose:			
Frequency:		Bandwidth:	
Modulation:		Effective Radiate Power (ERP):	
Specifications:			
Other Transmission Capabilities			
Does the device employ any other methods of non-wired access to transmit or receive any data whatsoever (e.g. anything other than standard hard wired TCP/IP, direct USB, or parallel connections)? <input checked="" type="checkbox"/> Yes <input type="checkbox"/> No If Yes please describe below:			
Purpose: WiFi Direct Print			
Frequency: 2.4 GHz, 5GHz		Bandwidth: 2401 - 2495 MHz; depending on selected channel in 2.4GHz band. 5180 - 5825 MHz; depending on selected channel in 5GHz band.	
Modulation:		Effective Radiate Power (ERP):	
Specifications: 802.11 b/g/n			
Other Transmission Capabilities			
Does the device employ any other methods of non-wired access to transmit or receive any data whatsoever (e.g. anything other than standard hard wired TCP/IP, direct USB, or parallel connections)? <input checked="" type="checkbox"/> Yes <input type="checkbox"/> No If Yes please describe below:			
Purpose: Device Beaconsing, Secure Print Apps			
Frequency: 2.4 GHz		Bandwidth: 2400-2483.5 MHz; depending on selected channel.	
Modulation:		Effective Radiate Power (ERP):	
Specifications: BTLE4.0 compliant			
Other Capabilities			
Does the device employ any other method of communications such as a Modem to transmit or receive any data whatsoever? <input type="checkbox"/> Yes <input checked="" type="checkbox"/> No If Yes please describe below:			
Purpose:			
Specifications:			
Author Information			
Name	Title	Email	Business Unit
Jaeseung Jang	Technical Marketing Engineer	jaeseung.jang@hp.com	IPG
LEE, JAESUNG	HW Asset Engineer	jaesung.lee@hp.com	IPG
Date Prepared: 3/30/2020			

## Certificate of Volatility (for E783xxz)

Figure A-6 Certificate of Volatility (1 of 3)

Hewlett-Packard Certificate of Volatility				
<b>Model:</b> HP Color LaserJet Managed MFP E783XXz		<b>Part Number:</b> Managed 8GR99A =E78323z  8GS00A = E78325z  8GS01A = E78330z		<b>Address:</b> Hewlett Packard Company 11311 Chinden Blvd Boise, ID 83714
Volatile Memory				
Does the device contain volatile memory (Memory whose contents are lost when power is removed)? <input checked="" type="checkbox"/> Yes <input type="checkbox"/> No If Yes please describe the type, size, function, and steps to clear the memory below				
Type (SRAM, DRAM, etc):	Size:	User Modifiable:	Function:	Steps to clear memory:
DDR3-DRAM	HP Formatter (Rock) – 4GB ECB – 4GB	<input type="checkbox"/> Yes <input checked="" type="checkbox"/> No	Operation system and print/scan buffer	When the printer is powered off the memory is erased
Type (SRAM, DRAM, etc):	Size:	User Modifiable:	Function:	Steps to clear memory:
		<input type="checkbox"/> Yes <input type="checkbox"/> No		When the printer is powered off the memory is erased
Non-Volatile Memory				
Does the device contain non-volatile memory (Memory whose contents are retained when power is removed)? <input checked="" type="checkbox"/> Yes <input type="checkbox"/> No If Yes please describe the type, size, function, and steps to clear the memory below				
Type (Flash, EEPROM, etc):	Size:	User Modifiable:	Function:	Steps to clear memory:
IOD EEPROM	64KB	<input type="checkbox"/> Yes <input checked="" type="checkbox"/> No	Store customer setting data for backup/restore	There are no steps to clear this data.
Type (Flash, EEPROM, etc):	Size:	User Modifiable:	Function:	Steps to clear memory:
HP side: SPI Flash	4MB	<input checked="" type="checkbox"/> Yes <input type="checkbox"/> No	Contains the boot code and factory product configuration data required for the device to function. User modifications are limited to downloading digitally signed HP firmware images.	There are no steps to clear this data
Type (Flash, EEPROM, etc):	Size:	User Modifiable:	Function:	Steps to clear memory:
MSOK : MSOK – TPM NVRAM MSOK – EEPROM MSOK – CRUM	256 KB 32 KB 120 KB	<input type="checkbox"/> Yes <input checked="" type="checkbox"/> No	TPM NVRAM - stores HP-signed immutable ID certificate and associated RSA key pair in locked memory. EEProm - stores device lifecycle data (e.g. device page counts), copy of device speed license, and SED (self-encrypting drive) drive lock password. CRUM - stores device page counts, consumables information, device speed information, and product serial number.	Drive lock password can be changed through the device embedded web server interface. No other data stored on the MSOK can be cleared.

Figure A-7 Certificate of Volatility (2 of 3)

Mass Storage				
Does the device contain mass storage memory (Hard Disk Drive, Tape Backup)? <input checked="" type="checkbox"/> Yes <input type="checkbox"/> No If Yes please describe the type, size, function, and steps to clear the memory below				
Type (HDD, Tape, etc.): 2 – Hard Drivers (1 – Formatter & 1 – ECB) 1- ECB HDD SED Encrypted HDD 2- HP Formatter FIPS Encrypted HDD	Size: 500GB  500GB  500GB	User Modifiable: <input checked="" type="checkbox"/> Yes <input type="checkbox"/> No	Function: Stores customer data, OS, applications, digitally signed firmware images, persistent data, and temporary data used for processing and system functions.	Steps to clear memory: 1. Secure Storage Erase – Areas temporary files and job data by overwriting information overwriting information one or three times. 2. Secure Disk Erase – Erases files when jobs finish processing by overwriting them one or three times. 3. Secure File Erase – Erases files when jobs finish processing by overwriting them one or three times.

Optional Mass Storage				
Does the device contain mass storage memory (Hard Disk Drive, Tape Backup)? <input checked="" type="checkbox"/> Yes <input type="checkbox"/> No If Yes please describe the type, size, function, and steps to clear the memory below				
Type (HDD, Tape, etc.): Optional Formatter HDD FIPS Encrypted HDD  Optional Formatter HDD TAA Secure Encrypted HDD (Available AMS only)	Size: 500GB  500GB	User Modifiable: <input checked="" type="checkbox"/> Yes <input type="checkbox"/> No	Function: Stores customer data, OS, applications, digitally signed firmware images, persistent data, and temporary data used for processing and system functions.	Steps to clear memory: 1. Erase and Unlock Encrypted Disk – This changes the Encryption keys rendering all data unreadable. 2. Secure Storage Erase – Areas temporary files and job data by overwriting information overwriting information one or three times. 3. Secure Disk Erase – Erases files when jobs finish processing 4. Secure File Erase – Erases files when jobs finish processing by overwriting them one or three times.

Figure A-8 Certificate of Volatility (3 of 3)

USB			
Does the item accept USB input and if so, for what purpose (i.e Print Jobs, device firmware updates, scan upload)? <input checked="" type="checkbox"/> Yes <input type="checkbox"/> No If Yes please describe below			
Print jobs, HP digitally signed firmware upgrades, 3rd party application loading. USB ports can be disabled.			
Can any data other than scan upload be sent to the USB device? <input checked="" type="checkbox"/> Yes <input type="checkbox"/> No If Yes please describe below			
Diagnostic service logs can be uploaded. Print files can be printed via a USB thumb drive.			
RF/RFID			
Does the item use RF or RFID for receive or transmit of any data including remote diagnostics. (e.g. Cellular phone, Bluetooth) <input type="checkbox"/> Yes <input checked="" type="checkbox"/> No If Yes please describe below			
Purpose:			
Frequency:		Bandwidth:	
Modulation:		Effective Radiate Power (ERP):	
Specifications:			
Other Transmission Capabilities			
Does the device employ any other methods of non-wired access to transmit or receive any data whatsoever (e.g. anything other than standard hard wired TCP/IP, direct USB, or parallel connections)? <input checked="" type="checkbox"/> Yes <input type="checkbox"/> No If Yes please describe below:			
Purpose: WiFi Direct Print			
Frequency: 2.4 GHz, 5GHz		Bandwidth: 2401 - 2495 MHz; depending on selected channel in 2.4GHz band. 5180 - 5825 MHz; depending on selected channel in 5GHz band.	
Modulation:		Effective Radiate Power (ERP):	
Specifications: 802.11 b/g/n			
Other Transmission Capabilities			
Does the device employ any other methods of non-wired access to transmit or receive any data whatsoever (e.g. anything other than standard hard wired TCP/IP, direct USB, or parallel connections)? <input checked="" type="checkbox"/> Yes <input type="checkbox"/> No If Yes please describe below:			
Purpose: Device Beaconsing, Secure Print Apps			
Frequency: 2.4 GHz		Bandwidth: 2400-2483.5 MHz; depending on selected channel.	
Modulation:		Effective Radiate Power (ERP):	
Specifications: BTLE4.0 compliant			
Other Capabilities			
Does the device employ any other method of communications such as a Modem to transmit or receive any data whatsoever? <input type="checkbox"/> Yes <input checked="" type="checkbox"/> No If Yes please describe below:			
Purpose:			
Specifications:			
Author Information			
Name	Title	Email	Business Unit
Jaeseung Jang	Technical Marketing Engineer	jaeseung.jang@hp.com	IPG
LEE, JAESUNG	HW Asset Engineer	jaesung.lee@hp.com	IPG
Date Prepared: 3/30/2020			



# B Service parts changes For Environmental Protection Agency 3.0 Compliant Products

Learn about service part changes for EPA compliance.

HP is introducing A3 Laser Jet MFPs to meet the new Environmental Protection Agency (EPA) 3.0 Compliance standards. A few service parts are changing even though their appearance and ways of replacing them are almost the same as before. These new regulations are primarily concerned with lower power consumption which the parts affected contribute to. All Items listed in this document are service parts being changed for these EPA 3.0 Compliant products.

Theses EPA 3.0 compliant devices will begin manufacturing in Spring 2020 and will not have new product numbers. Identification of these products will be accomplished by a specific character in their serial numbers.

## Printer service parts affected

- Formatter
- FDB (Fuser Drive Board)
- Fuser unit

## Printer service parts affected

- HP Color LaserJet Managed MFP **E77822dn / E77825dn** / E77830dn
- HP Color LaserJet Managed Flow MFP **E77822z / E77825z** / E77830z
- HP Color LaserJet Managed MFP **E77422a / E77422dv/ E77422dn** / E77428dn
- HP LaserJet Managed MFP **E72525dn / E72530dn** / E72535dn
- HP LaserJet Managed Flow MFP **E72525z / E72530z** / E72535z
- HP LaserJet Managed MFP **E72425a / E72425dv / E72425dn** / E72430dn

\* Parts referenced in this doc are also compatible with the SKU's above. However, installation of these parts in the SKU's in **BOLD** will not make them EPA 3.0 compliant. Only SKU's identified by a specific character in their serial number are EPA 3.0 compliant.

Table B-1 E77822z/E77825z/E77830z (color printers)

Item	Description
1	Formatter Rock

**Table B-1** E77822z/E77825z/E77830z (color printers) (continued)

Item	Description
2	FDB V1
3	FDB V2

**Table B-2** E77822dn/E77825dn/E77830dn (color printers)

Item	Description
1	Formatter Obisidian1
2	FDB V1
3	FDB V2

**Table B-3** E77422a/E77428dv/E77422dn/E77428dn (color printers)

Item	Description
1	Formatter Obisidian2
2	FDB V1
3	FDB V2

**Table B-4** E72525z/E72530z/E72535z (mono printers)

Item	Description
1	Formatter Rock
2	FDB V1
3	FDB V2
4	Fuser V1
5	Fuser V2

**Table B-5** E72525dn/E72530dn/E72535dn (mono printers)

Item	Description
1	Formatter Obisidian1
2	FDB V1
3	FDB V2
4	Fuser V1
5	Fuser V2



**Table B-6** E72425a/E72425dv/E72425dnE72430dn (mono printers)

Item	Description
1	Formatter Obisidian2
2	FDB V1
3	FDB V2
4	Fuser V1
5	Fuser V2

**Table B-7** Foramtter type 1/2/3

No	Legacy part number	EPA 3.0 compliant product	Common	Part name	Description	Remark
1	JC92-03070A	Y3K99-60005	New	Formatter	Rock PCA	Formatter_Rock
1	JC92-03005A	X3A92-60006	New	Formatter	Obsidian PCA	Formatter_Obisidian1
1	JC92-03036A	X3A92-60007	New	Formatter	Obsidian PCA	Formatter_Obisidian2

**Table B-8** FDB V1/V2

No	Legacy part number	EPA 3.0 compliant product	Common	Part name	Description	Remark
2	JC44-00210E	8GR94-60001	New	FDB	110V(V1)	FDB V1
3	JC44-00211E	8GR94-60002	New	FDB	220V(V2)	FDB V1

**Table B-9** Fuser V1/V2

No	Legacy part number	EPA 3.0 compliant product	Common	Part name	Description	Remark
4	JC82-00479A	X3A65-61001	New	Fuser	110V(V1)	Fuser V1
5	JC82-00481A	X3A65-61002	New	Fuser	220V(V2)	Fuser V1

## Notes

- Service parts referenced above for legacy products (Gemstone 1.0/1.1) and EPA 3.0 Compliant products are forward and backward compatible. **However, Hp does not recommend installing old service parts which do not meet EPA 3.0 Compliance in EPA 3.0 Compliant products.** This is to ensure these products remain EPA 3.0 compliant after field service.
- If an EPA 3.0 Compliant FUSER is installed in any printer, **that unit needs to have firmware upgraded to the latest level to function properly, especially those with a B or C in 3rd digit of serial number (SN).**

- EPA 3.0 Compliant products will be identified as indicated below : 3rd digit will be shown as “D” from “B” or “C”.



---

# Glossary of terms

## **802.11**

802.11 is a set of standards for wireless local area network (WLAN) communication, developed by the IEEE LAN/MAN Standards Committee (IEEE 802).

## **802.11b/g/n**

802.11b/g/n can share the same hardware and use the 2.4 GHz band. 802.11b supports bandwidth up to 11 Mbps, 802.11n supports bandwidth up to 150 Mbps. 802.11b/g/n devices might occasionally suffer interferences from microwave ovens, cordless telephones, and Bluetooth devices.

## **AC**

An electric current that reverses its direction many times a second at regular intervals. For example, the 110V line current found in a typical US electrical wall receptacle.

## **AC Control Module (PageWide)**

The AC Control Module controls the heating elements in the airflow assembly. Function include: voltage monitoring (ensuring correct operation in a low-quality-power environment), isolation (low voltage heater control signals are isolated from the high voltage AC power for safety), AC switching (power is switched on/off to the heater), and heating element configuration (heating element configuration is changed between series and parallel for temperature predictability).

## **ADF**

An Automatic Document Feeder (ADF) is a device that automatically feeds an original sheet (or multiple sheets) of paper into the image scanner. The document feeder is a component of the integrated scanner assembly (ADF and image scanner).

## **Airflow System (PageWide)**

The airflow system conditions the printed pages to avoid page curling due to the ink on the page. The airflow system functionally consists of a fan and heating elements. The pressurized air is blown on the page through the nozzles that are placed on the paper path of the airflow system between print and eject zone.

## **BOOTP**

Bootstrap Protocol. A network protocol used by a network client to obtain its IP address automatically. This is usually done in the bootstrap process of computers or operating systems running on them. The BOOTP servers assigns an IP address from a pool of addresses to each client. BOOTP enables “diskless workstation” computers to obtain an IP address prior to loading any advanced operating system.

## **CCD**

A Charged Coupled Device (CCD) is the scanner module which enables a scan job. A CCD locking mechanism is used to hold the CCD module to prevent any damage when the printer is moved.

## **CIS**

A Contact Image Sensor (CIS) scanner captures an image using the printer's optical path. Red, green, and blue LEDs sequentially illuminate a small strip of the document (often called a raster line), and the optical system captures each color in a single row of Charged Coupled Device (CCD) sensors that cover the entire page width.

**Collation**

Collation is a process of printing a multiple-copy job in sets. When collation is selected, the device prints an entire set before printing additional copies.

**Control Panel**

The control panel is a flat, typically vertical panel or screen where the user can control and/or monitor the printer. The control panel is found on the front of the printer.

**Coverage**

Coverage is the printing term used for a toner usage measurement on printing. For example, 5% coverage means that an A4 sided paper has about 5% image or text on it. If the paper or original has complicated images or a large amount of text, the coverage will be higher and at the same time, a toner usage will be as much as the coverage.

**DC**

An electric current flowing in one direction only. Typically a low voltage load current supplied to an electrical assembly.

**DCC**

The DC controller (DCC) controls the operation of the printer sub-systems and electrical components. The DCC sends out various signals to operate motors, solenoids, and other printer components based on the print command and image data that the host computer sends the formatter.

**Default**

The value or setting that is in effect when a printer is unboxed, reset, or initialized.

**DHCP**

Dynamic Host Configuration Protocol (DHCP) is a client-server networking protocol. A DHCP server provides configuration parameters specific to the DHCP client host requesting, generally, information required by the client host to participate on an IP network. The DHCP also provides a mechanism for allocation of IP addresses to client hosts.

**Digital Send Software**

Digital send software allows a multi-function printer (MFP) to scan and send information quickly and securely to email, network folders, other printers, and fax services.

**DIMM**

A Dual Inline Memory Module (DIMM) is a small circuit board that holds memory. The DIMM stores all data within the printer, such as printing data and received fax data.

**DPI**

Dots Per Inch (DPI) is a measurement of resolution that is used for scanning and printing. Generally, higher DPI results in a higher resolution (more visible detail in the image and a larger file size).

**Duplex**

A mechanism that automatically turns over a sheet of paper so that the printer can print (or scan) on both sides of the paper. A printer equipped with a duplex unit can print on both sides of the paper during one print cycle.

**Duty Cycle**

Duty cycle is the page quantity which does not affect printer performance for a month. Generally, the printer has the lifespan limitation such as pages per year. The lifespan means the average capacity of print-outs, usually within the warranty period. For example, if the duty cycle is 48,000 pages per month the printer limit is 2,400 pages a day (assuming 20 working days/month).

**Dynamic Security**

Dynamic Security is a toner cartridge design and process for authenticating genuine HP supplies. HP printers use toner cartridges that have security chips or electronic circuitry. Cartridges using a non-HP chip or modified or non-HP circuitry might not work (now or in the future).

**e-Duplex**

Single-pass electronic duplex (e-Duplex) printer use two separate scan modules to scan the front-side and back-side of an e-duplex copy job page in a single pass through the document feeder.

**EMC**

EMC is a measure of a device's ability to operate as intended in its shared operating environment while, at the same time, not affecting the ability of other equipment within the same environment to operate as intended.

**EMI**

EMI is the electromagnetic energy which affects the functioning of an electronic device. Electronic devices (like printers) are a source of EMI. Because it is rare for electronics to operate in isolation, products are generally engineered to function in the presence of some amount of EMI.

**eMMC**

An embedded Multi-Media Card is a compact memory device consisting of NAND flash memory and a simple storage controller.

**Emulation**

Emulation is a technique of one machine obtaining the same results as another. An emulator duplicates the functions of one system with a different system, so that the second system behaves like the first system. Emulation focuses on exact reproduction of external behavior. This is different from simulation, which concerns an abstract model of the system being simulated, often considering its internal state.

**EPS**

Encapsulated PostScript (EPS) is a PostScript (PS) code file which is used for storing font and vector graphic image information.

**ESD**

An electrostatic discharge (ESD) is a sudden flow of electricity between two electrically charged objects caused by contact, an electrical short, or dielectric breakdown. Discharge of built up static electricity.

**Ethernet**

Ethernet is a frame-based computer networking technology for local area networks (LANs). It defines wiring and signaling for the physical layer, and frame formats and protocols for the media access control (MAC)/data link layer of the OSI model. Ethernet is mostly standardized as IEEE 802.3. Ethernet has become the most widespread LAN technology in use during the 1990s to present.

**Ferrite**

A ferrite are used to reduce the amount of radio frequency noise (or interference) in a wire or cable. A ferrite enables proper EMC/EMI performance for regulatory purposes.

**FFC**

Flat Flexible Cables (FFCs) are designed for Printed Circuit Assembly (PCA) to PCA connections (for example, connecting a fax PCA to the formatter).

**FIH**

A Foreign Interface Harness (FIH) is a port that enables HP multifunction printers (MFPs) to use third-party devices to extend the capabilities of the MFP.

**Firmware**

The formatter stores the printer firmware. A remote firmware upgrade process is used to overwrite and upgrade the firmware.

**Flash memory**

Flash memory is non-volatile, meaning it retains stored data even when the power is turned off.

**Flow integrated scanner assembly**

A printer scanner assembly that includes a slide-out external physical keyboard.

**Formatter (LaserJet)**

The formatter controls printer functions like receiving and processes print data, developing and coordinating data placement and timing with the DC controller PCA, storing font and customer configuration information, communicating with the host computer, and monitoring control panel functions and relaying printer status information through the control panel.

**FTP**

FTP stands for File Transfer Protocol. FTP is a protocol designed for transferring files over the Internet. Files stored on an FTP server can be accessed using an FTP client, such as a web browser, FTP software program, or a command line interface.

**Fuser Unit**

The fuser unit is part of a laser printer that adheres the toner onto the printed page. It consists of a heat roller and a pressure roller. After toner is transferred onto the paper, the fuser unit applies heat and pressure to make sure that the toner stays on the paper permanently (which is why paper is warm when it comes out of a laser printer).

**Gateway**

A connection between computer networks, or between a computer network and a telephone line. A gateway is used to connect two different computer networks, especially a connection to the Internet.

**Grayscale**

Shades of gray that represent light and dark portions of a color image printed in monochrome. Colors are represented by a range of gray shades from white to black.

**Halftone**

Halftone is a way of reproducing a photograph or other image in which the various tones of gray or color are produced by variously sized dots of ink or toner. Halftone simulates grayscale by varying the number of dots. Highly colored areas consist of a large number of dots, while lighter areas consist of a smaller number of dots.

**HDD**

A Hard-Disk Drive (HDD) (commonly referred to as a hard drive or hard disk) is a non-volatile storage device which stores digitally-encoded data on rapidly rotating platters with magnetic surfaces.

**IEEE**

The Institute of Electrical and Electronics Engineers (IEEE) is an international non-profit, professional organization for the advancement of technology related to electricity.

**Image scanner**

The image scanner (or Sub Scanner Assembly) contains the components to digitally scan an original source document. The image scanner is a component of the integrated scanner assembly (ADF and image scanner).

**IP address**

An Internet Protocol (IP) address is a unique number that a device uses in order to identify and communicate with other devices on a network utilizing the Internet Protocol standard.

**IPM**

The Images Per Minute (IPM) is a method of measuring the speed of a printer. An IPM rate indicates the number of single-sided sheets a printer can complete in one minute.

**IPP**

The Internet Printing Protocol (IPP) defines a standard protocol for printing and managing print jobs, media size, resolution, etc. IPP can be used locally, or over the internet to reach hundreds of printers. IPP also supports access control, authentication, and encryption, making it a capable and secure printing solution.

**ISA**

The Integrated Scanner Assembly (ISA) includes the document feeder and image scanner.

**ISO**

The International Organization for Standardization (ISO) is an international standard-setting body composed of representatives from national standards bodies. It produces world-wide industrial and commercial standards.

**JBIG**

Joint Bi-level Image Experts Group (JBIG) is an image compression standard with no loss of accuracy or quality. It was designed for compression of binary images, particularly for faxes, but can also be used for other images.

**JPEG**

Joint Photographic Experts Group (JPEG) is a commonly used standard method of loss compression for photographic images. It is the format used for storing and transmitting photographs on the World Wide Web.

**LDAP**

The Lightweight Directory Access Protocol (LDAP) is a networking protocol for querying and modifying directory services running over TCP/IP.

**LED**

A Light-Emitting Diode (LED) is a semiconductor device that can indicate the status of a printer (formatter LEDs) or a component in a contact image sensor (CIS) scanner that helps capture an image.

**LEDM**

Low end data model (LEDM) provides one consistent data representation method and defines the dynamic and capabilities tickets shared between clients and devices, as well as the access protocol, event, security, and discovery methods.

**LPDC**

Late point differentiation configuration (LPDC) allows the channel partner to configure the speed to the printer depending on the customer's order. LPDC configuration is stored on the Trusted Platform Module (TPM).

**LVPS - SMPS**

Low Voltage Power Supplies (LVPS) and Switching Mode Power Supplies (SMPS) supply direct current (DC) voltages to various printer components and assemblies.

**MAC address**

Media Access Control (MAC) address is a unique identifier associated with a network adapter. MAC address is a unique 48-bit identifier usually written as 12 hexadecimal characters grouped in pairs (for example, 00-00-0c-34-11-4e). This address is usually hard-coded into a Network Interface Card (NIC) by the manufacturer, and used as an aid for routers trying to locate machines on a large network.

**MEt**

HP Memory Enhancement technology (MEt) effectively doubles the standard memory through a variety of font- and data-compression methods. MEt is available only in Printer Command Language (PCL) mode; it is not functional when printing in PostScript (PS) mode.

**MFP**

A Multi Function Printer (MFP) is a printer that incorporates multiple functionality in a single physical body. For example, an MFP printer can scan, digitally send, fax, copy, and print.

**MHV**

Miniature High Voltage (MHV) is designed for high voltage applications of BNC connectors (DC voltage between 500 V and 5 kV).

**Modem**

A device that modulates a carrier signal to encode digital information, and also demodulates such a carrier signal to decode transmitted information.

**MPCA (PageWide)**

The MPCA integrates both formatter (LaserJet) and engine control electronics (DC controller) into a single assembly. The Main PCA (MPCA) controls printer functions like receiving and processes print data, developing and coordinating data placement, storing font and customer configuration information, communicating with the host computer, and monitoring control panel functions and relaying printer status information through the control panel.

**NAND**

NAND is not an acronym (the term is short for **NOT AND** a Boolean operator and logic gate). NAND (flash) memory is non-volatile, meaning it retains stored data even when the power is turned off.

**NVRAM**

Nonvolatile random access memory (NVRAM) is used to store I/O and information about the print environment configuration (stored data even when the power is turned off).

**OPC**

Organic Photo Conductor (OPC) is a mechanism that makes a virtual image for print using a laser beam emitted from a laser printer. It is usually green or rust colored and has a cylinder shape. An imaging unit containing a drum slowly wears the drum surface during its usage in the printer, and it should be replaced appropriately due to wear from contact with the cartridge development brush, cleaning mechanism, and paper.

**Originals**

The first example of something, such as a document, photograph, or text which is copied, reproduced, or translated to produce additional copies. The original itself is not copied or derived from something else.

**PCA**

Printed Circuit Assembly (PCA). Once the printed circuit board (PCB) is complete, electronic components must be assembled to form a functional printed circuit assembly or PCA.

**PCL**

Printer Command Language (PCL) is a Page Description Language (PDL) developed by HP as a printer protocol. PCL has become an industry standard. Originally developed for early Inkjet printers, PCL has been released in varying levels for thermal, dot matrix printers and laser printers.

**PDF**

Portable Document Format (PDF) is a proprietary file format developed by Adobe Systems. A PDF represents two dimension documents in a device independent and resolution independent format.

**PJL**

Printer job language (PJL) is an integral part of printer configuration, in addition to the standard PCL and PostScript (PS). With standard cabling, the printer can use PJL to perform a variety of functions like dynamic I/O switching, context-sensitive switching, and isolation of print environment settings from one print job to the next.

**PML**

Printer management language (PML) allows remote configuration of the printer and status read-back from the printer through the I/O ports.

**PostScript (PS)**

PostScript (PS) is a Page Description Language (PDL) and programming language used primarily in electronic and desktop publishing. PostScript is run in an interpreter to generate an image.

**PPM**

Pages Per Minute (PPM) is a method of measurement for determining how fast a printer works, meaning the number of pages a printer can produce in one minute.

**Print Media**

Media like paper, envelopes, labels, and transparencies which can be used in a printer, scanner, fax, or copier.

**Printer Driver**

A program used to send commands and transfer data from the computer to the printer.

**Printhead (PageWide)**

The printhead converts the digital firing instructions from the printer electronics into properly formed and timed microscopic drops of the four ink colors.



**Printhead Wiper (PageWide)**

The printhead wiper system keeps the printhead nozzles firing correctly throughout the life of the printer as it performs the wiping and capping functions. The wiping function cleans the nozzles of ink residue and particulates. The capping function keeps the nozzles moist during storage and when the printer is idle.

**Protocol**

A convention or standard that controls or enables the connection, communication, and data transfer between two computing endpoints.

**RAM**

Random Access Memory (RAM) is the printer memory device where the data in current use is kept so it can be quickly retrieved by the device's processor. This memory is an important factor in avoiding errors and printing documents properly. Printer memory is used to store and process print jobs as they are sent to the printer from a computer. After printing, the job is cleared from the memory to make room for more print jobs. Printer memory is directly linked to two print characteristics: speed and print quality. More memory allows you to print faster and print larger, high-quality graphics.

**Resolution**

The sharpness of an image, measured in Dots Per Inch (DPI). The higher the DPI, the greater the resolution.

**SCB**

The Scanner Control Board (SCB) controls the functions of the image scanner components in the Sub Scanner Assembly (SSA).

**Service fluid and aerosol management systems (PageWide)**

There are two types of service fluid, shipping fluid and ink. The service fluid management system is contained entirely within the duplex module. Service fluid is discharged as droplets from the printhead, and then collected in a container inside the duplex module. Some of the droplets are called aerosol because they are lighter than air. Aerosol can float inside the printer and collect on the lens of optical sensors, producing false failures. The aerosol management system transports the aerosol and collects it in a safe place. Aerosol management consists of an aerosol fan, mounted on the rear wall of the air flow assembly, which creates air flow that pulls the aerosol through the holes in the platen and into the aerosol filter inside the duplex module.

**SFP**

A single-function printer only processes print jobs sent from a host computer or from an USB port on the printer.

**SMB**

Server Message Block (SMB) is a network protocol mainly applied to share files, printers, serial ports, and miscellaneous communications between nodes on a network. SMB also provides an authenticated inter-process communication mechanism.

**SMTP**

Simple Mail Transfer Protocol (SMTP) is the standard for email transmissions across the internet. SMTP is a relatively simple, text-based protocol, where one or more recipient of a message are specified and the message text is transferred. It is a client server protocol where the client transmits an email message to the server.

**SODIMM**

Small outline dual in-line memory module (SODIMM) is a thin profile memory storage device (a smaller alternative to a standard DIMM device).

**SSA**

The Sub-Scanner Assembly is the image scanner component of the Integrated Scanner Assembly (ISA; which includes the document feeder and the image scanner).

**Subnet Mask**

The subnet mask is used in conjunction with the network address to determine which part of the address is the network address and which part is the host address.

**TCP/IP**

The Transmission Control Protocol (TCP) and the Internet Protocol (IP) are the set of communications protocols that implement the protocol stack on which the internet and most commercial networks run.

**TIFF**

Tagged Image File Format (TIFF) is a variable-resolution bit mapped image format. TIFF describes image data that typically come from scanners. TIFF images use tags, keywords defining the characteristics of the image that is included in the file. This flexible and platform-independent format can be used for pictures that have been made by various image processing applications.

**Toner Cartridge**

A bottle or container that holds toner, which is used in a machine like a printer. Toner is a powder used in laser printers and photocopiers. The toner forms the text and images on printed paper. Toner can be fused by a combination of heat/pressure from the fuser, causing it to bind the fibers in the paper.

**TPM**

The HP Trusted Platform Module (TPM) is a security accessory for printers. The TPM strengthens protection of encrypted credentials and data stored on your printer. Certificate private keys are both generated by and protected by the TPM. Once installed, the printer and the TPM are sealed and the printer owns the TPM. The TPM may not be moved to another device without losing its ownership from the original printer. Installing a TPM accessory might necessitate a firmware upgrade. The TPM prevents the printer from starting if the TPM is missing. If the TPM is removed from the printer, a control-panel error message appears indicating that the TPM is missing.

**TWAIN**

An industry standard for scanners and software. By using a TWAIN compliant scanner with TWAIN-compliant software, a scan can be initiated from the program. TWAIN is an image capture API for Microsoft Windows and Apple Macintosh operating systems.

**URL**

Uniform Resource Locator (URL) is the global address of documents and resources on the internet. The first part of the address indicates what protocol to use. The second part specifies the IP address or the domain name where the resource is located.

**USB**

Universal Serial Bus (USB) is a standard that was developed by the USB Implementers Forum, Inc., to connect computers and peripherals. Unlike the parallel port, USB is designed to concurrently connect a single computer USB port to multiple peripherals.

**Walk-up USB**

Some printers support direct printing from a USB flash drive (the walk-up USB port is usually near the control panel).

**Watermark**

A watermark is a recognizable image or pattern in paper that appears lighter when viewed by transmitted light. Watermarks were first introduced in Bologna, Italy in 1282. Watermarks have been used by paper makers to identify their product, and also on postage stamps, currency, and other government documents to discourage counterfeiting.

**XPS**

XML Paper Specification (XPS) is a specification for a Page Description Language (PDL) and a new document format developed by Microsoft. This has benefits for portable document and electronic documents. It is an XML-based specification based on a new print path and vector-based, device-independent document format.

**ZIF Connector**

Zero insertion force (ZIF) connectors use a mechanical locking method to secure Flat Flexible Cables (FFCs) to a Printed Circuit Assembly (PCA).

---

# Index

## A

### accessories

- dimensions 1, 8, 14
- weight 1, 8, 14

### acoustic specifications 1, 8, 15

### ADF

- parts and diagrams - exterior LX 506
- parts and diagrams - lower image scanner (LX) 630
- parts and diagrams - LX models 478, 506, 520
- parts and diagrams - main frame assembly LX 520
- parts and diagrams - pickup LX 506

### ADF (GX/z)

- parts and diagrams 534

### ADF main frame (GX/z)

- parts and diagrams 582

### ADF upper pickup (GX/z)

- parts and diagrams 562

### after-service checklist 123, 130, 131, 981, 1063, 1066, 2269, 2314, 2317

### APS sensor 636

### authorized service providers, parts 128, 1068, 2319

## B

### backup error

- 32.WX.YZ error 759, 760
- reset error 759, 760
- restore error 759, 760

### belt - timing gear

- HCI 694

### booklet blade

- parts and diagrams 1134

### booklet blade motor

- parts and diagrams 1134

### booklet c-fold blade

- parts and diagrams 1128

### booklet c-fold motor

- parts and diagrams 1130

### booklet diverter

- parts and diagrams 1128

### booklet diverter motor

- parts and diagrams 1130

### Booklet diverter unit 1052, 2188

### booklet diverter unit

- parts and diagrams 1126

### Booklet end fence unit 1040, 1983

### booklet end fence unit

- parts and diagrams 1138

### booklet entrance

- parts and diagrams 1120

### Booklet entrance unit 1037, 1952

### booklet entrance unit

- parts and diagrams 1118

### booklet entrance-presser motor

- parts and diagrams 1120

### booklet exit

- parts and diagrams 1128

### Booklet exit unit 1054, 2212

### booklet exit unit

- parts and diagrams 1126

### booklet finisher

- booklet blade 2105

- booklet blade home sensor 2124

- booklet blade motor 2142

- booklet c-fold blade 2151

- booklet c-fold blade home

- sensor 2166

- booklet c-fold blade motor 2181

- booklet diverter 2189

- booklet diverter home sensor 2206

### booklet diverter motor 2209

### booklet end fence 1984

### booklet end fence home sensor 2000

### booklet end fence motor 1996

### booklet entrance motor 1953

### booklet entrance sensor 1956

### booklet exit sensor 2213

### booklet fold motor 2146

### booklet front cover 1233

### booklet maker 1942

### booklet maker PCA 2241

### booklet output tray 2232

### booklet paddle home sensor 1974

### booklet paddle motor 1971

### booklet presser 2006

### booklet presser home sensor 2021

### booklet presser motor 2025

### booklet stapler unit 2086

### booklet tamper home sensor 2047

### booklet tamper motor 2066

### booklet tamper unit 2029

### bridge door sensor 1161

### bridge entrance sensor 1143

### bridge exit sensor 1156

### bridge motor 1150

### buffer motor 1928

### buffer solenoid 1934

### caster cover 1201

### dummy feed guide 1243

### ejector assembly 1069

### ejector motor 1069

### ejector unit 1653

### ejector1 1704

### ejector1 motor sensor 1678

### ejector2 home sensor 1731

- ejector2 motor 1782
- ejector2 motor sensor 1756
- end fence home 1069
- end fence home sensor 1380
- end fence motor 1405
- entrance motor 1069
- entrance sensor 1069
- exir roller 1069
- exit motor 1333
- exit sensor 1069
- feed entrance motor 1237
- front cover 1185
- front door 1174
- front lower cover 1193
- front paper holding sensor 1886
- front paper support 1069
- front tamper home sensor 1441
- front tamper motor 1467
- front tamper unit 1416
- left lower cover 1205
- left upper cover 1218
- main exit cam motor 1338
- main exit sensor 1320
- main output tray lower limit sensor 1840
- main output tray motor 1860
- main output tray motor sensor 1854
- main output tray top of stack sensor 1809
- main output tray top of stack switch 1825
- main paddle 1069
- main PCA 2236
- manual staple sensor 1631
- motor 1069
- paddle 1347
- paddle home sensor 1361
- paddle motor 1370
- paper holding home sensor 1870
- paper holding Motor 1912
- paper holding solenoid 1069
- paper support 1069
- paper support home sensor 1069
- punch waste full 1069
- rear cover 1180
- rear paper holding sensor 1899
- rear paper support 1069
- rear tamper home sensor 1519
- rear tamper motor 1545
- rear tamper unit 1494
- right upper cover 1167
- sensor 1069
- stacker lower limit switch 1069
- stacker motor 1069
- stapler 1069
- stapler front sensor 1583
- stapler mid-front sensor 1595
- stapler mid-rear sensor 1607
- stapler position motor 1640
- stapler position sensor 1069
- stapler rear sensor 1619
- stapler unit 1572
- switch 1069
- top cover 1170
- top exit sensor 1292
- top jam cover assembly 1250
- top lower feed assembly 1279
- top output tray 1306
- top output tray paper full sensor 1308
- tray diverter 1260
- tray diverter home sensor 1268
- booklet finisher diagrams 1069, 1116
- booklet finisher parts 1069, 1116
- booklet finisher remove and replace 1069
- booklet finisher specification 984
- booklet finisher view 982
- booklet fold motor
  - parts and diagrams 1130
- booklet fold roller
  - parts and diagrams 1132
- Booklet fold unit 1048, 2104
- booklet fold unit
  - parts and diagrams 1126
- Booklet maker 1941
- booklet maker
  - parts and diagrams 1116
- booklet maker baset
  - parts and diagrams 1140
- Booklet output tray unit 1055, 2231
- Booklet paddle unit 1038, 1970
- booklet paddle unit
  - parts and diagrams 1136
- Booklet presser unit 1042, 2005
- booklet presser unit
  - parts and diagrams 1118
- Booklet stapler unit 1046
- booklet stapler unit
  - parts and diagrams 1122
- Booklet tamper unit 1044, 2028
- booklet tamper unit
  - parts and diagrams 1124
- bookletr finisher
  - exit motor 1069
- Bridge unit 1078, 1142
- bridge unit
  - parts and diagrams 1078, 1080
- buffer diverter
  - parts and diagrams 1114
- Buffer unit 1033, 1927
- buffer unit
  - parts and diagrams 1112

**C**

- Calibrate/Cleaning menu, control panel 759, 786, 809, 873
- cartridge
  - dynamic security 46
- cassette 1, 34, 37
- cassette lift drive 1, 61, 63
- Cassettes Tray 2/3
  - parts and diagrams 264
- caster
  - HCI 709
- caution vii
- caution for moving the scanner 1, 68, 77
- CCDM PCA 1, 95
- Certificate of Volatility 2881, 2884
- certificate of volatility 2879
  - CoV E77822/25/30 2879
- Channel partners
  - WISE 123
- Channel partners support
  - HP Channel Services Network (CSN) 123
- checklists
  - after-service 123, 130, 131, 981, 1063, 1066, 2269, 2314, 2317
  - preservice 123, 130, 131, 981, 1063, 1066, 2269, 2314, 2317
- cleaning page 759, 786, 809, 873
- cleaning the paper dust stick 123, 133
- cleaning the scan glass 123, 133

clear paper jams 981, 2253, 2254, 2851  
 component test  
     special mode test 759, 766, 767, 779, 785  
 components  
     diagnostic tests 759, 766, 767, 779, 785  
     scanning system 1, 68, 71  
 connection  
     diagram 2869  
 connector error  
     65.WX.YZ error 759, 761  
 control panel 252  
     Backup/Restore menu 759, 786, 809, 873  
     Calibrate/Cleaning menu 759, 786, 809, 873  
     Copy menu (MFP only) 759, 786, 809, 852  
     CPMD 759  
     Fax menu (fax models only) 759, 786, 809, 865  
     Print menu 759, 786, 809, 868  
     Reports menu 759, 786, 809  
     Scan menu (MFP only) 759, 786, 809, 856  
     Settings menu 759, 786, 809, 810  
     Supplies menu 759, 786, 809, 868  
     Trays menu 759, 786, 809, 869  
     troubleshooting menu 759, 786, 809, 869  
     USB Firmware Upgrade menu 759, 786, 809, 873, 874  
 control panel diagnostic flowcharts 759, 766, 767, 772, 773  
 control panel menus 759, 786, 809  
 control panel messages 760  
 conventions used vii  
 Copy menu (MFP only), control panel 759, 786, 809, 852  
 copy specifications 1, 8, 22  
 CoV  
     certificate of volatility 2879  
 cover  
     parts and diagrams 1072  
 Covers 1166, 2338  
     parts and diagrams 432  
 CPMD 760  
 CPMP  
     WISE 124, 762  
 current settings pages 759, 786  
**D**  
 DC controller communication error 55.WX.YZ error 759, 761  
 DC controller firmware error 70.WX.YZ error 759, 761  
 DCF 1, 114  
 DCF main frame pickup  
     parts and diagrams 666  
 DCF main frame pickup 1  
     parts and diagrams - drive 664  
 DCF main frame pickup upper  
     parts and diagrams - drive 672  
 decoding  
     message 759  
 defeating  
     interlocks 759, 766, 767, 779, 782, 783  
 definitions and terms  
     glossary 2893  
 determine problem source 759, 766, 767  
 developer unit 1, 41, 43, 44  
 diagnostics  
     adjustment 759, 881, 893, 906  
     component 759, 766, 767, 779, 785  
     engine 759, 766, 767, 779, 782, 881, 893  
     fax 759, 881, 893  
     image management 759, 881, 893, 910  
     LED 759, 766, 767, 779, 780  
     print test patterns 759, 881, 893, 911  
     scanner 759, 881, 893, 901  
 diagram  
     connection 2869  
     dual cassette feeder 2877  
     FDB/LVPS 2873  
     front OPC 2875  
     fuser exit 2870  
     laser scanner assembly/HVPS 2871  
     pickup/ph drive/side 2870  
     scanner 2876  
     toner 2872  
     UI 2874  
 diagram, electrical-mechanical relationships  
     document feeder section 965  
     drive section 946  
     dual-cassette feeder (DCF) 971  
     exit section 945  
     frame section 955  
     fuser section 958  
     high-capacity input (HCI) 974  
     image formation section 967  
     MP right door section 959  
     paper handling section 953  
     PCAs, Boards, and Laser Scanning Unit (LSU) 941  
     scanner section 963  
 Diagrams  
     ADF (GX/z) 534  
     ADF (LX models) 478  
     ADF exterior and ADF pickup(LX models) 506  
     ADF lower image scanner (LX) 630  
     ADF main frame (GX/z) 582  
     ADF main frame assembly (LX models) 520  
     ADF upper pickup (GX/z) 562  
     booklet blade 1134  
     booklet blade motor 1134  
     booklet c-fold blade 1128  
     booklet c-fold motor 1130  
     booklet diverter 1128  
     booklet diverter motor 1130  
     booklet diverter unit 1126  
     booklet end fence unit 1138  
     booklet entrance 1120  
     booklet entrance unit 1118  
     booklet entrance-presser motor 1120  
     booklet exit 1128  
     booklet exit unit 1126  
     booklet fold motor 1130  
     booklet fold roller 1132  
     booklet fold unit 1126  
     booklet maker 1116  
     booklet maker base 1140  
     booklet paddle unit 1136  
     booklet presser unit 1118  
     booklet stapler unit 1122

booklet tamper unit 1124  
 bridge unit 1078, 1080  
 buffer diverter 1114  
 buffer unit 1112  
 cassettes tray 2/3 264  
 cover 1072  
 covers 432  
 DCF main frame pickup 666  
 DCF main frame pickup 1 664  
 DCF main frame pickup upper 672  
 Dual cassette feeder DCF 646  
 ejector unit 1098, 1102  
 end fence unit 1094  
 entrance motor 1084  
 entrance unit 1082, 1084  
 exit assemblies 260  
 exit motor 1092  
 flow ADF image scanner (GX/sGX) 616  
 flow ADF open cover (GX/z) 552  
 flow ADF stacker (GX/sGX) 578  
 front door 1076  
 front jam cover 1114  
 fuser output drive 272  
 harness 1072  
 HCI drive 721  
 HCI main 675  
 HCI sub - cassette 746  
 HCI sub - frame 692  
 HCI sub - pickup upper/lower 714  
 image scanner assembly 620  
 left lower cover 1108  
 left upper cover 1106  
 lower bridge 1080  
 main assembly 140  
 main drive 268  
 main engine frame assembly 276  
 main exit CAM motor 1092  
 main exit unit 1090, 1094  
 main frame 384  
 main frame pickup 364  
 main frame pickup upper 380  
 main output tray motor 1110  
 main output tray unit 1104  
 main PCA 1098  
 paddle 1096  
 paddle motor 1096  
 paddle unit 1094  
 paper holding motor 1110  
 paper holding unit 1104  
 registration sub-frame 350  
 right door 442  
 right door feed guide 472  
 right door output 468  
 right upper cover 1076  
 stapler unit 1098  
 tamper unit 1098, 1100  
 top cover 1076  
 top door 1076  
 top exit unit 1090  
 top lower cover 1092  
 top output tray unit 1090  
 Tray 1 registration drive 346  
 Tray 1 rollers 446  
 Tray diverter CAM 1088  
 tray diverter unit 1086  
 tray jam cover 1088  
 upper bridge 1078  
 diagrams  
   covers-inner finisher 2324  
   ejector unit-inner finisher 2336  
   electrical-mechanical 941, 2869  
   finisher system 981, 2267  
   inner finisher 2321  
   paper support unit-inner finisher 2328  
   sensor, motor, and roller-inner finisher 2326  
   stapler unit-inner finisher 2334  
   tamper unit-inner finisher 2330, 2332  
   use parts lists and diagrams 128  
 digital sending error (firmware)  
   44.WX.YZ error 759, 761  
 dimensions  
   accessories 1, 8, 14  
   printer 1, 8, 14  
 diverter unit 2286  
 document feeder  
   document feeder input tray (LX) 484  
 document feeder (LX) reverse roller 522  
 document feeder error  
   31.WX.YZ error 759, 760  
 document feeder pick roller (LX) 512  
 document feeder section  
   electrical-mechanical relationships diagram 965  
 document feeder skew (LX du models) 759  
 documentation, printer error codes and messages  
   WISE 124, 762  
 drive assembly - feed  
   HCI 723  
 drive assembly - feed motor  
   HCI 727  
 drive assembly - lift drive right and motor - lift drive left motor  
   HCI 732  
 drive assembly - step motor  
   HCI 735  
 drive assembly - sub-pulley  
   HCI 738  
 drive section  
   electrical-mechanical relationships diagram 946  
 drive system 1, 61  
   cassette lift drive 1, 61, 63  
   drive motors 1, 61  
   exit drive 1, 61  
   feed drive 1, 61, 64  
   fuser drive 65  
   fuser release drive 1, 61  
   main drive unit 62  
   main drive unit motor 1, 61  
   pickup drive 1, 61, 63  
   registration / Tray 1 drive 64  
   registration drive 1, 61  
   toner collection unit drive 66  
   toner reservoir drive 1, 61  
   toner supply drive 1, 61, 67  
 drivers, supported 1, 8  
 dual cassette feeder (DCF) motor 656  
 dual cassette feeder (DCF) right door 650  
 dual cassette feeder 1, 114  
   diagram 2877  
 dual cassette feeder (DCF) PCA 653  
 dual cassette feeder (DCF) pickup motor 660  
 dual cassette feeder (DCF) pickup units 668  
 dual cassette feeder (DCF) rear cover 648

- dual cassette feeder (DCF) unit
  - dual cassette feeder (DCF) motor 656
  - dual cassette feeder (DCF) rear cover 648
  - dual cassette feeder (DCF) motor 660
  - dual cassette feeder (DCF) PCA 653
  - dual cassette feeder (DCF) pickup units 668
  - dual cassette feeder (DCF) right door 650
- Dual cassette feeder DCF
  - parts and diagrams - Dual cassette feeder DCF 646
- dual-cassette feeder (DCF)
  - electrical-mechanical relationships diagram 971
- duplexer error
  - 69.WX.YZ error 759, 761
- dynamic security
  - toner cartridge 46

**E**

- each unit functions
  - finisher system 981, 982, 2270
- ejector home sensor 2862
- ejector motor 2862
- Ejector unit 1025, 1652, 2649
- ejector unit 2302
  - parts and diagrams 1098, 1102
- Ejector1 1677
- ejector2 unit 1730
- electrical parts layout
  - finisher system layout 981, 982, 2270
- electrical specifications 1, 8, 15
- electrical-mechanical
  - diagrams 941, 2869
- electrostatic discharge (ESD) 123, 128, 981, 1063, 1066, 2269, 2314, 2317
- Embedded Jetdirect error
  - 80.WX.YZ error 759, 761
- end fence sensor 2860
- End fence unit 1017, 1379, 2715
- end fence unit 2298
  - parts and diagrams 1094
- engine
  - diagnostics 759, 766, 767, 779, 782
  - engine error (LaserJet)
    - 46.WX.YZ error 759, 761
    - 63.WX.YZ error 759, 761
  - engine error (PageWide)
    - 61.WX.YZ error 759, 761
  - entrance motor 2854
    - parts and diagrams 1084
  - Entrance unit 1082, 1236, 2364
  - entrance unit 2285
    - parts and diagrams 1082, 1084
  - eraser PCA 1, 95, 112
  - error
    - fault 759
  - ESD electrostatic discharge (ESD) 123, 128, 981, 1063, 1066, 2269, 2314, 2317
  - event log 759, 786, 790
    - clear using touchscreen control panel 759, 786, 790
  - event log error (firmware)
    - 42.WX.YZ error 759, 761
  - Exit assemblies
    - parts and diagrams 260
  - exit drive 1, 61, 65
  - exit motor
    - parts and diagrams 1092
  - exit section
    - electrical-mechanical relationships diagram 945
  - exit sensor 2855
  - Exit unit 2380
  - exit unit 2288
  - exploded parts views, use parts lists and diagrams 128

**F**

- fan error
  - 58.WX.YZ error 759, 761
- Fax menu (fax models only), control panel 759, 786, 809, 865
- FDB/LVPS
  - diagram 2873
- feed drive 1, 61, 64
- feeding system 1, 34
  - cassette 1, 34, 37
  - main components and functions 1, 34, 35
- MP feeder assembly 1, 34
  - overview 1, 34
  - pickup assembly 39
  - pickup unit 1, 34
  - registration assembly 39
  - registration unit 1, 34
  - rollers 1, 34, 35
  - sensor, motor, and solenoid 1, 34, 35, 36
  - Tray 1 feeder assembly 39
- feeding system information 1, 34
- finisher docking sensor 2853
- finisher sectional view 981, 982, 2270
- finisher system 981, 982, 991, 2270, 2276
  - diagrams 981, 2267
  - each unit functions 981, 982, 2270
  - electrical parts layout 981, 982, 2270
  - finisher sectional view 981, 982, 2270
  - paper path 981, 982, 2270
  - PCA connection information 981, 982, 2270
- finisher system diagram 991, 2276
- finisher system electrical parts 991, 2276
- finisher system paper path 991, 2276
- finisher system PBA connection 991, 2276
- finisher system sectional view 991, 2276
- firmware communication error
  - 49.WX.YZ error 759, 761
- firmware install error
  - 99.WX.YZ error 759, 762
- hard disk error 759, 762
- remote firmware upgrade error 759, 762
- flatbed scanner system
  - overview 1, 68, 69
- flow (z bundles) document feeder
  - document feeder contact image sensor (CIS) 543
  - document feeder contact image sensor (CIS) fan 601

- document feeder front motor 585
  - document feeder input tray 536
  - document feeder jam access cover 554
  - document feeder PCA fan 598
  - document feeder rear motors 589
  - document feeder ultrasonic sensor with PCA 604
  - Flow ADF image scanner (GX/SGX) parts and diagrams 616
  - Flow ADF open cover (GX/z) parts and diagrams 552
  - flow ADF PCA 1, 95
  - flow ADF skew (LX du models) 759
  - Flow ADF stacker (GX/SGX) parts and diagrams 578
  - Formatter 104
  - formatter locating 1, 2, 3
  - formatter lights 759, 766, 767, 779, 780, 781
  - frame section electrical-mechanical relationships diagram 955
  - front cover switch 2866
  - front door parts and diagrams 1076
  - front jam cover parts and diagrams 1114
  - front OPC diagram 2875
  - Front tamper 1415, 2511
  - front tamper motor 2858
  - front tamper sensor 2858
  - front view 2270
  - fuser drive 65
  - fuser drive assembly 1, 95
  - fuser drive board 108
  - fuser error 41.WX.YZ error 759, 761 laser scanner error 759, 761 paper path error 759, 761 fuser error (LaserJet) 50.WX.YZ error 759, 761
  - fuser exit diagram 2870
  - fuser output drive parts and diagrams 272
  - fuser PCA 1, 95
  - fuser release drive 1, 61
  - fuser section electrical-mechanical relationships diagram 958
  - fuser unit 1, 50 fuser unit drive 1, 50, 51 overview 1, 50 temperature control 1, 50, 51 fuser unit drive 1, 50, 51 fuser unit temperature control 1, 50, 51
- G**
- General Settings menu, control panel 759, 786, 809, 810
  - general specifications 1, 8, 15
  - glossary terms and definitions 2893
  - guide post and guide post plate HCl 711
- H**
- hanress parts and diagrams 1072
  - hard disk drive 207
  - hard disk partition error 98.WX.YZ error 759, 762
  - hardware configuration 1, 95 CCDM PCA 1, 95 eraser PCA 1, 95, 112 flow ADF PCA 1, 95 fuser drive assembly 1, 95 fuser drive board 108 fuser PCA 1, 95 high voltage power supply PCA 1, 95 high-voltage power supply (HVPS) PCA 110 low voltage power supply (LVPS; Type 5H) / switching mode power supply (SMPS) 106 low voltage power supply PCA (Type 3R) 1, 95 low voltage power supply PCA (Type 4) 1, 95, 106 low voltage power supply PCA (Type 5H) 1, 95 LVPS PCA (Type 3R) 1, 95 LVPS PCA (Type 4) 1, 95, 106 LVPS PCA (Type 5H) 1, 95, 106 main controller 1, 95, 99 master system operation key 1, 95, 99, 102 scan joint PCA 1, 95 WLED IF PCA 1, 95 WLED PCA 1, 95 hardware integration pocket (HIP) is not functioning 759, 766, 767, 772, 773, 777
  - HCl 1
  - HCl belt - timing gear 694
  - HCl caster 709
  - HCl drive parts and diagrams 721
  - HCl drive assembly - feed 723
  - HCl drive assembly - sub-pulley 738
  - HCl guide post and guide post plate 711
  - HCl kit - HP LaserJet E7 tray rollers 716
  - HCl main parts and diagrams 675
  - HCl main electrical connector 706
  - HCl motor - feed drive 727
  - HCl motor - lift drive right and motor - lift drive left 732
  - HCl motor - step drive 735
  - HCl PCA 703
  - HCl photo interrupter and sensor bracket 755
  - HCl right door 687
  - HCl sub - cassette parts and diagrams 746
  - HCl sub - frame parts and diagrams 692
  - HCl sub - pickup upper/lower parts and diagrams 714
  - HCl sub-paper side right 748
  - HCl sup-pickup 677
  - HDD 207
  - high capacity input tray 1
  - high voltage power supply PCA 1, 95
  - high-capacity input (HCl) electrical-mechanical relationships diagram 974
  - high-voltage power supply (HVPS) PCA 110
  - high-voltage rail assembly 402



- home button is unresponsive 759, 766, 767, 772, 773, 776
- HP Channel Services Network (CSN)
  - Channel partners support 123
- HP internal users
  - WISE 123
- HP Jetdirect print server
  - lights 759, 766, 767, 779, 780, 781
- HP LaserJet E7 tray rollers
  - HCI 716
- HVPS PCA 1, 95

I

- image creation 1, 41
  - imaging unit 1, 41, 43
  - intermediate transfer belt unit 47
  - overview 1, 41
  - paper transfer belt unit 1, 41, 43
  - toner cartridge 1, 41, 43
- image formation section
  - electrical-mechanical relationships diagram 967
- image quality
  - black lines, vertical 759, 915, 916, 919
  - blurred image 759, 915, 916, 928
  - duplex blur, white spot blur on color print-out 933
  - flow ADF or ADF skew (LX du models) 759
  - foggy image 759, 915, 916, 926
  - incorrect color registration 928
  - jitter image 759, 915, 916, 929
  - light image 759, 915, 916, 927
  - light lines, vertical 759, 915, 916, 921
  - periodic black dots, horizontal 759, 915, 916, 924
  - periodic black lines, horizontal 759, 915, 916, 924
  - periodic light/dark band, horizontal 925
  - periodic light/dark dots, horizontal 759, 915, 916, 925
  - periodic light/dark lines, horizontal 759, 915, 916
  - poor fusing 759, 915, 916, 931
  - skewed image 759, 915, 916, 930
  - stain on back side 759, 915, 916, 932
  - standard tone, setting 759, 915, 916
  - uneven pitch 759, 915, 916, 929
  - white lines, vertical 759, 915, 916, 921
- image scanner assembly
  - parts and diagrams 620
- imaging unit 1, 41, 43
  - developer unit 1, 41, 43, 44
  - overview 1, 41, 43
- individual component diagnostics 759, 766, 767, 779
- information
  - general 759, 881, 889
  - print reports 759, 881, 889, 890
  - software version 759, 881, 889, 890
  - supply status 759, 881, 889
- inner finisher 118
  - block diagram 2269
  - ejector & paper support assembly 2650
  - ejector assembly 2320, 2692
  - ejector motor 2320
  - ejector motor assembly 2670
  - end fence home 2320
  - end fence sensor 2716
  - entrance motor 2320, 2371
  - entrance sensor 2320, 2365
  - exir roller 2320
  - exit motor 2320, 2397
  - exit roller 2381
  - exit sensor 2320, 2389
  - front cover 2339
  - front paper support 2320, 2401
  - front tamper 2512
  - front tamper home sensor 2530
  - front tamper motor 2548
  - left cover 2354
  - main paddle 2320, 2487
  - main paddle assembly 2499
  - main paddle home sensor 2491
  - main paddle motor 2495
  - middle cover 2345
  - motor 2320
  - output tray 2727
- output tray lower limit switch 2744
- output tray motor 2778
- output tray motor assembly 2756
- output tray motor sensor 2767
- output tray top of stack sensor 2734
- paper holding 2790
- paper holding sensor 2803
- paper holding solenoid 2320, 2816
- paper support 2320
- paper support home sensor 2320, 2444
- paper support motor 2466
- parts and diagrams 2321
- parts and diagrams - covers 2324
- parts and diagrams - ejector unit 2336
- parts and diagrams - paper support unit 2328
- parts and diagrams - sensor, motor, and roller 2326
- parts and diagrams - stapler unit 2334
- parts and diagrams - tamper unit 2330, 2332
- PCA cover 2352
- punch cover 2837
- punch waste full 2320
- punch waste full sensor 2842
- rear cover 2342
- rear paper support 2320, 2423
- rear tamper 2567, 2585
- rear tamper motor 2603
- sensor 2320
- stacker lower limit switch 2320
- stacker motor 2320
- stapler 2320, 2622
- stapler position motor 2639
- stapler position sensor 2320, 2627
- sub paddle unit 2506
- switch 2320
- top cover 2349
- inner finisher diagrams 2320
- inner finisher parts 2320
- inner finisher PCA 2310

- inner finisher remove and replace 2320
  - inner finisher specification 2271
  - input accessory error
    - 67.WX.YZ error 759, 761
  - input/output error
    - 40.WX.YZ error 759, 760
  - interlocks
    - defeating 759, 766, 767, 779, 782, 783
  - intermediate transfer belt
    - overview 47
  - intermediate transfer belt unit 47
    - cleaning blade 47, 48
    - overview 47
    - transfer belt drive 47, 48
  - internal diagnostics error
    - 90.WX.YZ error 759, 762
    - video display error 759, 762
  - interpret control-panel messages and event log entries 981, 2253, 2269, 2851
- J**
- jam error (LaserJet)
    - 13.WX.YZ error 759, 760
  - jam error (PageWide)
    - 13.WX.YZ error 759, 760
  - jams
    - locations 759, 875
  - Jetdirect print server
    - lights 759, 766, 767, 779, 780, 781
  - job accounting error (firmware)
    - 48.WX.YZ error 759, 761
  - job management error (firmware) 759, 761
  - job pipeline error (firmware) 759, 761
  - job parser error (firmware)
    - 47.WX.YZ error 759, 761
    - printer calibration error 759, 761
- K**
- keyboard 255
- L**
- laser scanner assembly 1
    - laser scanning optical path 1, 55
    - overview 1, 54
  - laser scanner assembly/HVPS
    - diagram 2871
  - laser scanner error (LaserJet)
    - 51.WX.YZ error 759, 761
    - 52.WX.YZ error 759, 761
  - laser scanner unit 54
    - laser scanning optical path 54
    - overview 54
  - LED lamp module 625
  - LEDs. *See* lights
  - left lower cover
    - parts and diagrams 1108
  - left upper cover
    - parts and diagrams 1106
  - lights
    - formatter 759, 766, 767, 779, 780, 781
    - troubleshooting with 759, 766, 767, 779, 780
  - low voltage power supply (LVPS; Type 5H) / switching mode power supply (SMPS) 106
  - low voltage power supply PCA (Type 3R) 1, 95
  - low voltage power supply PCA (Type 4) 1, 95, 106
  - low voltage power supply PCA (Type 5H) 1, 95
  - lower bridge
    - parts and diagrams 1080
  - LVPS PCA (Type 3R) 1, 95
  - LVPS PCA (Type 4) 1, 95, 106
  - LVPS PCA (Type 5H) 1, 95, 106
    - switching mode power supply 106
- M**
- machine cleaning for maintenance 123, 133
    - cleaning the flow ADF white bar and CIS (GX ADF) 123, 133
    - cleaning the flow ADF white bar and CIS (LX/du model) 123, 133
    - cleaning the paper dust stick 123, 133
    - cleaning the scan glass 123, 133
  - main assembly
    - parts and diagrams 140
  - main controller
    - hardware configuration 1, 95, 99
    - new model (IR/UI) 1, 95, 99
    - previous model 1, 95, 99
  - main drive
    - parts and diagrams 268
  - main electrical connector
    - HCI 706
  - Main engine frame assembly
    - parts and diagrams 276
  - main exit CAM motor
    - parts and diagrams 1092
  - Main exit unit 1013, 1319
  - main exit unit
    - parts and diagrams 1090, 1094
  - main frame
    - parts and diagrams 384
  - main frame pickup
    - parts and diagrams 364
  - main frame pickup upper
    - parts and diagrams 380
  - main output tray motor
    - parts and diagrams 1110
  - Main output tray unit 1028, 1808
  - main output tray unit
    - parts and diagrams 1104
  - main parts 139
  - main PCA
    - parts and diagrams 1098
  - maintenance 123, 133
    - machine cleaning for maintenance 123, 133
  - maintenance counts
    - part replacement count 759, 881, 891
  - maintenance parts 1, 8, 30
  - master system operation key 1, 95, 99, 102
  - memory error
    - 82.WX.YZ error 759, 762
    - EMMC error 759, 762
    - hard disk error 759, 762
  - menu map 759, 786
  - menus, control panel
    - Calibrate/Cleaning 759, 786, 809, 873
    - Copy (MFP only) 759, 786, 809, 852
    - Fax (fax models only) 759, 786, 809, 865

- General Settings 759, 786, 809, 810
- Manage Trays 759, 786, 809, 869
- Print 759, 786, 809, 868
- Reports 759, 786, 809
- Scan (MFP only) 759, 786, 809, 856
- Supplies 759, 786, 809, 868
- motor error (LaserJet)
  - 59.WX.YZ error 759, 761
- MP right door section
  - electrical-mechanical relationships diagram 959
- MSOK 1, 95, 99, 102
- multipurpose feeder assembly 1, 34

**N**

- Near Field Communication error
  - 81.WX.YZ error 759, 762
  - Bluetooth error 759, 762
  - external I/O card error 759, 762
  - internal EIO error 759, 762
  - wireless error 759, 762
- network and software specifications 1, 8
- network interface 1, 8
- no control panel sound 759, 766, 767, 772, 773, 775
- note vii

**O**

- operating systems, supported 1, 8
- operating-environment range
  - printer 15
- option specifications 1, 8
- optional configurations 1, 8
- optional parts 32
- options list 1, 8
- orderable parts 128, 1068, 2319
- ordering 981, 1063, 2269, 2314
- other errors
  - drive unit 759, 915
  - electrical circuit 759, 915
  - feeding system 759, 915
  - flow ADF 759, 915
  - fuser 759, 915
  - image system 759, 915
  - laser scanner assembly 759, 915
  - scanner 759, 915

- output accessory error
  - 66.WX.YZ error 759, 761
- output tray 2306
- output tray motor 2863
- Output tray motor assembly 2755
- output tray motor sensor 2863
- Output tray top of stack sensor 2864
- Output tray unit 2726
- OXPd/Web kit error
  - 45.WX.YZ error 759, 761

**P**

- paddle
  - parts and diagrams 1096
- paddle motor
  - parts and diagrams 1096
- Paddle unit 1016, 1346, 2486
- paddle unit 2292
  - parts and diagrams 1094
- page error
  - 21.WX.YZ error 759, 760
- paper handling error (LaserJet)
  - 56.WX.YZ error 759, 761
- paper handling section
  - electrical-mechanical relationships diagram 953
- paper handling specifications 1, 8, 25
- paper holding motor
  - parts and diagrams 1110
- Paper holding unit 1030, 1869, 2789
- paper holding unit 2306
  - parts and diagrams 1104
- paper jams
  - locations 759, 875
- paper path
  - finisher system 981, 982, 2270
- paper support motor 2857
- paper support sensor 2857
- Paper support unit 2400
- paper support unit 2291
- paper transfer belt unit 1, 41, 43
  - cleaning blade 1, 41, 43
  - overview 1, 41, 43
  - transfer belt drive 1, 41, 43
- Parts
  - ADF (GX/z) 534
  - ADF (LX models) 478

- ADF exterior and ADF pickup(LX models) 506
- ADF lower image scanner (LX) 630
- ADF main frame (GX/z) 582
- ADF main frame assembly (LX models) 520
- ADF upper pickup (GX/z) 562
- booklet blade 1134
- booklet blade motor 1134
- booklet c-fold blade 1128
- booklet c-fold motor 1130
- booklet diverter 1128
- booklet diverter motor 1130
- booklet diverter unit 1126
- booklet end fence unit 1138
- booklet entrance 1120
- booklet entrance unit 1118
- booklet entrance-presser motor 1120
- booklet exit 1128
- booklet exit unit 1126
- booklet fold motor 1130
- booklet fold roller 1132
- booklet fold unit 1126
- booklet maker 1116
- booklet maker base 1140
- booklet paddle unit 1136
- booklet presser unit 1118
- booklet stapler unit 1122
- booklet tamper unit 1124
- bridge unit 1078, 1080
- buffer diverter 1114
- buffer unit 1112
- cassettes tray 2/3 264
- cover 1072
- covers 432
- covers-inner finisher 2324
- DCF main frame pickup 666
- DCF main frame pickup 1 664
- DCF main frame pickup upper 672
- Dual cassette feeder DCF 646
- ejector unit 1098, 1102
- ejector unit-inner finisher 2336
- end fence unit 1094
- entrance motor 1084
- entrance unit 1082, 1084
- exit assemblies 260
- exit motor 1092

flow ADF image scanner (GX/sGX) 616  
 flow ADF open cover (GX/z) 552  
 flow ADF stacker (GX/sGX) 578  
 front door 1076  
 front jam cover 1114  
 fuser output drive 272  
 hanress 1072  
 HCI drive 721  
 HCI main 675  
 HCI sub - cassette 746  
 HCI sub - frame 692  
 HCI sub - pickup upper/lower 714  
 image scanner assembly 620  
 inner finisher 2321  
 left lower cover 1108  
 left upper cover 1106  
 lower bridge 1080  
 main assembly 140  
 main drive 268  
 main engine frame assembly 276  
 main exit CAM motor 1092  
 main exit unit 1090, 1094  
 main frame 384  
 main frame pickup 364  
 main frame pickup upper 380  
 main output tray motor 1110  
 main output tray unit 1104  
 main PCA 1098  
 paddle 1096  
 paddle motor 1096  
 paddle unit 1094  
 paper holding motor 1110  
 paper holding unit 1104  
 paper support unit-inner finisher 2328  
 registration sub-frame 350  
 right door 442  
 right door feed guide 472  
 right door output 468  
 right upper cover 1076  
 ssensor, motor, and roller-inner finisher 2326  
 stapler unit 1098  
 stapler unit-inner finisher 2334  
 tamper unit 1098, 1100  
 tamper unit-inner finisher 2330, 2332  
 top cover 1076  
 top door 1076  
 top exit unit 1090  
 top lower cover 1092  
 top output tray unit 1090  
 Tray 1 registration drive 346  
 Tray 1 rollers 446  
 Tray diverter CAM 1088  
 tray diverter unit 1086  
 tray jam cover 1088  
 upper bridge 1078  
 parts 128, 1068, 2319  
   use parts lists and diagrams 128  
 parts and accessories 981, 1063, 2269, 2314  
 parts and diagrams 123  
 parts and diagrams, using 128  
 parts list and diagrams, how to use 128  
 parts, main 139  
 parts, order by authorized service providers 128, 1068, 2319  
 parts, orderable 128, 1068, 2319  
 parts, ordering 128, 1068, 2319  
 PCA 2235  
   HCI 703  
 PCA connection information 1058  
   finisher system 981, 982, 2270  
 PCA precautions 981, 1063, 1064, 1065, 2314, 2315, 2316  
 PCAs, Boards, and Laser Scanning Unit (LSU)  
   electrical-mechanical relationships diagram 941  
 pick roller  
   document feeder (LX) 512  
 pickup assembly 39  
 pickup drive 1, 61, 63  
 pickup unit 1, 34  
 pickup/ph drive/side  
   diagram 2870  
 plastic latches information 981, 1063, 1064, 1065, 2314, 2315, 2316  
 post-service tests 123, 130, 132, 981, 1063, 1067, 2269, 2314, 2318  
 power  
   consumption 1, 8, 15  
 power subsystem 759, 766, 767, 768  
 power supply  
   troubleshooting 759, 766, 767, 768, 769  
 power-on troubleshooting overview 759, 766, 767, 768, 769  
 pre-boot menu options 759, 786, 791  
 precautions  
   information 981, 1063, 1064, 2314, 2315  
 precautions  
   replacing parts 130, 1064, 2315  
 preservice checklist 123, 130, 131, 981, 1063, 1066, 2269, 2314, 2317  
 print bar error (PageWide)  
   62.WX.YZ error 759, 761  
 print drivers, supported 1, 8  
 Print menu, control panel 759, 786, 809, 868  
 print quality  
   test 123, 130, 132, 981, 1063, 1067, 2269, 2314, 2318  
 print quality troubleshooting 759, 915  
   flow ADF skew adjust 759  
   image quality 759, 915, 916  
   other errors 759, 915  
 print specifications 1, 8, 17  
 Print Test Page 759, 786, 809, 810  
 printer  
   dimensions 1, 8, 14  
   operating-environment range 15  
   weight 1, 8, 14  
 printer memory error  
   20.WX.YZ error 759, 760  
 Process Cleaning Page 759, 786, 809, 873  
 product number  
   locating 1, 2, 3  
 Punch unit 1242, 2836  
 punch unit 1006, 2282  
 punch waste box sensor 2853  
 Punch waste full sensor 2852

## R

real-time clock error  
   11.WX.YZ error 759, 760  
 Rear paper support 2422  
 Rear tamper 1493, 2566  
 rear tamper motor 2859

- rear tamper sensor 2859
- rear view 2270
- registration assembly 39
- registration drive 1, 61, 64
- registration sub-frame
  - parts and diagrams 350
- registration unit 1, 34
- removal and replacement 123
- removal and replacement booklet
  - finisher 1069
- removal and replacement inner
  - finisher 2320
- removal and replacement
  - precautions 981, 1063, 1064, 2314, 2315
- removal order
  - removing order 123, 130, 132, 1067, 2318
- removing parts
  - checklists 123, 130, 131, 981, 1063, 1066, 2269, 2314, 2317
- replacing parts
  - precautions 130, 1064, 2315
- replacing the main SVC part
  - high-voltage rail assembly 402
  - right door dampener 397
  - toner collection unit presence
    - photo sensor 427
- Reports menu, control panel 759, 786, 809
- reverse roller
  - document feeder (LX) 522
- revision history iii
- Right door
  - parts and diagrams 442
- right door
  - HCI 687
- right door dampener 397
- Right door feed guide
  - parts and diagrams 472
- right door output
  - parts and diagrams 468
- right upper cover
  - parts and diagrams 1076

**S**

- scan glass 622
- scan joint PCA 1, 95
- Scan menu (MFP only), control panel 759, 786, 809, 856

- scan specifications 1, 8, 19
- scanner
  - caution for moving 1, 68, 77
  - CDD and lens 632
  - diagram 2876
  - scanner glass 622
- scanner assembly - CDD and lens 632
- scanner error
  - 30.WX.YZ error 759, 760
- scanner section
  - electrical-mechanical relationships
    - diagram 963
- scanning system
  - components 1, 68, 71
- scanning system components 1, 68, 71
- security error
  - 33.WX.YZ error 759, 760
- sensor and bracket
  - HCI 755
- sensor error
  - 54.WX.YZ error 759, 761
  - 58.WX.YZ error 759, 761
- serial number
  - locating 1, 2, 3
- service and support
  - WISE 123
- service and support information
  - WISE and CSN 123
- service approach 123, 130, 981, 1063, 2269, 2314
  - precautions 130, 1064, 2315
- service functions
  - capture log 759, 881, 912
  - debug log 759, 881, 912
  - envelope rotate 759, 881, 912, 913
  - main memory clear 759, 881, 912
  - transfer assembly control 759, 881, 912, 913
- service mode 759, 881
  - diagnostics 759, 881, 893
  - entering service mode 759, 881
  - information 759, 881, 889
  - maintenance counts 759, 881, 891
  - mode menu tree 759, 881
  - service functions 759, 881, 912

- SHCI 1
- side high capacity input tray 1
- software and solutions 1, 8
- solve problems
  - control panel messages 760
  - CPMD 760
- specifications 1, 8
  - copy specifications 1, 8, 22
  - electrical and acoustic 1, 8, 15
  - general specifications 1, 8, 15
  - maintenance parts 1, 8, 30
  - network interface 1, 8
  - network specifications 1, 8
  - optional parts 32
  - options 1, 8
  - options list 1, 8
  - paper handling specifications 1, 8, 25
  - print specifications 1, 8, 17
  - scan specifications 1, 8, 19
  - software and solutions 1, 8
  - software specifications 1, 8
  - supplies 1, 8, 29
- Stacker finisher 991
- stacker finisher 982
- standard (dn bundles) document feeder
  - document feeder PCA 612
  - document feeder white backing 147
- standard (du bundles) document feeder
  - document feeder white backing 144
- standard (LX models) document feeder
  - document feeder whole unit 150
- standard (LX) document feeder
  - document feeder (ADF) PCA 508
  - document feeder feed motor 529
- standard (LX) document feeder (ADF)
  - contact image sensor (CIS) 490
  - document feeder (ADF) jam access cover (LX) 480
- standard (LX/du model) document feeder
  - document feeder main motor 500

standard (z bundles) document feeder  
   document feeder whole unit 155  
 Stapler finisher 991  
 stapler finisher 982  
 stapler position motor 2861  
 stapler position sensor 2861  
 Stapler unit 1571, 2621  
 stapler unit 2300  
   parts and diagrams 1098  
 Stapler unit (booklet) 2085  
 stapler/stacker diagrams 1070  
 stapler/stacker parts 1070  
 static, precautions for 123, 128,  
   981, 1063, 1066, 2269, 2314, 2317  
 sub-paper side right  
   HCI 748  
 sup-pickup  
   HCI 677  
 supplies 981, 1063, 2269, 2314  
 supplies error (LaserJet)  
   10.WX.YZ error 759, 760  
 supplies error (PageWide)  
   17.WX.YZ error 759, 760  
 Supplies menu, control panel 759,  
   786, 809, 868  
 switching mode power supply  
   LVPS PCA (Type 5H) 106  
 system error (LaserJet)  
   62.WX.YZ error 759, 761  
 system requirements  
   minimum 1, 8

**T**  
 Tamper unit 1019, 1022, 1414,  
   2510  
 tamper unit 2295  
   parts and diagrams 1098, 1100  
 terms and definitions  
   glossary 2893  
 tests  
   post-service 123, 130, 132, 981,  
   1063, 1067, 2269, 2314, 2318  
   print-quality 123, 130, 132, 981,  
   1063, 1067, 2269, 2314, 2318  
 tip vii  
 toner  
   diagram 2872  
 toner cartridge 1, 41, 43  
   dynamic security 46  
 toner collection unit drive 66  
 toner collection unit presence photo  
   sensor 427  
 top cover  
   parts and diagrams 1076  
 top cover switch 2865  
 top door  
   parts and diagrams 1076  
 Top exit unit 1011, 1278  
 top exit unit  
   parts and diagrams 1090  
 top lower cover  
   parts and diagrams 1092  
 Top output tray unit 1012, 1305  
 top output tray unit  
   parts and diagrams 1090  
 touchscreen blank, white, or dim (no  
   image) 759, 766, 767, 772, 773  
 touchscreen has an unresponsive  
   zone 759, 766, 767, 772, 773, 774  
 Tray 1  
   jams, clearing 759, 875  
 Tray 1 drive 64  
 Tray 1 feeder assembly 39  
 Tray 1 registration drive  
   parts and diagrams 346  
 Tray 1 rollers  
   parts and diagrams 446  
 Tray 2  
   jams, clearing 759, 875  
 Tray 3  
   jams, clearing 759, 875  
 Tray diverter CAM  
   parts and diagrams 1088  
 Tray diverter unit 1009, 1086, 1249  
 tray diverter unit  
   parts and diagrams 1086  
 tray jam cover  
   parts and diagrams 1088  
 tray motor error (LaserJet)  
   60.WX.YZ error 759, 761  
 tray selection - use requested tray  
   759, 786, 809, 810  
 trays  
   jams, clearing 759, 875  
 Trays menu, control panel 759, 786,  
   809, 869  
 troubleshooting  
   checklist 759, 786, 787  
   control panel checks 759, 766,  
   767, 772  
   lights, using 759, 766, 767, 779,  
   780  
   power 759, 766, 767, 768, 769  
   process 759, 766  
 troubleshooting tools  
   control panel messages 760  
   CPMD 760

**U**  
 UI  
   diagram 2874  
 understand lights on the formatter  
   formatter lights 759, 766, 767,  
   779, 780, 781  
 understand the lights on the formatter  
   HP Jetdirect LEDs 759, 766, 767,  
   779, 780, 781  
 upper bridge  
   parts and diagrams 1078  
 Use Requested Tray 759, 786, 809,  
   810

**W**  
 warning vii  
 Web-based Interactive Search Engine  
   WISE 123  
 Web-based Interactive Search Engine  
   (WISE)  
   HP internal users and Channel  
   partners 123  
 weight  
   accessories 1, 8, 14  
   printer 1, 8, 14  
 WISE  
   CPMD 124, 762  
   HP internal users and Channel  
   partners 123  
   Web-based Interactive Search  
   Engine 123  
 WLED IF PCA 1, 95  
 WLED PCA 1, 95